

# Instruction Manual

## **Triaxial Vibration Monitor VM40C**

Valid from version xxx.010



Manfred Weber

Metra Mess- und Frequenztechnik in Radebeul e.K.

Meissner Str. 58 - D-01445 Radebeul

Tel. +49-351 836 2191 Fax +49-351 836 2940

Email: [Info@MMF.de](mailto:Info@MMF.de) Internet: [www.MMF.de](http://www.MMF.de)

**Published by:**

Manfred Weber

Metra Mess- und Frequenztechnik in Radebeul e.K.

Meißner Str. 58

D-01445 Radebeul

Tel. +49-351-836 2191

Fax +49-351-836 2940

Email [Info@MMF.de](mailto:Info@MMF.de)

Internet [www.MMF.de](http://www.MMF.de)

Note: The latest version of this manual can be found at  
[http://www.mmf.de/product\\_literature.htm](http://www.mmf.de/product_literature.htm)

Specification subject to change.

© 2021 Manfred Weber Metra Mess- und Frequenztechnik in Radebeul e.K.

Full or partial reproduction subject to prior written approval.

# Contents

|  |    |
|--|----|
| 1. Purpose of Use.....                                       | 2  |
| 2. Function.....   | 2  |
| 3. Measuring.....  | 3  |
| 3.1. Selecting the Measuring Mode.....                       | 3  |
| 3.2. Measuring in accordance with DIN 4150-3.....            | 4  |
| 3.2.1. Measurement Procedure.....                            | 4  |
| 3.2.2. Measuring with the VM40C.....                         | 6  |
| 3.3. Measuring in accordance with BS7385.....                | 8  |
| 3.3.1. Measurement Procedure.....                            | 8  |
| 3.3.2. Measuring with the VM40C.....                         | 9  |
| 3.4. Measuring in accordance with SN 640312a.....            | 10 |
| 3.4.1. Measurement Procedure.....                            | 10 |
| 3.4.2. Measuring with the VM40C.....                         | 10 |
| 3.5. Measurement in accordance with Circulaire 23/07/86..... | 12 |
| 3.5.1. Measurement Procedure.....                            | 12 |
| 3.5.2. Measuring with the VM40C.....                         | 12 |
| 3.6. Non-Standardized Measuring.....                         | 13 |
| 3.7. Overload Indication.....                                | 14 |
| 4. Saving Measurement Values.....                            | 14 |
| 4.1. Introduction.....                                       | 14 |
| 4.2. Settings for Recording Data.....                        | 15 |
| 4.3. Viewing saved Data.....                                 | 17 |
| 4.4. Deleting the Data Memory.....                           | 18 |
| 4.5. Alarm Statistics.....                                   | 18 |
| 4.6. Transferring the recorded data to a PC.....             | 19 |
| 5. Printing a Report.....                                    | 19 |
| 6. Relay Output and Alarm Beacon VM40-L.....                 | 21 |
| 7. Receiving Alerts via SMS (VM40-MODEM).....                | 23 |
| 7.1. General Information.....                                | 23 |
| 7.2. Inserting the SIM Card.....                             | 23 |
| 7.3. Connecting to a Mobile Phone Network.....               | 24 |
| 7.4. SMS Alerts.....   | 25 |
| 7.5. Polling the Alarm Status by Calling.....                | 27 |
| 7.6. Phone Book.....   | 28 |
| 7.7. Writing an SMS.....                                     | 28 |
| 7.8. Close connection with mobile phone network.....         | 29 |
| 8. Miscellaneous Settings.....                               | 29 |
| 8.1. Warning Threshold.....                                  | 29 |
| 8.2. Keypad Lock.....  | 30 |
| 8.3. Adjusting the Axes.....                                 | 30 |
| 8.4. Date and Time.....                                      | 31 |
| 8.5. Instrument Name.....                                    | 32 |
| 8.6. Menu Language.....                                      | 32 |
| 9. Data Transfer.....  | 33 |
| 9.1. Connection to a PC.....                                 | 33 |
| 9.2. Software VM40MDB.....                                   | 33 |
| 10. Firmware Update.....                                     | 39 |
| 11. Charging the Accumulator.....                            | 40 |
| 12. External Power Supply.....                               | 41 |
| 13. Reset.....   | 41 |
| 14. Mounting / Installation.....                             | 42 |
| 15. Calibration.....   | 43 |
| 16. Technical Data.....                                      | 44 |

Appendix: Guarantee

CE Declaration of Conformity

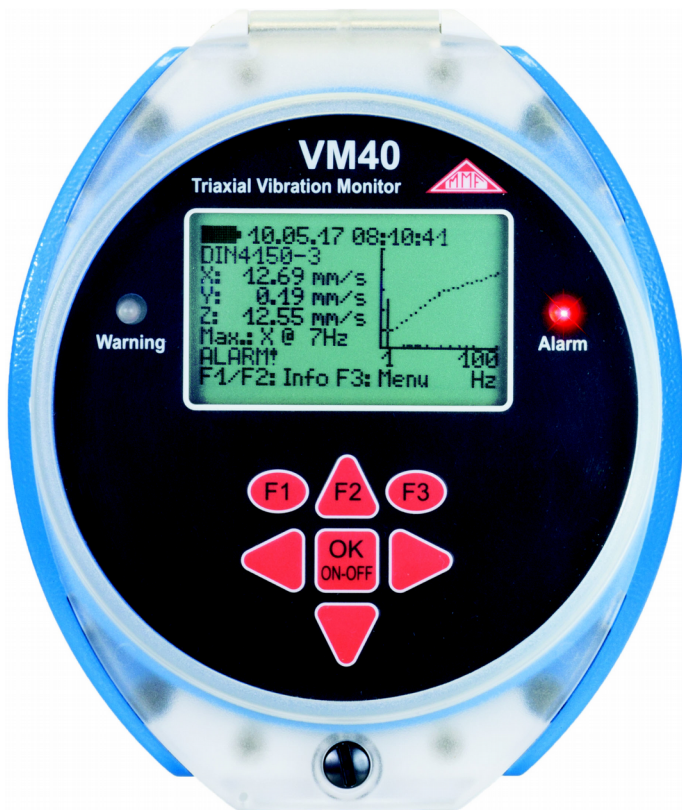



*Thank you for choosing a Metra Vibration Measurement Instrument*

## **1. Purpose of Use**

The VM40C is designed for measuring vibration in buildings, bridges, towers, pipelines and various other large structures.

The measurements serve to prevent possible structural damage or disturbance to people.

The VM40C contains a sensor, recording and evaluation electronics and an accumulator in its robust casing. It is especially suitable for autonomous operation over longer periods of time e.g. on construction sites.

## **2. Function**

The instrument contains three highly sensitive piezoelectric systems for vibration measurement of all three spacial dimensions.

The signal processing is controlled by a micro processor. The VM40C is operated via its seven keypad buttons and illuminated LCD display.

The measurement data can be transferred to a PC via the USB interface. The instrument also has a port for connecting a charger and a relay output for the external signaling of vibration occurrences.

The VM40C can measure in accordance with to the following standards:

- **DIN 4150-3**: Structural Vibration – Effects of vibration on structures
- **BS 7385**: Evaluation and measurement for vibration in buildings
- **SN 640312a**: Effects of vibrations on buildings
- **Circulaire du 23/07/86** relative vibrations mécaniques émises dans l'environnement par les installations classées pour la protection de l'environnement

Through menu navigation, all information concerning the type and location of the measurement and the building type is requested and operational errors are avoided.

The display of the measurement values is carried out using the three peak values of vibration velocity (X/Y/Z) or the vector sum. Furthermore the main frequency and its coordinate are displayed for the highest amplitude.

Additionally the VM40C displays the FFT spectrum of the measured vibration quantity. The spectral graph also indicates the limit value curve of the chosen standard, which enables you to analyze potential damage at a glance.

If the limit value is exceeded, the measured value can be saved. The VM40C also contains two LEDs and a relay output for signaling alarm status.

The VM40C with the optional accessory VM40-MODEM has the option of sending SMS alert messages, if a limit value is exceeded.

Other accessories are the mobile report printer VM40-PRINTER and the alarm beacon VM40-L.

### 3. Measuring

#### 3.1. Selecting the Measuring Mode

Switch on the VM40C by pressing the ON-OFF button. After the start screen, the measurement value display with the most recently selected settings appears.

Press F3 to open the main window and select "measuring mode" (Figure 1).

```
MEASURING MODE
-----
>Non-standard
DIN 4150-3
BS 7385
SN 640312a
Circulaire
▲▼: Select F3: Quit
```

Figure 1: Measuring mode

You can choose between adjustable measured value (non-standardized) and the four supported standards, which are described in the following sections.

In the measurement value display you can view the selected settings by pressing the F1 button (Figure 2).

```
VIBRATION MONITOR
BS 7385

Unreinforced/Resident.

1 /4 /15 /40 Hz
3 /15 /20 /50 mm/s
F3: Back
```

Figure 2: Settings display

Here you will see your chosen standard with its specified settings as well as the four frequency and amplitude dots of the limit value curve.

**Notice:** The following chapters include abstracts of the most relevant standards for building vibration. For a compliant evaluation it is necessary to study the standard documents to the full extent.

**Notice:** Menus are closed automatically if no operation is done for 1 minute and the VM40C returns to the measuring screen.

## 3.2. Measuring in accordance with DIN 4150-3

### 3.2.1. Measurement Procedure

DIN 4150-3 is the most widely applied standard internationally for measuring structural vibrations. The measurement procedure can be found in a similar form in other national standards, for example the Italian UNI 9916.

The assessment parameter is the maximum value  $v_i$  of the three individual components (peak values) of vibration velocity at frequencies of 1 to 80 Hz. According to the 2016 edition of the standard the most significant measurement location is the highest ceiling. This measurement determines the horizontal response of the building to vibrations at the foundation. Only the higher value of the two horizontal components X/Y is evaluated.

Alternatively, measurements of short-time vibrations can be carried out at the foundation. In this case the highest value of X/Y/Z is used. For measurements at the foundation the evaluation is frequency weighted which reflects the transmission from the foundation to the upper ceiling.

The standard provides guide values for permissible vibration velocities for short-time and sustained vibrations in three types of buildings.

| <b>Guide values for vibration velocity <math>v_i</math><br/>for analyzing the effects of transient vibration</b> |  |              |              |                 |         |
|--|--|--------------|--------------|-----------------|---------|
| Building Type  | Foundation                             |              |              | Upper ceiling   |         |
|  | Frequency of the Significant Vibration |              |              |                 |         |
| Frequency range  | 1 – 10 Hz                              | 10 – 50 Hz   | 50 – 100 Hz  | all Frequencies |         |
| Direction  | X / Y / Z                              | X / Y / Z    | X / Y / Z    | X / Y           | Z       |
| Reinforced or framed structures.<br>Industrial and heavy commercial buildings                                    | 20 mm/s                                | 20 – 40 mm/s | 40 – 50 mm/s | 40 mm/s         | 20 mm/s |
| Unreinforced or light framed structures/ Residential or light commercial type buildings                          | 5 mm/s                                 | 5 – 15 mm/s  | 15 – 20 mm/s | 15 mm/s         | 20 mm/s |
| Delicate, listed buildings e.g. historical monuments   | 3 mm/s                                 | 3 – 8 mm/s   | 8 – 10 mm/s  | 8 mm/s          | 20 mm/s |

Table 1: Guide values for transient vibration

Notes from DIN 4150-3 about the guide values in Table 1:

- For engineering structures in massive scale construction, e.g. reinforced concrete for abutments or block foundations you can raise the guide values for industrial type buildings twofold.
- If short-time vibrations occur in ceilings at below 20 mm/s in vertical direction, a reduction in the serviceability is not to be expected.

The standard also gives guide values for short-time vibrations on pipelines of varying types:

| <b>Guide values for transient vibrations in pipelines</b>              |                          |
|--|--------------------------|
| Pipe material  | Vibration Velocity $v_i$ |
| Steel, welded  | 100 mm/s                 |
| Stoneware, concrete, reinforced concrete, pre-stressed concrete, metal | 80 mm/s                  |
| Brickwork, plastic   | 50 mm/s                  |

Table 2: Guide values for pipelines

For continuous vibrations the following guide values apply:

| <b>Guide values for vibration velocity <math>v_i</math> for analyzing the effects of continuous vibration</b> |                                      |              |
|---|--------------------------------------|--------------|
| Building Type   | Upper ceiling level, all Frequencies |              |
| Direction   | X / Y (horizontal)                   | Z (vertical) |
| Reinforced or framed structures industrial and heavy commercial buildings                                     | 10 mm/s                              | 10 mm/s      |
| Unreinforced or light framed structures, residential or light commercial type buildings                       | 5 mm/s                               | 10 mm/s      |
| Delicate buildings, listed buildings e.g. historical monuments  | 2.5 mm/s                             | -            |

Table 3: Guide values for continuous vibration

Vertical continuous vibrations with a vibration velocity below 10 mm/s normally do not cause damage to ceilings in houses. For delicate buildings there are no guide values available.

For sustained vibrations on pipelines, the guide values for short time vibrations, reduced by 50%, can be applied.

The following advice is given in DIN 4150-3 for the placement of sensors:

- In the upper ceiling level the sensor should be placed where the greatest horizontal vibration is expected. It may be necessary to perform comparison measurements along the outer walls. On concrete ceilings which are reinforced in both directions measurements can be taken in any place.
- For foundation vibrations the transducer should be placed on the lowest floor at the foundation or on the outer wall.
- For buildings without a basement the measurement location must not be higher than 0.5m above the ground level.
- One of the lateral coordinates (X/Y) should be parallel to an outside edge of the building.
- Buildings with larger ground areas should be measured at several points.
- In addition to measuring at the foundation and the upper ceiling, if required, measurements can be carried out in the vertical direction on the ceilings, where the strongest vibrations are to be expected (mostly central).
- When measuring pipelines, where possible, the sensor should be placed on the pipeline itself

### 3.2.2. Measuring with the VM40C

After choosing the operating mode „DIN 4150-3“, please select whether you will be measuring short-time or sustained vibrations (Figure 3).

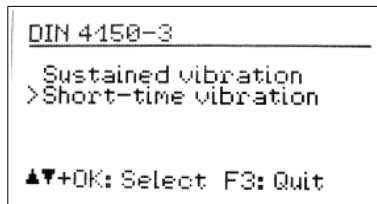

Figure 3: Short-time/Sustained vibration

Next, please select the building type:



Figure 4: Building type

When selecting “Pipeline” the following types are available:

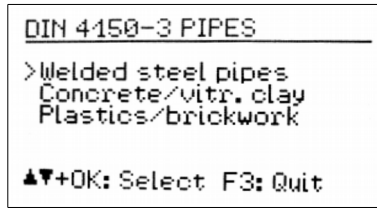

Figure 5: Pipeline types

In the case of short-time vibrations the measurement location needs to be selected:

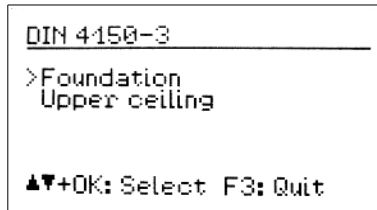

Figure 6: Measurement location

The standard frequency range is 1 to 80 Hz. In special cases, e.g. blasting operations, the frequency range can be increased to 1 to 315 Hz.

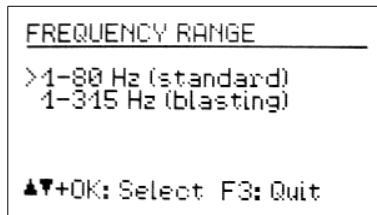

Figure 7: Frequency range

Press F3 to exit the menu to go to the measurement value display (Figure 8).

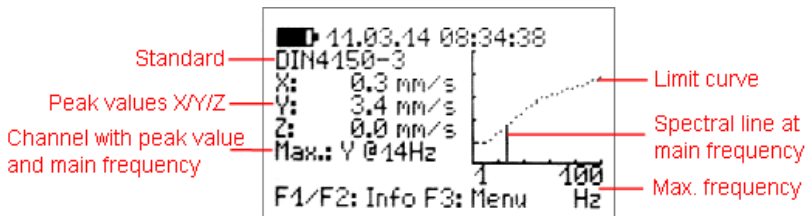

Figure 8: Measurement value display in accordance with DIN 4150-3

The three peak values X/Y/Z of the vibration velocity and the highest amplitude together with its main frequency are displayed every second. On the right side of the screen a graph displays the frequency spectrum (FFT) including the limit curve. The diagram is scaled to the limit curve. Higher magnitudes will be cut off.

**Notice:** For ceiling vibrations (1 and 3) there are different guide values for the vertical (Z) direction. They are evaluated by the VM40C and considered for alarms. In the FFT and frequency display, however, only the horizontal directions (X / Y) are shown.

If the limit value curve is exceeded, “ALARM” is displayed below the main frequency. If the limit value is exceeded the following will happen:

- The red light will flash.
- The measurement values will be saved if the event recording has been activated.
- The relay output will switch, if it has been activated.
- A text message (SMS) will be sent, if this option has been set up and if the modem is connected.

Note: The alarm and recording functions will be activated after a delay of 30 seconds after leaving the menu.

Note: If the measured vibration is too low for a precise calculation of the main frequency the unit will display “???” instead of a frequency.

### 3.3. Measuring in accordance with BS7385

#### 3.3.1. Measurement Procedure

The British Standard BS 7385 is mainly used in the Commonwealth countries. It is less complex than the DIN Standard. Similarly to the DIN standard, it also measures the peak value of the vibration velocity in all spacial dimensions. It is called “peak particle velocity” (ppv). The frequency range is not precisely specified. The VM40C uses the range 1 to 80 Hz and 1 to 315 Hz.

The Standard provides guide values for short-time vibrations, which are measured at the foundation (Table 4). The guide values mark the limit above which cosmetic damage may occur, such as cracks in the walls or ceilings. Lesser damage is to be expected at double the guide value and greater damage at fourfold the guide value. In the case of sustained vibrations or excitation from building resonance the guide values need to be reduced by at least 50%.

Residential and Industrial buildings are differentiated.

| <b>Guide values for short-time vibrations without excitation of building resonances</b> |  |   |
|---|--|---|
| Main Frequency  | Vibration Velocity for Residential Buildings | Vibration Velocity for Industrial Buildings |
| 1 – 4 Hz  | < 0.6 mm displacement                        | -   |
| 4 Hz  | 15 mm/s                                      | 50 mm/s                                     |
| 15 Hz   | 20 mm/s                                      | 50 mm/s                                     |
| 40 Hz   | 50 mm/s                                      | 50 mm/s                                     |
| 250 Hz  | 50 mm/s                                      | 50 mm/s                                     |

Table 4: Guide values in accordance with BS 7385

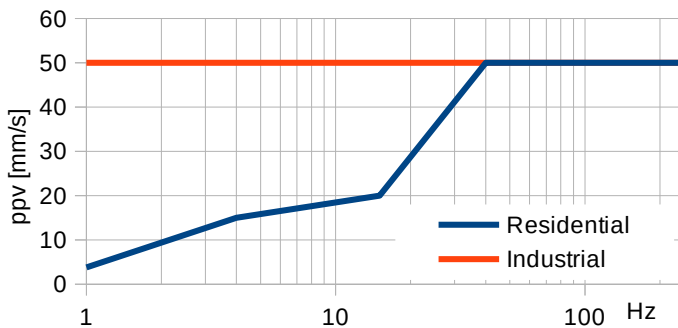

Figure 9: Graph: Guide values in accordance with BS 7385

### 3.3.2. Measuring with the VM40C

Once you have selected the measuring mode “BS7385”, select the building type to be assessed (Figure 10).

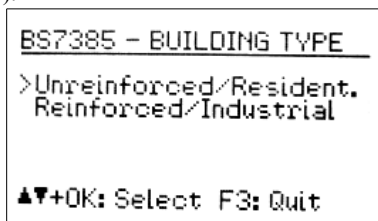

Figure 10: Building Type

In the next menu select the frequency range:

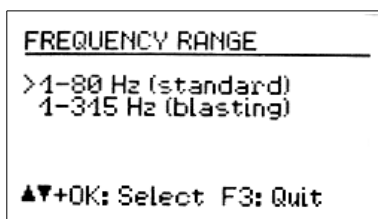

Figure 11: Frequency range

Press F3 to exit the menu and to go the measurement value display (Figure 12).



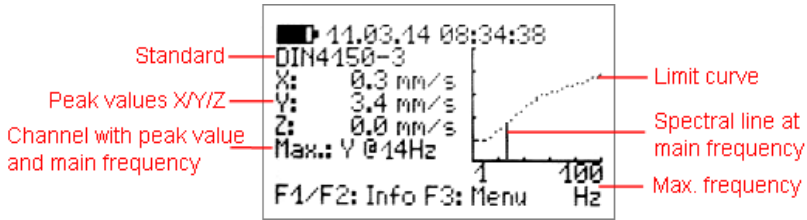

Figure 12: Measurement value display to BS7385

The three peak values X/Y/Z of the vibration velocity and the highest amplitude together with its main frequency are displayed every second. On the right side of the screen a graph displays the frequency spectrum (FFT) including the limit curve. The diagram is scaled to the limit curve. Higher magnitudes will be cut off.

If the limit value is exceeded, “ALARM” is displayed below the main frequency and the following will happen:

- The red light will flash.
- The measurement values will be saved if the event recording has been activated.
- The relay output will switch off, if it has been activated.
- A text message (SMS) will be sent, if this option has been set up and if the modem is connected.

Note: The alarm and recording functions will be activated after a delay of 30 seconds after leaving the menu.

Note: If the measured vibration is too low for a precise calculation of the main frequency the unit will display “???” instead of a frequency.

### 3.4. Measuring in accordance with SN 640312a

#### 3.4.1. Measurement Procedure

The Swiss Standard SN 640312a is also based on the peak values of the vibration velocity. However, it uses the vector sum as assessment parameter:

$$v_l = \sqrt{v_x^2 + v_y^2 + v_z^2}$$

It measures between 5 and 150 Hz. The frequency range is divided into three sections: 8 to 30 Hz, 30 to 60 Hz and > 60 Hz. For frequencies below 8 Hz the guide value for 8 to 30 Hz reduced by one-third is applied.

As a basis for the guide values, four building types with different levels of sensitivity, the occurrence of vibrations and the frequency with which the vibration influence occurs are taken as a the basis for the guide values (5).

#### 3.4.2. Measuring with the VM40C

After selecting the measuring mode “SN 640312a”, define which sensitivity class the building belongs to:

| Occurance of vibrations | very low sensitivity |            |                  | low sensitivity   |            |                  | normal sensitivity |            |                  | increased sensitivity |            |                  |
|-------------------------|----------------------|------------|------------------|-------------------|------------|------------------|--------------------|------------|------------------|-----------------------|------------|------------------|
|                         | occasio-<br>nally    | frequently | perma-<br>nently | occasio-<br>nally | frequently | perma-<br>nently | occasio-<br>nally  | frequently | perma-<br>nently | occasio-<br>nally     | frequently | perma-<br>nently |
| 1 Hz                    | 45 mm/s              | 18 mm/s    | 9 mm/s           | 30 mm/s           | 12 mm/s    | 6 mm/s           | 15 mm/s            | 6 mm/s     | 3 mm/s           | 7,5 mm/s              | 3 mm/s     | 1,5 mm/s         |
| 30 Hz                   | 60 mm/s              | 24 mm/s    | 12 mm/s          | 40 mm/s           | 16 mm/s    | 8 mm/s           | 20 mm/s            | 8 mm/s     | 4 mm/s           | 10 mm/s               | 4 mm/s     | 2 mm/s           |
| 60 Hz                   | 90 mm/s              | 36 mm/s    | 18 mm/s          | 60 mm/s           | 24 mm/s    | 12 mm/s          | 30 mm/s            | 12 mm/s    | 6 mm/s           | 15 mm/s               | 6 mm/s     | 3 mm/s           |

Table 5: Guide values in accordance with SN 640312a

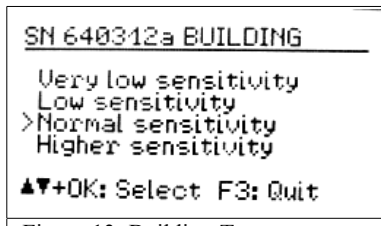

Figure 13: Building Type

Once you have selected the building type, select the occurrence of the vibrations. The figures represent the vibration emissions, at which the velocity vector exceeds the 0,7-fold guide value. The assessment period is the time duration during which the building is exposed to vibrations.

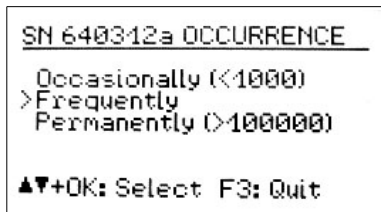

Figure 14: Occurrence

Press F3 to exit the menu and to go to the measurement value display (Figure 15).

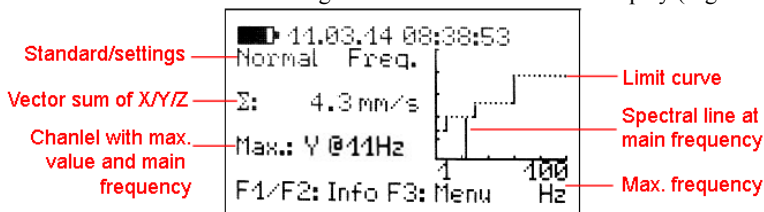

Figure 15: Measurement value display in accordance with SN 640312a

The vector sum of the vibration velocity in the three directions X/Y/Z and the highest amplitude together with its main frequency are displayed every second. On the right side of the screen a graph displays the frequency spectrum (FFT) including the limit curve. The diagram is scaled to the limit curve. Higher magnitudes will be cut off.

If the limit value is exceeded, “ALARM” is displayed below the main frequency and the following will happen:

- The red light will flash.
- The measurement values will be saved if the event recording has been activated.
- The relay output will switch off, if it has been activated.
- A text message (SMS) will be sent, if this option has been set up and if the modem is connected.

Note: The alarm and recording functions will be activated after a delay of 30 seconds after leaving the menu.

Note: If the measured vibration is too low for a precise calculation of the main frequency the unit will display “???” instead of a frequency.

### 3.5. Measurement in accordance with Circulaire 23/07/86

#### 3.5.1. Measurement Procedure

The French guideline specifies a measuring method and limits for building vibration. It differentiates between methods for “fine analysis” and “monitoring”. The VM40C supports the second method. Measurement is based on the peak values of vibration velocity in directions X/Y/Z between 4 and 150 Hz..

Relevant for evaluation is the maximum of the three peak values and its main frequency. The guideline gives limit values for resistant, sensitive and very sensitive structures and for permanent or short-time vibration. The limit values are found in figures 16 and 17.

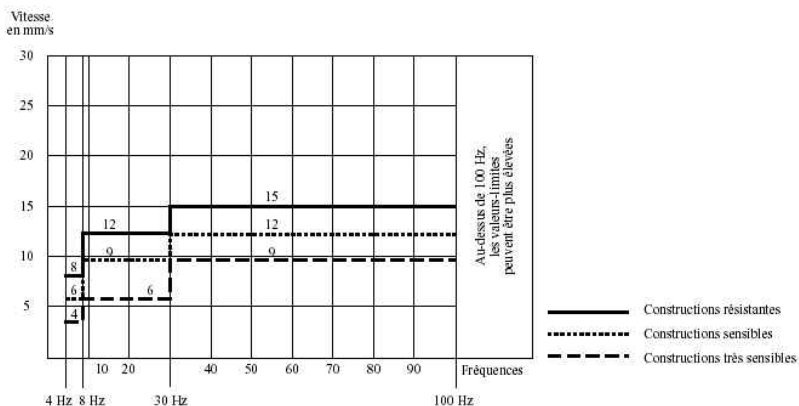

Figure 17: Limits for short-time vibration (Circulaire 23/07/86)

#### 3.5.2. Measuring with the VM40C

After selecting the measuring mode “Circulaire” you will be asked to enter the building type (resistant, sensitive or very sensitive). In the next step you select permanent or short-time vibration. Leave the menu by pressing OK.

The three peak values X/Y/Z of the vibration velocity and the highest amplitude together with its main frequency are displayed every second. On the right side of the screen a graph displays the frequency spectrum (FFT) including the limit curve. The diagram is scaled to the limit curve. Higher magnitudes will be cut off.

If the limit value is exceeded, “ALARM” is displayed below the main frequency and the following will happen:

- The red light will flash.
- The measurement values will be saved if the event recording has been activated.
- The relay output will switch off, if it has been activated.
- A text message (SMS) will be sent, if this option has been set up and if the modem is connected.

Note: The alarm and recording functions will be activated after a delay of 30 seconds after leaving the menu.

Note: If the measured vibration is too low for a precise calculation of the main frequency the unit will display “???” instead of a frequency.

### 3.6. Non-Standardized Measuring

If a standardized measurement is not desired, the vibration quantity (acceleration or velocity), the frequency range and the limit values can be entered manually. For this option select the measuring mode “Non-standardized”.

Next you can select the vibration quantity and frequency range (Figure 18).

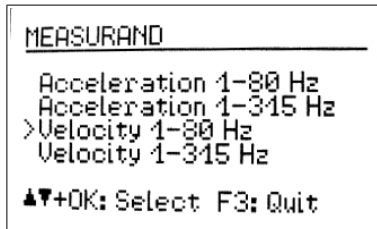

Figure 18: Non-standardized measurement

After this the points which define the limit value curve can be entered. The lowest and highest frequencies are fixed. The amplitudes and the two middle frequencies can be freely selected within the range limits. (Figure 19).

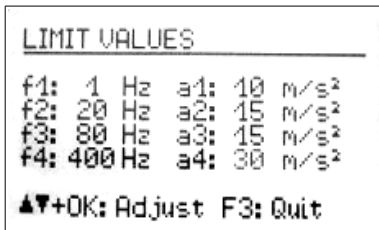

Figure 19: Entering limit values

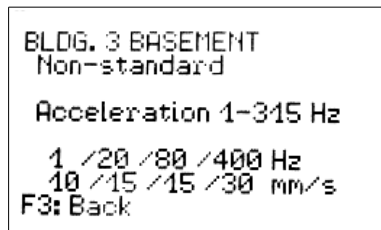

Figure 20: Display of limit values

As with the other measuring modes, your chosen measuring settings can be viewed during measuring by pressing F1 (Figure 20).

### 3.7. Overload Indication

If the vibration magnitude exceeds the limits shown in the Technical Data section, the VM40C will indicate “OVERLOAD” instead of the measuring value for the respective direction. (Figure 21).

In addition the warning and alarm LEDs flash simultaneously.

Due to integration the overload limit for velocity is frequency dependent (Figure 22).

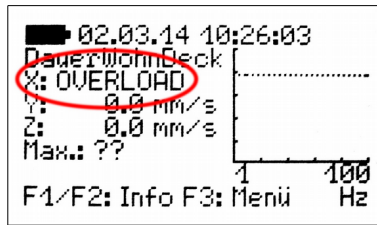

Figure 21: Overload indication

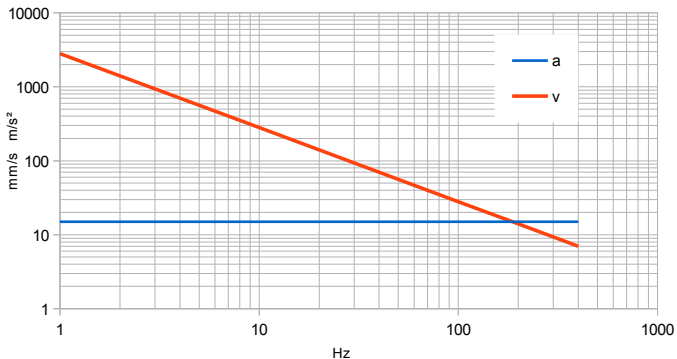

Figure 22: Overload limits for acceleration (a) and velocity (v)

## 4. Saving Measurement Values

### 4.1. Introduction

The VM40C has memory space for 100,000 measurements. The saved data can be viewed via the instrument menu or transferred to the PC via the USB interface.

A measurement record includes:

- Date and time
- Measurement values X/Y/Z or the vector sum
- Main frequency
- Trigger event

The instrument saves the data if any of the following events (triggers) occur:

- a warning or alarm event occurred
- a predefined time interval expired

Alarm events occur if the limits described in Section 3 are exceeded.

Warning events occur if the warning threshold is exceeded (see section 8.1).

The VM40C can also save measurements in fixed time intervals. In this case the highest X/Y/Z peak values since the last time step are saved<sup>1</sup>. Thereby no vibration event will be lost when recording in time intervals. This mode may be used if continuous recording is desired. It should be noted, however, that large amounts of data is accumulated withing short time. At 5 s recording interval, for example, the memory will be full after only 5 days. You should also be aware that it will take longer to transfer the data to a PC.

For most applications event controlled recording is sufficient. With carefully set alarm and warning limits all relevant vibration events are stored whereas time sections without vibration are ignored. This avoids the accumulation of useless data without information value. For verification purposes a combination of event and time controlled recording (e.g. with 5 minute intervals) may be useful. In any case the VM40C ensures continuous monitoring.

Notice: Saving measurements will start 30 seconds after leaving the menu.

Saved measurements are sorted in to data files in the VM40C. A file contains related measurements with the same settings.

## 4.2. Settings for Recording Data

To start recording open the main menu by pressing F3 and select “Recording” (Figure 23).

```
RECORDING
-----
>Start recording
View/edit/delete files
Print report
Delete all files

▲▼: Select  F3: Quit
```

Figure 23: Start Recording

Select “start”. Now you can define the events (triggers), when the data should be saved. (Figure 24).

---

1 from version 001.008, in earlier versions the current display value was saved

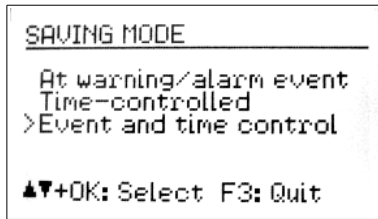

Figure 24: Trigger selection

In the setting “Warning/Alarm” the measurement value is saved as soon as a change in status occurs, as follows:

- Normal to Warning
- Normal to Alarm
- Warning to Alarm
- Alarm to Warning
- Alarm to Normal
- Warning to Normal

If the warning or alarm status persists, no further measured values will be saved. This keeps the quantity of saved data down to a minimum. The type of status change is saved with the measurement.

The VM40C also offers you the possibility of saving measurements at pre-set time intervals. The time intervals are to be entered in seconds, for a minimum of 5 seconds. (Figure 25).

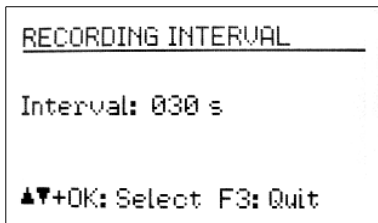

Figure 25: Recording interval

The time interval recording can also be combined with the status change recording (“Event and time control”).

After determining the recording settings you will be asked to enter the name of the data record (Figure 26).

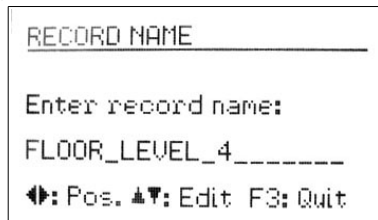

Figure 26: Record name

The record name identifies a block of related measurements with the same saved settings. Here you can enter, for example, the measurement location. With the arrow keys you can enter up to 20 upper case characters and digits. The last entered name appears as the default name. To exit the menu press OK.

Next you will be asked for SMS alarms. You may confirm if the modem is connected (see section 7.4).

After defining all the recording settings you can activate the keypad lock by pressing OK, to ensure that no unwanted interference occurs (see Section 8.2). You can also start recording without using the keypad lock by pressing F3 (27).

```
Activate key lock?
Unlock by USB command or
pressing all arrow keys
OK: Yes  F3: No
```

Figure 27: Key lock

The instrument will now display “Recording started”. Thirty seconds later the evaluation of the recording trigger (event or time interval) will begin. The currently active recording can be seen in the measurement value display as a blinking text “Rec.# xxx”, where xxx is the number of the previously saved measurements.

During recording the menu cannot be opened. If you press the menu button F3 you will be asked whether you wish to stop recording, the same will happen if you press OK/ON-OFF. The modem will also be switched off to save power.

After reaching the memory end the VM40C will display the error message “Memory full”.

Notice: The transmission of data from the VM40C to the PC is not possible while recording is active.

### 4.3. Viewing saved Data

After recording you can view the saved measurements in the “Recording” menu. Select the menu point “View/edit/delete files” and then use the arrow keys ▲▼ to select the data file you wish to view (28).

```
File No. 2 of 3
FLOOR LEVEL 4
Start: 11.03.14 08:43:44
BS 7385 (1-80Hz)
unreinforced/Res.
5 s + events
F1: Edit name  F4: Delete
▲▼+OK: Select  F3: Quit
```

Figure 28: Select file

A data file is displayed by its number and name, together with the start time, chosen standard and trigger source.

Note: The file numbers are not always in the order of saving. A previously erased file number will be re-assigned to the next saved file.



Pressing ◀ deletes the file together with all of its recorded measurements.

Press F1 to change the file name.

Press OK to open the file. The first saved record is then displayed (29). Below the file name you see the record number with the total number of records in the file, date and time and the trigger event. The abbreviations mean:

(T): time interval controlled

0→W: normal to warning transition

0→A: normal to alarm transition

W→A: warning to alarm transition

W→0: warning to normal transition

A→W: alarm to warning transition

A→0: alarm to normal transition

END: recording stopped by the user, last record

BAT: recording terminated because of low battery, last record

MEM: recording terminated because of full memory, last record

CH1: charging of the accumulator started

CH0: charging of the accumulator finished

When the data was measured to SN 640312a you see the vector sum, otherwise the three measuring values of X / Y / Z. The significant frequency  $f(\max)$  of the highest value is also displayed.

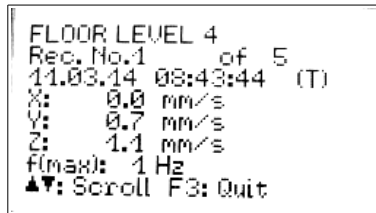

```
FLOOR LEVEL 4
Rec. No.1 of 5
11.03.14 08:43:44 (T)
X: 0.0 mm/s
Y: 0.7 mm/s
Z: 1.1 mm/s
f(max): 1 Hz
▲▼: Scroll F3: Quit
```

Figure 29: View record

Use keys ▲ ▼ to scroll between records. Press F3 to exit the menu.

#### 4.4. Deleting the Data Memory

In the “Recording” menu the entire memory can be deleted by selecting “Delete all files”. This can take several seconds, depending on the amount of data stored. The event counters (see chapter 4.5) are also reset.

#### 4.5. Alarm Statistics

In the measurement value display, press F2 for an overview of the warning and alarm events that have occurred. These are displayed together with the number of saved measured values.

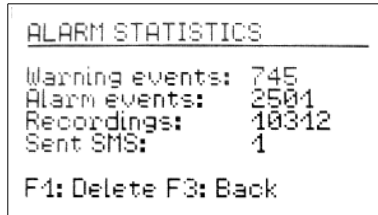

Figure 30: Event display

The sent SMS counter is only useful in combination with VM40-MODEM.

Press F1 to reset all counters.

## 4.6. Transferring the recorded data to a PC

For transferring saved data from the VM40C to a PC, a program is available (see section 9.2). It can be found on our website [http://mmf.de/software\\_download.htm](http://mmf.de/software_download.htm)

The program enables you to display the measured data as table or time graph and generates reports according to your own requirements. It also converts the measurement data into a table of comma-separated values (CSV).

## 5. Printing a Report

The mobile printer VM40-PRINTER is offered as an optional accessory. It enables printing an immediate report on the site of measurement. The small printer uses thermo paper rolls. It is powered from an internal accumulator. It only needs to be connected to the VM40C via the supplied cable.



Figure 31: Printer VM40-PRINTER

To print a report, please open the menu “Recording” (Figure 32).

```
RECORDING
-----
Start recording
View/edit/delete files
>Print report
Delete all files

▲▼: Select F3: Quit
```

Figure 32: Printer menu

Select “Print report” and press OK. Next you will see the menu for the selection of a data file. Use the ▲▼ keys and OK to select a file. If the file contains more than 50 records a warning message will be issued to avoid excessive paper consumption (Figure 33).

```
PRINTER WARNING
-----
Records in file: 88
Paper length: 70 cm†
Filter records?
OK: Yes F3: No
```

Figure 33: Warning at more than 50 records

You can continue printing all records by pressing F3 or filter the data before print-

```
FILTER PRINTER OUTPUT
-----
>Only alarms (6)
Warn. + alarms (18)
Max. value

▲▼: Select F3: Quit
```

Figure 35: Selecting data to be printed

ing using the ▲▼ keys (Figure 34).

The following options are available:

- Only recordings triggered by the alarm limit
- Recordings triggered by the warning or alarm limit
- Only the recording with the highest measuring value

By this moment the printer needs to be connected and switched on pressing the  button for at least 1 s. Press OK at the VM40C to start printing.

Each recording fills two lines. The number af-

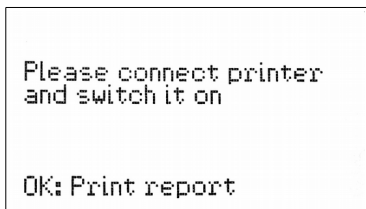

Figure 36: Start printing

ter “No.” indicates the position of the record in the VM40C memory. After “Event” you find the reason of recording. “A” stands for exceeding the alarm limit, “W” for exceeding the warning limit, “N” for dropping below the warning limit and “T” for recording in time intervals. In the last record “E” marks termination by the user, “B” because of battery discharge and “M” because of full memory. The recording event is followed by the time of recording.

The second line shows the measuring values. For triaxial measurement, e.g. to DIN 4150-3,

there are the three axis values X/Y/Z. For vector sums, e.g. to SN 640312a there is only one value per record. The main frequency is also printed.

Each printout ends with a record “Event: E”. This marks the end of recording.

In Figure 37 you see an example printout showing only alarm events. The header includes device data, settings and start time. Below you find the recordings.

The printout ends with “END OF REPORT”.

The printer switches off automatically when not used for longer time. The included battery can be charged by the supplied mains adapter.

## 6. Relay Output and Alarm Beacon VM40-L

The VM40C has a relay output for controlling external signaling devices. These can be, for example, warning lights and acoustic signaling devices.

Please pay careful attention to the maximum contact load (see technical data, section 16). The relay output is not suitable for direct connection of mains operated devices.

To adjust the settings open the main menu and select “Alarms” and then “Relay output”. You can pre-set the relay to energize or de-energize when warning status (see Section 8.1) or alarm status occurs. (38).

```

Triaxial Vibration Monitor VM40C
Ser.: 131215
Cal.: Nov 2016
Title: MARKT 16 KELLER
DIN 4150-3 (1-80Hz)
Mode: sust. lis. ceiling
Start: 28.08.17 10:01:13
Data filter: Only alarms

X      Y      Z      FREQU
No. 9  Event: A  12:31:26
2.31  2.59  9.34 mm/s 14Hz
No. 15 Event: A  12:31:38
2.23  3.15  8.53 mm/s 13Hz
No. 27 Event: A  12:32:25
1.94  2.84  13.25 mm/s 7Hz
No. 41 Event: A  12:32:46
2.13  2.74  10.11 mm/s 13Hz
No. 54 Event: A  12:33:23
2.46  2.67  14.34 mm/s 12Hz
No. 85 Event: A  12:35:36
2.29  2.65  9.74 mm/s 13Hz

END OF REPORT
    
```

Figure 37: Example printout



Figure 38: Relay output

In addition, you can determine whether the relay should stay energized (“Latching”) or de-energize after the event finishes, until OK is pressed (“Non-latching”).

Note: The relay function will be activated after a delay of 30 seconds after leaving the menu.

Figure 39 shows the output socket and its contact assignment. In neutral (de-energized) position the contacts “C” and “n.c.” are connected, during warning or alarm status (energized) the contacts “C” and “n.o.” are connected.

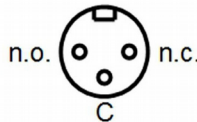

Figure 39: Relay output terminal assignment (external view of the socket)

Metra offers the alarm beacon VM40-L as accessory (Figure 40). It is supplied with 5 m connection cable to the VM40 relay output. Two LR20 batteries are included which last for approximately 180 hours of light. The battery compartment is opened by unscrewing the bottom lid.

Within the battery compartment there are also two switches. The white one enables a light sensor which switches off the beacon during day light. Since this will not be desired in most cases the white switch should be unlatched (off). The black push button selects the flashing pattern.

The switch outside the beacon is for testing.



Figure 40: Alarm beacon VM40-L

## 7. Receiving Alerts via SMS (VM40-MODEM)

### 7.1. General Information

The optional mobile phone modem VM40-MODEM can be connected for sending SMS text message alerts when vibration events occur. In this way the VM40C can be used far away grid-bound infrastructures.

The modem supports the 4G (LTE) frequency bands 3, 8 and 20 for Europe, Middle East and Africa and 2G (E-GSM-900 and DCS-1800).

Available is also model VM40-MODEM V2 with 4G bands B1, B2, B3, B4, B5, B8, B12, B13, B18, B19, B20, B26, B28 and 2G bands B2, B3, B5, B8 for world-wide use.

The modem is connected via a 5 m long cable to the 8 pin socket of the VM40C which helps to find a suitable location even in places with poor network coverage. Power supply for the modem is provided from the VM40C.

To provide the additional power for the modem (current consumption is about three times higher than without modem) it is recommended to connect a USB mains plug adapter via the “+5 V supply” socket of the modem using the supplied USB cable (see section 12).



Figure 41: VM40-MODEM

### 7.2. Inserting the SIM Card

To use the SMS functions a SIM card is needed. Open the case of the modem by loosening two cross-headed screws (Figure 42). Remove the cover and open the SIM card holder. Insert a Micro SIM card in the direction printed on the case and push it in until you hear a clicking sound.



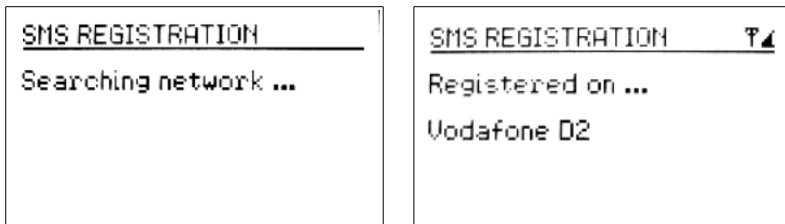

Figure 44: Mobile Registration

The antenna symbol and the reception quality display, with five levels in the upper right corner of the display indicate the connection status. If the reception quality is too low, a question mark appears next to the antenna symbol. An active connection is also indicated by the green LED at the modem. Next you will see the SMS settings menu (Figure 45).

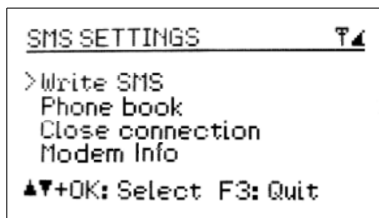

Figure 45: SMS Menu

## 7.4. SMS Alerts

In recording mode (see section 4), the VM40C with connected VM40-MODEM can send SMS messages including measurement values and the time when a limit value is exceeded. The necessary settings are made in the menu “Recording” / “Start recording” / “SMS alarms?” (Figure 46). A connection to the mobile network will be established automatically if not done before as shown in section 7.3.

Under the entry “Max. alerts/day” you can choose the maximum number of text

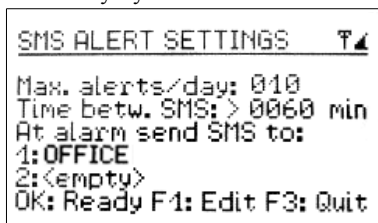

Figure 46: SMS Settings

messages the VM40C can send in one day. This allows you to control the connection costs.



Under “Time betw. SMS” you can set how many minutes the VM40C should wait before sending another SMS. This information also helps to avoid unnecessary costs or disturbances.

Furthermore, one or two telephone numbers need to be entered, to which the SMS messages should be sent. The numbers are selected from the phone book which is saved on the SIM Card (see Section 7.6).

Thirty seconds after starting the recording mode the SMS alert function will be activated. During measurement operation this is indicated by an “S” displayed in the top left corner next to the antenna symbol. (47).

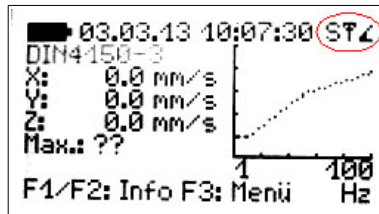

Figure 47: SMS Function display

The number of text SMS messages already sent can be viewed during measurement operation by pressing F2.



Figure 48: Number of messages sent

The message will be displayed on the receiver's mobile (varying slightly dependent on the receiving phone) as shown in Figure 49.

Under the heading “!!VIBRATION ALERT!!” the instrument name is displayed (see Section 8.5). Below this the date and time of the alarm event are displayed, followed by the three vibration values measured at the time of the alarm signal. Lastly the main frequency and the remaining accumulator power of the VM40C are shown.

A similar message including “!!LOW BATTERY ALERT!!”, date and time is shown at 5 % battery charge. At full memory a warning message “!!MEMORY ALERT!!” is sent.



Figure 49: Example of received SMS message

## 7.5. Polling the Alarm Status by Calling

For remote access the VM40C can be called via its mobile phone number. The instrument will terminate the call after the first ring tone without establishing a connection, i.e. there will be no connection fee for the caller. Some providers will play a “temporary unavailable” message which you can ignore by hanging up. Shortly after you will receive an SMS message with the number of occurred alarms, the maximum X/Y/Z values with main frequency, date and time since the last reset of the alarm statistics (see section 4.5) and the current battery condition (Figure 50).

Please note that the VM40C only reacts on caller numbers which are stored in the phone book of its SIM card.



Figure 50: SMS polling example



Figure 51: SMS polling without recording

If the VM40C is connected to the mobile network (see section 7.3) but not in recording / monitoring mode it will answer with an SMS message showing the maximum values and the text “NOT RECORDING!” (Figure 51).

## 7.6. Phone Book

The phone book is saved to the SIM card. If you have already contacts saved to the inserted SIM card, these will also appear in the VM40C. New contacts can be added to the phone book by the VM40C.

The phone book is found in the main menu under “Alarms/SMS”, sub-menu “SMS” and from there under “Phone book” (Figure 52). To edit the phone book you need to be connected to the network.

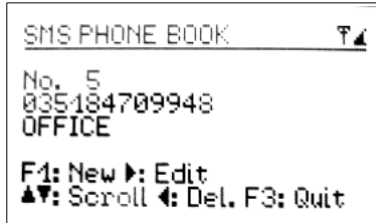

Figure 52: Phone Book

Press F1 to create a new entry. First enter the telephone number without spaces and then the name. Press OK to save the entry.

With the keys ▲▼ you can scroll through the existing entries.

Press ◀ to delete an entry.

Press ▶ to edit an existing entry.

The phone book can store a maximum number of 50 entries.

## 7.7. Writing an SMS

In the menu “Write SMS” under “Alarm/SMS”, sub-menu “SMS” you can write and send a short text message. You will then need to enter the receivers telephone number or select it from the phone book (Figure 53).

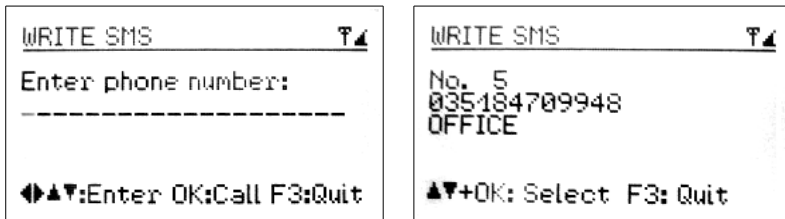

Figure 53: Enter receivers number or select from phone book.

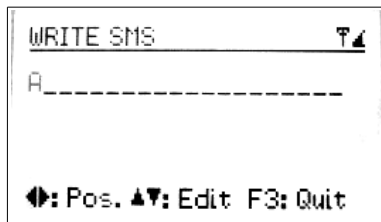

Figure 54: Write a short message

Next you can enter 4 rows of text, each up to a maximum of 20 characters long. At the end of each row press OK. After entering the fourth row the message will be sent. (Figure 54).

## 7.8. Close connection with mobile phone network

In the sub-menu “SMS” you will find the option “close connection”. Press OK to confirm you want close the connection with the mobile phone network (Figure 55). To prolong the life of the accumulator we recommend closing the connection with the mobile network when it is not being used. Keeping it connected runs down the accumulator more quickly.

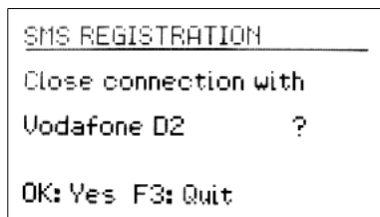

Figure 55: Close connection

## 8. Miscellaneous Settings

### 8.1. Warning Threshold

The warning threshold is an adjustable percentage value, which relates to the Alarm threshold of the selected standard (see Section 3). This enables you to automatically save measurement values or activate signaling at below the alarm limit of the applied standard.

If the warning threshold is exceeded the yellow light next to the display will flash.

To adjust the warning threshold, open the main menu by pressing F3, then select “Alarm/SMS” and “Warning Threshold (Figure 56).

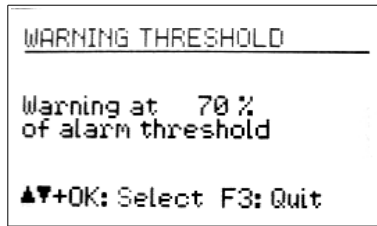

Figure 56: Warning Threshold

By pressing the keys ▲▼ you can set the value between 10 and 95 % .

## 8.2. Keypad Lock

To prevent manipulation during ongoing monitoring, it can be advantageous to activate the key lock. This function can be found in the main menu under “Key Lock” (Figure 57).

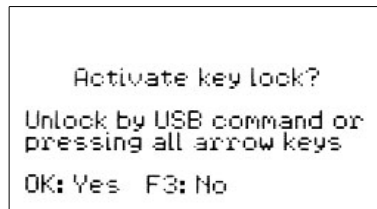

Figure 57: Key Lock

When the key lock has been activated, after leaving the menu you can only retrieve information using keys F1 and F2.

To release the key lock press all four arrow keys simultaneously, until the instrument displays “unlocked”.

Alternatively, the key lock can be switched on and off by a command sent via the USB interface.

## 8.3. Adjusting the Axes

The VM40C contains a tilt sensor for adjusting and monitoring the vertical alignment. The axes adjustment is located in the main menu under “Device settings”. There you will see a graph which resembles a spirit level (Figure 58). The moving point has to be located within the circle. If this is the case, “OK” will be displayed on the left of the screen.

To install/mount the VM40C on various floors or surfaces in conformity with a standard, Metra offers a tripod floor plate with adjustable feet.

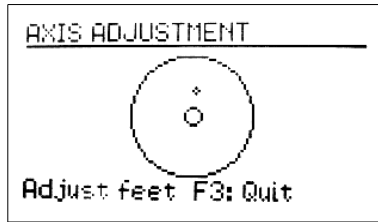

Figure 58: Axis adjustment

The axis adjustment is monitored during measurement operation. If the axes have been adjusted incorrectly, the flashing warning will appear in place of the standard “Adjust Axes!” (Figure 59).

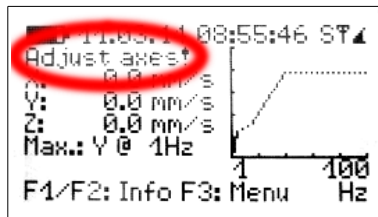

Figure 59: Warning "Adjust axes"

## 8.4. Date and Time

To retrace vibration events in the saved values the exact date and time are important. To set the data and time open the main menu, by pressing F3. From the main menu go to the menu option “Device settings” and press OK. From within this sub-menu go to “Date and time”.

Use the keys ▲▼ to change the flashing value and with the keys ◀▶ move between second, hour, minute, month, day and year.

The date also takes the leap year in to account.

In the same menu you can also correct clock inaccuracy. This can be done using the setting at “Cal.” in ppm (parts per million). The clock frequency can be increased with positive values and decreased with negative values. The sign changes to minus at +254 ppm.

Example: The clock is 5 seconds slow. There are  $24 * 60 * 60 \text{ s} = 86400 \text{ seconds}$  in a day. The difference amounts to  $5 \text{ s} / 86400 \text{ s} = 58 * 10^{-6} = 58 \text{ ppm}$ . The adjustable value is -58 ppm. Press OK to apply the settings.

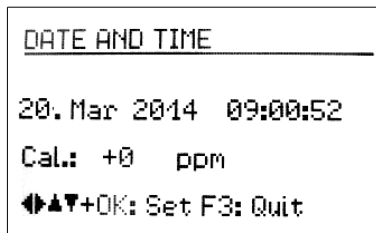

Figure 60: Date and Time

## 8.5. Instrument Name

The VM40C can be given an individual name, which, for example, identifies the location of installation. The instrument name is retrievable via the USB interface and is also used for the SMS alerts (VM40-MODEM) (see Section 7.4).

To enter the name open the main menu, go to “Device settings” and then to “Device name”.

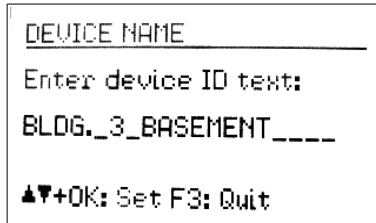

Figure 61: Device Name

Using the arrow keys you can enter up to 20 upper case characters and digits.

## 8.6. Menu Language

In the “Device settings” menu under “Menu language” you can choose between German and English. From our Download web page you may also install a firmware version in French and Italian (see section 10).

## 9. Data Transfer

### 9.1. Connection to a PC

The VM40C has a USB interface. For connecting to a PC the VM2x-USB cable is provided (Figure 74), which is connected to the second socket on the VM40C. As soon as the other end of the cable is connected to the computer USB socket, the device identification begins.

If the instrument is being connected to a PC for the first time you will be asked to carry out a driver installation. The required driver data MMF\_VCP.zip can be found on our website:

[http://mmf.de/software\\_download.htm](http://mmf.de/software_download.htm)

Save both data files in a directory on your computer.

When Windows requests details of the source of the device driver, this directory should be entered.

The device driver is digitally signed and runs with Windows 7, 8 and 10.

If the VM40C is connected to a PC, the signal “USB” appears on the measurement screen in place of the battery symbol. The battery power is then switched off and the instrument obtains its power supply via the USB connection.

### 9.2. Software VM40MDB

The PC software VM40MDB is used to archive and display measuring data from the VM40C. In addition it generates reports in accordance with the relevant standards.

You can download the license-free software from the web page

[http://mmf.de/software\\_download.htm#vm40](http://mmf.de/software_download.htm#vm40)

VM40MDB runs under Windows 7, 8 and 10.

Connect the VM40C to the USB port of the PC, switch it on and install the device driver, if necessary (see chapter 9.1).

Install VM40MDB and start it from the Windows start menu (Programs / Metra Radebeul). The main window will appear. (Figure 62).

Note: On 64 bit systems it may be necessary to install manually “SQL Server Compact” which can be found under this link:

<https://www.microsoft.com/en-us/download/details.aspx?id=5783>



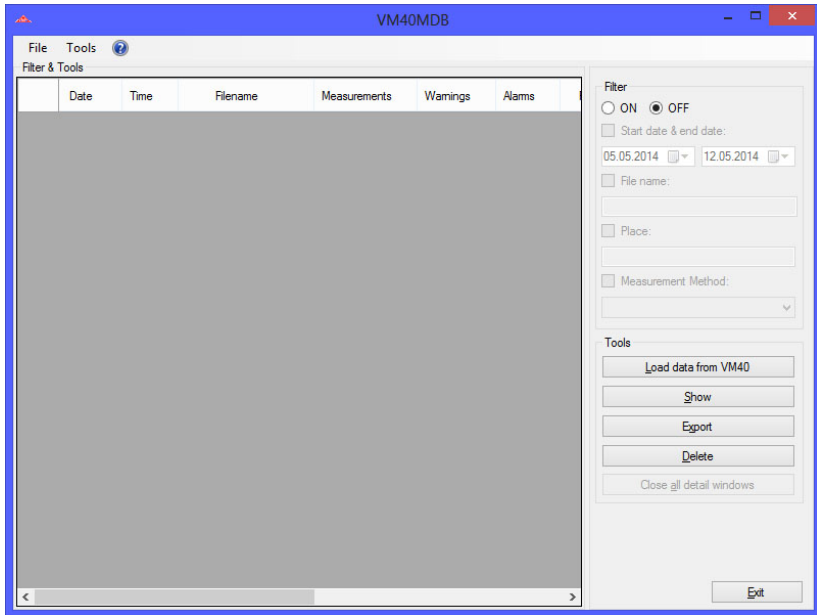

Figure 62: Main window without data

To start the transfer of data from the VM40C to the PC click “Load data from VM40”. The software will read header data first. Now you can select the files to be loaded by clicking the checkboxes (Figure 63).

Notice: The transmission of data from the VM40C to the PC is not possible while recording is active.

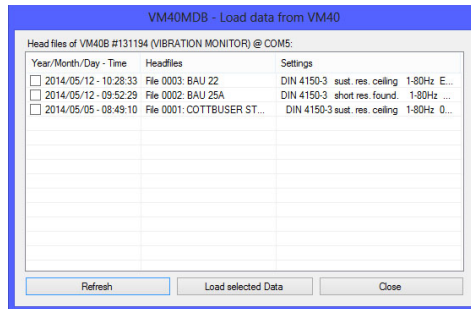

Figure 63: Selection of files

Click “Load selected data” to start the transfer. This may take up to some minutes for larger amounts of data. The progress is indicated above the list of header data.

| Date       | Time     | Filename            | Measurements | Warnings | Alarms |
|------------|----------|---------------------|--------------|----------|--------|
| 05.05.2014 | 08:49:10 | COTTBUSER STR 29 OG | 41928        | 49       | 57     |
| 12.05.2014 | 09:52:29 | BAU 25A             | 5            | -        | 2      |
| 12.05.2014 | 10:28:33 | BAU 22              | 6            | -        | 3      |

Figure 64: Imported data

VM40MDB can archive all measurements you have ever recorded with the VM40C. They can also come from different VM40C units.

To search in larger amounts of data there are filter functions on the right side of the header list. You may search for a certain range of calendar dates, parts of the file name or the “place” text or for the measurement mode. The wild-card character “\*” is allowed.

Select a record with the mouse pointer and click “Show”. A window showing “Properties” of the opened file will appear (Figure 65).

File COTTBUSER STR 29 OG: DIN 4150-3 @ 1-80 Hz (05.05.2014 - 08:49:10)

Properties | Measurement Chart | Measurements

Main properties

Filename: COTTBUSER STR 29 OG

Period: 05.05.2014 08:49:10 - 07.05.2014 15:51:26

Device: VM40B Serial number: 131194

Measurement method: DIN 4150-3 Frequency range: 1-80 Hz

Settings: sust. res. ceiling

Trigger mode: 005s + events

Measurement Summary

Measurements: 41928

Warnings (D-W): 49

Alarms (W-A, D-A): 57

Max. X-value: 97,62 mm/s

Max. Y-value: 93,31 mm/s

Max. Z-value: 113,94 mm/s

Optional Properties

Place: Fußbodenmitte in Raum 2

Comment:

Open protocol Export Cancel OK

Figure 65: File properties

You find the following information:

- Record name which was entered in the VM40C (see page 16)
- Period of recording
- Device name and serial number
- Used standard with detailed settings
- Record settings (triggers and interval)
- Number of saved measurements, warnings and alarms (colored)
- Maximum values for X, Y and Z

You may manually enter a description of the place of measurement, measuring conditions, etc. Two text fields are available for this purpose.

Click “Open protocol” to generate a report to DIN 4150-3, Appendix A. Under several menu tabs the necessary information is gathered (Figure 66). These include:

- Purchaser and person in charge
- Details about the source of vibration
- Description of the monitored structure
- Information about the location and the measuring point
- Environmental and other conditions
- Measuring results to be included

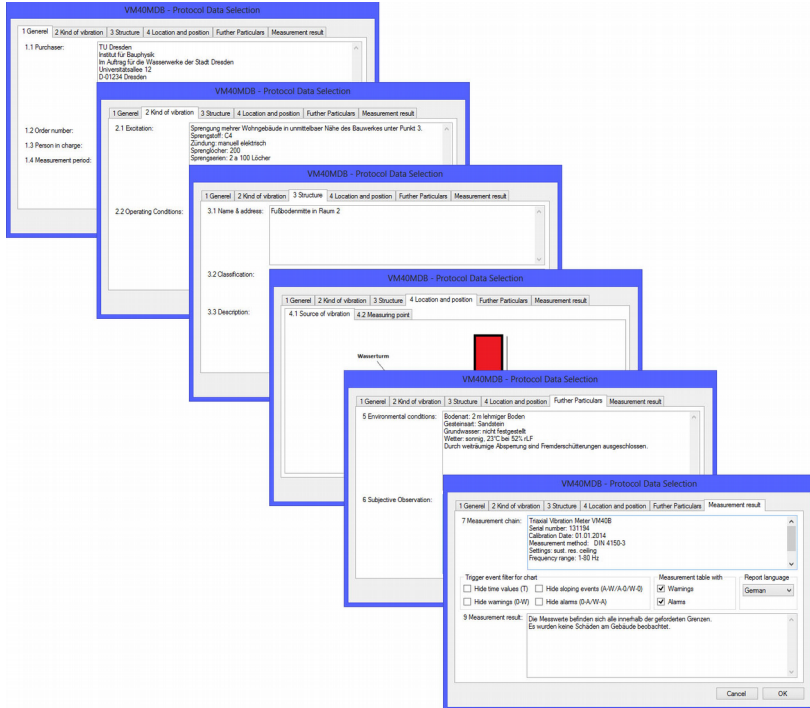

Figure 66: Entering data for the measuring report

In the menu “Location and position” pictures can be entered. Click inside the white space and load the image file from a specified storage position.

Press “OK” to complete the report. Figure 68 shows an example report.

The letter head of the protocol, including company address data and a logo, are entered in the menu “File” / “Settings” of the main window (Figure 67).

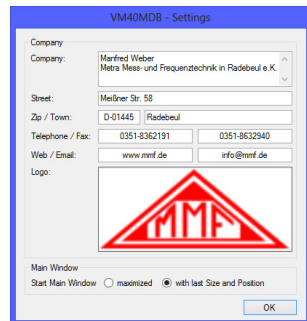

Figure 67: Protocol letter head



**Measurement protocol**

**1 General**

1.1 Purchase: TU Dresden  
 Institut für Bauphysik  
 im Auftrag für die Wasserwerke der Stadt Dresden  
 Universitätsallee 12  
 01028 Dresden

1.2 Order number: DK-2014/2348

1.3 Person in charge: Christian Richter

1.4 Measurement period: 05.05.2014 08:49:10 - 07.05.2014 15:51:26

**2 Kind of vibration**

2.1 Excitation: Sprengung mehrer Wohngebäude in unmittelbarer Nähe des Bauwerkes unter Punkt 3  
 Sprengstoff: C4  
 Zündung: manuell elektrisch  
 Sprenglöcher: 200  
 Sprengserien: 2 x 100 Löcher

2.1 Operating conditions: keine weiteren Erschütterungsquellen im Radius von 1 Kilometer.

**3 Structure**

3.1 Name and address: Fußbodenmitte in Raum 2

3.2 Classification: Baudenkmal nach DIN 4150-3

3.3 Description: Bauart: Wasserturmgebäude  
 Größe: Grundfläche 20m x 20 m / Höhe 30 m  
 Gründung: 1889  
 Baulicher Zustand: 1992 saniert, keine Schäden erkennbar.



**4 Location and position**

**4.1 Source of vibration**

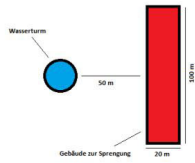

**4.2 Measuring point**

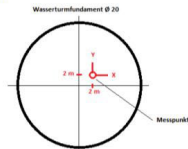

**5 Environmental conditions**

Bodenart: 2 m lehmiger Boden  
 Gesteinsart: Sandstein  
 Grundwasser: nicht festgesetzt  
 Wetter: sonnig, 23°C bei 52% rLF  
 Durch weitraumige Absperrung sind Fremderschütterungen ausgeschlossen.



**6 Subjective observations**

An der Abseppengrenze (1 km von Sprengung entfernt) waren keine sekundären Nebeneffekte außer der Explosion an sich zu spüren.

**7 Measuring chain**

Triaxial Vibration Meter VM408  
 Serial number: 131194  
 Calibration Date: 01.02.2014  
 Measurement method: DIN 4150-3  
 Settings: suit. res. ceiling  
 Frequency range: 1-80 Hz  
 Trigger mode: 005 + events  
 Measurement processing and report generation done with VM408MDB software.

**8 Measurement result**

**8.1 Event chart**

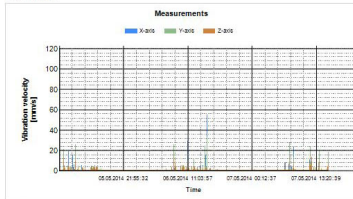

**8.2 Single measurements**

| Date       | Time     | X-axis [mm/s] | Y-axis [mm/s] | Z-axis [mm/s] | Frequency [Hz] | Trigger event |
|------------|----------|---------------|---------------|---------------|----------------|---------------|
| 05.05.2014 | 09:35:49 | 1,79          | 5,8           | 1,79          | 11             | Alarm (D-A)   |
| 05.05.2014 | 09:42:49 | 2,26          | 6,19          | 2,11          | 9              | Alarm (D-A)   |
| 05.05.2014 | 10:22:57 | 4,7           | 20,47         | 7,32          | 9              | Alarm (D-A)   |
| 05.05.2014 | 10:32:45 | 5,18          | 1,52          | 1,26          | 3              | Alarm (D-A)   |
| 05.05.2014 | 10:39:51 | 19,42         | 4,39          | 2,44          | 5              | Alarm (D-A)   |
| 05.05.2014 | 11:22:48 | 9,54          | 2,13          | 1,6           | 11             | Alarm (D-A)   |
| 05.05.2014 | 11:22:59 | 15,62         | 1,97          | 1,98          | 2              | Alarm (D-A)   |



|            |          |       |       |       |    |             |
|------------|----------|-------|-------|-------|----|-------------|
| 07.05.2014 | 13:19:35 | 0,90  | 5,77  | 13,42 | 11 | Alarm (D-A) |
| 07.05.2014 | 13:19:53 | 1,68  | 5,19  | 2,97  | 9  | Alarm (D-A) |
| 07.05.2014 | 13:41:33 | 5,55  | 8,75  | 2,97  | 11 | Alarm (D-A) |
| 07.05.2014 | 13:52:43 | 7,01  | 1,18  | 1,52  | 10 | Alarm (D-A) |
| 07.05.2014 | 13:53:51 | 5,44  | 2,09  | 2,55  | 9  | Alarm (D-A) |
| 07.05.2014 | 13:53:59 | 10,96 | 20,42 | 3,22  | 8  | Alarm (D-A) |
| 07.05.2014 | 15:44:36 | 8,57  | 19,34 | 4,08  | 2  | Alarm (D-A) |
| 07.05.2014 | 15:44:45 | 1,3   | 5,74  | 5,49  | 11 | Alarm (D-A) |
| 07.05.2014 | 15:47:31 | 1,94  | 6,11  | 5,04  | 8  | Alarm (D-A) |
| 07.05.2014 | 15:51:14 | 97,60 | 90,31 | 76,33 | 3  | Alarm (D-A) |
| 07.05.2014 | 15:51:25 | 7,94  | 4,69  | 2,12  | 2  | Alarm (D-A) |

**9 Evaluation**

Die Messwerte befinden sich alle innerhalb der geforderten Grenzen.  
 Es wurden keine Schäden am Gebäude beobachtet.

**10 Signs**

Person in charge & stamp \_\_\_\_\_  
 Purchaser \_\_\_\_\_

Figure 68: Example report (4 pages)

Apart from the report function you may display the measuring data graphically by selecting the menu tab “Measurement chart” (Figure 69). You will see all measurements in a magnitude/time diagram. Displayed events can be filtered depending on their trigger event. For example, you may want to see alarm events only. By right mouse click axes can be disabled. You may also save the diagram as image or in CSV table format to be further processed in Excel, OpenOffice Calc etc.

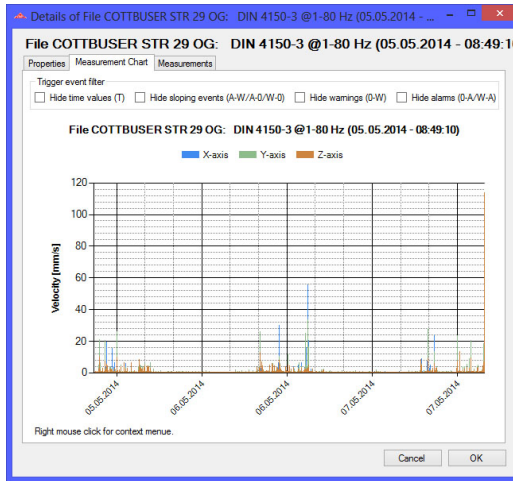

Figure 69: Measuring chart

Select the menu tab “Measurements” to switch to table view (Figure 70). Like in the diagram window you have the possibility to suppress certain kinds of events.

| Datum      | Uhrzeit  | X-Achse | Y-Achse | Z-Achse |
|------------|----------|---------|---------|---------|
| 05.05.2014 | 08:49:10 | 0.61    | 0.99    | 1.18    |
| 05.05.2014 | 08:49:15 | 0.58    | 1.23    | 0.61    |
| 05.05.2014 | 08:49:19 | 3.54    | 0.87    | 0.87    |
| 05.05.2014 | 08:49:25 | 0.33    | 0.34    | 0.17    |
| 05.05.2014 | 08:49:30 | 0.29    | 0.21    | 0.19    |
| 05.05.2014 | 08:49:34 | 0.24    | 0.17    | 0.16    |
| 05.05.2014 | 08:49:39 | 0.11    | 0.07    | 0.09    |
| 05.05.2014 | 08:49:44 | 0.11    | 0.08    | 0.07    |
| 05.05.2014 | 08:49:48 | 0.12    | 0.08    | 0.13    |
| 05.05.2014 | 08:49:53 | 0.1     | 0.11    | 0.1     |
| 05.05.2014 | 08:49:58 | 0.18    | 0.22    | 0.16    |
| 05.05.2014 | 08:50:02 | 0.08    | 0.13    | 0.11    |
| 05.05.2014 | 08:50:07 | 0.11    | 0.15    | 0.09    |
| 05.05.2014 | 08:50:13 | 0.07    | 0.13    | 0.16    |
| 05.05.2014 | 08:50:17 | 0.08    | 0.09    | 0.07    |
| 05.05.2014 | 08:50:22 | 0.23    | 0.09    | 0.07    |

Figure 70: Table view

Notice: The frequency column shows “???” instead of a main frequency if the magnitude was too low to detect a main frequency.

If you click “Export” in the main window you will be asked to select the events to be saved into an export file (Figure 62). Available export formats are text and CSV.

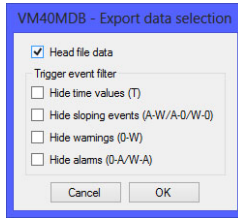

Figure 71: Selecting data for export

Finally, you may use the “Delete” button to erase data files from the VM40C memory.

## 10. Firmware Update

The device software (firmware) can be updated via the USB interface. First check whether an updated version of the currently installed software is available. This can be found on our website under:

[http://mmf.de/software\\_download.htm](http://mmf.de/software_download.htm)

There you will see the most recently updated firmware version. The version number is composed of three digits for the hardware and three for the software (hhh.sss). Only the last three digits are relevant for the Firmware.

The currently installed version is displayed on the VM40C start screen.

If firmware with a higher version number is available on the website, please proceed as follows:

1. Download the packed firmware file vm40c.zip from the above named internet address and unpack the contained file vm40c.hex to a folder of your choice  
Notice: The firmware file vm40c.zip is available in different menu languages.
2. Also download the program “Firmware Updater” from the above named internet address and install it on your PC.
3. Connect the VM40C to the PC using the supplied USB cable and switch it on, by doing this the PC recognizes it as a USB device.

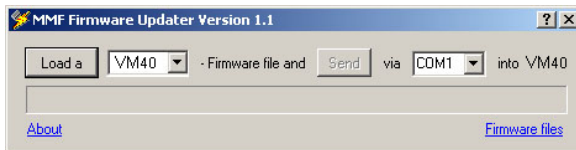

Figure 72: Firmware Updater

4. Start the “Firmware Updater”, then select the instrument type “VM40” and the virtual COM port assigned by the PC. If you are not sure which of the available COM ports is correct, you can check in the Windows system control manager located within the device manager.
5. Click on “Load” in the “Firmware Updater” and enter the path to the file where the downloaded firmware file vm40.hex is located.

6. Within the VM40C “Device settings” select the option “Update firmware” and confirm the subsequent warning by pressing OK (Figure 73). By carrying out this step the old Firmware is deleted. The VM40C will then indicate that it is awaiting new Firmware data from the USB interface (“Waiting for update”).



Figure 73: Start update

7. Click on “Send” in the “Firmware Updater” and confirm the subsequent hint. Transfer of the firmware data has now begun. The transfer progress is displayed as a time bar on the PC and also on the VM40C. When the update is finished the VM40C will carry out a new start and the “Firmware Updater” will close. Please do not interrupt the update process. After transfer failures the update can be restarted at point 3.

**Important:** Before starting an update please ensure that the battery is sufficiently charged. Otherwise the update may fail and can only be restored by the manufacturer.

## 11. Charging the Accumulator

The built-in NiMH accumulator has a capacity of 9 A h, which enables the VM40C to operate independently for more than 15 days. The usage of the mobile phone modem will approximately triple the current consumption and consequently shorten the operation time by two thirds.

NiMH accumulators have a self-discharge rate of 0,5 to 1 % per day.

The charge status is displayed in the top left corner of the display. Shortly after the battery symbol displays empty, the VM40C switches off. The device measures according to the specification until it reaches this state.

To recharge the accumulator please connect the charger provided to the device via the charge socket.

After connecting up the charger you need to switch the device on in order to start the charging process. After a few seconds “Chg” appears in the top left corner of the screen in place of the battery symbol. The accumulator has started charging, only when the “Chg” indicator appears and only while measurements are being displayed. If you open a menu or switch off the device the charging process will be interrupted.

If the accumulator is completely empty it takes approximately 10 hours to be fully recharged.

For longer measurements the charger can remain connected. The charge process will start automatically if the accumulator voltage drops under a minimum value. It is recommended, however, to support the accumulator by connecting a USB supply.

## 12. External Power Supply

For measurements of long duration an external power supply is recommendable.

To operate the VM40C using an external power supply, connect the USB cable provided via the device USB socket. (Figure 74).

To operate the device via a USB power supply you may use a standard USB wall charger with a minimum output current of 1500 mA at 5 V (please check the power rating of the device). If the VM40C is connected via USB, the text “USB” appears on the measurement screen in place of the battery symbol. The internal accumulator then switches off and the VM40C receives its power via the USB connection.

If there is no mains available in the measurement location you can power the VM40C from a USB battery, also called “Power Bank”. However, most of the commercially available power banks have an automatic switch-off function below a certain load current what makes them unsuited for powering the VM40C. There are some models with “Always On” feature which are suitable.

A source is <https://voltaicsystems.com/always-on-batteries>

If the modem is connected the VM40 can be powered externally via the modem connector (see section 7.1).

Notice: The battery charger VM40-CH is not recommended for permanent operation of the VM40C. Measurement can be continued with connected charger but for battery support during measurement a USB power source should be connected (see above).



Figure 74: USB Socket, USB Charger, power bank with Always-On feature



## 13. Reset

In rare cases the VM40C may not respond to key pressure. You can restart the firmware by pressing the internal reset button. For this purpose the case needs to be opened by unscrewing the four screws of plastic covers and then further four screws which are under the gray plastic parts. Please open the lid carefully.

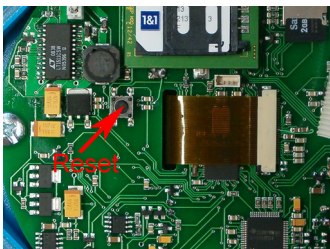

Figure 75: Reset button

Pressing the Rest button does not affect data in the memory. Only time and date need to be readjusted (chapter 8.4).

## 14. Mounting / Installation

The cast aluminum casing of the VM40C is suitable for direct mounting because of its weight. However, we recommend using the Tripod Floor Plate VM40-BP, available from Metra as a mounting accessory. (Figure 76). The VM40-BP has adjustable feet for aligning the axes, including exchangeable tips for different floor types.

At higher magnitudes the VM40C should be attached by screws. According to SN 640312a, free placement is not allowed at accelerations above  $3 \text{ m/s}^2$ . The corresponding velocity is, for example, 24 mm/s at 20 Hz or 12 mm/s at 40 Hz.

For screw attachment the VM40C has four through-holes for screws up to M5 with a maximum head diameter of 8 mm. It is not necessary to open the casing in order to mount the device. Only the two gray plastic panels need to be removed.



Figure 76: VM40C with Tripod Floor Plate VM40-BP

Figure 77 shows a dimensional drawing of the mounting holes.

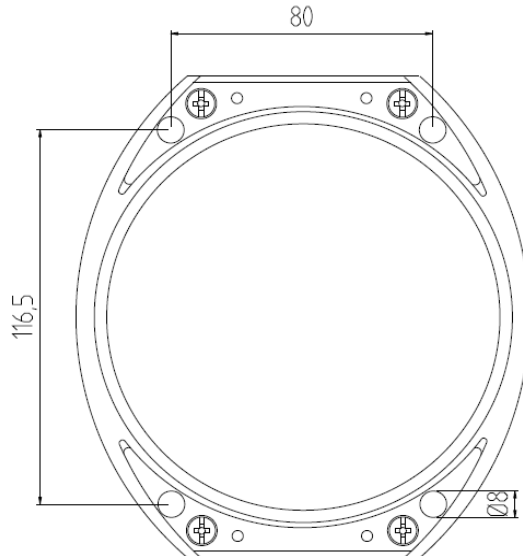

Figure 77: Dimensions of the mounting holes

## **15. Calibration**

A VM40C distinguishing feature of the VM40C is its high long-term stability. Depending on the intensity with which it is used we recommend a recalibration after approximately 1 to 2 years. The month and year of the last calibration are displayed on the start screen.

The calibration is performed through mechanical excitation with known vibration amplitudes.

Due to the weight of the device and the required low frequencies and high amplitudes a particular kind of vibration exciter is needed.

The calibration menu is not accessible to the user in order to avoid manipulation

Metra offers a calibration service. For calibrations in other labs we also provide the necessary technical documentation, upon request.

## 16. Technical Data

|   |  |
|---|--|
| Measured value                          | Peak value of vibration velocity or vibration acceleration   |
| Supported standards                     | DIN 4150-3; BS 7385; SN 640312a, Circulaire du 23/07/86  |
| Vibration Sensor                        | Triaxial piezoelectric shear type accelerometer  |
| Display ranges (peak)                   |  |
| Vibration acceleration:                 | 0.001 – 15 m/s <sup>2</sup>  |
| Vibration velocity:                     | 0.01 – 2400 mm/s at 1 Hz; 0.01 – 30 mm/s at 80 Hz<br>(full-scale value frequency dependent)  |
| Measurement accuracy                    | ±3 % ±20 digits at reference frequency 16 Hz, 100 Hz low pass<br>pass<br>±3 % ±40 digits at reference frequency 16 Hz, 395 Hz low pass                                 |
| Frequency ranges                        | 0.8- 100 Hz; 0.8 – 395 Hz, 5 – 150 Hz  |
| Display                                 | LCD, b/w, 128 x 64 pixels, back light<br>3 peak values (X/Y/Z) or vector sum<br>significant frequency<br>50 lines FFT spectrum<br>battery charge condition; date; time |
| Alarm signaling                         | Warning and Alarm LEDs next to the Display<br>Relay output (change-over contact, max. 100 VDC / 2 A)   |
| SMS alarm function<br>(with VM40-MODEM) | SMS transmission at vibration events<br>including X/Y/Z values, frequency, date, time, device name   |
| Measurement value<br>memory             | Built-in Micro SD card<br>max. 100 000 measurements (X/Y/Z, frequency, date, time,<br>trigger event)   |
| Analog/digital converter                | 24 Bit, Sigma-Delta  |
| USB interface                           | USB 2.0 Full-Speed, CDC mode, via cable VM2x-USB   |
| Accumulator                             | NiMH, 4.8 V / 9 Ah, charging duration: approx. 10 h;<br>buffered operation without accumulator load by USB power;<br>(e.g. USB mains adapter)                          |
| Battery operating life<br>per charge    | 5 – 15 days, depending on temperature, mobile communication<br>(VM40-MODEM) and display light duration   |
| Menu language                           | English / German / Italian / French  |
| Operating temperature<br>range          | - 20 – 60 °C   |
| Protection grade                        | IP67   |
| Dimensions                              | 150 mm x 140 mm x 80mm   |
| Weight                                  | 2 kg   |
| Accessories included                    | USB Cable VM40 USB<br>Battery charger VM40-CH  |
| Optional Accessories                    | Tripod Floor Plate VM40-BP<br>2G/4G (GSM/LTE) modem VM40-MODEM*<br>Portable battery-powered printer VM40-PRINTER   |

\* For the supported frequency bands see section 7.1

## Limited Warranty

Metra warrants for a period of  
**24 months**

that its products will be free from defects in material or workmanship and shall conform to the specifications current at the time of shipment.

The warranty period starts with the date of invoice.

The customer must provide the dated bill of sale as evidence.

The warranty period ends after 24 months.

Repairs do not extend the warranty period.

This limited warranty covers only defects which arise as a result of normal use according to the instruction manual.

Metra's responsibility under this warranty does not apply to any improper or inadequate maintenance or modification and operation outside the product's specifications.

Shipment to Metra will be paid by the customer.

The repaired or replaced product will be sent back at Metra's expense.

## Declaration of Conformity

According to EMC Directive 2014/30/EC

Product: Triaxial Vibration Monitor  
Type: VM40C (from Ser. no. 170000)

It is hereby certified that the above mentioned products comply with the demands pursuant to the following standards:

DIN EN 61326-1: 2013  
DIN EN 61010-1: 2011  
DIN 45669-1: 2010

The producer is responsible for this declaration

Metra Mess- und Frequenztechnik  
in Radebeul e.K.

Meißner Str. 58, D-01445 Radebeul

declared by



Michael Weber  
Radebeul, April 22, 2016