

Operating Manual

CB (E6.1)

CO₂ - Incubators

CO₂ – Incubators with O₂ control

with sterilizable NDIR sensor system for CO₂
and microprocessor controller T4.12

Model	Voltage	Equipment	Art. No.	
CB 60	230 V		9040-0088, 9140-0088	
CB 60-UL	100-120V		9040-0089, 9140-0089	
CB 60	230 V	O ₂ control	9040-0090, 9140-0090	
CB 60-UL	100-120V	O ₂ control	9040-0091, 9140-0091	
CB 60	230 V		Divided inner door	9040-0104, 9140-0104
CB 60-UL	100-120V		Divided inner door	9040-0105, 9140-0105
CB 60	230 V	O ₂ control	Divided inner door	9040-0106, 9140-0106
CB 60-UL	100-120V	O ₂ control	Divided inner door	9040-0107, 9140-0107
CB 160 (E6)	230 V		9040-0092, 9140-0092	
CB 160-UL	100-120V		9040-0093, 9140-0093	
CB 160 (E6)	230 V	O ₂ control	9040-0094, 9140-0094	
CB 160-UL	100-120V	O ₂ control	9040-0095, 9140-0095	
CB 160	230 V		Divided inner door	9040-0100, 9140-0100
CB 160-UL	100-120V		Divided inner door	9040-0101, 9140-0101
CB 160	230 V	O ₂ control	Divided inner door	9040-0102, 9140-0102
CB 160-UL	100-120V	O ₂ control	Divided inner door	9040-0103, 9140-0103
CB 220	230 V		9040-0096, 9140-0096	
CB 220-UL	100-120V		9040-0097, 9140-0097	
CB 220	230 V	O ₂ control	9040-0098, 9140-0098	
CB 220-UL	100-120V	O ₂ control	9040-0099, 9140-0099	
CB 220	230 V		Divided inner door	9040-0108, 9140-0108
CB 220-UL	100-120V		Divided inner door	9040-0109, 9140-0109
CB 220	230 V	O ₂ control	Divided inner door	9040-0110, 9140-0110
CB 220-UL	100-120V	O ₂ control	Divided inner door	9040-0111, 9140-0111

BINDER GmbH

- ▶ Address: Post office box 102, 78502 Tuttlingen, Germany ▶ Phone: +49 7462 2005 0
- ▶ Fax: +49 7462 2005 100 ▶ Internet: <http://www.binder-world.com>
- ▶ E-mail: info@binder-world.com ▶ Service Hotline: +49 7462 2005 555
- ▶ Service Fax: +49 7462 2005 93 555 ▶ Service E-Mail: service@binder-world.com
- ▶ Service Hotline USA: +1 866 885 9794 or +1 631 224 4340 x3
- ▶ Service Hotline Asia Pacific: +852 390 705 04 or +852 390 705 03
- ▶ Service Hotline Russia and CIS: +7 495 988 15 16

Contents

1. SAFETY	6
1.1 Legal considerations	6
1.2 Structure of the safety instructions	6
1.2.1 Signal word panel	6
1.2.2 Safety alert symbol	7
1.2.3 Pictograms	7
1.2.4 Word message panel structure	8
1.3 Localization / position of safety labels on the chamber	8
1.4 Type plate	10
1.5 General safety instructions on installing and operating the CO ₂ incubator	11
1.6 Precautions when working with gases	12
1.7 Precautions when handling gas cylinders	14
1.8 Intended use	15
2. CHAMBER DESCRIPTION	16
2.1 Chamber overview	17
2.2 Instrument panel	17
2.3 Inner chamber	18
2.4 Control panel on the rear of the chamber	20
3. COMPLETENESS OF DELIVERY, TRANSPORTATION, STORAGE, AND INSTALLATION	21
3.1 Unpacking, and checking equipment and completeness of delivery	21
3.2 Guidelines for safe lifting and transportation	21
3.3 Storage	22
3.4 Location of installation and ambient conditions	22
4. INSTALLATION AND CONNECTIONS	26
4.1 Shelves	26
4.2 Permadry™ water pan	26
4.3 Connecting the O ₂ sensor (chamber with O ₂ control)	27
4.4 Gas connections	28
4.4.1 Connection of the CO ₂ gas cylinder	29
4.4.2 Connection of the O ₂ gas cylinder (chamber with O ₂ control and optional alternative control range 10 up to 95 vol.-% O ₂)	30
4.4.3 Connection of the N ₂ gas cylinder (chamber with O ₂ control)	31
4.4.4 Connecting the gas hose to the chamber rear (for CO ₂ , O ₂ , N ₂)	32
4.4.5 Gas cylinder connection kits (option)	33
4.5 Electrical connection	34
4.6 Handling and aligning the divided inner door, gas proof (optional equipment)	35
5. START UP	36
5.1 Equilibration time	36
5.2 Factory settings	36
6. FUNCTIONAL OVERVIEW OF THE T4.12 CHAMBER CONTROLLER	37
6.1 Menu structure	38
6.1.1 General menu	38
6.1.2 Quick menu	39
6.1.3 User menu	40
6.2 Operating modes	41
6.2.1 Activating the “control off” mode or change to “fixed value” operating mode	41
6.3 Deactivating the O ₂ control and O ₂ /N ₂ pressure alarms (chamber with O ₂ control)	43
6.3.1 Required gas supply of the chamber with O ₂ control	43
6.3.2 Activating / deactivating the O ₂ control and O ₂ / N ₂ pressure alarms	44

6.4	Humidity control of the Permadyry™ system.....	45
6.5	Turning on / off the interior socket voltage (with optional interior socket).....	46
6.6	Performance during and after power failure.....	46
6.7	Information	47
7.	SETPOINT ENTRY	48
7.1	Setting ranges	48
7.2	Note when setting high gas concentrations	48
7.3	Entering the setpoints via “quick menu”.....	50
7.4	Entering the setpoints via general menu.....	52
8.	KEY LOCK	54
8.1	Directly activating the key lock.....	55
8.2	Automatic key lock	55
8.3	Changing the password for unlocking the key lock.....	57
9.	GENERAL CONTROLLER SETTINGS.....	58
9.1	Setup wizard	59
9.2	Date and time settings	59
9.3	Selecting the menu language of the T4.12 controller	61
9.4	Setting display brightness	61
9.5	Changing the temperature unit	62
9.6	Defining the data recording rate.....	62
9.7	Factory reset	63
9.8	Network configuration	63
9.9	Display of the network configuration	67
9.10	RS 422 address (with optional RS 422 interface).....	68
9.11	Display and entry of the device configuration – for service purpose	68
10.	DATA TRANSFER VIA USB INTERFACE	69
10.1	Exporting data to USB drive.....	69
10.2	Importing data from USB drive.....	70
11.	NOTIFICATIONS AND ALARMS.....	71
11.1	Notifications overview	71
11.2	Alarm messages overview	71
11.3	Alarm status	73
11.4	Confirming an active “set” alarm	74
11.5	Alarm configuration and overview.....	75
11.5.1	List of active alarms	75
11.5.2	History – list of all alarms.....	76
11.5.3	Activating, deactivating, and testing the alarm buzzer	77
11.5.4	Activating / deactivating all alarm functions.....	77
11.5.5	Setting the delay time after opening the door.....	78
11.5.6	Tolerance ranges and alarm delay times	78
11.6	Zero-voltage relay alarm output.....	82
12.	EVENT LIST	83
13.	GRAPHICAL DISPLAY OF THE MEASURED VALUES	84
13.1	Setting the sampling rate	84
13.2	Defining the display range.....	85
13.3	Selecting the parameters	86
14.	TEMPERATURE SAFETY DEVICES.....	87
14.1	Overtemperature protective device (class 1)	87
14.2	Overtemperature safety controller (temperature safety device class 3.1)	87
14.2.1	Safety controller modes	87
14.2.2	Setting the safety controller	88

15. OPTIONS.....	91
15.1 Communication software APT-COM™ 3 DataControlSystem (option).....	91
15.2 RS 422 interface (option).....	91
15.3 Silicone access ports 30 mm / 1.18 in, closable from both sides with silicon plugs (option).....	91
15.4 Interior socket 230V (option).....	92
15.5 Analog outputs for temperature and CO ₂ (option).....	94
15.6 Access port for extra-low voltage (option).....	94
15.7 BINDER Gas Supply Service – External bottle changer for CO ₂ , N ₂ or O ₂ (option).....	95
15.8 Stands.....	96
15.8.1 Stacking stand (option).....	96
15.8.2 Stacking adapter for direct thermal decoupled stacking (option).....	96
15.8.3 Base on castors (option).....	96
16. REFERENCE MEASUREMENTS	97
16.1 CO ₂ reference measuring.....	97
16.1.1 Measuring CO ₂ concentration indirectly via the pH of the cell medium.....	97
16.1.2 Measuring CO ₂ directly via chemical indicator tubes.....	98
16.1.3 Measuring CO ₂ directly with an electronic infrared measuring device.....	99
16.2 Temperature reference measurement.....	99
17. AVOIDING MICROBIAL CONTAMINATION.....	99
17.1 Cells and media.....	99
17.2 Laboratory conditions / equipment around the incubator.....	99
17.3 Working and behavior in the lab.....	100
17.4 Chamber design and equipment of the CO ₂ incubator.....	100
17.5 Handling the CO ₂ incubator.....	101
18. CLEANING, DECONTAMINATION / DISINFECTION, AND STERILIZATION..	103
18.1 Cleaning.....	103
18.2 Decontamination / chemical disinfection of the chamber.....	105
18.3 Hot-air sterilization at 180 °C / 356 °F.....	106
18.3.1 Overview.....	106
18.3.2 Performing a hot-air sterilization.....	107
18.3.3 Aborting the hot-air sterilization – general procedure.....	109
18.3.4 Aborting hot-air sterilization after less than 4 hours.....	110
18.3.5 Terminating successful sterilization during the cooling-down phase (abortion after more than 4 hours).....	112
18.3.6 Terminating the completed sterilization cycle.....	113
19. MAINTENANCE AND SERVICE	115
19.1 Maintenance intervals, service.....	115
19.2 Checking the air jacket heating fan.....	116
19.3 Checking the humidity system fan.....	116
19.4 Gas inlet fine filter.....	116
19.5 Sending the chamber back to BINDER GmbH.....	116
20. DISPOSAL	117
20.1 Disposal of the transport packing.....	117
20.1.1 Outer chamber packing.....	117
20.1.2 Packing inside the chamber and equipment.....	117
20.2 Decommissioning.....	118
20.3 Disposal of the chamber in the Federal Republic of Germany.....	118
20.4 Disposal of the chamber in the member states of the EU except for the Federal Republic of Germany.....	119
20.5 Disposal of the chamber in non-member states of the EU.....	120



21. TROUBLESHOOTING	121
21.1 General.....	121
21.2 Heating.....	121
21.3 Gas cylinder pressure too low.....	123
21.4 Gas concentration	124
21.5 Sterilization.....	126
21.6 Humidity	126
21.7 Controller.....	127
21.8 Open door	127
22. TECHNICAL DESCRIPTION.....	128
22.1 Factory calibration and adjustment	128
22.2 Over current protection	128
22.3 Definition of usable volume.....	128
22.4 CB technical data	129
22.5 Equipment and Options.....	131
22.6 Accessories and spare parts (extract)	132
22.7 Important conversion data for non-SI units.....	133
22.8 Conversion table for gas inlet pressures, bar – psi.....	133
22.9 Dimensions CB 60	134
22.10 Dimensions CB 160	135
22.11 Dimensions CB 220	136
23. CERTIFICATES AND DECLARATIONS OF CONFORMITY.....	137
23.1 EU Declaration of conformity	137
24. PRODUCT REGISTRATION	139
25. CONTAMINATION CLEARANCE CERTIFICATE	140
25.1 For chambers located outside the USA and Canada	140
25.2 For chambers in the USA and Canada.....	143

Dear customer,

For the correct operation of the CO₂ incubator CB, it is important that you read this operating manual completely and carefully and observe all instructions as indicated. Failure to read, understand and follow the instructions may result in personal injury. It can also lead to damage to the chamber and/or poor equipment performance

1. Safety

This operating manual is part of the components of delivery. Always keep it handy for reference. The device should only be operated by laboratory personnel especially trained for this purpose and familiar with all precautionary measures required for working in a laboratory. Observe the national regulations on minimum age of laboratory personnel. To avoid injuries and damage observe the safety instructions of the operating manual.

	 WARNING
	<p>Failure to observe the safety instructions. Serious injuries and chamber damage.</p> <ul style="list-style-type: none"> ➤ Observe the safety instructions in this operating manual. ➤ Carefully read the complete operating instructions of the chamber.

1.1 Legal considerations

This operating manual is for informational purposes only. It contains information for installing, start-up, operation and maintenance of the product. Note: the contents and the product described are subject to change without notice.

Understanding and observing the instructions in this operating manual are prerequisites for hazard-free use and safety during operation and maintenance. In no event shall BINDER be held liable for any damages, direct or incidental arising out of or related to the use of this manual.

This operating manual cannot cover all conceivable applications. If you would like additional information, or if special problems arise that are not sufficiently addressed in this manual, please ask your dealer or contact us directly by phone at the number located on page one of this manual

Furthermore, we emphasize that the contents of this operating manual are not part of an earlier or existing agreement, description, or legal relationship, nor do they modify such a relationship. All obligations on the part of BINDER derive from the respective purchase contract, which also contains the entire and exclusively valid statement of warranty administration. The statements in this manual neither augment nor restrict the contractual warranty provisions.

1.2 Structure of the safety instructions

In this operating manual, the following safety definitions and symbols indicate dangerous situations following the harmonization of ISO 3864-2 and ANSI Z535.6.

1.2.1 Signal word panel

Depending on the probability of serious consequences, potential dangers are identified with a signal word, the corresponding safety color, and if appropriate, the safety alert symbol.

 DANGER
<p>Indicates an imminently hazardous situation that, if not avoided, will result in death or serious (irreversible) injury.</p>

WARNING

Indicates a potentially hazardous situation which, if not avoided, could result in death or serious (irreversible) injury.

CAUTION

Indicates a potentially hazardous situation which, if not avoided, may result in moderate or minor (reversible) injury.

CAUTION

Indicates a potentially hazardous situation which, if not avoided, may result in damage to the product and/or its functions or of a property in its proximity.

1.2.2 Safety alert symbol



Use of the safety alert symbol indicates a **risk of injury**.

Observe all measures that are marked with the safety alert symbol in order to avoid death or injury.

1.2.3 Pictograms

Warning signs			
Electrical hazard	Hot surface	Explosive atmosphere	Stability hazard
Lifting hazard	Gas cylinders	Suffocation hazard	CO ₂ suffocation and poisoning hazard
Explosive substances	Fire promoting agents	Harmful substances	Risk of corrosion and / or chemical burns
Biohazard	Pollution Hazard		

Mandatory action signs			
Mandatory regulation	Read operating instructions	Disconnect the power plug	Lift with several persons
Environment protection	Wear protective gloves	Wear safety goggles	
Prohibition signs			
Do NOT touch	Do NOT spray with water	Do NOT climb	
	Information to be observed in order to ensure optimum function of the product.		

1.2.4 Word message panel structure

Type / cause of hazard.

Possible consequences.

- Instruction how to avoid the hazard: prohibition
- Instruction how to avoid the hazard: mandatory action

Observe all other notes and information not necessarily emphasized in the same way, in order to avoid disruptions that could result in direct or indirect injury or property damage.

1.3 Localization / position of safety labels on the chamber

The following labels are located on the chamber:

Pictograms (Warning signs)	Service label
<p>Hot surface</p> <ul style="list-style-type: none"> • on the outer chamber door 	<p>Service - Hotline</p> <p>International: + 49 (0) 7462 / 2005-555 USA Toll Free: + 1 866 885 9794 or: + 1 631 224 4340 Россия и СНГ: + 7 495 98815 17</p> <p>service@binder-world.com www.binder-world.com </p>
<p>Risk of injury</p> <ul style="list-style-type: none"> • on the outer door: CB-UL only • above the access ports (option) 	

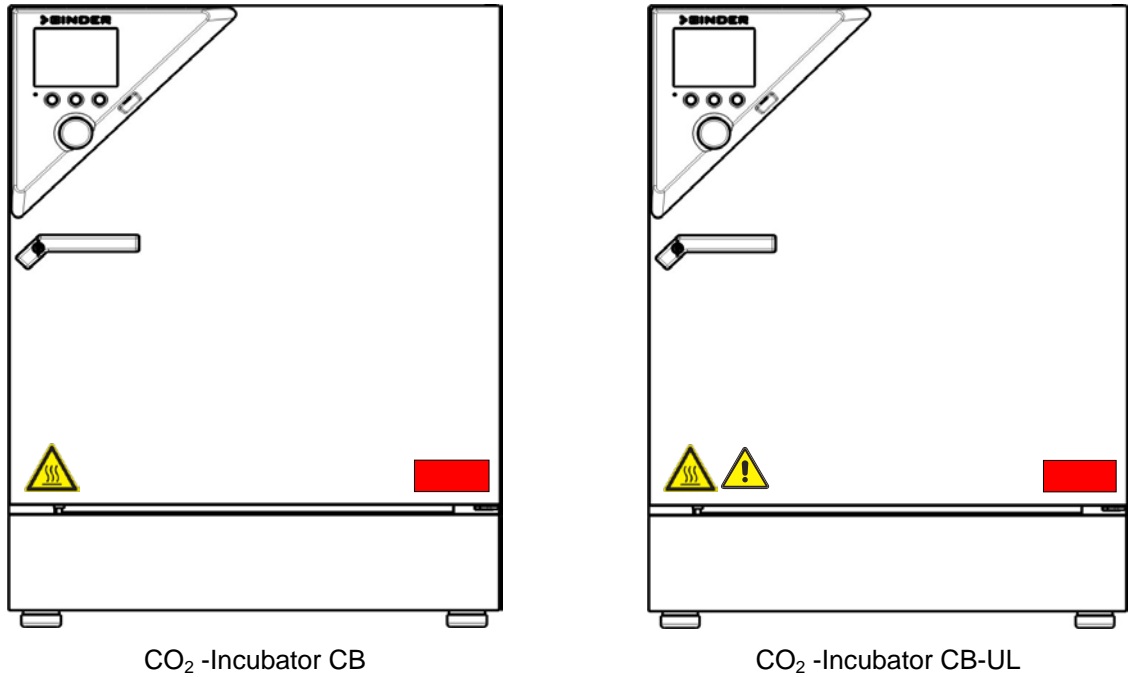

Figure 1: Position of labels on the chamber



Keep safety labels complete and legible.

Replace safety labels that are no longer legible. Contact BINDER service for these replacements.

1.4 Type plate

Position of type plate: left chamber side (seen from front), at the bottom in the middle

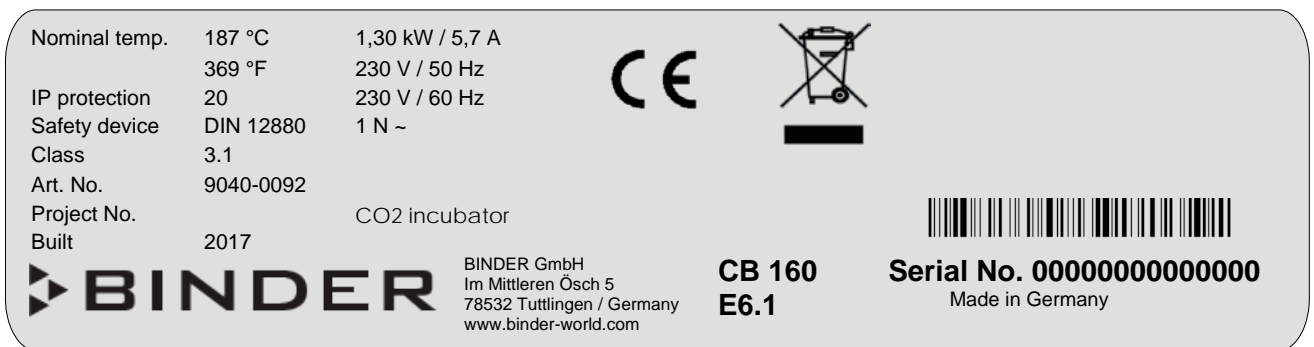





Figure 2: Type plate (example of CB 160 regular chamber)

Indications of the type plate (example)		Information
BINDER		Manufacturer: BINDER GmbH
CB 160		Model designation
CO2 incubator		Device name
Serial No.	0000000000000000	Serial no. of the chamber
Built	2017	Year of construction
Nominal temperature	187 °C 369 °F	Nominal temperature
IP protection	20	IP type of protection acc. to standard EN 60529
Temp. safety device	DIN 12880	Temperature safety device acc. to standard DIN 12880
Class	3.1	Class of temperature safety device
Art. No.	9040-0092	Art. No. of the chamber
Project No.	---	Optional: Special application acc. to project no.
1,30 kW		Nominal power
230 V / 50 Hz		Nominal voltage \pm 10% at the indicated power frequency
230 V / 60 Hz		
1 N ~		Current type
5,7 A		Nominal current

Symbol on the type plate	Information
	CE conformity marking
	Electrical and electronic equipment manufactured / placed on the market in the EC after 13 August 2005 and to be disposed of in separate collection according to Directive 2012/19/EU on waste electrical and electronic equipment (WEEE).
 (CB-UL only)	The chamber is certified by Underwriters Laboratories Inc. [®] according to the following standards: CAN/CSA-C22.2 No. 61010-1, 2 nd Edition, 2004-07 UL 61010-1, 2 nd Edition, 2005-07-22

1.5 General safety instructions on installing and operating the CO₂ incubator



With regard to operating the chamber and to the installation location, please observe the guideline BGI/GUV-I 850-0 on safe working in laboratories (formerly BGR/GUV-R 120 or ZH 1/119 laboratory guidelines issued by the employers' liability insurance association) (for Germany).

BINDER GmbH is only responsible for the safety features of the chamber provided skilled electricians or qualified personnel authorized by BINDER perform all maintenance and repair, and if components relating to chamber safety are replaced in the event of failure with original spare parts.



To operate the chamber, use only original BINDER accessories or accessories from third-party suppliers authorized by BINDER. The user is responsible for any risk caused by using unauthorized accessories.

	CAUTION
	<p>Danger of overheating. Damage to the chamber.</p> <ul style="list-style-type: none"> ⊘ Do NOT install the chamber in unventilated recesses. ➤ Ensure sufficient ventilation for dispersal of the heat.

Do not operate the chamber in hazardous locations.

	 DANGER
	<p>Explosion hazard. Danger of death.</p> <ul style="list-style-type: none"> ⊘ Do NOT operate the chamber in potentially explosive areas. ➤ KEEP explosive dust or air-solvent mixtures AWAY from the chamber.

The chamber does not dispose of any measures of explosion protection.

	 DANGER
	<p>Explosion hazard. Danger of death.</p> <ul style="list-style-type: none"> ⊘ Do NOT introduce any substance into the chamber which is combustible or explosive at working temperature. ⊘ NO explosive dust or air-solvent mixture in the inner chamber.



Any solvent contained in the charging material must not be explosive or inflammable. I.e., irrespective of the solvent concentration in the steam room, NO explosive mixture with air must form. The temperature inside the chamber must lie below the flash point or below the sublimation point of the charging material. Familiarize yourself with the physical and chemical properties of the charging material, as well as the contained moisture constituent and its behavior with the addition of heat energy.



Familiarize yourself with any potential health risks caused by the charging material, the contained moisture constituent or by reaction products which may arise during the temperature process. Take adequate measures to exclude such risks prior to putting the chamber into operation.

	 DANGER
	<p>Electrical hazard. Danger of death.</p> <ul style="list-style-type: none"> ⊘ The chamber must NOT become wet during operation or maintenance.

The chambers were produced in accordance with VDE regulations and were routinely tested in accordance to VDE 0411-1 (IEC 61010-1).

During and after a sterilization the temperature of the inner surfaces almost equals the set-point.



	 CAUTION
	<p>The inner doors, the inner door and glass door handles, and the inner chamber will become hot during a sterilization.</p> <p>Danger of burning.</p> <ul style="list-style-type: none"> ⊘ Do NOT touch the inner doors, the inner door and glass door handles, and the inner surfaces after a sterilization.

 	 WARNING
	<p>Stability hazard.</p> <p>Danger of injury.</p> <p>Damage to the chamber and the charging material.</p> <p>Housing cover breakaway.</p> <ul style="list-style-type: none"> ⊘ Do NOT climb on the lower housing cover. ⊘ Do NOT load the lower housing cover with heavy objects while the chamber door is open.

1.6 Precautions when working with gases



Notes on handling carbon dioxide (CO₂)

Carbon dioxide (CO₂) in high concentrations is hazardous to health. It is colorless and almost odorless and therefore practically imperceptible. Vent out any CO₂ gas that may escape via good room ventilation or a suitable connection to an exhaust system. We recommend installing a CO₂ warning system

	 WARNING
	<p>High concentration of CO₂ (> 4 Vol.-%).</p> <p>Risk of death by suffocation.</p> <p>Danger of poisoning.</p> <ul style="list-style-type: none"> ⊘ Do NOT set up chambers in non-ventilated recesses. ➤ Ensure technical ventilation measures. ➤ Observe the relevant regulations for handling CO₂.

Chamber with O₂ control: Notes on handling oxygen (O₂)

Oxygen (O₂) is colorless and almost odorless and therefore practically imperceptible. It promotes burns, which can proceed explosively. There is a fire hazard for flammable oxygenated materials, e.g. clothes and hair. O₂ is heavier than air and may accumulate in low-lying areas.



	 WARNING
	<p>High concentration of O₂ (> 21 % O₂). Fire and explosion hazard through contact of combustible materials with O₂. Risk of burns and other injuries.</p> <ul style="list-style-type: none"> ⊘ Do NOT set up chambers in non-ventilated recesses. ➤ Ensure technical ventilation measures. ➤ Observe the relevant regulations for handling O₂.

Take appropriate measures to prevent oxygen enrichment and fire and explosion hazards in areas where oxygen enrichment is possible.

	<p>General information for safe handling of oxygen:</p> <ul style="list-style-type: none"> • Make sure training of personnel on hazards of oxygen enrichment and necessary safety measures. • Make sure adequate labeling of all oxygen equipment and facilities. • Make sure gas tightness of all gas connections by checking them for leaks (e.g. with leak spray or diluted soap solution). • Close the main valve of the source of oxygen after work when not using the chamber. • Never lubricate O₂ equipment with oil or fat. Use only materials and spare parts which are approved for use with oxygen. • Regularly inspect fire extinguishers for proper condition. • Set up emergency showers where oxygen enrichment is possible. • Strictest smoking ban and no ignition sources in areas where oxygen enrichment is possible. • Make sure good ventilation of areas where oxygen enrichment is possible (location of the chamber and/or O₂ cylinders). • Persons who may have been in a possibly oxygen-enriched atmosphere must keep away from ignition sources (flames, cigarettes, etc.) and ventilate their clothes at least 15 minutes. • Always keep emergency routes free.
---	---

Chamber with O₂ control: Notes on handling nitrogen (N₂)



Nitrogen (N₂) in high concentrations is hazardous to health. It is colorless and almost odorless and therefore practically imperceptible. Any N₂ gas that may escape must be safely led out via good room ventilation or a suitable connection to an exhaust system.

	 WARNING
	<p>High concentration of N₂. Risk of death by suffocation.</p> <ul style="list-style-type: none"> ⊘ Do NOT set up chambers in non-ventilated recesses. ➤ Ensure technical ventilation measures. ➤ Observe the relevant regulations for handling N₂.



1.7 Precautions when handling gas cylinders

	<p>General information for safe handling of gas cylinders:</p> <ul style="list-style-type: none"> • Store and use gas cylinders only in well-ventilated locations. • Open the gas cylinder valve slowly to avoid pressure surges. • Secure gas cylinders during storage and use against falling (chaining). • Transport gas cylinders with a cylinder cart, do not carry, roll, or throw them. • Always close the valve even with apparently empty cylinders; screw on the cap when not in use. Return gas cylinders with the valve closed. • Do not open gas cylinders by force. Mark them when damaged. • Protect gas cylinders against fire, e.g. do not store together with flammable liquids. • Observe relevant regulations for dealing with gas cylinders.
---	---

Secure the gas cylinders against falling and other mechanical damage.

	<div style="background-color: #FFA500; padding: 5px; text-align: center;">  WARNING </div> <p>Safety valve tearing off. Sudden release of the stored pressure energy. Risk of injury.</p> <ul style="list-style-type: none"> ➤ Secure gas cylinders against falling (chaining). ➤ Transport gas cylinders with a cylinder cart.
---	--

The valve of the gas cylinder **always** must be closed before screwing on or unscrewing the gas hose.

	<div style="background-color: #FFA500; padding: 5px; text-align: center;">  WARNING </div> <p>Opening the cylinder valve when the cylinder is not connected. Sudden release of the stored pressure energy. Risk of injury.</p> <ul style="list-style-type: none"> ➤ Close the gas cylinder valve before connecting or removing the gas hose.
---	--



	<p>After connecting the gas cylinder, check all gas connections for leaks (e.g. with leak spray or diluted soap solution).</p>
---	--

1.8 Intended use

Series CB incubators are suitable for the cultivation of mammal cells under typical conditions of approx. 37 °C / 98.6°F. The chamber permits setting defined pH conditions by common NaHCO₃ buffer systems of commercial cell media by keeping an exact CO₂ atmosphere inside. The chambers guarantee high humidity inside to avoid osmolarity increasing caused by the evaporation of the cell media.

With the chamber with O₂ control, a variable oxygen atmosphere can additionally influence the growth of the cells.

The chambers are suitable for exact conditioning of harmless materials. Any possible solvent any solvent must not be explosive and flammable. Components of the charging material must NOT form an explosive mixture with air. The operating temperature must lie below the flash point or below the sublimation point of the charging material. Any component of the charging material must NOT be able to release toxic gases.

 	 DANGER
<p>Explosion or implosion hazard.</p> <p>Danger of poisoning.</p> <p>Danger of death.</p> <ul style="list-style-type: none"> ∅ Do NOT introduce any substance combustible or explosive at working temperature into the chamber, in particular no energy sources such as batteries or lithium-ion batteries. ∅ NO explosive dust or air-solvent mixture in the inner chamber. ∅ Do NOT introduce any substance which could lead to release of toxic gases. 	

Other applications are not approved.

	<p>Following the instructions in this operating manual and conducting regular maintenance work (chap. 19.1) are part of the intended use.</p>
---	---

The chambers are not classified as medical devices as defined by the Medical Device Directive 93/42/EEC.

	<p>Due to the special demands of the Medical Device Directive (MDD), these chambers are not qualified for sterilization of medical devices as defined by the directive 93/42/EEC.</p>
---	---

	<p>WARNING: If customer should use a BINDER chamber running in non-supervised continuous operation, we strongly recommend in case of inclusion of irrecoverable specimen or samples to split such specimen or samples and store them in at least two chambers, if this is feasible.</p>
---	--

	<p>The charging material shall not contain any corrosive ingredients that may damage the machine components made of stainless steel, aluminum, and copper. Such ingredients include in particular acids and halides. Any corrosive damage caused by such ingredients is excluded from liability by BINDER GmbH.</p>
---	---

In case of foreseeable use of the chamber there is no risk for the user through the integration of the chamber into systems or by special environmental or operating conditions in the sense of EN 61010-1:2010. For this, the intended use of the chamber and all its connections must be observed.

2. Chamber description

The CO₂ incubators CB are equipped with a multifunctional microprocessor display controller for temperature, CO₂, and O₂ (chamber with O₂ control) levels and a digital display accurate to one-tenth of a degree resp. 0.1 vol.-%

The inner chamber, the pre-heating chamber and the inside of the doors are all made of stainless steel V2A (German material no. 1.4301, US equivalent AISI 304). The inner surfaces are smooth and therefore easy to clean. The inner chamber is deep-drawn from one piece, polished (suitable for pharmaceutical applications) and has no welds or inaccessible corners. The hinges and the seal of the inner glass door are glued from the outside to aid cleaning of the inner chamber. When operating the chamber at high temperatures (sterilization), the impact of the oxygen in the air may cause discoloration of the metallic surfaces (yellowish-brown or blue) by natural oxidation processes. These colorations are harmless and will in no way impair the function or quality of the chamber.

The perforated shelves are also made of stainless steel. You can insert a maximum of 3 (CB 60), 6 (CB 160), resp. 8 (CB 220) shelves.

The housing is RAL 7035 powder-coated. All corners and edges are also completely coated.

The chamber's heating system permits hot-air auto-sterilization at a setpoint of 187.5 °C / 369.5°F. Thus, a temperature of 180 °C / 356°F is maintained for at least 30 minutes on all internal surfaces, resulting in sterilization of the entire inner chamber. Therefore, this procedure meets all international guidelines regarding hot air sterilization, e.g. AAMI ST63, DIN 58947, European Pharmacopoeia.

Thanks to the standard safety device (class 3.1 according to DIN 12880), the set temperature is maintained in case of failure.

The gas enters the chamber via a fine filter (aseptic filter) with a high filtration efficiency that also filters the smallest particles.

A highly precise, drift-free CO₂ infrared measuring system in combination with the permanent mixture of CO₂ gas through a special proprietary gas mixing head developed by BINDER allows precise and constant CO₂ concentrations for long periods. This creates optimum growth conditions for cultures.

The CO₂ incubator is also available with O₂ control in addition to CO₂ control. There are two different control ranges:

- Regular equipment: Hypoxic control range **0.2 to 20 vol. % O₂**. Only N₂ can be connected to reduce O₂ concentration; it is not possible to connect O₂ gas bottles to increase O₂ concentration. Control in the low O₂ range is very precise, in particular in the range below 1 vol. % O₂.
- Alternative control range **10 to 95 vol. % O₂** (option no. 8012-1106). Although the high control range is intended in particular for hyperoxic applications (> 21 vol. % O₂), it is also suitable for slightly hypoxic applications between 10 and 20 vol. % O₂.

CO₂ and O₂ sensors

Fast reaction times, maximum accuracy and selectivity characterize the CO₂ measuring procedure of the CB incubator series. The accuracy of the CO₂ measuring system is based on a double-beam infrared measuring cell with NDIR (non-dispersive infrared) sensor, which continuously regulates to a reference value. Therefore, disturbance variables and aging phenomena in the measuring system are almost completely eliminated, so that this measuring system, in contrast to other measuring procedures, remains practically drift-free between calibrations and is entirely selective for CO₂. The sensor is built into the chamber and can be sterilized.

The O₂ sensor is a semiconductor gas sensor with ZrO₂ ceramic.

The accuracy of the indicated values of CO₂ and O₂ (chamber with O₂ control) depends on the ambient air pressure (approx. 0.08 vol.-% per 10 mbar / 0.15 psi). To compensate for this effect in the CO₂ measurement, the controller measures the ambient air pressure and automatically includes it in the calculation.

The chambers are equipped with an Ethernet interface for computer communication, e.g. with the communication software APT-COM™ 3 DataControlSystem (option, chap. 15.1). For further options, see chap. 22.5.

Temperature range:	7 °C / 12.6 °F above ambient temperature up to +60 °C / 140 °F
CO₂ range:	0 vol.-% up to 20 vol.-%)
O₂ range (chamber with O ₂ control):	0.2 vol.-% up to 20 vol.-% (hypoxic control range) or 10 Vol.-% up to 95 Vol.-% (alternative control range)

2.1 Chamber overview

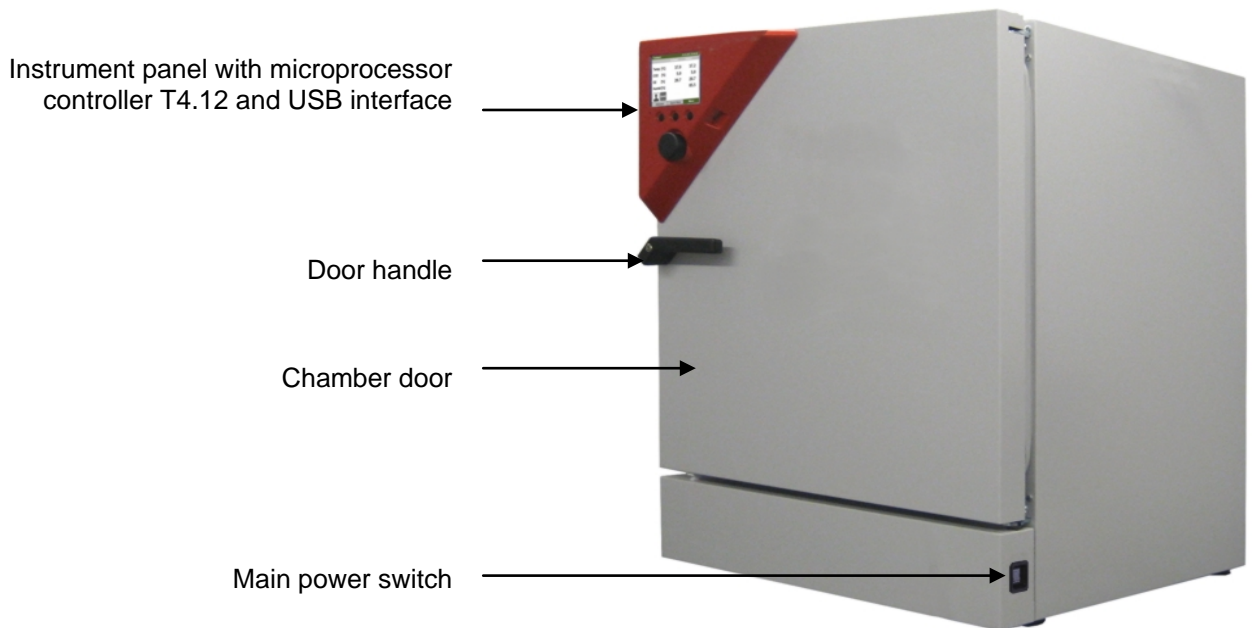

Figure 3: CO₂ incubator CB (example: model CB 160)

2.2 Instrument panel

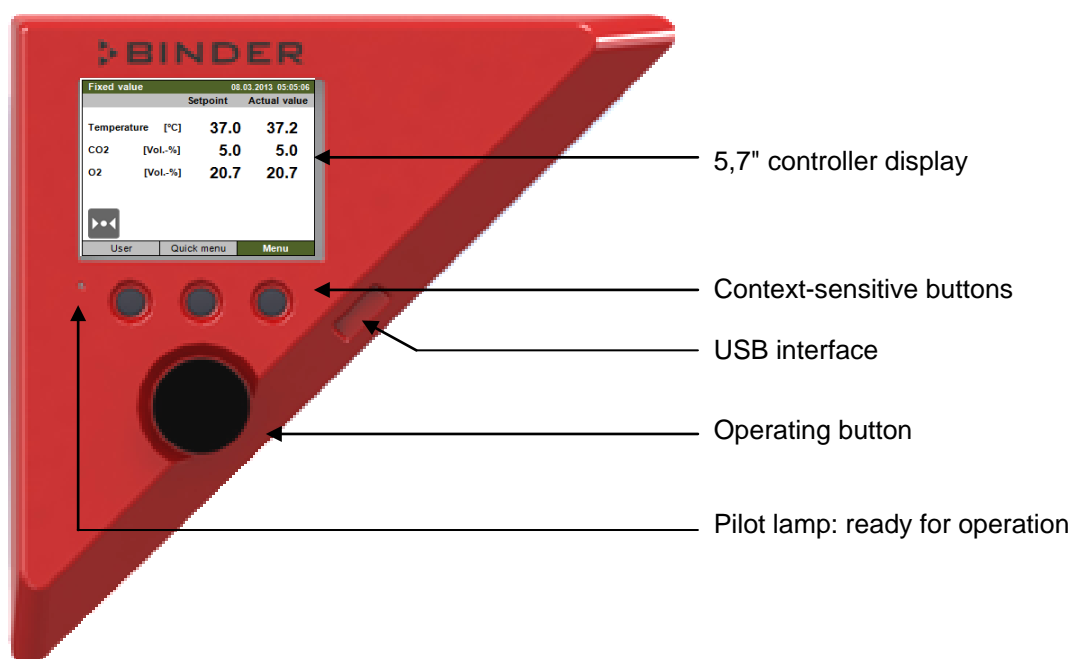

Figure 4: Instrument panel with microprocessor controller T4.12 and USB interface

2.3 Inner chamber

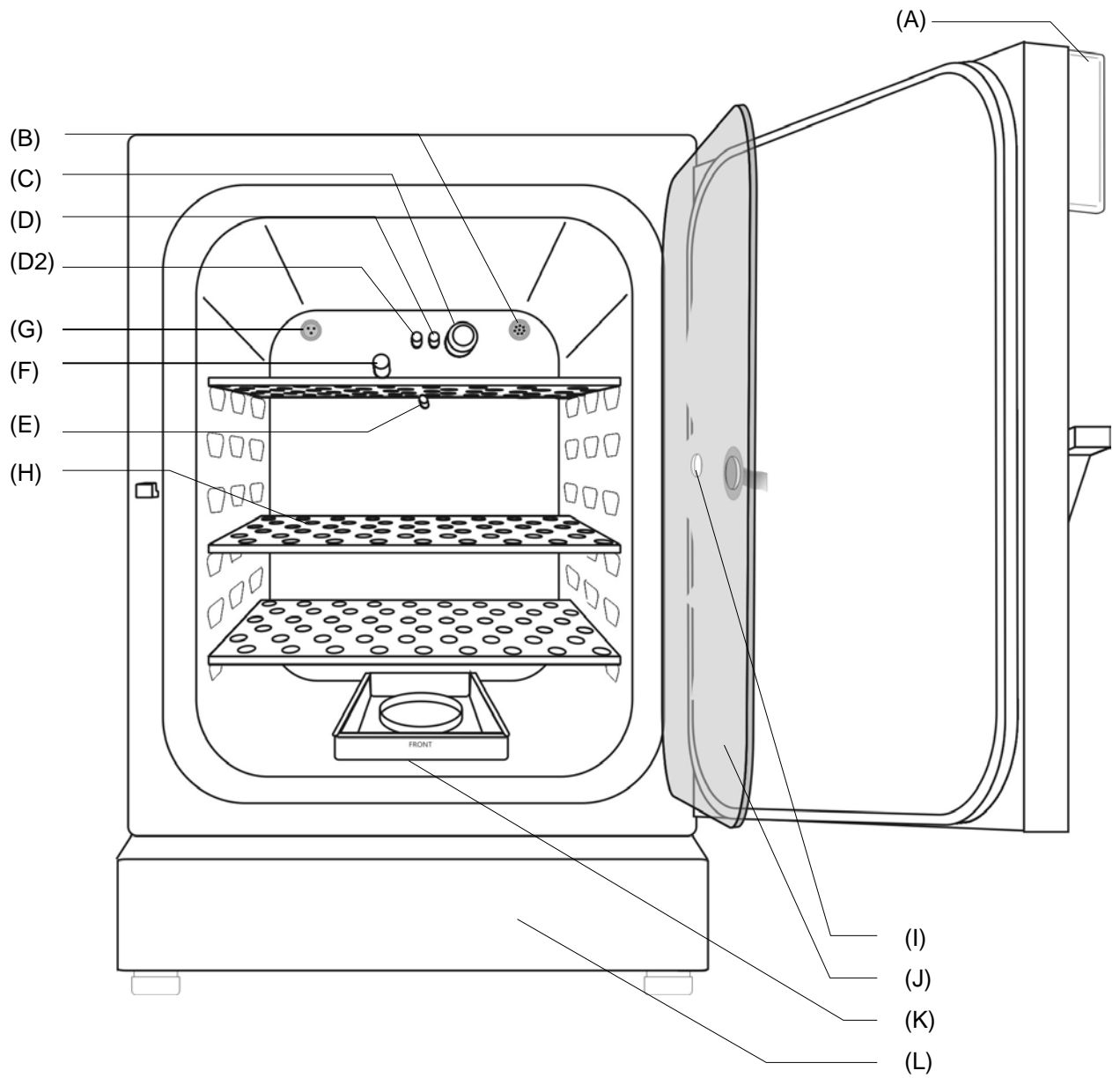

Figure 5: CB 160 with O₂ control and options

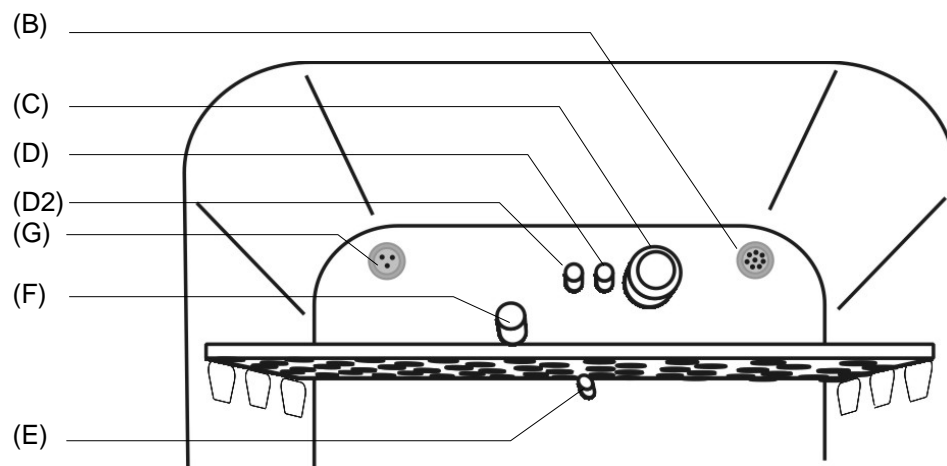

Figure 6: CB 160 / CB 220 with O₂ control and options

- (A) Instrument panel with microprocessor controller T4.12, indicating temperature and CO₂ as well as O₂ (chamber with O₂ control)"
- (B) Connection socket for extra-low voltage supply (option, chap. 15.6)
- (C) CO₂ sensor
- (D) Gas mixing head CO₂
- (D2) Additional gas mixing head O₂/ N₂ (chamber with O₂ control)
- (E) Pt 100 temperature probe
- (F) O₂ sensor (chamber with O₂ control)
- (G) Internal socket 230V (max. 3 A) (option, chap. 15.4)
- (H) Perforated shelves, made of stainless steel
- (I) Measuring access port
- (J) Inner glass doors
- (K) Permady™ water pans
- (L) Lower housing cover

2.4 Control panel on the rear of the chamber

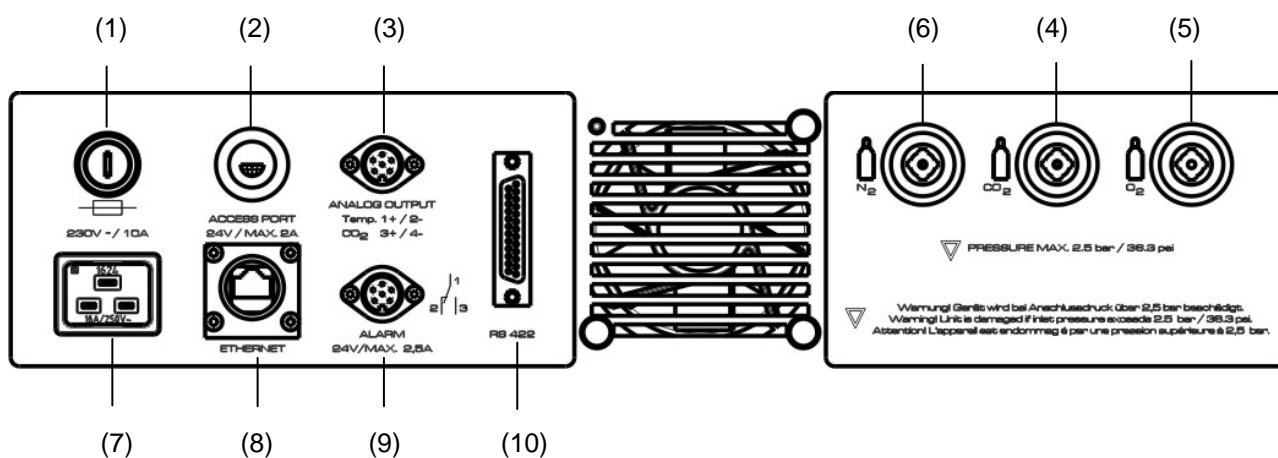

Figure 7: Rear control panel CB with O₂ control and options

- (1) Miniature fuse
- (2) External socket for extra-low voltage supply (option for CB 160 / CB 220, chap. 15.6)
- (3) DIN socket for analog outputs 4-20 mA (option, chap. 15.5)
- (4) Quick acting closure socket for CO₂
- (5) Quick acting closure socket for O₂ (chamber with O₂ control and optional alternative control range 10 up to 95 vol.-% O₂)
- (6) Quick acting closure socket for N₂ (chamber with O₂ control)
- (7) Socket for IEC connector plug for power cable
- (8) Ethernet interface for computer communication
- (9) DIN-socket for zero-voltage relay alarm outputs
- (10) RS 422 interface for computer communication (option)

3. Completeness of delivery, transportation, storage, and installation





3.1 Unpacking, and checking equipment and completeness of delivery

After unpacking, please check the chamber and its optional accessories, if any, based on the delivery receipt for completeness and for transportation damage. Inform the carrier immediately if transportation damage has occurred.

The final tests of the manufacturer may have caused traces of the shelves on the inner surfaces. This has no impact on the function and performance of the chamber.

Please remove any transportation protection devices and adhesives in/on the chamber and on the doors and remove the operating manuals and accessory equipment.

	Remove any protective lamination sheet on the inner metal surfaces prior to commissioning.
---	--

	<table border="1"> <tr> <td data-bbox="395 779 842 853" style="background-color: yellow;">  CAUTION </td> <td data-bbox="849 779 1471 853"></td> </tr> <tr> <td data-bbox="395 862 842 896"> Sliding or tilting of the chamber. </td> <td data-bbox="849 862 1471 896"></td> </tr> <tr> <td data-bbox="395 904 842 938"> Damage to the chamber. </td> <td data-bbox="849 904 1471 938"></td> </tr> <tr> <td data-bbox="395 947 842 981"> Risk of injury by lifting heavy loads. </td> <td data-bbox="849 947 1471 981"></td> </tr> <tr> <td data-bbox="395 990 842 1023"> <ul style="list-style-type: none"> ➤ Do NOT lift or transport the chamber using the door handle, the door or the lower housing. </td> <td data-bbox="849 990 1471 1023"></td> </tr> <tr> <td data-bbox="395 1032 842 1066"> <ul style="list-style-type: none"> ➤ Lift the chamber from the pallet at the four lower corners with the aid of four people. </td> <td data-bbox="849 1032 1471 1066"></td> </tr> </table>	 CAUTION		Sliding or tilting of the chamber.		Damage to the chamber.		Risk of injury by lifting heavy loads.		<ul style="list-style-type: none"> ➤ Do NOT lift or transport the chamber using the door handle, the door or the lower housing. 		<ul style="list-style-type: none"> ➤ Lift the chamber from the pallet at the four lower corners with the aid of four people. 	
 CAUTION													
Sliding or tilting of the chamber.													
Damage to the chamber.													
Risk of injury by lifting heavy loads.													
<ul style="list-style-type: none"> ➤ Do NOT lift or transport the chamber using the door handle, the door or the lower housing. 													
<ul style="list-style-type: none"> ➤ Lift the chamber from the pallet at the four lower corners with the aid of four people. 													

If you need to return the chamber, please use the original packing and observe the guidelines for safe lifting and transportation (chap. 3.2).

For disposal of the transport packing, see chap. 20.1.





Note on second-hand chambers (Ex-Demo-Units):

Second-hand chambers are chambers that were used for a short time for tests or exhibitions. They are thoroughly tested before resale. BINDER ensures that the chamber is technically sound and will work flawlessly.

Second-hand chambers are marked with a sticker on the chamber door. Please remove the sticker before commissioning the chamber.

3.2 Guidelines for safe lifting and transportation

After operation, please observe the guidelines for temporary decommissioning (chap. 20.2). Empty the Permady™ water pan before moving the chamber. In case of any spilling of the contents, shut down the chamber and dry it out carefully and completely.

	<table border="1"> <tr> <th colspan="2" style="background-color: yellow; text-align: center;">  CAUTION </th> </tr> <tr> <td colspan="2"> <p>Sliding or tilting of the chamber. Damage to the chamber. Risk of injury by lifting heavy loads.</p> <ul style="list-style-type: none"> ➤ Transport the chamber in its original packaging only. ➤ For moving or shipping, secure the chamber with transport straps. ⊘ Do NOT lift or transport the chamber using the door handle, the door or the lower housing. ➤ Lift the chamber at the four lower corners with the aid of 4 people and place it on a rolling pallet. ➤ Move the chamber to the desired location and lift it from the rolling pallet with the aid of four people. </td> </tr> </table>	 CAUTION		<p>Sliding or tilting of the chamber. Damage to the chamber. Risk of injury by lifting heavy loads.</p> <ul style="list-style-type: none"> ➤ Transport the chamber in its original packaging only. ➤ For moving or shipping, secure the chamber with transport straps. ⊘ Do NOT lift or transport the chamber using the door handle, the door or the lower housing. ➤ Lift the chamber at the four lower corners with the aid of 4 people and place it on a rolling pallet. ➤ Move the chamber to the desired location and lift it from the rolling pallet with the aid of four people. 	
 CAUTION					
<p>Sliding or tilting of the chamber. Damage to the chamber. Risk of injury by lifting heavy loads.</p> <ul style="list-style-type: none"> ➤ Transport the chamber in its original packaging only. ➤ For moving or shipping, secure the chamber with transport straps. ⊘ Do NOT lift or transport the chamber using the door handle, the door or the lower housing. ➤ Lift the chamber at the four lower corners with the aid of 4 people and place it on a rolling pallet. ➤ Move the chamber to the desired location and lift it from the rolling pallet with the aid of four people. 					

- Permissible ambient temperature range during transport: 10 °C / 14 °F to +60 °C / 140 °F.

You can order transport packing for moving or shipping purposes from BINDER service.

3.3 Storage

Intermediate storage of the chamber is possible in a closed and dry room. Observe the guidelines for temporary decommissioning (chap. 20.2).

- Permissible ambient temperature range during storage: -10 °C / 14 °F to +60 °C / 140 °F.
- Permissible ambient humidity: max. 70 % r.H., non-condensing

When after storage in a cold location you transfer the chamber to its warmer installation site, condensation may form. Before start-up, wait at least one hour until the chamber has attained ambient temperature and is completely dry.

3.4 Location of installation and ambient conditions

Notes on the location of installation

Set up the chamber on a flat, even surface, free from vibration and in a well-ventilated, dry location. The chambers are designed for setting up inside a building (indoor use).

Freestanding chamber are suitable for installation on tables or on the optionally available stand (height 200 mm / 0.5 ft). Note: The site of installation must be capable of supporting the chamber's weight (see technical data, chap.22.4).

Align the chamber using a spirit level to ensure even covering of the cell-cultures with the medium. For this purpose, manually adjust the four chamber feet.

The chambers can be stacked on top of each other (two chambers maximum). For safe stacking that is easy to maintain, use the original BINDER stacking stand (chap. 15.8.1) or the stacking adapter (chap. 15.8.2).

	<table border="1"> <tr> <th colspan="2" style="background-color: yellow; text-align: center;"> CAUTION </th> </tr> <tr> <td colspan="2"> <p>Sliding of stacked chamber. Damage to the chambers.</p> <ul style="list-style-type: none"> ➤ When stacking, use rubber pads (Art. No. 8012-0376) for the feet of the upper chamber. </td> </tr> </table>	CAUTION		<p>Sliding of stacked chamber. Damage to the chambers.</p> <ul style="list-style-type: none"> ➤ When stacking, use rubber pads (Art. No. 8012-0376) for the feet of the upper chamber. 	
CAUTION					
<p>Sliding of stacked chamber. Damage to the chambers.</p> <ul style="list-style-type: none"> ➤ When stacking, use rubber pads (Art. No. 8012-0376) for the feet of the upper chamber. 					



To completely separate the chamber from the power supply, you must disconnect the power plug. Install the chamber in a way that the power plug is easily accessible and can be easily pulled in case of danger.

For the user there is no risk of temporary overvoltages in the sense of EN 61010-1:2010.

In order to avoid contamination, never place the chamber directly on the floor.

	CAUTION
	<p>Danger of overheating. Damage to the chamber.</p> <ul style="list-style-type: none"> ⊘ Do NOT set up chambers in non-ventilated recesses. ➤ Ensure sufficient ventilation for dispersal of the heat.

Do not install or operate the chamber in potentially explosive areas.

	 DANGER
	<p>Explosion hazard. Danger of death.</p> <ul style="list-style-type: none"> ⊘ Do NOT operate the chamber in potentially explosive areas. ➤ KEEP explosive dust or air-solvent mixtures AWAY from the vicinity of the chamber.

Ambient conditions

- Permissible ambient temperature range for operation: +18 °C / 64.4 °F to +30 °C / 86 °F
 At elevated ambient temperature values, fluctuations in temperature can occur.
- Ideal ambient temperature: at least 7 °C / 12.6 °F below the intended working temperature. E.g., working temperature 37 °C / 98.6 °F = ambient temperature 30 °C / 86 °F and lower. In the event of working temperatures of less than 7 °C / 12.6 °F above the ambient temperature, the setpoint can be exceeded.



	<p>The ambient temperature should not be substantially higher than the indicated ambient temperature of 22 ±3 °C / 71.6 ±5.4 °F to which the specified technical data relates. For other ambient conditions, deviations from the indicated data are possible.</p>
---	---

	<p>Avoid direct solar radiation on the chamber.</p>
---	---

- Permissible ambient humidity: 70 % r.H. max., non-condensing.
- Installation height: max. 2000 m / 6561.7 ft above sea level.
- Wall distances: rear 100 mm / 3.94 in, sides 50 mm / 1.97 in.

Notes on handling carbon dioxide (CO₂)

Carbon dioxide (CO₂) in high concentrations is hazardous to health. It is colorless and almost odorless and therefore practically imperceptible. Vent out any CO₂ gas that may escape via good room ventilation or a suitable connection to an exhaust system. We recommend installing a CO₂ warning system.

	 WARNING
	<p>High concentration of CO₂ (> 4 Vol.-%). Danger of death by suffocation. Danger of poisoning.</p> <ul style="list-style-type: none"> ⊘ Do NOT set up chambers in non-ventilated recesses. ➤ Ensure technical ventilation measures. ➤ Observe the relevant regulations for handling CO₂.

Observe the **occupational exposure limit OEL** for CO₂ set by the national authorities (formerly maximum permitted workplace concentration). Check compliance when operating all chambers located in the room.

- OEL for Germany: 5000 ml/m³ (ppm) = 0,5 Vol.-%
- CO₂ lost with each opening the door: about 16.4 g, i.e. 0.0084 cubic meters / 0.296 cubic feet (under normal pressure)
- CO₂ lost during 12h at 5 vol.-% without opening the door: approx. < 2 g, i.e. 0.001 cubic meter / 0.035 cubic feet (under normal pressure 1013 mbar / 14.7 psi)

An example of how to evaluate laboratory volume and air change rate:

Question: Is an air change rate of 1/h sufficient for a lab with a volume of 100 cubic meters / 3,531.5 cubic feet with 10 incubators CB, opened 4 times per hour?

Calculation: CO₂ concentration = CO₂ lost by opening the door, multiplied by 10 chambers, multiplied by opening the door 4 times per hour, divided by lab volume

0.0084 cubic meters x 10 x 4 div. 100 cubic meters = 0.00336, i.e. 0.336 % or 3360 ppm.



0.296 cubic feet x 10 x 4 div. 3,531.5 cubic feet = 0.00336, i.e. 0.336 % or 3360 ppm.

Result: The maximum permissible value of 5000 ppm is not exceeded under these operation conditions.

Even when CO₂ or systems operated with CO₂ are handled carefully and appropriately, a residual risk remains, which can lead to life-threatening situations under certain circumstances. Therefore we strongly recommend continuous monitoring of CO₂ concentration in the ambient air of the CO₂ incubator. It must be ensured permanently that the maximum permissible occupational exposure limit OEL for CO₂ (0.5 vol - % CO₂ for Germany) is not exceeded.

Chamber with O₂ control: Notes on handling oxygen (O₂)

Oxygen (O₂) is colorless and almost odorless and therefore practically imperceptible. It promotes burns, which can proceed explosively. There is a fire hazard for flammable oxygenated materials, e.g. clothes and hair. O₂ is heavier than air and may accumulate in low-lying areas.



 	 WARNING
	<p>High concentration of O₂ (> 21 % O₂). Fire and explosion hazard through contact of combustible materials with O₂. Risk of burns and other injuries.</p> <ul style="list-style-type: none"> ⊘ Do NOT set up chambers in non-ventilated recesses. ➤ Ensure technical ventilation measures. ➤ Observe the relevant regulations for handling O₂.

Take appropriate measures to prevent oxygen enrichment and fire and explosion hazards in areas where oxygen enrichment is possible.

	<p>General information for safe handling of oxygen:</p> <ul style="list-style-type: none"> • Make sure training of personnel on hazards of oxygen enrichment and necessary safety measures. • Make sure adequate labeling of all oxygen equipment and facilities. • Make sure gas tightness of all gas connections by checking them for leaks (e.g. with leak spray or diluted soap solution). • Close the main valve of the source of oxygen after work when not using the chamber. • Never lubricate O₂ equipment with oil or fat. Use only materials and spare parts which are approved for use with oxygen. • Regularly inspect fire extinguishers for proper condition. • Set up emergency showers where oxygen enrichment is possible. • Strictest smoking ban and no ignition sources in areas where oxygen enrichment is possible. • Make sure good ventilation of areas where oxygen enrichment is possible (location of the chamber and/or O₂ cylinders). • Persons who may have been in a possibly oxygen-enriched atmosphere must keep away from ignition sources (flames, cigarettes, etc.) and ventilate their clothes at least 15 minutes. • Always keep emergency routes free.
---	---

Chamber with O₂ control: Notes on handling nitrogen (N₂)

Nitrogen (N₂) in high concentrations is hazardous to health. It is colorless and almost odorless and therefore practically imperceptible. Any N₂ gas that may escape must be safely led out via good room ventilation or a suitable connection to an exhaust system.

	 WARNING
	<p>High concentration of N₂. Risk of death by suffocation.</p> <ul style="list-style-type: none"> ⊘ Do NOT set up chambers in non-ventilated recesses. ➤ Ensure technical ventilation measures. ➤ Observe the relevant regulations for handling N₂.

4. Installation and connections

4.1 Shelves

You can put the shelves in different positions at the line of channel beads in the inner chamber. Hold the shelf straight and then insert it so it will go smoothly inside the chamber.

Permitted shelf loads:

Maximum load of one single shelf: 10 kg / 22 lb
 Maximum total load of all shelves: 30 kg / 66 lb

4.2 Permady™ water pan

The Permady™ system developed by BINDER is an effective and easy to handle system that ensures high humidity inside the chamber without any condensation forming on the inner surfaces. The Permady™ water pan consists of two pans in which the outer one is heated and the inner one cooled. With the slight difference of temperature caused by that cooling, the central pan is the specific point for condensation of the surplus humidity. Therefore, all other inner surfaces remain dry.



CB 60



CB 160 / CB 220

Figure 8: Permady™ water pan

- Put the Permady™ water pan on the bottom of the inner chamber in a way that both notches lock into place.
- The front side of the Permady™ water pan is marked "FRONT".



Figure 9: Letters "FRONT" indicating the front of the Permady™ water pan

- Please make sure that the Permady™ water pan has firm contact to the inner chamber bottom and rests tightly on it.
- Fill only the outer pan with distilled, sterilized water up to the filling level marking on the edge of the inner pan.

Maximum filling quantity of the outer pan: CB 60: approx. 0.7 liters, CB 160 and CB220): approx. 2 liters.



Figure 10: Filling height line of the outer basin CB 160 / CB 220

- We recommend cleaning and refilling the pans 2 to 3 times a week. For evacuation, remove the Permadyr™ water pan.
- We recommend using distilled, sterile water to achieve optimum growth results. Any corrosive damage that may arise following the use of water of different quality or by additives is excluded from the liability agreement.
- If required, you can add microbiologically inhibiting substances such as copper chips, copper sulfate or ethylene diamine tetra-vinegar acid (EDTA) in a concentration of 1 to 5 mmol/l.

Empty the Permadyr™ water pan before moving the chamber. In case of the contents spilling, immediately shut down the chamber and dry it carefully and completely.

4.3 Connecting the O₂ sensor (chamber with O₂ control)

The O₂ sensor is supplied with the chamber in a separate package.



Connect or remove the O₂ sensor only when the chamber is turned off.

Open the door of the inner chamber and plug the O₂ sensor (F) into the left connection socket located in the upper part of the rear of the inner chamber. Pay attention to the correct positioning of the pins.



Figure 11: O₂ sensor

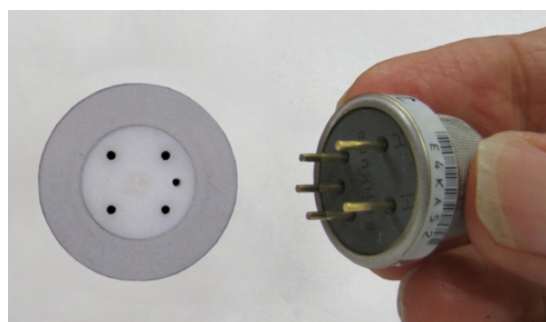



Figure 12: Connecting the O₂ sensor





The O₂ sensor must be plugged in during a hot-air sterilization.



4.4 Gas connections

	<p>General information for safe handling of gas cylinders:</p> <ul style="list-style-type: none"> • Store and use gas cylinders only in well ventilated areas. • Open the gas cylinder valve slowly to avoid pressure surges. • Secure gas cylinders during storage and use against falling (chaining). • Transport gas cylinders with a cylinder cart, do not carry, roll, or throw them. • Always close the valve even with apparently empty cylinders; screw on the cap when not in use. Return gas cylinders with the valve closed. • Do not open gas cylinders by force. Mark them when damaged. • Protect gas cylinders against fire, e.g. do not store together with flammable liquids. • Observe relevant regulations for dealing with gas cylinders.
---	---

Secure the gas cylinder against falling and other mechanical damage.

	 WARNING
	<p>Safety valve tearing off. Sudden release of the stored pressure energy. Risk of injury.</p> <ul style="list-style-type: none"> ➤ Secure gas cylinders against falling (chaining). ➤ Transport gas cylinders with a cylinder cart.



The valve of the gas cylinder **always** must be closed before screwing on or unscrewing the gas hose.

	 WARNING
	<p>Opening the cylinder valve when the cylinder is not connected. Sudden release of the stored pressure energy. Risk of injury.</p> <ul style="list-style-type: none"> ➤ Close the gas cylinder valve before connecting or removing the gas hose.

	<p>After connecting the gas cylinder, check all gas connections for leaks (e.g. with leak spray or diluted soap solution).</p>
---	--

4.4.1 Connection of the CO₂ gas cylinder

Carbon dioxide (CO₂) in high concentrations is hazardous to health. It is colorless and almost odorless and therefore practically imperceptible. Vent out any CO₂ gas that may escape via good room ventilation or a suitable connection to an exhaust system. We recommend installing a CO₂ warning system.

	 WARNING
	<p>High concentration of CO₂ (> 4 Vol.-%). Risk of death by suffocation. Danger of poisoning.</p> <ul style="list-style-type: none"> ⊘ Do NOT set up chambers in non-ventilated recesses. ➤ Ensure technical ventilation measures. ➤ Observe the relevant regulations for handling CO₂.

	The CO ₂ gas necessary for operation must have a technical grade of 99.5 %.
---	--

	The gas connections must be established by qualified personnel who are trained in handling the respective gases and familiar with the required safety measures.
---	---

The following steps are required:

Ensuring the correct CO₂ output pressure

	A gas supply pressure above 2.5 bar / 36 psi will result in chamber damage.
---	---

Use a pressure reducer and make sure to avoid any excessive outlet pressure when connecting the gas hose to the chamber.

The real outlet pressure of gas cylinders, sets of gas cylinders or central gas supplies am on the second manometer must **not** exceed 2.5 bar / 36 psi.

	CAUTION
	<p>Excessive outlet pressure > 2.5 bar / 36 psi. Damage to the chamber.</p> <ul style="list-style-type: none"> ⊘ The outlet pressure must NOT exceed the indicated value of 2.5 bar / 36 psi. ➤ Before connecting, check the outlet pressure on the pressure reducer of the cylinder. ➤ Adjust the outlet pressure to 2.0 bar / 29 psi above the ambient pressure.

Observe the correct outlet pressure also when replacing the gas cylinders.

Establishing the connection to the chamber

Connect the supplied gas hose (internal diameter 6 mm / 0.24 inches) to the pressure reducer of the gas cylinders or central gas supply and secure the connection with the supplied hose clamp.

Connect the pre-assembled hose nozzle of the gas hose to the quick acting closure socket (4) DN 6 on the chamber rear, as described in chap. 4.4.4.

Leak test

After connecting the gas cylinder, check all gas connections for leaks (e.g. with leak spray or diluted soap solution).



	The recovery times of the gas concentrations inside the chamber after opening the door are indicated in the technical data (chap. 22.4) and refer to a connection pressure of 2.0 bar / 29 <i>psi</i> . Decreasing supply pressure will result in longer recovery times.
---	--

Conversion table for gas inlet pressures, bar – psi, see chap. 22.8.

4.4.2 Connection of the O₂ gas cylinder (chamber with O₂ control and optional alternative control range 10 up to 95 vol.-% O₂)

	Note: Do not connect the O ₂ cylinder or disconnect the gas supply (by pulling off the gas hose) when operating at setpoints below 19 vol.-% O ₂ .
---	--

Oxygen (O₂) is colorless and almost odorless and therefore practically imperceptible. It promotes burns, which can proceed explosively. There is a fire hazard for flammable oxygenated materials, e.g. clothes and hair. O₂ is heavier than air and may accumulate in low-lying areas.

	 WARNUNG
	<p>High concentration of O₂ (> 21 % O₂). Fire and explosion hazard through contact of combustible materials with O₂. Risk of burns and other injuries.</p> <ul style="list-style-type: none"> ∅ Do NOT set up chambers in non-ventilated recesses. ➤ Ensure technical ventilation measures. ➤ Observe the relevant regulations for handling O₂.

	The O ₂ gas necessary for operation must have a technical grade of 99.5 %.
---	---

	The gas connections must be established by qualified personnel who are trained in handling the respective gases and familiar with the required safety measures.
---	---

The following steps are required:

Ensuring the correct O₂ output pressure

	A gas supply pressure above 2.5 bar / 36 <i>psi</i> will result in chamber damage.
---	--

Use a pressure reducer and make sure to avoid any excessive outlet pressure when connecting the gas hose to the chamber.

The real outlet pressure of gas cylinders, sets of gas cylinders or central gas supplies am on the second manometer must **not** exceed 2.5 bar / 36 *psi*.

	CAUTION
	<p>Excessive outlet pressure > 2.5 bar / 36 <i>psi</i>. Damage to the chamber.</p> <ul style="list-style-type: none"> ∅ The outlet pressure must NOT exceed the indicated value of 2.5 bar / 36 <i>psi</i>. ➤ Before connecting, check the outlet pressure on the pressure reducer of the cylinder. ➤ Adjust the outlet pressure to 2.0 bar / 29 <i>psi</i> above the ambient pressure.

Observe the correct outlet pressure also when replacing the gas cylinders.

Establishing the connection to the chamber

Connect the supplied gas hose (internal diameter 6 mm / 0.24 inches) to the pressure reducer of the gas cylinders or central gas supply and secure the connection with the supplied hose clamp.

Connect the pre-assembled hose nozzle of the gas hose to the quick acting closure socket (5) DN 6 on the chamber rear, as described in chap. 4.4.4.

Leak test



After connecting the gas cylinder, check all gas connections for leaks (e.g. with leak spray or diluted soap solution).

	<p>The recovery times of the gas concentrations inside the chamber after opening the door are indicated in the technical data (chap. 22.4) and refer to a connection pressure of 2.0 bar / 29 psi. Decreasing supply pressure will result in longer recovery times.</p>
---	---

Conversion table for gas inlet pressures, bar – psi, see chap. 22.8.

4.4.3 Connection of the N₂ gas cylinder (chamber with O₂ control)

Nitrogen (N₂) in high concentrations is hazardous to health. It is colorless and almost odorless and therefore practically imperceptible. Any N₂ gas that may escape must be safely led out via good room ventilation or a suitable connection to an exhaust system.

	<div style="background-color: orange; padding: 5px; text-align: center;">  WARNING </div> <p>High concentration of N₂. Risk of death by suffocation.</p> <ul style="list-style-type: none"> ⊘ Do NOT set up chambers in non-ventilated recesses. ➤ Ensure technical ventilation measures. ➤ Observe the relevant regulations for handling N₂.
--	--

	<p>The N₂ gas necessary for operation must have a technical grade of 99.5 %.</p>
---	---

	<p>The gas connections must be established by qualified personnel who are trained in handling the respective gases and familiar with the required safety measures.</p>
---	--

The following steps are required:

Ensuring the correct N₂ output pressure

	<p>A gas supply pressure above 2.5 bar / 36 psi will result in chamber damage.</p>
---	--

Use a pressure reducer and make sure to avoid any excessive outlet pressure when connecting the gas hose to the chamber.

The real outlet pressure of gas cylinders, sets of gas cylinders or central gas supplies am on the second manometer must **not** exceed 2.5 bar / 36 psi.

	CAUTION
	<p>Excessive outlet pressure > 2.5 bar / 36 psi. Damage to the chamber.</p> <ul style="list-style-type: none"> ∅ The outlet pressure must NOT exceed the indicated value of 2.5 bar / 36 psi. ➤ Before connecting, check the outlet pressure on the pressure reducer of the cylinder. ➤ Adjust the outlet pressure to 2.0 bar / 29 psi above the ambient pressure.

Observe the correct outlet pressure also when replacing the gas cylinders.

Establishing the connection to the chamber

Connect the supplied gas hose (internal diameter 6 mm / 0.24 inches) to the pressure reducer of the gas cylinders or central gas supply and secure the connection with the supplied hose clamp.

Connect the pre-assembled hose nozzle of the gas hose to the quick acting closure socket (6) DN 6 on the chamber rear, as described in chap. 4.4.4.

Leak test

After connecting the gas cylinder, check all gas connections for leaks (e.g. with leak spray or diluted soap solution).

	<p>The recovery times of the gas concentrations inside the chamber after opening the door are indicated in the technical data (chap. 22.4) and refer to a connection pressure of 2.0 bar / 29 psi. Decreasing supply pressure will result in longer recovery times.</p>
---	---

Conversion table for gas inlet pressures, bar – psi, see chap. 22.8.

4.4.4 Connecting the gas hose to the chamber rear (for CO₂, O₂, N₂)

The procedure of connecting the gas hose to the chamber rear is the same for any gas connection. All quick acting closure sockets (CO₂, N₂ on chamber with O₂ control, and O₂ on chamber with O₂ control and optional alternative control range 10 up to 95 vol.-% O₂) are degreased and supplied with a FKM gasket.

Note for chambers with O₂ control: The quick acting closure socket and the hose nozzle for the O₂ connection (chamber with O₂ control) must be degreased.

	WARNING
	<p>Fire and explosion hazard through contact of fat with O₂. Risk of burns and other injuries.</p> <ul style="list-style-type: none"> ∅ All connection parts for the O₂ connection must be degreased.

The gas hose, which will be used to establish the connection to a gas cylinder, is already attached to the hose nozzle and secured by a hose clamp. Plug the hose nozzle into the corresponding quick acting closure socket (a) located at the rear of the chamber. This quick acting closure socket is closed by a rubber cover (b).

	<p>Only use the supplied hose nozzle to connect to the quick acting closure socket. Otherwise, the quick acting closure socket may leak, and/or it may become impossible to connect the original hose nozzle. In this case, please contact BINDER Service.</p>
---	--

Remove the rubber cover (b) by pulling it off.

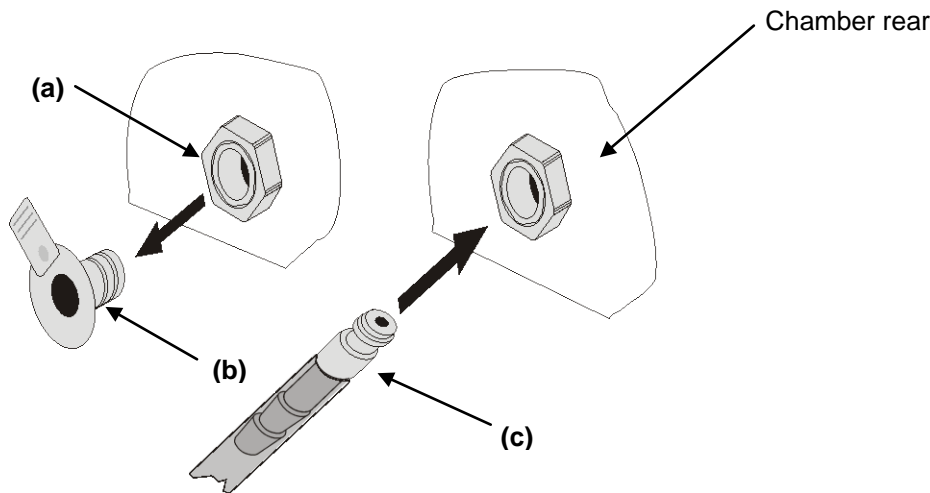
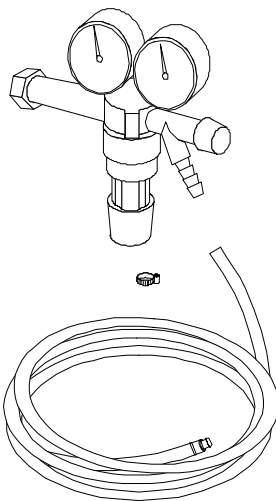

Figure 13: Connecting the hose lead to the gas cylinder

Now fit the hose nozzle (c) in the quick acting closure socket. To remove the connection, pull the hose nozzle off the quick acting closure socket.

4.4.5 Gas cylinder connection kits (option)



Gas cylinder connection kits are available for CO₂ (Art. No. 8012-0014), O₂ (Art. No. 8012-0015) and N₂ (Art. No. 8012-0016).

The connection kit includes the following parts for connecting a gas cylinder to the CO₂ incubator:

- Pressure reducer with manometers for cylinder pressure (high pressure gauge) and outlet pressure (low pressure gauge)
- 5 m pressure hose with pre-assembled hose nozzle for quick acting closure socket
- 1 hose clamp to connect the gas hose to the pressure reducer

Figure 14: Gas cylinder connection kit

	<p>Instructions 7001-0249 included with the connection kit describe connecting and setting the gas cylinder connection kit.</p>
--	---

	<h3>CAUTION</h3>
	<p>Excessive outlet pressure > 2.5 bar / 36 psi. Damage to the chamber.</p> <ul style="list-style-type: none"> ∅ The outlet pressure must NOT exceed the indicated value of 2.5 bar / 36 psi. ➤ Before connecting, check the outlet pressure on the pressure reducer of the cylinder. ➤ Adjust the outlet pressure to 2.0 bar / 29 psi above the ambient pressure.

	<p>The gas connections must be established by qualified personnel who are trained in handling the respective gases and familiar with the required safety measures.</p>
--	--

4.5 Electrical connection

The chambers are supplied ready for connection. They come with an IEC connector plug.

Model (including chambers with O ₂ control and/or divided inner door)	Art. No. (x = 0 or 1)	Power plug	Voltage +/-10 %	Power frequency	Chamber fuse
CB 60	9x40-0088 9x40-0090	Shock-proof plug	200-240 V (1N~)	50/60 Hz	10 A
CB 60-UL	9x40-0089 9x40-0091	NEMA 5-15P	100-120 V (1N~)	50/60 Hz	16 A
CB 160	9x40-0092 9x40-0100 9x40-0094 9x40-0102	Shock-proof plug	200-240 V (1N~)	50/60 Hz	10 A
CB 160-UL	9x40-0093 9x40-0101 9x40-0095 9x40-0103	NEMA 5-20P	100-120 V (1N~)	50/60 Hz	16 A
CB 220	9x40-0096 9x40-0108 9x40-0098 9x40-0110	Shock-proof plug	200-240 V (1N~)	50/60 Hz	10 A
CB 220-UL	9x40-0097 9x40-0109 9x40-0099 9x40-0111	NEMA 5-20P	100-120 V (1N~)	50/60 Hz	16 A

- The domestic socket must also provide a protective conductor. Make sure that the connection of the protective conductor of the domestic installations to the chamber's protective conductor meets the latest technology. The protective conductors of the socket and plug must be compatible!
- Prior to connection and start-up, check the power supply voltage. Compare the values to the specified data located on the chamber's type plate (left chamber side, bottom right-hand, see chap. 1.4). We recommend the use of a residual current circuit breaker.
- When connecting, please observe the regulations specified by the local electricity supply company as well as the VDE directives (for Germany).
- Pollution degree (acc. to IEC 61010-1): 2
- Over-voltage category (acc. to IEC 61010-1): II

	CAUTION
	<p>Danger of incorrect power supply voltage. Damage to the equipment.</p> <ul style="list-style-type: none"> ➤ Check the power supply voltage before connection and start-up. ➤ Compare the power supply voltage with the data indicated on the type plate.

See also electrical data (chap. 22.4).



To completely separate the chamber from the power supply, you must disconnect the power plug. Install the chamber in a way that the power plug is easily accessible and can be easily pulled in case of danger.

4.6 Handling and aligning the divided inner door, gas proof (optional equipment)

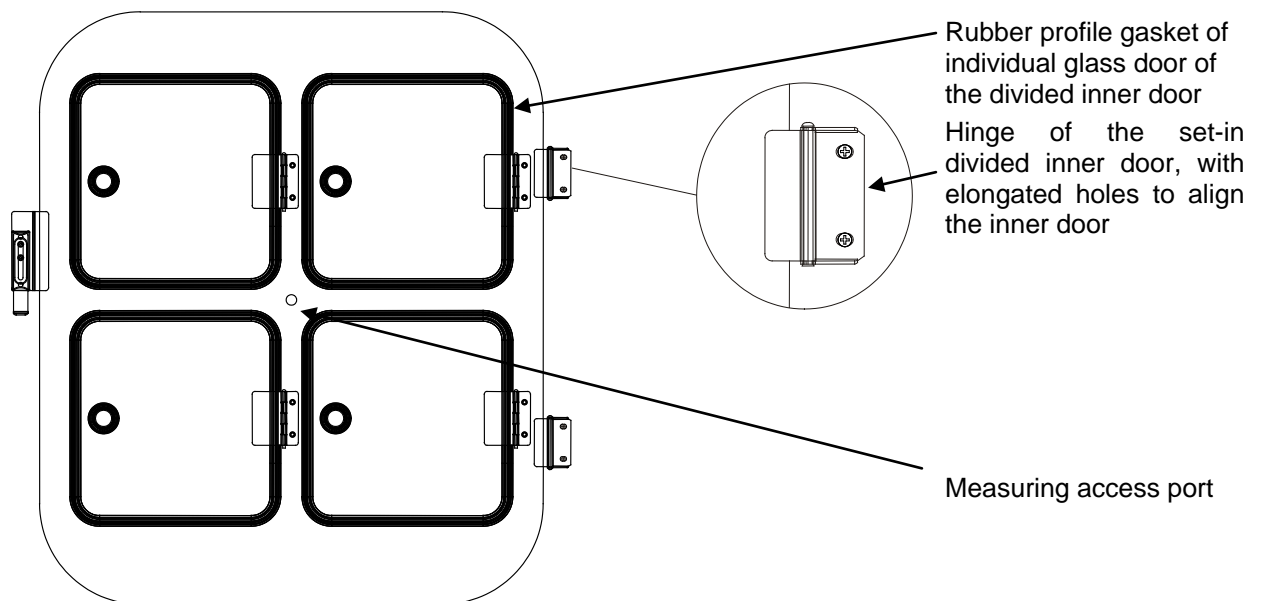

Figure 15: Divided inner door, gas proof, for CB 160

- Pull the handles to open each of the individual glass doors. Do not press too hard while closing them to avoid pushing the doors through the gasket into the inner chamber.
- The rubber profile gaskets of the individual glass doors are easy to replace.
- If the divided inner door is not in an aligned position, fasten the hinge screws in the elongated holes of the hinge to align it. Align the door and operate the locking smoothly.

5. Start up

After connecting the supply lines (chap. 4.5) turn on the chamber by the main power switch. The pilot lamp shows the chamber is ready for operation.



Observe a delay time of about 30s between turning Off and On again. Otherwise an initialization problem may occur.

Note that the chamber is in stand-by mode when the main power switch has been turned on and yet the controller display is dark. Turn on the chamber by pressing any controller button.

Warming chambers may release odors in the first few days after commissioning. This is not a quality defect. To reduce odors quickly we recommend heating up the chamber to its nominal temperature for one day and in a well-ventilated location.



WARNING: If customer should use a BINDER chamber running in non-supervised continuous operation, we strongly recommend in case of inclusion of irrecoverable specimen or samples to split such specimen or samples and store them in at least two chambers, if this is feasible.



After chamber startup this symbol and the message window “Power supply was interrupted.” appear in the controller display. Confirm with OK to close the window and make the icon disappear.

5.1 Equilibration time

Temperature: Equilibration time is approx. 1 hour.

CO₂: After approx. 5 minutes, the CO₂ concentration equilibrates automatically to the pre-set value of 5 vol.-% CO₂.

O₂ (chamber with O₂ control): After a delay of 10 minutes, the ambient oxygen concentration of approx. 20.7 vol.-% is displayed. During the first 10 minutes, O₂ control is not defined. Then O₂ is regulated to the displayed setpoint value of 20.7 vol.-%.

5.2 Factory settings

The chamber is supplied with the following basic preset parameters:

- Temperature setpoint 37 °C / 98.6°F
- CO₂ concentration 5 vol.-%
- O₂ concentration (chamber with O₂ control) 20.7 vol.-%
- Safety controller class 3.1 38.5 °C / 101.3°F
- Sterilization temperature 187.5 °C / 369.5°F
- Audible alarm signal (buzzer) turned on

The set temperature determines the target working temperature in the inner chamber, i.e. set value 37 °C / 98.6°F = target working temperature 37 °C / 98.6°F. The same is valid for the CO₂ and O₂ concentration (chamber with O₂ control). For the hot-air sterilization, the set value is 187.5 °C / 369.5°F and cannot be changed.



As long as there is a difference between the actual and set value shown in the display, adequate operation of the chamber is not guaranteed.

6. Functional overview of the T4.12 chamber controller

The T4.12 chamber controller controls the following values inside the chamber:

- Temperature in °C (range by 7 °C / 12.6 °F above ambient temperature up to +60 °C / 140 °F)
- Carbon dioxide concentration in vol.-% (range 0 vol.-% up to 20 vol.-%)

Chamber with O₂ control in addition:

- Oxygen concentration in vol.-% (range 0.2 vol.-% up to 95 vol.-%)

You can enter the desired setpoint values in fixed value operating mode in the display controller. The controller also offers various notifications and alarm messages with visual and audible indication, a trace file and remote alarms via e-mail. Programming can be done directly through the keypad of the controller or graphically through the software APT-COM™ 3 DataControlSystem (option, chap. 15.1) specially developed by BINDER.

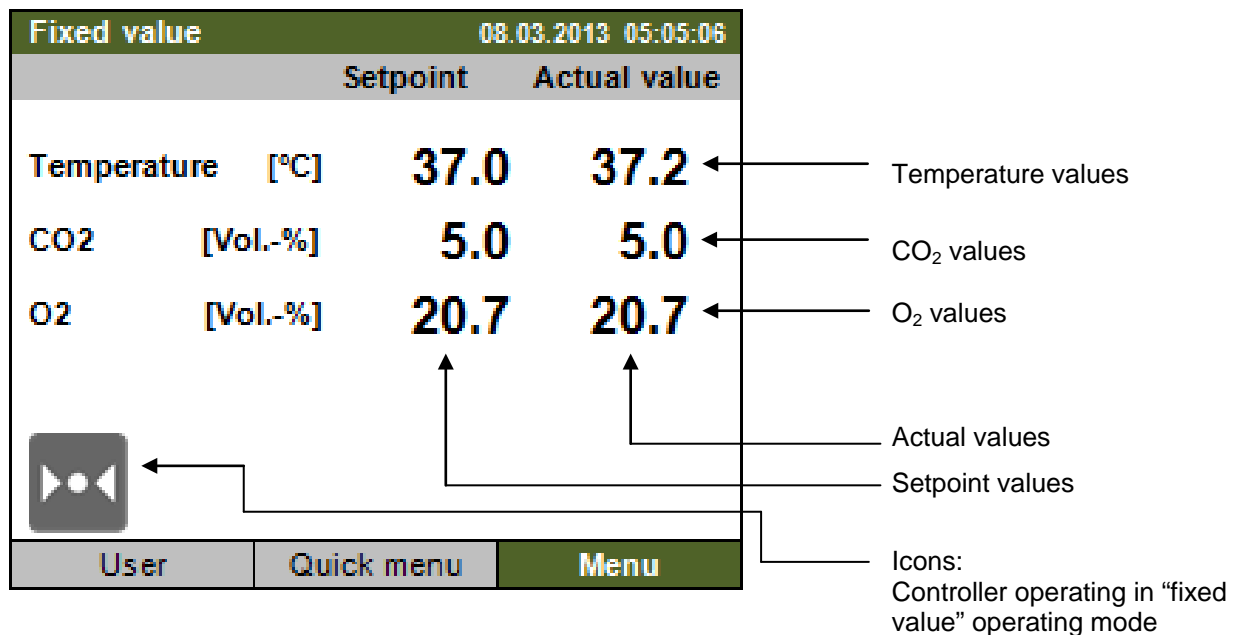



Figure 16: T4.12 microprocessor controller, initial view in "Fixed value" controller mode (sample values, chamber with O₂ control)

6.1 Menu structure

Fixed value		08.03.2013 05:05:06	
		Setpoint	Actual value
Temperature	[°C]	37.0	37.2
CO2	[Vol.-%]	5.0	5.0
O2	[Vol.-%]	20.7	20.7
			
User		Quick menu	Menu

Initial view (sample values, chamber with O₂ control).

Press the desired menu button.

From the Initial view you have access to different menus using the menu buttons "User", "Quick menu", or "Menu". From there you can access the desired control functions. To do this, select the function by turning the operating button and press the operating button to confirm the selection.

In any menu, you can return to the previous display pressing the "Close" button or to the initial view with the "Home" button.

Depending on the logged-in user or administrator, the available menu functions may vary. These instructions present the functions which are available to the logged-in administrator.

6.1.1 General menu

The general menu provides access to all setting functions of the controller, a graphical display of the measured values, and the possibility to read and give out data via the USB interface. In addition, supporting functions like a settings wizard or a contact page are available.

Fixed value		08.03.2013 05:05:06	
..\ Menu			
Controller mode			
Event list			
Alarms			
Setpoints			
Safety controller			
Import/Export			
Hot-air sterilization			
Humidity control			
			
Close		Home	

General menu

Turn the operating button to see additional menu items.

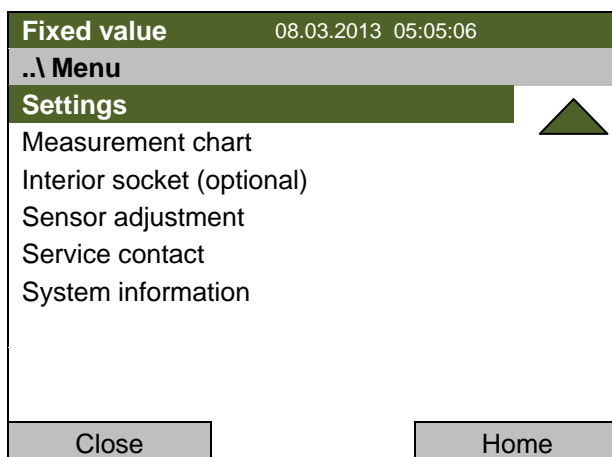

General menu (next page)

Controller mode	Switching between the operating modes "control off" or "fixed value", chap. 6.2.1
Event list	Display of status information and errors, chap. 12
Alarms	Alarm settings, chap. 11.5
Setpoints	Setpoint entry, chap. 7.4
Safety controller	Setting the safety controller, chap. 14.2
Import/Export	Data transfer via USB interface, chap. 10
Hot-air sterilization	Performing a hot-air sterilization at 180 °C / 356 °F, chap. 18.3
Humidity control	Setting the humidity control of the Permadyr™ system, chap.6.4
Settings	General controller settings, chap. 9
Measurement chart	Graphical display of the measured values, chap. 13
Interior socket (optional)	Turning on / off the interior socket voltage (option), chap. 6.5
Sensor adjustment	Adjustment menu for single-point and two-point adjustments (for Service)
Service contact	Service information
System information	Chamber information (model, name, serial no., firmware etc.)

6.1.2 Quick menu

The Quick menu provides fast access to frequently used functions.

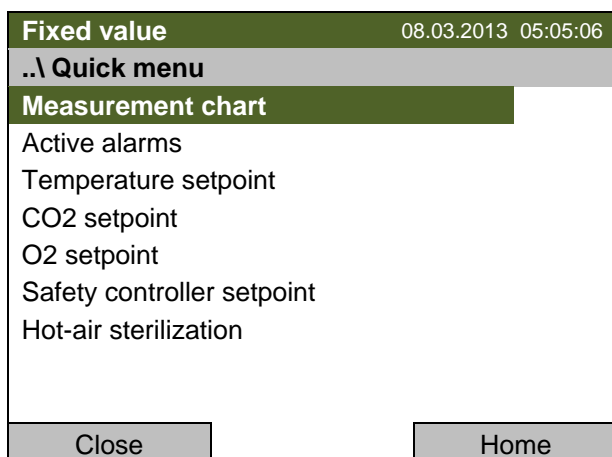

"Quick menu".
(item "O₂ setpoint" only coming with chamber with O₂ control)

Measurement chart	Graphical display of the measured values, chap. 13
Active alarms	Alarm settings, chap. 11.5
Temperature setpoint	Temperature setpoint entry, chap. 7.3
CO ₂ setpoint	CO ₂ setpoint entry, chap. 7.3
O ₂ setpoint	O ₂ setpoint, chap. 7.3
Safety controller setpoint	Setting the safety controller setpoint, chap. 14.2.2
Hot-air sterilization	Performing a hot-air sterilization at 180 °C / 356 °F, chap. 18.3

6.1.3 User menu

The user menu includes the key lock function, and provides quick access to the event list.

The key lock function serves to block the access to the controller. An overview of logon, logoff, and other events is given in the event list.

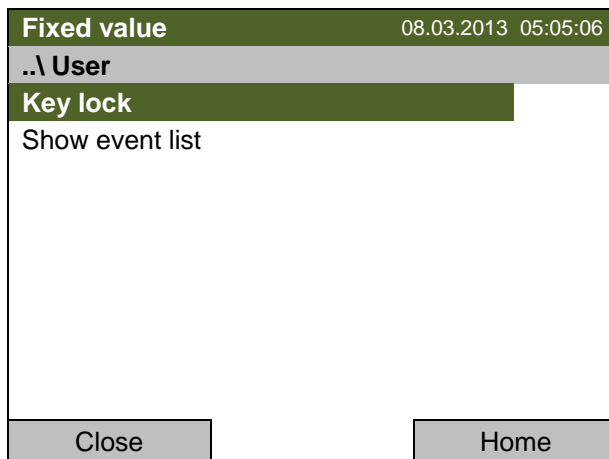

“User” menu

Key lock	Configuring the key lock function, chap. 8
Show event list	Displaying the event list, chap. 12

6.2 Operating modes

In the “**control off**” mode (chap. 6.2.1), the controller is non-functional and displays only the actual values. There is no heating or refrigeration and no inlet of CO₂ or O₂ (chamber with O₂ control). The temperature approximates the ambient value.

You can enter the desired setpoint values in “**fixed value**” mode (chap. 7). The controller then operates as a fixed-point control, i.e., it reaches and maintains the defined setpoints until the next manual change.

6.2.1 Activating the “control off” mode or change to “fixed value” operating mode

To select the “control off” or “fixed value” operating mode, go to [Menu > Controller mode](#)

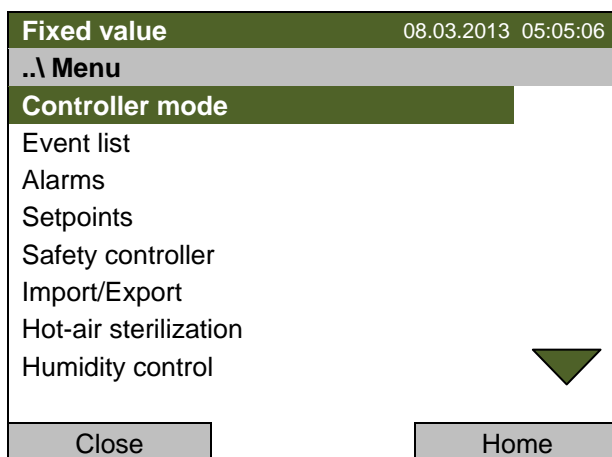

General menu.
Select “Controller Mode”
and press the operating button.

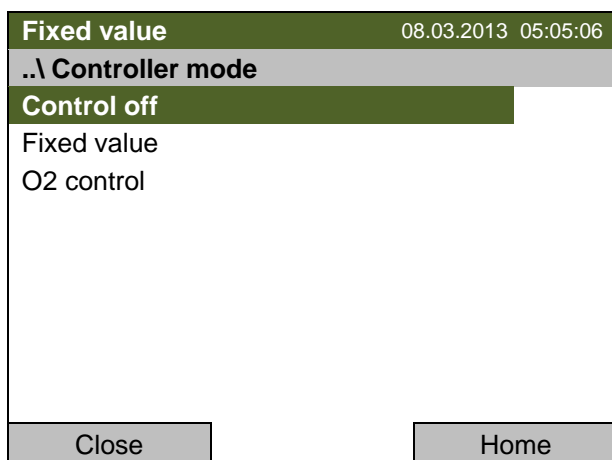

Submenu “Controller Mode”.
Select the desired controller mode
“Control off” or “Fixed value”
and press the operating button.

Control off		08.03.2013 05:05:06
..\ Menu		
Controller mode		
Event list		
Alarms		
Setpoints		
Safety controller		
Import/Export		
Hot-air sterilization		
Humidity control		
Close		Home

General menu.

The controller mode "Fixed value" or "Control off" is indicated in the display headline.

Go back to the initial view with "Home".

Control off		08.03.2013 05:05:06
	Setpoint	Actual value
Temperature	[°C]	22.2
CO2	[Vol.-%]	0.3
O2	[Vol.-%]	0.5
User	Quick menu	Menu

Initial view in "Control off" mode (sample values)

The controller is non-functional, i.e., there is no heating or CO₂ entry or O₂ entry (chamber with O₂ control).

6.3 Deactivating the O₂ control and O₂/N₂ pressure alarms (chamber with O₂ control)

6.3.1 Required gas supply of the chamber with O₂ control

In the chamber with O₂ control, cell growth can be additionally influenced by a variable oxygen content. Depending on the required range of O₂ concentration, the type of gas which is required may vary:

- **Hyperoxic range (> 22 vol.-% O₂)**

As compared to the ambient air (O₂ concentration of 20.9 vol.-%) only the O₂ concentration needs to be increased, no nitrogen is required for the O₂ control. Therefore, it is not necessary to connect a N₂ cylinder. You can deactivate the N₂ pressure alarm in the menu "[Menu > Controller mode > O₂ control](#)" (chap. 6.3.2).

- **Hypoxic range (< 20 Vol.-% O₂)**

As compared to the ambient air (O₂ concentration of 20.9 vol.-%) only the N₂ concentration needs to be increased, no oxygen is required for the O₂ control. Therefore, it is not necessary to connect an O₂ cylinder. You can deactivate the O₂ pressure alarm in the menu "[Menu > Controller mode > O₂ control](#)" (chap. 6.3.2).

- **Hyperoxic and hypoxic range or range from 20 vol.-% O₂ up to 22 vol.-% O₂**

N₂ and O₂ are required for O₂ control. It is necessary to connect all gas supplies.



- **Operation without O₂ control**

You can deactivate the O₂ control in the menu "[Menu > Controller mode > O₂ control](#)" (chap. 6.3.2). With this setting, no alarm messages for O₂ and N₂ (pressure or concentration) will be issued.

Since neither nitrogen nor oxygen are required, it is not necessary to connect an O₂ or N₂ cylinder. No O₂ and N₂ pressure alarms will be issued with deactivated O₂ control.

The zero-voltage relay alarm contact (chap. 11.6) for messages of deviation of the O₂ concentration will also not be triggered.

Overview

	Hyperoxic range (>22 vol.-% O ₂)	Hypoxic range (<20 vol.-% O ₂)	Hyperoxic and hypoxic ranges	No O ₂ control
O ₂ control (with O ₂ concentration alarm)	active	active	active	off 
Connection of O ₂ cylinder	connected	not connected	connected	not connected
O ₂ pressure alarm	active	off 	active	off
Connection of N ₂ cylinder	not connected	connected	connected	not connected
N ₂ pressure alarm	off 	active	active	off

6.3.2 Activating / deactivating the O₂ control and O₂ / N₂ pressure alarms

To activate or deactivate the O₂ control and O₂ / N₂ pressure alarms, go to [Menu > Controller mode > O₂ control](#)

Fixed value		08.03.2013 05:05:06
..\ O ₂ control		
O ₂ control: On		
O ₂ pressure alarm: On		
N ₂ pressure alarm: On		
Close	Home	

Submenu "O₂ control".

The current settings are displayed.

To change the settings, press the operating button.

The modified settings are displayed

"O₂ control: On" = O₂ control is active.

"O₂ control: Off" = O₂ control is deactivated.

"O₂ pressure alarm: On" or "N₂ pressure alarm: On" = the corresponding pressure alarm is activated.

"O₂ pressure alarm: Off" or "N₂ pressure alarm: Off" = the corresponding pressure alarm is deactivated.

Go back to the initial view with "Home".

Fixed value		08.03.2013 05:05:06	
	Setpoint	Actual value	
Temperature	[°C]	37.0	37.2
CO ₂	[Vol.-%]	5.0	5.0
O ₂	[Vol.-%]		20.9
			
User	Quick menu	Menu	

Initial view with deactivated O₂ control (sample values).

Also the pressure alarms for O₂ and N₂ are deactivated.

To enter the O₂ setpoint, first activate the O₂ control again.

With active O₂ control, the pressure alarms for O₂ and N₂ can be deactivated individually.

Fixed value		08.03.2013 05:05:06	
	Setpoint	Actual value	
Temperature	[°C]	37.0	37.2
CO ₂	[Vol.-%]	5.0	5.0
O ₂	[Vol.-%]		20.9
			
User	Quick menu	Menu	

Initial view with activated O₂ control and deactivated O₂ pressure alarm (sample values).

6.4 Humidity control of the Permady™ system

The Permady™ system with its 2-pan water system guarantees a maximum humidity of up to 95 % r.H. in the inner chamber, which remains condensation-free. This performance assumes an average ambient temperature of $22 \pm 3 \text{ }^\circ\text{C}$ / $71.6 \pm 5.4 \text{ }^\circ\text{F}$ and a working temperature in the inner chamber of $37 \text{ }^\circ\text{C}$ / $98.6 \text{ }^\circ\text{F}$.

You can increase or decrease humidity slightly if required.

To configure the humidity control of the Permady™ system, go to [Menu > Humidity control](#)

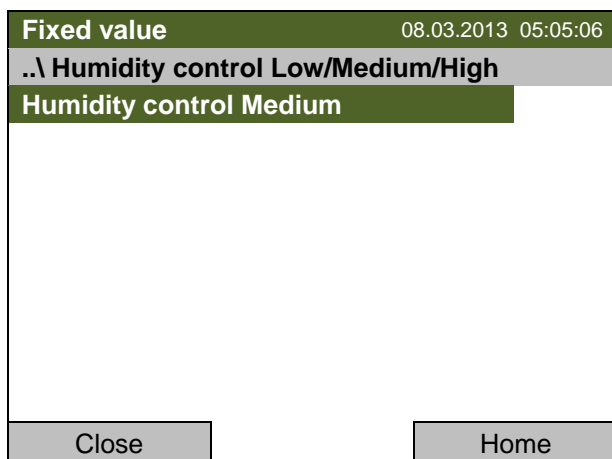

Submenu "Humidity control".
The current setting is displayed.
To change the setting, press the operating button.

Factory default setting: "Medium".

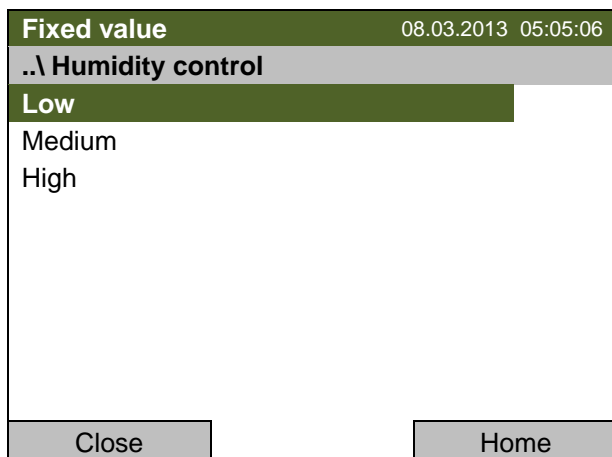

Submenu "Humidity control".
Select the desired setting
and press the operating button



If the ambient temperature deviates by more than $\pm 5 \text{ }^\circ\text{C}$ from the values recommended by the manufacturer, the conditions for maximum air humidity with condensation-free inner chamber are no longer guaranteed. Contact BINDER Service for assistance.

6.5 Turning on / off the interior socket voltage (with optional interior socket)

For chambers equipped with the optional interior socket (chap. 15.4) you can turn on and off the voltage of the interior socket.

To turn on or off the interior socket voltage, go to [Menu > Interior socket \(optional\)](#)

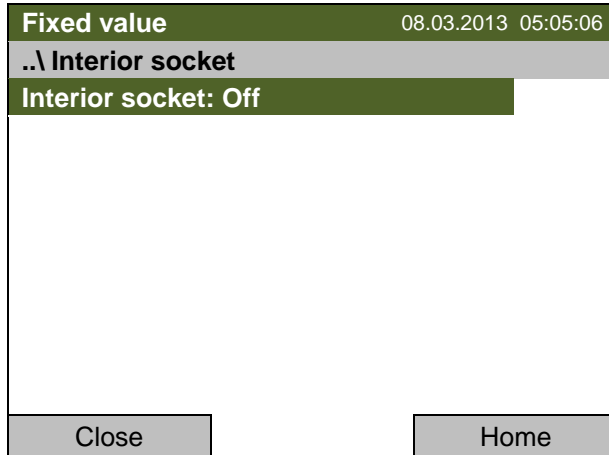

Submenu "Interior socket".

The current setting is displayed.

To change the setting, press the operating button

"Interior socket: On" = socket with activated voltage

"Interior socket: Off" = socket voltage-free

Go back to the initial view with "Home".

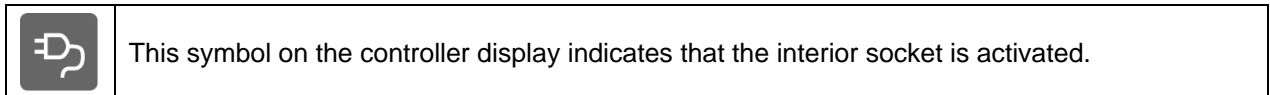

6.6 Performance during and after power failure

During a power failure, all controller functions are shut down. The gas inlet valves are closed so that no gas can escape into the ambient air. The zero-voltage relay alarm output (9) (chap. 11.6) is switched to alarm position for the whole duration of the power failure.

After the power returns, all functions return to the same status the chamber had before power failure. The controller continues to function in the original operating mode it was in previously before the power failure occurred. In "fixed value" mode, the setpoints are immediately resumed.

If the chamber had been running in sterilization mode, the sterilization process is cancelled and the chamber operates in "fixed value" operation mode with the setpoints already entered. All setpoint values remain in memory.

If the temperature or concentration of CO₂, and O₂ (chamber with O₂ control) have dropped below the alarm limits during power failure, confirm the alarms with the RESET button as soon as the correct values are reached again (chap. 11.4).

Power failure, including chamber shut-down with the main power switch, is listed in the event list.

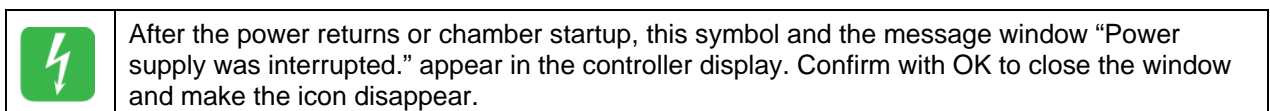

6.7 Information

You access chamber information like the chamber type, serial no., firmware version etc. To display the system information, go to [Menu > System information](#)

Fixed value 08.03.2013 05:05:06	
..\ System information	
Chamber type: CB	
Chamber name: CB_E6.1	
Serial number: 00-00000	
Special application number: 00-0000	
Parameter version: 511B-0004-0000	
Firmware version (1): 521C-0001-002E	
Firmware version (2): 521B-0005-0023	
Close	Home

Submenu "System information" (sample values).

To display the BINDER Service contact data, go to [Menu > Service contact](#)

Fixed value 08.03.2013 05:05:06	
..\ Service contact	
	
Best conditions for your success	
Service hotline	
International:	+49 7462 2005 555
USA Toll Free:	+ 1 866 885 9794
	or + 1 631 224 4340
CIS:	+ 7 495 988 1516
service@binder-world.com	
www.binder-world.com	
Close	Home

Submenu "Service contact".

Further information windows are accessible under [Menu > Settings > Network settings > Show network settings](#) (chap. 9.9) and – for Service purpose – under [Menu > Settings > Chamber configuration](#) (chap. 9.11).

7. Setpoint entry

7.1 Setting ranges

Temperature	7 °C / 12.6 °F above ambient up to 60 °C / 140 °F
CO ₂	0 vol.-% up to 20 vol.-%
O ₂ (chamber with O ₂ control)	0.2 vol.-% up to 95 vol.-%

	<p>When changing the temperature setpoint, check the setting of the overtemperature safety controller class 3.1 (chap. 14.2).</p> <p>With setpoint type "Limit", adapt the safety controller always when changing the temperature setpoint.</p>
---	---



	<p>When setting a lower temperature setpoint, in order to save time, we recommend cooling down the chamber by turning it off and opening both chamber doors.</p>
---	--

	<p>When setting a lower CO₂ setpoint, the CO₂ gas must be able to escape first. Open both chamber doors for this purpose.</p>
---	---

7.2 Note when setting high gas concentrations

Notes on handling carbon dioxide (CO₂)



Carbon dioxide (CO₂) in high concentrations is hazardous to health. It is colorless and almost odorless and therefore practically imperceptible. Vent out any CO₂ gas that may escape via good room ventilation or a suitable connection to an exhaust system. We recommend installing a CO₂ warning system.

	 WARNING
	<p>High concentration of CO₂ (> 4 Vol.-%).</p> <p>Danger of death by suffocation.</p> <p>Danger of poisoning.</p> <ul style="list-style-type: none"> ⊘ Do NOT set up chambers in non-ventilated recesses. ➤ Ensure technical ventilation measures. ➤ Observe the relevant regulations for handling CO₂.

If CO₂ is released, leave the area und inform the security service or fire department.

Chamber with O₂ control: Notes on handling oxygen (O₂)

Oxygen (O₂) is colorless and almost odorless and therefore practically imperceptible. It promotes burns, which can proceed explosively. There is a fire hazard for flammable oxygenated materials, e.g. clothes and hair. O₂ is heavier than air and may accumulate in low-lying areas.



	 WARNING
<p>High concentration of O₂ (> 21 % O₂). Fire and explosion hazard through contact of combustible materials with O₂. Risk of burns and other injuries.</p> <ul style="list-style-type: none"> ∅ Do NOT set up chambers in non-ventilated recesses ➤ Ensure technical ventilation measures ➤ Observe the relevant regulations for handling O₂. 	

Take appropriate measures to prevent oxygen enrichment and fire and explosion hazards in areas where oxygen enrichment is possible.

Observe the general information for safe handling of oxygen (chap. 1.6).

Chamber with O₂ control: Notes on handling nitrogen (N₂)

Nitrogen (N₂) in high concentrations is hazardous to health. It is colorless and almost odorless and therefore practically imperceptible. Any N₂ gas that may escape must be safely led out via good room ventilation or a suitable connection to an exhaust system.

	 WARNING
<p>High concentration of N₂. Risk of death by suffocation.</p> <ul style="list-style-type: none"> ∅ Do NOT set up chambers in non-ventilated recesses ➤ Ensure technical ventilation measures ➤ Observe the relevant regulations for handling N₂. 	

7.3 Entering the setpoints via “quick menu”

To enter setpoints via quick menu, go to [Quick menu](#).

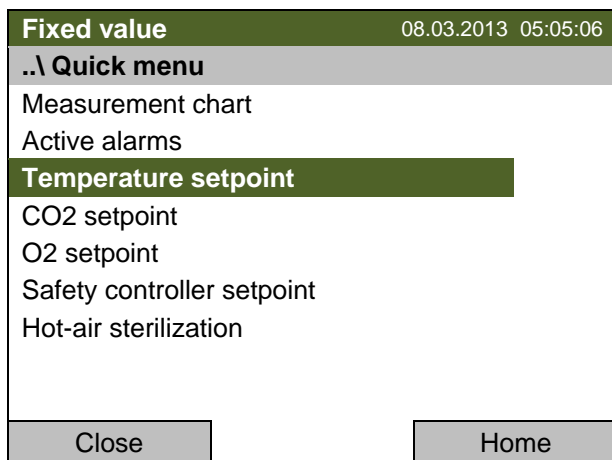

“Quick menu”.
 (item “O2 setpoint” only coming with chamber with O₂ control)
 Select the desired parameter and press the operating button.

	<p>When trying to enter a setpoint in the „Controller off“ operating mode, a notification window shows “Controller mode is OFF!”. Press the operating button to confirm with “Ok” and change the operating mode to “Fixed value” (chap. 6.2.1).</p>
---	---

Temperature setting

To enter the temperature setpoint, go to [Quick menu > Temperature setpoint](#)

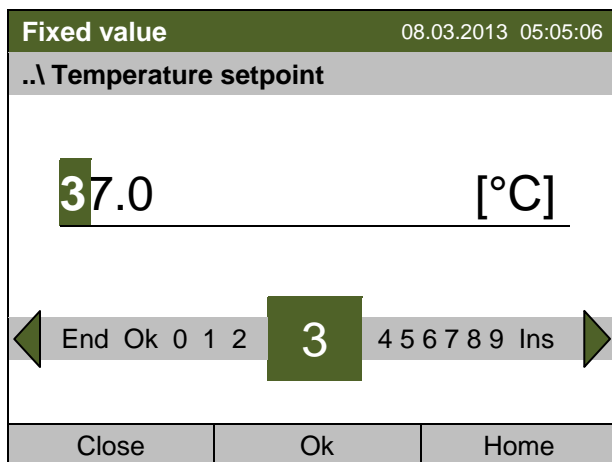

Entry menu “Temperature setpoint”.
 Select each number with the operating button and press the operating button to confirm.
 Setting range: 20 °C / 68 °F up to 60 °C / 140 °F.
 Press the “Ok” button to confirm.

When entering a value outside the setting range, the message “invalid value” appears. Press the operating button to confirm with “Ok” and repeat the entry with a correct value.

Go back to the initial view with “Home” or enter the CO₂ concentration.

Setting the CO₂ concentration

To enter the CO₂ setpoint, go to [Quick menu > CO₂ setpoint](#)

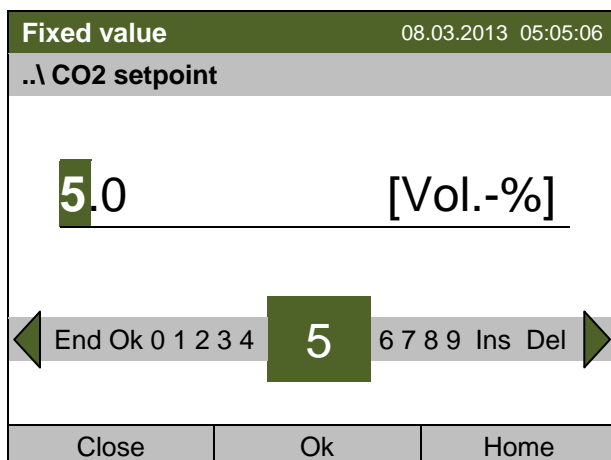

Entry menu "CO₂ setpoint".

Select each number with the operating button and press the operating button to confirm.

Setting range: 0 vol.-% up to 20 vol.-%.

Press the "Ok" button to confirm.

When entering a value outside the setting range, the message "invalid value" appears. Press the operating button to confirm with "Ok" and repeat the entry with a correct value.

Go back to the initial view with "Home" or enter the O₂ concentration (chamber with O₂ control).

Setting the O₂ concentration (chamber with O₂ control)

To enter the O₂ setpoint, go to [Quick menu > O₂ setpoint](#)

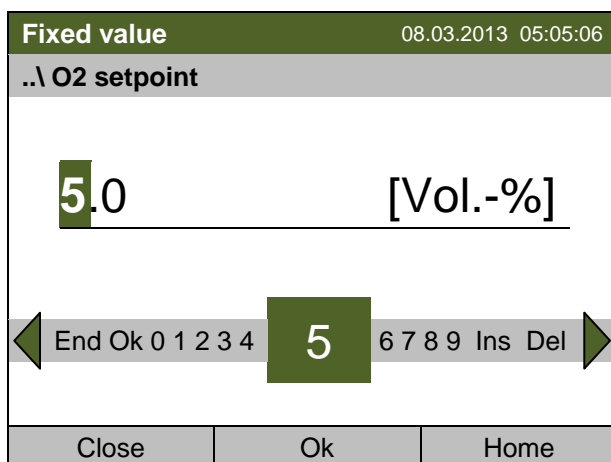

Entry menu "O₂ setpoint".

Select each number with the operating button and press the operating button to confirm.

Setting range: 0.2 vol.-% up to 95 vol.-%.

Press the "Ok" button to confirm.

When entering a value outside the setting range, the message "invalid value" appears. Press the operating button to confirm with "Ok" and repeat the entry with a correct value.

Go back to the initial view with "Home".

7.4 Entering the setpoints via general menu

To enter setpoints via general menu, go to [Menu > Setpoints](#)

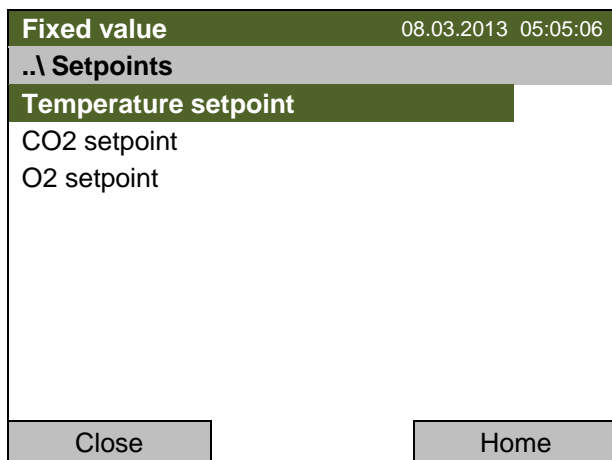

Submenu "Setpoints".
(item "O2 setpoint" only coming with chamber with O₂ control)
Select the desired parameter and press the operating button.

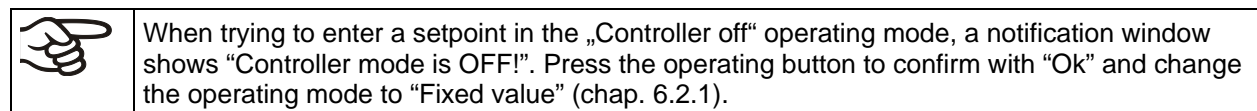

Temperature setting

To enter the temperature setpoint, go to [Menu > Setpoints > Temperature setpoint](#)

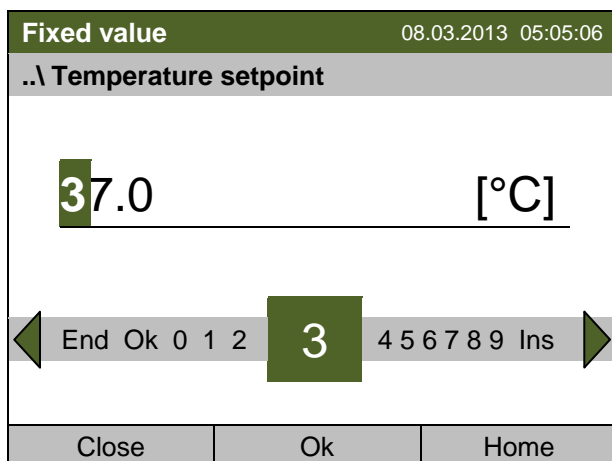

Entry menu "Temperature setpoint".
Select each number with the operating button and press the operating button to confirm.
Setting range: 20 °C / 68 °F up to 60 °C / 140 °F.
Press the "Ok" button to confirm.

When entering a value outside the setting range, the message "invalid value" appears. Press the operating button to confirm with "Ok" and repeat the entry with a correct value.

Go back to the initial view with "Home" or enter the CO₂ concentration.

Setting the CO₂ concentration

To enter the CO₂ setpoint, go to [Menu > Setpoints > CO₂ setpoint](#)

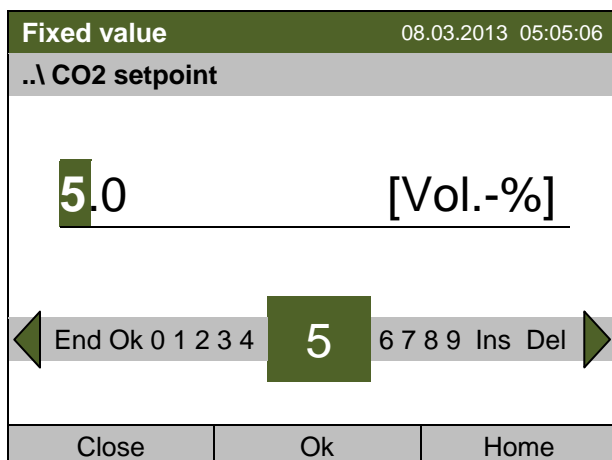

Entry menu "CO₂ setpoint".

Select each number with the operating button and press the operating button to confirm.

Setting range: 0 vol.-% up to 20 vol.-%.

Press the "Ok" button to confirm.

When entering a value outside the setting range, the message "invalid value" appears. Press the operating button to confirm with "Ok" and repeat the entry with a correct value.

Go back to the initial view with "Home" or enter the O₂ concentration (chamber with O₂ control).

Setting the O₂ concentration (chamber with O₂ control)

To enter the O₂ setpoint, go to [Menu > Setpoints > O₂ setpoint](#)

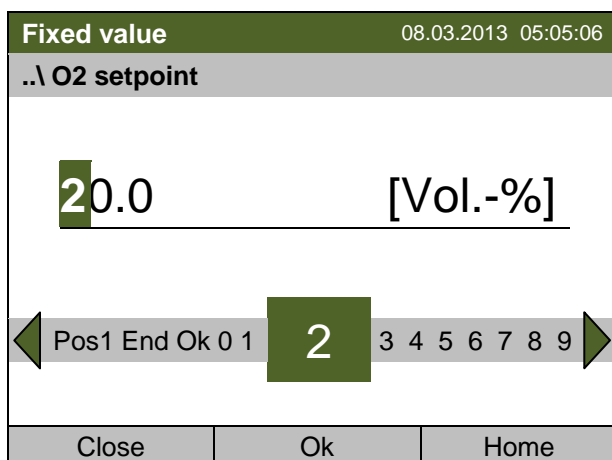

Entry menu "O₂ setpoint".

Select each number with the operating button and press the operating button to confirm.

Setting range: 0.2 vol.-% up to 95 vol.-%.

Press the "Ok" button to confirm.

When entering a value outside the setting range, the message "invalid value" appears. Press the operating button to confirm with "Ok" and repeat the entry with a correct value.

Go back to the initial view with "Home".

8. Key lock

The key lock function serves to block the access to the controller. When the “key lock” function is activated, the controller changes to the initial view and can only be changed when entering the current password.

To configure the key lock function, go to [User > Key lock](#)

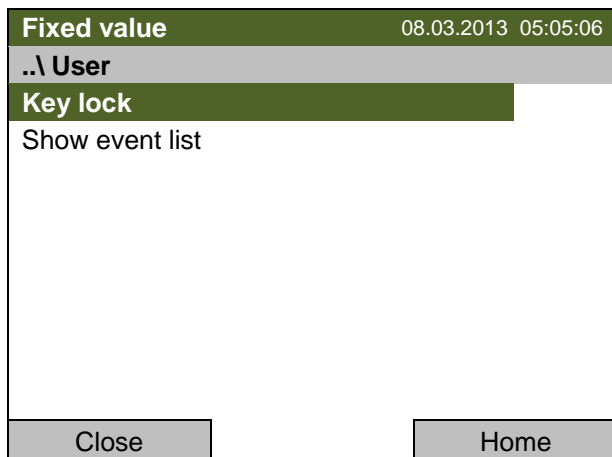

“User” menu.
Select “Key lock”
and press the operating button.

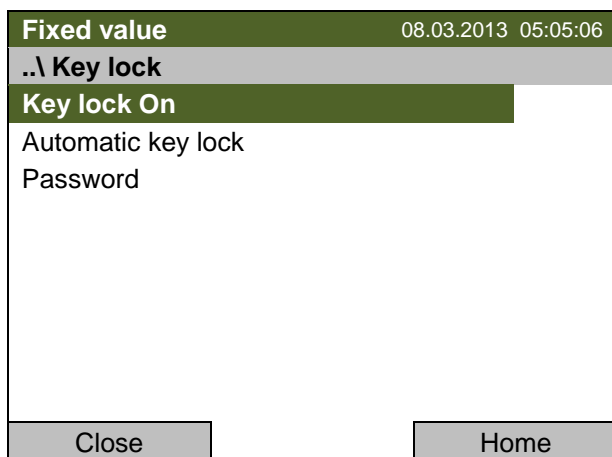

Submenu “Key lock”.
Select the desired function
and press the operating button.

Key lock On	The key lock is directly activated
Automatic key lock	The key lock is activated automatically after a defined waiting time
Password	Change password for unlocking. Factory setting: 0000

8.1 Directly activating the key lock

To directly activate the key lock, go to [User > Key lock > Key lock On](#)

Fixed value 08.03.2013 05:05:06	
..\ Key lock	
Key lock On	
Automatic key lock	
Password	
Close	Home

Submenu "Key lock".

Select "Key lock On" to activate the key lock function immediately and press the operating button.

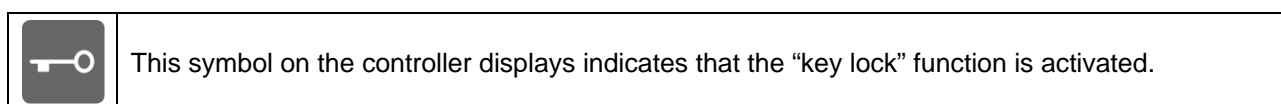

The controller remains in the initial view and may be operated only after entering the current password.

Enter password 08.03.2013 05:05:06		
..\ Key lock password		
<div style="border: 1px solid black; width: 100px; height: 20px; background-color: #ccc; margin-bottom: 5px;"></div>		
<div style="border: 1px solid black; padding: 5px; display: flex; justify-content: space-between;"> Ok: A B C D E F 0 1 2 3 4 5 6 7 8 9 </div>		
Close	Ok	Home

Entry menu "Key lock password".

Enter the password with the operating button.

Factory setting is 0000

Press the "Ok" button to confirm.

8.2 Automatic key lock

To configure the automatic key lock, go to [User > Key lock > Automatic key lock](#)

Fixed value 08.03.2013 05:05:06	
..\ Automatic key lock	
Automatic key lock	
Waiting time [min]	
Close	Home

Submenu "Automatic Key lock".

Select the desired function and press the operating button.

Under “Waiting time [min]” you can enter the waiting time, after which the key lock will be automatically activated. This time starts running off after the last entry to the controller. To enter it, go to [User > Key lock > Automatic key lock > Waiting time \[min\]](#)

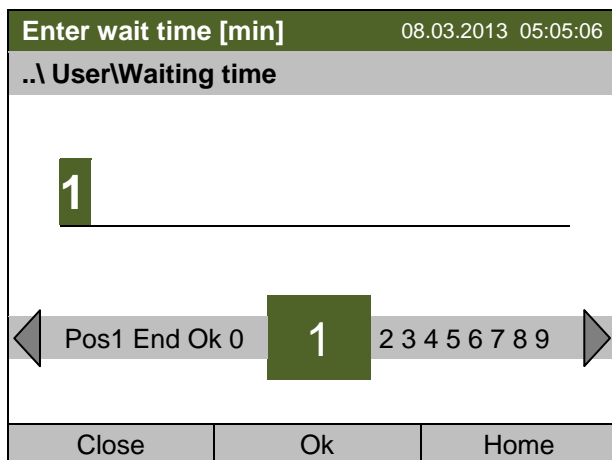

Entry menu “Waiting time”.
 Enter the desired interval with the operating button. This interval starts running off after the last action on the controller. If the automatic key lock function is enabled, it will become active after this time.
 Factory setting: 1 minute.
 Press the “Ok” button to confirm.

To activate the automatic key lock function with the pre-configured waiting time, select [User > Key lock > Automatic key lock > Automatic key lock](#)

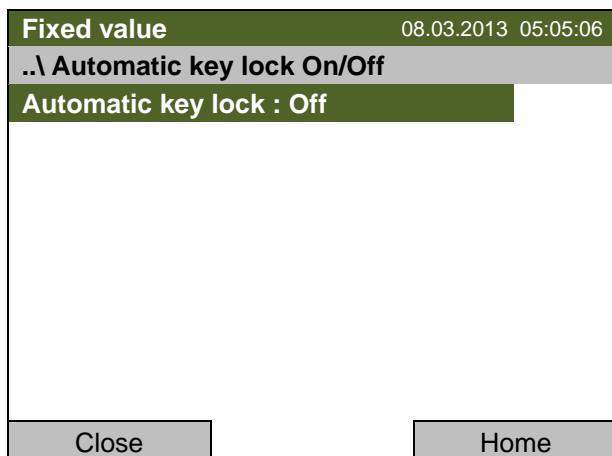

Submenu “Automatic Key lock On/Off”.
 The current setting is displayed.
 To change the setting, press the operating button.
 “Automatic Key lock : On” = Automatic key lock function activated. The time set under “Waiting time” begins running off.
 “Automatic Key lock : Off” = Automatic key lock function deactivated

Now the waiting time starts running off.
 Go back to the initial view with “Home”.

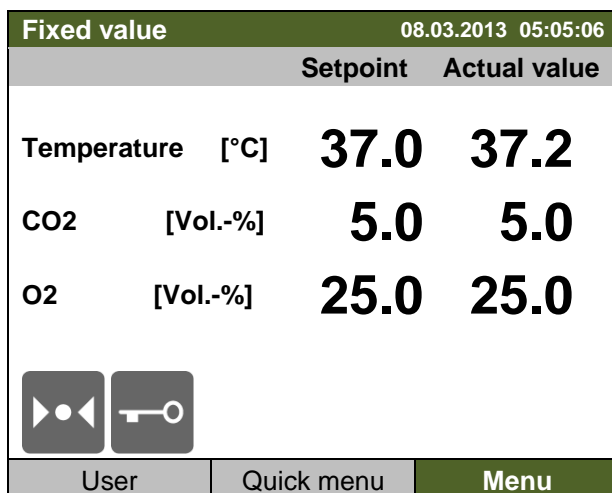

Initial view.
 As soon as the waiting period has expired, the “key lock” symbol is displayed.

The controller remains in the initial view and may be operated only after entering the current password.
 After further entries to the controller, the waiting period begins running again, since the automatic keylock function remains active until turning it off manually.

	<p>This symbol on the controller displays indicates that the “key lock” function is activated.</p>
---	--

8.3 Changing the password for unlocking the key lock

To change the password for unlocking the key lock, go to *User > Key lock > Password*

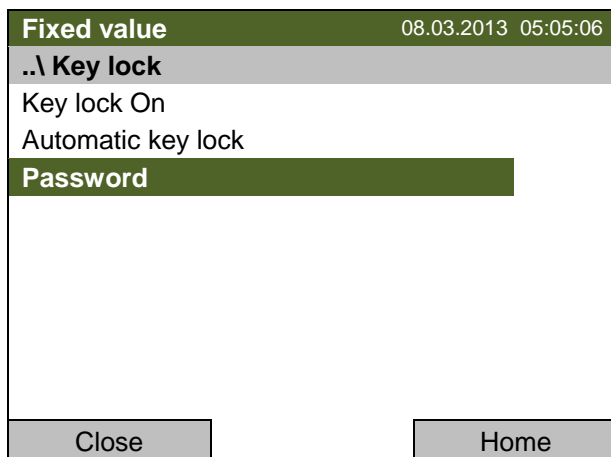

Submenu “Key lock”.
Select „Password“
and press the operating button.

A security question is displayed:

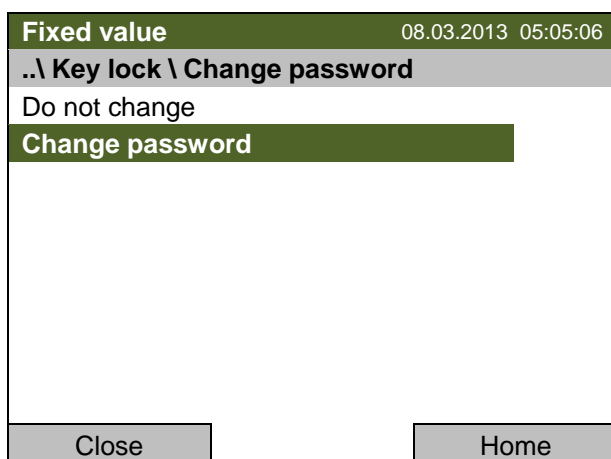

Submenu “Change password”.
To change the password,
select “Change password”
and press the operating button.

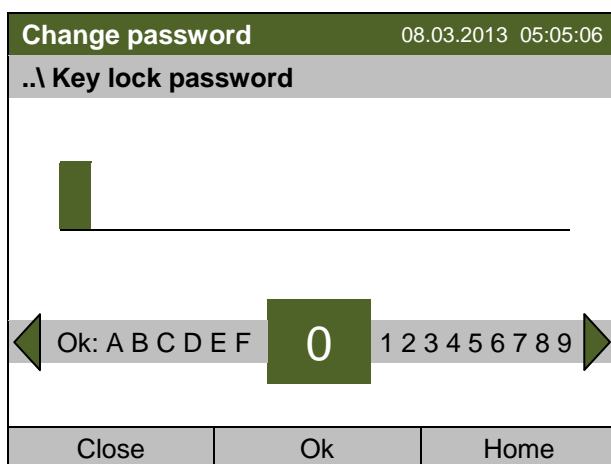

Entry menu “Key lock password”.
Enter the desired password with the operating
button. Factory setting is 0000
Press the “Ok” button to confirm.

	<p>Keep well in mind any password modification. Without the correct password, unlocking the key lock is impossible.</p>
---	---

9. General controller settings

In the "Settings" submenu, you can enter the date and time, select the language for the menus and the desired temperature unit, perform the configuration for the controller's communication functions, and reset the controller to factory settings.

To access the "Settings" submenu, go to [Menu > Settings](#)

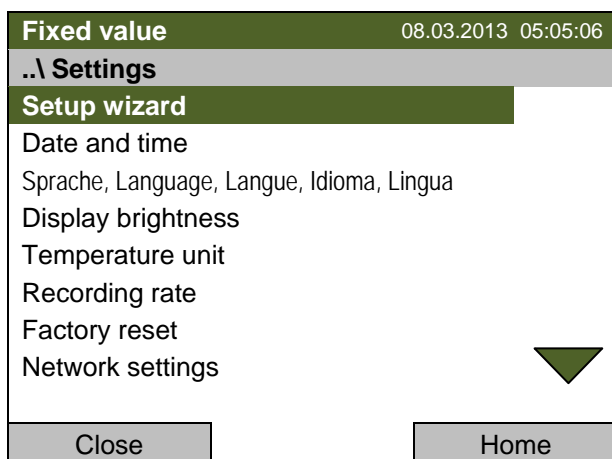

Submenu "Settings".

Turn the operating button to see additional menu items.

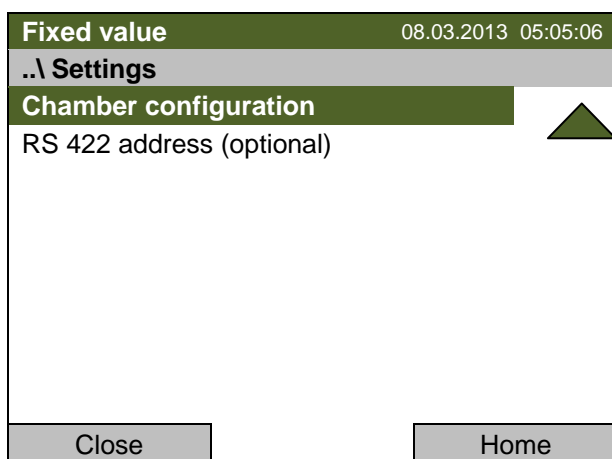

Submenu "Settings" (next page).

Setup wizard	Chap. 9.1
Date and time	Setting date and time, chap. 9.2
Sprache, Language, Langue, Idioma, Lingua	Selecting the controller's menu language, chap. 9.3
Display brightness	Adjusting display brightness by turning the operating button, chap. 9.4
Temperature unit	Selecting the temperature unit, chap.9.5
Recording rate	Defining the recording rate for data storage, chap. 9.6
Factory reset	Factory reset, chap. 9.7
Network settings	Network configuration, chap. 9.8
Chamber configuration	Menu for Service purpose – Entering chamber data like the serial no., service information
RS 422 address (optional)	Setting the RS 422 chamber address(with option RS422 interface), chap. 9.10

9.1 Setup wizard

The setup wizard will guide you sequentially through the important menus to configure your chamber

- Menu language
- Device name
- Date and time
- IP address
- Subnet mask
- Network name
- Gateway
- DNS 1
- DNS 2

Then the controller returns to the initial view.



Use the setup wizard only if you want to enter all the requested information, as no item can be skipped.



You can configure the network settings (IP address, and the following) only if the DHCP status is Off, otherwise the DHCP server would assign the network configuration.

If you try configuring any network settings (i.e., when reaching item "IP address" in the setup wizard) while DHCP is enabled, the message "DHCP enabled!" is shown. After confirming with Ok the Setup wizard is cancelled and the controller returns to the initial display. Any settings made so far remain valid.

9.2 Date and time settings

To access the date and time settings, go to [Menu > Settings > Date and time](#)

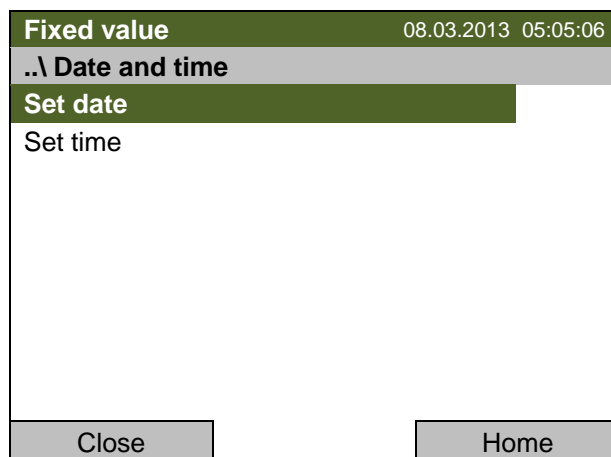

Submenu "Date and time".
Select the desired function
and press the operating button.

Function "Set date"

Fixed value		08.03.2013 05:05:06
..\ Select date (DD.MM.YYYY)		
08.03.2013		
◀	Ins Pos1 End Ok	0 1 2 3 4 5 6 7 8 9 ▶
Close	Ok	Home

Entry menu "Select date".

The current date is shown. If it is incorrect, enter the correct date with the operating button.

Press the "Ok" button to confirm.

Function "Set time"

Fixed value		08.03.2013 05:05:06
..\ Set time (HH:MM:SS)		
05:05:06		
◀	Ins Pos1 End Ok	0 1 2 3 4 5 6 7 8 9 ▶
Close	Ok	Home

Entry menu "Set time".

The current time is shown. If it is incorrect, enter the correct time with the operating button.

Press the "Ok" button to confirm.

There is no automatic switch to local light-saving times because this could lead to problems with data seeming to be missing or being overwritten in the data base.

Go back to the "Settings" menu with "Close" or to the initial view with "Home".

9.3 Selecting the menu language of the T4.12 controller

The T4.12 chamber controller communicates via a comprehensible menu navigation in plain text in a selectable language.

To select the desired menu language, go to

Menu > Settings > Sprache, Language, Langue, Idioma, Lingua



Submenu “Language”.
Select the desired language and press the operating button.

Go back to the “Settings” menu with “Close” or to the initial view with “Home”.

9.4 Setting display brightness

To select the display brightness, go to **Menu > Settings > Display brightness**

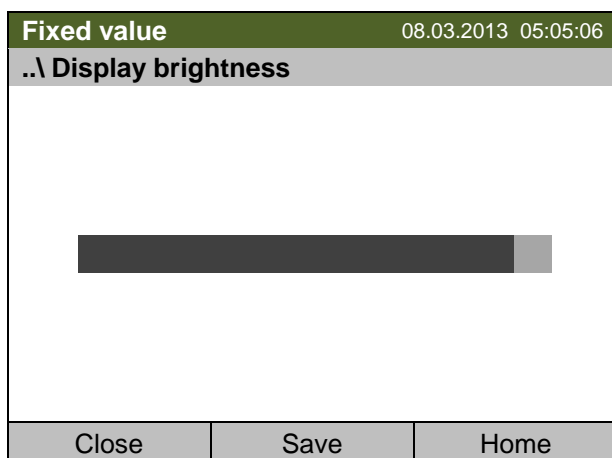

Submenu “Display brightness”.
Select the desired setting by turning the operating button.
Confirm by selecting “Save”.

Go back to the “Settings” menu with “Close” or confirm the change with “Save”: The controller returns to the initial view.

9.5 Changing the temperature unit

To select the temperature unit, go to [Menu > Settings > Temperature unit](#)

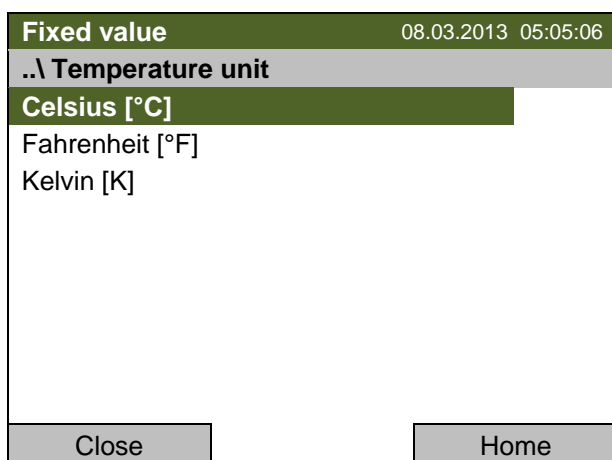

Submenu "Temperature unit".
Select the desired temperature unit
and press the operating button.

Go back to the "Settings" menu with "Close" or to the initial view with "Home".

9.6 Defining the data recording rate

To define the recording rate for data storage on the SD card, go to [Menu > Settings > Recording rate](#)

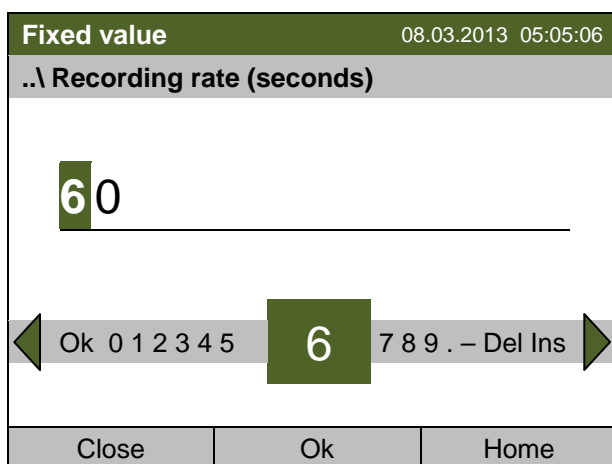

Entry menu "Recording rate".
The current recording rate is shown. Enter the
desired value with the operating button.
Shortest possible value: 60 seconds.
Press the "Ok" button to confirm.

Go back to the "Settings" menu with "Close" or to the initial view with "Home".

Note:

After a period of 3 years, the controller starts overwriting the oldest values on the storage medium. This is independent of the selected storage interval and the actual operating time of the chamber. In any case, the data can be read out at any time using the function "Export to USB drive" (chap. 10.1) and stored externally.

9.7 Factory reset

The “factory reset” function allows resetting the controller configuration to the factory settings.

	<p>Risk of data loss! When resetting to factory settings, all controller settings will be deleted. The event list and stored measuring data are NOT affected.</p>
---	--

To access the “Factory reset” function, go to [Menu > Settings > Factory reset](#)

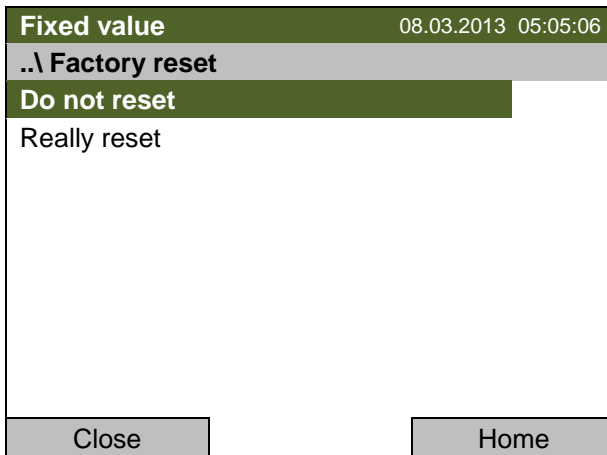

Submenu “Factory reset”.
This a security question. Select the desired function and press the operating button.

Go back to the “Settings” menu with “Close” or to the initial view with “Home”.

9.8 Network configuration

The settings of this submenu are required for networking chambers with an Ethernet interface, e.g. to connect them with BINDER’s communication software APT-COM™ 3 DataControlSystem.

You can display the chamber’s IP address that has been assigned by your DHCP server or manually assign the IP address. All necessary configurations for networking the chamber are available in this menu.

To view and configure the network settings, go to [Menu > Settings > Network settings](#)

	<p>To configure the network settings, the DHCP state must be set to off. Otherwise, the DHCP-server would assign the network configuration.</p>
---	---

If you try to configure the network settings with enabled DHCP state, the message “DHCP enabled!” is shown. Confirm with „Ok” to return to the “Network settings” menu.

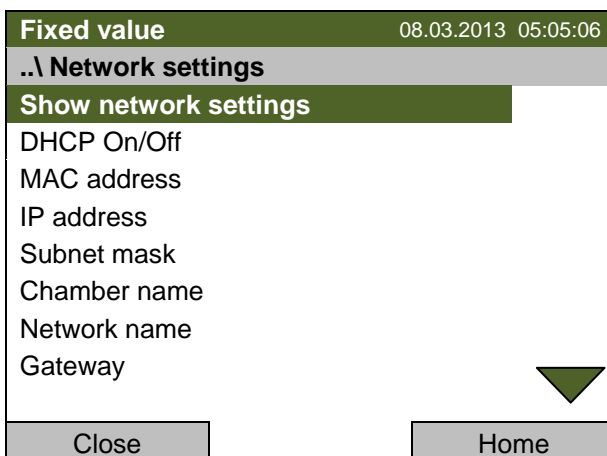

Submenu “Network settings”.
Turn the operating button to see additional menu items.

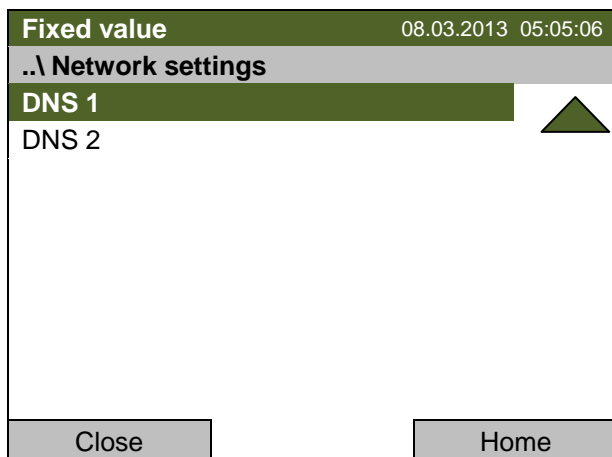

Submenu "Network settings" (next page).

Show network settings	Overview of the entire network configuration
DHCP On/Off	Switching on and off the DHCP state
MAC address	Displaying the MAC address
IP address	Entering the desired IP address
Subnet mask	Entering the subnet mask number
Chamber name	Entering the name of the CO ₂ incubator
Network name	Entering the network name
Gateway	Entering the gateway number
DNS 1	Entering the DNS 1 number
DNS 2	Entering the DNS 2 number

Set the DHCP State on/off:

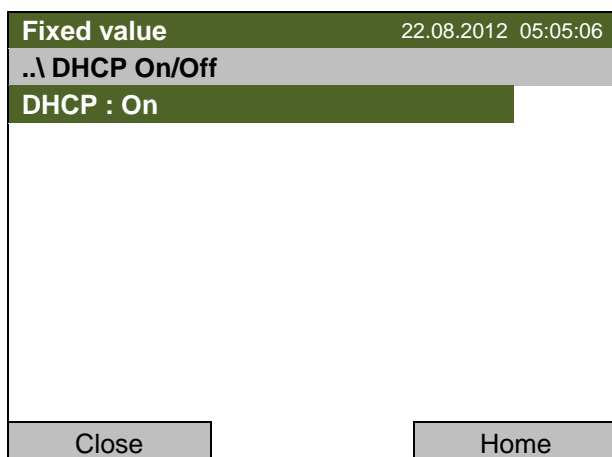

Submenu "DHCP On/Off".

The current DHCP state is displayed. Press the operating button to change it.

Then the new DHCP state is displayed

"DHCP : On" = DHCP state activated

"DHCP : Off" = DHCP state deactivated

Go back to the "Network settings" menu with "Close" or to the initial view with "Home".



You can only configure the following network settings if the DHCP state is set to "Off".

Display the MAC address

To identify the chamber in the Ethernet network you can display the chamber's MAC address.

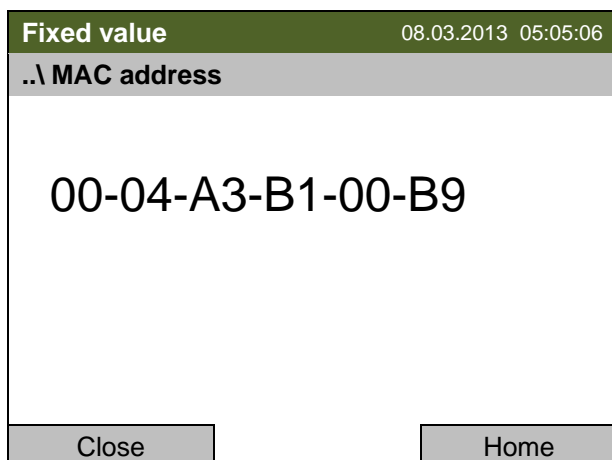

Submenu "MAC address"
(example value)
The MAC address is displayed.

Go back to the "Network settings" menu with "Close" or to the initial view with "Home".

Enter the IP address:

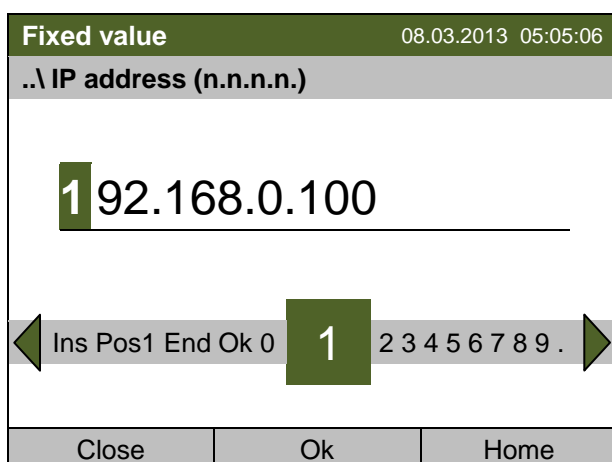

Entry menu "IP address"
(example value)
Enter the desired IP address with the operating
button.
Press the "Ok" button to confirm.

Go back to the "Network settings" menu with "Close" or to the initial view with "Home".

Enter the subnet mask:

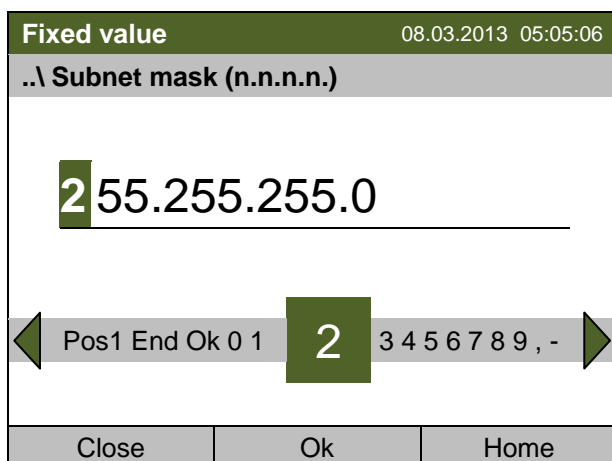

Entry menu "Subnet mask"
(example value)
Enter the desired net mask with the operating
button.
Press the "Ok" button to confirm.

Go back to the "Network settings" menu with "Close" or to the initial view with "Home".

Enter the chamber name:

Fixed value		08.03.2013 05:05:06
..\ Chamber name		
<div style="border: 1px solid black; padding: 5px;"> C B_E6.1 </div>		
← End Ok _ : A B	C	D E F G H I J K →
Close	Ok	Home

Entry menu "Chamber name".
 Enter the desired chamber name with the operating button.
 Press the "Ok" button to confirm.

Go back to the "Network settings" menu with "Close" or to the initial view with "Home".

Enter the network name:

Fixed value		08.03.2013 05:05:06
..\ Network name		
<div style="border: 1px solid black; padding: 5px;"> C B_E6.1 </div>		
← End Ok _ : A B	C	D E F G H I J K →
Close	Ok	Home

Entry menu "Network name".
 Enter the desired network name with the operating button.
 Press the "Ok" button to confirm.

Go back to the "Network settings" menu with "Close" or to the initial view with "Home".

Enter the default gateway:

Fixed value		08.03.2013 05:05:06
..\ Gateway (n.n.n.n.)		
<div style="border: 1px solid black; padding: 5px;"> 1 92.168.0.1 </div>		
← Pos1 End Ok 0	1	2 3 4 5 6 7 8 9 , →
Close	Ok	Home

Entry menu "Gateway"
 (example value)
 Enter the desired gateway with the operating button.
 Press the "Ok" button to confirm.

Go back to the "Network settings" menu with "Close" or to the initial view with "Home".

Enter the DNS 1 or DNS 2:

Fixed value		08.03.2013 05:05:06
..\ DNS 1 (n.n.n.n.)		
1 92.168.0.1		
◀	Ins Pos1 End Ok 0	1 2 3 4 5 6 7 8 9 , ▶
Close	Ok	Home

Entry menu "DNS 1" or "DNS 2"
(example value)
Enter the desired number with the operating button.
Press the "Ok" button to confirm.

Go back to the "Network settings" menu with "Close" or to the initial view with "Home".

9.9 Display of the network configuration

To access the overview of the complete network configuration, go to
[Menu > Settings > Network settings > Show network settings](#)

Fixed value		08.03.2013 05:05:06
..\ Show network settings		
DHCP	Off	
MAC address	00-04-A3-B1-00-B9	
IP address	192.168.0.100	
Net mask	255.255.255.0	
Gateway	192.168.0.1	
DNS1	192.168.0.1	
DNS2	0.0.0.0	
Chamber name	CB_E6.1	
BIOS name	CB_E6.1	
Close		Home

Overview of the network configuration
(sample values)

Go back to the "Network settings" menu with "Close" or to the initial view with "Home".

9.10 RS 422 address (with optional RS 422 interface)

For chambers equipped with the optional RS 422 interface, the RS 422 address serves to identify the chamber in a network and to establish communication with the optional BINDER communication software APT-COM™ 3 DataControlSystem. The factory default setting is “1”.

To enter the RS 422 chamber address, go to [Menu > Settings > RS 422 address \(optional\)](#)

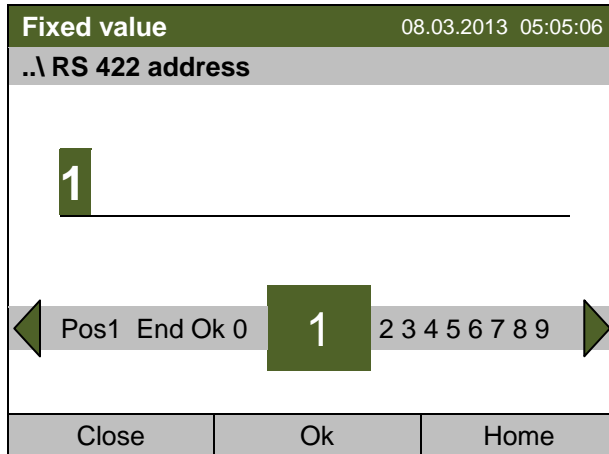

Entry menu “RS 422 address”.

Enter the desired address (1 up to 254) with the operating button.

Press the “Ok” button to confirm.

Go back to the “Settings” menu with “Close” or to the initial view with “Home”.

9.11 Display and entry of the device configuration – for service purpose

Information about the chamber, such as chamber type, name, serial number, firmware version, etc. can be viewed under [Menu > System information](#) (chap. 6.7).

To access the device configuration menu, go to [Menu > Settings > Chamber configuration](#)

This menu is password protected and only intended for Service purpose.

10. Data transfer via USB interface

The USB port is located in the instrument box.

To access the submenus for data transfer, go to [Menu > Import/Export](#)

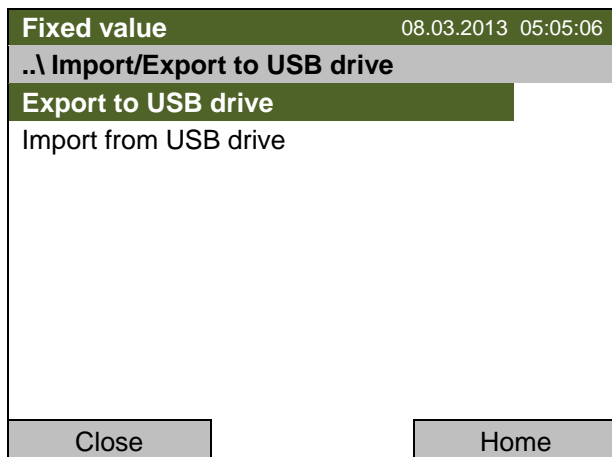

Submenu "Import/Export to USB drive".
Select the desired type of communication via USB port (data export or import) and press the operating button.



It is possible that some USB devices are not recognized due to compatibility issues. In this case, please use a USB storage device from a different manufacturer.

10.1 Exporting data to USB drive

Insert the USB stick or the plug of your USB drive into the USB port in the instrument box.

To configure data export to USB media, go to [Menu > Import/Export > Export to USB drive](#)

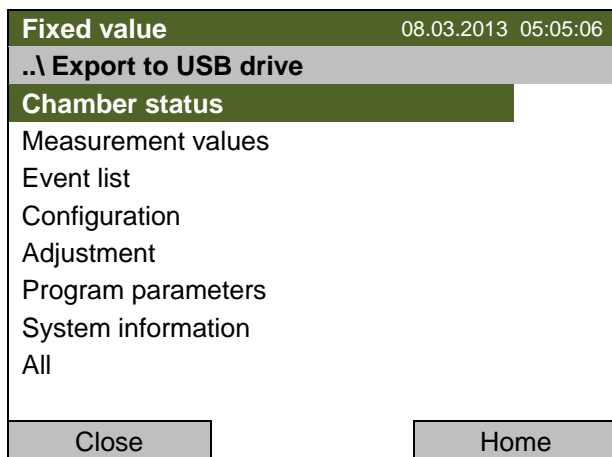

Submenu "Export to USB drive".

Select the desired data type and press the operating button. Data is written to the connected media.

Chamber status	Actual chamber status, including operating mode, setpoints etc.
Measurement values	Measured data
Event list	List of status information and errors (see chap. 12)
Configuration	(Service only)
Adjustment	Adjustment data
Program parameters	(Service only)
System information	(Service only)
All	All data

 If no USB device has been connected, the message “No USB device found” is displayed. Confirm the message with “OK” and insert the USB medium.

 This symbol on the controller display in the initial view indicates that data are being transmitted via the USB port.

During a prolonged transfer, the message “USB data transfer in progress” is displayed. Confirm the message with “OK”.

Following data transfer, the message “USB data transfer completed” is displayed. Confirm the message with “OK”.

10.2 Importing data from USB drive

Insert the USB stick or the plug of your USB drive into the USB port in the instrument box.

To configure data import from USB media, go to [Menu > Import/Export > Import from USB drive](#)

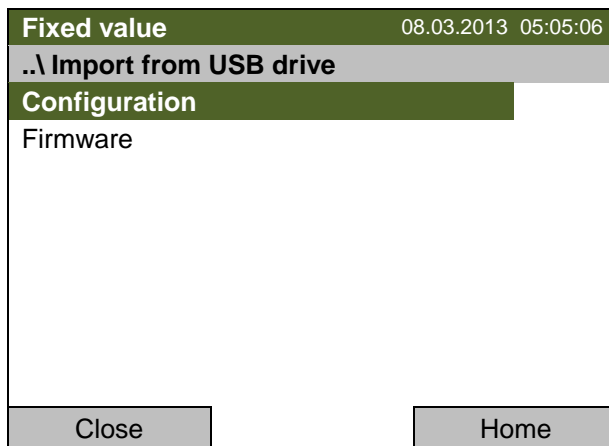

Submenu “Import from USB drive”.
Select the desired data type
and press the operating button.
Data is read from the connected media.

Configuration	(Service only)
Firmware	(Service only)

 If no USB device has been connected, the message “No USB device found” is displayed. Confirm the message with “OK” and insert the USB medium.











 This symbol on the controller display in the initial view indicates that data are being transmitted via the USB port.



During a prolonged transfer, the message “USB data transfer in progress” is displayed. Confirm the message with “OK”.

Following data transfer, the message “USB data transfer completed” is displayed. Confirm the message with “OK”.





11. Notifications and Alarms







11.1 Notifications overview

Icon	Signification	Icon	Signification
	Fixed value operation		O ₂ /N ₂ control deactivated. No O ₂ concentration alarms will occur. (chamber with O ₂ control)
	Heating active		CO ₂ pressure alarm deactivated
	Key lock activated		O ₂ pressure alarm deactivated (chamber with O ₂ control)
	Copying data via USB		N ₂ pressure alarm deactivated (chamber with O ₂ control)
	Interior socket turned on (with option interior socket)		Power return after power failure or shut-down of the chamber

Icon	Notifying message	Signification
	DO NOT OPEN THE DOOR !	Hot air sterilization running
	STERILIZATION FINISHED	Hot air sterilization successful The inner chamber and parts inside can still be hot. Do not touch.
	STERILIZATION ABORTED	Hot air sterilization cancelled The inner chamber and parts inside can still be hot. Do not touch.

11.2 Alarm messages overview

Icon	Alarm message	Signification
	Safety controller overtemperature	Overtemperature safety controller alarm (class 3.1): selected value of the safety controller exceeded.
	Temp. range	Having reached the setpoint, the temperature deviates by more than the set tolerance range value (chap. 11.5.6) and longer than 10 min. from the setpoint or the temperature doesn't reach the tolerance range within 3 hours from turning on the chamber or closing the door
	CO ₂ range	Having reached the setpoint, the CO ₂ concentration deviates by more than the set tolerance range value (chap. 11.5.6) and longer than 10 min. from the setpoint or the CO ₂ concentration doesn't reach the tolerance range within 3 hours from turning on the chamber or closing the door
	O ₂ range	Having reached the setpoint, the O ₂ concentration deviates by more than the set tolerance range value (chap. 11.5.6) and longer than 10 min. from the setpoint or the O ₂ concentration doesn't reach the tolerance range within 3 hours from turning on the chamber or closing the door (chamber with O ₂ control)

Icon	Alarm message	Signification
	Door open	Door is open for more than the set alarm delay time (chap. 11.5.5, factory setting: 1 minute). Close the door.
	Low pressure CO2	Low CO ₂ outlet pressure (< 0.3 bar)
	Low pressure CO2	Low O ₂ outlet pressure (< 0.3 bar) (chamber with O ₂ control)
	Low pressure N2	Low N ₂ outlet pressure (< 0.3 bar) (chamber with O ₂ control)
	CO2 sensor defective	CO ₂ sensor defective. Contact BINDER Service.
	O2 sensor defective	O ₂ sensor defective. Contact BINDER Service.
	Inform service - adjust CO2 sensor	CO ₂ sensor adjustment required. Contact BINDER Service.

You can activate / deactivate the buzzer in the “Alarms” submenu (chap. 11.5.3).

With an activated buzzer there is an **audible alert** with an alarm. You can reset it in the “Alarms” submenu for alarm acknowledgement pressing the “Reset” button (chap. 11.4). The alarm symbol will only disappear when the cause of the alarm has been remedied.

The **zero-voltage relay alarm contact** (chap. 11.6) is activated in case of the alarm messages “door open” and deviations of temperature and gas concentrations) as well as in case of a power failure and turning off the chamber at its main power switch.

For appropriate actions in the event of an alarm, please refer to chap. 21 “Troubleshooting”.

11.3 Alarm status

An alarm message can appear in 3 different states:

“Set”

- Active alarm.
- The corresponding alarm icon is displayed in the initial view The buzzer sounds (if activated).
- The “Info” button in the initial view leads to the “Alarms” submenu for alarm acknowledgement.
- Press the “Reset” button in the “Alarms” submenu for alarm acknowledgement to mute the buzzer and confirm the alarm.

“Acknowledged”



- Active alarm.
- The alarm was acknowledged. The buzzer is off.
- The alarm cause is still valid. Therefore, the alarm icon remains displayed in the initial view.
- The alarm message figures in the list of active alarms.

“Cleared”

- The alarm cause has disappeared.
- The alarm icon is not displayed any longer
- The alarm message has disappeared from the list of active alarms.
- The alarm message remains in the “Event list” for information.

11.4 Confirming an active “set” alarm

Fixed value		08.03.2013 05:05:06	
		Setpoint	Actual value
Temperature	[°C]	37.0	39.2
CO2	[Vol.-%]	5.0	5.0
O2	[Vol.-%]	25.0	25.0

		
User	Info	Menu

Initial view with overtemperature safety controller alarm.
The buzzer sounds (if not deactivated previously).
Press the “Info” button.



Alarm acknowledgement		08.03.2013 05:05:06	
../Home/Alarms			
Safety controller overtemperature			

Close	Reset	Home
-------	-------	------

Submenu “Alarms” for alarm acknowledgement.

Press the “Reset” button to confirm the alarm. If there is another active “set” alarm, you can also confirm it with the “Reset” button. After confirming all active “set” alarms, the buzzer is off, and the initial view is displayed.

As long as an alarm is still active, i.e. as long as the alarm cause is still valid, the alarm icon continues to be displayed in the initial view.

11.5 Alarm configuration and overview

To access the alarm lists and configuration menu, go to [Menu > Alarms](#)

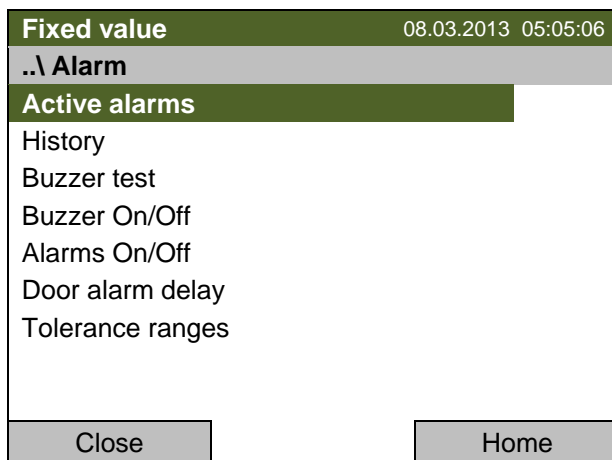

Submenu "Alarm".
Select the desired function
and press the operating button.

Active Alarms	List of the alarms with status "set" or "acknowledged".
History	List of all alarms (status "set" or "acknowledged" or "cleared")
Buzzer test	Testing the alarm buzzer, chap. 11.5.3
Buzzer On/Off	Activating / deactivating the alarm buzzer, chap. 11.5.3
Alarms On/Off	Activating / deactivating the alarm functions. Off: Alarm buzzer off, no alarm icons displayed.
Door alarm delay	Entering the delay time of the door alarm
Tolerance ranges	Defining the tolerance ranges and alarm delay times for the individual parameters

11.5.1 List of active alarms

To access the overview list of active alarms, go to [Menu > Alarms > Active alarms](#)

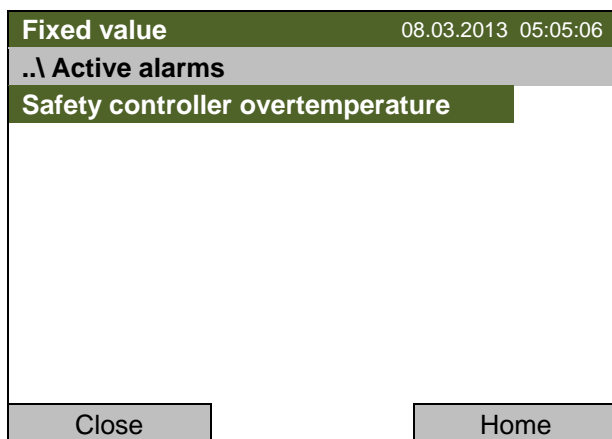

Submenu "Active alarms".
All active alarms with status "set" or "acknowledged",
are listed.

If no alarm is active ("set" or "acknowledged"), no message will be displayed in this window.

11.5.2 History – list of all alarms

To access the overview list of all alarms, go to [Menu > Alarms > History](#)

This list indicates the moment when an alarm was set and when cleared.

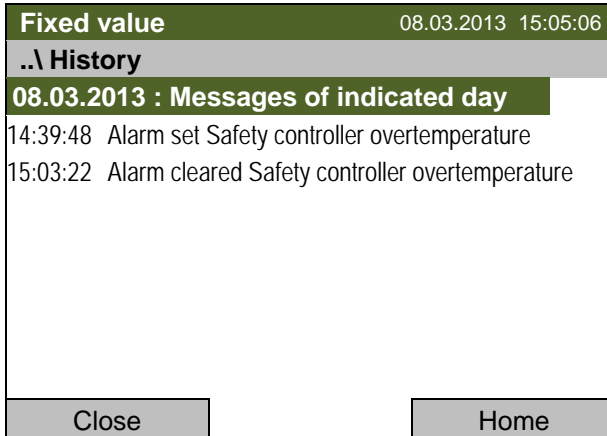

Fixed value 08.03.2013 15:05:06

..\ History

08.03.2013 : Messages of indicated day

14:39:48 Alarm set Safety controller overtemperature
15:03:22 Alarm cleared Safety controller overtemperature

Close Home

Submenu “History” (example).

The list shows when the alarms of the current day were triggered and when cleared. The most recent message appears at the end of the list.

The information that an alarm has been acknowledged is shown in the event list.

When there is more information than one page, you can scroll the list in both directions with the operating button.

To select a different date, select “Messages of indicated day” and press the operating button. You can enter the desired date through an entry menu.

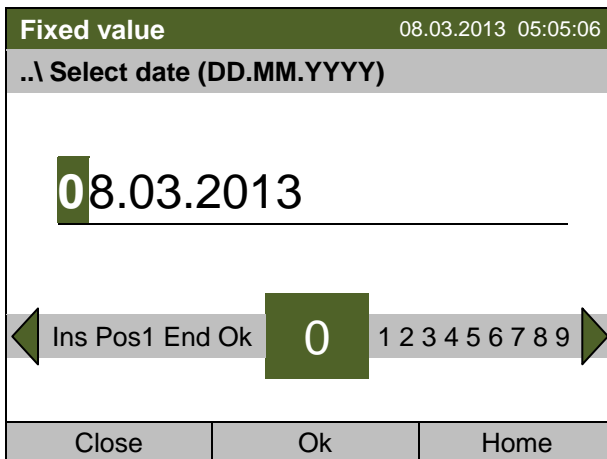

Fixed value 08.03.2013 05:05:06

..\ Select date (DD.MM.YYYY)

08.03.2013

◀ Ins Pos1 End Ok **0** 1 2 3 4 5 6 7 8 9 ▶

Close Ok Home

Entry menu “Select date”.

The current date is shown. Enter the desired date with the operating button.

Press the “Ok” button to confirm.

The alarm list of the selected date is displayed.

The entire sequence of the alarm events (set – acknowledged – cleared) is shown in the event list (chap. 12).

To access the event list, go to [Menu > Event list](#) or [User > Show event list](#)

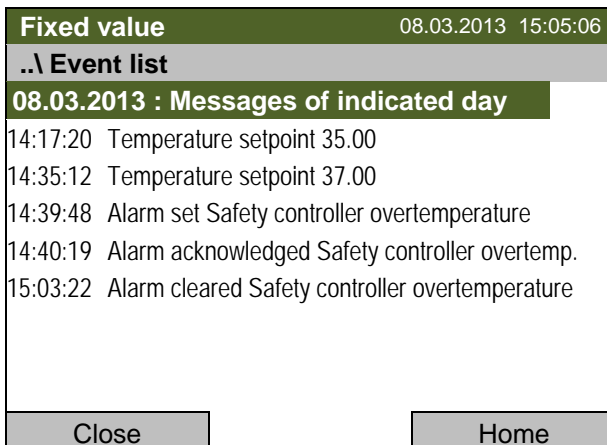

Fixed value 08.03.2013 15:05:06

..\ Event list

08.03.2013 : Messages of indicated day

14:17:20 Temperature setpoint 35.00
14:35:12 Temperature setpoint 37.00
14:39:48 Alarm set Safety controller overtemperature
14:40:19 Alarm acknowledged Safety controller overtemp.
15:03:22 Alarm cleared Safety controller overtemperature

Close Home

Submenu “Event list” (example).

The events and alarm messages of the current day are displayed. The most recent message appears at the end of the list.

11.5.3 Activating, deactivating, and testing the alarm buzzer

Alarm buzzer test

To access the alarm buzzer functional test, go to [Menu > Alarms > Buzzer test](#)

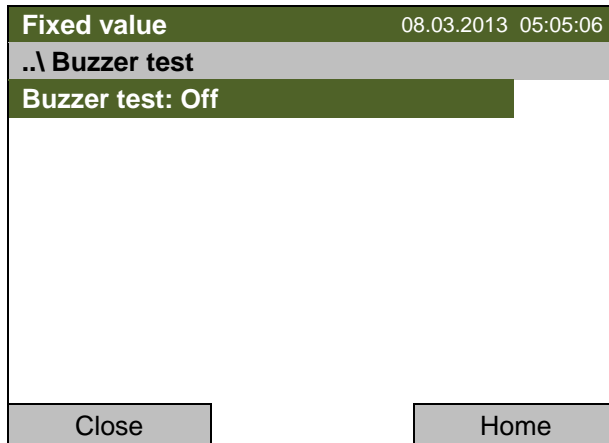

Submenu "Buzzer test".

The current setting is displayed.

Press the operating button to turn on or off the buzzer for test purpose.

The modified setting is displayed.

"Buzzer test: On" = Buzzer turns on

"Buzzer test: Off" = Buzzer turns off

When turned on, the alarm buzzer emits an intermittent signal. To turn this off, change the test function to "Buzzer test: Off".

Activating / deactivating the alarm buzzer

To activate or deactivate the alarm buzzer, go to [Menu > Alarms > Buzzer On/Off](#)

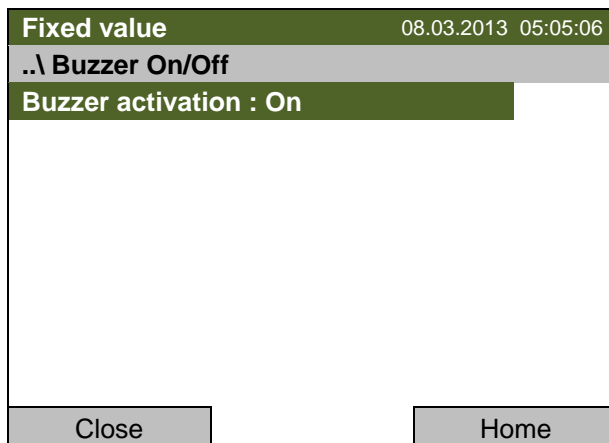

Submenu "Buzzer On/Off".

The current setting is displayed.

To change the setting, press the operating button.

The modified setting is displayed.

"Buzzer activation: On" = Buzzer will turn on in the event of an alarm

"Buzzer activation: Off" = Buzzer is deactivated

11.5.4 Activating / deactivating all alarm functions

To access the alarm function setting, go to [Menu > Alarms > Alarms On/Off](#)

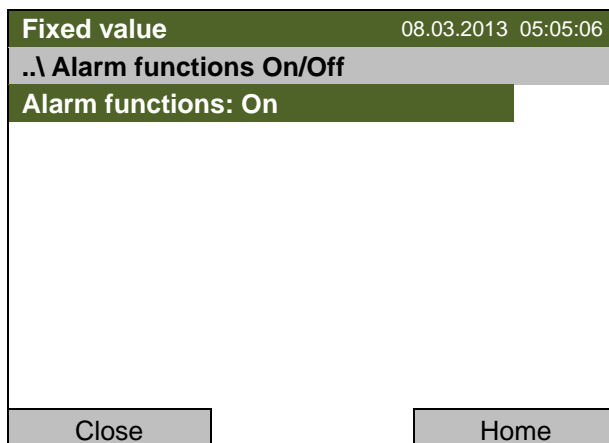

Submenu "Alarm functions On/Off".

The current setting is displayed.

To change the setting, press the operating button.

The modified setting is displayed.

"Alarm functions: On" = The alarm functions of the controller are active

"Alarm functions: Off" = All alarm functions are deactivated

11.5.5 Setting the delay time after opening the door

To enter the delay time for the door open alarm, go to [Menu > Alarms > Door alarm delay](#)

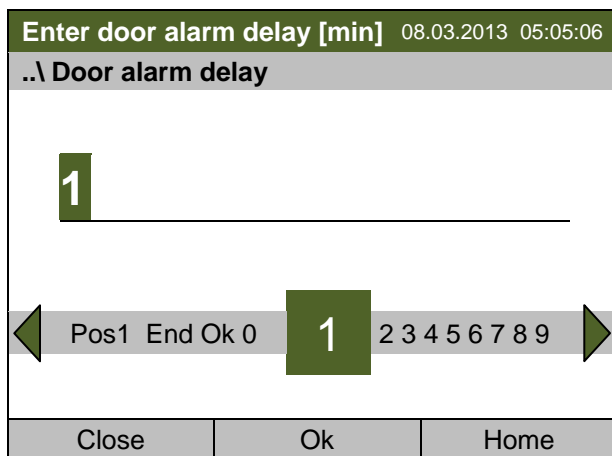

Entry menu "Door alarm delay"
 Enter the desired delay time in minutes with the operating button.
 Setting range: 1 up to 999
 Press the "Ok" button to confirm.

When entering a value outside the setting range, the message "invalid value" appears. Press the operating button to confirm with "Ok" and repeat the entry with a correct value.

11.5.6 Tolerance ranges and alarm delay times

For **temperature**, **CO₂**, and **O₂** you can enter a value which defines a tolerance range around the setpoint value. Example: Temperature setpoint: 37 °C, tolerance range value: ±2 °C, i.e. this defines a tolerance range from 35 °C up to 39 °C. If the actual value, after having reached the setpoint, deviates by more than the set tolerance range value and longer than 10 min. from the setpoint **or** the temperature doesn't reach the tolerance range within 3 hours from turning on the chamber or closing the door, tolerance alarm is triggered.

To define the tolerance ranges and the alarm delay times for the individual parameters, go to [Menu > Alarms > Tolerance ranges](#)

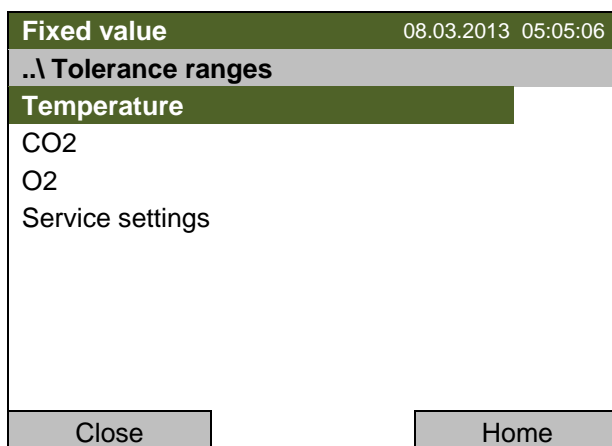

Submenu "Tolerance ranges".
 Select the desired parameter and press the operating button.

Temperature

First you can enter the desired value of the temperature tolerance range:

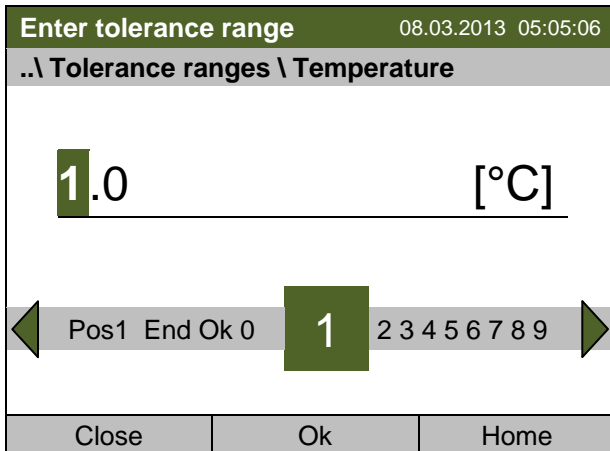

Entry menu "Temperature".
Enter the desired value of the temperature tolerance range with the operating button.
Setting range: 0 up to infinite
Press the "Ok" button to confirm.

When entering a value outside the setting range, the message "invalid value" appears. Press the operating button to confirm with "Ok" and repeat the entry with a correct value.

Then you can enter the delay time for the temperature tolerance range alarm:

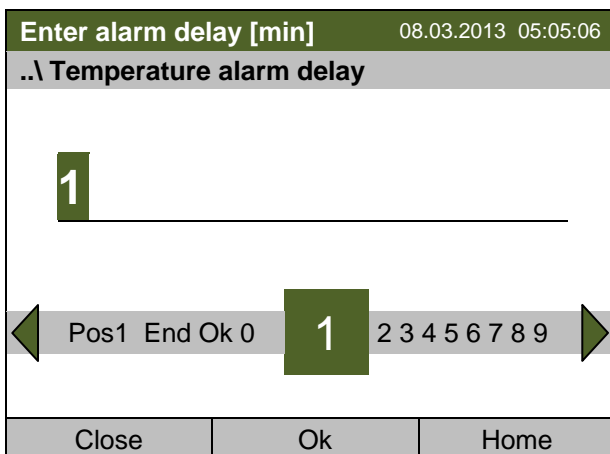

Entry menu "Temperature alarm delay"
Enter the desired delay time in minutes with the operating button.
Setting range: 0 up to infinite
Press the "Ok" button to confirm.

When entering a value outside the setting range, the message "invalid value" appears. Press the operating button to confirm with "Ok" and repeat the entry with a correct value.

CO₂

First you can enter the desired value of the CO₂ tolerance range:

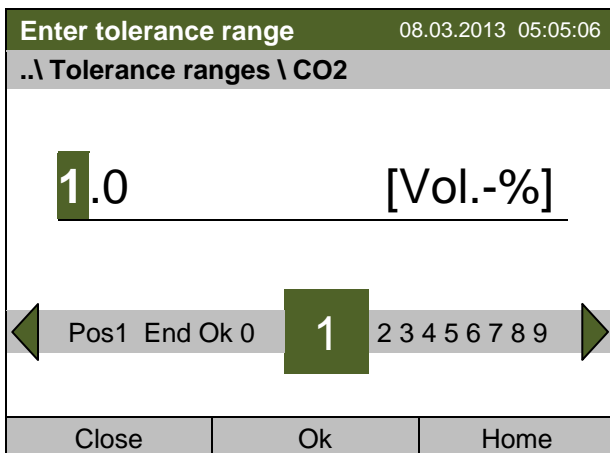

Entry menu "CO2".
Enter the desired value of the CO₂ tolerance range with the operating button.
Setting range: 0 vol.-% up to 100 vol.-%
Press the "Ok" button to confirm.

When entering a value outside the setting range, the message "invalid value" appears. Press the operating button to confirm with "Ok" and repeat the entry with a correct value.

Then you can enter the delay time for the CO₂ tolerance range alarm:

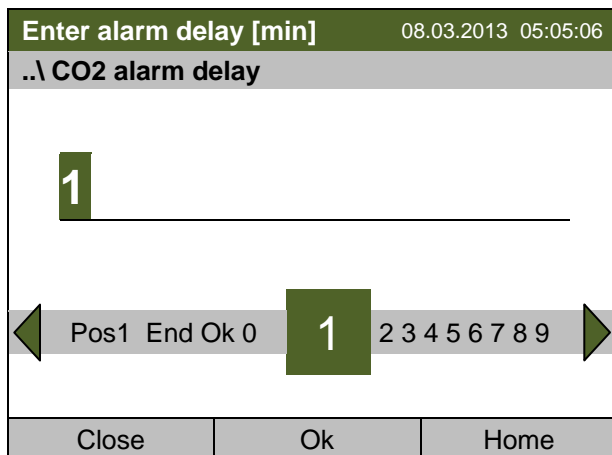

Entry menu "CO₂ alarm delay"
 Enter the desired delay time in minutes with the operating button.
 Setting range: 0 up to infinite
 Press the "Ok" button to confirm.

When entering a value outside the setting range, the message "invalid value" appears. Press the operating button to confirm with "Ok" and repeat the entry with a correct value.

O₂ (chamber with O₂ control)

First you can enter the desired value of the CO₂ tolerance range:

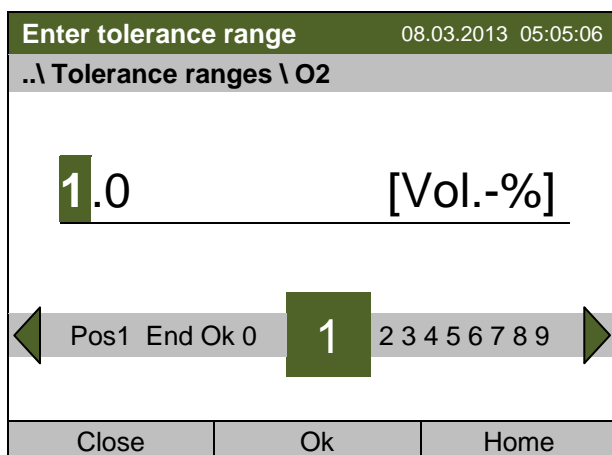

Entry menu "O₂".
 Enter the desired value for the O₂ tolerance range with the operating button.
 Setting range: 0 vol.-% up to 100 vol.-%
 Press the "Ok" button to confirm.

When entering a value outside the setting range, the message "invalid value" appears. Press the operating button to confirm with "Ok" and repeat the entry with a correct value.

Then you can enter the delay time for the O₂ tolerance range alarm:

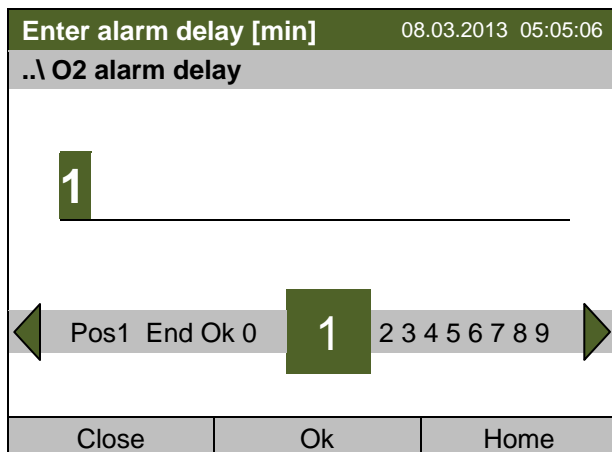

Entry menu "O₂ alarm delay"
 Enter the desired delay time in minutes with the operating button.
 Setting range: 0 up to infinite °C
 Press the "Ok" button to confirm.

When entering a value outside the setting range, the message "invalid value" appears. Press the operating button to confirm with "Ok" and repeat the entry with a correct value.

Go back to the initial view with "Home".

Service settings

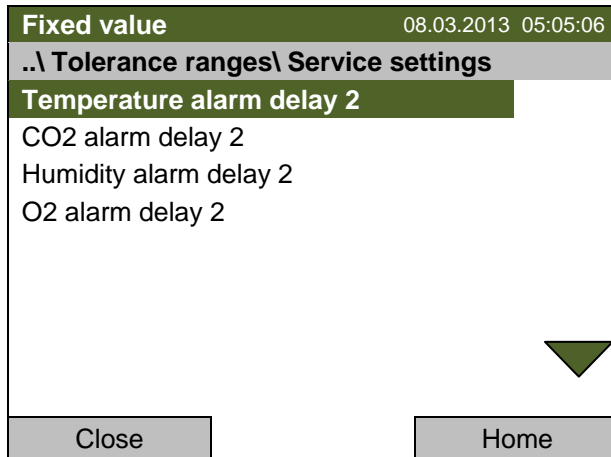

Submenu "Service settings".

Access to the following submenus is password-protected and for service purpose only.

11.6 Zero-voltage relay alarm output

The chamber is equipped with a zero-voltage relay output which permits the transmission of some alarm messages to a central monitoring system.

The connection is realized as a DIN socket (9) on the chamber rear. A suitable DIN plug is enclosed.

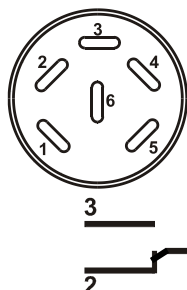

Figure 17: Pin configuration of the DIN socket (9) on the chamber rear

Pin 1: Pole, Pin 2: Break relay, Pin 3: Make contact

In case there is no alarm, contact 1 closes with contact 3.

Closing contact 1 with contact 2 switches the zero-voltage relay alarm output.

Maximum loading capacity of the switching contacts: 24V AC/DC – 2.5A

	DANGER
	<p>Electrical hazard. Danger of death. Damage to switching contacts and connection socket.</p> <ul style="list-style-type: none"> ⊘ Do NOT exceed the maximum switching load of 24V AC/DC – 2.5A. ⊘ Do NOT connect any devices with a higher loading capacity.

The zero-voltage relay alarm output switches at the following events:

Displayed icon	Error / event when icon is displayed	Switching the alarm contact
	Power failure	immediately
	Tolerance range alarm of temperature, CO ₂ , or O ₂ (chamber with O ₂ control)	after 10 min from error
	Door open for more than the set alarm delay time (chap. 11.5.5, factory setting: 1 minute)	after 10 minutes from door opening

In case of a tolerance range alarm or a door open alarm, the alarm message on the controller display remains on during the alarm transmission via the zero-voltage relay outputs.

As soon as the cause of the alarm is identified and resolved, you can reset the alarm transmission via the zero-voltage relay outputs together with the alarm message on the controller display by hitting the “RESET” key.

In case of a power failure, transmission of the alarm via zero-voltage relay outputs remains active for the duration of the power failure. After power returns, contact 1 closes automatically with contact 3.

	<p>When using the communication software APT-COM™ 3 DataControlSystem (option, chap. 15.1) via the Ethernet interface or optional RS 422 interface of the chamber for data acquisition, only the alarm message is recorded in the APT-COM™ 3 protocol.</p> <ul style="list-style-type: none"> ➤ Set the tolerance limits for limit alarms by APT-COM™ 3 separately in the APT-COM™ 3 measuring window.
--	---

12. Event list

The “Event list” displays status information and errors of the current day. You can also access the events of past days.

To access the event list, go to [Menu > Event list](#) or [User > Show event list](#)

Fixed value		08.03.2013 15:05:18
..\ Event list		
08.03.2013 Messages of indicated day		
14:17:20 Temperature setpoint 35.00		
14:35:12 Temperature setpoint 37.00		
14:39:48 Alarm set Safety controller overtemperature		
14:40:19 Alarm acknowledged Safety controller overtemp.		
15:03:22 Alarm cleared Safety controller overtemperature		
Close	Reset	Home

Submenu “Event list” (example).

The events of the current day are displayed. The most recent message appears at the end of the list.

If you want to acknowledge an active alarm, proceed as described in chap. 11.4.

When there is more information than one page, you can scroll the event list in both directions with the operating button.

To select a different date, select “Messages of indicated day” and press the operating button. You can enter the desired date through an entry menu.

Fixed value		08.03.2013 05:05:06
..\ Select date		
08.03.2013		
◀	Ins Pos1 End Ok	0 1 2 3 4 5 6 7 8 9 ▶
Close	Ok	Home

Entry menu “Select date”.

The current date is shown. Enter the desired date with the operating button.

Press the “Ok” button to confirm.

The event list of the selected date is displayed.

13. Graphical display of the measured values

To access the graphical display, go to [Menu > Measurement chart](#)

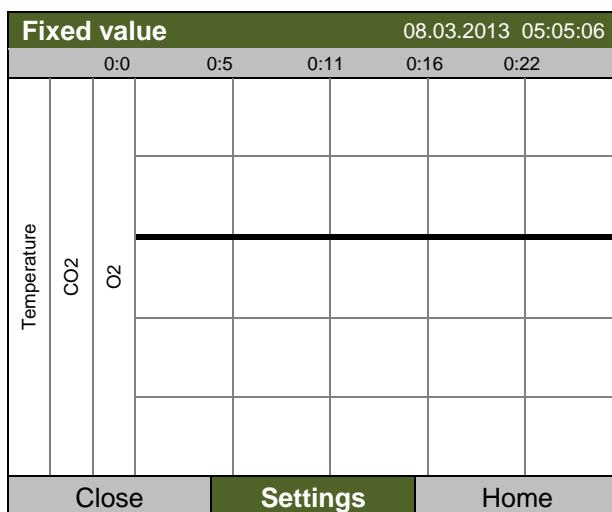

Measurement chart view (sample view).
Press the "Settings" button.

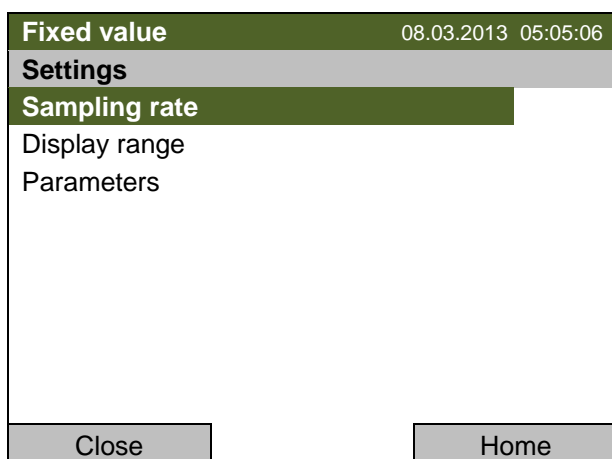

Submenu "Settings".
Select the desired function
and press the operating button.

13.1 Setting the sampling rate

To define the sampling rate, go to [Menu > Measurement chart > Settings > Sampling rate](#)

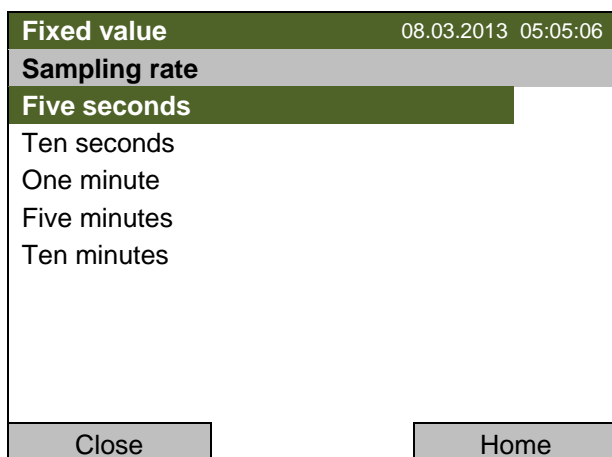

Submenu "Sampling rate".
Select the desired interval
and press the operating button.

13.2 Defining the display range

To define the display range, go to [Menu > Measurement chart > Settings > Display range](#)

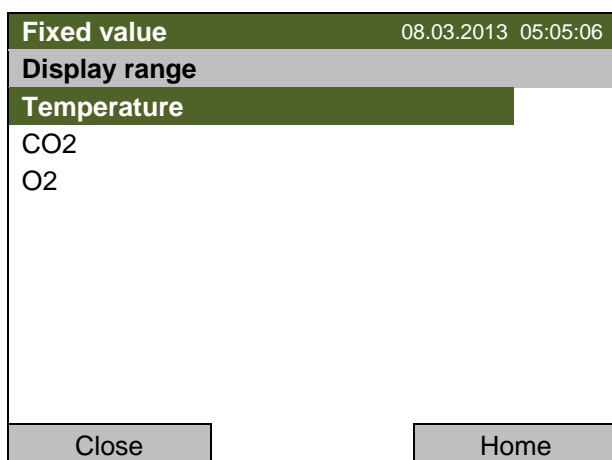

Submenu “Display range” (unit with O₂ control).
Select the desired parameter
and press the operating button.

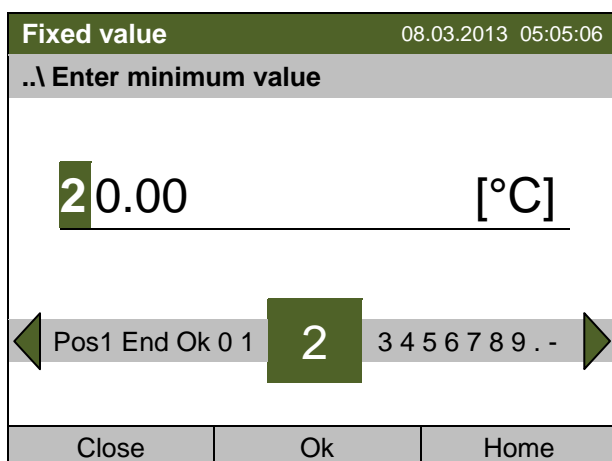

Entry menu for temperature “Enter minimum value”.
Enter the desired value with the operating button
and press the operating button to confirm.

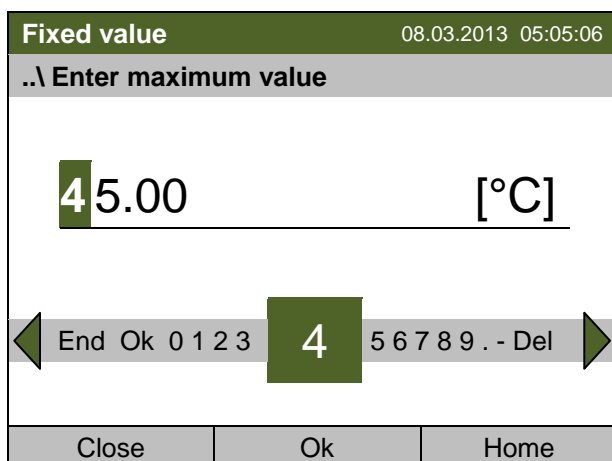

Entry menu for temperature “Enter maximum value”.
Enter the desired value with the operating button
and press the operating button to confirm.

You can now define the view range of the other parameters or press the “Close” button twice to go back to the graphic display.

13.3 Selecting the parameters

Here you can select the parameters, which shall be displayed graphically. To select the parameters, go to [Menu > Measurement chart > Settings > Parameters](#)

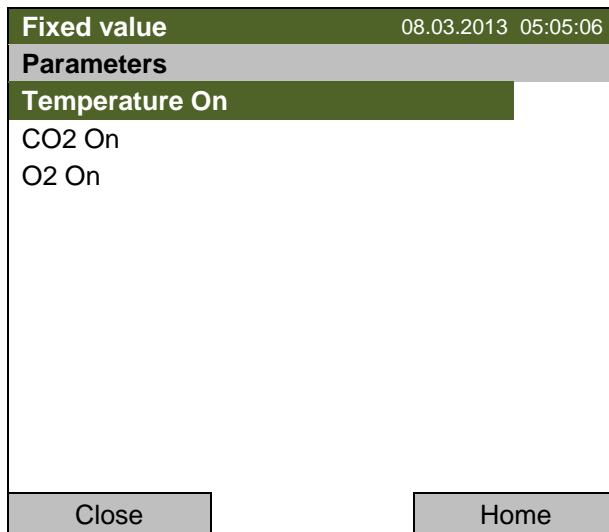

Submenu "Parameters" (chamber with O₂ control).
 The current setting for each parameter is displayed.
 Select the desired parameter
 and press the operating button to change its status
 On/Off.
 The modified setting is displayed.

Press the "Close" button twice to go back to the graphic display. If any parameter was set to "Off", it will not be included in the graphical display.

14. Temperature safety devices

14.1 Overtemperature protective device (class 1)

The chamber is equipped with an internal temperature safety device, class 1 acc. to DIN 12880. It serves to protect the chamber and prevents dangerous conditions caused by major defects.

If the actual temperature exceeds the nominal temperature by approx. 10 °C, the over temperature protective device permanently turns off the chamber. The user cannot restart the device again. The protective cut-off device is located internally. Only a service specialist can replace it. Therefore, please contact an authorized service provider or BINDER Service.

14.2 Overtemperature safety controller (temperature safety device class 3.1)

The chamber is regularly equipped with an electronic overtemperature safety controller (temperature safety device class 3.1 according to DIN 12880).

The overtemperature safety controller serves to protect the chamber, its environment and the contents from exceeding the maximum permissible temperature. In the case of an error, it limits the temperature inside the chamber to the entered safety controller setpoint.

Please observe the guideline BGI/GUV-I 850-0 on safe working in laboratories (formerly BGR/GUV-R 120 or ZH 1/119 laboratory guidelines issued by the employers' liability insurance association) (for Germany).

Set the safety controller setpoint by approx. 2 °C above the desired temperature setpoint. Recommended setting: Setpoint type "Offset" with safety controller setpoint 2 °C (factory setting).

The safety controller is functionally and electrically independent of the temperature control system. If an error occurs, it performs a regulatory function.

	Check the setting regularly and adjust it following changes of the setpoint or charge.
---	--

	During a running sterilization (chap. 18.3) the safety controller is non-functional
---	---

14.2.1 Safety controller modes

You can select between "Limit (absolute)" and "Offset (relative)" safety controller mode

- **Limit:** Absolute maximum permitted temperature value

Example:

This setting offers high safety as a defined temperature limit will not be exceeded. It is important to adapt the safety controller setpoint after each modification of the temperature setpoint. Otherwise, the limit could be too high to ensure efficient protection, or, in the opposite case, it could prevent the controller from reaching an entered setpoint outside the limit range.

- **Offset:** Maximum overtemperature above any active temperature setpoint. The maximum temperature changes internally and automatically with every setpoint change.

It is important to check the safety controller setpoint and safety controller mode occasionally, as it does not offer a fix, independent limit temperature value, which would never be exceeded.

Example: Desired temperature value 37 °C, desired safety controller value: 39 °C

Possible settings:

Temperature setpoint	Safety controller mode	Safety controller setpoint
37 °C	Limit (absolute)	39 °C
	Offset (relative)	2 °C

14.2.2 Setting the safety controller

To display and to change the current safety controller settings in the “safety controller” submenu, go to [Menu > Safety controller](#)

Safety controller mode: selection between Limit (absolute) and Offset (relative)

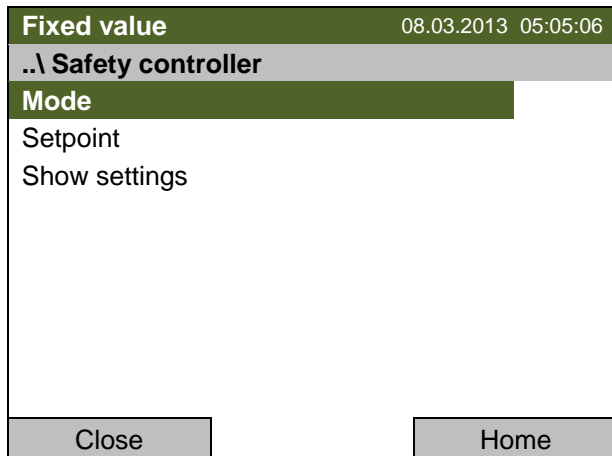

Submenu “Safety controller”
Select “Mode”
and press the operating button.

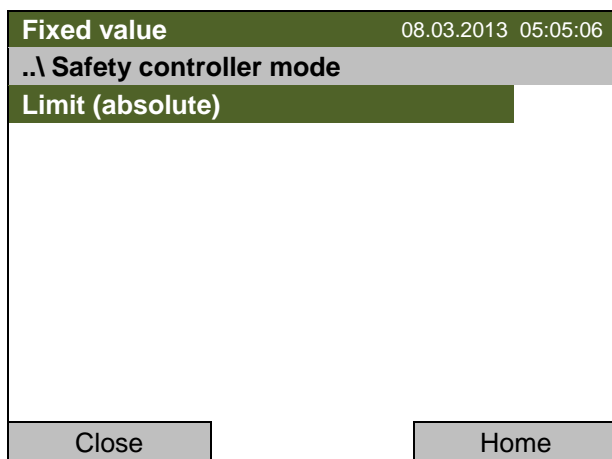

Submenu “Safety controller mode”.
The current safety controller mode is displayed:
“Limit (absolute)” or “Offset (relative)”
To change the mode, press the operating button.
The modified safety controller mode is displayed.



When changing the safety controller mode, the safety controller setpoint which had been active before in this mode becomes active again.

Entering the safety controller setpoint

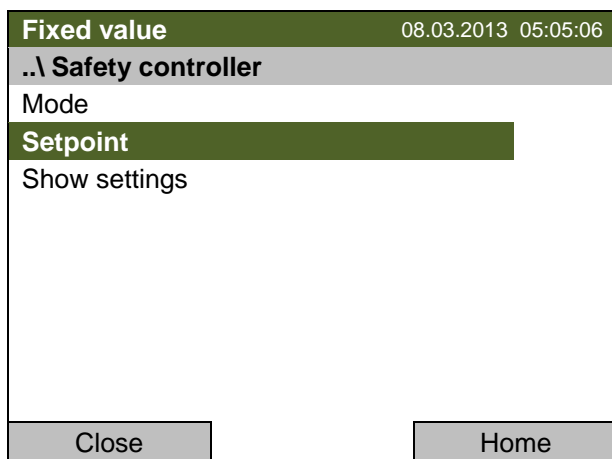

Submenu “Safety controller”
Select “Setpoint”
and press the operating button.

You can also access this submenu to directly enter the safety controller setpoint via [Quick menu > Safety controller setpoint](#)

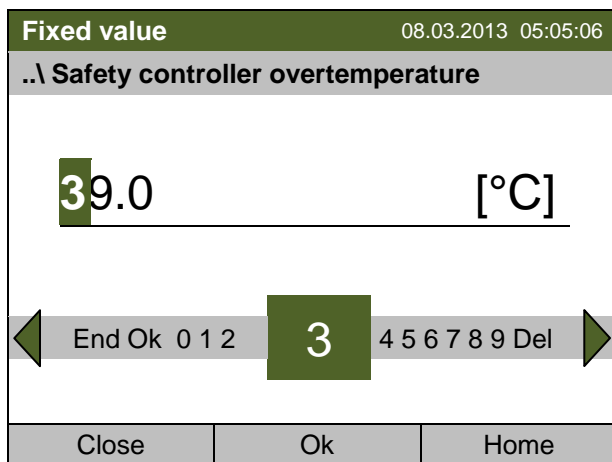

Entry menu "Safety controller overtemperature".
Enter the desired value with the operating button and press the operating button to confirm.
Press the "Ok" button to confirm.

Go one level back with the "Close" button or back to the initial view with "Home".

Overview of the current settings

You can check the current settings of the safety controller:

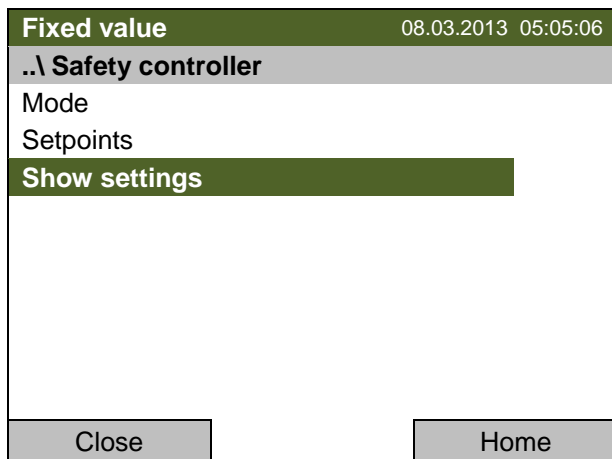

Submenu "Safety controller"
Select "Show settings"
and press the operating button.

The overview display shows the setpoints and actual values of the main temperature controller and the safety controller and indicates the safety controller mode.

Fixed value		08.03.2013 05:05:06	
.. \ Safety controller			
		Setpoint	Actual value
Chamber temperature [°C]	37.0	37.6	
Safety controller mode	Limit (absolute)		
Safety controller [°C]	39.0	37.6	
Close		Home	

Overview display with "Limit" mode
(example values)

Fixed value		08.03.2013 05:05:06	
	Setpoint	Actual value	
Chamber temperature [°C]	37.0	37.6	
Safety controller mode	Offset (relative)		
Safety controller [°C]	2.0	37.6	
Close		Home	

Overview display with "Offset" mode (example values)

Go back to the initial view with "Home".

15. Options

15.1 Communication software APT-COM™ 3 DataControlSystem (option)

The chamber is regularly equipped with an Ethernet interface (6) that can connect the BINDER communication software APT-COM™ 3 DataControlSystem. The MAC Address is indicated below the Ethernet interface. The actual temperature, and gas concentration values are given in adjustable intervals. Up to 40 chambers can be cross linked. For further information, refer to the operating manual of the BINDER communication software APT-COM™ 3.

15.2 RS 422 interface (option)

With this option, the chamber is equipped with a serial interface RS 422 (5), that can connect the BINDER communication software APT-COM™ 3 DataControlSystem. The MAC Address is indicated below the Ethernet interface. The actual temperature, and gas concentration values are given in adjustable intervals. For further information, refer to the operating manual of the BINDER communication software APT-COM™ 3.

The connection to a computer is established using the CB interface via an interface converter.

Pin allocation of the RS 422 interface (5) on the chamber rear	Pin 2:	RxD (+)
	Pin 3:	TxD (+)
	Pin 4:	RxD (-)
	Pin 5:	TxD (-)
	Pin 7:	Ground

15.3 Silicone access ports 30 mm / 1.18 in, closable from both sides with silicon plugs (option)

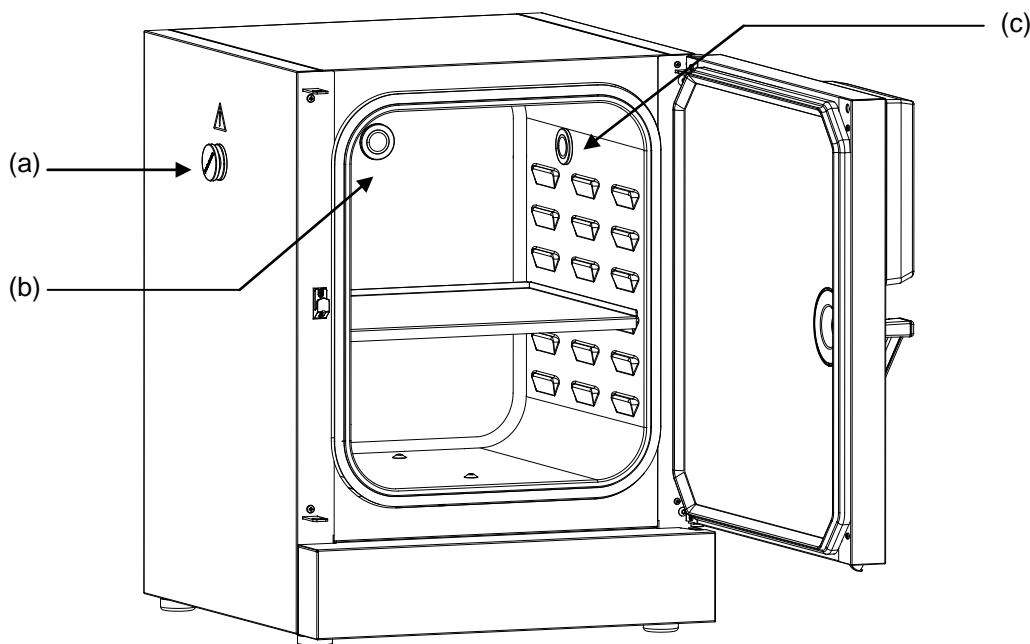







Figure 18: Positions of the optional silicon access ports left (a), rear (b), and right (c)

A warning sticker is located above each access port.

When operating a CB with silicon access ports, both silicon plugs must tightly close the access ports. If the plugs are inserted in a not-gastight manner, or if plugs are missing, CO₂ / O₂ / N₂ gas (chamber with O₂ control) may escape into the environment. The CO₂ control and the O₂ control (chamber with O₂ control) only turn off when the chamber door is opened.

	 WARNING
	<p>High concentration of CO₂ (> 4 Vol.-%). Risk of death by suffocation. Danger of poisoning.</p> <p>➤ Tightly close each access port with two plugs during operation.</p>

Note for chambers with O₂ control:

 	 WARNING
	<p>High concentration of O₂ (> 21 % O₂). Fire and explosion hazard through contact of combustible materials with O₂. Risk of burns and other injuries.</p> <p>➤ Tightly close each access port with two plugs during operation.</p>

15.4 Interior socket 230V (option)

	<p>The T4.12 controller permits turning on and off the voltage of the interior socket (chap. 6.5).</p>
---	--

The interior socket (G) is located at the upper left corner on the rear wall of the inner chamber. It is closed with a waterproof lid. The interior socket is suitable to supply electrical devices inside the chamber with 230V AC voltage.

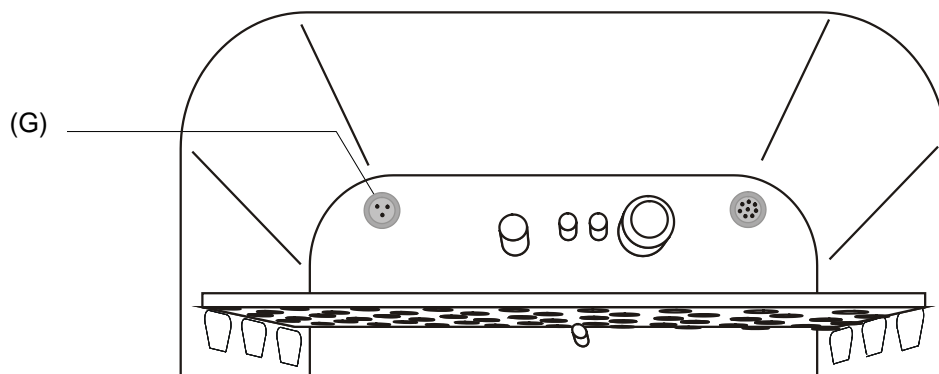



Figure 19: Position of the interior socket 230 V

(G) Interior socket

The maximum head load must not exceed a capacity of 20 W.

	CAUTION
	<p>Exceeding the setpoint temperature. Damage to the cultures.</p> <p>⊘ Do NOT exceed the maximum head load of 20 W. ⊘ Do NOT connect equipment with a nominal capacity > 20 W.</p>

	Heat emission of electrical devices connected inside the CO ₂ incubator may modify the temperature range.
--	--

The maximum load must not exceed 3 Amp.

	WARNING
	<p>Overload of contacts. Damage to contacts and connection socket. Electrical hazard. Danger of death.</p> <ul style="list-style-type: none"> ⊘ Do NOT exceed the maximum load of 3 A. ⊘ Do NOT connect any devices with a nominal current > 3 A.

Turning on and off the voltage of the interior socket is possible at the chamber controller through [Menu > Interior socket \(optional\)](#), see chap. 6.5.

Turning off the chamber at the main power switch also switches the interior socket voltage-free.

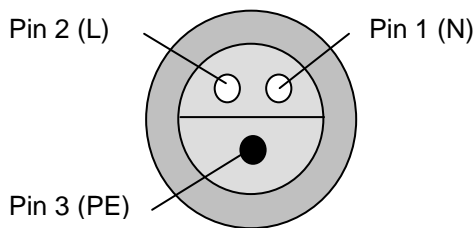

Figure 20: Interior socket (G) (front view)

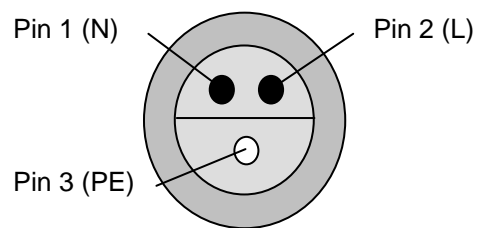

Figure 21: Supplied plug (front view)

Electrical data socket and plug: IP system of protection 65, 230 V 1N ~ 50-60 Hz

	CAUTION
	<p>Risk of short circuit. Damage to the chamber.</p> <ul style="list-style-type: none"> ➤ Use delivered plug only (IP protection type 65). ➤ If the socket is not used, close it with the waterproof lid.

When inserting a heat load into the inner chamber by introducing electrical devices such as shakers or rollers, the ambient temperature of the incubator must not exceed 25 °C / 77°F. Otherwise, temperature control to 37 °C / 98.6°F cannot be assured. When operating electrical devices inside the incubator, always check the desired incubation temperature **before** introducing any cells.

	CAUTION
	<p>Excessive inner temperature > 37 °C / 98.6°F when operating electrical devices inside the incubator. Damage to the cell cultures.</p> <ul style="list-style-type: none"> ➤ When operating electrical devices inside the incubator: Ambient temperature ≠ 25 °C / 77°F. ➤ Check the temperature observation before introducing any cells.

15.5 Analog outputs for temperature and CO₂ (option)

With this option, the chamber is equipped with analog outputs 4-20 mA for temperature and CO₂. These outputs allow transmitting data to external data registration systems or devices.

The connection is realized as a DIN socket (3) on the chamber rear. A suitable DIN plug is enclosed.

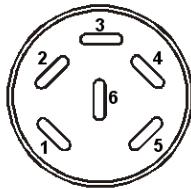

ANALOG OUTPUT 4-20 mA DC

PIN 1: Temperature +
 PIN 2: Temperature -
 PIN 3: CO₂ +
 PIN 4: CO₂ -

CO₂ range: 0 vol.-% up to 20 vol.-%
 Temperature range: 0 °C / 32°F up to +200 °C / 392°F

Figure 22: Pin configuration of the DIN socket (3) on the chamber rear

15.6 Access port for extra-low voltage (option)

The access port (B) (8-pin) for extra-low voltage (ELV) consists of a LEMO socket (which can be covered) and a LEMO connector. It is suitable to connect two electrical devices, one inside and one outside the incubator. You can use it e.g. for devices with a monitoring and control part remaining outside the incubator, whereas its mechanical component like roller or shaker systems is located inside the chamber.

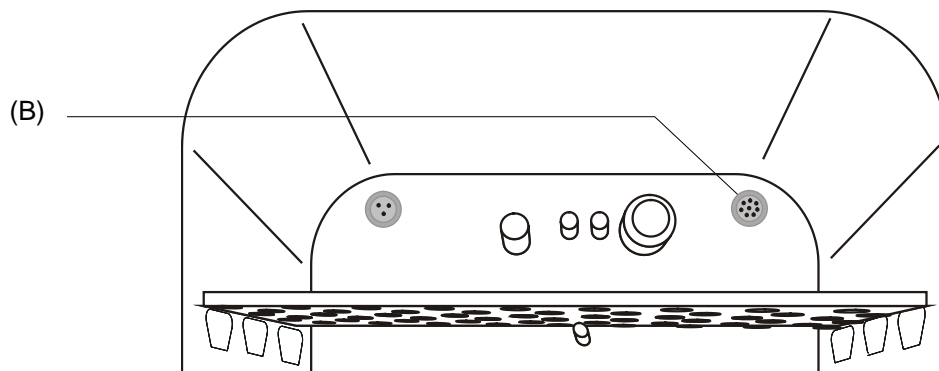



Figure 23: Position of the access port for extra-low voltage

Maximum power rating 24V AC/DC 2Amp.

	 WARNING
	<p>Overload of contacts. Damage to contacts and connection socket. Electrical hazard. Danger of death.</p> <ul style="list-style-type: none"> ⊘ Do NOT exceed the maximum load of 24V AC/DC 2Amp. ⊘ Do NOT connect any devices with a nominal current > 2 Amp. ⊘ Do NOT connect any devices with a nominal voltage > 24 V DC.



		
<p>On chamber rear: Exterior Lemo socket (8) on the rear of the chamber</p>	<p>Interior: LEMO socket (B) located at the upper right corner of the rear wall of the inner chamber</p>	<p>Supplied LEMO connector: on external and internal side</p>

Figure 24: Pin allocation (front view) of the Lemo sockets and plug

When introducing a heat load into the inner chamber by inserting electrical devices like shakers or rollers, the ambient temperature of the incubator must not exceed 25 °C / 77°F. Otherwise, temperature control to 37 °C / 98.6°F cannot be assured. When operating electrical devices inside the incubator, always check the desired incubation temperature **before** introducing in any cells.

	<p>CAUTION</p>
	<p>Excessive inner temperature > 37 °C / 98.6°F when operating electrical devices inside the incubator. Damage to the cell cultures.</p> <ul style="list-style-type: none"> ➤ When operating electrical devices inside the incubator: Ambient temperature ≤ 25 °C / 77°F. ➤ Before introducing any cells, check the correct ambient temperature.

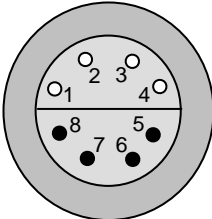
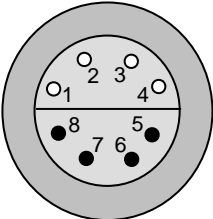
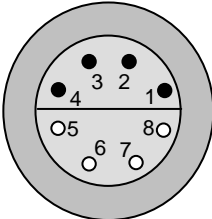
15.7 BINDER Gas Supply Service – External bottle changer for CO₂, N₂ or O₂ (option)

The external bottle changer permits automatic switching to a second gas cylinder as soon as the first cylinder is empty. It can be used for a maximum of two CB chambers.

	<p>Instructions 7001-0196 delivered with the external bottle changer (Art. no. 8012-0408) describe its installation and operation.</p>
---	--

15.8 Stands

15.8.1 Stacking stand (option)

We recommend not stacking CB incubators directly on top of one another in order to avoid transmission of shocks and vibrations from one chamber to the other. This could happen e.g. while opening or closing the door, cleaning, charging and discharging the chamber. BINDER offers stable, vibration-free stands with castors (2 lockable by brakes) for the safe stacking of two chambers.

The stacking stand ensures that the set incubation parameters are precisely maintained also during sterilization of the other chamber in the same stacking stand (chap. 18.3) by thermal decoupling.

Using the stacking stand offers more advantages: You can pull the lower chamber forward separately (e.g., for access to the rear), and not have to place it directly on the floor (important for sanitary purpose).



The mounting instructions 7001-0194 delivered with the stacking stand describe its installation (Art. No. 9051-0020 for CB 160, Art. No. 9051-0023 for CB 220).

15.8.2 Stacking adapter for direct thermal decoupled stacking (option)

We recommend not stacking CB incubators directly on top of one another in order to avoid transmission of shocks and vibrations from one chamber to the other. This could happen e.g. while opening or closing the door, cleaning, loading and unloading the chamber. BINDER offers a stacking adapter for direct thermal decoupled stacking of two chamber.

The stacking adapter ensures the exact maintenance of the set incubation parameters also during sterilization of the other chamber in the same stacking stand (chap. 18.3).



The mounting instructions 7001-0145 delivered with the stacking adapter describe its installation (Art. No. 9051-0032 for CB 60, Art. No. 9051-0026 for CB 160, Art. No. 9051-0030 for CB 220).

15.8.3 Base on castors (option)

In order to obtain easy access to the chamber and to avoid contamination of the chamber caused by soil pollution, BINDER recommends using the base on castors.



The mounting instructions 7001-0147 delivered with the base on castors describe its installation (Art. No. 9051-0031 for CB 60, Art. No. 9051-0028 for CB 160, Art. No. 9051-0029 for CB 220).

16. Reference measurements

Reference measurements of the temperature, CO₂, and O₂ (chamber with O₂ control) can be performed via the silicone measuring port (N) located on the inner glass door. Reference temperature measurements always take place under equilibrated conditions with both doors closed.

16.1 CO₂ reference measuring

There are three possibilities to perform CO₂ test measurements between the recommended annual maintenance procedures. To test the CO₂ concentration inside an incubator, see chapters 16.1.1 to 16.1.3.

16.1.1 Measuring CO₂ concentration indirectly via the pH of the cell medium

By using the indirect determination of CO₂ concentration via the pH-value of the nutrient, it is possible to check the CO₂ concentration inside the chamber. This is a simple method to test the correct CO₂ concentration without any special CO₂ measuring equipment. You need only use an accurate pH indicator or a pH-measuring electrode, which are standard equipment in cell culture laboratories.

This method is based on the acid base equilibrium of the buffer system in the culture media. NaHCO₃ buffers the common media. From the pH value of the medium, it is possible to conclude its CO₂ concentration. Figure 25 shows the relationship between CO₂ concentration in vol.-% and the pH of different NaHCO₃ buffered media.



These test systems are not suitable for calibrating the BINDER sensor system.

Recommended procedure:

- Incubate an empty sample with medium for 1/2 day under the same conditions as the cells. You can perform the incubation in a cell culture cylinder or in a 50 ml Falcon tube with open lid.
- After gassing, remove the empty sample from the incubator and within 5 minutes measure the pH-value with a glass electrode.

During the measurement, the medium should have the least possible surface contact with the ambient air, so that the CO₂ can evaporate only slightly. A significant downward movement will happen only after 5 minutes, permitting sufficient time for measurement.

- In addition, you can of course use pH-test strips (pH range 6 to 8, not bleeding).

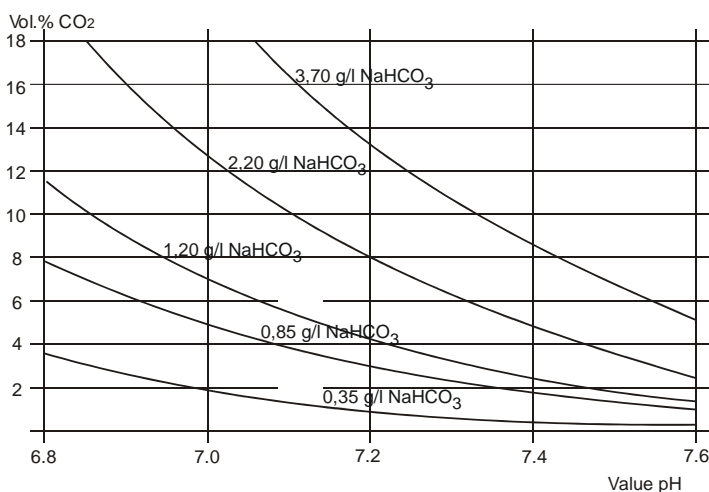

Trade names of common media:

	NaHCO ₃ [g/l]
DMEM	3.70
BME	2.20
MEM	2.20
Medium 199	2.20
Mc Coy	2.20
F10	1.20
F12	1.20

Figure 25: Value pH of NaHCO₃ buffered media as a function of the CO₂ concentration:

Example: If a pH of 7.2 is measured in a medium buffered with 2.20 g NaHCO₃ per liter, there must be 8 vol.-% CO₂ surrounding this medium.

16.1.2 Measuring CO₂ directly via chemical indicator tubes

This is a common “do-it-yourself” test for many users. A chemical color reaction in a glass tube shows the CO₂ concentration. A standardized volume of air from inside the incubator has to be suctioned through this glass tube to get a quantitative test result. Therefore, use a special hand pump with a standardized suction volume.

Procedure (example):

- 1) Break off both ends of the glass tube or remove the plugs.
- 2) Pin the end with the higher end of the scale to the adapter of the hand pump that belongs to that test system.
- 3) Pin the other end through the silicone access port of the inner chamber door of the CB incubator.
- 4) Take one sample volume out of the inner chamber volume by pressing the pump fully together and releasing it afterwards.
- 5) The standardized volume is suctioned through the glass tube and the chemical indicator changes its color beginning from the side pinned into the chamber in the direction of the hand pump.
- 6) The more CO₂ is inside the chamber the more the chemical reaction will cause a color change of the chemical reactor.
- 7) You can read the CO₂ concentration by the scale directly printed on the glass tube or a delivered reference-reading rule.
- 8) The result must then be corrected to the current ambient pressure. The required formula is printed on the instruction sheet of such systems.

All the necessary equipment must be supplied by one manufacturer only and in a defined test system.

Note: These test systems are not very accurate. A typical accuracy is around 10 % of the full-scale value.



These test systems are not suitable for calibrating the BINDER sensor system.



Figure 26: Example of chemical indicator tubes



Figure 27: Example of a hand pump (foreground) and electrical pump (background)

16.1.3 Measuring CO₂ directly with an electronic infrared measuring device

Another possible way of measuring the CO₂ concentration is by electronic sensor systems. Portable measuring devices are suitable for measuring temperature and CO₂ concentration and can be used both for reference measurements in certified laboratories, and for service purposes.

16.2 Temperature reference measurement

When performing a temperature reference measurement using an electronic measuring, and temperature display device, it is important to use a device traceable to an acknowledged standards/calibration institution (DKD, PTB for Germany) with a valid calibration certificate.

Note: The cable of the sensor must be thin enough to lay it over the door gasket of the incubator without causing any leakages.

17. Avoiding microbial contamination

The main types of microbial contaminants in cell and tissue culture are bacteria, fungi, yeast, mycoplasma, and viruses. This chapter gives an overview of potential sources of contamination and precautions and measures to eliminate them.

17.1 Cells and media

- Primary cultures from the original tissue
- Cells / cell lines from unknown sources or from cell banks: Use only cells of known and tested origin. Monitoring and routine screening of new cultures.
- Media and sera: Use only sera of known and tested origin (mycoplasma free, e.g., UV or γ radiated).
- Virus suspensions, antibody solutions etc. Use only reagents of known and tested origin.
- Laboratory instruments, media and reagents that were exposed to possible contaminated cultures must be sterilized / autoclaved / disposed.
- Antibiotics in the cell culture media may prevent bacteria detection: Use antibiotics selectively and economically.

17.2 Laboratory conditions / equipment around the incubator

Possible sources of contamination in the cell culture lab are airborne germs, lab equipment, building features, and the lab personnel.

- Keep pipettes and instruments sterile after autoclaving.
- Bio safety cabinets (laminar air flow) should have a minimum of items apart from aspirator tube and burner. Items shall be positioned within easy reach and separate from each other. Disinfect surfaces with an alcohol-based disinfectant before and after use, clean the space underneath the bench, and carry out regular sterility tests of the filters.
- Regular cleaning / disinfection of laboratory equipment such as a centrifuge, microscope, water bath, refrigerator, and telephone.
- No equipment should be placed on the floor.
- Rough or humid walls are not suitable.
- Identify leaking doors and windows and make them airtight.
- Use air conditioning with special filters.

- Reduce the number of personnel and their movements in the lab by careful positioning all relevant equipment. For practical reasons, install the chamber close to the laminar air flow bench.
- Regular microbiological monitoring of the cell culture laboratory.

17.3 Working and behavior in the lab

Sources of contamination are often the laboratory personnel themselves (surface germs, oral flora droplet transfer) and handling the equipment and cultures. We recommend staff training in aseptic techniques, laboratory safety and good laboratory practice (GLP).

Examples of general rules to reduce the contamination risks

- Reduce hand germ count (wash hands with antimicrobial soap, dry with paper tissues, and rub dry hands with alcohol-based solution).
- Wear appropriate clothing (work coat, shoes, face mask)
- Keep as few personnel as possible in the cell culture lab.

Examples of sterile working method

- Work "clean-to-dirty", i.e., handle confirmed uncontaminated cells first, unknown or untested cells next, and lastly, if necessary, cells suspected to be contaminated.
- Perform daily microscopic observations of cultures and specific tests for the bacteria and fungi as part of a controlled routine. Test cultures for sterility before starting work.
- Keep working surfaces clean. Immediately wipe spilled liquids with alcohol solutions.
- No mouth contact on pipettes.
- Never work on top of open sterile containers.

17.4 Chamber design and equipment of the CO₂ incubator

The design concepts behind the CO₂ incubator CB considerably reduce the risk of contamination. Among them are:

Even surfaces for easy manual cleaning

- The inner surfaces are smooth and therefore easy to clean. The inner chamber is deep-drawn from a single piece, polished (suitable for pharmaceutical work) and has no welds or inaccessible corners. The hinges and the seal of the inner glass door are glued from the outside, which also aids cleaning of the inner chamber.

Removable parts for cleaning and autoclaving

- The shelves are easily removed without screws. It is possible to autoclave the shelves. But this is generally not necessary because they can remain inside the chamber during sterilization.

Door gasket

- The inner door gasket is removable and autoclavable.

Gas fine filter

- The incoming gas used in the operation passes through a fine filter (aseptic filter, filtration efficiency 99.99 %, particle size 0.45 µm) with a high filtration efficiency, which can also filter the smallest particles.

CO₂ measuring system in the inner chamber

- The CO₂ sensor can be hot-air sterilized inside the chamber.

O₂ measuring system in the inner chamber

- The O₂ sensor can be hot-air sterilized inside the chamber.

Condensation prevention

- Condensation in the inner chamber represents a particular risk of contamination. The Permadyr™ system developed by BINDER is an effective and easy way to ensure high humidity (≥ 95 % r.h.) inside the chamber without any condensation forming on the inner surfaces.

Hot air sterilization at 180 °C / 356 °F

- The heating system of the CO₂ incubator permits hot-air auto-sterilization at a setpoint of 187.5 °C / 369.5 °F. Thus, a temperature of 180 °C / 356 °F is maintained for at least 30 minutes on all internal surfaces, resulting in sterilization of the entire inner chamber. Therefore, this procedure meets all international guidelines regarding hot air sterilization, e.g. AAMI ST63, DIN 58947, European Pharmacopoeia.

17.5 Handling the CO₂ incubator

Any manipulation of the CO₂ incubator involves some contamination risks, from installation to opening the doors and regular cleaning.

Installation away from sources of contamination

- Do not place the chamber on the floor or close to windows and doors. Use the optional stand, if appropriate.

Reduce the periods in which the door is open

- Do not open the door too frequently.
- Placing items in order inside the chamber results in shorter door opening times.

Permadyr™ water pan

- Fill the outer pan with distilled, sterilized water (chap. 4.2). Never use ion exchange water; ion exchangers are propagation sites for bacteria.
- Clean and refill the pans 2 to 3 times a week. For evacuation, remove the Permadyr™ water pan. It is autoclavable.
- If desired, you can add microbiologically inhibiting substances as copper chips, copper sulfate or ethylene diamine tetra-vinegar acid (EDTA) in a concentration of 1 to 5 mmol/l.

Avoiding condensation caused by ambient conditions

Ambient room conditions have an effect on condensation inside the chamber, which can be caused by insufficient wall clearances, preventing even dissipation of heat, air movement or direct sunlight. If the temperature distribution inside the chamber becomes uneven, condensation may form on the cooler surfaces.

- Maintain distances from the wall: rear 100 mm / 3.94 in, sides 50 mm / 1.97 in
- Do not place the chamber in front of a window. No direct sunlight. No air movement.
- Permissible ambient temperature range for operation: +18 °C / 64.4°F to +30 °C / 86°F.

Ideal ambient temperature: by at least 7 °C / 12.6 °F below the intended working temperature. E.g., working temperature 37 °C / 98.6 °F = ambient temperature 30 °C / 86 °F and less.

- The chamber should be calibrated / precisely adjusted.
- Let BINDER Service adjust the setting of the door heating in reaction to critical ambient conditions.

Regular cleaning, decontamination and sterilization





- Clean the shelves, glass door, gaskets, and inner chamber weekly (for cleaning see chap. 18.1, for decontamination see chap. 18.2. You can clean the shelves in a laboratory dishwasher and, if needed, individually autoclave them.

- Regularly use the hot air sterilization function (chap. 18.3) following cleaning. The shelves and the emptied water pan can remain inside the chamber during this operation.
- Have replaced the CO₂ sterile filter (gas fine filter) once or twice a year.

What to do in case of contamination?

- Throw away / autoclave contaminated cultures.
- Carefully inspect cultures that seem to be uncontaminated.
- Clean the chamber as described. Wipe the inner chamber and the doors with a disinfectant and allow drying. Autoclave the shelves. Empty the water pan and autoclave it.
- Perform a hot air sterilization.

18. Cleaning, decontamination / disinfection, and sterilization

   	 DANGER
	<p>Electrical hazard. Danger from cleaning agents on hot surfaces. Danger of death.</p> <ul style="list-style-type: none"> ⊘ Do NOT spill water or cleaning agents over the inner and outer surfaces. ➤ Before cleaning, turn off the chamber at the main power switch and disconnect the power plug. Let the chamber cool down to ambient temperature. ➤ Completely dry the chamber before turning it on again.

18.1 Cleaning

Disconnect the chamber from the power supply before cleaning. Disconnect the power plug.

	<p>The interior of the chamber must be kept clean. Thoroughly remove any residues of the charging material.</p>
---	---

Wipe the surfaces with a moistened towel. In addition, you can use the following cleaning agents:

Exterior surfaces, instrument panel	Standard commercial cleaning detergents free from acid or halides. Alcohol-based solutions. We recommend using the neutral cleaning agent Art. No. 1002-0016.
Inner chamber, shelves	Standard commercial cleaning detergents free from acid or halides. Copper sulfate solutions or alcohol-based solutions. We recommend using the neutral cleaning agent Art. No. 1002-0016.
Silicone door gasket	Alcohol-based solutions or the neutral cleaning agent Art. No. 1002-0016.
Zinc coated hinge parts rear chamber wall	Standard commercial cleaning detergents free from acid or halides. Do NOT use a neutral cleaning agent on zinc coated surfaces.

Do not use cleaning agents that may cause a hazard due to reaction with components of the device or the charging material. If there is doubt regarding the suitability of cleaning products, please contact BINDER service.

	<p>We recommend using the neutral cleaning agent Art. No. 1002-0016 for thorough cleaning. Any corrosive damage that may arise following use of other cleaning agents is excluded from liability by BINDER GmbH. Any corrosive damage caused by a lack of cleaning, is excluded from liability by BINDER GmbH.</p>
---	--

	CAUTION
	<p>Danger of corrosion. Damage to the chamber.</p> <ul style="list-style-type: none"> ⊘ Do NOT use acidic or chlorine cleaning detergents. ⊘ Do NOT use a neutral cleaning agent on other kind of surfaces e.g., the zinc coated hinge parts or the rear chamber wall.

Important: To maintain the proper function of the CO₂ sensor, never spray the sensor with any cleaning detergents or disinfectants. Generally perform any cleaning only when the chamber is turned off.

	CAUTION
	<p>Damage to the CO₂ sensor.</p> <ul style="list-style-type: none"> ⊘ Do NOT spray cleaning detergents directly on the CO₂ sensor. ➤ Wipe the sensor with a lint-free cloth soaked with cleaning agent.

Use only the detergents or disinfectants recommended by BINDER. Other products are not approved, since they could in particular damage the CO₂ sensor.

	<p>For surface protection, perform cleaning as quickly as possible. After cleaning completely remove any cleaning agents from the surfaces by using a moistened towel. Let the chamber dry.</p>
---	---



	<p>Soapsuds may contain chlorides and must therefore NOT be used for cleaning.</p>
---	--

	<p>With every decontamination method, always use adequate personal safety controls.</p>
---	---

Following cleaning, leave the chamber door open or remove the access port plugs.

	<p>The neutral cleaning agent may cause health problems in contact with skin and if ingested. Follow the operating instructions and safety hints labeled on the bottle of the neutral cleaning agent.</p>
---	---

Recommended precautions: To protect the eyes use sealed protective goggles. Suitable protective gloves with full contact: butyl or nitrile rubber, penetration time >480 minutes.

	 CAUTION
<p>Contact with skin, ingestion. Skin and eye damage due to chemical burns.</p> <ul style="list-style-type: none"> ⊘ Do not ingest. Keep away from food and beverages. ⊘ Do NOT empty into drains. ➤ Wear protective gloves and goggles. ➤ Avoid skin contact. 	

	<p>Following use of the neutral cleaning agent and prior to hot-air sterilization, remove any agent residues by using a moistened towel in order to avoid formation of permanent residues.</p>
---	--

18.2 Decontamination / chemical disinfection of the chamber

The operator must ensure that proper decontamination is performed in case a contamination of the chamber by hazardous substances has occurred.

Disconnect the chamber from the power supply prior to chemical decontamination. Disconnect the power plug.

Do not use decontamination agents that may cause a hazard due to reaction with components of the device or the charging material. If there is doubt regarding the suitability of cleaning products, please contact BINDER service.

You can use the following disinfectants:

Inner chamber	Standard commercial surface disinfectants free from acid or halides. Alcohol based solutions. We recommend using the disinfectant spray Art. No. 1002-0022.
---------------	---

	For chemical disinfection, we recommend using the disinfectant spray Art. No. 1002-0022. Any corrosive damage that may arise following use of other disinfectants is excluded from liability by BINDER GmbH.
---	--

Important: To maintain the proper function of the CO₂ sensor, never spray the sensor with any cleaning detergents or disinfectants. Generally perform any disinfection only when the chamber is turned off. The sensor may be only superficially disinfected with a damp cloth. The hot air sterilization routine is intended for a thorough sterilization of the entire chamber.

	CAUTION
	<p>Damage to the CO₂ sensor.</p> <ul style="list-style-type: none"> ⊘ Do NOT spray the disinfectant directly on the CO₂ sensor. ➤ Wipe the sensor with a lint-free cloth soaked with the disinfectant.

Use only the detergents or disinfectants recommended by BINDER. Other products are not approved, since they could in particular damage the CO₂ sensor.

	With every decontamination method, always use adequate personal safety controls.
---	--

In case of contamination of the interior by biologically or chemically hazardous material, there are two possible procedures depending on the type of contamination and charging material.

(1) Spray the inner chamber with an appropriate disinfectant.

Before start-up, the chamber must be absolutely dry and ventilated, as explosive gases may form during the decontamination process.

(2) If necessary, have strongly contaminated inner chamber parts removed by an engineer for cleaning, or have them exchanged. Sterilize the inner chamber parts in a sterilizer or autoclave.

	In case of eye contact, the disinfectant spray may cause eye damage due to chemical burns. Follow the operating instructions and safety hints labeled on the bottle of the disinfectant spray.
---	--

Recommended precautions: To protect the eyes use sealed protective goggles.

	CAUTION
	<p>Eye contact. Eye damage due to chemical burns.</p> <p>⊘ Do NOT empty into drains. ➤ Wear protective goggles.</p>

	<p>Following frequent use of the disinfectant spray and prior to hot-air sterilization, remove any agent remainder by using the neutral cleaning agent and then a moistened towel to avoid formation of permanent residues.</p>
--	---

	<p>After using the disinfectant spray, allow the chamber to dry thoroughly, and aerate it sufficiently.</p>
--	---

18.3 Hot-air sterilization at 180 °C / 356 °F

	<p>The very first sterilization after operation may cause an odor. This is not a quality defect. We recommend ventilating well the room during sterilization.</p>
--	---

18.3.1 Overview

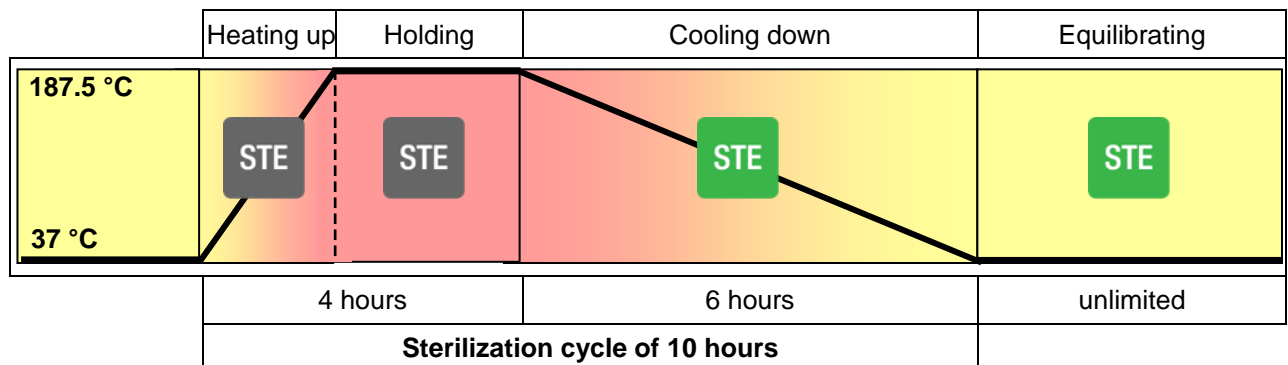

Figure 28: Setpoint profile during the sterilization cycle





The chamber can perform an automatically controlled hot-air sterilization cycle. This procedure will take approx. 10 hours and consists of the following steps:

- Heating up phase:** The chamber heats up the inner chamber as fast as possible to the sterilization setpoint temperature STE
- Holding phase:** Constant sterilization setpoint temperature
 The sterilization setpoint temperature is pre-set in factory to 187.5 °C / 369.5 °F. The duration of the heating up and holding phase is in total 4 hours. This ensures that 180 °C / 356 °F is maintained on all internal surfaces for at least 30 minutes STE
- Cooling down phase:** Programmed duration of 6 hours until 37 °C / 98.6°F is reached STE
- Equilibration phase:** This phase of unlimited duration follows the sterilization with a constant setpoint temperature of 37 °C / 98.6 °F STE



To start the hot-air sterilization cycle, go to [Menu > Hot-air sterilization](#)

Note: in the case when two chambers are directly stacked on top of each other **without** using the original BINDER stacking stand or the BINDER stacking adapter, the exact maintenance of the incubation set parameters in one of the chambers while carrying out sterilization in the other one cannot be assured. Therefore, without using the stacking stand or the stacking adapter, safe incubation is not possible during sterilization of the other chamber. We recommend using a stacking stand (chap. 15.8.1) or a stacking adapter (chap. 15.8.2).

18.3.2 Performing a hot-air sterilization

-  Before carrying out the first hot-air sterilization, remove any protective lamination sheet from the inner metal surfaces.
-  When starting a hot-air sterilization, all gas controls automatically deactivate.
-  The safety controller settings are inactive during sterilization. They become functional again following abortion of the sterilization and/or restart of the chamber at the main power switch.
-  The O₂ sensor must be plugged in during a hot-air sterilization.

- Empty the Permadry™ water pan.

	 WARNING
	<p>Danger of implosion. Destruction of the chamber.</p> <p>➤ Empty the Permadry™ water pan before starting the hot-air sterilization.</p>

- Water pans and shelves must be inside the chamber.
- Close the inner glass door and the outer chamber door.
- Activate the sterilization procedure in the controller.

-  Before starting a hot-air sterilization, the entire interior must be clean and dry. No residue of e.g., water, medium or plastic must remain inside the chamber.

To start the hot-air sterilization cycle, go to [Menu > Hot-air sterilization](#) or [Quick menu > Hot-air sterilization](#)

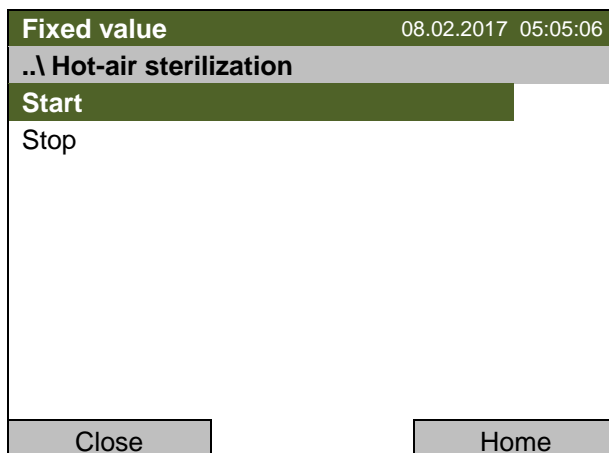

Submenu "Hot-air sterilization".
 Select "Start"
 and press the operating button.

 The message "Warning: Samples and water must be removed!" is displayed. Confirm the message with "OK" and make sure that all samples were removed from the CB before starting the hot-air sterilization.

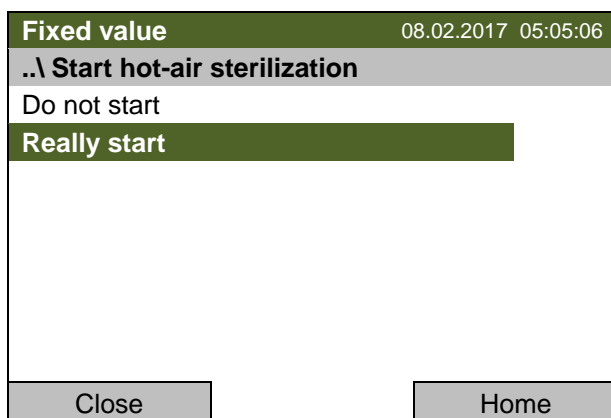

Submenu "Start hot-air sterilization".
Select "Really start" and press the operating button.

The controller returns to the initial view, and hot-air sterilization begins.

 This symbol on the controller display in the initial view indicates that the hot-air sterilization is running.

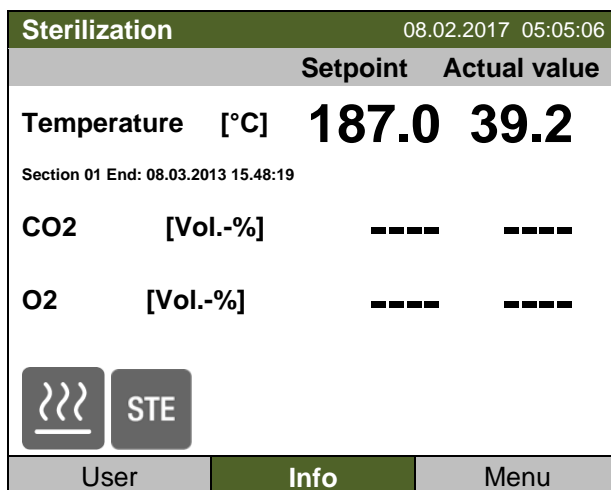

Initial view during the heating-up phase of the hot-air sterilization (sample values).

For further information, press the "Info" button.

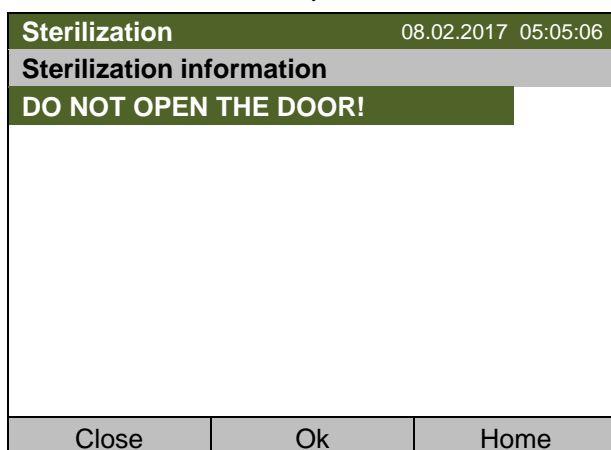



Information menu "Sterilization information".
Confirm the information with "Ok".

If a hot-air sterilization is already running and you try to start it again, the message „Hot air sterilization running“ is displayed. Confirm the message with “OK”.

Opening the outer door during sterilization leads to aborting the automatic sterilization cycle.

	CAUTION
	<p>Interruption of the temperature reaction time. Ineffective sterilization.</p> <p>∅ Do NOT open the chamber doors during sterilization.</p>

	 CAUTION
	<p>Glass door and inner chamber become hot during sterilization. Danger of burning.</p> <p>∅ Do NOT touch the glass door and inner surfaces during sterilization</p>

18.3.3 Aborting the hot-air sterilization – general procedure

Three events lead to aborting the automatic sterilization cycle prematurely:

- Abortion via the controller menu
- Opening the outer door
- Turning off the chamber at the main power switch, or a power failure

To abort the hot-air sterilization cycle via the controller menu, go to [Menu > Hot-air sterilization](#) or [Quick menu > Hot-air sterilization](#)

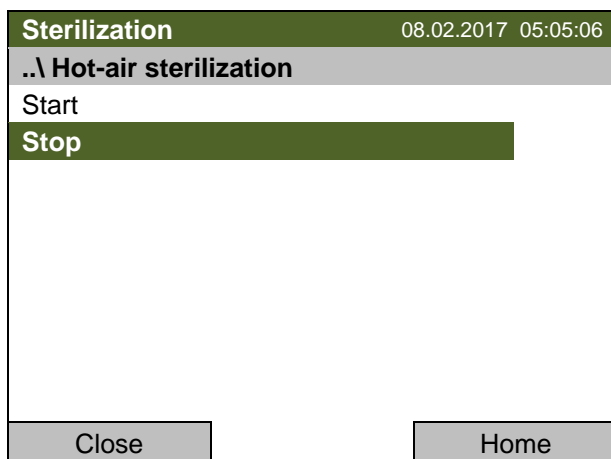

Submenu “Hot-air sterilization”.
 To abort the hot-air sterilization, select “Stop” and press the operating button.

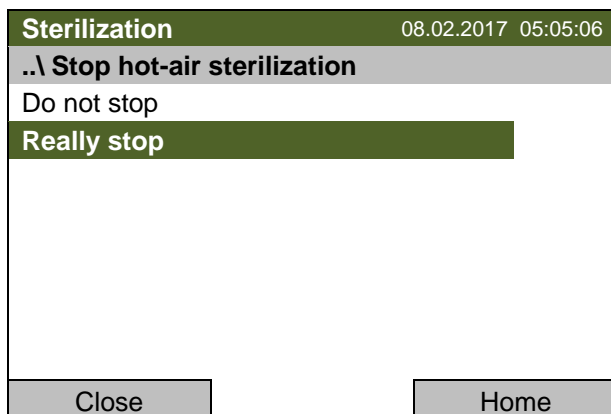

Submenu “Stop hot-air sterilization”.
 This is a security question.
 To abort the hot-air sterilization, select “Really stop” and press the operating button.

The controller returns to the initial view

Aborting the sterilization cycle means cancelling it before the entire 10-hour duration is completed. Whether effective sterilization has occurred depends on the time that has elapsed before abortion.



- Aborting sterilization after less than 4 hours: Prevents effective sterilization.

	<p>This symbol on the controller display indicates that the hot-air sterilization was aborted. The interior may still be hot. Do not touch the glass door and inner surfaces!</p>
---	---

- Aborting / terminating sterilization after more than 4 hours: The chamber is in the cooling-down phase, meaning that the necessary duration for the proper sterilization phase has occurred.

	<p>This symbol on the controller display indicates a successful hot-air sterilization. The sterilization cycle is now in the cooling down phase.</p>
---	--

18.3.4 Aborting hot-air sterilization after less than 4 hours

Sterilization		08.02.2017 05:05:06	
	Setpoint	Actual value	
Temperature [°C]	187.0	89.2	
Section 01 End: 08.03.2013 15.48:19			
CO2 [Vol.-%]	----	----	
O2 [Vol.-%]	----	----	
 			
User	Info	Menu	

Initial view during the hot-air sterilization (sample values).



For further information, press the "Info" button.

To **abort the sterilization cycle** proceed as described in chap. 18.3.3.

	<p>This symbol on the controller display indicates that the hot-air sterilization was aborted. The interior may still be hot. Do not touch the glass door and inner surfaces!</p>
---	---

When aborting the sterilization prematurely, it may be that the cells/pathogens inside the chamber have not all been killed. If necessary, you should repeat the sterilization.

	<p style="text-align: center;">CAUTION</p> <p>Interruption of temperature reaction time. Ineffective sterilization.</p> <p>➤ If necessary, repeat the sterilization.</p>
---	--

	<p style="text-align: center;"> CAUTION</p> <p>Glass door and inner chamber become hot during sterilization. Danger of burning.</p> <p>⊘ Do NOT touch the glass door and inner surfaces for approx. 7 hours after aborting sterilization.</p>
---	--

Fixed value		08.02.2017 05:05:06	
	Setpoint	Actual value	
Temperature [°C]	37.0	60.2	
CO ₂ [Vol.-%]	5.0	---	
O ₂ [Vol.-%]	20.0	---	
			
User	Info	Menu	

Initial view after aborting the hot-air sterilization (sample values).

For further information, press the "Info" button.



Sterilization information		08.02.2017 05:05:06	
Sterilization information			
STERILIZATION ABORTED			
Close	Ok	Home	

Information menu "Sterilization information".

Confirm the information with "Ok".

The  symbol then disappears from the controller display.

Gas control (CO₂, and O₂ (chamber with O₂ control) is deactivated during the sterilization cycle. To activate gas control, the following conditions are required:

1. Aborting the hot-air sterilization cycle
2. Confirming the information message "STERILIZATION ABORTED" with "Ok"
3. Inner chamber temperature below 80 °C

	<p>If the temperature exceeds < 80 °C, gas control will remain deactivated even after aborting the sterilization cycle and confirming the information message "STERILIZATION ABORTED" with "Ok".</p> <p>Only after the temperature has decreased below 80 °C, gas control will turn on again.</p>
---	--

Following abortion of the sterilization cycle:



- If necessary, repeat the sterilization.
- When the inner chamber has cooled down to a value below 60 °C / 140°F, turn on the chamber (chap. 5).

18.3.5 Terminating successful sterilization during the cooling-down phase (abortion after more than 4 hours)

The duration of the entire sterilization is approx. 10 hours. If you want to shorten the sterilization procedure in order to save time, you can abort it during the cooling-down phase, i.e. no sooner than after 4 hours. At this point, the inner temperature is still approx. 140 °C / 284°F.

The effective sterilization phase is automatically finished after 4 hours. The chamber is in the cooling-down phase, meaning that the necessary duration for the proper sterilization phase has occurred.

STE	This symbol on the controller display indicates a successful hot-air sterilization. The sterilization cycle is now in the cooling down phase.
------------	---

	CAUTION
	<p>Glass door and inner chamber become hot during sterilization. Danger of burning.</p> <p>⊘ Do NOT touch the glass door and inner surfaces for approx. 4 hours after aborting sterilization.</p>

Fixed value		08.02.2017 05:05:06	
	Setpoint	Actual value	
Temperature [°C]	37.0	60.2	
CO2 [Vol.-%]	5.0	---	
O2 [Vol.-%]	20.0	---	
			
User	Info	Menu	

Initial view after finishing the sterilization phase (sample values).
 For further information, press the "Info" button.



Sterilization information		08.02.2017 05:05:06	
Sterilization information			
STERILIZATION FINISHED			
Close	Ok	Home	

Information menu "Sterilization information".
 Confirm the information with "Ok".

As the 6-hour cooling-down phase is still running, the  symbol continues to be shown on the controller display. You must now abort the sterilization cycle.



To **abort the sterilization cycle** proceed as described in chap. 18.3.3. The  symbol then disappears from the controller display.

The inner chamber and parts inside can still be hot. Do not touch.

The defined cooling down phase lasts 6 hours until reaching 37 °C / 98.6°F and is followed by a holding phase at 37 °C / 98.6°F of unlimited duration

If you prefer accelerating the cooling- down phase, proceed as follows:

- If required, open the outer door.
- Cooling-down time:
 - Front door open: at least 1 hour
 - Front door closed: at least 4 hours
- If required, open the glass door.

	CAUTION
	<p>The glass door handle reaches a temperature of approx. 150 °C / 302 °F. Danger of burning.</p> <p>➤ Use gloves or a tool (e.g. pincers) to open the glass door.</p>

- When the inner chamber has cooled down to a value below 60 °C / 140°F, turn on the chamber (chap. 5).

Gas control (CO₂, and O₂ (chamber with O₂ control) is deactivated during the sterilization cycle. To activate gas control, the following conditions are required:

1. Confirming the information message “STERILIZATION FINISHED” with “Ok”
2. Aborting the still running hot-air sterilization cycle
3. Inner chamber temperature below 80 °C

	<p>If the temperature exceeds < 80 °C, gas control will remain deactivated even after confirming the information message “STERILIZATION FINISHED” with “Ok” and aborting the sterilization cycle.</p> <p>Only after the temperature has decreased below 80 °C, gas control will turn on again.</p>
---	---



18.3.6 Terminating the completed sterilization cycle

The effective sterilization phase (holding phase) is automatically finished after 4 hours. Then comes a defined 6-hours cooling down phase until 37 °C / 98.6°F is reached. This entire sterilization cycle of 10 hours duration is followed by an equilibration phase of unlimited duration with a constant setpoint temperature of 37 °C / 98.6 °F.

	<p>This symbol on the controller display indicates a successful hot-air sterilization.</p> <p>The sterilization cycle is first in the cooling-down phase and after completing the sterilization cycle in the subsequent equilibrating phase of 37 °C / 98.6°F.</p>
---	--

	<p>To terminate the hot-air sterilization cycle before completing the entire cooling-down phase, proceed as described in chap. 18.3.5.</p>
---	--

Fixed value		08.02.2017 05:05:06	
	Setpoint	Actual value	
Temperature [°C]	37.0	37.2	
CO ₂ [Vol.-%]	5.0	---	
O ₂ [Vol.-%]	20.0	---	

User	Info	Menu
------	------	------

Initial view after finishing the hot-air sterilization cycle (sample values).
For further information, press the "Info" button.



Sterilization information		08.02.2017 05:05:06	
STERILIZATION FINISHED			

Close	Ok	Home
-------	----	------

Information menu "Sterilization information".
Confirm the information with "Ok".



Gas control (CO₂, and O₂ (chamber with O₂ control) is deactivated during and will only be activated after confirming the information message "STERILIZATION FINISHED" with "Ok".

	<p>Gas control (CO₂, and O₂ (chamber with O₂ control) will only be activated after confirming the information message "STERILIZATION FINISHED" with "Ok".</p>
---	--

Then turn on the chamber again (chap. 5).

19. Maintenance and service

19.1 Maintenance intervals, service

 	 DANGER
	<p>Electrical hazard. Danger of death.</p> <ul style="list-style-type: none"> ⊘ The chamber must NOT become wet during operation or maintenance works. ⊘ Do NOT remove the rear panel of the chamber. ➤ Before conducting maintenance work, turn off the chamber at the main power switch and disconnect the power plug. ➤ Any maintenance work must be conducted by licensed electricians or experts authorized by BINDER.

Ensure regular maintenance work is performed at least once a year.

	The warranty becomes void if maintenance work is conducted by non-authorized personnel.
---	---

	Replace the door gasket only when cold. Otherwise, the door gasket may become damaged.
--	--

With an increased amount of dust in the ambient air, clean the Peltier fan grid (7) by suction or blowing several times a year.

We recommend taking out a maintenance agreement. Please consult BINDER Service.

BINDER telephone hotline:	+49 (0) 7462 2005 555
BINDER fax hotline:	+49 (0) 7462 2005 93555
BINDER e-mail hotline:	service@binder-world.com
BINDER service hotline USA:	+1 866 885 9794 or +1 631 224 4340 x3 (toll-free in the USA)
BINDER service hotline Asia Pacific:	+852 390 705 04 or +852 390 705 03
BINDER service hotline Russia and CIS	+7 495 988 15 16
BINDER Internet website	http://www.binder-world.com
BINDER address	BINDER GmbH, post office box 102, D-78502 Tuttlingen

International customers, please contact your local BINDER distributor.

	The gas sensors are especially adjusted for the specific incubator. When exchanging a sensor, you must repeat control adjustment for CO ₂ and O ₂ (chamber with O ₂ control).
---	--

19.2 Checking the air jacket heating fan

The user should regularly perform the following checks:

When the chamber is operating, you will be able to observe the air jacket heating fan centered at the top of the chamber by looking through the ventilation slides at the rear. During chamber operation, the fan must turn counter-clockwise continuously. For better monitoring, you can turn off the chamber and wait until the fan has stopped.

19.3 Checking the humidity system fan

The user should regularly perform the following checks:

Hold a sheet of paper in front of the ventilation silts at the bottom rear of the chamber. If the sheet of paper is suctioned inwards, the fan operates correctly. When opening the door, the fan automatically turns off.

19.4 Gas inlet fine filter

When the chamber is in operation, the incoming gas passes through a fine gas filter (aseptic filter, filtration efficiency 99.99 %, particle size 0.45 µm). This fine filter prevents dirt accumulating in the gas inlet valves and the tubes leading into the inner chamber, which could be in the gas cylinder or in the supply tubes.

When using gas with a technical grade of 99.5 %, we recommend changing the fine gas filter once a year. Please consult BINDER Service. When using gases with less pureness, the changing intervals should be shorter.

19.5 Sending the chamber back to BINDER GmbH

If you return a BINDER product to us for repair or any other reason, we will only accept the product upon presentation of an **authorization number** (RMA number) that has previously been issued to you. An authorization number will be issued after receiving your complaint either in writing or by telephone **prior** to your sending the BINDER product back to us. The authorization number will be issued following receipt of the information below:

- BINDER product type and serial number
- Date of purchase
- Name and address of the dealer from which you bought the BINDER product
- Exact description of the defect or fault
- Complete address, contact person and availability of that person
- Exact location of the BINDER product in your facility
- A contamination clearance certificate (chap. 25) must be faxed in advance

The authorization number must be applied to the packaging in such a way that it can be easily recognized or be recorded clearly in the delivery documents.



For security reasons we cannot accept a chamber delivery if it does not carry an authorization number.

Return address:

BINDER GmbH
Abteilung Service

Gänsäcker 16
78502 Tuttlingen
Germany

20. Disposal

20.1 Disposal of the transport packing

20.1.1 Outer chamber packing

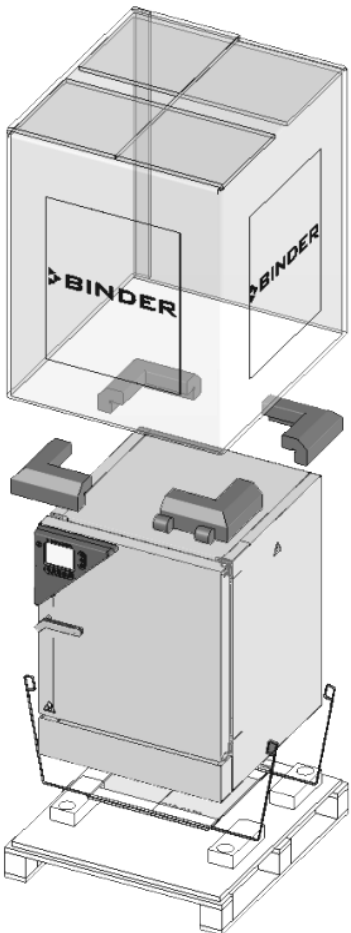
Packing element	Material	Disposal
	Straps to fix packing on pallet (no image)	Plastic Plastic recycling
	Shipping box	Cardboard Paper recycling
	Edge stuffing, top	PE foam Plastic recycling
	Removal aid	Cardboard Paper recycling
		Plastic Plastic recycling
	Pallet with foamed plastic stuffing	PE foam Plastic recycling
Solid wood (IPPC standard) Wood recycling		

20.1.2 Packing inside the chamber and equipment

Packing element	Material	Disposal
Door protection	PE foam	Plastic recycling
Packing box equipment	Cardboard	Paper recycling
Insulating air cushion foil	PE foil	Plastic recycling
Bag for operating manuals	PE foil	Plastic recycling



If recycling is not possible, all packing parts can also be disposed of with normal waste.

20.2 Decommissioning

- Turn off the chamber at the main power switch and disconnect it from the power supply (pull the power plug).

	When switching off the main power switch ON / OFF (1), the stored parameters remain saved.
---	--

- Turn off the CO₂ supply and the O₂ / N₂ supplies (chamber with O₂ control). Remove the gas connections.
- Let the inner chamber sufficiently cool down after a hot-air sterilization before removing any parts.
- The Permadyry™ water pan must not remain filled while the chamber is out of operation. Otherwise condensation on the inner surfaces may occur. In this case, clean and dry the chamber with doors open for at least one hour before restarting the chamber. BINDER recommends performing a hot air sterilization of the chamber before commissioning.
- Temporal decommissioning: See indications for appropriate storage, chap. 3.3.
- Final decommissioning: Dispose of the chamber as described in chap. 20.3 to 20.5.
- When restarting the chamber, please pay attention to the corresponding information in chap. 5.

20.3 Disposal of the chamber in the Federal Republic of Germany

According to Annex I of Directive 2012/19/EU of the European Parliament and of the Council on waste electrical and electronic equipment (WEEE), BINDER devices are classified as “monitoring and control instruments” (category 9) only intended for professional use“. They must not be disposed of at public collecting points.

The chambers bear the symbol for the marking of electrical and electronic equipment manufactured / placed on the market in the EU after 13 August 2005 and be disposed of in separate collection according to Directive 2012/19/EU on waste electrical and electronic equipment (WEEE) and German national law for electrical and electronic equipment (Elektro- und Elektronikgerätegesetz, ElektroG). WEEE marking: crossed-out wheeled bin with solid bar under. A significant part of the materials must be recycled in order to protect the environment.

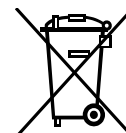



At the end of the device's service life, have the chamber disposed of according to the German national law for electrical and electronic equipment (Elektro- und Elektronikgerätegesetz, ElektroG from 20 October 2015, BGBl. I p. 1739) or contact BINDER service who will organize taking back and disposal of the chamber according to the German national law for electrical and electronic equipment (Elektro- und Elektronikgerätegesetz, ElektroG from 20 October 2015, BGBl. I p. 1739).

	CAUTION
	<p>Violation against existing law.</p> <ul style="list-style-type: none"> ⊘ Do NOT dispose of BINDER devices at public collecting points. ➤ Have the device disposed of professionally at a recycling company which is certified according to the German national law for electrical and electronic equipment (Elektro- und Elektronikgerätegesetz, ElektroG from 20 October 2015, BGBl. I p. 1739). <li style="text-align: center;"><i>or</i> ➤ Instruct BINDER Service to dispose of the device. The general terms of payment and delivery of BINDER GmbH apply, which were valid at the time of purchasing the chamber.

Certified companies disassemble waste (used) BINDER equipment in primary substances for recycling according to Directive 2012/19/EU. The devices must be free from toxic, infectious or radioactive substances in order to eliminate any health hazards to the employees of the recycling companies.

	<ul style="list-style-type: none"> • Prior to handing the chamber over to a recycling company, it is the user's responsibility that it is free from toxic, infectious or radioactive substances. • Prior to disposal, clean all introduced or residual toxic substances from the chamber. • Prior to disposal, disinfect the chamber from all sources of infection. Be aware that sources of infection may also be located outside the inner chamber. • If you cannot safely remove all toxic substances and sources of infection from the chamber, dispose of it as special waste according to national law. • Fill out the contamination clearance certificate (chap. 25) and enclose it with the chamber.
---	---

	 WARNING
	<p>Contamination of the chamber with toxic, infectious or radioactive substances. Danger of intoxication. Danger of infection.</p> <ul style="list-style-type: none"> ⊘ NEVER take a chamber contaminated with toxic substances or sources of infection for recycling according to Directive 2012/19/EU. ➤ Prior to disposal, remove all toxic substances and sources of infection from the chamber. ➤ A chamber from which all toxic substances or sources of infection cannot be safely removed must be considered as "special" waste according to national law. Dispose of it accordingly.

20.4 Disposal of the chamber in the member states of the EU except for the Federal Republic of Germany

According to Annex I of Directive 2012/19/EU of the European Parliament and of the Council on waste electrical and electronic equipment (WEEE), BINDER devices are classified as "monitoring and control instruments" (category 9) only intended for professional use". They must not be disposed of at public collecting points.

The chambers bear the symbol for the marking of electrical and electronic equipment manufactured / placed on the market in the EC after 13 August 2005 and be disposed of in separate collection according to the Directive 2012/19/EU on waste electrical and electronic equipment (WEEE). WEEE marking: crossed-out wheeled bin with solid bar under.

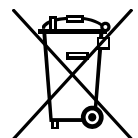





At the end of the device's service life, notify the distributor who sold you the device, who will take back and dispose of the chamber according to the Directive 2012/19/EU on waste electrical and electronic equipment (WEEE).

	CAUTION
	<p>Violation against existing law.</p> <ul style="list-style-type: none"> ⊘ Do NOT dispose of BINDER devices at public collecting points. ➤ Have the device disposed of professionally at a recycling company that is certified according to conversion of the Directive 2012/19/EU into national law. <i>or</i> ➤ Instruct the distributor who sold you the device to dispose of it. The agreements apply that were agreed with the distributor when purchasing the chamber (e.g. his general terms of payment and delivery). ➤ If your distributor is not able to take back and dispose of the chamber, please contact BINDER service.

Certified companies disassemble waste (used) BINDER equipment in primary substances for recycling according to Directive 2012/19/EU. The devices must be free from toxic, infectious or radioactive substances in order to eliminate any health hazards to the employees of the recycling companies.

	<ul style="list-style-type: none"> • Prior to handing the chamber over to a recycling company, it is the user's responsibility that it is free from toxic, infectious or radioactive substances. • Prior to disposal, clean all introduced or residual toxic substances from the chamber. • Prior to disposal, disinfect the chamber from all sources of infection. Be aware that sources of infection may also be located outside the inner chamber. • If you cannot safely remove all sources of infection and toxic substances from the chamber, dispose of it as special waste according to national law. • Fill out the contamination clearance certificate (chap. 25) and enclose it with the chamber.
---	---

	<table border="1"> <tr> <th colspan="2" data-bbox="384 712 1477 792" style="background-color: #FFA500; text-align: center;">  WARNING </th> </tr> <tr> <td data-bbox="384 792 1477 1151"> <p>Contamination of the chamber with toxic, infectious or radioactive substances. Danger of intoxication. Danger of infection.</p> <ul style="list-style-type: none"> ⊘ NEVER take a chamber contaminated with toxic substances or sources of infection for recycling according to Directive 2012/19/EU. ➤ Prior to disposal, remove all toxic substances and sources of infection from the chamber. ➤ A chamber from which all toxic substances or sources of infection cannot be safely removed must be considered as "special" waste according to national law. Dispose of it accordingly. </td> <td></td> </tr> </table>	 WARNING		<p>Contamination of the chamber with toxic, infectious or radioactive substances. Danger of intoxication. Danger of infection.</p> <ul style="list-style-type: none"> ⊘ NEVER take a chamber contaminated with toxic substances or sources of infection for recycling according to Directive 2012/19/EU. ➤ Prior to disposal, remove all toxic substances and sources of infection from the chamber. ➤ A chamber from which all toxic substances or sources of infection cannot be safely removed must be considered as "special" waste according to national law. Dispose of it accordingly. 	
 WARNING					
<p>Contamination of the chamber with toxic, infectious or radioactive substances. Danger of intoxication. Danger of infection.</p> <ul style="list-style-type: none"> ⊘ NEVER take a chamber contaminated with toxic substances or sources of infection for recycling according to Directive 2012/19/EU. ➤ Prior to disposal, remove all toxic substances and sources of infection from the chamber. ➤ A chamber from which all toxic substances or sources of infection cannot be safely removed must be considered as "special" waste according to national law. Dispose of it accordingly. 					

20.5 Disposal of the chamber in non-member states of the EU

	<table border="1"> <tr> <th colspan="2" data-bbox="384 1303 1477 1361" style="background-color: #FFFF00; text-align: center;">CAUTION</th> </tr> <tr> <td data-bbox="384 1361 1477 1592"> <p>Alteration of the environment.</p> <ul style="list-style-type: none"> ➤ For final decommissioning and disposal of the chamber, please contact BINDER service. ➤ Follow the statutory regulations for appropriate, environmentally friendly disposal. </td> <td></td> </tr> </table>	CAUTION		<p>Alteration of the environment.</p> <ul style="list-style-type: none"> ➤ For final decommissioning and disposal of the chamber, please contact BINDER service. ➤ Follow the statutory regulations for appropriate, environmentally friendly disposal. 	
CAUTION					
<p>Alteration of the environment.</p> <ul style="list-style-type: none"> ➤ For final decommissioning and disposal of the chamber, please contact BINDER service. ➤ Follow the statutory regulations for appropriate, environmentally friendly disposal. 					

The main board of the chamber includes a lithium cell. Please dispose of it according to national regulations.





21. Troubleshooting



	Only qualified service personnel authorized by BINDER must perform repair. Repaired chambers must comply with the BINDER quality standards.
---	---

21.1 General

Fault description / indication	Possible cause	Required measures
Chamber without function.	No power supply.	Check connection to power supply.
	Wrong voltage.	Check power supply for voltage of 100-120V or 200-240V.
	Chamber fuse has responded.	Check chamber fuse and replace it if appropriate. If it responds again, contact BINDER service.
	Controller defective.	Contact BINDER service.
	Nominal temperature exceeded by 10° due to chamber failure. Over temperature protective device (class 1) responds.	

21.2 Heating

Fault description / indication	Possible cause	Required measures
Excess temperature. Having reached the setpoint, the temperature exceeds the setpoint by more than the set tolerance range value (more than 10 min.) Alarm message "Temp. range" 	Site of installation too warm. Difference between the set temperature and the ambient temperature too low.	Confirm the alarm (chap. 11.4). Difference between the set temperature and the ambient temperature must be at least 7 °C / 12.6 °F.
Excess temperature. Chamber heating permanently, exceeding the setpoint. Notification "Heating active". Alarm message "Temp. range"  	Temporary disturbance of the temperature control.	Confirm the alarm (chap. 11.4). Turn off the chamber. Open the chamber doors for approx.. 5 minutes and turn on the chamber again. Confirm the alarm (chap. 11.4). Upon renewed alarm, contact BINDER service.
	Controller defective.	Confirm the alarm (chap. 11.4).
	Semiconductor relay defective	Contact BINDER service.
Excess temperature. Overtemperature safety controller class 3.1 responds. Alarm message "Safety controller" 	Safety controller setpoint value exceeded.	Confirm the alarm (chap. 11.4). Check setting of temperature setpoint and of the safety controller class 3.1 setpoint. If appropriate, select suitable value.
	Too much external heat load.	Confirm the alarm (chap. 11.4). Reduce heat load.
	Controller defective.	Confirm the alarm (chap. 11.4). Contact BINDER service.
	Semiconductor relay defective	
	Safety controller defective.	

Fault description / indication	Possible cause	Required measures
<p>Too low temperature. Setpoint temperature is not reached after specified time.</p> <p>Notification “Heating active”.</p> 	<p>Chamber door not properly closed.</p> <p>Semiconductor relay defective.</p> <p>Door gasket defective.</p> <p>Temperature controller not adjusted.</p>	<p>Completely close chamber door.</p> <p>Contact BINDER service</p> <p>Replace door gasket.</p> <p>Calibrate and adjust the temperature controller.</p>
<p>Too low temperature. Having reached the setpoint, the temperature falls below the setpoint by more than the set tolerance range value (more than 10 min.) or the temperature doesn't reach the tolerance range within 3 hours from turning on the chamber or closing the door.</p> <p>Alarm message “Temp. range”</p> 	<p>Chamber door not properly closed.</p> <p>Door gasket defective.</p> <p>Controller defective.</p> <p>Temporary disturbance of the temperature control.</p>	<p>Confirm the alarm (chap. 11.4). Completely close chamber door.</p> <p>Confirm the alarm (chap. 11.4). Replace door gasket.</p> <p>Confirm the alarm (chap. 11.4). Check the function of the temperature controller.</p> <p>Confirm the alarm (chap. 11.4). Turn off the chamber. After approx. 5 minutes turn on the chamber again. Upon renewed alarm, contact BINDER service.</p>
<p>Chamber doesn't heat up.</p> <p>Alarm message “Safety controller”</p> 	<p>Safety controller has turned off the heating. Limit temperature reached. Safety controller set too low.</p> <p>Safety controller defective.</p>	<p>Confirm the alarm (chap. 11.4) and allow the chamber to cool down. Check temperature setpoint and setting of safety controller. If appropriate, select suitable limit value.</p> <p>Confirm the alarm (chap. 11.4). Contact BINDER service.</p>
<p>Chamber doesn't heat up.</p>	<p>Semiconductor relay defective.</p> <p>Controller defective.</p>	<p>Contact BINDER service.</p>
<p>Very long heating-up times.</p>	<p>Chamber fully loaded.</p>	<p>Load the chamber less or consider longer heating-up times.</p>
<p>The displayed actual temperature value deviates largely compared with a reference method..</p>	<p>Temperature control not adjusted.</p> <p>Temperature sensor defective.</p>	<p>Calibrate and adjust the temperature control.</p> <p>Transfer the cultures to another incubator and contact BINDER Service.</p>

21.3 Gas cylinder pressure too low

The alarm messages indicate that the pressure in the supply lines of CO₂, O₂, and N₂ (chamber with O₂ control) has dropped below 0.3 bar. If no gas cylinder changer is installed, the gas cylinder must be replaced. Observe the safety instructions and the maximum outlet pressure (chap. 4.4).



	Prerequisite for pressure alarm messages for O ₂ and N ₂ (chamber with O ₂ control) is that the O ₂ / N ₂ control with the respective alarms are activated (chap. 6.3).
---	--



Note: The recovery times of the gas concentrations inside the chamber following door opening, which are indicated in the technical data (chap. 22.4), refer to a connection pressure of 2.0 bar / 29 *psi*. Decreasing supply pressure down to the shift point (alarm point) of 0.3 bar / 4.4 *psi* results in longer recovery times. Check the pressure displays of your gas supply. If very short recovery times are required or the door is opened frequently, replace the gas cylinders promptly when the pressure decreases below 2.0 bar / 29 *psi*.

Fault description / indication	Possible cause	Required measures
Low CO ₂ outlet pressure (< 0.3 bar) Alarm message "Low pressure CO ₂ " <div style="float: right; background-color: red; color: white; padding: 2px 5px; font-weight: bold;">CO₂</div>	CO ₂ cylinder is not connected correctly.	Confirm the alarm (chap. 11.4). Correctly connect the gas cylinder.
	Connected gas cylinder is closed.	Confirm the alarm (chap. 11.4). Open the gas cylinder.
	Connected gas cylinder is empty.	Confirm the alarm (chap. 11.4). Replace the gas cylinder. Observe the safety instructions and the maximum outlet pressure (chap. 4.4).
	Gas hose is dirty or obstructed.	Confirm the alarm (chap. 11.4). Turn off the gas supply and remove the gas connections. Check the tube system for dirt accumulation or obstruction, clean or replace it.
	Controller malfunction.	Confirm the alarm (chap. 11.4). If necessary, contact BINDER Service.
	Pressure sensor system defective.	Confirm the alarm (chap. 11.4). Contact BINDER Service.
Low O ₂ outlet pressure (< 0.3 bar) (chamber with O ₂ control) Alarm message "Low pressure O ₂ " <div style="float: right; background-color: red; color: white; padding: 2px 5px; font-weight: bold;">O₂</div>	O ₂ cylinder is not connected correctly.	Confirm the alarm (chap. 11.4). Correctly connect the gas cylinder.
	Connected gas cylinder is closed.	Confirm the alarm (chap. 11.4). Open the gas cylinder.
	Connected gas cylinder is empty.	Confirm the alarm (chap. 11.4). Replace the gas cylinder. Observe the safety instructions and the maximum outlet pressure (chap. 4.4).
	Gas hose is dirty or obstructed.	Confirm the alarm (chap. 11.4). Turn off the gas supply and remove the gas connections. Check the tube system for dirt accumulation or obstruction, clean or replace it.
	Controller malfunction	Confirm the alarm (chap. 11.4). If necessary, contact BINDER Service.
	Pressure sensor system defective.	Confirm the alarm (chap. 11.4). Contact BINDER Service.

Fault description / indication	Possible cause	Required measures
Low N ₂ outlet pressure (< 0.3 bar) (chamber with O ₂ control) Alarm message "Low pressure N ₂ " 	N ₂ cylinder is not connected correctly.	Confirm the alarm (chap. 11.4). Correctly connect the gas cylinder.
	Connected gas cylinder is closed.	Confirm the alarm (chap. 11.4). Open the gas cylinder.
	Connected gas cylinder is empty.	Confirm the alarm (chap. 11.4). Replace the gas cylinder. Observe the safety instructions and the maximum outlet pressure (chap. 4.4).
	Gas hose is dirty or obstructed.	Confirm the alarm (chap. 11.4). Turn off the gas supply and remove the gas connections. Check the tube system for dirt accumulation or obstruction, clean or replace it.
	Controller malfunction	Confirm the alarm (chap. 11.4). If necessary, contact BINDER Service.
	Pressure sensor system defective.	Confirm the alarm (chap. 11.4). Contact BINDER Service.



21.4 Gas concentration

Fault description / indication	Possible cause	Required measures
Excess CO₂ concentration. Having reached the setpoint, CO ₂ exceeds the setpoint by more than the set tolerance range value (more than 10 min.) Alarm message "CO ₂ range" 	Temporary disturbance of the CO ₂ control.	Confirm the alarm (chap. 11.4). Turn off the chamber. Open the chamber doors for approx. 5 minutes. Observe the general information for safe handling of CO ₂ (chap. 1.6). Turn on the chamber again. Upon renewed alarm, contact BINDER service.
	CO ₂ sensor defective.	Confirm the alarm (chap. 11.4). Contact BINDER Service.
Excess O₂ concentration. Having reached the setpoint, O ₂ exceeds the setpoint by more than the set tolerance range value (more than 10 min.) (chamber with O ₂ control) Alarm message "O ₂ range" 	Temporary disturbance of the O ₂ control.	Confirm the alarm (chap. 11.4). Turn off the chamber. Open the chamber doors for approx. 5 minutes. Observe the general information for safe handling of oxygen (chap. 1.6).. Prevent oxygen enrichment in the ambiance of the chamber. Turn on the chamber again. Upon renewed alarm, contact BINDER service.
	O ₂ sensor defective.	Confirm the alarm (chap. 11.4). Contact BINDER Service.
Recovery time (up to 5 vol.-% CO ₂) after doors were open for 2 minutes is < 2 minutes	CO ₂ sensor system defective.	Contact BINDER Service.

Fault description / indication	Possible cause	Required measures
<p>Too low CO₂ concentration. Having reached the setpoint, CO₂ falls below the setpoint by more than the set tolerance range value (more than 10 min.) or CO₂ doesn't reach the tolerance range within 3 hours from turning on the chamber or closing the door.</p> <p>Alarm message "CO₂ range" </p>	<p>Temporary disturbance of the CO₂ control.</p>	<p>Confirm the alarm (chap. 11.4). Turn off the chamber. After approx. 5 minutes turn on the chamber again. Upon renewed alarm, contact BINDER service.</p>
<p>Too low O₂ concentration. Having reached the setpoint, O₂ falls below the setpoint by more than the set tolerance range value (more than 10 min.) or O₂ doesn't reach the tolerance range within 3 hours from turning on the chamber or closing the door (chamber with O₂ control).</p> <p>Alarm message "O₂ range" </p>	<p>Temporary disturbance of the O₂ control.</p>	<p>Confirm the alarm (chap. 11.4). Turn off the chamber. After approx. 5 minutes turn on the chamber again. Upon renewed alarm, contact BINDER service.</p>
<p>Too low gas concentration. The concentration of CO₂ or O₂ (chamber with O₂ control) does not reach the adjusted set value.</p>	<p>Door gaskets defective.</p>	<p>Replace door gaskets</p>
	<p>Doors not closed properly.</p>	<p>Close door properly.</p>
	<p>Connected gas cylinder is empty or not opened.</p>	<p>Open or replace gas cylinder.</p>
	<p>Gas cylinder is not connected correctly.</p>	<p>Correctly connect the gas cylinder.</p>
	<p>Gas hose is dirty or obstructed.</p>	<p>Check the tube system for dirt accumulation or obstruction, clean or replace it.</p>
<p>Recovery time (up to 5 vol.-% CO₂) after doors were open for 2 minutes is > 10 minutes.</p>	<p>Obstructed gas supply.</p>	<p>Check gas supply (cylinder, connections, hose system).</p>
	<p>Insufficient CO₂ input pressure</p>	
<p>Unusually high gas consumption.</p>	<p>Door gaskets defective.</p>	<p>Replace door gaskets</p>
	<p>Gas sensor not adjusted.</p>	<p>Calibrate the sensor.</p>
	<p>Gas sensor defective.</p>	<p>Contact BINDER Service</p>
	<p>Gas fine filter not connected correctly.</p>	
<p>The displayed actual value of CO₂ deviates largely compared with a reference method.. The pH indicator of the cell culture medium changes its normal color.</p>	<p>CO₂ control not adjusted.</p>	<p>Calibrate and adjust CO₂ control.</p>
	<p>CO₂ sensor defective.</p>	<p>Transfer the cultures to another incubator and contact BINDER Service.</p>
<p>The displayed actual value of O₂ (chamber with O₂ control) deviates largely compared with a reference method.</p>	<p>O₂ control not adjusted.</p>	<p>Calibrate and adjust O₂ control.</p>
	<p>O₂ sensor defective.</p>	<p>Transfer the cultures to another incubator and contact BINDER Service.</p>

Fault description / indication	Possible cause	Required measures
No gas control after hot-air sterilization.	Sterilization cycle still running.	Abort hot-air sterilization.
	Information message not confirmed.	Confirm the information message with "OK".
	Inner chamber temperature above 80 °C	Let the inner chamber temperature decrease below 80 °C.

21.5 Sterilization

Indication	Possible cause	Required measures
The sterilization is running. Notification "DO NOT OPEN THE DOOR !". 	Sterilization cycle is in the heating up or holding phase	Confirm the alarm (chap. 11.4). Do not open the door.
Sterilization phase (4 hours) of the sterilization is successfully completed: Interior is sterilized. Notification "STERILIZATION FINISHED". 	Sterilization phase (4 hours) of the sterilization cycle completed.	Confirm the information message (chap. 11.4). The inner chamber and parts inside can still be hot. Do not touch. You can open the doors. If the sterilization cycle is still running: abort hot-air sterilization. Let the chamber cool down (chap. 18.3) and take it into operation again (chap. 5).
Abortion of sterilization after less than 4 hours. Interior is not sterilized. Notification "STERILIZATION ABORTED". 	Abortion of the hot-air sterilization via the controller menu or by turning off the chamber.	Confirm the information message (chap. 11.4). The inner chamber and parts inside can still be hot. Do not touch. Interior is not sterilized. Start again the hot-air sterilization or disinfect the interior (chap. 18.2)
	Outer door opened during hot-air sterilization.	Confirm the information message (chap. 11.4). Close the chamber door and start again the hot-air sterilization.

21.6 Humidity

Fault description / indication	Possible cause	Required measures
Condensations inside the chamber.	Permadry™ pan filled with water when the chamber is not operating.	Empty Permadry™ pan when the chamber is not operating.
	Door gaskets defective.	Replace door gaskets
	Doors not closed properly.	Close door properly.
	Humidity set too high.	Reduce humidity (chap. 6.4)
Condensation on the divided inner door.	Chamber placed on very cold floor.	Place the chamber on a BINDER stand to increase the distance to the floor.
	Door gaskets defective.	Replace door gaskets
	Doors not closed properly.	Close door properly.
	Humidity set too high.	Reduce humidity (chap. 6.4)
	Door heating set too low.	Contact BINDER Service to adjust the door heating

Fault description / indication	Possible cause	Required measures
Condensation on the divided inner door, gas-proof.	Chamber placed on very cold floor.	Place the chamber on a BINDER stand to increase the distance to the floor.
	Door gaskets defective.	Replace door gaskets
	Doors not closed properly.	Close door properly.
	Humidity set too high.	Reduce humidity (chap. 6.4).
Too low humidity inside.	Door heating set too low.	Contact BINDER Service to adjust the door heating
	Humidity set too low.	Increase humidity (chap. 6.4)
	Chamber door not properly closed.	Completely close chamber door.
	Door gasket defective.	Replace door gasket.
	Permadyr™ pan empty.	Fill the outer Permadyr™ pan with water up to the marking on the inner pan with distilled, sterile water. The pan must have thorough contact to the bottom of the inner chamber, see chap. 4.2.

21.7 Controller

Fault description / indication	Possible cause	Required measures
No entries to controller keypad possible. Notification "Key lock".	 Key lock activated.	Enter the key lock password (chap. 8).

21.8 Open door

A door contact switch serves to check the state of the outer door. When the door is open, temperature, CO₂, and O₂ (chamber with O₂ control) control are turned off.

Indication	Possible cause	Required measures
Outer door open (longer than the selected alarm delay time) Alarm message "Door open"	 Outer door open or not properly closed.	Confirm the alarm (chap. 11.4). Close the door. The triggered zero-voltage relay alarm contact switches back.

22. Technical description

22.1 Factory calibration and adjustment

This chamber was calibrated and adjusted in the factory. Calibration and adjustment were performed using standardized test instructions, according to the QM DIN EN ISO 9001 system applied by BINDER (certified since December 1996 by TÜV CERT). All test equipment used is subject to the administration of measurement and test equipment that is also a constituent part of the BINDER QM DIN EN ISO 9001 systems. They are controlled and calibrated to a DKD-Standard at regular intervals.

A record of this calibration and adjustment is part of the BINDER test certificate of the chamber.

Adjustment in factory:

- **Temperature:** 37 °C / 98.6°F measured in the center of the usable volume
- **CO₂:** 0 vol.-% CO₂ (100 vol.-% N₂) and 5 vol.-% CO₂ (analyzed test gas directly exposed to the sensor head)
- **O₂** (chamber with O₂ control): 0 vol.-% O₂ (100 vol.-% N₂, analyzed test gas directly exposed to the sensor head) and 20.9 vol.-% O₂ (ambient air).



Repeated calibrations are recommended in periods of 12 months.

BINDER service uses an electronic measuring and display device for temperature traceable to an acknowledged standards/calibration institution (DKD or PTB for Germany) with valid calibration certificate.

Test gases with an analyzed concentration serve to calibrate the sensor systems for CO₂ and O₂ (chamber with O₂ control). The sensor heads are exposed directly to the test gas.

22.2 Over current protection

The CB is protected by a chamber-protection against over current, accessible from the outside. It is located at the rear of the chamber below the strain relief of the power cord. The fuse holder is equipped with a fuse clip 5mm x 20 mm (cUL-Version 6.3 x32 mm). Replace this fuse only with a substitute of the same ratings. Refer to the technical data of the respective device type. If this fuse is blown, please inform an electronic engineer or BINDER service.

22.3 Definition of usable volume

The usable volume illustrated below is calculated as follows:

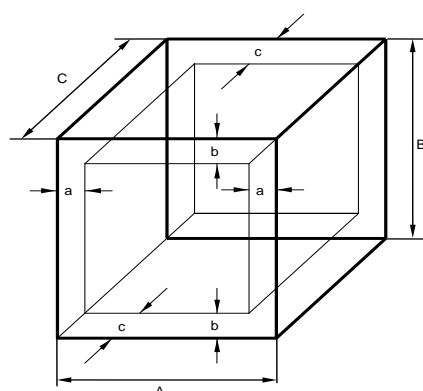

A, B, C = internal dimensions (W, H, D)

a, b, c = wall separation

$$a = 0.1 \cdot A$$

$$b = 0.1 \cdot B$$

$$c = 0.1 \cdot C$$

$$V_{\text{USE}} = (A - 2 \cdot a) \cdot (B - 2 \cdot b) \cdot (C - 2 \cdot c)$$

Figure 29: Determination of the usable volume

The technical data refers to the defined usable volume.

	<p>Do NOT place samples outside this usable volume.</p> <p>Do NOT load this volume by more than half to enable sufficient airflow inside the chamber.</p> <p>Do NOT divide the usable volume into separate parts with large area samples.</p> <p>Do NOT place samples too close to each other in order to permit circulation between them and thus obtain a homogenous distribution of temperature, CO₂ and O₂ (chamber with O₂ control).</p>
---	--

22.4 CB technical data

Chamber size		60	160	220	
Exterior dimensions					
Width, net	mm / inch	580 / 22.83	680 / 26.77	740 / 29.13	
Height including feet	mm / inch	720 / 28.35	920 / 36.22	1070 / 42.13	
Depth, net	mm / inch	550 / 21.65	715 / 28.15	715 / 28.15	
Depth plus door handle, I-triangle	mm / inch	55 / 2.16	55 / 2.16	55 / 2.16	
Depth plus power connection and gas connection	mm / inch	17 / 0.67	17 / 0.67	17 / 0.67	
Wall clearance rear (minimum)	mm / inch	100 / 3.94	100 / 3.94	100 / 3.94	
Wall clearance side (minimum)	mm / inch	50 / 1.97	50 / 1.97	50 / 1.97	
Doors					
Quantity of outer doors		1	1	1	
Quantity of inner doors (inner glass door or divided inner door)		1	1	1	
Quantity of individual inner glass doors (with divided inner door)		4	4	6	
Interior dimensions					
Width	mm / inch	400 / 15.75	500 / 19.69	560 / 22.05	
Height	mm / inch	400 / 15.75	600 / 23.62	750 / 29.53	
Depth	mm / inch	330 / 12.99	500 / 19.69	500 / 19.69	
Interior volume	l / c.ft.	53 / 1.9	150 / 5.4	210 / 7.5	
Shelves					
Number of shelves, regular		2	3	3	
Number of shelves, max.		3	6	8	
Size of shelf (external) Width x Depth	mm x mm inch x inch	396 x 289 15.59 x 11.38	495 x 444 19.49 x 17.48	556 x 444 21.89 x 17.48	
Maximum load per shelf	Kg / lbs.	10 / 22	10 / 22	10 / 22	
Permitted total load	Kg / lbs	30 / 66	30 / 66	30 / 66	
Weight					
Weight (empty)	Kg / lbs	60 / 132	107 / 236	121 / 267	
Temperature data					
Temperature range	from ... degree above ambient	°C / °F	7 / 12.6	7 / 12.6t	7 / 12.6
	up to	°C / °F	60 / 140	60 / 140	60 / 140
Temperature fluctuation	at 37 °C/ 98.6 °F	± K	0.1	0.1	0.1
Temperature uniformity (variation)	at 37 °C/ 98.6 °F	± K	0.3	0.3	0.4
Recovery time after door was opened for 30 sec	at 37 °C/ 98.6 °F	minutes	4	5	5

Chamber size		60	160	220
CO₂ data				
CO ₂ range	vol.-% CO ₂	0 to 20	0 to 20	0 to 20
Setting accuracy	vol.-% CO ₂	0.1	0.1	0.1
Recovery time after door was opened for 30 sec at 5 vol.-% CO ₂	minutes	5	5	5
CO ₂ measurement		IR	IR	IR
Connection hose nozzle DN6 for CO ₂ connection to the chamber for hose with internal diameter	mm / inch	6 / 0.24	6 / 0.24	6 / 0.24
Humidity data				
Humidity	% r.H.	90 to 95	90 to 95	90 to 95
O₂ Data				
O ₂ range (regular equipment)	vol.-% O ₂	0.2 to 20	0.2 to 20	0.2 to 20
O ₂ range (chamber with optional alternative control range 10 up to 95 vol.-% O ₂)	vol.-% O ₂	10 to 95	10 to 95	10 to 95
Setting accuracy with inlet pressure 2 bar	vol.-% O ₂	0.1	0.1	0.1
Recovery time after door was opened for 30 sec at 1 vol.-% O ₂	minutes	8	12	18
Recovery time after door was opened for 30 sec at 5 vol.-% O ₂	minutes	8	12	18
O ₂ measurement		ZrO ₂	ZrO ₂	ZrO ₂
Connection hose nozzle DN6 for O ₂ /N ₂ connection to the chamber for hose with internal diameter	mm / inch	6 / 0.24	6 / 0.24	6 / 0.24
Electrical data				
IP system of protection acc. to EN 60529	IP	20	20	20
Nominal voltage (±10 %)	at 50 Hz power frequency	V	200-240	200-240
	at 60 Hz power frequency	V	200-240	200-240
Current type		1N~	1N~	1N~
Nominal power	kW	1.00	1.30	1.50
Power plug (IEC connector plug)		Shock-proof plug		
Installation category acc. to IEC 61010-1		II	II	II
Pollution degree acc. to IEC 61010-1		2	2	2
Chamber fuse 4x20mm / semi time-lag (M)	Amp	10	10	10
Different electrical data for CB-UL constructed for the USA and Canada				
Nominal voltage (±10 %)	at 50 Hz power frequency	V	100-120	100-120
	at 60 Hz power frequency	V	100-120	100-120
Current type		1N~	1N~	1N~
Power plug	NEMA	5-15P	5-20P	5-20P
Nominal power	kW	1.00	1.30	1.50
Chamber fuse 6.3 X 32 mm / 250V / super-time-lag TT	Amp	16 external	16 external	16 external
Additional temperature fuse class 1 (DIN 12880)		internal	internal	internal
Environment-specific data				
Energy consumption at 37 °C/ 98.6 °F	Wh/h	80	100	120

Note: The recovery times of the gas concentrations inside the chamber after the door is opened coincide with a connection pressure of 2.0 bar / 29 psi. Decreasing supply pressure results in longer recovery times.

All technical data is specified for unloaded chambers with standard equipment at an ambient temperature of 22 +/- 3 °C / 71.6 +/- 5.4 °F and a power supply voltage fluctuation of +/-10%. Technical data is determined in accordance to BINDER Factory Standard Part 2:2015 and DIN 12880:2007.

All indications are average values, typical for chambers produced in series. We reserve the right to change technical specifications at any time.

22.5 Equipment and Options

	<p>To operate the chamber, use only original BINDER accessories or accessories / components from third-party suppliers authorized by BINDER. The user is responsible for any risk arising from using unauthorized accessories.</p>
---	--

Regular equipment
Multifunction controller T4.12 for temperature and CO ₂ (and for O ₂ with chamber with O ₂ control)
CO ₂ infra-red absorption measuring system
Fan-assisted air jacket system
Hot-air auto sterilization at 187.5 °C / 369.5 °F
Gas mixing head
Permadyr™ system
Weldless deep-drawn inner chamber made of stainless steel 1.4301/V2A, polished
Electronic error auto-diagnosis system with zero-voltage relay output
Zero-voltage relay alarm output with DIN socket (6 poles), DIN plug included
Tightly closing inner glass door; or divided inner door, gas-proof, stainless steel, 4 times (CB 60, CB 160), 6 times (CB 220)
3 perforated shelves, stainless steel 1.4301/V2A
Overtemperature safety controller class 3.1 acc. to DIN 12880:2007
Ethernet interface
Programmable key lock

Options / accessories
Perforated shelf ,stainless steel
Stable perforated shelf with additional fixation for shaker operation
Reinforced shelf stainless steel with 1 set of rack lockings
Rack lockings (4 pieces)
Lockable door
Shelves for divided inner door, gas-proof, stainless steel
Stacking stand with castors lockable by breaks (CB 150 / CB 210)
Stacking adapter for direct, thermally decoupled stacking
Base with castors
Stacking adapter for combination C 150 on top of CB 160
Silicone access ports closable with 2 silicone plugs
BINDER Gas Supply Service: External CO ₂ bottle changer CO ₂ , O ₂ or N ₂
Connection kit for CO ₂ , O ₂ or N ₂ cylinder
Water tight internal socket 230 V (max. 3 A), with turn-off switch
Analog output temperature and CO ₂ 4-20 mA 4-20mA with DIN socket (6 poles), DIN plug included
Cleaning kit (neutral cleaning agent, disinfection spray and lint-free disposable wipes, gloves and goggles)
Intelligent Fail-Safe CO ₂ monitoring function
CELLROLL roller system with set of connection cables and extra-low voltage access port
Access port (8-pin) for extra-low voltage (ELV) with LEMO socket (can be covered) and LEMO connector, maximum power rating 24VAC/DC – 2.5 Amp

Options / accessories (continued)
Communication interface RS 422
Data Logger Kit T 220
Qualification folder
Calibration of temperature including certificate
Calibration of CO ₂ including certificate
Calibration of O ₂ including certificate (chamber with O ₂ control)
Spatial temperature measurement including certificate
Spatial temperature measurement acc. to DIN 12880 including certificate

22.6 Accessories and spare parts (extract)

	BINDER GmbH is responsible for the safety features of the chamber only, provided skilled electricians or qualified personnel authorized by BINDER perform all maintenance and repair, and if components relating to chamber safety are replaced in the event of failure with original spare parts. The user is responsible for any risks arising from using unauthorized accessories/components.
---	--

Chamber size	60	160	220
Description	Art. no.		
Perforated shelf, stainless steel	6004-0136	6004-0139	6004-0137
Divided shelves (1 level) for divided inner door, gas-proof, stainless steel	--	8012-0578	8012-0579
Extra-deep shelf for divided inner door, gas-proof, stainless steel	6004-0120	--	--
Door gasket for outer chamber door	6005-0208	6005-0017	6005-0027
Door gasket for inner glass door	6005-0187	6005-0077	6005-0080
Door gasket (slim) for divided inner door, gas-proof	--	6005-0102	6005-0103
Door gasket for individual glass door of divided inner door, gas-proof	--	6005-0100	6005-0101
Individual glass door of divided inner door, gas-proof, complete	--	8010-0051	8010-0035
Stacking stand with castors lockable by breaks	--	9051-0020	9051-0023
Stacking adapter for direct, thermally decoupled stacking	9051-0032	9051-0026	9051-0030
Base with castors	9051-0031	9051-0028	9051-0029
Stacking adapter for combination C 150/170 on top of CB 160	--	9051-0027	--
Flat stacking adapter	9051-0037	9051-0035	--
CELLROLL roller system with set of connection cables and extra-low voltage access port	--	8012-0571	8012-0572

Description	Art. no.
Plug for optional silicon access port d30	6016-0035
Gas cylinder connection kit for CO ₂	8012-0014
Gas cylinder connection kit for O ₂	8012-0015
Gas cylinder connection kit for N ₂	8012-0016
Chamber fuse 5x20mm 250V 10A semi time-lag (M)	5006-0012
Chamber fuse 6.3x32mm 250V 16A super-time (TT) for CUL version only	5006-0033

Description	Art. no.
CO ₂ sensor	5002-0076
O ₂ sensor for regular equipment: hypoxic control range 0.2 up to 20 vol.-% O ₂	5002-0080
O ₂ sensor for chambers with optional alternative control range 10 up to 95 vol.-% O ₂	5002-0149
Gas fine filter	8009-0369
Permady TM water pan CB 60	4022-0260
Permady TM water pan CB 160 / CB 220	6006-0441
Cleaning kit (neutral cleaning agent, disinfection spray and lint-free disposable wipes, protective gloves and goggles)	8012-0503
Neutral cleaning agent, 1 kg	1002-0016

Validation service	Art. no.
Qualification folder IQ-OQ	8012-0876
Qualification folder IQ-OQ-PQ	8012-0963
Execution of IQ-OQ	DL410200
Execution of IQ-OQ-PQ	DL440500

Calibration service	Art. no.
Calibration of temperature including certificate	8012-1132
Calibration of temperature and CO ₂ including certificate	8012-1235
Calibration of O ₂ including certificate (chamber with O ₂ control)	8012-0229
Spatial temperature measurement including certificate (15-18 measuring points)	8012-1571
Spatial temperature measurement including certificate (9 measuring points)	8012-1550
Spatial temperature measurement including certificate (27 measuring points)	8012-1592

For information on components not listed here, please contact BINDER Service.

22.7 Important conversion data for non-SI units

1 ft = 0.305 m

1 m = 100 cm = 3.28 ft = 39.37 inch

1 mbar = 0.0145 psi

22.8 Conversion table for gas inlet pressures, bar – psi

bar	psi	bar	psi	bar	psi
1	14.5	3	43.5	5	72.5
1.5	21.7	3.5	50.7	5.5	79.7
2	29.0	4	58.0	6	87.0
2.5	36.3	4.5	65.2		

22.9 Dimensions CB 60

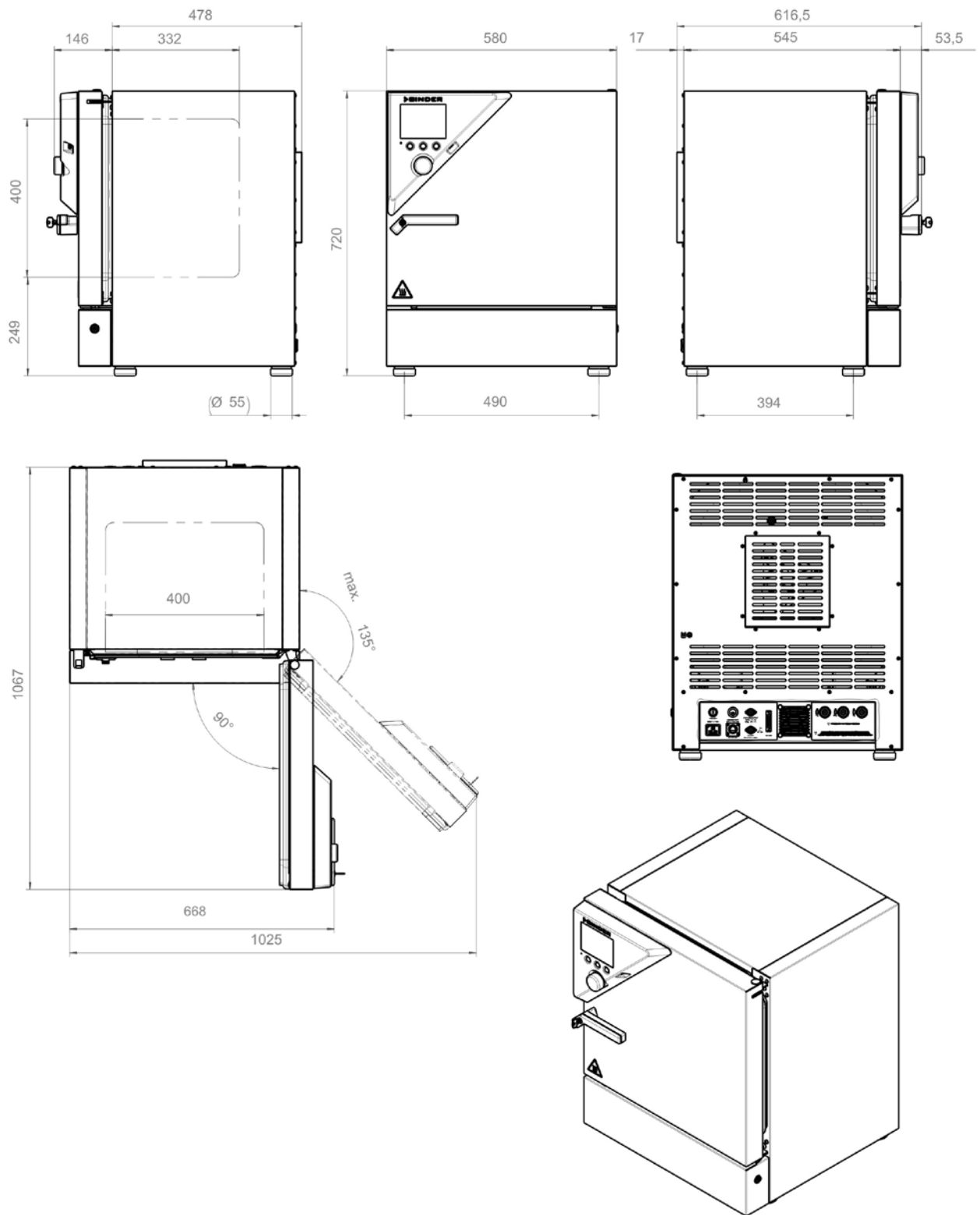

(Dimensions in mm)

22.10 Dimensions CB 160

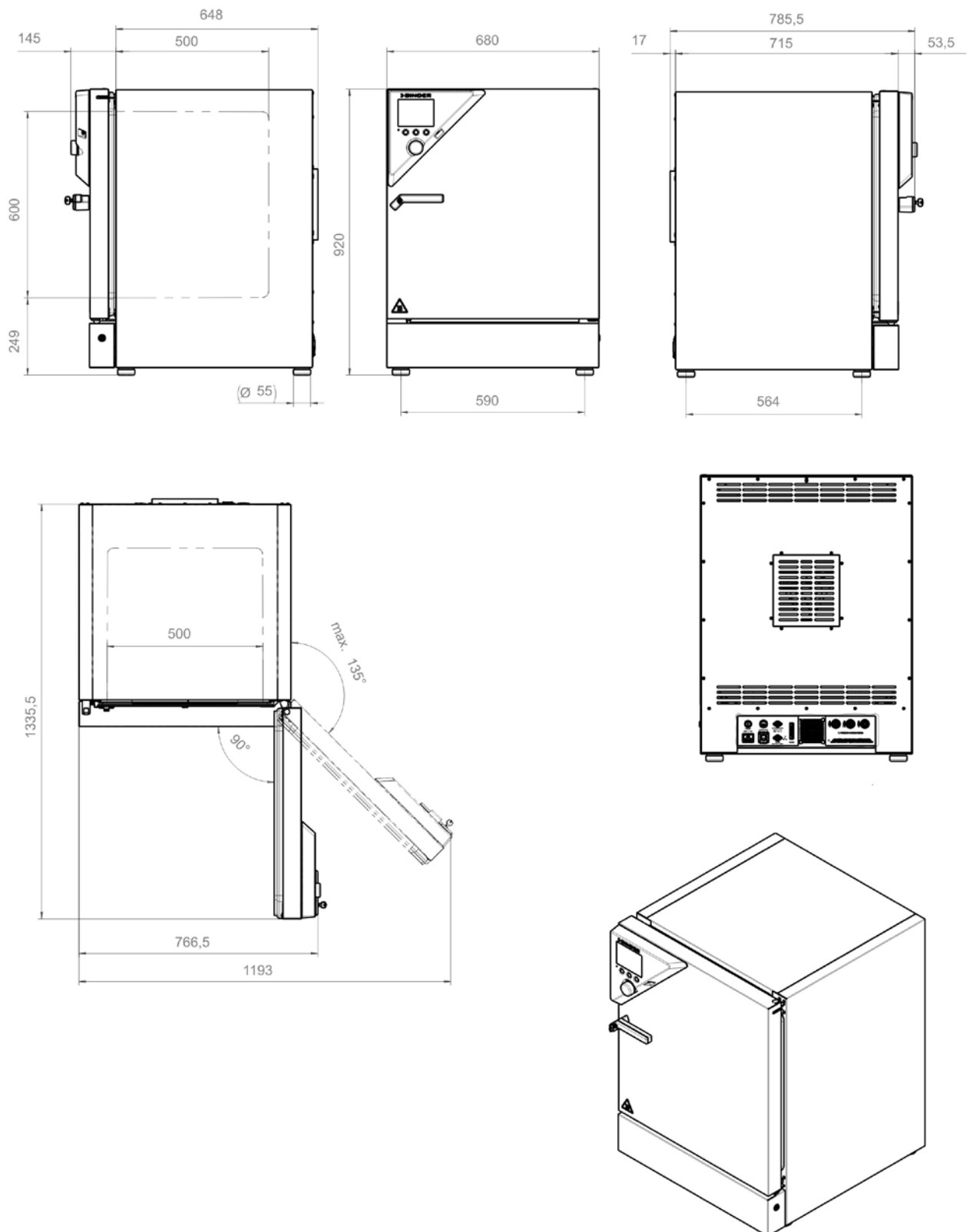

(Dimensions in mm)

22.11 Dimensions CB 220

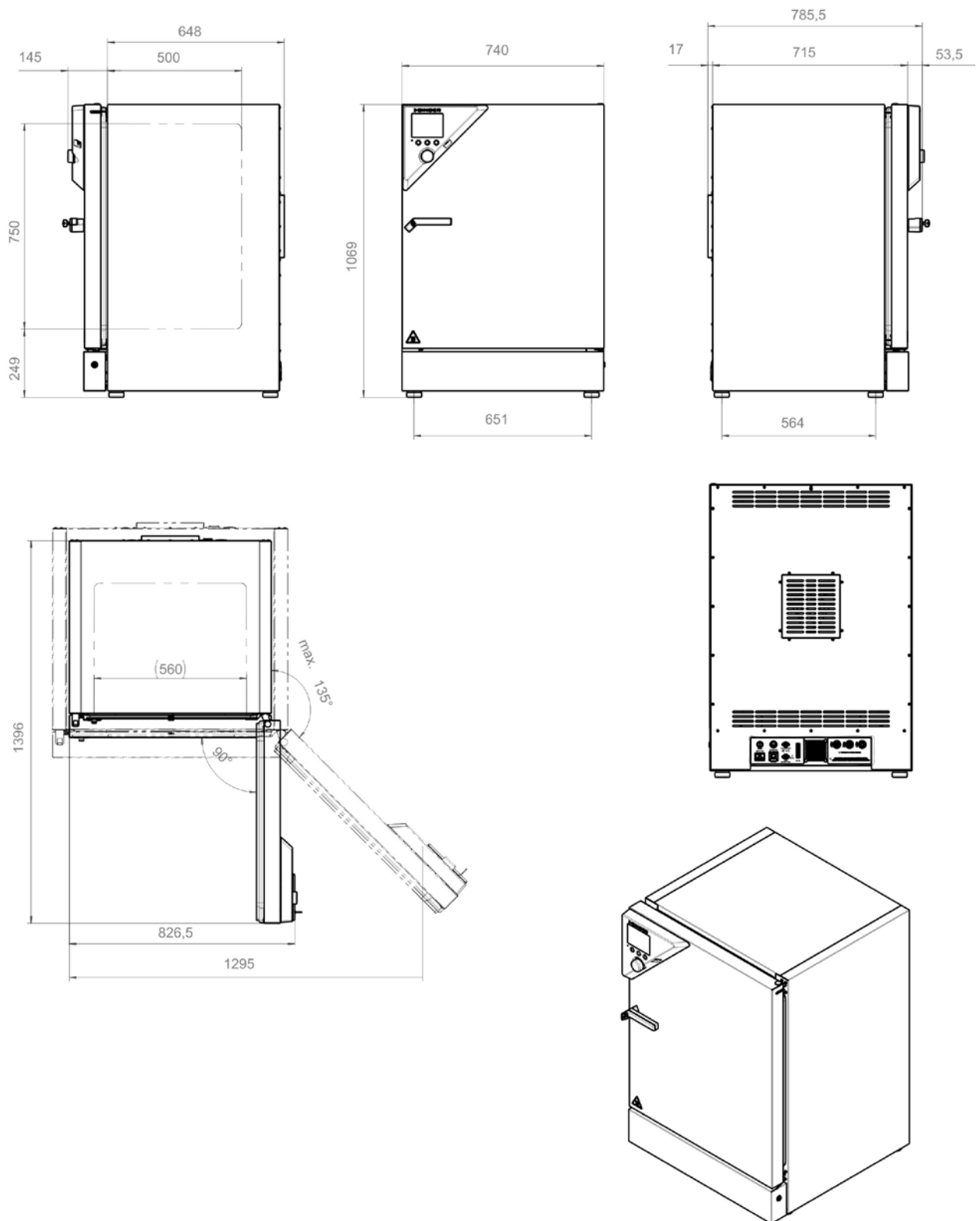

(Dimensions in mm)

23. Certificates and declarations of conformity

23.1 EU Declaration of conformity



Best conditions for your success

 EU-Konformitätserklärung / EU Declaration of Conformity / Déclaration de conformité UE / Declaración de conformidad UE / Dichiarazione di conformità UE / Декларация соответствия EU	
Hersteller / Manufacturer / Fabricant / Fabricante / Fabbricante / Производитель	BINDER GmbH
Anschrift / Address / Adresse / Dirección / Indirizzo / Адрес	Im Mittleren Ösch 5, 78532 Tuttlingen, Germany
Produkt / Product / Produit / Producto / Prodotto / Продукт	CO ₂ -Inkubatoren CO ₂ Incubators Incubateurs à CO ₂ Incubadoras de CO ₂ Incubatori a CO ₂ CO ₂ инкубаторы
Typenbezeichnung / Type / Type / Tipo / Tipo / Тип	CB 60, CB 160, CB 220

Das oben beschriebene Produkt ist konform mit folgenden EU-Richtlinien:
 The product described above is in conformity with the following EU Directives:
 Le produit décrit ci-dessus est conforme aux directives UE suivantes:
 El producto descrito arriba cumple con las siguientes directivas de la UE:
 Il prodotto sopra descritto è conforme alle seguenti direttive UE:
 Продукты, указанные выше, полностью соответствуют следующим EU руководствам:

- **2014/35/EU**
Niederspannungsrichtlinie 2014/35/EU / Low voltage directive 2014/35/EU / Directive basse tension 2014/35/UE / Directiva sobre baja tensión 2014/35/UE / Direttiva Bassa tensione 2014/35/UE / Директива по низкому напряжению 2014/35/EU
- **2014/30/EU**
EMV-Richtlinie 2014/30/EU / EMC Directive 2014/30/EU / Directive CEM 2014/30/UE / Directiva CEM 2014/30/UE / Direttiva EMC 2014/30/UE / Директива ЭМС 2014/30/EU
- **2011/65/EU**
RoHS-Richtlinie 2011/65/EU / RoHS Directive 2011/65/EU / Directive RoHS 2011/65/UE / Directiva RoHS 2011/65/UE / Direttiva RoHS 2011/65/UE / Директива RoHS 2011/65/EU

Die oben beschriebenen Produkte tragen entsprechend die Kennzeichnung CE.
 The products described above, corresponding to this, bear the CE-mark.
 Les produits décrits ci-dessus, en correspondance, portent l'indication CE.
 Los productos descritos arriba, en conformidad, llevan la indicación CE.
 I prodotti sopra descritti, conformi a quanto sopra, portano il marchio CE.
 Данные продукты в соответствии с изложенным выше маркированы знаком CE.

1 / 2

BINDER GmbH Postfach 102 D-78502 Tuttlingen Address: BINDER GmbH Im Mittleren Ösch 5 78532 Tuttlingen Germany
 Contact: Phone: +49 (0) 74 62 / 20 05 - 0 | Fax: +49 (0) 74 62 / 20 05 - 100 | info@binder-world.com | www.binder-world.com
 Managing Director: Dipl.-Ing. Peter M. Binder | District court Stuttgart, HRB 727150 | Company head office: Tuttlingen Germany
 Payment Details: Kreissparkasse Tuttlingen Account no.: 2266 BAN: 643 500 70 | IBAN-Code: DE05643 500700 000002266 | SWIFT-Code: SOLA DE S1TUT
 \$-Account no. 2202 611 55 | IBAN-Code: DE7464350070 0220 261155 | SWIFT-Code: SOLA DE S1TUT
 Deutsche Bank Tuttlingen Account no.: 2 138 709 BAN: 653 700 75 | IBAN-Code: DE56653 70075 0213870900 | SWIFT-Code: DEUT DE SS603
 Recycling of old equipment according to WEEE-Reg.-no. DE 37004983

Die oben beschriebenen Produkte sind konform mit folgenden harmonisierten Normen:
 The products described above are in conformity with the following harmonized standards:
 Les produits décrits ci-dessus sont conformes aux normes harmonisées suivantes:
 Los productos descritos arriba cumplen con las siguientes normas:
 I prodotti sopra descritti sono conformi alle seguenti normative armonizzate:
 Продукты, указанные выше, полностью соответствуют следующим стандартам:

Sicherheit / Safety / Sécurité / Seguridad / Sicurezza / Нормативы по безопасности
<ul style="list-style-type: none"> • EN 61010-1:2010 • EN 61010-2-010:2014
EMV / EMC / CEM / CEM / EMC / ЭМС
<ul style="list-style-type: none"> • EN 61326-1:2013
RoHS
<ul style="list-style-type: none"> • EN 50581:2012

78532 Tuttlingen, 03.07.2017

BINDER GmbH



P. M. Binder
 Geschäftsführender Gesellschafter
 Managing Director
 Directeur général
 Director general
 Direttore Generale
 Генеральный Директор



J. Bollaender
 Leiter F & E
 Director R & D
 Chef de service R&D
 Responsable I & D
 Direttore R & D
 Глава департамента R&D

2 / 2

BINDER GmbH Postfach 102 D-78502 Tuttlingen **Address:** BINDER GmbH Im Mittleren Ösch 5 78532 Tuttlingen Germany
Contact: Phone: +49 (0) 74 62 / 20 05 – 0 | Fax: +49 (0) 74 62 / 20 05 – 100 | info@binder-world.com | www.binder-world.com
Managing Director: Dipl.-Ing. Peter M. Binder | District court Stuttgart, HRB 727150 | Company head office: Tuttlingen Germany
Payment Details: Kreissparkasse Tuttlingen Account no.: 2266 BAN: 643 500 70 | IBAN-Code: DE05643 500700 000002266 | SWIFT-Code: SOLA DE S1TUT
 \$-Account no. 2202 811 55 | IBAN-Code: DE7464350070 0220 261155 | SWIFT-Code: SOLA DE S1TUT
 Deutsche Bank Tuttlingen Account no.: 2 138 709 BAN: 653 700 75 | IBAN-Code: DE56653 70075 0213870900 | SWIFT-Code: DEUT DE SS603
 Recycling of old equipment according to WEEE-Reg.-no. DE 37004983

24. Product registration

Online Product Registration

Register your BINDER now!

www.binder-world.com/register

The registration is free and takes just a few seconds

Advantages:

- ▶ Short response times if service is needed
- ▶ Fair prices when relocating or installing equipment
- ▶ Calibration as required at no charge in case of recalls
- ▶ Free information on news, product upgrades and accessories

Easy registered in 3 steps:



1. List serial number here: -

2. Go online: www.binder-world.com/register

3. Register serial number

25. Contamination clearance certificate

25.1 For chambers located outside the USA and Canada

Declaration regarding safety and health

Erklärung zur Sicherheit and gesundheitlichen Unbedenklichkeit

The German Ordinance on Hazardous Substances (GefStofV), and the regulations regarding safety at the workplace, require that this form be filled out for all products that are returned to us, so that the safety and the health of our employees can be guaranteed.

Die Sicherheit und Gesundheit unserer Mitarbeiter, die Gefahrstoffverordnung GefStofV und die Vorschriften zur Sicherheit am Arbeitsplatz machen es erforderlich, dass dieses Formblatt für alle Produkte, die an uns zurückgeschickt wird.



Note: A repair is not possible without a completely filled out form.
Ohne Vorliegen des vollständig ausgefüllten Formblattes ist eine Reparatur nicht möglich.

- A completely filled out form must be transmitted via Fax (+49 (0) 7462 2005 93555) or by letter in advance, so that this information is available before the equipment/component part arrives. A second copy of this form must accompany the equipment/component part. In addition, the carrier should be informed.

Eine vollständig ausgefüllte Kopie dieses Formblattes soll per Telefax (Nr. +49 (0) 7462 2005 93555) oder Brief vorab an uns gesandt werden, so dass die Information vorliegt, bevor das Gerät/Bauteil eintrifft. Eine weitere Kopie soll dem Gerät/Bauteil beigelegt sein. Ggf. ist auch die Spedition zu informieren.

- Incomplete information or non-conformity with this procedure will inevitably lead to substantial delays in processing. Please understand the reason for this measure, which lies outside our area of influence and will help us to speed up this procedure.

Unvollständige Angaben oder Nichteinhalten dieses Ablaufs führen zwangsläufig zu beträchtlichen Verzögerungen in der Abwicklung. Bitte haben Sie Verständnis für Maßnahmen, die außerhalb unserer Einflussmöglichkeiten liegen und helfen Sie mit, den Ablauf beschleunigen.

- **Please print and fill out this form completely.**

Bitte unbedingt vollständig ausfüllen!

1.	Chamber/ component part / type: / Gerät / Bauteil / Typ:
2.	Serial No./ Serien-Nr.:
3.	Details about utilized substances / biological substances / Einzelheiten über die eingesetzten Substanzen/biologische Materialien:
3.1	Designations / Bezeichnungen:
a)	_____
b)	_____
c)	_____
3.2	Safety measures required for handling these substances / Vorsichtsmaßnahmen beim Umgang mit diesen Stoffen:
a)	_____
b)	_____
c)	_____

3.3	Measures to be taken in case of skin contact or release into the atmosphere / Maßnahmen bei Personenkontakt oder Freisetzung:
a)	_____
b)	_____
c)	_____
d)	_____
3.4	Other important information that must be taken into account / Weitere zu beachtende und wichtige Informationen:
a)	_____
b)	_____
c)	_____
4.	Declaration on the risk of these substances (please checkmark the applicable items) / Erklärung zur Gefährlichkeit der Stoffe (bitte Zutreffendes ankreuzen) :
<input type="checkbox"/>	4.1 For non toxic, non radioactive, biologically harmless materials / für nicht giftige, nicht radioaktive, biologisch ungefährliche Stoffe:
We hereby guarantee that the above-mentioned chamber / component part... / Wir versichern, dass o.g. Gerät/Bauteil...	
<input type="checkbox"/>	Has not been exposed to or contains any toxic or otherwise hazardous substances / weder giftige noch sonstige gefährliche Stoffe enthält oder solche anhaften.
<input type="checkbox"/>	That eventually generated reaction products are non-toxic and also do not represent a hazard / auch evtl. entstandene Reaktionsprodukte weder giftig sind noch sonst eine Gefährdung darstellen.
<input type="checkbox"/>	Eventual residues of hazardous substances have been removed / evtl. Rückstände von Gefahrstoffen entfernt wurden.
<input type="checkbox"/>	4.2 For toxic, radioactive, biologically harmful or hazardous substances, or any other hazardous materials / für giftige, radioaktive, biologisch bedenkliche bzw. gefährliche Stoffe oder anderweitig gefährliche Stoffe.
We hereby guarantee that ... / Wir versichern, dass ...	
<input type="checkbox"/>	The hazardous substances, which have come into contact with the above-mentioned equipment/component part, have been completely listed under item 3.1 and that all information in this regard is complete / die gefährlichen Stoffe, die mit dem o.g. Gerät/Bauteil in Kontakt kamen, in 3.1 aufgelistet sind und alle Angaben vollständig sind.
<input type="checkbox"/>	That the chamber /component part has not been in contact with radioactivity / das Gerät/Bauteil nicht mit Radioaktivität in Berührung kam
5.	Kind of transport / transporter / Transportweg/Spediteur:
Transport by (means and name of transport company, etc.) Versendung durch (Name Spediteur o.ä.)	

Date of dispatch to BINDER GmbH / Tag der Absendung an BINDER GmbH:	

We hereby declare that the following measures have been taken / Wir erklären, dass folgende Maßnahmen getroffen wurden:

- Hazardous substances were removed from the chamber including component parts, so that no hazard exists for any person in the handling or repair of these items / das Gerät/Bauteil wurde von Gefahrstoffen befreit, so dass bei Handhabung/Reparaturen für die betreffende Person keinerlei Gefährdung besteht
- The chamber was securely packaged and properly identified / das Gerät wurde sicher verpackt und vollständig gekennzeichnet.
- Information about the hazardousness of the shipment (if required) has been provided to the transporter / der Spediteur wurde (falls vorgeschrieben) über die Gefährlichkeit der Sendung informiert.

We hereby commit ourselves and guarantee that we will indemnify BINDER GmbH for all damages that are a consequence of incomplete or incorrect information provided by us, and that we will exempt BINDER GmbH from eventual damage claims by third parties./ Wir versichern, dass wir gegenüber BINDER für jeden Schaden, der durch unvollständige und unrichtige Angaben entsteht, haften und BINDER gegen eventuell entstehende Schadenansprüche Dritter freistellen.

We are aware that, in accordance with Article 823 of the German Civil Code (BGB), we are directly liable with regard to third parties, in this instance especially the employees of BINDER GmbH, who have been entrusted with the handling / repair of the chamber / component. / Es ist uns bekannt, dass wir gegenüber Dritten – hier insbesondere mit der Handhabung/Reparatur des Geräts/des Bauteils betraute Mitarbeiter der Firma BINDER - gemäß §823 BGB direkt haften

Name: _____

Position/Title: _____

Date / Datum: _____

Signature / Unterschrift: _____

Company stamp / Firmenstempel:



Equipment that is returned to the factory for repair must be accompanied by a completely filled out contamination clearance certificate. For service and maintenance on site, such a contamination clearance certificate must be submitted to the service technician before the start of any work. No repair or maintenance of the equipment is possible, without a properly filled out contamination clearance certificate.

25.2 For chambers in the USA and Canada

Product Return Authorization Request

Please complete this form and the Customer Decontamination Declaration (next 2 pages) and attach the required pictures. E-mail to: IDL_SalesOrderProcessing_USA@binder-world.com

After we have received and reviewed the complete information we will decide on the issue of a RMA number. Please be aware that size specifications, voltage specifications as well as performance specifications are available on the internet at www.binder-world.us at any time.

Take notice of shipping laws and regulations.

	Please fill:	
Reason for return request	<input type="radio"/> Duplicate order	
	<input type="radio"/> Duplicate shipment	
	<input type="radio"/> Demo	<i>Page one completed by sales</i>
	<input type="radio"/> Power Plug / Voltage	115V / 230 V / 208 V / 240V
	<input type="radio"/> Size does not fit space	
	<input type="radio"/> Transport Damage	Shock watch tripped? (<i>pictures</i>)
	<input type="radio"/> Other (specify below)	

Is there a replacement PO?	<input type="radio"/> Yes <input type="radio"/> No	
<i>If yes -> PO #</i>		
<i>If yes -> Date PO placed</i>		
Purchase order number		
BINDER model number		
BINDER serial number		
Date chamber was received		
Was the chamber unboxed?	<input type="radio"/> Yes <input type="radio"/> No	
Was the chamber plugged in?	<input type="radio"/> Yes <input type="radio"/> No	
Was the chamber in operation?	<input type="radio"/> Yes <input type="radio"/> No	
<i>Pictures of chamber attached?</i>	<input type="radio"/> Yes <input type="radio"/> No	Pictures have to be attached!
<i>Pictures of Packaging attached?</i>	<input type="radio"/> Yes <input type="radio"/> No	

	Customer Contact Information	Distributor Contact Information
Name		
Company		
Address		
Phone		
E-mail		

Customer (End User) Decontamination Declaration

Health and Hazard Safety declaration

To protect the health of our employees and the safety at the workplace, we require that this form is completed by the user for all products and parts that are returned to us. (Distributors or Service Organizations cannot sign this form)

	<p>NO RMA number will be issued without a completed form. Products or parts returned to our NY warehouse without a RMA number will be refused at the dock.</p>
---	--

A second copy of the completed form must be attached to the outside of the shipping box.

1.	Chamber/ component part / type:
2.	Serial No.
3.	List any exposure to hazardous liquids, gasses or substances and radioactive material
3.1	List with MSDS sheets attached where available or needed (if there is not enough space available below, please attach a page):
a)	_____
b)	_____
c)	_____
3.2	Safety measures required for handling the list under 3.1
a)	_____
b)	_____
c)	_____
3.3	Measures to be taken in case of skin contact or release into the atmosphere:
a)	_____
b)	_____
c)	_____
d)	_____
3.4	Other important information that must be considered:
a)	_____
b)	_____
c)	_____

4. Declaration of Decontamination

For toxic, radioactive, biologically and chemically harmful or hazardous substances, or any other hazardous materials.

We hereby guarantee that

- 4.1 Any hazardous substances, which have come into contact with the above-mentioned equipment / component part, have been completely listed under item 3.1 and that all information in this regard is complete.
- 4.2 That the chamber /component part has not been in contact with radioactivity
- 4.3 Any Hazardous substances were removed from the chamber / component part, so that no hazard exists for a persons in the shipping, handling or repair of these returned chamber
- 4.4 The chamber was securely packaged in the original undamaged packaging and properly identified on the outside of the packaging material with the chamber designation, the RMA number and a copy of this declaration.
- 4.5 Shipping laws and regulations have not been violated.

I hereby commit and guarantee that we will indemnify BINDER Inc. for all damages that are a consequence of incomplete or incorrect information provided by us, and that we will indemnify and hold harmless BINDER Inc. from eventual damage claims by third parties..

Name: _____

Position: _____

Company: _____

Address: _____

Phone #: _____

Email: _____

Date: _____

Signature: _____



Equipment returned to the NY warehouse for repair must be accompanied by a completed customer decontamination declaration. For service and maintenance works on site, such a customer decontamination declaration must be submitted to the service technician before the start of work. No repair or maintenance of the equipment is possible without a completed form.