

# GENIUS<sup>®</sup>

SINCE 1975

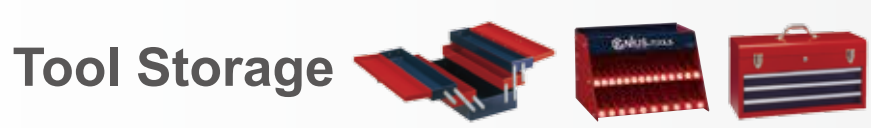

GT-19-3





A2- A78



B2- B94



C2- C61



D2- D62



E2- E29



F2- F40



G2- G18



H2- H68



I2- I8



J2- J20

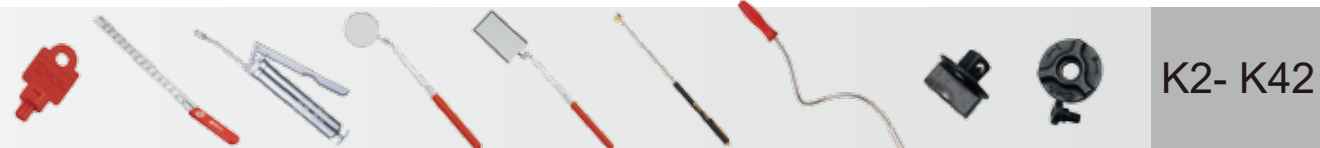

K2- K42



You may find out more detailed information by looking at different indexes:

1. Drive Size Index on page 2
2. Numerical Index on page Z-2 ~ Z-59
3. Alphabetical Index on page Z-60 ~ Z-63

# Drive Size Index

## 1/4" Drive

Air Ratchets	E-2
Deep Hand Sockets (6-Point)	B-2
Deep Hand Sockets (12-Point)	B-3
Deep Impact Sockets	A-3
Double Square Hand Sockets	B-4
E-Star Hand Sockets	B-4
Hand Adapters	B-7
Hand Bit Holders	D-21
Hand Extension Bars	B-7
Hand Sockets (6-Point)	B-2
Hand Sockets (12-Point)	B-3
Hex Bit Sockets	C-18
Hex Head Hand Sockets	B-5
Hinge Handles	B-6
Impact Adapters	A-3
Impact Bit Holders	A-3
Impact Extension Bars	A-3
Impact Sockets	A-2
Impact Universal Joints	A-3
Pentacle Bit Sockets	C-22
Phillips Bit Sockets	C-17
Phillips Head Hand Sockets	B-4
Ratchets	B-5
Ribe Bit Sockets	C-20
Sliding T-Handles	B-7
Slotted Bit Sockets	C-17
Slotted Head Hand Sockets	B-4
Spanner Bit Sockets	C-22
Star Bit Sockets	C-20
Tamperproof Star Bit Sockets	C-21
Triple Square Bit Sockets	C-21
Universal Hand Sockets	B-4
Universal Joint	B-7
Wobble Extension Bars	B-7
Wobble Hex Bit Sockets	C-18

## 3/8" Drive

Air Impact Wrenches	E-3
Air Ratchets	E-2
Deep Hand Sockets (6-Point)	B-21
Deep Hand Sockets (12-Point)	B-23
Deep Impact Sockets (CRV)	A-6
Deep Impact Sockets (CRMO)	A-13
E-Star Hand Sockets	B-20
Hand Adapters	B-24
Hand Bit Holders	D-21
Hand Extension Bars	B-24
Hand Sockets (6-Point)	B-20
Hand Sockets (12-Point)	B-22
Hex Bit Sockets	C-24
Hex Head Drivers	C-4
Hinge Handles	B-26
Impact Adapters (CRV)	A-7
Impact Adapters (CRMO)	A-14
Impact Bit Holders (CRV)	A-7
Impact Bit Holders (CRMO)	A-14
Impact Driver	D-38
Impact Extension Bars (CRV)	A-7
Impact Extension Bars (CRMO)	A-14
Impact Sockets (CRV)	A-5
Impact Sockets (CRMO)	A-12
Impact Universal Joint	A-7
L-Handle	B-25
Pentacle Bit Sockets	C-31
Phillips Bit Sockets	C-23
Phillips Head Drivers	C-2
Ratchets	B-26
Ribe Bit Sockets	C-32
Sliding T-Handle	B-25
Slotted Bit Sockets	C-23
Slotted Head Drivers	C-2
Spark Plug Sockets	B-25
Speed Handle	B-25
Star Bit Sockets	C-28
Star Head Drivers	C-3
Stud Bolt Sockets	J-19

Swivel Impact Sockets	A-9
Tamperproof Star Bit Sockets	C-29
Triple Square Bit Sockets	C-30
Triple Square Head Drivers	C-6
Universal Hand Sockets	B-23
Universal Joint	B-24
Wobble Extension Bars	B-24
Wobble Hex Bit Sockets	C-26

## 1/2" Drive

Air Impact Wrenches	E-4
Air Ratchets	E-2
Deep Hand Sockets (6-Point)	B-39
Deep Hand Sockets (12-Point)	B-41
Deep Impact Sockets (CRV)	A-18
Deep Impact Sockets (CRMO)	A-31
Deep Thin Wall Impact Sockets (12-Point)	A-34
E-Star Deep Hand Sockets	B-42
E-Star Deep Impact Sockets	A-35
E-Star Hand Sockets	B-42
E-Star Impact Sockets	A-35
Hand Adapters	B-42
Hand Bit Holders	D-21
Hand Extension Bars	B-46
Hand Sockets (6-Point)	B-38
Hand Sockets (12-Point)	B-40
Hex Bit Sockets	C-49
Hex Head Drivers	C-8
Hinge Handles	B-44
Impact Adapters (CRMO)	A-36
Impact Bit Holders (CRMO)	A-36
Impact Driver	D-38
Impact Extension Bars (CRV)	A-18
Impact Extension Bars (CRMO)	A-36
Impact Sockets (CRV)	A-17
Impact Sockets (CRMO)	A-30
Impact Universal Joint	A-18
L-Handle	B-43
Pentacle Bit Sockets	C-53
Phillips Bit Sockets	C-48
Phillips Head Drivers	C-7
Ratchets	B-44
Ribe Bit Sockets	C-53
Semi-Deep Thin Wall Impact Sockets (6-Point)	A-33
Sliding T-Handle	B-43
Slotted Bit Sockets	C-48
Slotted Head Drivers	C-7
Spark Plug Sockets	B-43
Speed Handles	B-42
Star Bit Sockets	C-54
Star Head Drivers	C-7
Stud Bolt Sockets	J-19
Stud Remover Sockets	J-20
Swivel Impact Sockets	A-26
Tamperproof Star Bit Sockets	C-55
Thin Wall Impact Sockets (6-Point)	A-32
Thin Wall Impact Sockets (12-Point)	A-33
Triple Square Bit Sockets	C-56
Triple Square Head Drivers	C-8
Universal Joint	B-43
Wobble Extension Bars	B-46
Wobble Hex Bit Sockets	C-52

## 3/4" Drive

Air Impact Wrenches	E-10
Deep Hand Sockets	B-80
Deep Impact Sockets	A-44
Deep Thin Wall Impact Sockets (6-Point)	A-45
Hand Adapters	B-83
Hand Extension Bars	B-83
Hand Sockets (6-Point)	B-78
Hand Sockets (12-Point)	B-82
Hex Bit Sockets	C-12
Hex Head Drivers	C-12
Hinge Handles	B-84
Impact Adapters	A-46
Impact Bit Holders	D-20

Impact Extension Bars	A-47
Impact Sockets	A-42
Impact Universal Joints	A-47
L-Handles	B-83
Ratchets	B-84
Sliding T-Handles	B-84
Star Bit Sockets	C-13
Thin Wall Impact Sockets (12-Point)	A-46
Triple Square Bit Sockets	C-13
Truck Wheel Impact Sockets	A-49
Universal Joints	B-83

## 1" Drive

Air Impact Wrenches	E-13
Deep Impact Sockets	A-55
Hand Adapters	B-94
Hand Extension Bars	B-94
Hand Sockets (6-Point)	B-89
Hand Sockets (12-Point)	B-92
Hex Bit Sockets	C-14
Hex Head Drivers	C-15
Hinge Handles	B-94
Impact Adapters	A-59
Impact Bit Holders	D-20
Impact Extension Bars	A-59
Impact Sockets	A-54
Impact Universal Joints	A-59
Ratchets	B-94
Sliding T-Handles	B-94
Thin Wall Deep Impact Sockets (6-Point)	A-59
Thin Wall Impact Sockets (6-Point)	A-59
Truck Wheel Impact Sockets	A-65
Universal Joint	B-94

## 1-1/2" Drive

Air Impact Wrenches	E-17
Deep Impact Sockets	A-68
Hex Bit Sockets	C-16
Impact Adapters	A-67
Impact Bit Holders	D-20
Impact Extension Bars	A-69
Impact Sockets	A-66
Impact Universal Joint	A-67
Sliding T-Handle	A-69

## 2-1/2" Drive

Impact Adapter	A-70
Impact Extension Bars	A-70
Impact Sockets	A-70

## 3-1/2" Drive

Impact Sockets	A-73
----------------	------

## #5 Spline Drive

Air Impact Wrenches	E-18
Deep Impact Sockets	A-77
Impact Adapters	A-78
Impact Extension Bars	A-78
Impact Sockets	A-76
Impact Universal Joint	A-78
Thin Wall Impact Sockets	A-77
Truck Wheel Impact Sockets	A-78

## Other Tools

Automotive Tools	J-2
Files	G-12
Hammers	G-14
Key Wrenches	F-22
Locking Pliers	G-5
Master Sets	H-2
Pliers	G-2
Riveters	G-6
Screwdriver Bits	D-2
Screwdrivers	D-40
Spinner Handles	D-22
Tool Storage	I-2
Torque Tools	F-35
Wrenches	F-2



## INTRODUCTION

**GENIUS Tools'** commitment to creating the highest quality of tools dates back to 1975, and that tradition continues today – supported by the best engineering talent, professional manufacturing, and invaluable feedbacks from customers. We have grown to carry a wide range of hand tools, pneumatic tools, automotive tools, and tool storage, providing over 9,000 unique items. GENIUS Tools offers efficient, durable, and cost-effective solutions to professional users worldwide.

**GENIUS Tools** has always aimed to shatter the market misconception that high quality tools is necessarily coupled with unaffordable prices. We dedicate ourselves to developing high quality products to deliver outstanding reliability and durability to users who do not wish to compromise product performance for price, actively engaging our resources in research and development to improve products and exceed the expectations of our customers.

**GENIUS Tools** has already won recognition and support from its customers for our emphasis on customer service and production of high quality products. At present, our operation has expanded to over 84 countries worldwide, creating strong bonds with clients in a range of industries including automotive, hardware, heavy-duty, mining, shipbuilding, and a number of other manufacturing-related fields. With offices and warehouses in North America, Asia, and Europe collaborating with a well established distribution network worldwide, our inventory and support are readily accessible, enabling us to continually provide on-time delivery service and after-sales service.



# GENIUS QUALITY

## Product Quality

The best quality and on time delivery are key factors to GENIUS Tools success in the market. The exact careful research and development, professional manufacturing and complete after sales service are also keys for our continuous operation. GENIUS Tools' quality begins with selecting the best raw materials, namely Chrome Vanadium steel, Chrome Molybdenum steel, S2 steel, and utilize the latest technologies in design and manufacturing such as: computer-aided design, cold forming, hot forging, extrusion, heat treatment, polishing and many more. From product development to mass production, we carefully look into each stage in the process include raw material inspection, production control, quality and function test, and to the final packaging and delivery, we are serious about our products quality performance and free of defect.



## Innovation Quality

With series of tightly controlled research and development procedures from early ideation, inspection of related standards and market information, design and drawing, technology discussion, sample production, test and inspection and lastly volume production, GENIUS Tools always starts out with customers demand and develop and improve products that are most suited for the market using latest technologies, the best in testing equipment and state of the art manufacturing processes to keep its designs functional and effective.

## Service Quality

GENIUS Tools constantly focuses on delivering the quality products and services that professional tool users demand. By expanding our operations to different countries and regions: North America, Central America, Europe, Middle East and Asia, we are able to provide On-Time Delivery and better after sales service to our customers worldwide with satisfactions. At GENIUS Tools, we value each customer's feedback so we can translate these messages into quality products and top performance tools and make continuous improvements to optimize both our products and service. If you have any comments, please kindly send us an e-mail to: [info@geniustools.net](mailto:info@geniustools.net)

## **AFTER SALES SERVICE**

### **Lifetime Warranty**

- a. All GENIUS brand products are warranted against defects in materials and workmanship for the expected usable life of the product.
- b. Any tool that fails to give satisfactory service due to defective materials or workmanship will, after inspection, be repaired or replaced free of charge with a new or reconditioned product, provided it is shipped prepaid to GENIUS Tools service center along with a copy of proof of purchase.
- c. At the discretion of GENIUS Tools, a refund may also be provided to customer in form of credit with an amount equal to the original purchase price.
- d. All claimed defective tools must be returned to the place of purchase. A copy of the invoice proving the date of purchase from the distributor will be required in the event of a warranty claim. The warranty period takes effect from the date of purchase and only extends to the original customer and cannot be transferred or assigned.
- e. Consumable products are warranted, at the time of sale only, against defects in workmanship or materials that prevent their use. Consumable products are goods reasonably expected to be used up or damaged during use.

### **Limited Warranty**

- a. All Torque Wrenches (exclude Torque Calibration), Torque Multipliers, Torque Screwdrivers, and all Air Powered, Electric Powered & Battery Powered Tools are only parts warranted for a period of one year. For regions where GENIUS Tools does not have its own service center, GENIUS Tools will supply 2% spare parts free of charge to the distributor for repair and maintenance.
- b. Moving parts of Ratchets, Hinge Handles, Speed Handles, Sliding T-handles, Impact Drivers, Adjustable Wrenches, and Pipe Wrenches are warranted against defects in material and workmanship for the life of the product. This warranty is limited to the repair and replacement, without charge, of said moving parts and is not valid on any irreparable damage sustained on the main bodies of these tools. This warranty does not cover damage attributable to normal wear and tear. Warranty does not cover associated shipping and handling costs.
- c. Warranty will be voided if the damage has occurred due to accident, abuse, misuse, neglect or modification. Upon inspection and approval, GENIUS Tools, at its option, will repair or replace any defective parts and charge parts and labor costs.

- d. GENIUS Tools will also charge shipping and labor costs if the returned product requires regular maintenance only.
- e. GENIUS Tools products used on assembly process have a limited 60-Day warranty, from the date of purchase, against defects in material and workmanship.

## Non-Warranty

- a. Due to the nature of the product, the following products are not covered by any warranty: Reducing Adapters, Thin Wall Sockets, Swivel Sockets, Impact Universal Joints, Wobble Extension Bars, Stud Bolt Sockets, Torque Calibration, Cutting Tools, Extractors, Files, Picks, Punches, Chisels, Spanner Bits, Batteries, Tool Storage, plastic- or rubber-made materials such as handles, items that are 6.35mm in size and under and discontinued items. For more information on discontinued items, please see Return & Exchange Policy section.
- b. GENIUS Tools does not provide warranty for products labeled other than GENIUS.
- c. No warranty consideration can be made if the initial inspection shows that the tool has been abused, misused, neglected, altered, improperly maintained or worn out from use. Broken handles, bent shafts, snipe or hammer marks also void warranty. Figure 1, 2, 3, 4 and as such are not covered by any warranty.
- d. Consumable products are goods reasonably expected to be used up or damaged during use.

	<p><b>Figure 1</b> Broken screwdriver tips and bent shafts are the result of using screwdrivers as pry bars, punches, chisels or levers</p>
	<p><b>Figure 2</b> All products that have been worn, altered, neglected, abused, or misused, are not under warranty</p>
	<p><b>Figure 3</b> The length of a tool is designed to furnish suitable stress levels. Use pipes or other devices on any of the tools to increase leverage may put stress and fatigue on a tool which are beyond the design of the tool. When this happens, the tool can break.</p>
	<p><b>Figure 4</b> Use hand sockets with an impact or power wrench can wear out the sockets and cause peened metal around the drive.</p>



## Limited Liability

- a. GENIUS Tools will not accept any liability for incidental or consequential losses to the customer incurred by the purchaser losing the use of one or more of our products.
- b. GENIUS Tools is not responsible for any damage or personal injury that may result from the misuse, alteration, abuse, or use beyond the expected life of its products, or using tools which have been improperly repaired or maintained.

## Change of Product Design

- a. GENIUS Tools reserves the right to make changes in design, appearance or construction of all products at any time without incurring any obligation in making such changes in products previously distributed.
- b. GENIUS Tools also reserves the right to discontinue the availability of any products at such time GENIUS Tools considers necessary.
- c. Features, dimensions, descriptions and images of products in the brochures, catalogs and online catalogs are subject to change without notice.

## Shipping

- a. Unless otherwise stated, shipping costs will be charged for shipments to a customer's location.
- b. Any additional charges incurred for service, such as customer's carrier or special handling by the carrier, must be paid by the consignee.
- c. Item backordered that qualified for prepaid shipping will be shipped prepaid.
- d. Loss or damage that occurs during shipping by a carrier selected by customer is customer's responsibility. Loss or damage that occurs during shipping by a carrier selected by GENIUS Tools is GENIUS Tools' responsibility.
- e. GENIUS Tools agrees to pay one-way return shipping costs only on product that has been approved for warranty work, or exchange. This condition will be voided if the returned product appears to have been abused, misused, neglected, altered, badly worn, or treated with lack of maintenance.

## Return and Exchange Policy

- a. If you have received an incorrect product, ordered the wrong item or you are not fully satisfied with our product, you may return the product, prepaid, for a refund or an exchange only if the product has not been used with and is in its original condition and packaging. If the product is no longer in its original packaging, it cannot be returned unless the product is defective.
- b. To receive a refund or exchange please contact us by phone or e-mail and indicate the reason you would like to return the product. We will then issue an RA# (Return Authorization Number) and absolutely no items without an RA# may be returned. Any items without an RA# will not be accepted at our warehouse.
- c. Customer will be responsible for shipping costs for the returns except in the case of the incorrect product being shipped by GENIUS Tools, or in the case of a damaged or defective product. Once we receive the product we will ship a replacement product back to customer free of charge.
- d. All returns and exchanges should be within 30 days from the date of purchase in its original condition and packaging. There will be a 20% restocking fee on all returned or exchanged item(s). An original receipt is required for all returns, exchanges and warranty repair services. If, however, the product has been used and you are not fully satisfied with it, you may return or exchange the product within 7 days from the date of purchase along with a copy of proof of purchase.
- e. When a warranty product is discontinued or no replacement is available, GENIUS Tools will offer a credit for the value of discontinued product at the time of sale. An original receipt is required.

## Cancellation

- a. Any cancellation must be approved by GENIUS Tools, and may be subject to restocking fee and other charges.

## Delay

- a. GENIUS Tools shall not be held liable for any damage as a result of any delay or failure to deliver product due to causes of Acts of God, government regulation, strike, inability to procure product, supplies or raw materials, delay in transportation or any other circumstances or cause beyond reasonable control of GENIUS Tools.
- b. In the event of such delay, the date of delivery shall be extended for a period equal to the length of delay.

# SAFETY RECOMMENDATION

Please read and follow the basic safety rules below in order to avoid injury and to give the tools their best performance with a long serviceable life.



Read instructions before use



Do not use pipes or other extensions with wrenches to increase leverage

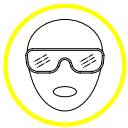

Wear safety goggles



Do not use screwdrivers as pry bars, punches, chisels or levers



Make sure that the screwdriver blade is vertical to the screw



Do not hit wrenches or ratchets with a hammer



Make sure that the fastener head is engaged fully



Do not use hand sockets with an impact or power wrench



Do not modify tools for safety



Do not open multiple drawers



# DRAWER ORGANIZERS

Plastic Tray:

- High quality drawer insert to keep your tool chest organized and protected.
- We have designed five interchangeable insert sizes ( 1/6, 1/3, 1/2, 2/3 and full size) allowing you to mix and match your favorite tool selection within each drawer.
- For best fit, use with GENIUS brand tool chests.

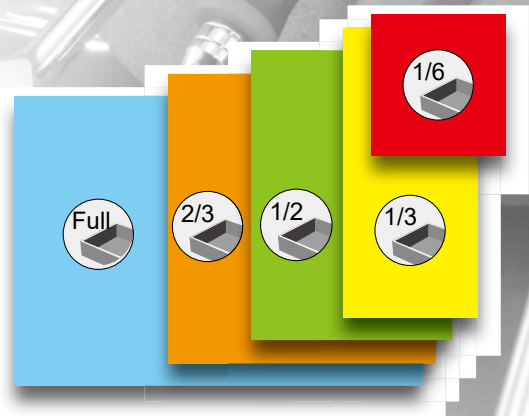

Since 1975

# GENIUS<sup>®</sup> TOOLS



## 100 Teeth Ratchet w/ Quick Release

Item No.	Drive size	Length mm(inch)	Weight g	PCS inner/ctn	G.W. KGS	CUFT
282100	1/4"	140(5.5")	135	40 / 80	12.0	0.48
282100L	1/4"	207(8")	160	40 / 80	14.0	0.48
383100	3/8"	180(7")	270	30 / 60	17.5	0.48
383100L	3/8"	305(12")	350	20 / 60	22.0	0.70
484100	1/2"	250(10")	550	1 / 30	17.5	0.34
484100L	1/2"	415(16")	750	1 / 30	23.5	0.53

- 3.6° increments for final tightening
- Aluminum grip prevents grease and oil absorption
- Dustproof and oilproof
- Small gear head & extra-long handle
- With Automated Optical Inspection to maximize gear precision



## GS-318M1X 18 Piece 3/8" Dr. Metric Hand Socket Set w/ 100 Teeth Ratchet

Item No.	Size	Item No.	Size
<b>3/8" Dr. 6pt Hand Socket:</b>			
323206	6mm	323214	14mm
323207	7mm	323215	15mm
323208	8mm	323216	16mm
323210	10mm	323217	17mm
323211	11mm	323219	19mm
323212	12mm	323221	21mm
323213	13mm		

### 3/8" Dr. Accessory:

320075	Extension Bar, 75mmL
320150	Extension Bar, 150mmL
380030	Sliding T-Handle
326021	20.6mm Spark Plug Socket
383100	100T Quick Release Ratchet

Metal Box

2400 g 10 sets / 25 Kgs / 0.77 CUFT

substitute 22 for 21mm: GS-318M2X also available  
SAE sizes: GS-318S1X also available  
12-point: TW-318M1X (M2X) & TW-318S1X also available



6 pt.

## GS-427MX 27 Piece 1/2" Dr. Metric Hand Socket Set w/ 100 Teeth Ratchet

Item No.	Size	Item No.	Size
<b>1/2" Dr. 6pt Hand Socket:</b>			
423810	10mm	423821	21mm
423811	11mm	423822	22mm
423812	12mm	423823	23mm
423813	13mm	423824	24mm
423814	14mm	423826	26mm
423815	15mm	423827	27mm
423816	16mm	423828	28mm
423817	17mm	423830	30mm
423818	18mm	423832	32mm
423819	19mm		

### 1/2" Dr. Accessory:

424125	Extension Bar, 125mmL
424250	Extension Bar, 250mmL
480070	Universal Joint
480040	Sliding T-Handle
427021	20.6mm Spark Plug Socket
480446A	Hinge Handle
480446PP	Pin Handle
484100	100T Quick Release Ratchet

Metal Box

6750 g 4 sets / 28 Kgs / 0.88 CUFT

SAE sizes: GS-427SX also available  
12-point: TW-427MX & TW-427SX also available



6 pt.

## MS-114TX 114 Piece 1/4", 3/8" & 1/2" Dr. Metric Mechanic Tool Set

Item No.	Pcs	Description
TS-3244X	44	A 44pcs 1/4" & 3/8" Dr. Metric Hand Socket Set
TS-4222X	22	B 22pcs 1/2" Dr. Metric Hand Socket Set
TS-7418	18	C 18pcs Metric Combination Wrench Set
TS-5010	10	D 10pcs Combination Screwdriver Set
TS-5004	4	E 4pcs Set-Hammer, Pliers, & Adjustable Wrench
TS-5005	5	F 5pcs Set-Pliers, Knife & Measuring Tape
HK-09MBS	9	9pcs S2 Wobble Hex Key Wrench, 1.5 ~ 10mm
HS-12	1	Heavy Duty Hacksaw
TS-125	1	5 Tier Portable Tool Chest

21 Kg

1 set / 22 Kgs / 2 CUFT



### Heavy Duty Hacksaw

ITEM No.	Blade Length	Weight g	PCS inner/ctn	G.W. KGS	CUFT
HS-12	12"	180	6 / 24	18.5	1.80

#### Features:

- High Tension
- With 12"L Bi-Metal Hacksaw Blade, 24TPI



### Heavy Duty Snap-off Knife

ITEM No.	Blade width	Weight g	PCS inner/ctn	G.W. KGS	CUFT
KN-4018	18mm	180	12 / 72	14.2	1.50

#### Features:

- Auto-Loading System
- With 4pcs SK-2 0.5mm Blade



### Auto Locking Measuring Tape

ITEM No.	Length m(feet)	Wide mm(inch)	Weight g	PCS inner/ctn	G.W. KGS	CUFT
MT-83525	5(16')	25(1")	315	6 / 48	17.4	2.35

#### Features:

- Two-Side Scale Printing w/Bi-Color Coating
- Long Rubber Hook w/Magnet
- Rubber Grip & Anti-Slip Hook



### Double Locking Measuring Tape

ITEM No.	Length m(feet)	Wide mm(inch)	Weight g	PCS inner/ctn	G.W. KGS	CUFT
MT-80525	5(16')	25(1")	270	3 / 60	18.0	1.07

#### Features:

- Double Locking System (Stop & Pause Button)
- Streamlined ABC Case



New Items

## AC234161S 161 Piece 1/4", 3/8" & 1/2" Dr. Metric & SAE Master Set (Rubber Handle)

Item No.	Pcs	Description	Item No.	Pcs	Description
222504	11	1/4" Dr. 6-Point Metric Hand Sockets:	27206P	3	1/4" Hex Shank Spinner Handle:
222512		4, 4.5, 5, 5.5, 6, 7, 8, 9, 10, 11, 12mm	27406P		1/4", 3/8" & 1/2" Dr.
282504	7	1/4" Dr. 6-Point SAE Hand Sockets:	726008	12	Metric Combination Wrenches: 8, 9, 10,
282511		1/8, 3/16, 7/32, 1/4, 9/32, 5/16, 11/32"	726019		11, 12, 13, 14, 15, 16, 17, 18, 19mm
252504	6	1/4" Dr. Star Hand Sockets:	HK-009MB	9	Metric L-Shaped Wobble Hex Wrenches:
252510		E4, 5, 6, 7, 8, 10	550601	3	1.5, 2, 2.5, 3, 4, 5, 6, 8, 10mm
225208	6	1/4" Dr. 6-Point Metric Deep Hand Sockets:	550603		6" Linesman, 6" Longnose &
225214		8, 9, 10, 12, 13, 14mm	220002	2	6" Diagonal Cutting
323213	7	3/8" Dr. 6-Point Metric Hand Sockets:	220006		1/4" Dr. Hand Extension Bars:
323219		13, 14, 15, 16, 17, 18, 19mm	280231S	1	50mmL(2"), 150mmL(6"L)
373212	9	3/8" Dr. 12-Point SAE Hand Sockets:	280070	1	1/4" Dr. 36T Quick Release Ratchet
373228		3/8, 7/16, 1/2, 9/16, 5/8, 11/16, 3/4, 13/16, 7/8"	506+0175	1	1/4" Dr. Hand Universible Joint
353512	5	3/8" Dr. Star Hand Socket:	282408	1	1/4" Dr. Socket Driver
353520		E12, 14, 16, 18, 20	286008	1	1/4" Dr. Hex Bit Holder
423820	7	1/2" Dr. 6-Point Metric Hand Sockets:	320075	1	1/4" Dr. Magnetic Bit Holder Adapter
423832		20, 21, 22, 24, 27, 30, 32 mm	380331S	1	3/8" Dr. Hand Extension Bar, 75mmL(3"L)
473830	4	1/2" Dr. 12-Point SAE Hand Sockets:	326014	3	3/8" Dr. 36T Quick Release Ratchet
473840		15/16, 1, 1-1/16, 1-1/4"	326021		3/8" Dr. Spark Plug Sockets:
417817	3	1/2" Dr. 6-Point Metric Deep Impact Sockets:	380070	1	14.0, 16.0 & 20.6mm
417821		17, 19, 21mm	424128	2	3/8" Dr. Hand Universal Joint
SB-111SP	10	1/4" Hex Shank Bits: #0, #1, #2, #3, 0.5x3.0, 0.6x4.0, 0.8x5.0, 1.0x6.0, 1.2x7.0mm	424253		1/2" Dr. Hand Extension Bars:
1210	1	1/4" Hex Shank 1/4" Square Adapter	320042	1	125mmL(5"), 250mmL(10"L)
1213	4	1/4" Hex Shank Posidriv Bits: #0, #1, #2, #3	480431S	1	2-way Adapter, 3/8"F x 1/2"M
SB-211MH	8	1/4" Hex Shank Hex Bits: 2, 2.5, 3, 4, 5, 6, 7, 8mm	480070	1	1/2" Dr. 36T Quick Release Ratchet
3		1/4" Hex Shank Triple Square Bits: M4, M5, M6			1/2" Dr. Hand Universal Joint
SB-711TP	11	1/4" Hex Shank Star Bits: T6, 7, 8, 9, 10, 15, 20, 25, 27, 30, 40			Blow Case
SB-811TP	11	1/4" Hex Shank Tamperproof Star Bits: T7, 8, 9, 10, 15, 20, 25, 27, 30, 40, 45			
283050A	3	1/4" Hex Shank Tamperproof Star Bits: T50, 55, 60			
283060A					

11.1 Kg

2 sets / 23.0 Kgs / 1.6 CUFT



AC234161P



AC234161R



AC234161A



# New Items

## SAE Hex Head Drivers

Item No.	A	D	Length	Weight	PCS	G.W.	CUFT
	inch	mm	mm	g	inner/ctn	KGS	
467606	3/16	24	76	70	10 / 140	10.8	0.44
467608	1/4	24	76	75	10 / 140	11.5	0.44
467610	5/16	24	76	85	10 / 140	13.0	0.44
467612	3/8	26	76	100	10 / 140	15.0	0.44
467614	7/16	26	76	120	10 / 140	17.8	0.44
467616	1/2	26	76	140	10 / 140	20.5	0.44
467618	9/16	26	76	150	10 / 120	19.0	0.52
467620	5/8	28	76	185	10 / 120	23.2	0.52
467622	11/16	28	76	200	10 / 120	25.0	0.52
467624	3/4	28	76	225	10 / 80	19.0	0.38

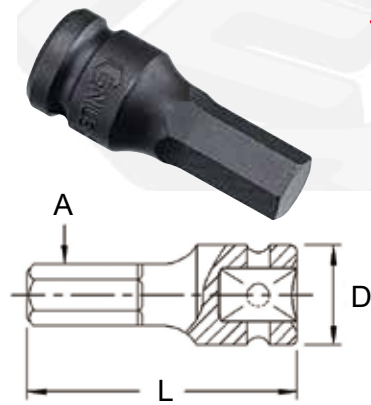

## Metric & SAE Wobble Hex Head Drivers

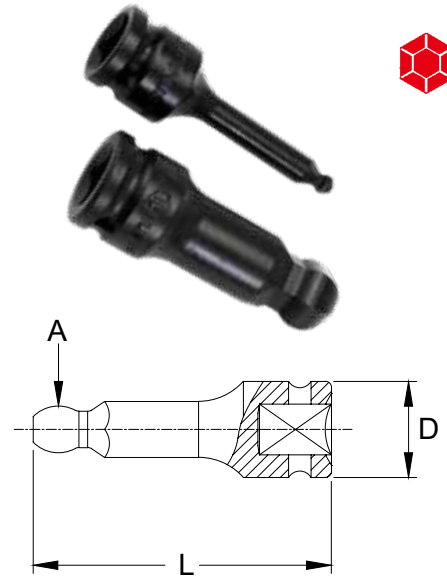

Item No.	A	D	Length	Weight	PCS	G.W.	CUFT
	mm / inch	mm	mm	g	inner/ctn	KGS	
4476W04	4	24	76	70	10 / 140	10.8	0.44
4476W05	5	24	76	70	10 / 140	10.8	0.44
4476W06	6	24	76	75	10 / 140	11.5	0.44
4476W07	7	24	76	75	10 / 140	11.5	0.44
4476W08	8	24	76	80	10 / 140	12.2	0.44
4476W10	10	26	76	105	10 / 140	15.7	0.44
4476W12	12	26	76	120	10 / 140	17.8	0.44
4476W14	14	26	76	140	10 / 120	17.8	0.52
4476W17	17	28	76	185	10 / 120	23.2	0.52
4476W19	19	28	76	210	10 / 80	17.8	0.38
4676W06	3/16	24	76	70	10 / 140	10.8	0.44
4676W08	1/4	24	76	75	10 / 140	11.5	0.44
4676W10	5/16	24	76	80	10 / 140	12.2	0.44
4676W12	3/8	26	76	100	10 / 140	15.0	0.44
4676W14	7/16	26	76	110	10 / 140	16.5	0.44
4676W16	1/2	26	76	130	10 / 140	19.2	0.44
4676W18	9/16	26	76	145	10 / 120	18.5	0.52
4676W20	5/8	28	76	175	10 / 120	22.0	0.52
4676W22	11/16	28	76	190	10 / 120	23.8	0.52
4676W24	3/4	28	76	210	10 / 80	17.8	0.38



## TH-410MD 10 Piece 1/2" Dr. Metric Hex Head Driver Set SAE size: TH-410SD also available

Item No.	Size	Item No.	Size
<b>1/2" Dr. Hex Head Driver, 76mmL</b>			
447604	4mm	447610	10mm
447605	5mm	447612	12mm
447606	6mm	447614	14mm
447607	7mm	447617	17mm
447608	8mm	447619	19mm

Metal Box



 1550 g  15x1 15 sets / 24.3 Kgs / 0.77 CUFT



## WH-410MD 10 Piece 1/2" Dr. Metric Wobble Hex Head Driver Set SAE size: WH-410SD also available

Item No.	Size	Item No.	Size
<b>1/2" Dr. Wobble Hex Head Driver, 76mmL</b>			
4476W04	4mm	4476W10	10mm
4476W05	5mm	4476W12	12mm
4476W06	6mm	4476W14	14mm
4476W07	7mm	4476W17	17mm
4476W08	8mm	4476W19	19mm

Metal Box

 1500 g  15x1 15 sets / 23.5 Kgs / 0.77 CUFT



New Items



## CM-417MB 1/2" Dr. 17 Piece Metric Impact Socket Set SAE size: CM-417SB also available

Item No.	Size	Item No.	Size
<b>1/2" Dr. 6pt Impact Socket(CRMO):</b>			
444008	8mm	444018	18mm
444010	10mm	444019	19mm
444011	11mm	444021	21mm
444012	12mm	444022	22mm
444013	13mm	444024	24mm
444014	14mm	444027	27mm
444015	15mm	444030	30mm
444016	16mm	444032	32mm
444017	17mm		Blow Case

2300 g

8 sets / 19.5 Kgs / 0.94 CUFT



6 pt.

## TF-417MB 1/2" Dr. 17 Piece Metric Impact Socket Set SAE size: TF-417SB also available

Item No.	Size	Item No.	Size
<b>1/2" Dr. 6pt Impact Socket(CRV):</b>			
413808	8mm	413818	18mm
413810	10mm	413819	19mm
413811	11mm	413821	21mm
413812	12mm	413822	22mm
413813	13mm	413824	24mm
413814	14mm	413827	27mm
413815	15mm	413830	30mm
413816	16mm	413832	32mm
413817	17mm		Blow Case

2420 g

8 sets / 20.3 Kgs / 0.94 CUFT



6 pt.

## IW-417MTB 1/2" Dr. 17 Piece Metric Thin Wall Impact Socket Set (12-Point)

Item No.	Size	Item No.	Size
<b>1/2" Dr. 12pt Impact Socket(CRMO):</b>			
453808	8mm	453818	18mm
453810	10mm	453819	19mm
453811	11mm	453821	21mm
453812	12mm	453822	22mm
453813	13mm	453824	24mm
453814	14mm	453827	27mm
453815	15mm	453830	30mm
453816	16mm	453832	32mm
453817	17mm		Blow Case

1930 g

8 sets / 16.5 Kgs / 0.94 CUFT



12 pt.

## GS-417MB 1/2" Dr. 17 Piece Metric Hand Socket Set

Item No.	Size	Item No.	Size
<b>1/2" Dr. 6pt Hand Socket:</b>			
423808	8mm	423818	18mm
423810	10mm	423819	19mm
423811	11mm	423821	21mm
423812	12mm	423822	22mm
423813	13mm	423824	24mm
423814	14mm	423827	27mm
423815	15mm	423830	30mm
423816	16mm	423832	32mm
423817	17mm		Blow Case

2150 g

8 sets / 18.2 Kgs / 0.94 CUFT

12-point: TW-417MB also available  
SAE size: GS-417SB & TW-417SB also available



6 pt.

# New Items

## IS-619M 3/4" Dr. 19 Piece Metric Impact Socket Set

SAE sizes: IS-619S also available

Item No.	Size	Item No.	Size
<b>3/4" Dr. 6pt Impact Socket:</b>			
645217	17mm	645233	33mm
645219	19mm	645234	34mm
645221	21mm	645235	35mm
645222	22mm	645236	36mm
645224	24mm	645238	38mm
645226	26mm	645241	41mm
645227	27mm	645246	46mm
645228	28mm	645250	50mm
645230	30mm	645255	55mm
645232	32mm	Blow Case	

10 Kg

2 sets / 21 Kgs / 0.92 CUFT



6 pt.

## IW-619M 3/4" Dr. 19 Piece Metric Impact Socket Set (12-Point)

SAE sizes: IW-619S also available

Item No.	Size	Item No.	Size
<b>3/4" Dr. 12pt Impact Socket:</b>			
655217	17mm	655233	33mm
655219	19mm	655234	34mm
655221	21mm	655235	35mm
655222	22mm	655236	36mm
655224	24mm	655238	38mm
655226	26mm	655241	41mm
655227	27mm	655246	46mm
655228	28mm	655250	50mm
655230	30mm	655255	55mm
655232	32mm	Blow Case	

8.5 Kg

2 sets / 18 Kgs / 0.92 CUFT



12 pt.

## SS-619M 3/4" Dr. 19 Piece Metric Hand Socket Set

SAE sizes: SS-619S also available

Item No.	Size	Item No.	Size
<b>3/4" Dr. 6pt Hand Socket:</b>			
625217	17mm	625233	33mm
625219	19mm	625234	34mm
625221	21mm	625235	35mm
625222	22mm	625236	36mm
625224	24mm	625238	38mm
625226	26mm	625241	41mm
625227	27mm	625246	46mm
625228	28mm	625250	50mm
625230	30mm	625255	55mm
625232	32mm	Blow Case	

9 Kg

2 sets / 19 Kgs / 0.92 CUFT



6 pt.

## TW-619M 3/4" Dr. 19 Piece Metric Hand Socket Set (12-Point)

SAE sizes: TW-619S also available

Item No.	Size	Item No.	Size
<b>3/4" Dr. 12pt Hand Socket:</b>			
635217	17mm	635233	33mm
635219	19mm	635234	34mm
635221	21mm	635235	35mm
635222	22mm	635236	36mm
635224	24mm	635238	38mm
635226	26mm	635241	41mm
635227	27mm	635246	46mm
635228	28mm	635250	50mm
635230	30mm	635255	55mm
635232	32mm	Blow Case	

9 Kg

2 sets / 19 Kgs / 0.92 CUFT



12 pt.

## **TW-615M6** 15 Piece 3/4" Dr. Metric Hand Socket Set (12-Point) 6-point: GS-615M6 also available

Item No.	Size	Item No.	Size
<b>3/4" Dr. 12pt Hand Socket:</b>			
635222	22mm	635236	36mm
635224	24mm	635238	38mm
635227	27mm	635241	41mm
635230	30mm	635246	46mm
635232	32mm	635250	50mm
635235	35mm		

### **3/4" Dr. Accessory:**

620200	Ext. Bar, 200mmL	680060	Sliding T-Handle
620400	Ext. Bar, 400mmL	680610S	36T Ratchet

Blow Case

13 Kg

1 set / 14 Kgs / 0.91 CUFT



12 pt.

## **TW-615S6** 15 Piece 3/4" Dr. SAE Hand Socket Set (12-Point) 6-point: GS-615S6 also available

Item No.	Size	Item No.	Size
<b>3/4" Dr. 12pt Hand Socket:</b>			
675230	15/16"	675246	1-7/16"
675232	1"	675248	1-1/2"
675236	1-1/8"	675252	1-5/8"
675240	1-1/4"	675256	1-3/4"
675242	1-5/16"	675260	1-7/8"
675244	1-3/8"		

### **3/4" Dr. Accessory:**

620200	Ext. Bar, 8"L	680060	Sliding T-Handle
620400	Ext. Bar, 16"L	680610S	36T Ratchet

Blow Case

13 Kg

1 set / 14 Kgs / 0.91 CUFT



12 pt.

## **IA-288B** 8 Piece Impact Adapter Set (Steel Ball Type)

Item No.	Size
290030	1/4" Dr. Impact Adapter, 1/4"F x 3/8"M
340020	3/8" Dr. Impact Adapter, 3/8"F x 1/4"M
340040B	3/8" Dr. Impact Adapter, 3/8"F x 1/2"M
480033MB	1/2" Dr. Impact Adapter, 1/2"F x 3/8"M
480066MB	1/2" Dr. Impact Adapter, 1/2"F x 3/4"M
640604B	3/4" Dr. Impact Adapter, 3/4"F x 1/2"M
640608B	3/4" Dr. Impact Adapter, 3/4"F x 1"M
841006B	1" Dr. Impact Adapter, 1"F x 3/4"M

Blow Case

1750 g

12 sets / 22 Kgs / 1.25 CUFT

Pin Hole Type: IA-288 also available  
One-Piece Type: IA-288BA also available



## **HA-288** 8 Piece Hand Adapter Set

Item No.	Size
280030	1/4" Dr. Hand Adapter, 1/4"F x 3/8"M
320020	3/8" Dr. Hand Adapter, 3/8"F x 1/4"M
320040	3/8" Dr. Hand Adapter, 3/8"F x 1/2"M
420033	1/2" Dr. Hand Adapter, 1/2"F x 3/8"M
420066	1/2" Dr. Hand Adapter, 1/2"F x 3/4"M
620604	3/4" Dr. Hand Adapter, 3/4"F x 1/2"M
620608	3/4" Dr. Hand Adapter, 3/4"F x 1"M
821006	1" Dr. Hand Adapter, 1"F x 3/4"M

Blow Case

1800 g

12 sets / 22.5 Kgs / 1.25 CUFT



## Metric & SAE Reversible Combination Ratcheting Wrenches - Mirror Finish

ITEM NO.	Size mm	Length mm	Weight g	PCS inner/ctn	Weight w/packing	G.W. KGS	CUFT
769508	8	135	35	1 / 60	50	4.0	0.37
769510	10	158	55	1 / 40	75	4.0	0.37
769511	11	167	70	1 / 40	90	4.5	0.37
769512	12	173	75	1 / 40	95	4.8	0.37
769513	13	179	100	1 / 40	125	6.0	0.37
769514	14	189	120	1 / 40	145	6.8	0.37
769515	15	199	135	1 / 30	165	6.0	0.37
769516	16	215	165	1 / 30	195	7.0	0.37
769517	17	232	195	1 / 20	230	5.5	0.37
769518	18	238	200	1 / 20	235	5.7	0.37
769519	19	247	240	1 / 20	275	6.5	0.37
769521	21	285	345	1 / 20	400	9.0	0.39
769522	22	285	340	1 / 20	395	9.0	0.39
769524	24	325	480	1 / 20	545	12.0	0.45
769527	27	359	630	1 / 20	700	15.0	0.62
769530	30	425	940	1 / 15	1030	16.5	0.73
769532	32	425	900	1 / 15	990	16.0	0.73

ITEM NO.	Size inch	Length mm	Weight g	PCS inner/ctn	Weight w/packing	G.W. KGS	CUFT
779510	5/16	135	35	1 / 60	50	4.0	0.37
779512	3/8	158	60	1 / 40	80	4.2	0.37
779514	7/16	167	75	1 / 40	90	4.8	0.37
779516	1/2	179	100	1 / 40	125	6.0	0.37
779518	9/16	189	120	1 / 40	145	6.8	0.37
779520	5/8	215	165	1 / 30	195	7.0	0.37
779522	11/16	232	195	1 / 20	230	5.5	0.37
779524	3/4	247	235	1 / 20	270	6.5	0.37
779526	13/16	285	350	1 / 20	405	9.0	0.39
779528	7/8	285	335	1 / 20	390	8.8	0.39
779530	15/16	325	470	1 / 20	535	11.7	0.45
779532	1	325	465	1 / 20	530	11.5	0.45
779534	1-1/16	359	635	1 / 20	705	15.0	0.62
779536	1-1/8	425	960	1 / 15	1050	16.8	0.73
779540	1-1/4	425	920	1 / 15	1010	16.2	0.73

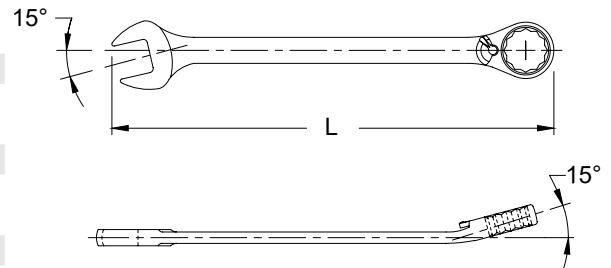

### GR-7611M 11 Piece Metric Reversible Combination Ratcheting Wrench Set

Item No. Size Item No. Size  
**Reversible Com. Ratcheting Wrench (Mirror Finish):**

769508	8mm	769515	15mm
769510	10mm	769516	16mm
769511	11mm	769517	17mm
769512	12mm	769518	18mm
769513	13mm	769519	19mm
769514	14mm		Pouch Bag

1700 g 8 sets / 14.5 Kgs / 0.7 CUFT

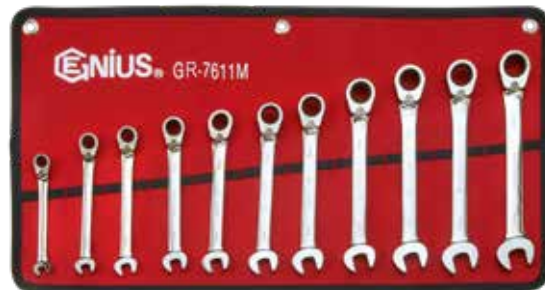

### GR-7708S 8 Piece SAE Reversible Combination Ratcheting Wrench Set

Item No. Size Item No. Size  
**Reversible Com. Ratcheting Wrench (Mirror Finish):**

779510	5/16"	779518	9/16"
779512	3/8"	779520	5/8"
779514	7/16"	779522	11/16"
779516	1/2"	779524	3/4"

Pouch Bag

1200 g 8 sets / 10.5 Kgs / 0.7 CUFT



## GRP-7608M 8 Piece Metric Reversible Combination Ratcheting Wrench Set

**Item No. Size Item No. Size**  
**Reversible Com. Ratcheting Wrench (Mirror Finish):**

769508	8mm	769514	14mm
769510	10mm	769515	15mm
769512	12mm	769517	17mm
769513	13mm	769519	19mm

Plastic Tray

1100 g 10 sets / 12 Kgs / 0.71 CUFT



## GRP-7708S 8 Piece SAE Reversible Combination Ratcheting Wrench Set

**Item No. Size Item No. Size**  
**Reversible Com. Ratcheting Wrench (Mirror Finish):**

779510	5/16"	779518	9/16"
779512	3/8"	779520	5/8"
779514	7/16"	779522	11/16"
779516	1/2"	779524	3/4"

Plastic Tray

1100 g 10 sets / 12 Kgs / 0.71 CUFT



## GR-7617M 17 Piece Metric Reversible Combination Ratcheting Wrench Set

**Item No. Size Item No. Size**  
**Reversible Com. Ratcheting Wrench (Mirror Finish):**

769508	8mm	769518	18mm
769510	10mm	769519	19mm
769511	11mm	769521	21mm
769512	12mm	769522	22mm
769513	13mm	769524	24mm
769514	14mm	769527	27mm
769515	15mm	769530	30mm
769516	16mm	769532	32mm
769517	17mm	Blow Case	

6250 g 3 sets / 19.8 Kgs / 1.68 CUFT



## GR-7715S 15 Piece SAE Reversible Combination Ratcheting Wrench Set

**Item No. Size Item No. Size**  
**Reversible Com. Ratcheting Wrench (Mirror Finish):**

779510	5/16"	779526	13/16"
779512	3/8"	779528	7/8"
779514	7/16"	779530	15/16"
779516	1/2"	779532	1"
779518	9/16"	779534	1-1/16"
779520	5/8"	779536	1-1/8"
779522	11/16"	779540	1-1/4"
779524	3/4"	Blow Case	

6450 g 3 sets / 20.3 Kgs / 1.68 CUFT



## Metric & SAE Flex Head Combination Ratcheting Wrenches - Mirror Finish

ITEM NO.	Size mm	Length mm	Weight g	PCS inner/ctn	Weight w/packing	G.W. KGS	CUFT
764508	8	136	40	1 / 60	55	4.3	0.37
764510	10	160	60	1 / 40	80	4.2	0.37
764512	12	174	90	1 / 40	110	5.5	0.37
764513	13	180	105	1 / 40	130	6.2	0.37
764514	14	193	125	1 / 40	150	7.0	0.37
764515	15	200	145	1 / 30	175	6.3	0.37
764517	17	233	210	1 / 20	245	6.0	0.37
764519	19	250	260	1 / 20	295	7.0	0.37

ITEM NO.	Size inch	Length mm	Weight g	PCS inner/ctn	Weight w/packing	G.W. KGS	CUFT
774510	5/16	136	40	1 / 60	55	4.3	0.37
774512	3/8	160	60	1 / 40	80	4.2	0.37
774514	7/16	168	75	1 / 40	95	4.8	0.37
774516	1/2	180	110	1 / 40	135	6.5	0.37
774518	9/16	193	130	1 / 40	155	7.2	0.37
774520	5/8	216	185	1 / 30	215	7.5	0.37
774522	11/16	233	205	1 / 20	240	5.8	0.37
774524	3/4	250	265	1 / 20	300	7.0	0.37

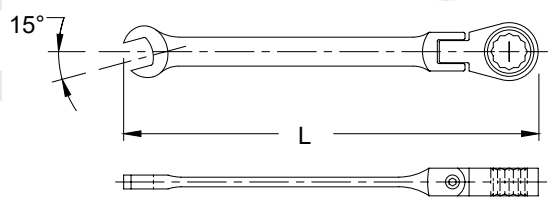

### GFP-7608M 8 Piece Metric Flex Head Combination Ratcheting Wrench Set

Item No.	Size	Item No.	Size
<b>Flex Head Com. Ratcheting Wrench (Mirror Finish):</b>			
764508	8mm	764514	14mm
764510	10mm	764515	15mm
764512	12mm	764517	17mm
764513	13mm	764519	19mm

Plastic Tray

1200 g 10 sets / 13 Kgs / 0.71 CUFT



### GFP-7708S 8 Piece SAE Flex Head Combination Ratcheting Wrench Set

Item No.	Size	Item No.	Size
<b>Flex Head Com. Ratcheting Wrench (Mirror Finish):</b>			
774510	5/16"	774518	9/16"
774512	3/8"	774520	5/8"
774514	7/16"	774522	11/16"
774516	1/2"	774524	3/4"

Plastic Tray

1200 g 10 sets / 13 Kgs / 0.71 CUFT



### GWP-7608M 8 Piece Metric Combination Ratcheting Wrench Set SAE sizes: GWP-7708S also available

Item No.	Size	Item No.	Size
<b>Combination Ratcheting Wrench (Mirror Finish):</b>			
768508	8mm	768514	14mm
768510	10mm	768515	15mm
768512	12mm	768517	17mm
768513	13mm	768519	19mm

Plastic Tray

1100 g 10 sets / 12 Kgs / 0.71 CUFT



New Items

## HS-030MS 30 Piece Metric & SAE Combination Wrench Set

Item No.	Size	Item No.	Size
<b>Combination Wrench (Matt Finish):</b>			
726006	6mm	726022	22mm
726007	7mm	726024	24mm
726008	8mm	737008	1/4"
726009	9mm	737010	5/16"
726010	10mm	737012	3/8"
726011	11mm	737014	7/16"
726012	12mm	737016	1/2"
726013	13mm	737018	9/16"
726014	14mm	737020	5/8"
726015	15mm	737022	11/16"
726016	16mm	737024	3/4"
726017	17mm	737026	13/16"
726018	18mm	737028	7/8"
726019	19mm	737030	15/16"
726021	21mm	737032	1"



Pouch Bag

5300 g 4 sets / 22 Kgs / 0.82 CUFT

## PR-007M 7 Piece Metric Combination Wrench Set

Item No.	Size	Item No.	Size
<b>Combination Wrench (Mirror Finish):</b>			
748210	10mm	748215	15mm
748212	12mm	748217	17mm
748213	13mm	748219	19mm
748214	14mm		Plastic Hook

1000 g 20 sets / 21 Kgs / 1.6 CUFT



## PR-007S 7 Piece SAE Combination Wrench Set

Item No.	Size	Item No.	Size
<b>Combination Wrench (Mirror Finish):</b>			
759212	3/8"	759220	5/8"
759214	7/16"	759222	11/16"
759216	1/2"	759224	3/4"
759218	9/16"		Plastic Hook

1000 g 20 sets / 21 Kgs / 1.6 CUFT



## HK-007HE 7 Piece Metric Hex Key Wrench Folding Set

### Description

#### Metric Hex Key Wrench:

2, 2.5, 3, 4, 5, 6 & 8mm

Sliding Card

210 g 72 sets / 16.4 Kgs / 1.1 CUFT



## HK-009HE 9 Piece Metric Hex Key Wrench Folding Set

### Description

#### Metric Hex Key Wrench:

1.5, 2, 2.5, 3, 4, 5, 6, 8 & 10mm

Sliding Card

345 g 72 sets / 25.7 Kgs / 1.0 CUFT



## TX-008F 8 Piece Star Key Wrench Folding Set

### Description

#### Star Key Wrench:

T9, T10, T15, T20, T25, T27, T30 & T40

Sliding Card

215 g 72 sets / 16.8 Kgs / 1.2 CUFT



## Metric & SAE Stubby Combination Wrenches - Mirror Finish

ITEM NO.	Size mm	Length mm	Weight g	PCS inner/ctn	G.W. KGS	CUFT
740210	10	102	30	15 / 180	6.5	0.3
740211	11	107	45	15 / 180	9.0	0.3
740212	12	107	40	15 / 180	8.2	0.3
740213	13	113	55	10 / 120	7.5	0.3
740214	14	118	65	10 / 120	8.8	0.3
740215	15	125	85	10 / 120	11.2	0.3
740216	16	125	85	10 / 120	11.2	0.3
740217	17	131	105	5 / 60	7.3	0.3
740218	18	131	105	5 / 60	7.3	0.3
740219	19	137	120	5 / 60	8.2	0.3

ITEM NO.	Size inch	Length mm	Weight g	PCS inner/ctn	G.W. KGS	CUFT
750212	3/8	102	30	15 / 180	6.5	0.3
750214	7/16	107	45	15 / 180	9.0	0.3
750216	1/2	113	55	10 / 120	7.5	0.3
750218	9/16	118	65	10 / 120	8.8	0.3
750220	5/8	125	80	10 / 120	10.5	0.3
750222	11/16	131	105	5 / 60	7.3	0.3
750224	3/4	137	115	5 / 60	8.0	0.3

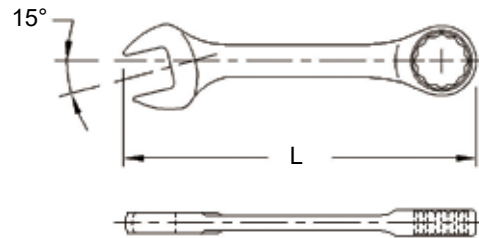

### SC-010M 10 Piece Metric Stubby Combination Wrench Set

Item No.	Size	Item No.	Size
<b>Stubby Combination Wrench (Mirror Finish):</b>			
740210	10mm	740215	15mm
740211	11mm	740216	16mm
740212	12mm	740217	17mm
740213	13mm	740218	18mm
740214	14mm	740219	19mm

Plastic Hook

850 g

20 sets / 18 Kgs / 1.21 CUFT



### SC-007M 7 Piece Metric Stubby Combination Wrench Set

Item No.	Size	Item No.	Size
<b>Stubby Combination Wrench (Mirror Finish):</b>			
740210	10mm	740215	15mm
740212	12mm	740217	17mm
740213	13mm	740219	19mm
740214	14mm		Plastic Hook

630 g

20 sets / 13.5 Kgs / 1.21 CUFT



### SC-007S 7 Piece SAE Stubby Combination Wrench Set

Item No.	Size	Item No.	Size
<b>Stubby Combination Wrench (Mirror Finish):</b>			
750212	3/8"	750220	5/8"
750214	7/16"	750222	11/16"
750216	1/2"	750224	3/4"
750218	9/16"		Plastic Hook

630 g

20 sets / 13.5 Kgs / 1.21 CUFT



New Items



## TR-5207S 7 Piece Slotted & Philips Screwdriver Set

Item No.	Size	Item No.	Size
<b>Screwdriver w/Rubber Handle:</b>			
504+0430	0.5 x 3.0mm, 155mmL	504+0400	#0 Philips, 155mmL
504+1240	0.8 x 4.0mm, 180mmL	504+1421	#1 Philips, 200mmL
506+0560	1.0 x 6.0mm, 250mmL	506+1802	#2 Philips, 225mmL
506+1966	1.2 x 6.5mm, 250mmL		Color Box

630 g 12 sets / 8.5 Kgs / 1.21 CUFT



## TR-5207S1 7 Piece Slotted & Philips Screwdriver Set

Item No.	Size	Item No.	Size
<b>Screwdriver w/Rubber Handle:</b>			
504+1240	0.8 x 4.0mm, 180mmL	504+0400	#0 Philips, 155mmL
506+1455	1.0 x 5.5mm, 200mmL	504+1401	#1 Philips, 170mmL
506+1966	1.2 x 6.5mm, 250mmL	506+1802	#2 Philips, 225mmL
506+1980	1.2 x 8.0mm, 280mmL		Color Box

720 g 12 sets / 9.5 Kgs / 1.21 CUFT



## TR-5207V 7 Piece Insulated Slotted & Philips Screwdriver Set

Item No.	Size	Item No.	Size
<b>Insulated Screwdriver w/Rubber Handle:</b>			
586225	0.4 x 2.5mm, 165mmL	586265	1.2 x 6.5mm, 270mmL
586230	0.5 x 3.0mm, 170mmL	584201	#1 Philips, 190mmL
586240	0.8 x 4.0mm, 210mmL	584202	#2 Philips, 220mmL
586255	1.0 x 5.5mm, 245mmL		Color Box

680 g 12 sets / 9.2 Kgs / 1.21 CUFT



## CP-5603V 3 Piece Insulated Pliers Set

Item No.	Description
550812V	8" Side Cutter Pliers
550607V	6" Diagonal Cutting Pliers
550804V	8" Chain Nose Pliers w/ Cutter
	Color Box

980 g 24 sets / 24.5 Kgs / 1.58 CUFT



## CP-5703 3 Piece Pliers Set

Item No.	Description
550812	8" Side Cutter Pliers
550607	6" Diagonal Cutting Pliers
550804	8" Chain Nose Pliers w/ Cutter
	Color Box

980 g 24 sets / 24.5 Kgs / 1.58 CUFT



## CP-5803 3 Piece Pliers Set

Item No.	Description
550812D	8" Side Cutter Pliers
550607D	6" Diagonal Cutting Pliers
550804D	8" Chain Nose Pliers w/ Cutter
	Color Box

1000 g 24 sets / 25 Kgs / 1.58 CUFT



## CP-5903 3 Piece Pliers Set

Item No.	Description
550812S	8" Side Cutter Pliers
550607S	6" Diagonal Cutting Pliers
550804S	8" Chain Nose Pliers w/ Cutter
	Color Box

1000 g 24 sets / 25 Kgs / 1.58 CUFT



## Oxygen Sensor Sockets

ITEM NO.	Drive Size	Description	Slot mm	Length mm	Weight g	PCS inner/ctn	G.W. KGS	CUFT
308022A	3/8"	6pt, 7/8"(22mm)	8	80	225	15 / 90	23.5	1.58
309022	3/8"	6pt, 7/8"(22mm)	20	90	225	15 / 90	23.5	1.58
409022	1/2"	6pt, 7/8"(22mm)	20	90	215	15 / 90	22.5	1.58
409022A	1/2"	6pt, 7/8"(22mm)	8	90	220	15 / 90	23.0	1.58

- Remove and install oxygen sensors on vehicles with computer-controlled engines.
- Side cutout prevents damage to wire.
- Use with square drive or 1" hex wrench.

## AT-OS07 7 Piece Oxygen Sensor Wrench Set

Parts No.	Parts Name	Description
409029	Vacuum Switch Socket	1/2" Dr. x 29mm x 90mmL (6-Point)
407827	Injector Socket	1/2" Dr. x 27mm(1-1/16") x 78mmL (12-Point)
39743234	Oil Sender Unit Socket	3/8" Dr. x 1" & 27mm(1-1/16") x 74mmL (6-Point)
309022	Oxygen Sensor Socket	3/8" Dr. x 22mm(7/8") x 90mmL (6-Point)
308022A	Vacuum Switch Socket	3/8" Dr. x 22mm(7/8") x 80mmL (6-Point)
303022	Oxygen Sensor Wrench	3/8" Dr. x 22mm(7/8") x 30mmL (6-Point)
405022	Oxygen Sensor Socket	1/2" Dr. x 22mm(7/8") x 50mmL (6-Point)

Blow Case

2000 g

12 sets / 25 Kgs / 1.13 CUFT



## Square Head Drain Plug Socket

ITEM NO.	Drive Size	Square Size	Length mm	Weight g	PCS inner/ctn	G.W. KGS	CUFT
4803808S	1/2"	8mm	38	60	10 / 200	13.0	0.52
4803810S	1/2"	10mm	38	65	10 / 200	14.0	0.52
4807508S	1/2"	8mm	75	125	10 / 140	18.5	0.44
4807510S	1/2"	10mm	75	130	10 / 140	19.2	0.44

- Designed to Service Male Square Plugs



## FG-013M 13 Blades Metric Feeler Gauge Set (0.05~1.00mm)

Blades: 100mmL x 10mmW

0.05 - 0.10 - 0.15 - 0.20 - 0.25 - 0.30 - 0.40

0.50 - 0.60 - 0.70 - 0.80 - 0.90 - 1.00mm

Sliding Card

80 g

20x10 200 sets / 18 Kgs / 1.42 CUFT



## AT-PC09 Big Mouth Clamp

Description

Capacity: 3 ton

Single-way pull operation

Same sizes for two jaws

Color Box

2000 g

10 pcs / 21 Kgs / 0.98 CUFT



## AT-PC13 Heavy Duty Pull Clamp

Description

Capacity: 5 ton

Single-way pull operation

Color Box

3000 g

6 pcs / 19 Kgs / 0.60 CUFT



## AT-PC11

### Small Mouth Pull Clamp

Description

Capacity: 5 ton

Single-way pull operation

Color Box

2000 g

12 pcs / 25.3 Kgs / 1.20 CUFT



## AT-PC11T Two-Way Small Mouth Pull Clamp

Description

Capacity: 5 ton on the straight way

2 ton on the cross way

Two-way pull operation

Color Box

2080 g

12 pcs / 26.3 Kgs / 1.20 CUFT



New Items

## AT-PC12 Box Clamp

### Description

Capacity: 3 ton  
Single-way pull operation  
Different sizes for two jaws  
Color Box



2100 g 10 pcs / 22 Kgs / 0.98 CUFT

## AT-PC12T Two-Way Box Clamp

### Description

Capacity: 3 ton on the straight way  
2 ton on the cross way  
Two-way pull operation  
Different sizes for two jaws  
Color Box



2200 g 10 pcs / 23 Kgs / 0.98 CUFT

## AT-PC61 Wide Serrate Clamp

### Description

Capacity: 5 ton  
Single-way pull operation  
Serrate width: 120mm  
Color Box



2850 g 6 pcs / 18.5 Kgs / 0.61 CUFT

## AT-PC61T Two-Way Wide Serrate Clamp

### Description

Capacity: 5 ton on the straight way  
3 ton on the cross way  
Two-way pull operation  
Serrate width: 120mm  
Color Box



2920 g 6 pcs / 18.5 Kgs / 0.61 CUFT

## AT-PC61M Multi-Way Wide Serrate Clamp

### Description

Capacity: 5 ton on the straight way  
3 ton on the cross way  
3 ton on the multi way



Multi-way pull operation  
Serrate width: 120mm  
Color Box

3000 g 6 pcs / 19 Kgs / 0.61 CUFT

## MF-506 5 Piece 6"L Machinists Files (2nd. Cut) Set

Item No.	Description
500106	Flat
500206	Round
500306	Half Round
500406	Square
500506	Triangle

Color Box

650 g 14 sets / 10 Kgs / 1.12 CUFT

## MF-508 5 Piece 8"L Machinists Files (2nd. Cut) Set

Item No.	Description
500108	Flat
500208	Round
500308	Half Round
500408	Square
500508	Triangle

Color Box

900 g 14 sets / 13.5 Kgs / 1.12 CUFT

## MF-510 5 Piece 10"L Machinists Files (2nd. Cut) Set

Item No.	Description
500110	Flat
500210	Round
500310	Half Round
500410	Square
500510	Triangle

Color Box

1500 g 12 sets / 19 Kgs / 1.35 CUFT

## MF-512 5 Piece 12"L Machinists Files (2nd. Cut) Set

Item No.	Description
500112	Flat
500212	Round
500312	Half Round
500412	Square
500512	Triangle

Color Box

2100 g 12 sets / 26.2 Kgs / 1.35 CUFT





## Rolling Head Pry Bars

ITEM NO.	Length mm (Inch)	Weight g	PCS inner/ctn	G.W. KGS	CUFT
561106	150 (6")	70	10 / 200	15.0	0.52
561112	305 (12")	250	5 / 60	16.0	0.52
561116	405 (16")	530	1 / 40	21.5	0.53
561120	505 (20")	945	1 / 20	20.0	0.45

### **PB-RH4** 4 Piece Rolling Head Pry Bar Set

Item No.	Description
561106	Rolling Head Pry Bar, 150mmL(6"L)
561112	Rolling Head Pry Bar, 305mmL(12"L)
561116	Rolling Head Pry Bar, 405mmL(16"L)
561120	Rolling Head Pry Bar, 505mmL(20"L)

Plastic Tray  
 1800 g       12 sets / 22.5 Kgs / 0.7 CUFT



## Aluminum Socket Holders

ITEM No.	Drive Size	Length mm	Clips pcs	Weight g	PCS inner/ctn	G.W. KGS	CUFT
013216	1/4"	432	16	140	12 / 72	11.1	1.60
013316	3/8"	432	16	150	12 / 72	12.2	1.60
013416	1/2"	432	16	185	12 / 72	14.5	1.60
013608	3/4"	432	8	170	1 / 50	9.6	1.02
013806	1"	432	8	185	1 / 50	10.3	1.02

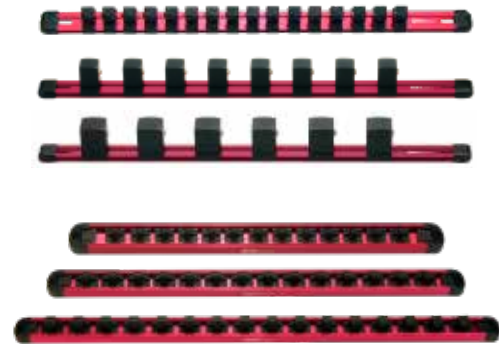

## Aluminum Socket Holders w/ Quick-Lock

ITEM No.	Drive Size	Length mm	Clips pcs	Weight g	PCS inner/ctn	G.W. KGS	CUFT
014213	1/4"	355	13	250	12 / 72	19.7	1.80
014314	3/8"	457	14	330	12 / 48	17.5	1.80
014416	1/2"	558	16	395	12 / 48	21.0	2.28

### NEW Quick-Lock

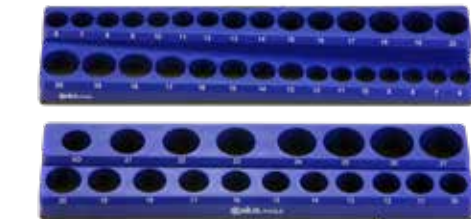

## Magnetic Socket Holders

ITEM No.	Drive Size	Pin pcs	Size Range	Weight g	PCS inner/ctn	G.W. KGS	CUFT
012330M	3/8"	15x2	6~20mm	740	12 / 24	18.7	1.4
012419M	1/2"	19	10~27mm	730	12 / 24	18.6	1.2

### Dimension:

- 012330M: 375x88x34mm
- 012419M: 375x88x27mm



## Magnetic Socket Trays

ITEM No.	Drive Size	Pin pcs	Dimension mm	Weight g	PCS inner/ctn	G.W. KGS	CUFT
019328	3/8"	14x2	418x125x20	935	1 / 20	20.2	1.2
019422	1/2"	11x2	420x159x32	1100	1 / 20	24.0	2.2

## Plastic Ratchet Holders

ITEM No.	Size	Weight g	PCS	G.W. KGS	CUFT
002002	1/4"	4.0	500	2.5	0.49
002003	3/8"	5.5	500	3.3	0.60
002004	1/2"	6.5	500	3.8	0.77



**GENIUS<sup>®</sup>**

*Impact Sockets*



**GENIUS TOOLS**  
[www.geniustools.net](http://www.geniustools.net)

## Metric Impact Sockets

Item No.	A mm	D1 mm	D2 mm	Length mm	Weight g	PCS inner/ctn	G.W. KGS	CUFT
212503	3	6.1	12	25	9	20 / 300	4.0	0.69
212504	4	7.3	12	25	9	20 / 300	4.0	0.69
2125045	4.5	7.9	12	25	10	20 / 300	4.0	0.69
212505	5	8.5	12	25	10	20 / 300	4.0	0.69
2125055	5.5	9.1	12	25	10	20 / 300	4.0	0.69
212506	6	9.7	12	25	11	20 / 300	4.5	0.69
212507	7	11.0	12	25	11	20 / 300	4.5	0.69
212508	8	12.0	12	25	11	20 / 300	4.5	0.69
212509	9	13.0	13	25	13	20 / 300	5.5	0.69
212510	10	14.0	14	25	15	20 / 300	6.0	0.69
212511	11	16.0	16	25	20	20 / 300	8.0	0.69
212512	12	17.0	17	25	25	20 / 300	9.0	0.69
212513	13	18.0	18	25	30	20 / 300	10.0	0.69
212514	14	20.0	20	25	35	20 / 300	11.5	0.69



6 pt.

## SAE Impact Sockets

Item No.	A inch	D1 mm	D2 mm	Length mm	Weight g	PCS inner/ctn	G.W. KGS	CUFT
292504	1/8	6.2	12	25	9	20 / 300	4.0	0.69
292506	3/16	8.2	12	25	10	20 / 300	4.0	0.69
292507	7/32	9.2	12	25	10	20 / 300	4.0	0.69
292508	1/4	10.2	12	25	11	20 / 300	4.0	0.69
292509	9/32	11.2	12	25	12	20 / 300	4.5	0.69
292510	5/16	12.0	12	25	12	20 / 300	4.5	0.69
292511	11/32	13.0	13	25	14	20 / 300	5.5	0.69
292512	3/8	14.0	14	25	16	20 / 300	6.0	0.69
292514	7/16	16.0	16	25	20	20 / 300	7.5	0.69
292516	1/2	18.0	18	25	30	20 / 300	9.5	0.69
292518	9/16	20.0	20	25	35	20 / 300	11.5	0.69

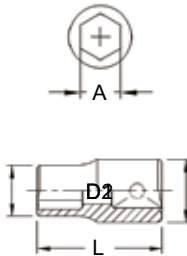

## TF-214M 14 Piece 1/4" Dr. Metric Impact Socket Set

Item No.	Size	Item No.	Size
<b>1/4" Dr. 6pt Impact Socket:</b>			
212503	3mm	212508	8mm
212504	4mm	212509	9mm
2125045	4.5mm	212510	10mm
212505	5mm	212511	11mm
2125055	5.5mm	212512	12mm
212506	6mm	212513	13mm
212507	7mm	212514	14mm



6 pt.

Socket Holder

310 g 10x6 60 sets / 19.5 Kgs / 1.58 CUFT

## TF-211S 11 Piece 1/4" Dr. SAE Impact Socket Set

Item No.	Size	Item No.	Size
<b>1/4" Dr. 6pt Impact Socket:</b>			
292504	1/8"	292511	11/32"
292506	3/16"	292512	3/8"
292507	7/32"	292514	7/16"
292508	1/4"	292516	1/2"
292509	9/32"	292518	9/16"
292510	5/16"	Socket Holder	



6 pt.

260 g 10x6 60 sets / 18 Kgs / 1.58 CUFT

Impact Sockets



# Impact Sockets

## Metric Deep Impact Sockets

Item No.	A	D1	D2	Length mm	Weight g	PCS inner/ctn	G.W.		CUFT
	mm	mm	mm				KGS		
215204	4	7.3	12.0	50	16	10 / 200	4.5		0.39
2152045	4.5	7.9	12.0	50	17	10 / 200	4.5		0.39
215205	5	8.5	12.0	50	18	10 / 200	4.5		0.39
2152055	5.5	9.1	12.0	50	19	10 / 200	4.5		0.39
215206	6	9.7	12.0	50	20	10 / 200	5.0		0.39
215207	7	11.0	12.0	50	20	10 / 200	5.5		0.39
215208	8	12.0	11.2	50	20	10 / 200	5.5		0.39
215209	9	13.0	12.0	50	25	10 / 200	6.5		0.39
215210	10	14.5	12.5	50	30	10 / 200	7.5		0.39
215211	11	16.0	13.0	50	35	10 / 200	8.0		0.39
215212	12	17.0	13.5	50	35	10 / 200	8.0		0.39
215213	13	19.0	14.0	50	50	10 / 200	10.0		0.60
215214	14	20.0	14.5	50	50	10 / 200	11.0		0.60

## SAE Deep Impact Sockets

Item No.	A	D1	D2	Length mm	Weight g	PCS inner/ctn	G.W.		CUFT
	inch	mm	mm				KGS		
295206	3/16	8.2	12.0	50	17	10 / 200	4.5		0.39
295207	7/32	9.2	12.0	50	18	10 / 200	4.5		0.39
295208	1/4	10.2	12.0	50	20	10 / 200	5.0		0.39
295209	9/32	11.2	12.0	50	20	10 / 200	5.5		0.39
295210	5/16	12.0	11.2	50	20	10 / 200	5.5		0.39
295211	11/32	13.0	12.0	50	25	10 / 200	6.5		0.39
295212	3/8	14.0	12.5	50	30	10 / 200	8.0		0.39
295214	7/16	16.0	13.0	50	30	10 / 200	8.0		0.39
295216	1/2	18.0	14.0	50	45	10 / 200	10.0		0.60
295218	9/16	20.0	15.0	50	50	10 / 200	11.0		0.60

## Impact Adapter

Item No.	Female	Male	Length mm	Weight g	PCS inner/ctn	G.W.		CUFT
	Drive	Drive				KGS		
290030	1/4"	3/8"	25	15	20 / 600	10.0		0.38

## Impact Bit Holders

Item No.	Hex	Length mm	Weight g	PCS inner/ctn	G.W.		CUFT
	Shank				mm	KGS	
263508	1/4"	35	20	10 / 300	7.0		0.38
263510	5/16"	35	25	10 / 300	8.0		0.38

## Impact Bit Holder

Item No.	Hex	Length mm	Weight g	PCS inner/ctn	G.W.		CUFT
	Shank				mm	KGS	
262808	1/4"	25	16	20 / 600	11.0		0.38

## Impact Extension Bars

Item No.	Length	Weight g	PCS inner/ctn	G.W.		CUFT
	mm (inch)			mm	KGS	
210002	50 (2")	25	25 / 400	11.0		0.30
210003	75 (3")	35	25 / 400	15.0		0.30
210004	100 (4")	45	20 / 240	12.0		0.30
210006	150 (6")	65	20 / 240	17.0		0.30
210009	225 (9")	95	20 / 200	20.5		0.41
210012	300 (12")	125	15 / 180	23.5		0.52

## Impact Universal Joint

Item No.	Outside	Length mm	Weight g	PCS inner/ctn	G.W.		CUFT
	Diameter				mm	KGS	
700106	14mm	35	20	10 / 300	7.0		0.38

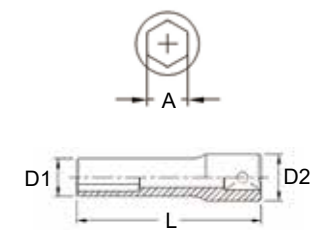

## TD-211M 11 Piece 1/4" Dr. Metric Deep Impact Socket Set

Item No.	Size	Item No.	Size
<b>1/4" Dr. 6pt Deep Impact Socket:</b>			
215204	4mm	215209	9mm
215205	5mm	215210	10mm
2152055	5.5mm	215211	11mm
215206	6mm	215212	12mm
215207	7mm	215213	13mm
215208	8mm		Socket Holder

400 g 5x4 20 sets / 9 Kgs / 0.71 CUFT



6 pt.

## TD-210S 10 Piece 1/4" Dr. SAE Deep Impact Socket Set

Item No.	Size	Item No.	Size
<b>1/4" Dr. 6pt Deep Impact Socket:</b>			
295206	3/16"	295211	11/32"
295207	7/32"	295212	3/8"
295208	1/4"	295214	7/16"
295209	9/32"	295216	1/2"
295210	5/16"	295218	9/16"
			Socket Holder

350 g 5x4 20 sets / 8 Kgs / 0.71 CUFT



6 pt.

## TF-255MS 55 Piece 1/4" Dr. Metric & SAE Deep Impact Socket Set

Item No.	Size	Item No.	Size	Item No.	Size
<b>1/4" Dr. 6pt Impact Socket:</b>			<b>1/4" Dr. Accessory:</b>		
212503	3mm	292504	1/8"	210002	Impact Extension Bar, 50mmL
212504	4mm	292506	3/16"	210003	Impact Extension Bar, 75mmL
2125045	4.5mm	292507	7/32"	210004	Impact Extension Bar, 100mmL
212505	5mm	292508	1/4"	210006	Impact Extension Bar, 150mmL
2125055	5.5mm	292509	9/32"	263508	Impact Bit Holder
212506	6mm	292510	5/16"	290030	Impact Adapter, 1/4"F x 3/8"M
212507	7mm	292511	11/32"	700106	Impact Universal Joint
212508	8mm	292512	3/8"		Blow Case
212509	9mm	292514	7/16"		
212510	10mm	292516	1/2"		
212511	11mm	292518	9/16"		
212512	12mm				
212513	13mm				
212514	14mm				
<b>1/4" Dr. 6pt Deep Impact Socket:</b>					
215204	4mm	295206	3/16"		
2152045	4.5mm	295207	7/32"		
215205	5mm	295208	1/4"		
2152055	5.5mm	295209	9/32"		
215206	6mm	295210	5/16"		
215207	7mm	295211	11/32"		
215208	8mm	295212	3/8"		
215209	9mm	295214	7/16"		
215210	10mm	295216	1/2"		
215211	11mm	295218	9/16"		
215212	12mm				
215213	13mm				
215214	14mm				

1750 g 12 sets / 22 Kgs / 1.59 CUFT



6 pt.

Impact Sockets





# Impact Sockets

## Metric Impact Sockets

Item No.	A mm	D1 mm	D2 mm	Length mm	Weight g	PCS	G.W. KGS	CUFT
						inner/ctn		
313006	6	11.0	18.8	28	35	20 / 300	13.0	0.69
313007	7	12.0	18.8	28	35	20 / 300	13.0	0.69
313008	8	13.5	18.8	28	35	20 / 300	13.0	0.69
313009	9	15.0	18.8	28	35	20 / 300	13.0	0.69
313010	10	16.0	18.8	28	35	20 / 300	13.0	0.69
313011	11	17.0	18.8	30	40	20 / 300	13.0	0.69
313012	12	18.8	18.8	30	40	20 / 300	13.0	0.69
313013	13	19.8	19.8	30	40	20 / 300	13.5	0.69
313014	14	22.0	22.0	30	55	20 / 300	19.0	0.69
313015	15	22.0	22.0	30	55	20 / 300	19.0	0.69
313016	16	23.8	23.8	30	60	20 / 300	20.0	0.69
313017	17	24.8	24.8	32	70	20 / 300	23.0	0.69
313018	18	25.8	25.8	32	75	20 / 300	24.5	0.69
313019	19	27.8	27.8	32	85	20 / 300	28.0	0.69
313020	20	27.8	27.8	32	85	20 / 300	28.0	0.69
313021	21	29.8	29.8	32	100	20 / 300	34.0	0.69
313022	22	31.8	31.8	32	110	20 / 300	36.0	0.69

## SAE Impact Sockets

Item No.	A inch	D1 mm	D2 mm	Length mm	Weight g	PCS	G.W. KGS	CUFT
						inner/ctn		
393008	1/4	11.0	18.8	28	30	20 / 300	12.0	0.69
393010	5/16	13.5	18.8	28	35	20 / 300	13.0	0.69
393011	11/32	14.5	18.8	28	35	20 / 300	13.0	0.69
393012	3/8	15.0	18.8	28	35	20 / 300	13.0	0.69
393014	7/16	17.0	18.8	30	40	20 / 300	13.0	0.69
393016	1/2	18.8	18.8	30	40	20 / 300	13.0	0.69
393018	9/16	22.0	22.0	30	55	20 / 300	19.0	0.69
393019	19/32	22.0	22.0	30	55	20 / 300	19.0	0.69
393020	5/8	23.8	23.8	30	60	20 / 300	20.0	0.69
393022	11/16	24.8	24.8	32	75	20 / 300	25.0	0.69
393024	3/4	27.8	27.8	32	85	20 / 300	28.0	0.69
393025	25/32	27.8	27.8	32	85	20 / 300	28.0	0.69
393026	13/16	29.8	29.8	32	110	20 / 300	34.0	0.69
393028	7/8	31.8	31.8	32	120	20 / 300	40.0	0.69

## TF-316M 16 Piece 3/8" Dr. Metric Impact Socket Set

Item No.	Size	Item No.	Size
<b>3/8" Dr. 6pt Impact Socket:</b>			
313007	7mm	313015	15mm
313008	8mm	313016	16mm
313009	9mm	313017	17mm
313010	10mm	313018	18mm
313011	11mm	313019	19mm
313012	12mm	313020	20mm
313013	13mm	313021	21mm
313014	14mm	313022	22mm

Socket Holder

1200 g 20x1 20 sets / 25 Kgs / 0.88 CUFT

## TF-313S 13 Piece 3/8" Dr. SAE Impact Socket Set

Item No.	Size	Item No.	Size
<b>3/8" Dr. 6pt Impact Socket:</b>			
393010	5/16"	393020	5/8"
393011	11/32"	393022	11/16"
393012	3/8"	393024	3/4"
393014	7/16"	393025	25/32"
393016	1/2"	393026	13/16"
393018	9/16"	393028	7/8"
393019	19/32"	Socket Holder	

1000 g 15x1 15 sets / 16 Kgs / 0.73 CUFT

Made of Chrome Vanadium Steel

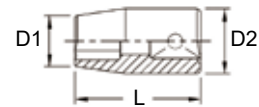
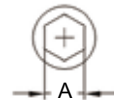

## Metric Deep Impact Sockets

Item No.	A mm	D1 mm	D2 mm	Length mm	Weight g	PCS inner/ctn	G.W. KGS	CUFT
316306	6	11.0	18.8	63	90	10 / 200	20.0	0.60
316307	7	12.0	18.8	63	90	10 / 200	20.0	0.60
316308	8	13.5	18.8	63	90	10 / 200	20.0	0.60
316309	9	15.0	18.8	63	90	10 / 200	20.0	0.60
316310	10	16.0	18.8	63	90	10 / 200	20.0	0.60
316311	11	17.0	18.8	63	90	10 / 200	20.0	0.60
316312	12	19.0	18.8	63	90	10 / 200	20.0	0.60
316313	13	19.8	19.8	63	90	10 / 200	20.0	0.60
316314	14	22.0	22.0	63	110	10 / 200	25.0	0.60
316315	15	22.0	22.0	63	120	10 / 200	25.0	0.60
316316	16	23.8	23.8	63	130	10 / 200	27.0	0.60
316317	17	24.8	24.8	63	140	10 / 120	18.0	0.35
316318	18	25.8	25.8	63	140	10 / 120	19.0	0.35
316319	19	27.8	27.8	63	160	10 / 120	21.0	0.35
316320	20	27.8	27.8	63	170	10 / 120	21.5	0.52
316321	21	29.8	29.8	63	210	10 / 120	27.5	0.52
316322	22	31.8	31.8	63	240	10 / 60	16.0	0.45



## SAE Deep Impact Sockets

Item No.	A inch	D1 mm	D2 mm	Length mm	Weight g	PCS inner/ctn	G.W. KGS	CUFT
396308	1/4	11.0	18.8	63	90	10 / 200	20.0	0.60
396310	5/16	13.5	18.8	63	90	10 / 200	20.0	0.60
396311	11/32	14.5	18.8	63	90	10 / 200	20.0	0.60
396312	3/8	15.0	18.8	63	90	10 / 200	20.0	0.60
396314	7/16	17.0	18.8	63	90	10 / 200	20.0	0.60
396316	1/2	18.8	18.8	63	90	10 / 200	20.0	0.60
396318	9/16	22.0	22.0	63	110	10 / 200	25.0	0.60
396319	19/32	22.0	22.0	63	120	10 / 200	25.0	0.60
396320	5/8	23.8	23.8	63	130	10 / 200	27.0	0.60
396322	11/16	24.8	24.8	63	140	10 / 120	18.0	0.35
396324	3/4	27.8	27.8	63	160	10 / 120	21.0	0.35
396325	25/32	27.8	27.8	63	170	10 / 120	21.5	0.52
396326	13/16	29.8	29.8	63	210	10 / 120	27.5	0.52
396328	7/8	31.8	31.8	63	240	10 / 60	16.0	0.45

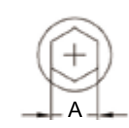

### TD-308M 8 Piece 3/8" Dr. Metric Deep Impact Socket Set

Previous Item No.: TF-004

Item No.	Size	Item No.	Size
<b>3/8" Dr. 6pt Deep Impact Socket:</b>			
316308	8mm	316313	13mm
316310	10mm	316314	14mm
316311	11mm	316317	17mm
316312	12mm	316319	19mm

Socket Holder



950 g    4x4 16 sets / 16.2 Kgs / 0.71 CUFT

### TD-308S 8 Piece 3/8" Dr. SAE Deep Impact Socket Set

Previous Item No.: TF-003

Item No.	Size	Item No.	Size
<b>3/8" Dr. 6pt Deep Impact Socket:</b>			
396310	5/16"	396318	9/16"
396312	3/8"	396320	5/8"
396314	7/16"	396322	11/16"
396316	1/2"	396324	3/4"

Socket Holder



975 g    4x4 16 sets / 16.5 Kgs / 0.71 CUFT

Impact Sockets

**3/8**

# Impact Sockets

## Impact Adapters

Item No.	Female Drive	Male Drive	Length mm	Weight g	PCS	G.W.	CUFT
					inner/ctn	KGS	
380040	3/8"	1/2"	35	50	20 / 300	16.0	0.69
380020	3/8"	1/4"	30	30	20 / 300	10.0	0.69

## Impact Bit Holders

Item No.	Hex Shank	Length mm	Weight g	PCS	G.W.	CUFT
				inner/ctn	KGS	
380031	1/4"	75	100	10 / 140	15.0	0.44
380032	1/4"	28	30	20 / 300	10.0	0.69
380033	5/16"	30	35	20 / 300	11.5	0.69

## Impact Extension Bars

Item No. (Previous No.)	Length mm (inch)	Weight g	PCS	G.W.	CUFT
			inner/ctn	KGS	
310002 (380005)	50 (2")	50	10 / 200	11.0	0.60
310003 (380029)	75 (3")	75	10 / 140	11.5	0.44
310005	125 (5")	120	10 / 120	15.5	0.30
310006 (380036)	150 (6")	145	10 / 120	19.0	0.30
310008 (380037)	200 (8")	190	10 / 100	20.0	0.34
310010	250 (10")	240	10 / 80	20.5	0.44
310012	300 (12")	285	5 / 60	18.0	0.52

## Impact Universal Joint

Item No.	Outside Diameter	Length mm	Weight g	PCS	G.W.	CUFT
				inner/ctn	KGS	
700107	26mm	65	95	10 / 200	23.0	0.60

## TF-308M 8 Piece 3/8" Dr. Metric Impact Socket Set

Previous Item No.: TF-002

Item No.	Size	Item No.	Size
<b>3/8" Dr. 6pt Impact Socket:</b>			
313008	8mm	313013	13mm
313010	10mm	313014	14mm
313011	11mm	313017	17mm
313012	12mm	313019	19mm



Socket Holder

470 g 6x6 36 sets / 18 Kgs / 1.41 CUFT

## TF-308S 8 Piece 3/8" Dr. SAE Impact Socket Set

Previous Item No.: TF-001

Item No.	Size	Item No.	Size
<b>3/8" Dr. 6pt Impact Socket:</b>			
393010	5/16"	393018	9/16"
393012	3/8"	393020	5/8"
393014	7/16"	393022	1 1/16"
393016	1/2"	393024	3/4"



Socket Holder

500 g 6x6 36 sets / 19 Kgs / 1.41 CUFT

## TF-316MD 16 Piece 3/8" Dr. Metric Deep Impact Socket Set

Item No.	Size	Item No.	Size
<b>3/8" Dr. 6pt Deep Impact Socket:</b>			
316307	7mm	316315	15mm
316308	8mm	316316	16mm
316309	9mm	316317	17mm
316310	10mm	316318	18mm
316311	11mm	316319	19mm
316312	12mm	316320	20mm
316313	13mm	316321	21mm
316314	14mm	316322	22mm



Socket Holder

2450 g 10x1 10 sets / 25.5 Kgs / 0.88 CUFT

Made of Chrome Vanadium Steel

**ENIUS**  
PROFESSIONAL TOOLS

## TF-313SD 13 Piece 3/8" Dr. SAE Deep Impact Socket Set

Item No.	Size	Item No.	Size
<b>3/8" Dr. 6pt Deep Impact Socket:</b>			
396310	5/16"	396320	5/8"
396311	11/32"	396322	11/16"
396312	3/8"	396324	3/4"
396314	7/16"	396325	25/32"
396316	1/2"	396326	13/16"
396318	9/16"	396328	7/8"
396319	19/32"	Socket Holder	

2050 g 12x1 12 sets / 26 Kgs / 0.73 CUFT



6 pt.

## TF-326M 26 Piece 3/8" Dr. Metric Impact Socket Set

Item No.	Size	Item No.	Size
<b>3/8" Dr. 6pt Impact Socket:</b>			
313006	6mm	313014	14mm
313007	7mm	313015	15mm
313008	8mm	313016	16mm
313010	10mm	313017	17mm
313011	11mm	313018	18mm
313012	12mm	313019	19mm
313013	13mm		
<b>3/8" Dr. 6pt Deep Impact Socket:</b>			
316306	6mm	316314	14mm
316307	7mm	316315	15mm
316308	8mm	316316	16mm
316310	10mm	316317	17mm
316311	11mm	316318	18mm
316312	12mm	316319	19mm
316313	13mm	Blow Case	

2650 g 5 sets / 14.3 Kgs / 0.60 CUFT



6 pt.

## TF-326S 26 Piece 3/8" Dr. SAE Impact Socket Set

Item No.	Size	Item No.	Size
<b>3/8" Dr. 6pt Impact Socket:</b>			
393010	5/16"	393020	5/8"
393011	11/32"	393022	11/16"
393012	3/8"	393024	3/4"
393014	7/16"	393025	25/32"
393016	1/2"	393026	13/16"
393018	9/16"	393028	7/8"
393019	19/32"		
<b>3/8" Dr. 6pt Deep Impact Socket:</b>			
396310	5/16"	396320	5/8"
396311	11/32"	396322	11/16"
396312	3/8"	396324	3/4"
396314	7/16"	396325	25/32"
396316	1/2"	396326	13/16"
396318	9/16"	396328	7/8"
396319	19/32"	Blow Case	

3050 g 5 sets / 16.5 Kgs / 0.60 CUFT



6 pt.



# Swivel Impact Sockets

## Metric Swivel Impact Sockets

Item No.	A mm	D1 mm	D2 mm	Length mm	Weight g	PCS inner/ctn	G.W. KGS	CUFT
380008M	8	14	26	53	110	10 / 200	23.0	0.60
380009M	9	15	26	53	110	10 / 200	23.0	0.60
380010M	10	16	26	53	110	10 / 200	23.0	0.60
380011M	11	18	26	53	110	10 / 200	23.0	0.60
380012M	12	19	26	53	110	10 / 200	23.0	0.60
380013M	13	20	26	53	110	10 / 200	23.0	0.60
380014M	14	22	26	53	120	10 / 200	25.0	0.60
380015M	15	23	26	53	120	10 / 200	25.0	0.60
380016M	16	24	26	53	120	10 / 200	25.0	0.60
380017M	17	25	26	53	130	10 / 200	27.0	0.60
380018M	18	26	26	53	130	10 / 200	27.0	0.60
380019M	19	28	26	53	130	10 / 200	27.0	0.60

## SAE Swivel Impact Sockets

Item No.	A inch	D1 mm	D2 mm	Length mm	Weight g	PCS inner/ctn	G.W. KGS	CUFT
380J21	5/16	14	26	53	110	10 / 200	20.0	0.60
380022	3/8	15	26	53	110	10 / 200	23.0	0.60
380023	7/16	18	26	53	110	10 / 200	23.0	0.60
380024	1/2	19	26	53	110	10 / 200	23.0	0.60
380025	9/16	22	26	53	120	10 / 200	25.0	0.60
380026	5/8	24	26	53	120	10 / 200	25.0	0.60
380027	11/16	25	26	53	130	10 / 200	27.0	0.60
380028	3/4	28	26	53	130	10 / 200	27.0	0.60

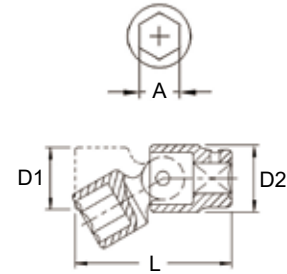

## TG-213M1 7 Piece 3/8" Dr. Metric Swivel Impact Socket Set

Item No.	Size	Item No.	Size
<b>3/8" Dr. 6pt Swivel Impact Socket:</b>			
380010M	10mm	380014M	14mm
380011M	11mm	380016M	16mm
380012M	12mm	380017M	17mm
380013M	13mm	Metal Box	

970 g      20 sets / 21 Kgs / 0.71 CUFT



## TG-312M 12 Piece 3/8" Dr. Metric Swivel Impact Socket Set

Item No.	Size	Item No.	Size
<b>3/8" Dr. 6pt Swivel Impact Socket:</b>			
380008M	8mm	380014M	14mm
380009M	9mm	380015M	15mm
380010M	10mm	380016M	16mm
380011M	11mm	380017M	17mm
380012M	12mm	380018M	18mm
380013M	13mm	380019M	19mm

Socket Holder

1270 g      12x1 12 sets / 16.5 Kgs / 0.73 CUFT



## TG-308S 8 Piece 3/8" Dr. SAE Swivel Impact Socket Set

Item No.	Size	Item No.	Size
<b>3/8" Dr. 6pt Swivel Impact Socket:</b>			
380J21	5/16"	380025	9/16"
380022	3/8"	380026	5/8"
380023	7/16"	380027	11/16"
380024	1/2"	380028	3/4"

Socket Holder

780 g      12x1 12 sets / 10.5 Kgs / 0.7 CUFT



## Metric Deep Swivel Impact Sockets

Item No.	A mm	D1 mm	D2 mm	Length mm	Weight g	PCS inner/ctn	G.W. KGS	CUFT
380008MD	8	14	26	95	210	4 / 80	18.5	0.34
380009MD	9	15	26	95	210	4 / 80	18.5	0.34
380010MD	10	16	26	95	210	4 / 80	18.5	0.34
380011MD	11	18	26	95	210	4 / 80	18.5	0.34
380012MD	12	19	26	95	210	4 / 80	18.5	0.34
380013MD	13	20	26	95	210	4 / 80	18.5	0.34
380014MD	14	22	26	95	210	4 / 80	18.5	0.34
380015MD	15	23	26	95	210	4 / 80	18.5	0.34
380016MD	16	24	26	95	210	4 / 80	18.5	0.34
380017MD	17	26	26	95	220	5 / 50	13.0	0.31
380018MD	18	26	26	95	230	5 / 50	13.0	0.31
380019MD	19	28	26	95	250	5 / 50	13.0	0.31

6 pt.



## SAE Deep Swivel Impact Sockets

Item No.	A inch	D1 mm	D2 mm	Length mm	Weight g	PCS inner/ctn	G.W. KGS	CUFT
380021D	5/16	14	26	95	210	4 / 80	18.5	0.34
380022D	3/8	15	26	95	210	4 / 80	18.5	0.34
380023D	7/16	18	26	95	210	4 / 80	18.5	0.34
380024D	1/2	19	26	95	210	4 / 80	18.5	0.34
380025D	9/16	22	26	95	210	4 / 80	18.5	0.34
380026D	5/8	24	26	95	210	4 / 80	18.5	0.34
380027D	11/16	26	26	95	220	5 / 50	12.0	0.31
380028D	3/4	28	26	95	250	5 / 50	13.0	0.31

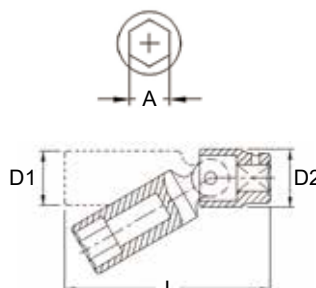

## TG-213M1D 7 Piece 3/8" Dr. Metric Deep Swivel Impact Socket Set

Item No.	Size	Item No.	Size
<b>3/8" Dr. 6pt Deep Swivel Impact Socket:</b>			
380010MD	10mm	380014MD	14mm
380011MD	11mm	380016MD	16mm
380012MD	12mm	380017MD	17mm
380013MD	13mm		Metal Box

2100 g 10 sets / 22 Kgs / 0.48 CUFT



6 pt.

## TG-312MD 12 Piece 3/8" Dr. Metric Deep Swivel Impact Socket Set

Item No.	Size	Item No.	Size
<b>3/8" Dr. 6pt Deep Swivel Impact Socket:</b>			
380008MD	8mm	380014MD	14mm
380009MD	9mm	380015MD	15mm
380010MD	10mm	380016MD	16mm
380011MD	11mm	380017MD	17mm
380012MD	12mm	380018MD	18mm
380013MD	13mm	380019MD	19mm

Socket Holder

2690 g 8x1 8 sets / 22.5 Kgs / 0.73 CUFT



6 pt.

## TG-308SD 8 Piece 3/8" Dr. SAE Deep Swivel Impact Socket Set

Item No.	Size	Item No.	Size
<b>3/8" Dr. 6pt Deep Swivel Impact Socket:</b>			
380021D	5/16"	380025D	9/16"
380022D	3/8"	380026D	5/8"
380023D	7/16"	380027D	11/16"
380024D	1/2"	380028D	3/4"

Socket Holder

1830 g 12x1 12 sets / 23 Kgs / 0.95 CUFT



6 pt.

Impact Sockets

3/8

# Swivel Impact Socket Sets

## TG-213 7 Piece 3/8" Dr. SAE Swivel Impact Socket Set

Item No.	Size	Item No.	Size
<b>3/8" Dr. 6pt Swivel Impact Socket:</b>			
380022	3/8"	380026	5/8"
380023	7/16"	380027	11/16"
380024	1/2"	380028	3/4"
380025	9/16"	Metal Box	

970 g 20 sets / 21 Kgs / 0.71 CUFT



6 pt.



## TG-213-D 7 Piece 3/8" Dr. SAE Deep Swivel Impact Socket Set

Item No.	Size	Item No.	Size
<b>3/8" Dr. 6pt Deep Swivel Impact Socket:</b>			
380022D	3/8"	380026D	5/8"
380023D	7/16"	380027D	11/16"
380024D	1/2"	380028D	3/4"
380025D	9/16"	Metal Box	

2100 g 10 sets / 22 Kgs / 0.48 CUFT



6 pt.



## MS-042M 42 Piece 3/8" Dr. Metric Deep Impact & Star Hand Socket Set

Item No.	Size	Item No.	Size
<b>3/8" Dr. 6pt Deep Impact Socket (CR-Mo):</b>			
346307	7mm	346315	15mm
346308	8mm	346316	16mm
346309	9mm	346317	17mm
346310	10mm	346318	18mm
346311	11mm	346319	19mm
346312	12mm	346320	20mm
346313	13mm	346321	21mm
346314	14mm	346322	22mm

Item No.	Size	Item No.	Size
<b>3/8" Dr. 6pt Swivel Impact Socket (CR-V):</b>			
380008M	8mm	380014M	14mm
380009M	9mm	380015M	15mm
380010M	10mm	380016M	16mm
380011M	11mm	380017M	17mm
380012M	12mm	380018M	18mm
380013M	13mm	380019M	19mm

Item No.	Size	Item No.	Size
<b>3/8" Dr. E-Star Hand Socket:</b>			
353510	E-10	353516	E-16
353511	E-11	353518	E-18
353512	E-12	353520	E-20
353514	E-14		

5080 g 3 sets / 16.5 Kgs / 1.35 CUFT

Item No.	Size
<b>3/8" Dr. Accessory:</b>	
380075CM	Impact Extension Bar, 75mmL
380125CM	Impact Extension Bar, 125mmL
380200CM	Impact Extension Bar, 200mmL
700107	Impact Universal Joint
320160L	L-Handle
380370	72T Stubby Ratchet
383363P	72T Flex Head Ratchet
	Plastic Tray



6 pt.

Star

1/2



(285W x 410D x 50H)

## Metric Impact Sockets

Item No.	A mm	D1 mm	D2 mm	Length mm	Weight g	PCS inner/ctn	G.W. KGS	CUFT
343206	6	11.0	18.8	28	35	20 / 300	12.0	0.69
343207	7	12.0	18.8	28	35	20 / 300	12.0	0.69
343208	8	13.5	18.8	28	35	20 / 300	12.0	0.69
343209	9	15.0	18.8	28	35	20 / 300	12.0	0.69
343210	10	16.0	18.8	28	35	20 / 300	12.0	0.69
343211	11	17.0	18.8	30	35	20 / 300	12.5	0.69
343212	12	19.0	18.8	30	40	20 / 300	12.5	0.69
343213	13	19.8	19.8	30	50	20 / 300	14.0	0.69
343214	14	22.0	22.0	30	50	20 / 300	17.0	0.69
343215	15	22.0	22.0	30	50	20 / 300	17.5	0.69
343216	16	23.8	22.0	30	60	20 / 300	17.5	0.69
343217	17	24.8	22.0	32	60	20 / 300	19.0	0.69
343218	18	25.8	22.0	32	65	20 / 300	19.0	0.69
343219	19	27.8	22.0	32	70	20 / 300	22.0	0.69
343220	20	27.8	22.0	32	75	20 / 300	22.0	0.69
343221	21	29.8	22.0	32	80	20 / 300	25.0	0.69
343222	22	31.8	22.5	32	85	20 / 300	26.5	0.69

6 pt.



## SAE Impact Sockets

Item No.	A inch	D1 mm	D2 mm	Length mm	Weight g	PCS inner/ctn	G.W. KGS	CUFT
363208	1/4	11.0	18.8	28	35	20 / 300	12.0	0.69
363210	5/16	13.5	18.8	28	35	20 / 300	12.0	0.69
363211	11/32	14.5	18.8	28	35	20 / 300	12.0	0.69
363212	3/8	15.0	18.8	28	35	20 / 300	12.0	0.69
363214	7/16	17.0	18.8	30	35	20 / 300	12.5	0.69
363216	1/2	18.8	18.8	30	35	20 / 300	12.5	0.69
363218	9/16	22.0	22.0	30	50	20 / 300	17.5	0.69
363219	19/32	22.0	22.0	30	50	20 / 300	17.5	0.69
363220	5/8	23.8	22.0	30	50	20 / 300	17.5	0.69
363222	11/16	24.8	22.0	32	60	20 / 300	22.0	0.69
363224	3/4	27.8	22.0	32	65	20 / 300	22.0	0.69
363225	25/32	27.8	22.0	32	70	20 / 300	22.0	0.69
363226	13/16	29.8	22.0	32	75	20 / 300	25.0	0.69
363228	7/8	31.8	22.0	32	80	20 / 300	26.5	0.69

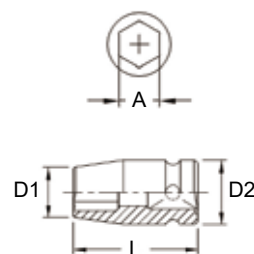

## CM-308M 8 Piece 3/8" Dr. Metric Impact Socket Set

Item No.	Size	Item No.	Size
<b>3/8" Dr. 6pt Impact Socket:</b>			
343208	8mm	343213	13mm
343210	10mm	343214	14mm
343211	11mm	343217	17mm
343212	12mm	343219	19mm

Socket Holder

430 g 6x6 36 sets / 16.5 Kgs / 1.41 CUFT



6 pt.

## CM-308S 8 Piece 3/8" Dr. SAE Impact Socket Set

Item No.	Size	Item No.	Size
<b>3/8" Dr. 6pt Impact Socket:</b>			
363210	5/16"	363218	9/16"
363212	3/8"	363220	5/8"
363214	7/16"	363222	11/16"
363216	1/2"	363224	3/4"

Socket Holder

450 g 6x6 36 sets / 17.2 Kgs / 1.41 CUFT



6 pt.

Impact Sockets



3/8

# Impact Sockets

## Metric Deep Impact Sockets

Item No.	A mm	D1 mm	D2 mm	Length mm	Weight g	PCS	G.W. KGS	CUFT
						inner/ctn		
346306	6	11.0	18.8	63	65	10 / 200	15.0	0.60
346307	7	12.0	18.8	63	65	10 / 200	15.0	0.60
346308	8	13.5	18.8	63	65	10 / 200	15.0	0.60
346309	9	15.0	18.8	63	70	10 / 200	15.0	0.60
346310	10	16.0	18.8	63	75	10 / 200	17.0	0.60
346311	11	17.0	18.8	63	75	10 / 200	17.0	0.60
346312	12	18.8	18.8	63	85	10 / 200	19.0	0.60
346313	13	19.8	19.8	63	85	10 / 200	19.0	0.60
346314	14	22.0	22.0	63	100	10 / 200	25.0	0.60
346315	15	22.0	22.0	63	100	10 / 200	25.0	0.60
346316	16	23.8	22.0	63	120	10 / 200	27.0	0.60
346317	17	24.8	22.0	63	130	10 / 200	27.0	0.60
346318	18	25.8	22.0	63	130	10 / 120	18.0	0.35
346319	19	27.8	22.0	63	150	10 / 120	19.0	0.35
346320	20	27.8	22.0	63	150	10 / 120	19.0	0.52
346321	21	29.8	22.0	63	160	10 / 120	21.5	0.52
346322	22	31.8	22.0	63	180	10 / 60	13.0	0.35

## SAE Deep Impact Sockets

Item No.	A inch	D1 mm	D2 mm	Length mm	Weight g	PCS	G.W. KGS	CUFT
						inner/ctn		
366308	1/4	11.0	18.8	63	65	10 / 200	15.0	0.60
366310	5/16	13.5	18.8	63	65	10 / 200	15.0	0.60
366311	11/32	14.5	18.8	63	65	10 / 200	15.0	0.60
366312	3/8	15.0	18.8	63	70	10 / 200	15.0	0.60
366314	7/16	17.0	18.8	63	75	10 / 200	17.0	0.60
366316	1/2	19.0	18.8	63	85	10 / 200	17.0	0.60
366318	9/16	22.0	22.0	63	100	10 / 200	25.0	0.60
366319	19/32	22.0	22.0	63	100	10 / 200	25.0	0.60
366320	5/8	23.8	22.0	63	120	10 / 200	25.0	0.60
366322	11/16	24.8	22.0	63	130	10 / 200	27.0	0.60
366324	3/4	27.8	22.0	63	150	10 / 120	20.0	0.35
366325	25/32	27.8	22.0	63	150	10 / 120	20.0	0.52
366326	13/16	29.8	22.0	63	160	10 / 120	21.5	0.52
366328	7/8	31.8	22.0	63	180	10 / 60	13.0	0.35

## CM-316MD 16 Piece 3/8" Dr. Metric Deep Impact Socket Set

Item No.	Size	Item No.	Size
<b>3/8" Dr. 6pt Deep Impact Socket:</b>			
346307	7mm	346315	15mm
346308	8mm	346316	16mm
346309	9mm	346317	17mm
346310	10mm	346318	18mm
346311	11mm	346319	19mm
346312	12mm	346320	20mm
346313	13mm	346321	21mm
346314	14mm	346322	22mm

Socket Holder

2400 g 10x1 10 sets / 25 Kgs / 0.88 CUFT

## CM-313SD 13 Piece 3/8" Dr. SAE Deep Impact Socket Set

Item No.	Size	Item No.	Size
<b>3/8" Dr. 6pt Deep Impact Socket:</b>			
366310	5/16"	366320	5/8"
366311	11/32"	366322	11/16"
366312	3/8"	366324	3/4"
366314	7/16"	366325	25/32"
366316	1/2"	366326	13/16"
366318	9/16"	366328	7/8"
366319	19/32"	Socket Holder	

2100 g 12x1 12 sets / 26 Kgs / 0.73 CUFT

Made of Chrome Molybdenum Steel



6 pt.

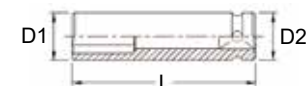

6 pt.



6 pt.





## Impact Adapters

Item No.	Female Drive	Male Drive	Length mm	Weight g	PCS inner/ctn	G.W. KGS	CUFT
340020	3/8"	1/4" w/Steel Ball	30	30	20 / 300	10.0	0.69
340040	3/8"	1/2" w/Pin Hole	35	50	20 / 300	16.0	0.69
340040B	3/8"	1/2" w/Steel Ball	35	50	20 / 300	16.0	0.69



## Impact Extension Bars

Item No. (Previous No.)	Length mm	Weight g	PCS inner/ctn	G.W. KGS	CUFT
380050CM	50 w/Pin Hole	50	10 / 200	11.0	0.60
380050MB	50 w/Steel Ball	50	10 / 200	11.0	0.60
380075CM (340075)	75 w/Pin Hole	75	10 / 140	11.5	0.44
380075MB (340075B)	75 w/Steel Ball	75	10 / 140	11.5	0.44
380125CM (340125)	125 w/Pin Hole	120	10 / 120	16.0	0.30
380125MB (340125B)	125 w/Steel Ball	120	10 / 120	16.0	0.30
380150CM	150 w/Pin Hole	145	10 / 120	18.5	0.30
380150MB	150 w/Steel Ball	145	10 / 120	18.5	0.30
380200CM (340200)	200 w/Pin Hole	190	10 / 100	20.5	0.34
380200MB (340200B)	200 w/Steel Ball	190	10 / 100	20.5	0.34
380250CM	250 w/Pin Hole	240	10 / 80	20.5	0.44
380250MB	250 w/Steel Ball	240	10 / 80	20.5	0.44
380300CM	300 w/Pin Hole	285	5 / 60	18.0	0.52
380300MB	300 w/Steel Ball	285	5 / 60	18.0	0.52



## Impact Bit Holders

Item No.	Hex Shank	Length mm	Weight g	PCS inner/ctn	G.W. KGS	CUFT
363908	1/4"	39	40	10 / 200	9.0	0.60
364608	1/4"	46	45	10 / 200	10.0	0.60
363910	5/16"	39	45	10 / 200	10.0	0.60
364610	5/16"	46	50	10 / 200	11.0	0.60



## Impact Bit Holders

Item No.	Hex Shank	Length mm	Weight g	PCS inner/ctn	G.W. KGS	CUFT
363008	1/4"	30	35	20 / 300	13.0	0.69
363010	5/16"	30	35	20 / 300	13.5	0.69



## CM-316M 16 Piece 3/8" Dr. Metric Impact Socket Set

Item No.	Size	Item No.	Size
<b>3/8" Dr. 6pt Impact Socket:</b>			
343207	7mm	343215	15mm
343208	8mm	343216	16mm
343209	9mm	343217	17mm
343210	10mm	343218	18mm
343211	11mm	343219	19mm
343212	12mm	343220	20mm
343213	13mm	343221	21mm
343214	14mm	343222	22mm

Socket Holder

1170 g 20x1 20 sets / 24.5 Kgs / 0.88 CUFT



## CM-313S 13 Piece 3/8" Dr. SAE Impact Socket Set

Item No.	Size	Item No.	Size
<b>3/8" Dr. 6pt Impact Socket:</b>			
363210	5/16"	363220	5/8"
363211	11/32"	363222	11/16"
363212	3/8"	363224	3/4"
363214	7/16"	363225	25/32"
363216	1/2"	363226	13/16"
363218	9/16"	363228	7/8"
363219	19/32"	Socket Holder	

1000 g 15x1 15 sets / 16 Kgs / 0.73 CUFT



Impact Sockets

**3/8**

# Impact Socket Sets

## CD-308M 8 Piece 3/8" Dr. Metric Deep Impact Socket Set

Previous Item No.: CM-004

Item No.	Size	Item No.	Size
<b>3/8" Dr. 6pt Deep Impact Socket:</b>			
346308	8mm	346313	13mm
346310	10mm	346314	14mm
346311	11mm	346317	17mm
346312	12mm	346319	19mm
Socket Holder			



6 pt.

875 g

5x4 20 sets / 18.5 Kgs / 0.71 CUFT

## CD-308S 8 Piece 3/8" Dr. SAE Deep Impact Socket Set

Previous Item No.: CM-003

Item No.	Size	Item No.	Size
<b>3/8" Dr. 6pt Deep Impact Socket:</b>			
366310	5/16"	366318	9/16"
366312	3/8"	366320	5/8"
366314	7/16"	366322	11/16"
366316	1/2"	366324	3/4"
Socket Holder			



6 pt.

875 g

5x4 20 sets / 18.5 Kgs / 0.71 CUFT

## IS-314M 14 Piece 3/8" Dr. Metric Impact Socket Set

Item No.	Size	Item No.	Size
<b>3/8" Dr. 6pt Impact Socket:</b>			
343208	8mm	343215	15mm
343209	9mm	343216	16mm
343210	10mm	343217	17mm
343211	11mm	343218	18mm
343212	12mm	343219	19mm
343213	13mm	343221	21mm
343214	14mm		



(192W x 203D)

6 pt.

1/6

### Accessory:

380075MB Impact Extension Bar, 75mmL  
Plastic Tray

950 g

10 sets / 10.5 Kgs / 0.93 CUFT

## CM-332M 32 Piece 3/8" Dr. Metric Deep Impact Socket Set

Item No.	Size	Item No.	Size
<b>3/8" Dr. 6pt Impact Socket:</b>			
343207	7mm	343215	15mm
343208	8mm	343216	16mm
343209	9mm	343217	17mm
343210	10mm	343218	18mm
343211	11mm	343219	19mm
343212	12mm	343220	20mm
343213	13mm	343221	21mm
343214	14mm	343222	22mm

### 3/8" Dr. 6pt Deep Impact Socket:

346307	7mm	346315	15mm
346308	8mm	346316	16mm
346309	9mm	346317	17mm
346310	10mm	346318	18mm
346311	11mm	346319	19mm
346312	12mm	346320	20mm
346313	13mm	346321	21mm
346314	14mm	346322	22mm

Plastic Tray



(192W x 406D)

6 pt.

1/3

3450 g

5 sets / 18 Kgs / 0.93 CUFT

Made of Chrome Molybdenum Steel

**ENIUS**  
PROFESSIONAL TOOLS

A-15

## ID-321M 21 Piece 3/8" Dr. Metric Impact Driver Set

Item No.	Size	Item No.	Size
<b>3/8" Dr. 6pt Impact Socket:</b>			
343208	8mm	343213	13mm
343210	10mm	343214	14mm
343211	11mm	343217	17mm
343212	12mm	343219	19mm
<b>3/8" Dr. Head Driver, 52mmL:</b>			
3452P055	1.0 x 5.5mm Slotted	345208	8mm Hex
3452P08	1.2 x 8.0mm Slotted	345210	10mm Hex
3452P10	1.6 x 10.0mm Slotted	3452R01	#1 Philips
345205	5mm Hex	3452R02	#2 Philips
345206	6mm Hex	3452R03	#3 Philips
345207	7mm Hex	3452R04	#4 Philips

**Accessory:**

700007	3/8" Dr. Impact Driver	Blow Case
--------	------------------------	-----------

2200 g      10 sets / 23 Kgs / 0.82 CUFT



SAE size: ID-321S also available

## CM-326M 26 Piece 3/8" Dr. Metric Impact Socket Set (CRMO)

Item No.	Size	Item No.	Size
<b>3/8" Dr. 6pt Impact Socket:</b>			
343206	6mm	343214	14mm
343207	7mm	343215	15mm
343208	8mm	343216	16mm
343210	10mm	343217	17mm
343211	11mm	343218	18mm
343212	12mm	343219	19mm
343213	13mm		
<b>3/8" Dr. 6pt Deep Impact Socket:</b>			
346306	6mm	346314	14mm
346307	7mm	346315	15mm
346308	8mm	346316	16mm
346310	10mm	346317	17mm
346311	11mm	346318	18mm
346312	12mm	346319	19mm
346313	13mm	Blow Case	

2400 g      5 sets / 13 Kgs / 0.60 CUFT



## CM-326S 26 Piece 3/8" Dr. SAE Impact Socket Set

Item No.	Size	Item No.	Size
<b>3/8" Dr. 6pt Impact Socket:</b>			
363210	5/16"	363220	5/8"
363211	11/32"	363222	11/16"
363212	3/8"	363224	3/4"
363214	7/16"	363225	25/32"
363216	1/2"	363226	13/16"
363218	9/16"	363228	7/8"
363219	19/32"		
<b>3/8" Dr. 6pt Deep Impact Socket:</b>			
366310	5/16"	366320	5/8"
366311	11/32"	366322	11/16"
366312	3/8"	366324	3/4"
366314	7/16"	366325	25/32"
366316	1/2"	366326	13/16"
366318	9/16"	366328	7/8"
366319	19/32"	Blow Case	

2700 g      5 sets / 14.5 Kgs / 0.60 CUFT



Impact Sockets



# Impact Sockets

## Metric Impact Sockets

Item No.	A	D1	D2	Length mm	Weight g	PCS inner/ctn	G.W. KGS	CUFT
	mm	mm	mm					
413808	8	12.8	23.3	38	75	10 / 200	17.0	0.59
413809	9	14.0	23.3	38	75	10 / 200	17.0	0.59
413810	10	14.9	23.3	38	75	10 / 200	17.0	0.59
413811	11	16.6	23.3	38	75	10 / 200	17.0	0.59
413812	12	17.8	23.3	38	75	10 / 200	17.0	0.59
413813	13	18.8	23.3	38	75	10 / 200	17.0	0.59
413814	14	20.4	23.3	38	75	10 / 200	17.0	0.59
413815	15	21.5	23.3	38	75	10 / 200	17.0	0.59
413816	16	23.8	23.8	38	75	10 / 200	17.0	0.59
413817	17	25.8	25.8	38	95	10 / 200	21.0	0.59
413818	18	26.8	26.8	38	100	10 / 200	23.0	0.59
413819	19	27.8	27.8	38	100	10 / 200	23.0	0.59
413820	20	29.8	29.8	38	120	10 / 150	20.5	0.52
413821	21	29.8	29.8	38	120	10 / 150	20.5	0.52
413822	22	31.8	31.8	38	140	10 / 100	16.0	0.62
413823	23	33.8	33.8	38	150	10 / 100	17.0	0.62
413824	24	33.8	33.8	38	160	10 / 100	18.0	0.62
413825	25	35.8	35.8	38	170	10 / 100	19.0	0.62
413826	26	35.8	35.8	38	180	10 / 100	20.0	0.62
413827	27	37.8	35.0	38	200	10 / 100	21.0	0.62
413828	28	39.8	35.0	46	240	10 / 100	26.0	0.62
413829	29	39.8	35.0	46	240	10 / 100	26.0	0.62
413830	30	41.8	35.0	46	250	10 / 100	26.0	0.62
413831	31	43.8	35.0	46	270	10 / 100	29.0	0.62
413832	32	44.8	35.0	46	280	10 / 100	29.0	0.62



## SAE Impact Sockets

Item No.	A	D1	D2	Length mm	Weight g	PCS inner/ctn	G.W. KGS	CUFT
	inch	mm	mm					
493810	5/16	12.8	23.3	38	75	10 / 200	17.0	0.59
493812	3/8	14.7	23.3	38	75	10 / 200	17.0	0.59
493814	7/16	16.7	23.3	38	75	10 / 200	17.0	0.59
493816	1/2	18.6	23.3	38	75	10 / 200	17.0	0.59
493818	9/16	20.6	23.3	38	75	10 / 200	17.0	0.59
493819	19/32	21.5	23.3	38	75	10 / 200	17.0	0.59
493820	5/8	23.8	23.8	38	75	10 / 200	17.0	0.59
493822	11/16	25.8	25.8	38	95	10 / 200	21.0	0.59
493824	3/4	27.8	27.8	38	100	10 / 200	23.0	0.59
493825	25/32	29.8	29.8	38	120	10 / 150	21.0	0.52
493826	13/16	29.8	29.8	38	120	10 / 150	21.0	0.52
493828	7/8	31.8	31.8	38	140	10 / 150	24.0	0.52
493830	15/16	33.8	33.8	38	160	10 / 100	18.0	0.62
493832	1	35.8	35.8	38	170	10 / 100	19.0	0.62
493834	1-1/16	37.8	35.0	38	200	10 / 100	21.0	0.62
493836	1-1/8	39.8	35.0	46	240	10 / 100	26.0	0.62
493838	1-3/16	41.8	35.0	46	250	10 / 100	26.0	0.62
493840	1-1/4	43.8	35.0	46	280	10 / 100	29.0	0.62

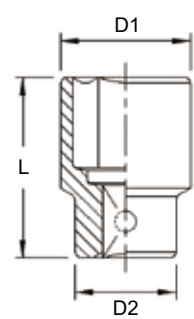
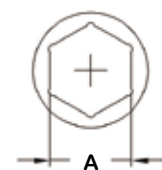

## Impact Adapters

Item No.	Female Drive	Male Drive	Length mm	Weight g	PCS inner/ctn	G.W. KGS	CUFT
480033	1/2"	3/8"	38	70	10 / 200	13.0	0.59
480066	1/2"	3/4"	41	110	10 / 200	28.0	0.59



## Impact Bit Holder

Item No.	Hex Shank	Length mm	Weight g	PCS inner/ctn	G.W. KGS	CUFT
480038	1/4"	75	130	10 / 140	19.5	0.44



Made of Chrome Vanadium Steel



## Metric Deep Impact Sockets

Item No.	A mm	D1 mm	D2 mm	Length mm	Weight g	PCS inner/ctn	G.W. KGS	CUFT
417808	8	12.8	23.3	78	180	10 / 140	26.0	0.44
417809	9	14.0	23.3	78	180	10 / 140	26.0	0.44
417810	10	14.9	23.3	78	180	10 / 140	26.0	0.44
417811	11	16.6	23.3	78	180	10 / 140	26.0	0.44
417812	12	17.8	23.3	78	180	10 / 140	27.5	0.44
417813	13	18.8	23.3	78	180	10 / 140	27.5	0.44
417814	14	20.4	23.8	78	190	10 / 140	27.5	0.44
417815	15	21.5	23.3	78	190	10 / 140	27.5	0.44
417816	16	23.8	23.8	78	190	10 / 140	27.5	0.44
417817	17	25.8	25.8	78	200	10 / 120	28.0	0.52
417818	18	26.8	26.8	78	210	10 / 120	28.0	0.52
417819	19	27.8	27.8	78	250	10 / 120	31.0	0.52
417820	20	29.8	29.8	78	270	10 / 120	33.0	0.52
417821	21	29.8	29.8	78	280	10 / 60	18.5	0.45
417822	22	31.8	31.8	78	290	10 / 60	19.0	0.45
417823	23	33.8	33.8	78	320	10 / 60	22.0	0.45
417824	24	34.8	34.8	78	340	10 / 60	22.0	0.45
417825	25	35.8	35.8	78	340	10 / 60	22.5	0.45
417826	26	35.8	35.8	78	350	10 / 60	22.5	0.45
417827	27	38.8	35.0	78	380	10 / 60	22.5	0.45
417828	28	39.8	35.0	78	390	5 / 50	20.0	0.62
417829	29	39.8	35.0	78	400	5 / 50	21.0	0.62
417830	30	41.8	35.0	78	410	5 / 50	22.0	0.62
417831	31	43.8	35.0	78	450	5 / 50	23.5	0.62
417832	32	44.8	35.0	78	460	5 / 50	24.0	0.62

6 pt.

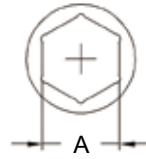

## SAE Deep Impact Sockets

Item No.	A inch	D1 mm	D2 mm	Length mm	Weight g	PCS inner/ctn	G.W. KGS	CUFT
497810	5/16	12.8	23.3	78	180	10 / 140	26.0	0.44
497812	3/8	14.7	23.8	78	180	10 / 140	26.0	0.44
497814	7/16	16.7	23.3	78	180	10 / 140	26.0	0.44
497816	1/2	18.6	23.3	78	190	10 / 140	27.5	0.44
497818	9/16	20.6	23.3	78	190	10 / 140	27.5	0.44
497819	19/32	21.5	23.3	78	190	10 / 140	27.5	0.44
497820	5/8	23.8	23.8	78	190	10 / 120	27.5	0.52
497822	11/16	25.8	25.8	78	200	10 / 120	28.0	0.52
497824	3/4	27.8	27.8	78	250	10 / 120	31.0	0.52
497825	25/32	29.8	29.8	78	270	10 / 120	33.0	0.52
497826	13/16	29.8	29.8	78	280	10 / 60	18.5	0.45
497828	7/8	31.8	31.8	78	290	10 / 60	19.0	0.45
497830	15/16	33.8	33.8	78	340	10 / 60	22.0	0.45
497832	1	35.8	35.8	78	340	10 / 60	22.5	0.45
497834	1-1/16	38.8	35.0	78	380	10 / 60	24.0	0.45
497836	1-1/8	39.8	35.0	78	400	5 / 50	21.0	0.62
497838	1-3/16	41.8	35.0	78	410	5 / 50	22.0	0.62
497840	1-1/4	43.8	35.0	78	460	5 / 50	24.0	0.62

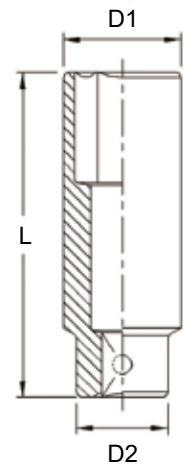

## Impact Extension Bars

Item No. (Previous No.)	Length mm (inch)	Weight g	PCS inner/ctn	G.W. KGS	CUFT
410002 (480002)	50 (2")	95	10 / 200	20.0	0.60
410003 (480032)	75 (3")	135	10 / 140	20.0	0.44
410005 (480036)	125 (5")	220	5 / 60	14.5	0.30
410006	150 (6")	265	5 / 60	17.0	0.30
410008	200 (8")	340	5 / 60	21.5	0.52
410010 (480320)	250 (10")	430	5 / 60	26.8	0.52
410012	300 (12")	510	5 / 40	21.5	0.38



## Impact Universal Joint

Item No.	Outside Diameter	Length mm	Weight g	PCS inner/ctn	G.W. KGS	CUFT
700108	28mm	70	150	10 / 120	20.5	0.52



Impact Sockets

**1/2**

# Impact Socket Sets

## TF-407M1 7 Piece 1/2" Dr. Metric Impact Socket Set

Item No.	Size	Item No.	Size
<b>1/2" Dr. 6pt Impact Socket:</b>			
413809	9mm	413814	14mm
413810	10mm	413817	17mm
413811	11mm	413819	19mm
413813	13mm	Metal Tray	

700 g 36x1 36 sets / 26.5 Kgs / 0.52 CUFT



6 pt.



## TF-407 7 Piece 1/2" Dr. SAE Impact Socket Set

Item No.	Size	Item No.	Size
<b>1/2" Dr. 6pt Impact Socket:</b>			
493812	3/8"	493820	5/8"
493814	7/16"	493822	11/16"
493816	1/2"	493824	3/4"
493818	9/16"	Metal Tray	

700 g 36x1 36 sets / 26.5 Kgs / 0.52 CUFT



6 pt.



## TF-410M2 10 Piece 1/2" Dr. Metric Impact Socket Set

Previous Item No.: TF-006

Item No.	Size	Item No.	Size
<b>1/2" Dr. 6pt Impact Socket:</b>			
413811	11mm	413817	17mm
413812	12mm	413819	19mm
413813	13mm	413821	21mm
413814	14mm	413822	22mm
413816	16mm	413824	24mm
Socket Holder			

1100 g 6x3 18 sets / 20.8 Kgs / 1.16 CUFT



6 pt.



## TF-410M3 10 Piece 1/2" Dr. Metric Impact Socket Set

Previous Item No.: TF-006-1

Item No.	Size	Item No.	Size
<b>1/2" Dr. 6pt Impact Socket:</b>			
413810	10mm	413817	17mm
413812	12mm	413819	19mm
413813	13mm	413821	21mm
413814	14mm	413822	22mm
413816	16mm	413824	24mm
Socket Holder			

1100 g 6x3 18 sets / 20.8 Kgs / 1.16 CUFT



6 pt.



## TF-410S 10 Piece 1/2" Dr. SAE Impact Socket Set

Previous Item No.: TF-005

Item No.	Size	Item No.	Size
<b>1/2" Dr. 6pt Impact Socket:</b>			
493814	7/16"	493824	3/4"
493816	1/2"	493826	13/16"
493818	9/16"	493828	7/8"
493820	5/8"	493830	15/16"
493822	11/16"	493832	1"
Socket Holder			

1200 g 6x3 18 sets / 22.5 Kgs / 1.16 CUFT



6 pt.



## TF-415M 15 Piece 1/2" Dr. Metric Impact Socket Set Previous Item No.: TF-016

Item No.	Size	Item No.	Size
<b>1/2" Dr. 6pt Impact Socket:</b>			
413810	10mm	413818	18mm
413811	11mm	413819	19mm
413812	12mm	413821	21mm
413813	13mm	413822	22mm
413814	14mm	413824	24mm
413815	15mm	413827	27mm
413816	16mm	413830	30mm
413817	17mm	Socket Holder	

1850 g 8x1 8 sets / 15.8 Kgs / 0.7 CUFT



6 pt.

## TF-415S 15 Piece 1/2" Dr. SAE Impact Socket Set Previous Item No.: TF-015

Item No.	Size	Item No.	Size
<b>1/2" Dr. 6pt Impact Socket:</b>			
493810	5/16"	493826	13/16"
493812	3/8"	493828	7/8"
493814	7/16"	493830	15/16"
493816	1/2"	493832	1"
493818	9/16"	493834	1-1/16"
493820	5/8"	493836	1-1/8"
493822	11/16"	493840	1-1/4"
493824	3/4"	Socket Holder	

2000 g 8x1 8 sets / 17 Kgs / 0.7 CUFT



6 pt.

## TD-413M 13 Piece 1/2" Dr. Metric Deep Impact Socket Set Previous Item No.: FD-414M1

Item No.	Size	Item No.	Size
<b>1/2" Dr. 6pt Deep Impact Socket:</b>			
417810	10mm	417819	19mm
417811	11mm	417821	21mm
417812	12mm	417822	22mm
417813	13mm	417824	24mm
417814	14mm	417827	27mm
417816	16mm	417830	30mm
417817	17mm	Metal Box	

4000 g 4 sets / 17 Kgs / 0.43 CUFT



6 pt.

## TD-413S 13 Piece 1/2" Dr. SAE Deep Impact Socket Set Previous Item No.: TF-031

Item No.	Size	Item No.	Size
<b>1/2" Dr. 6pt Deep Impact Socket:</b>			
497814	7/16"	497828	7/8"
497816	1/2"	497830	15/16"
497818	9/16"	497832	1"
497820	5/8"	497834	1-1/16"
497822	11/16"	497836	1-1/8"
497824	3/4"	497840	1-1/4"
497826	13/16"	Metal Box	

4620 g 4 sets / 19.5 Kgs / 0.43 CUFT



6 pt.

Impact Sockets



**1/2**

# Impact Socket Sets

## FD-410M 9 Piece 1/2" Dr. Metric Wheel Impact Socket Set

Item No.	Size	Item No.	Size
<b>1/2" Dr. 6pt Impact Socket:</b>			
413813	13mm	413819	19mm
413814	14mm	413821	21mm
413817	17mm	413824	24mm
<b>1/2" Dr. 6pt Deep Impact Socket:</b>			
417817	17mm	417822	22mm
417819	19mm	Socket Holder	

1500 g

10x1 10 sets / 16 Kgs / 0.71 CUFT



## TD-410M1 10 Piece 1/2" Dr. Metric Deep Impact Socket Set

[Previous Item No.: TF-008-1](#)

Item No.	Size	Item No.	Size
<b>1/2" Dr. 6pt Deep Impact Socket:</b>			
417810	10mm	417817	17mm
417812	12mm	417819	19mm
417813	13mm	417821	21mm
417814	14mm	417822	22mm
417816	16mm	417824	24mm

2530 g

10 sets / 26.3 Kgs / 0.52 CUFT



## TD-410M 10 Piece 1/2" Dr. Metric Deep Impact Socket Set

[Previous Item No.: TF-008](#)

Item No.	Size	Item No.	Size
<b>1/2" Dr. 6pt Deep Impact Socket:</b>			
417811	11mm	417817	17mm
417812	12mm	417819	19mm
417813	13mm	417821	21mm
417814	14mm	417822	22mm
417816	16mm	417824	24mm

2530 g

10 sets / 26.3 Kgs / 0.52 CUFT



## TD-410S 10 Piece 1/2" Dr. SAE Deep Impact Socket Set

[Previous Item No.: TF-007](#)

Item No.	Size	Item No.	Size
<b>1/2" Dr. 6pt Deep Impact Socket:</b>			
497814	7/16"	497824	3/4"
497816	1/2"	497826	13/16"
497818	9/16"	497828	7/8"
497820	5/8"	497830	15/16"
497822	11/16"	497832	1"

2830 g

10 sets / 29.3 Kgs / 0.52 CUFT



## UA-23411 11 Piece 1/4" , 3/8" & 1/2" Dr. Universal Joint and Adapter Set

Item No.	Size
700106	1/4" Dr. Impact Universal Joint
700107	3/8" Dr. Impact Universal Joint
700108	1/2" Dr. Impact Universal Joint
280070	1/4" Dr. Hand Universal Joint
380070	3/8" Dr. Hand Universal Joint
480070	1/2" Dr. Hand Universal Joint
290030	1/4" Dr. Impact Adapter, 1/4"F x 3/8"M
340020	3/8" Dr. Impact Adapter, 3/8"F x 1/4"M
340040B	3/8" Dr. Impact Adapter, 3/8"F x 1/2"M
480033MB	1/2" Dr. Impact Adapter, 1/2"F x 3/8"M
480066MB	1/2" Dr. Impact Adapter, 1/2"F x 3/4"M

1120 g

10 sets / 12.5 Kgs / 0.82 CUFT



## TD-3415M 14 Piece 3/8" & 1/2" Dr. Metric Deep Impact Socket Set

Item No.	Size	Item No.	Size
<b>3/8" Dr. 6pt Deep Impact Socket:</b>			
316308	8mm	316312	12mm
316310	10mm	316313	13mm
316311	11mm	316314	14mm
<b>1/2" Dr. 6pt Deep Impact Socket:</b>			
417816	16mm	417821	21mm
417817	17mm	417822	22mm
417819	19mm	417824	24mm

### Accessory:

380040	3/8" Dr. Impact Adapter, 3/8"F x 1/2"M
480033	1/2" Dr. Impact Adapter, 1/2"F x 3/8"M

2600 g

5 sets / 14 Kgs / 0.63 CUFT



6 pt.

## TD-3415S 14 Piece 3/8" & 1/2" Dr. SAE Deep Impact Socket Set

Item No.	Size	Item No.	Size
<b>3/8" Dr. 6pt Deep Impact Socket:</b>			
396310	5/16"	396316	1/2"
396312	3/8"	396318	9/16"
396314	7/16"	396320	5/8"
<b>1/2" Dr. 6pt Deep Impact Socket:</b>			
497822	11/16"	497828	7/8"
497824	3/4"	497830	15/16"
497826	13/16"	497832	1"

### Accessory:

380040	3/8" Dr. Impact Adapter, 3/8"F x 1/2"M
480033	1/2" Dr. Impact Adapter, 1/2"F x 3/8"M

2600 g

5 sets / 14 Kgs / 0.63 CUFT



6 pt.



# Impact Socket Sets

## TD-416M 16 Piece 1/2" Dr. Metric Deep Impact Socket Set

Item No.	Size	Item No.	Size
<b>1/2" Dr. 6pt Deep Impact Socket:</b>			
417810	10mm	417818	18mm
417811	11mm	417819	19mm
417812	12mm	417820	20mm
417813	13mm	417821	21mm
417814	14mm	417822	22mm
417815	15mm	417824	24mm
417816	16mm	417827	27mm
417817	17mm	417830	30mm

Blow Case

4500 g

6 sets / 28 Kgs / 1.21 CUFT



6 pt.



## TD-416M1 16 Piece 1/2" Dr. Metric Deep Impact Socket Set

Item No.	Size	Item No.	Size
<b>1/2" Dr. 6pt Deep Impact Socket:</b>			
417810	10mm	417818	18mm
417811	11mm	417819	19mm
417812	12mm	417821	21mm
417813	13mm	417822	22mm
417814	14mm	417824	24mm
417815	15mm	417827	27mm
417816	16mm	417830	30mm
417817	17mm	417832	32mm

Blow Case

4550 g

6 sets / 28.5 Kgs / 1.21 CUFT



6 pt.



## TD-416S 16 Piece 1/2" Dr. SAE Deep Impact Socket Set

Item No.	Size	Item No.	Size
<b>1/2" Dr. 6pt Deep Impact Socket:</b>			
497810	5/16"	497826	13/16"
497812	3/8"	497828	7/8"
497814	7/16"	497830	15/16"
497816	1/2"	497832	1"
497818	9/16"	497834	1-1/16"
497820	5/8"	497836	1-1/8"
497822	11/16"	497838	1-3/16"
497824	3/4"	497840	1-1/4"

Blow Case

5000 g

6 sets / 31 Kgs / 1.21 CUFT



6 pt.



# Impact Socket Sets

1/4 3/8 1/2

## IE-2349 9 Piece 1/4", 3/8" & 1/2" Dr. Impact Extension Bar Set

Item No.	Size
<b>Impact Extension Bar:</b>	
210002	1/4" Dr. 50mmL (2"L)
210004	1/4" Dr. 100mmL (4"L)
210006	1/4" Dr. 150mmL (6"L)
310002	3/8" Dr. 50mmL (2"L)
310003	3/8" Dr. 75mmL (3"L)
310006	3/8" Dr. 150mmL (6"L)
410002	1/2" Dr. 50mmL (2"L)
410005	1/2" Dr. 125mmL (5"L)
410010	1/2" Dr. 250mmL (10"L)

Plastic Tray



(192W x 203D)

1400 g 10 sets / 15 Kgs / 0.93 CUFT

1/6

## TF-019MS 18 Piece 1/2" Dr. Metric & SAE Impact Socket Set

Item No.	Size	Item No.	Size
<b>1/2" Dr. 6pt Impact Socket:</b>			
413811	11mm	493816	1/2"
413812	12mm	493818	9/16"
413813	13mm	493820	5/8"
413814	14mm	493822	11/16"
413816	16mm	493824	3/4"
413817	17mm	493826	13/16"
413819	19mm	493828	7/8"
413821	21mm	493830	15/16"
493814	7/16"	493832	1"

Metal Box



6 pt.

2300 g 8 sets / 20 Kgs / 0.49 CUFT

## TF-416M 16 Piece 1/2" Dr. Metric Impact Socket Set

Item No.	Size	Item No.	Size
<b>1/2" Dr. 6pt Impact Socket(CRV):</b>			
413808	8mm	413817	17mm
413810	10mm	413819	19mm
413811	11mm	413821	21mm
413812	12mm	413822	22mm
413813	13mm	413824	24mm
413814	14mm	413827	27mm
413816	16mm		

**1/2" Dr. Accessory:**

480036	Extension Bar, 125mmL	480446A	Hinge Handle
480444R	24T Reversible Ratchet		Blow Case

4000 g 4 sets / 17 Kgs / 0.93 CUFT

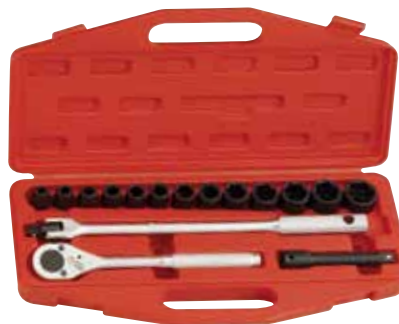

6 pt.

## TF-416S 16 Piece 1/2" Dr. SAE Impact Socket Set

Item No.	Size	Item No.	Size
<b>1/2" Dr. 6pt Impact Socket(CRV):</b>			
493810	5/16"	493824	3/4"
493812	3/8"	493826	13/16"
493814	7/16"	493828	7/8"
493816	1/2"	493830	15/16"
493818	9/16"	493832	1"
493820	5/8"	493834	1-1/16"
493822	11/16"		

**1/2" Dr. Accessory:**

480036	Extension Bar, 125mmL	480446A	Hinge Handle
480444R	24T Reversible Ratchet		Blow Case

4000 g 4 sets / 17 Kgs / 0.93 CUFT



6 pt.

Made of Chrome Vanadium Steel



# Impact Socket Sets



## MS-435I 35 Piece 1/2" Dr. Metric Deep Impact Socket Set

Item No.	Size	Item No.	Size	Item No.	Size
<b>1/2" Dr. 6pt Impact Socket (CR-V):</b>					
413810	10mm	413819	19mm	410002	Impact Extension Bar, 50mmL
413812	12mm	413821	21mm	410003	Impact Extension Bar, 75mmL
413813	13mm	413822	22mm	410005	Impact Extension Bar, 125mmL
413814	14mm	413824	24mm	410010	Impact Extension Bar, 250mmL
413815	15mm	413827	27mm	700108	Impact Universal Joint
413816	16mm	413830	30mm		Plastic Tray
413817	17mm	413832	32mm		
413818	18mm				
<b>1/2" Dr. 6pt Deep Impact Socket (CR-V):</b>					
417810	10mm	417819	19mm		
417812	12mm	417821	21mm		
417813	13mm	417822	22mm		
417814	14mm	417824	24mm		
417815	15mm	417827	27mm		
417816	16mm	417830	30mm		
417817	17mm	417832	32mm		
417818	18mm				



(285W x 410D x 50H)



7100 g 3 sets / 23 Kgs / 1.35 CUFT

## TF-425M 25 Piece 1/2" Dr. Metric Impact Socket Set

Item No.	Size	Item No.	Size
<b>1/2" Dr. 6pt Impact Socket (CR-V):</b>			
413808	8mm	413821	21mm
413809	9mm	413822	22mm
413810	10mm	413823	23mm
413811	11mm	413824	24mm
413812	12mm	413825	25mm
413813	13mm	413826	26mm
413814	14mm	413827	27mm
413815	15mm	413828	28mm
413816	16mm	413829	29mm
413817	17mm	413830	30mm
413818	18mm	413831	31mm
413819	19mm	413832	32mm
413820	20mm		Plastic Tray



(192W x 406D)



3700 g 3 sets / 13 Kgs / 0.82 CUFT

## TD-424M 24 Piece 1/2" Dr. Metric Deep Impact Socket Set

Previous Item No.: TF-425MD

Item No.	Size	Item No.	Size
<b>1/2" Dr. 6pt Deep Impact Socket (CR-V):</b>			
417808	8mm	417820	20mm
417809	9mm	417821	21mm
417810	10mm	417822	22mm
417811	11mm	417823	23mm
417812	12mm	417824	24mm
417813	13mm	417825	25mm
417814	14mm	417826	26mm
417815	15mm	417827	27mm
417816	16mm	417828	28mm
417817	17mm	417830	30mm
417818	18mm	417831	31mm
417819	19mm	417832	32mm



(192W x 406D)



Blow-mold Tray

6200 g 3 sets / 20 Kgs / 0.82 CUFT

Made of Chrome Vanadium Steel



## Metric Swivel Impact Sockets

Item No.	A mm	D1 mm	D2 mm	Length mm	Weight g	PCS inner/ctn	G.W. KGS	CUFT
480011M	11	19	28	66	150	5 / 100	16.0	0.39
480012M	12	20	28	66	150	5 / 100	16.0	0.39
480013M	13	20	28	66	150	5 / 100	16.0	0.39
480014M	14	22	28	66	160	5 / 100	17.0	0.39
480015M	15	24	28	66	160	5 / 100	17.0	0.39
480016M	16	24	28	66	170	5 / 100	18.0	0.39
480017M	17	26	32	66	190	4 / 80	16.0	0.39
480018M	18	26	32	66	220	4 / 80	18.5	0.39
480019M	19	28	32	66	230	4 / 80	19.5	0.39
480021M	21	30	32	66	240	4 / 80	20.5	0.39
480022M	22	32	32	66	250	4 / 80	21.0	0.39

6 pt.



## SAE Swivel Impact Sockets

Item No.	A inch	D1 mm	D2 mm	Length mm	Weight g	PCS inner/ctn	G.W. KGS	CUFT
480J24	7/16	19	28	66	150	5 / 100	17.0	0.39
480025	1/2	20	28	66	150	5 / 100	17.0	0.39
480026	9/16	22	28	66	160	5 / 100	18.0	0.39
480027	5/8	24	28	66	170	5 / 100	19.0	0.39
480028	11/16	26	32	66	230	4 / 80	20.0	0.39
480029	3/4	28	32	66	240	4 / 80	21.0	0.39
480030	13/16	30	32	66	250	4 / 80	22.0	0.39
480031	7/8	32	32	66	260	4 / 80	22.0	0.39

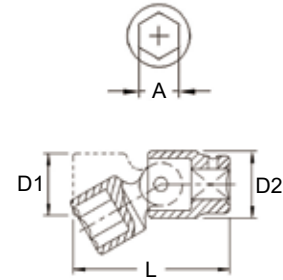

## Metric Semi-Deep Swivel Impact Sockets

Item No.	A mm	D1 mm	D2 mm	Length mm	Weight g	PCS inner/ctn	G.W. KGS	CUFT
487911M	11	18	28	80	180	4 / 80	15.5	0.31
487912M	12	19	28	80	180	4 / 80	15.5	0.31
487913M	13	21	28	80	180	4 / 80	15.5	0.31
487914M	14	22	28	80	190	4 / 80	16.0	0.31
487915M	15	23	28	80	190	4 / 80	16.0	0.31
487916M	16	24	28	80	200	4 / 80	17.0	0.31
487917M	17	26	32	80	270	5 / 50	14.5	0.43
487918M	18	26	32	80	290	5 / 50	15.5	0.43
487919M	19	28	32	80	290	5 / 50	15.5	0.43
487921M	21	30	32	80	300	5 / 50	16.0	0.43
487922M	22	32	32	80	310	5 / 50	16.5	0.43

6 pt.



## SAE Semi-Deep Swivel Impact Sockets

Item No.	A inch	D1 mm	D2 mm	Length mm	Weight g	PCS inner/ctn	G.W. KGS	CUFT
488014	7/16	19	28	80	180	4 / 80	15.5	0.31
488016	1/2	20	28	80	180	4 / 80	15.5	0.31
488018	9/16	22	28	80	190	4 / 80	16.0	0.31
488020	5/8	24	28	80	200	4 / 80	17.0	0.31
488022	11/16	26	32	80	270	5 / 50	14.5	0.31
488024	3/4	28	32	80	290	5 / 50	15.5	0.43
488026	13/16	30	32	80	300	5 / 50	16.0	0.43
488028	7/8	32	32	80	310	5 / 50	16.5	0.43

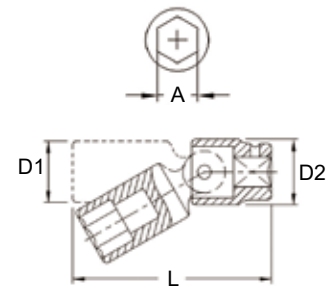

Impact Sockets



# Swivel Impact Sockets

## Metric Deep Swivel Impact Sockets

Item No.	A mm	D1 mm	D2 mm	Length mm	Weight g	PCS	G.W. KGS	CUFT
						inner/ctn		
480011MD	11	18	28	97	250	5 / 50	14.0	0.31
480012MD	12	20	28	97	250	5 / 50	14.0	0.31
480013MD	13	21	28	97	250	5 / 50	14.0	0.31
480014MD	14	22	28	97	250	5 / 50	14.0	0.31
480015MD	15	23	28	97	250	5 / 50	14.0	0.31
480016MD	16	24	28	97	250	5 / 50	14.0	0.31
480017MD	17	26	32	97	300	4 / 40	14.0	0.31
480018MD	18	26	32	97	310	4 / 40	14.0	0.31
480019MD	19	28	32	97	330	4 / 40	15.0	0.31
480021MD	21	30	32	97	340	4 / 40	16.0	0.31
480022MD	22	32	32	97	370	4 / 40	18.0	0.31



## SAE Deep Swivel Impact Sockets

Item No.	A inch	D1 mm	D2 mm	Length mm	Weight g	PCS	G.W. KGS	CUFT
						inner/ctn		
480024D	7/16	18	28	97	250	5 / 50	14.0	0.31
480025D	1/2	20	28	97	250	5 / 50	14.0	0.31
480026D	9/16	23	28	97	250	5 / 50	14.0	0.31
480027D	5/8	24	28	97	250	5 / 50	14.0	0.31
480028D	11/16	26	32	97	300	4 / 40	14.0	0.31
480029D	3/4	28	32	97	330	4 / 40	15.0	0.31
480030D	13/16	30	32	97	340	4 / 40	16.0	0.31
480031D	7/8	32	32	97	370	4 / 40	18.0	0.31

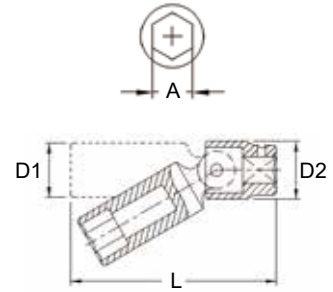

## MS-027S 27 Piece 1/2" Dr. SAE Impact Socket & Accessory Set

Item No.	Size	Item No.	Size
<b>1/2" Dr. 6pt Deep Impact Socket (CR-Mo):</b>			
467830	15/16"	467840	1-1/4"
467832	1"	467842	1-5/16"
467834	1-1/16"	467844	1-3/8"
467836	1-1/8"	467846	1-7/16"
467838	1-3/16"	467848	1-1/2"
<b>1/2" Dr. 6pt Swivel Impact Socket (CR-V):</b>			
488014	7/16"	488022	11/16"
488016	1/2"	488024	3/4"
488018	9/16"	488026	13/16"
488020	5/8"	488028	7/8"
<b>1/2" Dr. Hex Bit Socket:</b>			
418+3336	9/16" Hex	422+3344	11/16" Hex
420+3340	5/8" Hex	424+3348	3/4" Hex
<b>1/2" Dr. Accessory:</b>			
480075MB	Impact Extension Bar, 3"L		
480125MB	Impact Extension Bar, 5"L		
480250MB	Impact Extension Bar, 10"L		
700108	Impact Universal Joint		
420260L	L-Handle		
Plastic Tray			



(285W x 410D x 50H)



8650 g

3 sets / 27 Kgs / 1.35 CUFT

## TG-215M1 7 Piece 1/2" Dr. Metric Swivel Impact Socket Set

Item No.	Size	Item No.	Size
<b>1/2" Dr. 6pt Swivel Impact Socket, 66mmL:</b>			
480013M	13mm	480018M	18mm
480014M	14mm	480019M	19mm
480015M	15mm	480021M	21mm
480017M	17mm	Metal Box	

1650 g 15 sets / 26 Kgs / 0.63 CUFT



6 pt.

## TG-215 7 Piece 1/2" Dr. SAE Swivel Impact Socket Set

Item No.	Size	Item No.	Size
<b>1/2" Dr. 6pt Swivel Impact Socket, 66mmL:</b>			
480025	1/2"	480029	3/4"
480026	9/16"	480030	13/16"
480027	5/8"	480031	7/8"
480028	11/16"	Metal Box	

1650 g 15 sets / 26 Kgs / 0.63 CUFT



6 pt.

## TG-411M 11 Piece 1/2" Dr. Metric Swivel Impact Socket Set

Item No.	Size	Item No.	Size
<b>1/2" Dr. 6pt Swivel Impact Socket, 66mmL:</b>			
480011M	11mm	480017M	17mm
480012M	12mm	480018M	18mm
480013M	13mm	480019M	19mm
480014M	14mm	480021M	21mm
480015M	15mm	480022M	22mm
480016M	16mm	Socket Holder	

2250 g 12 sets / 28 Kgs / 0.73 CUFT



6 pt.

## TG-408S 8 Piece 1/2" Dr. SAE Swivel Impact Socket Set

Item No.	Size	Item No.	Size
<b>1/2" Dr. 6pt Swivel Impact Socket, 66mmL:</b>			
480J24	7/16"	480028	11/16"
480025	1/2"	480029	3/4"
480026	9/16"	480030	13/16"
480027	5/8"	480031	7/8"
Socket Holder			

1700 g 12 sets / 22 Kgs / 0.7 CUFT



6 pt.

## TG-411MA 11 Piece 1/2" Dr. Metric Semi-Deep Swivel Impact Socket Set

Item No.	Size	Item No.	Size
<b>1/2" Dr. 6pt Semi-Deep Swivel Impact Socket, 80mmL:</b>			
487911M	11mm	487917M	17mm
487912M	12mm	487918M	18mm
487913M	13mm	487919M	19mm
487914M	14mm	487921M	21mm
487915M	15mm	487922M	22mm
487916M	16mm	Socket Holder	

2250 g 12 sets / 28 Kgs / 1.24 CUFT



6 pt.



1/2

# Impact Sockets

## TG-408SA 8 Piece 1/2" Dr. SAE Semi-Deep Swivel Impact Socket Set

Item No.	Size	Item No.	Size
<b>1/2" Dr. 6pt Semi-Deep Swivel Impact Socket, 80mmL:</b>			
488014	7/16"	488022	11/16"
488016	1/2"	488024	3/4"
488018	9/16"	488026	13/16"
488020	5/8"	488028	7/8"
Socket Holder			

1700 g

12 sets / 22 Kgs / 0.95 CUFT



6 pt.



## TG-215M1D 7 Piece 1/2" Dr. Metric Deep Swivel Impact Socket Set

Item No.	Size	Item No.	Size
<b>1/2" Dr. 6pt Deep Swivel Impact Socket, 97mmL:</b>			
480013MD	13mm	480018MD	18mm
480014MD	14mm	480019MD	19mm
480015MD	15mm	480021MD	21mm
480017MD	17mm	Metal Box	

2500 g

10 sets / 26 Kgs / 0.48 CUFT



6 pt.

## TG-215-D 7 Piece 1/2" Dr. SAE Deep Swivel Impact Socket Set

Item No.	Size	Item No.	Size
<b>1/2" Dr. 6pt Deep Swivel Impact Socket, 97mmL:</b>			
480025D	1/2"	480029D	3/4"
480026D	9/16"	480030D	13/16"
480027D	5/8"	480031D	7/8"
480028D	11/16"	Metal Box	

2500 g

10 sets / 26 Kgs / 0.48 CUFT



6 pt.

## TG-411MD 11 Piece 1/2" Dr. Metric Deep Swivel Impact Socket Set

Item No.	Size	Item No.	Size
<b>1/2" Dr. 6pt Deep Swivel Impact Socket, 97mmL:</b>			
480011MD	11mm	480017MD	17mm
480012MD	12mm	480018MD	18mm
480013MD	13mm	480019MD	19mm
480014MD	14mm	480021MD	21mm
480015MD	15mm	480022MD	22mm
480016MD	16mm	Socket Holder	

3250 g

8 sets / 27.5 Kgs / 0.73 CUFT



6 pt.

## TG-408SD 8 Piece 1/2" Dr. SAE Deep Swivel Impact Socket Set

Item No.	Size	Item No.	Size
<b>1/2" Dr. 6pt Deep Swivel Impact Socket, 97mmL:</b>			
480024D	7/16"	480028D	11/16"
480025D	1/2"	480029D	3/4"
480026D	9/16"	480030D	13/16"
480027D	5/8"	480031D	7/8"
Socket Holder			

2350 g

8 sets / 20.5 Kgs / 0.7 CUFT



6 pt.

Made of Chrome Vanadium Steel

**ENIUS**  
PROFESSIONAL TOOLS

## Metric Impact Sockets

Item No.	A mm	D1 mm	D2 mm	Length mm	Weight g	PCS inner/ctn	G.W. KGS	CUFT
444008	8	14.7	23.3	38	70	10 / 200	16.0	0.59
444009	9	15.9	23.3	38	70	10 / 200	16.0	0.59
444010	10	17.2	23.3	38	70	10 / 200	16.0	0.59
444011	11	18.4	23.3	38	70	10 / 200	16.0	0.59
444012	12	19.7	23.3	38	70	10 / 200	16.0	0.59
444013	13	20.9	23.3	38	70	10 / 200	16.0	0.59
444014	14	22.2	23.3	38	70	10 / 200	16.0	0.59
444015	15	23.3	23.3	38	70	10 / 200	16.0	0.59
444016	16	23.8	23.8	38	70	10 / 200	16.0	0.59
444017	17	25.8	25.8	38	85	10 / 200	19.0	0.59
444018	18	26.8	26.8	38	90	10 / 200	20.0	0.59
444019	19	27.8	27.8	40	100	10 / 200	22.0	0.59
444020	20	29.8	29.8	40	120	10 / 150	20.0	0.52
444021	21	29.8	29.8	40	120	10 / 150	20.0	0.52
444022	22	31.8	30.0	42	130	10 / 150	21.5	0.52
444023	23	33.8	30.0	42	150	10 / 150	24.5	0.52
444024	24	34.8	30.0	44	160	10 / 150	26.0	0.52
444025	25	35.8	30.0	44	170	10 / 100	19.0	0.62
444026	26	35.8	30.0	44	180	10 / 100	20.0	0.62
444027	27	38.8	30.0	46	190	10 / 100	21.0	0.62
444028	28	39.8	30.0	46	200	10 / 100	22.0	0.62
444029	29	39.8	30.0	46	200	10 / 100	22.0	0.62
444030	30	41.8	31.0	46	210	10 / 100	23.0	0.62
444031	31	43.8	31.0	46	230	10 / 100	25.0	0.62
444032	32	45.5	31.0	46	240	10 / 100	26.0	0.62
444033	33	45.8	35.0	46	270	10 / 100	29.0	0.62
444034	34	47.7	35.0	46	300	5 / 50	16.0	0.41
444035	35	48.0	35.0	48	310	5 / 30	10.5	0.34
444036	36	50.0	35.0	48	330	5 / 30	11.0	0.34
444037	37	50.0	35.0	48	330	5 / 30	11.0	0.34
444038	38	52.7	35.0	48	350	5 / 30	11.5	0.34
444039	39	53.8	35.0	50	360	5 / 30	12.0	0.34
444040	40	55.0	35.0	55	410	5 / 30	13.5	0.34
444041	41	56.5	35.0	55	440	5 / 30	14.5	0.34



## SAE Impact Sockets

Item No.	A inch	D1 mm	D2 mm	Length mm	Weight g	PCS inner/ctn	G.W. KGS	CUFT
464010	5/16	14.7	23.3	38	70	10 / 200	16.0	0.59
464012	3/8	16.5	23.3	38	70	10 / 200	16.0	0.59
464014	7/16	18.4	23.3	38	70	10 / 200	16.0	0.59
464016	1/2	20.4	23.3	38	70	10 / 200	16.0	0.59
464018	9/16	22.4	23.3	38	70	10 / 200	16.0	0.59
464019	19/32	23.3	23.3	38	70	10 / 200	16.0	0.59
464020	5/8	23.8	23.8	38	70	10 / 200	16.0	0.59
464022	11/16	25.8	25.8	38	90	10 / 200	20.0	0.59
464024	3/4	27.8	27.8	40	100	10 / 200	22.0	0.59
464025	25/32	29.8	29.8	40	120	10 / 150	20.0	0.52
464026	13/16	29.8	29.8	40	130	10 / 150	21.5	0.52
464028	7/8	31.8	30.0	42	130	10 / 150	21.5	0.52
464030	15/16	33.8	30.0	44	160	10 / 150	26.0	0.52
464032	1	35.8	30.0	44	180	10 / 100	20.0	0.62
464034	1-1/16	38.8	30.0	46	190	10 / 100	21.0	0.62
464036	1-1/8	39.8	30.0	46	200	10 / 100	22.0	0.62
464038	1-3/16	41.8	30.0	46	210	10 / 100	23.0	0.62
464040	1-1/4	43.8	30.0	46	240	10 / 100	26.0	0.62
464042	1-5/16	46.0	35.0	46	270	5 / 50	15.0	0.41
464044	1-3/8	48.0	35.0	48	310	5 / 30	10.5	0.34
464046	1-7/16	49.0	35.0	48	330	5 / 30	11.0	0.34
464048	1-1/2	52.8	35.0	48	350	5 / 30	11.5	0.34
464050	1-9/16	54.8	35.0	55	410	5 / 30	13.0	0.34
464052	1-5/8	56.8	35.0	55	440	5 / 30	13.5	0.34

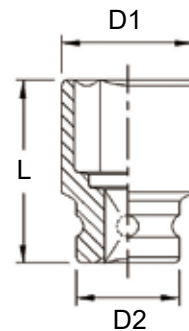
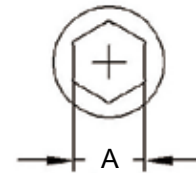

Impact Sockets



# Impact Sockets

## Metric Deep Impact Sockets

\*Thin Wall

Item No.	A mm	D1 mm	D2 mm	Length mm	Weight g	PCS		G.W.		CUFT
						inner/ctn		KGS		
447808	8	14.7	23.8	78	130	10 / 140		21.0		0.44
447809	9	15.9	23.8	78	140	10 / 140		21.0		0.44
447810	10	17.2	23.8	78	140	10 / 140		21.0		0.44
447811	11	18.4	23.8	78	140	10 / 140		21.0		0.44
447812	12	19.7	23.8	78	140	10 / 140		21.0		0.44
447813	13	20.9	23.8	78	150	10 / 140		21.0		0.44
447814	14	22.2	23.8	78	150	10 / 140		22.0		0.44
*447814T	14	20.5	23.8	78	140	10 / 140		21.0		0.44
447815	15	23.8	23.8	78	160	10 / 140		23.5		0.44
447816	16	23.8	23.8	78	170	10 / 140		25.0		0.44
447817	17	25.8	25.8	78	180	10 / 120		24.0		0.52
*447817T	17	23.8	23.8	78	150	10 / 120		19.5		0.52
447818	18	26.8	26.8	78	190	10 / 120		25.0		0.52
447819	19	27.8	27.8	78	230	10 / 120		30.0		0.52
*447819T	19	26.2	26.2	78	170	10 / 120		21.5		0.52
447820	20	29.8	29.8	78	240	10 / 120		30.0		0.52
447821	21	29.8	29.8	78	250	10 / 60		16.0		0.45
*447821T	21	28.5	29.8	78	220	10 / 60		14.5		0.45
447822	22	31.8	30.0	78	260	10 / 60		17.0		0.45
447823	23	33.8	30.0	78	300	10 / 60		19.0		0.45
447824	24	34.8	30.0	78	300	10 / 60		19.0		0.45
447825	25	35.8	30.0	78	300	10 / 60		19.5		0.45
447826	26	35.8	30.0	78	310	10 / 60		20.0		0.45
447827	27	38.8	30.0	78	340	10 / 60		22.0		0.45
447828	28	39.8	30.0	78	350	5 / 50		19.0		0.62
447829	29	39.8	30.0	78	360	5 / 50		19.5		0.62
447830	30	41.8	31.0	78	380	5 / 50		20.0		0.62
447831	31	43.8	31.0	78	440	5 / 50		24.0		0.62
447832	32	44.8	31.0	78	460	5 / 50		24.5		0.62
447833	33	45.8	35.0	78	480	5 / 50		26.0		0.62
447834	34	47.8	35.0	78	510	5 / 50		27.0		0.62
447835	35	47.8	35.0	78	520	5 / 50		28.0		0.62
447836	36	50.0	35.0	78	530	5 / 50		29.0		0.62
447837	37	50.0	35.0	78	530	1 / 30		18.0		0.52
447838	38	52.7	35.0	78	570	1 / 30		19.0		0.52
447839	39	53.8	35.0	78	580	1 / 30		19.0		0.52
447840	40	55.0	35.0	78	590	1 / 30		19.0		0.52
447841	41	56.5	35.0	78	600	1 / 30		19.5		0.52

## SAE Deep Impact Sockets

Item No.	A inch	D1 mm	D2 mm	Length mm	Weight g	PCS		G.W.		CUFT
						inner/ctn		KGS		
467810	5/16	14.7	23.8	78	130	10 / 140		21.0		0.44
467812	3/8	16.5	23.8	78	140	10 / 140		21.0		0.44
467814	7/16	18.4	23.8	78	140	10 / 140		21.0		0.44
467816	1/2	20.4	23.8	78	150	10 / 140		21.0		0.44
467818	9/16	22.4	23.8	78	150	10 / 140		22.0		0.44
467819	19/32	23.8	23.8	78	160	10 / 140		22.5		0.44
467820	5/8	23.8	23.8	78	170	10 / 140		25.0		0.44
467822	11/16	25.8	25.8	78	190	10 / 120		25.0		0.52
467824	3/4	27.8	27.8	78	230	10 / 120		30.0		0.52
467825	25/32	29.8	29.8	78	250	10 / 120		31.0		0.52
467826	13/16	29.8	29.8	78	260	10 / 120		32.0		0.52
467828	7/8	31.8	30.0	78	260	10 / 60		17.0		0.45
467830	15/16	33.8	30.0	78	300	10 / 60		19.5		0.45
467832	1	35.8	30.0	78	300	10 / 60		20.0		0.45
467834	1-1/16	38.8	30.0	78	340	10 / 60		22.0		0.45
467836	1-1/8	39.8	30.0	78	360	5 / 50		19.5		0.62
467838	1-3/16	41.8	30.0	78	380	5 / 50		20.0		0.62
467840	1-1/4	43.8	30.0	78	460	5 / 50		24.0		0.62
467842	1-5/16	45.8	35.0	78	480	5 / 50		25.5		0.62
467844	1-3/8	47.8	35.0	78	510	5 / 50		27.0		0.62
467846	1-7/16	50.0	35.0	78	530	1 / 30		18.0		0.52
467848	1-1/2	52.8	35.0	78	570	1 / 30		19.0		0.52
467850	1-9/16	54.8	35.0	78	590	1 / 30		19.0		0.52
467852	1-5/8	56.8	35.0	78	600	1 / 30		19.5		0.52

6 pt.

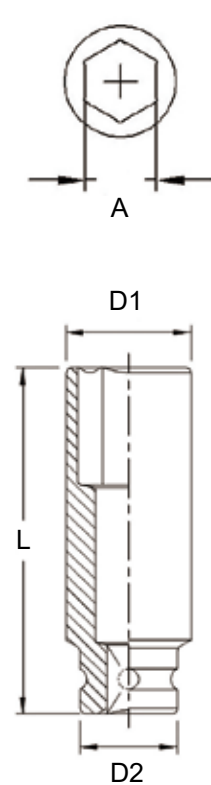

Made of Chrome Molybdenum Steel



## Metric Thin Wall Impact Sockets

Item No.	A mm	D1 mm	D2 mm	Length mm	Weight g	PCS inner/ctn	G.W.		CUFT
							KGS		
443808	8	14.0	23.3	38	50	10 / 200	11.5		0.59
443809	9	15.0	23.3	38	55	10 / 200	12.5		0.59
443810	10	16.0	23.3	38	55	10 / 200	12.5		0.59
443811	11	17.0	23.3	38	55	10 / 200	12.5		0.59
443812	12	19.0	23.3	38	55	10 / 200	12.5		0.59
443813	13	20.0	23.3	38	60	10 / 200	13.5		0.59
443814	14	21.0	23.3	38	60	10 / 200	13.5		0.59
443815	15	22.0	23.3	38	60	10 / 200	13.5		0.59
443816	16	23.0	23.8	38	65	10 / 200	14.5		0.59
443817	17	23.8	23.8	38	65	10 / 200	14.5		0.59
443818	18	25.8	25.8	38	80	10 / 200	17.5		0.59
443819	19	26.8	26.8	40	85	10 / 200	18.5		0.59
443820	20	27.8	27.8	40	90	10 / 150	15.5		0.52
443821	21	29.8	29.8	40	110	10 / 150	17.5		0.52
443822	22	30.8	29.0	42	120	10 / 150	19.0		0.52
443823	23	31.8	30.0	42	130	10 / 150	21.0		0.52
443824	24	32.8	30.0	44	140	10 / 150	23.0		0.52
443825	25	33.8	30.0	44	180	10 / 100	19.0		0.62
443826	26	35.8	30.0	44	190	10 / 100	20.0		0.62
443827	27	36.8	30.0	46	200	10 / 100	21.0		0.62
443828	28	37.8	30.0	46	210	10 / 100	22.0		0.62
443829	29	38.8	30.0	46	210	10 / 100	22.0		0.62
443830	30	40.8	30.0	46	220	10 / 100	23.0		0.62
443831	31	42.8	30.0	46	240	10 / 100	25.0		0.62
443832	32	42.8	30.0	46	250	10 / 100	26.0		0.62
443833	33	43.8	35.0	46	280	10 / 100	29.0		0.62
443834	34	46.0	35.0	46	300	5 / 50	16.0		0.41
443835	35	47.0	35.0	48	310	5 / 30	10.5		0.34
443836	36	48.0	35.0	48	330	5 / 30	11.0		0.34
443837	37	49.0	35.0	48	340	5 / 30	11.0		0.34
443838	38	51.0	35.0	48	350	5 / 30	11.5		0.34
443839	39	52.8	35.0	50	360	5 / 30	12.0		0.34
443840	40	53.8	35.0	55	410	5 / 30	13.5		0.34
443841	41	55.8	35.0	55	450	5 / 30	14.5		0.34

6 pt.



## SAE Thin Wall Impact Sockets

Item No.	A inch	D1 mm	D2 mm	Length mm	Weight g	PCS inner/ctn	G.W.		CUFT
							KGS		
463810	5/16	14.0	23.3	38	55	10 / 200	12.0		0.59
463812	3/8	15.0	23.3	38	55	10 / 200	13.0		0.59
463814	7/16	17.0	23.3	38	60	10 / 200	14.0		0.59
463816	1/2	19.0	23.3	38	60	10 / 200	14.0		0.59
463818	9/16	21.0	23.3	38	60	10 / 200	16.0		0.59
463819	19/32	22.0	23.3	38	60	10 / 200	16.0		0.59
463820	5/8	23.0	23.8	38	65	10 / 200	16.0		0.59
463822	11/16	24.8	24.8	38	65	10 / 200	20.0		0.59
463824	3/4	26.8	26.8	40	85	10 / 200	18.5		0.59
463825	25/32	28.8	28.8	40	120	10 / 150	20.0		0.52
463826	13/16	29.8	29.8	40	130	10 / 150	21.5		0.52
463828	7/8	30.8	29.0	42	130	10 / 150	19.0		0.52
463830	15/16	32.8	30.0	44	160	10 / 150	26.0		0.52
463832	1	34.8	30.0	44	190	10 / 100	20.0		0.62
463834	1-1/16	36.8	30.0	46	200	10 / 100	21.0		0.62
463836	1-1/8	38.8	30.0	46	210	10 / 100	23.0		0.62
463838	1-3/16	40.8	30.0	46	220	10 / 100	23.0		0.62
463840	1-1/4	42.8	30.0	46	250	10 / 100	26.0		0.62
463842	1-5/16	44.0	35.0	46	280	5 / 50	15.0		0.41
463844	1-3/8	47.0	35.0	48	310	5 / 30	10.5		0.34
463846	1-7/16	48.0	35.0	48	330	5 / 30	12.0		0.34
463848	1-1/2	51.0	35.0	48	350	5 / 30	11.5		0.34
463850	1-9/16	53.8	35.0	55	410	5 / 30	13.5		0.34
463852	1-5/8	55.8	35.0	55	440	5 / 30	14.5		0.34

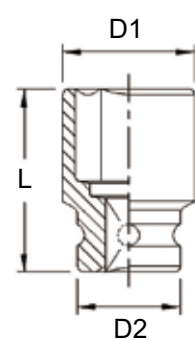
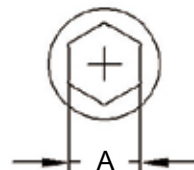

Impact Sockets



# Thin Wall Impact Sockets

## Metric Thin Wall Impact Sockets (12-Point)

Item No.	A mm	D1 mm	D2 mm	Length mm	Weight g	PCS	G.W. KGS	CUFT
						inner/ctn		
453808	8	14.0	23.3	38	50	10 / 200	13.0	0.59
453809	9	15.0	23.3	38	55	10 / 200	13.0	0.59
453810	10	16.0	23.3	38	55	10 / 200	13.0	0.59
453811	11	17.0	23.3	38	55	10 / 200	13.0	0.59
453812	12	19.0	23.3	38	55	10 / 200	13.0	0.59
453813	13	20.0	23.3	38	60	10 / 200	14.0	0.59
453814	14	21.0	23.3	38	60	10 / 200	14.0	0.59
453815	15	22.0	23.3	38	60	10 / 200	14.0	0.59
453816	16	23.0	23.8	38	65	10 / 200	15.0	0.59
453817	17	23.8	23.8	38	65	10 / 200	15.0	0.59
453818	18	25.8	25.8	38	80	10 / 200	18.0	0.59
453819	19	26.8	26.8	40	85	10 / 200	19.0	0.59
453820	20	27.8	27.8	40	95	10 / 150	16.0	0.52
453821	21	29.8	29.8	40	100	10 / 150	17.5	0.52
453822	22	29.8	29.0	42	120	10 / 150	20.5	0.52
453823	23	31.8	30.0	42	130	10 / 150	20.5	0.52
453824	24	32.8	30.0	44	140	10 / 150	22.0	0.52
453825	25	33.8	30.0	44	140	10 / 100	16.0	0.62
453826	26	35.8	30.0	44	150	10 / 100	16.0	0.62
453827	27	36.8	30.0	46	160	10 / 100	18.0	0.62
453828	28	37.8	30.0	46	160	10 / 100	18.0	0.62
453829	29	37.8	30.0	46	170	10 / 100	18.0	0.62
453830	30	40.8	30.0	46	180	10 / 100	20.0	0.62
453831	31	41.8	30.0	46	180	10 / 100	20.0	0.62
453832	32	42.8	30.0	46	190	10 / 100	21.0	0.62
453833	33	43.8	35.0	46	220	10 / 100	24.0	0.62
453834	34	46.0	35.0	46	250	5 / 50	13.5	0.41
453835	35	46.0	35.0	48	260	5 / 30	9.0	0.34
453836	36	48.0	35.0	48	270	5 / 30	9.5	0.34
453837	37	48.0	35.0	48	290	5 / 30	10.0	0.34
453838	38	51.0	35.0	48	300	5 / 30	10.0	0.34
453839	39	52.0	35.0	50	320	5 / 30	11.0	0.34
453840	40	53.0	35.0	55	380	5 / 30	12.5	0.34
453841	41	54.0	35.0	55	380	5 / 30	13.0	0.34



12 pt.

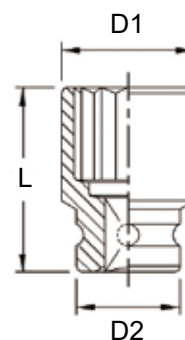

## Metric Semi-Deep Thin Wall Impact Sockets

Item No.	A mm	D1 mm	D2 mm	Length mm	Weight g	PCS	G.W. KGS	CUFT
						inner/ctn		
445210	10	16.0	23.8	52	80	10 / 140	12.0	0.44
445211	11	17.0	23.8	52	80	10 / 140	12.0	0.44
445212	12	19.0	23.8	52	80	10 / 140	13.5	0.44
445213	13	20.0	23.8	52	90	10 / 140	13.5	0.44
445214	14	21.0	23.8	52	90	10 / 140	13.5	0.44
445215	15	22.0	23.8	52	100	10 / 140	15.5	0.44
445216	16	23.0	23.8	52	100	10 / 140	15.5	0.44
445217	17	23.8	23.8	52	100	10 / 140	15.5	0.44
445218	18	25.8	25.8	52	110	10 / 150	18.0	0.69
445219	19	27.8	27.8	52	120	10 / 150	19.5	0.69
445220	20	27.8	27.8	52	140	10 / 120	18.5	0.52
445221	21	29.8	29.8	52	150	10 / 120	19.5	0.52
445222	22	29.8	29.8	52	170	10 / 120	22.5	0.52
445223	23	31.8	31.8	52	190	10 / 120	24.0	0.52
445224	24	33.8	33.8	52	200	10 / 120	25.0	0.52



6 pt.

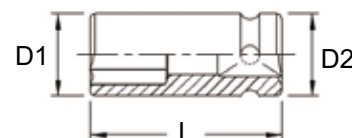
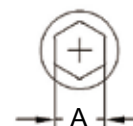

# Thin Wall Impact Sockets

1/2

## Metric Deep Thin Wall Impact Sockets (12-Point)

Item No.	A mm	D1 mm	D2 mm	Length mm	Weight g	PCS inner/ctn	G.W. KGS	CUFT
448508	8	14.0	23.8	85	100	10 / 140	15.0	0.44
448509	9	15.0	23.8	85	100	10 / 140	15.0	0.44
448510	10	16.0	23.8	85	120	10 / 140	18.0	0.44
448511	11	17.0	23.8	85	120	10 / 140	18.0	0.44
448512	12	19.0	23.8	85	130	10 / 140	19.0	0.44
448513	13	20.0	23.8	85	130	10 / 140	19.0	0.44
448514	14	21.0	23.8	85	140	10 / 140	20.5	0.44
448515	15	22.0	23.8	85	150	10 / 140	22.0	0.44
448516	16	23.8	23.8	85	160	10 / 140	23.5	0.44
448517	17	23.8	23.8	85	180	10 / 120	22.5	0.52
448518	18	25.8	25.8	85	190	10 / 120	24.0	0.52
448519	19	27.8	27.8	85	200	10 / 120	25.0	0.52
448520	20	27.8	27.8	85	230	10 / 120	28.5	0.52
448521	21	29.8	29.8	85	240	10 / 60	15.5	0.45
448522	22	29.8	29.8	85	260	10 / 60	16.5	0.45
448523	23	31.8	30.0	85	280	10 / 60	18.0	0.45
448524	24	33.8	30.0	85	300	10 / 60	19.0	0.45
448525	25	34.0	30.0	85	290	10 / 60	18.5	0.45
448526	26	36.0	30.0	85	310	10 / 60	19.5	0.45
448527	27	37.0	30.0	85	340	10 / 60	21.5	0.45
448528	28	38.0	30.0	85	360	6 / 60	22.5	0.62
448529	29	39.0	30.0	85	370	6 / 60	23.0	0.62
448530	30	41.0	30.0	85	390	5 / 50	21.5	0.62
448531	31	42.0	30.0	85	410	5 / 50	21.5	0.62
448532	32	43.0	30.0	85	420	5 / 50	22.0	0.62
448533	33	44.0	35.0	85	450	5 / 50	23.5	0.62
448534	34	46.0	35.0	85	490	5 / 50	24.5	0.62
448535	35	47.0	35.0	85	500	5 / 50	25.5	0.62
448536	36	48.0	35.0	85	550	1 / 30	17.5	0.52
448537	37	49.0	35.0	85	560	1 / 30	18.0	0.52
448538	38	51.0	35.0	85	570	1 / 30	18.0	0.52
448539	39	52.0	35.0	85	580	1 / 30	19.0	0.52
448540	40	53.0	35.0	85	620	1 / 30	19.5	0.52
448541	41	55.0	35.0	85	630	1 / 30	20.5	0.52



12 pt.

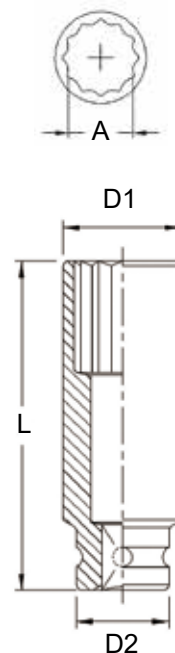

## DI-404M 4 Piece 1/2" Dr. Metric Spindle Nut Impact Socket Set (12-Point)

Item No.	Size	Item No.	Size
<b>1/2" Dr. 12pt Deep Thin Wall Impact Socket:</b>			
448530	30mm	448534	34mm
448532	32mm	448536	36mm

Blow Case

2000 g 12 sets / 25 Kgs / 0.85 CUFT



12 pt.

## DI-408M 8 Piece 1/2" Dr. Metric Spindle Nut Impact Socket Set (12-Point)

Item No.	Size	Item No.	Size
<b>1/2" Dr. 12pt Deep Thin Wall Impact Socket:</b>			
448529	29mm	448535	35mm
448530	30mm	448536	36mm
448532	32mm	448538	38mm
448534	34mm	448539	39mm

Blow Case

4500 g 6 sets / 28 Kgs / 1.39 CUFT



12 pt.

Impact Sockets

1/2

# Impact Sockets

## E-Star Impact Sockets

Item No.	A Size	D1 mm	D2 mm	Length mm	Weight g	PCS inner/ctn	G.W. KGS	CUFT
404508	E-8	12	22	38	55	10 / 200	12.5	0.59
404510	E-10	14	22	38	55	10 / 200	12.5	0.59
404511	E-11	15	22	38	55	10 / 200	12.5	0.59
404512	E-12	16	22	38	60	10 / 200	13.0	0.59
404514	E-14	18	22	38	60	10 / 200	13.0	0.59
404516	E-16	20	22	38	65	10 / 200	14.0	0.59
404518	E-18	22	24	40	85	10 / 200	18.5	0.59
404520	E-20	24	26	40	100	10 / 200	21.5	0.59
404522	E-22	26	26	40	110	10 / 200	22.0	0.59
404524	E-24	28	28	40	130	10 / 150	21.0	0.52
404526	E-26	30	30	44	150	10 / 150	24.0	0.52
404528	E-28	32	30	44	170	10 / 150	27.0	0.52
404530	E-30	34	30	46	190	10 / 100	21.0	0.62
404532	E-32	36	30	46	210	10 / 100	23.0	0.62



## E-Star Deep Impact Sockets

Item No.	A Size	D1 mm	D2 mm	Length mm	Weight g	PCS inner/ctn	G.W. KGS	CUFT
407808	E-8	12	23.5	78	135	10 / 140	20.0	0.44
407810	E-10	14	23.5	78	140	10 / 140	21.0	0.44
407811	E-11	15	23.5	78	145	10 / 140	21.5	0.44
407812	E-12	16	23.5	78	150	10 / 140	22.0	0.44
407814	E-14	18	23.5	78	155	10 / 140	22.5	0.44
407816	E-16	20	23.5	78	160	10 / 140	23.5	0.44
407818	E-18	22	24	78	170	10 / 140	25.0	0.44
407820	E-20	24	26	78	200	10 / 120	25.0	0.52
407822	E-22	26	26	78	200	10 / 120	25.5	0.52
407824	E-24	28	28	78	240	10 / 120	30.0	0.52
407826	E-26	30	30	78	280	10 / 60	18.0	0.45
407828	E-28	32	30	78	300	10 / 60	19.0	0.45
407830	E-30	34	30	78	330	10 / 60	21.0	0.45
407832	E-32	36	30	78	360	10 / 60	23.0	0.45



## Extra-Deep Impact Sockets

Item No.	A size	D1 mm	D2 mm	Length mm	Weight g	PCS inner/ctn	G.W. KGS	CUFT
4412711	11mm	18	24	127	180	5 / 60	12.5	0.30
4412715	15mm	24	24	127	280	10 / 80	24.0	0.44
4612716	1/2"	20	24	127	220	5 / 60	14.0	0.30
4612720	5/8"	24	24	127	260	10 / 80	22.5	0.44
4612722	11/16"	26	26	127	310	10 / 80	27.0	0.44

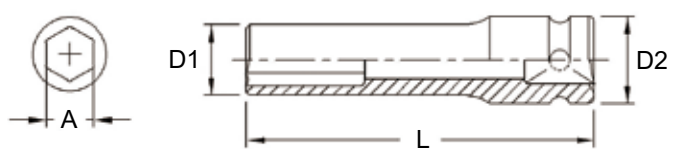

## SAE Extra-Thin Wall Flip Impact Sockets

Item No.	Size Hex	Size Hex	D1 mm	D2 mm	Length mm	Weight g	PCS inner/ctn	G.W. KGS	CUFT
49762426	3/4"	13/16"	18	24	76	165	10 / 120	21.0	0.52

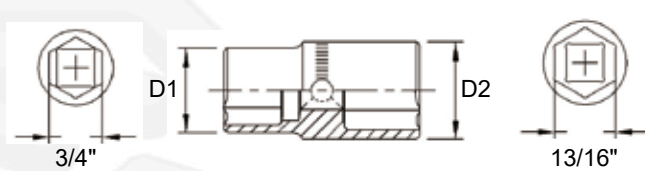

# Impact Socket Sets

1/2

## Impact Adapters

Item No.	Female Drive	Male Drive	Length mm	Weight g	PCS inner/ctn	G.W. KGS	CUFT
480033CM	1/2"	3/8" w/Pin Hole	38	60	10 / 200	14.0	0.59
480033MB	1/2"	3/8" w/Steel Ball	38	60	10 / 200	14.0	0.59
480066CM	1/2"	3/4" w/Pin Hole	41	90	10 / 200	19.5	0.59
480066MB	1/2"	3/4" w/Steel Ball	41	90	10 / 200	19.5	0.59



## Impact Extension Bars

Item No. (Previous No.)	Length mm	Weight g	PCS inner/ctn	G.W. KGS	CUFT
480050CM	50 w/Pin Hole	90	10 / 200	19.0	0.60
480050MB	50 w/Steel Ball	90	10 / 200	19.0	0.60
480075CM (480032CM)	75 w/Pin Hole	130	10 / 140	20.0	0.44
480075MB (480032MB)	75 w/Steel Ball	130	10 / 140	20.0	0.44
480125CM (480036CM)	125 w/Pin Hole	210	5 / 60	14.0	0.30
480125MB (480036MB)	125 w/Steel Ball	210	5 / 60	14.0	0.30
480150CM	150 w/Pin Hole	260	5 / 60	16.5	0.30
480150MB	150 w/Steel Ball	260	5 / 60	16.5	0.30
480200CM	200 w/Pin Hole	345	5 / 60	21.5	0.52
480200MB	200 w/Steel Ball	345	5 / 60	21.5	0.52
480250CM	250 w/Pin Hole	425	5 / 60	26.5	0.52
480250MB	250 w/Steel Ball	425	5 / 60	26.5	0.52
480300CM	300 w/Pin Hole	510	5 / 40	21.5	0.38
480300MB	300 w/Steel Ball	510	5 / 40	21.5	0.38



## Impact Bit Holders

Item No.	Hex Shank	Length mm	Weight g	PCS inner/ctn	G.W. KGS	CUFT
464108	1/4"	41	55	10 / 200	13.0	0.52
464808	1/4"	48	60	10 / 200	13.0	0.52
464110	5/16"	41	60	10 / 200	13.0	0.52
464810	5/16"	48	65	10 / 200	14.0	0.52



## Impact Bit Holders

Item No.	Hex Shank	Length mm	Weight g	PCS inner/ctn	G.W. KGS	CUFT
463608	1/4"	38	80	10 / 200	17.0	0.52
463610	5/16"	38	80	10 / 200	17.0	0.52



## CM-410M 10 Piece 1/2" Dr. Metric Impact Socket Set

Item No.	Size	Item No.	Size
<b>1/2" Dr. 6pt Impact Socket:</b>			
444010	10mm	444017	17mm
444011	11mm	444019	19mm
444012	12mm	444021	21mm
444013	13mm	444022	22mm
444014	14mm	444024	24mm

Socket Holder

1050 g 6x3 18 sets / 20 Kgs / 1.16 CUFT

NEW



6 pt.

## CM-410S 10 Piece 1/2" Dr. SAE Impact Socket Set

Item No.	Size	Item No.	Size
<b>1/2" Dr. 6pt Impact Socket:</b>			
464014	7/16"	464024	3/4"
464016	1/2"	464026	13/16"
464018	9/16"	464028	7/8"
464020	5/8"	464030	15/16"
464022	11/16"	464032	1"

Socket Holder

1160 g 6x3 18 sets / 22 Kgs / 1.16 CUFT

NEW



6 pt.

Impact Sockets







# Impact Socket Sets



## CM-415M 15 Piece 1/2" Dr. Metric Impact Socket Set

Item No.	Size	Item No.	Size
<b>1/2" Dr. 6pt Impact Socket:</b>			
444010	10mm	444018	18mm
444011	11mm	444019	19mm
444012	12mm	444021	21mm
444013	13mm	444022	22mm
444014	14mm	444024	24mm
444015	15mm	444027	27mm
444016	16mm	444030	30mm
444017	17mm	Socket Holder	

1800 g 8x1 8 sets / 15.5 Kgs / 0.7 CUFT

NEW

6 pt.



## CM-415S 15 Piece 1/2" Dr. SAE Impact Socket Set

Item No.	Size	Item No.	Size
<b>1/2" Dr. 6pt Impact Socket:</b>			
464010	5/16"	464026	13/16"
464012	3/8"	464028	7/8"
464014	7/16"	464030	15/16"
464016	1/2"	464032	1"
464018	9/16"	464034	1-1/16"
464020	5/8"	464036	1-1/8"
464022	11/16"	464040	1-1/4"
464024	3/4"	Socket Holder	

1950 g 8x1 8 sets / 16.5 Kgs / 0.7 CUFT

NEW

6 pt.



## TI-414 14 Piece 1/2" Dr. Star Impact Socket Set

Item No.	Size	Item No.	Size
<b>1/2" Dr. E-Star Hand Socket:</b>			
404508	E-8	404520	E-20
404510	E-10	404522	E-22
404511	E-11	404524	E-24
404512	E-12	404526	E-26
404514	E-14	404528	E-28
404516	E-16	404530	E-30
404518	E-18	404532	E-32
Socket Holder			

1500 g 10x1 10 sets / 16 Kgs / 0.6 CUFT

NEW

Star



## CM-417MB 1/2" Dr. 17 Piece Metric Impact Socket Set

Item No.	Size	Item No.	Size
<b>1/2" Dr. 6pt Impact Socket(CRMO):</b>			
444008	8mm	444018	18mm
444010	10mm	444019	19mm
444011	11mm	444021	21mm
444012	12mm	444022	22mm
444013	13mm	444024	24mm
444014	14mm	444027	27mm
444015	15mm	444030	30mm
444016	16mm	444032	32mm
444017	17mm	Blow Case	

2300 g 8 sets / 19.5 Kgs / 0.94 CUFT

SAE size: CM-417SB also available



6 pt.

## CD-410M 10 Piece 1/2" Dr. Metric Deep Impact Socket Set [Previous Item No.: CM-008](#)

Item No.	Size	Item No.	Size
<b>1/2" Dr. 6pt Deep Impact Socket:</b>			
447811	11mm	447817	17mm
447812	12mm	447819	19mm
447813	13mm	447821	21mm
447814	14mm	447822	22mm
447816	16mm	447824	24mm

Metal Box  
 2330 g 10 sets / 24.3 Kgs / 0.52 CUFT



## CD-410S 10 Piece 1/2" Dr. SAE Deep Impact Socket Set [Previous Item No.: CM-007](#)

Item No.	Size	Item No.	Size
<b>1/2" Dr. 6pt Deep Impact Socket:</b>			
467814	7/16"	467824	3/4"
467816	1/2"	467826	13/16"
467818	9/16"	467828	7/8"
467820	5/8"	467830	15/16"
467822	11/16"	467832	1"

Metal Box  
 2530 g 10 sets / 26.3 Kgs / 0.52 CUFT



## DI-424M 24 Piece 1/2" Dr. Metric Deep Impact Socket Set [Previous Item No.: DI-425M](#)

Item No.	Size	Item No.	Size
<b>1/2" Dr. 6pt Deep Impact Socket:</b>			
447808	8mm	447820	20mm
447809	9mm	447821	21mm
447810	10mm	447822	22mm
447811	11mm	447823	23mm
447812	12mm	447824	24mm
447813	13mm	447825	25mm
447814	14mm	447826	26mm
447815	15mm	447827	27mm
447816	16mm	447828	28mm
447817	17mm	447830	30mm
447818	18mm	447832	32mm
447819	19mm	447836	36mm

Blow-mold Tray  
 7000 g 3 sets / 22 Kgs / 0.82 CUFT



(192W x 406D)

## DI-422S 22 Piece 1/2" Dr. SAE Deep Impact Socket Set

Item No.	Size	Item No.	Size
<b>1/2" Dr. 6pt Deep Impact Socket:</b>			
467810	5/16"	467828	7/8"
467812	3/8"	467830	15/16"
467814	7/16"	467832	1"
467816	1/2"	467834	1-1/16"
467818	9/16"	467836	1-1/8"
467819	19/32"	467838	1-3/16"
467820	5/8"	467840	1-1/4"
467822	11/16"	467842	1-5/16"
467824	3/4"	467844	1-3/8"
467825	25/32"	467846	1-7/16"
467826	13/16"	467848	1-1/2"

Plastic Tray  
 6700 g 3 sets / 21 Kgs / 0.82 CUFT



(192W x 406D)

Impact Sockets

1/2

# Impact Socket Sets

## CD-413M 13 Piece 1/2" Dr. Metric Deep Impact Socket Set

Previous Item No.: CD-415M

Item No.	Size	Item No.	Size
<b>1/2" Dr. 6pt Deep Impact Socket:</b>			
447810	10mm	447819	19mm
447811	11mm	447821	21mm
447812	12mm	447822	22mm
447813	13mm	447824	24mm
447814	14mm	447827	27mm
447816	16mm	447830	30mm
447817	17mm	Metal Box	

3630 g 4 sets / 15.5 Kgs / 0.43 CUFT



6 pt.



## CD-413S 13 Piece 1/2" Dr. SAE Deep Impact Socket Set

Previous Item No.: CM-031

Item No.	Size	Item No.	Size
<b>1/2" Dr. 6pt Deep Impact Socket:</b>			
467814	7/16"	467828	7/8"
467816	1/2"	467830	15/16"
467818	9/16"	467832	1"
467820	5/8"	467834	1-1/16"
467822	11/16"	467836	1-1/8"
467824	3/4"	467840	1-1/4"
467826	13/16"	Metal Box	

4120 g 4 sets / 17.5 Kgs / 0.43 CUFT



6 pt.



## IW-415MT 15 Piece 1/2" Dr. Metric Thin Wall Impact Socket Set (12-Point)

Previous Item No.: GS-415M

Item No.	Size	Item No.	Size
<b>1/2" Dr. 12pt Thin Wall Impact Socket:</b>			
453810	10mm	453818	18mm
453811	11mm	453819	19mm
453812	12mm	453820	20mm
453813	13mm	453821	21mm
453814	14mm	453822	22mm
453815	15mm	453823	23mm
453816	16mm	453824	24mm
453817	17mm	Socket Holder	

1500 g 10x1 10 sets / 16 Kgs / 0.6 CUFT



12 pt.

## DI-417MD 17 Piece 1/2" Dr. Metric Deep Thin Wall Impact Socket Set (12-Point)

Item No.	Size	Item No.	Size
<b>1/2" Dr. 12pt Deep Thin Wall Impact Socket:</b>			
448508	8mm	448517	17mm
448509	9mm	448518	18mm
448510	10mm	448519	19mm
448511	11mm	448520	20mm
448512	12mm	448521	21mm
448513	13mm	448522	22mm
448514	14mm	448523	23mm
448515	15mm	448524	24mm
448516	16mm	Plastic Tray	

3340 g 5 sets / 18 Kgs / 0.93 CUFT



(192W x 406D)

12 pt.

1/3

## DI-407M 7 Piece 1/2" Dr. Metric Deep Impact Socket Set

Item No.	Size	Item No.	Size
<b>1/2" Dr. 6pt Deep Impact Socket:</b>			
447830	30mm	447835	35mm
447832	32mm	447836	36mm
447833	33mm	447838	38mm
447834	34mm	Plastic Tray	

3750 g

6 sets / 24 Kgs / 0.94 CUFT



(192W x 203D x 50H)



## DI-407S 7 Piece 1/2" Dr. SAE Deep Impact Socket Set

Item No.	Size	Item No.	Size
<b>1/2" Dr. 6pt Deep Impact Socket:</b>			
467836	1-1/8"	467844	1-3/8"
467838	1-3/16"	467846	1-7/16"
467840	1-1/4"	467848	1-1/2"
467842	1-5/16"	Plastic Tray	

3750 g

6 sets / 24 Kgs / 0.94 CUFT



(192W x 203D x 50H)



## IS-425M 25 Piece 1/2" Dr. Metric Impact Socket Set

Item No.	Size	Item No.	Size
<b>1/2" Dr. 6pt Impact Socket:</b>			
444008	8mm	444021	21mm
444009	9mm	444022	22mm
444010	10mm	444023	23mm
444011	11mm	444024	24mm
444012	12mm	444025	25mm
444013	13mm	444026	26mm
444014	14mm	444027	27mm
444015	15mm	444028	28mm
444016	16mm	444029	29mm
444017	17mm	444030	30mm
444018	18mm	444032	32mm
444019	19mm	444036	36mm
444020	20mm	Plastic Tray	

4000 g

3 sets / 13 Kgs / 0.82 CUFT



(192W x 406D)



## IS-422S 22 Piece 1/2" Dr. SAE Impact Socket Set

Item No.	Size	Item No.	Size
<b>1/2" Dr. 6pt Impact Socket:</b>			
464010	5/16"	464028	7/8"
464012	3/8"	464030	15/16"
464014	7/16"	464032	1"
464016	1/2"	464034	1-1/16"
464018	9/16"	464036	1-1/8"
464019	19/32"	464038	1-3/16"
464020	5/8"	464040	1-1/4"
464022	11/16"	464042	1-5/16"
464024	3/4"	464044	1-3/8"
464025	25/32"	464046	1-7/16"
464026	13/16"	464048	1-1/2"
Plastic Tray			

4330 g

3 sets / 14 Kgs / 0.82 CUFT



(192W x 406D)



Impact Sockets

**1/2**

# Impact Socket Sets



## CD-440M 40 Piece 1/2" Dr. Metric Master Impact Socket Set

Previous Item No.: GS-440M

Item No.	Size	Item No.	Size
<b>1/2" Dr. 6pt Impact Socket:</b>			
444009	9mm	444019	19mm
444010	10mm	444020	20mm
444011	11mm	444021	21mm
444012	12mm	444022	22mm
444013	13mm	444023	23mm
444014	14mm	444024	24mm
444015	15mm	444026	26mm
444016	16mm	444027	27mm
444017	17mm	444030	30mm
444018	18mm		
<b>1/2" Dr. 6pt Deep Impact Socket:</b>			
447809	9mm	447819	19mm
447810	10mm	447820	20mm
447811	11mm	447821	21mm
447812	12mm	447822	22mm
447813	13mm	447823	23mm
447814	14mm	447824	24mm
447815	15mm	447826	26mm
447816	16mm	447827	27mm
447817	17mm	447830	30mm
447818	18mm		

**1/2" Dr. Accessory:**

- 700108 Impact Universal Joint
- 480125MB Impact Extension Bar, 125mmL
- Blow Case

8000 g 3 sets / 25 Kgs / 1.16 CUFT



6 pt.



## CD-434S 34 Piece 1/2" Dr. SAE Master Impact Socket Set

Previous Item No.: GS-434S

Item No.	Size	Item No.	Size
<b>1/2" Dr. 6pt Impact Socket:</b>			
464010	5/16"	464026	13/16"
464012	3/8"	464028	7/8"
464014	7/16"	464030	15/16"
464016	1/2"	464032	1"
464018	9/16"	464034	1-1/16"
464020	5/8"	464036	1-1/8"
464022	11/16"	464038	1-3/16"
464024	3/4"	464040	1-1/4"
<b>1/2" Dr. 6pt Deep Impact Socket:</b>			
467810	5/16"	467826	13/16"
467812	3/8"	467828	7/8"
467814	7/16"	467830	15/16"
467816	1/2"	467832	1"
467818	9/16"	467834	1-1/16"
467820	5/8"	467836	1-1/8"
467822	11/16"	467838	1-3/16"
467824	3/4"	467840	1-1/4"

**1/2" Dr. Accessory:**

- 700108 Impact Universal Joint
- 480125MB Impact Extension Bar, 5"L
- Blow Case

7500 g 3 sets / 23.5 Kgs / 1.16 CUFT



6 pt.



Made of Chrome Molybdenum Steel



## Metric Impact Sockets

Item No.	A mm	D1 mm	D2 mm	Length mm	Weight g	PCS	G.W. KGS	CUFT
						inner/ctn		
645217	17	29.0	38	51	220	5 / 50	12.5	0.34
645218	18	31.0	38	51	230	5 / 50	12.5	0.34
645219	19	32.0	38	51	240	5 / 50	13.0	0.34
645220	20	33.0	38	51	250	5 / 50	13.5	0.34
645221	21	35.0	38	51	250	5 / 50	14.0	0.34
645222	22	36.0	40	51	290	5 / 50	16.0	0.34
645223	23	38.0	40	51	290	5 / 50	16.0	0.34
645224	24	39.0	40	51	300	5 / 50	16.5	0.34
645225	25	40.0	40	54	330	5 / 50	17.5	0.34
645226	26	41.0	41	54	340	5 / 50	18.5	0.34
645227	27	42.0	42	54	350	5 / 50	18.5	0.41
645228	28	44.0	44	54	380	5 / 50	20.5	0.41
645229	29	45.0	44	54	390	5 / 50	21.0	0.41
645230	30	46.0	44	54	400	5 / 50	21.5	0.41
645231	31	48.0	44	54	430	5 / 30	14.0	0.34
645232	32	49.0	44	57	460	5 / 30	15.0	0.34
645233	33	50.0	44	57	460	5 / 30	15.0	0.34
645234	34	51.0	44	57	470	5 / 30	15.5	0.34
645235	35	53.0	44	57	500	5 / 30	16.0	0.34
645236	36	54.0	44	57	510	5 / 30	16.5	0.34
645237	37	55.0	44	57	520	5 / 30	16.5	0.34
645238	38	56.0	44	57	520	5 / 30	16.5	0.34
645239	39	57.0	44	58	570	5 / 30	18.0	0.34
645240	40	59.0	44	58	580	1 / 20	12.5	0.39
645241	41	60.0	44	58	600	1 / 20	13.0	0.39
645242	42	61.0	44	61	630	1 / 20	13.5	0.39
645243	43	62.0	44	61	630	1 / 20	13.5	0.39
645244	44	64.0	44	63	690	1 / 20	15.0	0.39
645245	45	65.0	44	63	690	1 / 20	15.0	0.39
645246	46	66.0	44	63	730	1 / 20	16.0	0.39
645247	47	67.0	44	64	770	1 / 20	16.5	0.39
645248	48	69.0	44	65	790	1 / 20	17.0	0.39
645249	49	70.0	44	65	840	1 / 20	18.0	0.39
645250	50	71.0	44	68	870	1 / 20	19.0	0.39
645251	51	72.0	44	68	870	1 / 10	10.0	0.43
645252	52	74.0	54	70	1080	1 / 10	12.0	0.43
645253	53	75.0	54	70	1100	1 / 10	12.0	0.43
645254	54	76.0	54	73	1200	1 / 10	13.0	0.43
645255	55	78.0	54	73	1240	1 / 10	13.5	0.43
645256	56	79.0	54	73	1240	1 / 10	13.5	0.43
645257	57	80.0	54	73	1290	1 / 10	14.0	0.43
645258	58	81.0	54	73	1330	1 / 10	14.5	0.43
645259	59	83.0	60	73	1400	1 / 10	15.0	0.43
645260	60	84.0	60	80	1580	1 / 10	17.0	0.43
645261	61	85.0	60	80	1580	1 / 10	17.0	0.43
645262	62	86.0	60	80	1600	1 / 10	17.0	0.43
645263	63	88.0	60	80	1680	1 / 10	18.0	0.43
645264	64	89.0	60	80	1720	1 / 6	11.5	0.41
645265	65	90.0	60	85	1820	1 / 6	12.0	0.41
645266	66	90.5	60	85	1830	1 / 6	12.0	0.41
645267	67	92.0	60	85	1840	1 / 6	12.0	0.41
645268	68	94.0	60	85	1840	1 / 6	12.0	0.41
645269	69	94.5	60	85	1960	1 / 6	13.0	0.41
645270	70	96.0	60	90	2140	1 / 6	14.0	0.41
645271	71	97.5	60	90	2170	1 / 6	14.0	0.41
645272	72	99.0	60	90	2200	1 / 6	14.0	0.41
645273	73	99.5	60	90	2230	1 / 6	14.5	0.41
645274	74	101.0	60	90	2250	1 / 6	14.5	0.41
645275	75	102.0	60	90	2270	1 / 6	14.5	0.41
645276	76	103.5	60	90	2340	1 / 6	15.0	0.41

6 pt.

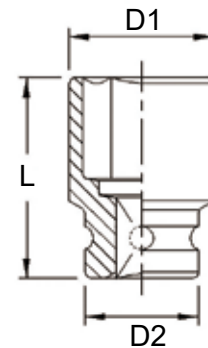
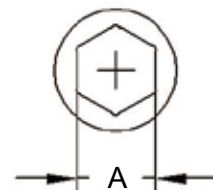

Impact Sockets

3/4

# Impact Sockets

## SAE Impact Sockets

Item No.	A	D1	D2	Length mm	Weight g	PCS inner/ctn	G.W. KGS	CUFT
	inch	mm	mm					
665222	11/16	30	38	51	230	5 / 50	13.0	0.34
665224	3/4	32	38	51	240	5 / 50	13.0	0.34
665225	25/32	33	38	51	250	5 / 50	13.5	0.34
665226	13/16	35	38	51	250	5 / 50	14.0	0.34
665228	7/8	36	40	51	290	5 / 50	16.0	0.34
665230	15/16	39	40	51	300	5 / 50	16.5	0.34
665232	1	40	40	54	330	5 / 50	17.5	0.34
665234	1-1/16	42	42	54	350	5 / 50	18.5	0.41
665236	1-1/8	45	44	54	390	5 / 50	21.0	0.41
665238	1-3/16	46	44	54	400	5 / 50	21.5	0.41
665240	1-1/4	49	44	57	460	5 / 30	15.0	0.34
665242	1-5/16	50	44	57	460	5 / 30	15.0	0.34
665244	1-3/8	53	44	57	500	5 / 30	16.0	0.34
665246	1-7/16	54	44	57	510	5 / 30	16.5	0.34
665248	1-1/2	56	44	57	520	5 / 30	16.5	0.34
665250	1-9/16	59	44	58	580	1 / 20	12.5	0.39
665252	1-5/8	60	44	58	600	1 / 20	13.0	0.39
665254	1-11/16	63	44	61	630	1 / 20	13.5	0.39
665256	1-3/4	65	44	63	730	1 / 20	16.0	0.39
665258	1-13/16	66	44	63	730	1 / 20	16.0	0.39
665260	1-7/8	69	44	65	800	1 / 20	17.0	0.39
665262	1-15/16	70	44	65	840	1 / 20	18.0	0.39
665264	2	72	44	68	840	1 / 20	18.0	0.39
665266	2-1/16	74	54	70	1080	1 / 10	12.0	0.43
665268	2-1/8	76	54	73	1200	1 / 10	13.0	0.43
665270	2-3/16	78	54	73	1240	1 / 10	13.5	0.43
665272	2-1/4	80	54	73	1290	1 / 10	14.0	0.43
665274	2-5/16	83	60	73	1400	1 / 10	15.0	0.43
665276	2-3/8	84	60	80	1580	1 / 10	17.0	0.43
665278	2-7/16	86	60	80	1600	1 / 10	17.0	0.43
665280	2-1/2	88	60	80	1680	1 / 10	18.0	0.43
665282	2-9/16	90	60	85	1820	1 / 6	12.0	0.41
665284	2-5/8	92	60	85	1840	1 / 6	12.0	0.41
665286	2-11/16	94	60	85	1840	1 / 6	12.0	0.41
665288	2-3/4	96	60	90	2140	1 / 6	14.0	0.41
665290	2-13/16	98	60	90	2170	1 / 6	14.0	0.41
665292	2-7/8	99	60	90	2230	1 / 6	14.5	0.41
665294	2-15/16	102	60	90	2270	1 / 6	14.5	0.41
665296	3	103.5	60	90	2340	1 / 6	15.0	0.41

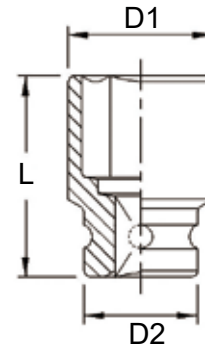
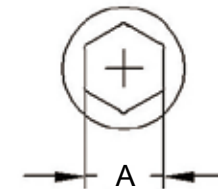

6 pt.

## Metric Budd Wheel Sockets

ITEM NO.	A	D1	D2	Length mm	Weight g	PCS inner/ctn	G.W. KGS	CUFT
	Square	mm	mm					
649517S	17mm	34	40	90	520	1 / 30	17.0	0.52
649519S	19mm	38	40	90	570	1 / 30	18.5	0.52
649520S	20mm	40	40	90	600	1 / 30	19.5	0.52
649521S	21mm	40	40	90	610	1 / 30	20.0	0.52

## SAE Budd Wheel Sockets

ITEM NO.	A	D1	D2	Length mm	Weight g	PCS inner/ctn	G.W. KGS	CUFT
	Square	mm	mm					
669522S	11/16"	34	40	90	560	1 / 30	17.0	0.52
669524S	3/4"	38	40	90	570	1 / 30	18.5	0.52
669526S	13/16"	40	40	90	580	1 / 30	20.0	0.52

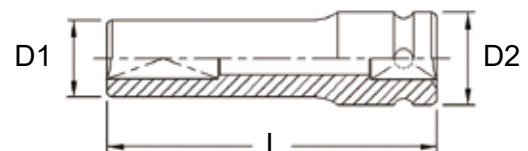
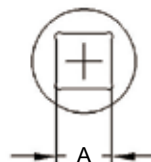

Made of Chrome Molybdenum Steel

**ENIUS**  
PROFESSIONAL TOOLS

## Metric Deep Impact Sockets

Item No.	A mm	D1 mm	D2 mm	Length mm	Weight g	PCS	G.W. KGS	CUFT
						inner/ctn		
649517	17	29.0	38	90	390	1 / 30	13.0	0.52
649518	18	31.0	38	90	400	1 / 30	13.0	0.52
649519	19	32.0	38	90	420	1 / 30	14.0	0.52
649520	20	33.0	38	90	430	1 / 30	14.0	0.52
649521	21	35.0	38	90	450	1 / 30	14.5	0.52
649522	22	36.0	40	90	490	1 / 30	16.0	0.52
649523	23	38.0	40	90	520	1 / 30	16.5	0.52
649524	24	39.0	40	90	530	1 / 30	17.0	0.52
649525	25	40.0	40	90	540	1 / 30	17.5	0.52
649526	26	41.0	41	90	560	1 / 30	18.0	0.52
649527	27	42.0	42	90	580	1 / 30	18.5	0.52
649528	28	44.0	44	90	630	1 / 30	20.0	0.52
649529	29	45.0	44	90	630	1 / 30	20.0	0.52
649530	30	46.0	44	90	680	1 / 30	21.5	0.52
649531	31	46.0	44	90	680	1 / 30	21.5	0.52
649532	32	49.0	44	90	740	1 / 30	23.5	0.52
649533	33	50.0	44	90	760	1 / 30	24.0	0.52
649534	34	51.0	44	90	790	1 / 30	25.0	0.52
649535	35	53.0	44	90	800	1 / 30	25.5	0.52
649536	36	54.0	44	90	840	1 / 30	26.5	0.52
649537	37	55.0	44	90	840	1 / 30	26.5	0.52
649538	38	56.0	44	90	880	1 / 30	28.0	0.52
649539	39	57.0	44	90	880	1 / 10	10.0	0.31
649540	40	59.0	44	90	940	1 / 10	10.5	0.31
649541	41	60.0	44	90	970	1 / 10	11.0	0.31
649542	42	61.0	44	90	990	1 / 10	11.0	0.31
649543	43	62.0	44	90	1000	1 / 10	11.0	0.31
649544	44	64.0	44	90	1170	1 / 10	13.0	0.31
649545	45	65.0	44	95	1180	1 / 10	13.0	0.31
649546	46	66.0	44	95	1180	1 / 10	13.0	0.31
649547	47	67.0	44	95	1190	1 / 10	13.0	0.31
649548	48	69.0	44	100	1250	1 / 10	13.5	0.31
649549	49	70.0	44	100	1350	1 / 10	14.5	0.31
649550	50	71.0	44	100	1400	1 / 10	15.0	0.31
649551	51	72.0	44	100	1400	1 / 10	15.0	0.31
649552	52	73.0	44	100	1580	1 / 6	10.5	0.41
649553	53	74.5	54	100	1600	1 / 6	10.5	0.41
649554	54	76.0	54	100	1660	1 / 6	11.0	0.41
649555	55	78.0	54	100	1720	1 / 6	11.5	0.41
649556	56	79.0	54	100	1720	1 / 6	11.5	0.41
649557	57	80.0	54	100	1730	1 / 6	11.5	0.41
649558	58	81.0	54	100	1740	1 / 6	11.5	0.41
649559	59	83.0	60	100	1750	1 / 6	11.5	0.41
649560	60	84.0	60	105	2070	1 / 6	13.5	0.41
649561	61	85.0	60	105	2070	1 / 6	13.5	0.41
649562	62	85.5	60	105	2070	1 / 6	13.5	0.41
649563	63	88.0	60	105	2150	1 / 6	14.0	0.41
649564	64	89.0	60	105	2200	1 / 6	14.0	0.41
649565	65	90.0	60	105	2240	1 / 6	14.5	0.41
649566	66	91.0	60	105	2240	1 / 6	14.5	0.41
649567	67	92.0	60	105	2350	1 / 6	15.0	0.41
649568	68	94.0	60	105	2380	1 / 6	15.5	0.41
649569	69	94.5	60	105	2380	1 / 6	15.5	0.41
649570	70	96.0	60	110	2400	1 / 6	15.5	0.41
649571	71	97.5	60	110	2500	1 / 3	9.0	0.31
649572	72	98.0	60	110	2550	1 / 3	9.0	0.31
649573	73	99.0	60	110	2600	1 / 3	9.0	0.31
649574	74	101.0	60	110	2650	1 / 3	9.0	0.31
649575	75	102.0	60	110	2700	1 / 3	9.0	0.31
649576	76	104.0	60	110	2890	1 / 3	10.0	0.31

6 pt.

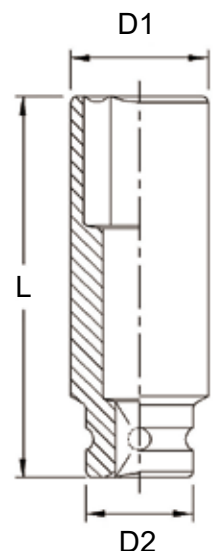
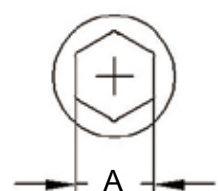

Impact Sockets



3/4

# Impact Sockets

## SAE Deep Impact Sockets

Item No.	A inch	D1 mm	D2 mm	Length mm	Weight g	PCS inner/ctn	G.W. KGS	CUFT
669522	11/16	30	38	90	400	1 / 30	13.0	0.52
669524	3/4	32	38	90	420	1 / 30	14.0	0.52
669525	25/32	33	38	90	430	1 / 30	14.0	0.52
669526	13/16	35	38	90	450	1 / 30	14.5	0.52
669528	7/8	36	40	90	490	1 / 30	16.0	0.52
669530	15/16	39	40	90	530	1 / 30	17.0	0.52
669532	1	40	40	90	550	1 / 30	17.5	0.52
669534	1-1/16	42	42	90	580	1 / 30	18.5	0.52
669536	1-1/8	45	44	90	630	1 / 30	20.0	0.52
669538	1-3/16	46	44	90	680	1 / 30	21.5	0.52
669540	1-1/4	49	44	90	740	1 / 30	23.5	0.52
669542	1-5/16	50	44	90	760	1 / 30	24.0	0.52
669544	1-3/8	53	44	90	800	1 / 30	25.5	0.52
669546	1-7/16	54	44	90	840	1 / 30	26.5	0.52
669548	1-1/2	56	44	90	880	1 / 10	10.0	0.31
669550	1-9/16	59	44	90	940	1 / 10	10.5	0.31
669552	1-5/8	60	44	90	970	1 / 10	11.0	0.31
669554	1-11/16	63	44	90	1000	1 / 10	11.0	0.31
669556	1-3/4	65	44	95	1180	1 / 10	13.0	0.31
669558	1-13/16	66	44	95	1180	1 / 10	13.0	0.31
669560	1-7/8	69	44	100	1250	1 / 10	13.5	0.31
669562	1-15/16	70	44	100	1350	1 / 10	14.5	0.31
669564	2	72	44	100	1400	1 / 10	15.0	0.31
669566	2-1/16	73	44	100	1580	1 / 6	10.5	0.41
669568	2-1/8	76	54	100	1660	1 / 6	11.0	0.41
669570	2-3/16	78	54	100	1720	1 / 6	11.5	0.41
669572	2-1/4	80	54	100	1730	1 / 6	11.5	0.41
669574	2-5/16	83	60	100	1750	1 / 6	11.5	0.41
669576	2-3/8	84	60	105	2070	1 / 6	13.5	0.41
669578	2-7/16	86	60	105	2070	1 / 6	13.5	0.41
669580	2-1/2	88	60	105	2150	1 / 6	14.0	0.41
669582	2-9/16	90	60	105	2240	1 / 6	14.5	0.41
669584	2-5/8	92	60	105	2350	1 / 6	15.0	0.41
669586	2-11/16	94	60	105	2380	1 / 6	15.5	0.41
669588	2-3/4	96	60	110	2400	1 / 6	15.5	0.41
669590	2-13/16	97.5	60	110	2500	1 / 3	9.0	0.31
669592	2-7/8	99	60	110	2600	1 / 3	9.0	0.31
669594	2-15/16	102	60	110	2700	1 / 3	9.0	0.31
669596	3	104	60	110	2890	1 / 3	10.0	0.31



6 pt.

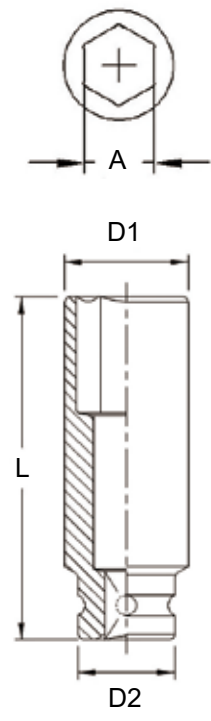

## SAE Deep Thin Wall Impact Sockets

Item No.	A inch	D1 mm	D2 mm	Length mm	Weight g	PCS inner/ctn	G.W. KGS	CUFT
669534T	1-1/16	40	42	90	500	1 / 30	16.5	0.52
669536T	1-1/8	42	44	90	550	1 / 30	17.5	0.52
669540T	1-1/4	46	44	90	630	1 / 30	19.5	0.52

6 pt.

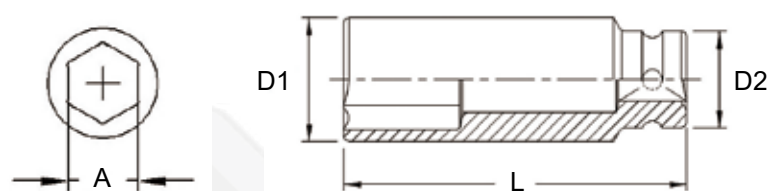

## Metric Thin Wall Impact Sockets (12-Point)

Item No.	A mm	D1 mm	D2 mm	Length mm	Weight g	PCS	G.W. KGS	CUFT
						inner/ctn		
655217	17	27.0	38	51	210	5 / 50	11.5	0.34
655218	18	28.0	38	51	220	5 / 50	12.0	0.34
655219	19	29.5	38	51	220	5 / 50	12.0	0.34
655220	20	30.7	38	51	230	5 / 50	12.5	0.34
655221	21	32.0	38	51	230	5 / 50	12.5	0.34
655222	22	33.0	40	51	260	5 / 50	14.0	0.34
655223	23	34.5	40	51	260	5 / 50	14.0	0.34
655224	24	35.7	40	51	270	5 / 50	14.5	0.34
655225	25	37.0	40	51	290	5 / 50	15.5	0.34
655226	26	38.0	40	54	300	5 / 50	16.5	0.34
655227	27	39.5	42	54	310	5 / 50	16.5	0.41
655228	28	42.0	38	54	310	5 / 50	16.5	0.41
655229	29	42.0	39	54	310	5 / 50	16.5	0.41
655230	30	43.0	40	54	330	5 / 50	17.5	0.41
655231	31	44.0	41	54	330	5 / 30	11.0	0.34
655232	32	46.0	42	57	380	5 / 30	12.5	0.34
655233	33	46.0	43	57	380	5 / 30	12.5	0.34
655234	34	48.0	43	57	400	5 / 30	13.0	0.34
655235	35	49.5	44	57	410	5 / 30	13.5	0.34
655236	36	50.7	44	57	420	5 / 30	14.0	0.34
655237	37	51.0	44	57	440	5 / 30	14.5	0.34
655238	38	53.0	44	57	450	5 / 30	14.5	0.34
655239	39	54.5	44	58	480	5 / 30	15.5	0.34
655240	40	55.7	44	58	500	1 / 20	11.0	0.39
655241	41	57.0	44	58	510	1 / 20	11.5	0.39
655242	42	58.0	44	61	520	1 / 20	11.5	0.39
655243	43	59.5	44	61	560	1 / 20	12.5	0.39
655244	44	60.7	44	63	580	1 / 20	13.0	0.39
655245	45	61.0	44	63	600	1 / 20	13.0	0.39
655246	46	63.0	44	63	640	1 / 20	14.0	0.39
655247	47	63.5	44	63	650	1 / 20	14.0	0.39
655248	48	65.7	44	65	680	1 / 20	14.5	0.39
655249	49	67.0	44	65	690	1 / 20	14.5	0.39
655250	50	68.0	44	68	750	1 / 20	16.0	0.39
655251	51	69.0	44	68	770	1 / 20	16.5	0.39
655252	52	70.7	54	70	930	1 / 20	19.5	0.39
655253	53	72.0	54	70	1000	1 / 10	11.0	0.43
655254	54	73.0	54	73	1040	1 / 10	11.5	0.43
655255	55	74.5	54	73	1050	1 / 10	11.5	0.43
655256	56	75.7	54	73	1070	1 / 10	12.0	0.43
655257	57	77.0	54	73	1100	1 / 10	12.0	0.43
655258	58	78.0	54	73	1170	1 / 10	13.0	0.43
655259	59	79.0	60	73	1240	1 / 10	13.5	0.43
655260	60	80.7	60	80	1350	1 / 10	14.5	0.43
655263	63	84.0	60	80	1430	1 / 10	15.5	0.43
655265	65	87.0	60	85	1560	1 / 6	10.5	0.41
655270	70	93.0	60	90	1790	1 / 6	12.0	0.41

12 pt.

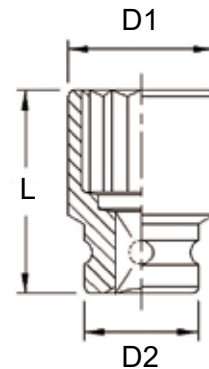

## Impact Adapters

Item No.	Female Drive	Male Drive	Length mm	Weight g	PCS	G.W. KGS	CUFT
					inner/ctn		
640604	3/4"	1/2" w/Pin Hole	63	260	5 / 50	14.0	0.34
640604B	3/4"	1/2" w/Steel Ball	63	260	5 / 50	14.0	0.34
640608	3/4"	1" w/Pin Hole	65	370	1 / 30	13.0	0.38
640608B	3/4"	1" w/Steel Ball	65	370	1 / 30	13.0	0.38



Impact Sockets



# Impact Sockets

## SAE Thin Wall Impact Sockets (12-Point)

Item No.	A	D1	D2	Length mm	Weight g	PCS inner/ctn	G.W. KGS	CUFT
	inch	mm	mm					
695222	11/16	27.6	38	51	210	5 / 50	11.5	0.34
695224	3/4	29.6	38	51	220	5 / 50	12.0	0.34
695225	25/32	30.5	38	51	230	5 / 50	12.5	0.34
695226	13/16	31.5	38	51	230	5 / 50	12.5	0.34
695228	7/8	33.0	40	51	260	5 / 50	14.0	0.34
695230	15/16	35.5	40	51	270	5 / 50	14.5	0.34
695232	1	37.5	40	54	300	5 / 50	16.0	0.34
695234	1-1/16	39.5	42	54	310	5 / 50	16.5	0.41
695236	1-1/8	42.0	42	54	310	5 / 50	16.5	0.41
695238	1-3/16	43.0	43	54	330	5 / 50	17.5	0.41
695240	1-1/4	46.0	44	57	380	5 / 30	12.5	0.34
695242	1-5/16	46.0	44	57	380	5 / 30	12.5	0.34
695244	1-3/8	50.0	44	57	410	5 / 30	13.5	0.34
695246	1-7/16	51.0	44	57	440	5 / 30	14.5	0.34
695248	1-1/2	53.0	44	57	450	5 / 30	14.5	0.34
695250	1-9/16	55.4	44	58	500	1 / 20	11.0	0.39
695252	1-5/8	57.0	44	58	510	1 / 20	11.5	0.39
695254	1-11/16	59.3	44	61	560	1 / 20	12.5	0.39
695256	1-3/4	61.0	44	63	600	1 / 20	13.0	0.39
695258	1-13/16	63.0	44	63	640	1 / 20	14.0	0.39
695260	1-7/8	65.3	44	65	680	1 / 20	14.5	0.39
695262	1-15/16	67.0	44	65	690	1 / 20	14.5	0.39
695264	2	69.0	44	68	770	1 / 20	16.5	0.39
695266	2-1/16	71.0	54	70	930	1 / 20	19.5	0.39
695268	2-1/8	73.0	54	73	1040	1 / 10	11.5	0.43
695270	2-3/16	75.0	54	73	1050	1 / 10	11.5	0.43
695272	2-1/4	77.0	54	73	1100	1 / 10	12.0	0.43
695274	2-5/16	79.0	60	73	1240	1 / 10	13.5	0.43
695276	2-3/8	81.0	60	80	1350	1 / 10	14.5	0.43
695280	2-1/2	84.0	60	80	1430	1 / 10	15.5	0.43
695284	2-5/8	89.0	60	85	1500	1 / 6	10.0	0.41
695288	2-3/4	93.0	60	90	1790	1 / 6	12.0	0.41

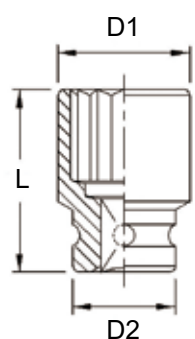
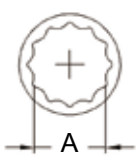

## Impact Universal Joints

Item No.	Type	Outside Diameter	Length mm	Weight g	PCS inner/ctn	G.W. KGS	CUFT
640606B	w/Steel Ball	44mm	110	680	1 / 12	9.0	0.30



## Impact Extension Bars

Item No.	Length mm	Weight g	PCS inner/ctn	G.W. KGS	CUFT
640100B	100 w/Steel Ball	455	1 / 30	15.0	0.52
640150	150 w/Pin Hole	645	1 / 20	14.0	0.52
640150B	150 w/Steel Ball	645	1 / 20	14.0	0.52
640200	200 w/Pin Hole	825	1 / 20	17.5	0.62
640200B	200 w/Steel Ball	825	1 / 20	17.5	0.62
640250	250 w/Pin Hole	1030	2 / 20	22.0	0.62
640250B	250 w/Steel Ball	1030	2 / 20	22.0	0.62
640400	400 w/Pin Hole	1600	1 / 15	25.0	0.43
640400B	400 w/Steel Ball	1600	1 / 15	25.0	0.43



# Impact Socket Sets

3/4

## E-Star Impact Sockets

Item No.	A Size	D1 mm	D2 mm	Length mm	Weight g	PCS inner/ctn	G.W. KGS	CUFT
605018	E-18	26	44	50	300	5 / 50	16.0	0.41
605020	E-20	28	44	50	310	5 / 50	16.5	0.41
605022	E-22	30	44	50	315	5 / 50	16.8	0.41
605024	E-24	32	44	50	325	5 / 50	17.3	0.41
605026	E-26	34	44	55	355	5 / 50	18.8	0.41
605028	E-28	36	44	60	400	5 / 50	21.0	0.41
605030	E-30	38	44	60	410	5 / 50	21.5	0.41
605032	E-32	40	44	60	435	5 / 50	22.8	0.41



## CM-608M 8 Piece 3/4" Dr. Metric Impact Socket Set

Previous Item No.: CM-022

Item No.	Size	Item No.	Size
<b>3/4" Dr. 6pt Impact Socket:</b>			
645226	26mm	645232	32mm
645227	27mm	645235	35mm
645229	29mm	645236	36mm
645230	30mm	645238	38mm

Metal Box

4150 g 6 sets / 26 Kgs / 0.62 CUFT



6 pt.

## CM-608S 8 Piece 3/4" Dr. SAE Impact Socket Set

Previous Item No.: CM-021

Item No.	Size	Item No.	Size
<b>3/4" Dr. 6pt Impact Socket:</b>			
665232	1"	665242	1-5/16"
665234	1-1/16"	665244	1-3/8"
665236	1-1/8"	665246	1-7/16"
665240	1-1/4"	665248	1-1/2"

Metal Box

4150 g 6 sets / 26 Kgs / 0.62 CUFT



6 pt.

## IS-609E 9 Piece 3/4" Dr. Metric Impact Socket Set

Item No.	Size	Item No.	Size
<b>3/4" Dr. 6pt Impact Socket:</b>			
645219	19mm	645232	32mm
645222	22mm	645233	33mm
645224	24mm	645234	34mm
645227	27mm	645236	36mm
645230	30mm	Blow Case	

4000 g 4 sets / 17 Kgs / 0.85 CUFT



6 pt.

## IS-609M 9 Piece 3/4" Dr. Metric Impact Socket Set

Item No.	Size	Item No.	Size
<b>3/4" Dr. 6pt Impact Socket:</b>			
645226	26mm	645233	33mm
645227	27mm	645235	35mm
645229	29mm	645236	36mm
645230	30mm	645238	38mm
645232	32mm	Blow Case	

4450 g 4 sets / 19 Kgs / 0.85 CUFT



6 pt.

Impact Sockets

3/4

# Impact Socket Sets

## E-Star Deep Impact Sockets

Item No.	A Size	D1 mm	D2 mm	Length mm	Weight g	PCS inner/ctn	G.W. KGS	CUFT
609018	E-18	26	44	110	625	1 / 20	13.5	0.52
609020	E-20	28	44	110	660	1 / 20	14.2	0.52
609022	E-22	30	44	110	670	1 / 20	14.5	0.52
609024	E-24	32	44	110	710	1 / 20	15.2	0.52
609026	E-26	34	44	110	760	1 / 20	16.2	0.52
609028	E-28	36	44	110	785	1 / 20	16.7	0.52
609030	E-30	38	44	110	800	1 / 20	17.0	0.52
609032	E-32	40	44	110	850	1 / 20	18.0	0.52

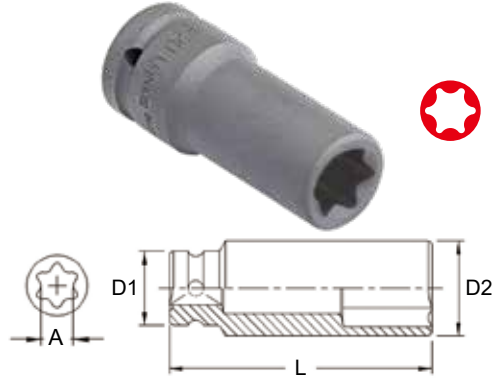

## IS-609DE 9 Piece 3/4" Dr. Metric Deep Impact Socket Set

Item No.	Size	Item No.	Size
<b>3/4" Dr. 6pt Deep Impact Socket:</b>			
649519	19mm	649532	32mm
649522	22mm	649533	33mm
649524	24mm	649534	34mm
649527	27mm	649536	36mm
649530	30mm	Blow Case	

6600 g 3 sets / 21 Kgs / 1.12 CUFT



## IS-609MD 9 Piece 3/4" Dr. Metric Deep Impact Socket Set

Item No.	Size	Item No.	Size
<b>3/4" Dr. 6pt Deep Impact Socket:</b>			
649526	26mm	649533	33mm
649527	27mm	649535	35mm
649529	29mm	649536	36mm
649530	30mm	649538	38mm
649532	32mm	Blow Case	

7200 g 3 sets / 22.5 Kgs / 1.12 CUFT



## TR-611MS 11 Piece 3/4" Dr. Metric & SAE Truck Wheel Impact Socket Set

Item No.	Size	Item No.	Size
<b>3/4" Dr. 6pt Deep Impact Socket:</b>			
649533	33mm	649538	38mm
649535	35mm	649541	41mm
<b>3/4" Dr. 6pt Deep Thin Wall Impact Socket:</b>			
669534T	1-1/16"	669540T	1-1/4"
669536T	1-1/8"		
<b>3/4" Dr. Budd Wheel Impact Socket:</b>			
649517S	17mm	669526S	13/16"
649521S	21mm		
<b>3/4" Dr. Deep Budd Wheel Impact Socket:</b>			
669548B	1-1/2"	Blow Case	

8540 g 2 sets / 18 Kgs / 0.95 CUFT



- These 1" & 3/4" Dr. impact socket sets designed for servicing truck wheels.
- The most popular SAE and Metric impact socket sizes for truck wheel fasteners.
- 4-Point impact sockets for inner Budd-style square fasteners on truck wheels.
- Special 1-1/2" Hex deep impact socket designed for outer cap nuts on Budd-style truck wheels.
- Deep Thin Wall impact sockets designed for truck wheel servicing when removing Dayton Style Lug Nuts that are deeply recessed and where space is very limited.
- Metric impact socket set for servicing tires and wheels on a complete range of European and Japanese trucks with metric wheel fasteners.

Made of Chrome Molybdenum Steel

**ENIUS**  
PROFESSIONAL TOOLS

## CD-608M4 8 Piece 3/4" Dr. Metric Budd Wheel Impact Socket Set [Previous Item No.: CM-608M4](#)

Item No.	Size	Item No.	Size
<b>3/4" Dr. 6pt Deep Impact Socket:</b>			
649527	27mm	649535	35mm
649530	30mm	649538	38mm
649532	32mm	649541	41mm
<b>3/4" Dr. Budd Wheel Impact Socket:</b>			
649519S	19mm	649521S	21mm
Metal Box			

6500 g 4 sets / 27 Kgs / 0.62 CUFT

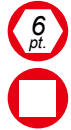

## CD-608S4 8 Piece 3/4" Dr. SAE Budd Wheel Impact Socket Set [Previous Item No.: CM-608S4](#)

Item No.	Size	Item No.	Size
<b>3/4" Dr. 6pt Deep Impact Socket:</b>			
669534	1-1/16"	669540	1-1/4"
669536	1-1/8"	669544	1-3/8"
669538	1-3/16"	669548	1-1/2"
<b>3/4" Dr. Budd Wheel Impact Socket:</b>			
669524S	3/4"	669526S	13/16"
Metal Box			

6500 g 4 sets / 27 Kgs / 0.62 CUFT

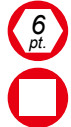

## CD-608M 8 Piece 3/4" Dr. Metric Deep Impact Socket Set [Previous Item No.: CM-023M2](#)

Item No.	Size	Item No.	Size
<b>3/4" Dr. 6pt Deep Impact Socket:</b>			
649526	26mm	649532	32mm
649527	27mm	649535	35mm
649529	29mm	649536	36mm
649530	30mm	649538	38mm
Metal Box			

6750 g 4 sets / 28 Kgs / 0.62 CUFT



## CD-608S 8 Piece 3/4" Dr. SAE Deep Impact Socket Set [Previous Item No.: CM-023-1](#)

Item No.	Size	Item No.	Size
<b>3/4" Dr. 6pt Deep Impact Socket:</b>			
669532	1"	669542	1-5/16"
669534	1-1/16"	669544	1-3/8"
669536	1-1/8"	669546	1-7/16"
669540	1-1/4"	669548	1-1/2"
Metal Box			

6750 g 4 sets / 28 Kgs / 0.62 CUFT



Impact Sockets

**3/4**

# Impact Socket Sets

## DI-621M 21 Piece 3/4" Dr. Metric Deep Impact Socket Set

Item No.	Size	Item No.	Size
<b>3/4" Dr. 6pt Deep Impact Socket:</b>			
649519	19mm	649536	36mm
649521	21mm	649538	38mm
649522	22mm	649540	40mm
649523	23mm	649541	41mm
649524	24mm	649542	42mm
649527	27mm	649543	43mm
649529	29mm	649545	45mm
649530	30mm	649546	46mm
649532	32mm	649548	48mm
649533	33mm	649550	50mm
649535	35mm	Blow Case	

19 Kg

1 set / 20 Kgs / 0.91 CUFT



6 pt.



## DI-621S 21 Piece 3/4" Dr. SAE Deep Impact Socket Set

Item No.	Size	Item No.	Size
<b>3/4" Dr. 6pt Deep Impact Socket:</b>			
669524	3/4"	669546	1-7/16"
669526	13/16"	669548	1-1/2"
669528	7/8"	669550	1-9/16"
669530	15/16"	669552	1-5/8"
669532	1"	669554	1-11/16"
669534	1-1/16"	669556	1-3/4"
669536	1-1/8"	669558	1-13/16"
669538	1-3/16"	669560	1-7/8"
669540	1-1/4"	669562	1-15/16"
669542	1-5/16"	669564	2"
669544	1-3/8"	Blow Case	

19.5 Kg

1 set / 20.5 Kgs / 0.91 CUFT



6 pt.



## IS-619M 3/4" Dr. 19 Piece Metric Impact Socket Set

Item No.	Size	Item No.	Size
<b>3/4" Dr. 6pt Impact Socket:</b>			
645217	17mm	645233	33mm
645219	19mm	645234	34mm
645221	21mm	645235	35mm
645222	22mm	645236	36mm
645224	24mm	645238	38mm
645226	26mm	645241	41mm
645227	27mm	645246	46mm
645228	28mm	645250	50mm
645230	30mm	645255	55mm
645232	32mm	Blow Case	

10 Kg

2 sets / 21 Kgs / 0.92 CUFT



6 pt.

SAE sizes: IS-619S also available



## CM-610M 10 Piece 3/4" Dr. Metric Impact Socket Set

Item No.	Size	Item No.	Size
<b>3/4" Dr. 6pt Impact Socket:</b>			
645219	19mm	645230	30mm
645222	22mm	645232	32mm
645224	24mm	645233	33mm
645227	27mm	645236	36mm
<b>3/4" Dr. Accessory:</b>			
640150	Impact Extension Bar, 150mmL		
640606	Impact Universal Joint		
Metal Box			

4750 g 4 sets / 20 Kgs / 0.6 CUFT



6 pt.

## CM-610S 10 Piece 3/4" Dr. SAE Impact Socket Set

Item No.	Size	Item No.	Size
<b>3/4" Dr. 6pt Impact Socket:</b>			
665224	3/4"	665234	1-1/16"
665228	7/8"	665236	1-1/8"
665230	15/16"	665240	1-1/4"
665232	1"	665244	1-3/8"
<b>3/4" Dr. Accessory:</b>			
640150	Impact Extension Bar, 6"L		
640606	Impact Universal Joint		
Metal Box			

5000 g 4 sets / 21 Kgs / 0.6 CUFT



6 pt.

## IS-617M 17 Piece 3/4" Dr. Metric Impact Socket Set

Item No.	Size	Item No.	Size
<b>3/4" Dr. 6pt Impact Socket:</b>			
645226	26mm	645235	35mm
645227	27mm	645236	36mm
645228	28mm	645237	37mm
645229	29mm	645238	38mm
645230	30mm	645240	40mm
645231	31mm	645241	41mm
645232	32mm	645243	43mm
645233	33mm	645246	46mm
645234	34mm	Blow Case	

10 Kg 2 sets / 21 Kgs / 0.92 CUFT



6 pt.

## IS-617S 17 Piece 3/4" Dr. SAE Impact Socket Set

Item No.	Size	Item No.	Size
<b>3/4" Dr. 6pt Impact Socket:</b>			
665232	1"	665250	1-9/16"
665234	1-1/16"	665252	1-5/8"
665236	1-1/8"	665254	1-11/16"
665238	1-3/16"	665256	1-3/4"
665240	1-1/4"	665258	1-13/16"
665242	1-5/16"	665260	1-7/8"
665244	1-3/8"	665262	1-15/16"
665246	1-7/16"	665264	2"
665248	1-1/2"	Blow Case	

11 Kg 2 sets / 23 Kgs / 0.92 CUFT



6 pt.



**3/4**

# Impact Socket Sets

## IS-617E 17 Piece 3/4" Dr. Metric Impact Socket Set

Item No.	Size	Item No.	Size
<b>3/4" Dr. 6pt Impact Socket:</b>			
645219	19mm	645235	35mm
645221	21mm	645236	36mm
645222	22mm	645238	38mm
645224	24mm	645240	40mm
645227	27mm	645241	41mm
645230	30mm	645246	46mm
645232	32mm	645250	50mm
645233	33mm	645255	55mm
645234	34mm	Blow Case	

9800 g 2 sets / 20.5 Kgs / 0.92 CUFT



6 pt.



## IS-627M 27 Piece 3/4" Dr. Metric Impact Socket Set

Item No.	Size	Item No.	Size
<b>3/4" Dr. 6pt Impact Socket:</b>			
645217	17mm	645236	36mm
645219	19mm	645237	37mm
645220	20mm	645238	38mm
645221	21mm	645240	40mm
645222	22mm	645241	41mm
645223	23mm	645245	45mm
645224	24mm	645246	46mm
645227	27mm	645248	48mm
645230	30mm	645250	50mm
645231	31mm	645254	54mm
645232	32mm	645255	55mm
645233	33mm	645257	57mm
645234	34mm	645260	60mm
645235	35mm	Blow Case	

18 Kg 1 set / 19 Kgs / 0.91 CUFT



6 pt.

## IS-627S 27 Piece 3/4" Dr. SAE Impact Socket Set

Item No.	Size	Item No.	Size
<b>3/4" Dr. 6pt Impact Socket:</b>			
665224	3/4"	665250	1-9/16"
665225	25/32"	665252	1-5/8"
665226	13/16"	665254	1-11/16"
665228	7/8"	665256	1-3/4"
665230	15/16"	665258	1-13/16"
665232	1"	665260	1-7/8"
665234	1-1/16"	665262	1-15/16"
665236	1-1/8"	665264	2"
665238	1-3/16"	665266	2-1/16"
665240	1-1/4"	665268	2-1/8"
665242	1-5/16"	665270	2-3/16"
665244	1-3/8"	665272	2-1/4"
665246	1-7/16"	665276	2-3/8"
665248	1-1/2"	Blow Case	

20 Kg 1 set / 21 Kgs / 0.91 CUFT



6 pt.

## Metric Impact Sockets

Item No.	A mm	D1 mm	D2 mm	Length mm	Weight g	PCS	G.W. KGS	CUFT
						inner/ctn		
847017	17	33.0	50	60	470	1 / 30	15.0	0.38
847018	18	34.3	50	60	480	1 / 30	15.5	0.38
847019	19	35.6	50	60	500	1 / 30	16.0	0.38
847020	20	36.9	50	60	500	1 / 30	16.0	0.38
847021	21	38.1	50	60	510	1 / 30	16.5	0.38
847022	22	39.4	50	60	520	1 / 30	16.5	0.38
847023	23	40.6	50	60	520	1 / 30	16.5	0.38
847024	24	41.9	50	60	530	1 / 30	17.0	0.38
847025	25	43.2	50	60	530	1 / 30	17.0	0.38
847026	26	44.4	50	60	540	1 / 30	17.0	0.38
847027	27	45.7	50	60	550	1 / 30	17.5	0.38
847028	28	46.9	50	60	560	1 / 30	18.0	0.38
847029	29	48.2	50	60	560	1 / 30	18.0	0.38
847030	30	49.0	50	62	580	1 / 30	18.5	0.38
847031	31	50.0	50	62	580	1 / 30	18.5	0.38
847032	32	52.0	52	63	650	1 / 30	20.5	0.38
847033	33	53.0	53	63	670	1 / 30	21.0	0.38
847034	34	54.0	54	63	700	1 / 30	22.0	0.38
847035	35	55.6	52	63	700	1 / 30	22.0	0.38
847036	36	56.9	53	67	750	1 / 20	16.0	0.39
847037	37	58.2	54	67	750	1 / 20	16.0	0.39
847038	38	59.4	54	67	800	1 / 20	17.0	0.39
847039	39	60.7	54	67	840	1 / 20	18.0	0.39
847040	40	61.9	54	67	850	1 / 20	18.0	0.39
847041	41	63.1	54	70	900	1 / 20	19.0	0.39
847042	42	64.3	54	70	920	1 / 20	19.5	0.39
847043	43	65.6	54	70	920	1 / 20	19.5	0.39
847044	44	66.8	54	70	920	1 / 20	19.5	0.39
847045	45	68.0	54	70	1000	1 / 20	21.0	0.39
847046	46	69.4	54	70	1020	1 / 20	21.5	0.39
847047	47	70.7	54	70	1050	1 / 10	11.5	0.43
847048	48	71.9	54	70	1050	1 / 10	11.5	0.43
847049	49	73.2	54	70	1050	1 / 10	11.5	0.43
847050	50	74.4	54	70	1080	1 / 10	12.0	0.43
847051	51	75.2	54	70	1080	1 / 10	12.0	0.43
847052	52	76.9	54	82	1300	1 / 10	14.0	0.43
847053	53	78.2	54	82	1350	1 / 10	14.5	0.43
847054	54	79.4	54	82	1400	1 / 10	15.0	0.43
847055	55	80.7	55	87	1580	1 / 10	17.0	0.43
847056	56	82.0	55	87	1580	1 / 10	17.0	0.43
847057	57	83.2	57	87	1650	1 / 10	17.5	0.43
847058	58	84.4	57	87	1700	1 / 10	18.0	0.43
847059	59	85.7	57	87	1780	1 / 10	19.0	0.43
847060	60	86.9	60	91	1960	1 / 6	13.0	0.41
847061	61	88.1	60	91	1960	1 / 6	13.0	0.41
847062	62	88.9	60	91	1970	1 / 6	13.0	0.41
847063	63	90.7	60	91	2000	1 / 6	13.0	0.41
847064	64	92.0	60	91	2000	1 / 6	13.0	0.41
847065	65	93.2	65	95	2300	1 / 6	15.0	0.41
847066	66	94.4	65	95	2330	1 / 6	15.0	0.41
847067	67	95.7	65	95	2330	1 / 6	15.0	0.41
847068	68	96.9	65	95	2350	1 / 6	15.0	0.41
847069	69	98.1	65	95	2350	1 / 6	15.0	0.41
847070	70	99.4	70	100	2730	1 / 6	17.5	0.41

6 pt.

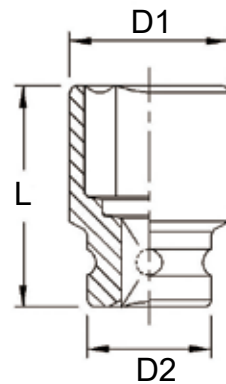
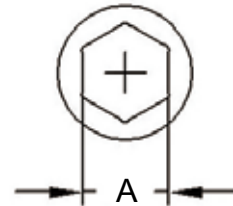

• Size more than 71mm on the next page.

Impact Sockets



# Impact Sockets

## Metric Impact Sockets

Item No.	A mm	D1 mm	D2 mm	Length mm	Weight g	PCS	G.W. KGS	CUFT
						inner/ctn		
847071	71	100.6	70	100	2730	1 / 6	17.5	0.41
847072	72	101.4	70	100	2730	1 / 6	17.5	0.41
847073	73	103.1	70	100	2800	1 / 6	18.0	0.41
847074	74	104.3	70	100	2980	1 / 6	19.0	0.41
847075	75	105.6	70	105	3150	1 / 6	20.0	0.41
847076	76	107.0	70	105	3200	1 / 3	10.5	0.31
847077	77	108.4	70	105	3300	1 / 3	11.0	0.31
847078	78	109.0	70	105	3300	1 / 3	11.0	0.31
847079	79	111.2	70	105	3600	1 / 3	12.0	0.31
847080	80	111.9	80	105	3700	1 / 3	12.0	0.31
847082	82	113.3	80	105	3700	1 / 3	12.0	0.31
847083	83	114.0	80	105	3800	1 / 3	12.5	0.31
847085	85	119.0	86	110	4200	1 / 3	13.5	0.31
847090	90	124.0	86	110	4700	1 / 3	15.0	0.31
847095	95	132.0	86	120	5500	1 / 3	17.5	0.31
847100	100	138.0	86	120	6100	1 / 2	13.0	0.31
847105	105	143.0	95	120	6600	1 / 2	14.0	0.31
847110	110	148.0	95	120	6800	1 / 2	14.5	0.31
847115	115	155.0	95	120	7200	1 / 2	15.5	0.31



## Metric Deep Impact Sockets

Item No.	A mm	D1 mm	D2 mm	Length mm	Weight g	PCS	G.W. KGS	CUFT
						inner/ctn		
849517	17	33.0	50	90	600	1 / 20	13.0	0.34
849518	18	34.3	50	90	600	1 / 20	13.0	0.34
849519	19	35.6	50	90	620	1 / 20	13.5	0.34
849520	20	36.9	50	90	630	1 / 20	13.5	0.34
849521	21	38.1	50	90	670	1 / 20	14.5	0.34
849522	22	39.4	50	90	700	1 / 20	15.0	0.34
849523	23	40.6	50	90	730	1 / 20	15.5	0.34
849524	24	41.9	50	90	740	1 / 20	16.0	0.34
849525	25	43.2	50	90	750	1 / 20	16.0	0.34
849526	26	44.4	50	90	760	1 / 20	16.0	0.34
849527	27	45.7	50	90	800	1 / 20	17.0	0.34
849528	28	46.9	50	90	810	1 / 20	17.0	0.34
849529	29	48.2	50	90	840	1 / 20	18.0	0.34
849530	30	49.0	50	90	840	1 / 20	18.0	0.34
849531	31	50.0	50	90	840	1 / 20	18.0	0.34
849532	32	52.0	52	90	900	1 / 20	19.0	0.34
849533	33	53.0	53	90	950	1 / 20	20.0	0.34
849534	34	54.0	54	90	970	1 / 20	20.5	0.34
849535	35	55.6	52	90	1000	1 / 20	21.0	0.34
849536	36	56.9	53	90	1000	1 / 20	21.0	0.34
849537	37	58.2	54	90	1050	1 / 20	22.0	0.34
849538	38	59.4	54	90	1100	1 / 20	23.0	0.52
849539	39	60.7	54	90	1100	1 / 10	12.0	0.31
849540	40	61.9	54	90	1100	1 / 10	12.0	0.31



• Size more than 41mm on the next page.

Made of Chrome Molybdenum Steel



## Metric Deep Impact Sockets

Item No.	A mm	D1 mm	D2 mm	Length mm	Weight g	PCS inner/ctn	G.W. KGS	CUFT 
849541	41	63.1	54	90	1180	1 / 10	13.0	0.31
849542	42	64.3	54	90	1200	1 / 10	13.0	0.31
849543	43	65.6	54	90	1240	1 / 10	13.5	0.31
849544	44	66.8	54	90	1240	1 / 10	13.5	0.31
849545	45	68.0	54	90	1400	1 / 10	15.0	0.31
849546	46	69.4	54	100	1500	1 / 10	16.0	0.31
849547	47	70.7	54	100	1500	1 / 10	16.0	0.31
849548	48	71.9	54	100	1530	1 / 10	16.5	0.31
849549	49	73.2	54	100	1530	1 / 10	16.5	0.31
849550	50	74.4	54	100	1680	1 / 10	18.0	0.31
849551	51	75.2	54	100	1680	1 / 6	11.0	0.41
849552	52	76.4	54	100	1700	1 / 6	11.0	0.41
849553	53	78.2	54	100	1700	1 / 6	11.0	0.41
849554	54	79.4	54	100	1750	1 / 6	12.0	0.41
849555	55	80.7	55	110	2000	1 / 6	13.0	0.31
849556	56	82.0	55	110	2000	1 / 6	13.0	0.31
849557	57	82.7	57	110	2140	1 / 6	14.0	0.31
849558	58	84.0	57	110	2140	1 / 6	14.0	0.31
849559	59	85.7	57	110	2140	1 / 6	14.0	0.31
849560	60	86.9	60	110	2420	1 / 6	15.5	0.31
849561	61	88.1	60	110	2420	1 / 6	15.5	0.31
849562	62	88.9	60	110	2460	1 / 6	16.0	0.31
849563	63	90.7	60	120	2700	1 / 6	17.0	0.41
849564	64	92.0	60	120	2700	1 / 6	17.0	0.41
849565	65	93.2	65	120	2900	1 / 6	18.5	0.41
849566	66	94.4	65	120	2900	1 / 6	18.5	0.41
849567	67	95.7	65	120	3000	1 / 6	19.0	0.41
849568	68	96.9	65	120	3060	1 / 6	19.5	0.41
849569	69	98.1	65	120	3100	1 / 6	19.5	0.41
849570	70	100.0	70	125	3500	1 / 6	22.0	0.41
849571	71	101.0	70	125	3500	1 / 3	11.5	0.31
849572	72	102.0	70	125	3700	1 / 3	12.0	0.31
849573	73	103.0	70	125	3880	1 / 3	12.5	0.31
849574	74	104.0	70	125	3950	1 / 3	13.0	0.31
849575	75	106.0	70	150	4850	1 / 3	15.5	0.31
849576	76	107.0	70	150	4850	1 / 3	15.5	0.31
849577	77	108.0	70	150	4850	1 / 3	15.5	0.31
849578	78	110.0	70	150	5200	1 / 3	16.5	0.31
849579	79	111.0	70	150	5200	1 / 3	16.5	0.31
849580	80	112.0	80	150	5400	1 / 2	12.0	0.30
849582	82	113.0	80	150	5400	1 / 2	12.0	0.30
849583	83	114.0	80	150	5600	1 / 2	12.0	0.30
849585	85	118.0	86	160	6600	1 / 2	14.0	0.30
849590	90	124.0	86	160	7000	1 / 2	15.0	0.30
849595	95	132.0	86	160	8000	1 / 2	17.0	0.31
849600	100	138.0	86	160	8500	1 / 2	18.0	0.31
849605	105	143.0	95	160	9100	1 / 2	19.0	0.39
849610	110	148.0	95	160	9450	1 / 2	20.0	0.39
849615	115	155.0	95	160	10300	1 / 2	21.5	0.39



6 pt.

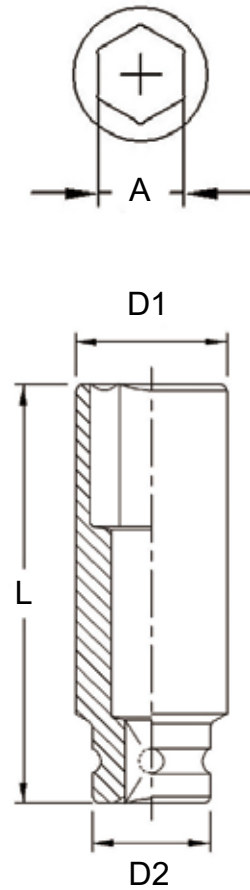



# Impact Sockets

## SAE Impact Sockets

Item No.	A inch	D1 mm	D2 mm	Length mm	Weight g	PCS	G.W. KGS	CUFT
						inner/ctn		
867024	3/4	35.6	50	60	500	1 / 30	16.0	0.38
867025	25/32	36.9	50	60	500	1 / 30	16.0	0.38
867026	13/16	37.7	50	60	510	1 / 30	16.5	0.38
867028	7/8	39.4	50	60	520	1 / 30	16.5	0.38
867030	15/16	41.9	50	60	530	1 / 30	17.0	0.38
867032	1	43.6	50	60	530	1 / 30	17.0	0.38
867034	1-1/16	45.7	50	60	550	1 / 30	17.5	0.38
867036	1-1/8	47.7	50	60	560	1 / 30	18.0	0.38
867038	1-3/16	49.4	50	62	580	1 / 30	18.5	0.38
867040	1-1/4	52.0	52	63	650	1 / 30	20.5	0.38
867042	1-5/16	53.0	53	63	670	1 / 30	21.0	0.38
867044	1-3/8	55.6	52	63	700	1 / 30	22.0	0.38
867046	1-7/16	57.4	54	67	750	1 / 20	16.0	0.39
867048	1-1/2	59.4	54	67	800	1 / 20	17.0	0.39
867050	1-9/16	61.9	54	67	850	1 / 20	18.0	0.39
867052	1-5/8	63.1	54	70	900	1 / 20	19.0	0.39
867054	1-11/16	65.6	54	70	920	1 / 20	19.5	0.39
867056	1-3/4	67.8	54	70	1000	1 / 20	21.0	0.39
867058	1-13/16	69.4	54	70	1020	1 / 20	21.5	0.39
867060	1-7/8	71.9	54	70	1050	1 / 10	11.5	0.43
867062	1-15/16	73.1	54	70	1050	1 / 10	11.5	0.43
867064	2	75.2	54	70	1080	1 / 10	12.0	0.43
867066	2-1/16	76.9	54	82	1300	1 / 10	14.0	0.43
867068	2-1/8	79.4	54	82	1400	1 / 10	15.0	0.43
867070	2-3/16	80.7	55	87	1580	1 / 10	17.0	0.43
867072	2-1/4	83.2	57	87	1650	1 / 10	17.5	0.43
867074	2-5/16	85.7	57	87	1780	1 / 10	19.0	0.43
867076	2-3/8	86.9	60	91	1960	1 / 6	13.0	0.41
867078	2-7/16	88.9	60	91	1970	1 / 6	13.0	0.41
867080	2-1/2	90.7	60	91	2000	1 / 6	13.0	0.41
867082	2-9/16	93.2	65	95	2300	1 / 6	15.0	0.41
867084	2-5/8	95.2	65	95	2330	1 / 6	15.0	0.41
867086	2-11/16	96.9	65	95	2350	1 / 6	15.0	0.41
867088	2-3/4	99.4	70	100	2730	1 / 6	17.5	0.41
867090	2-13/16	100.6	70	100	2730	1 / 6	17.5	0.41
867092	2-7/8	103.1	70	100	2800	1 / 6	18.0	0.41
867094	2-15/16	105.6	70	105	3150	1 / 6	20.0	0.41
867096	3	107.0	70	105	3200	1 / 3	10.5	0.31
867098	3-1/16	109.0	70	105	3300	1 / 3	11.0	0.31
867100	3-1/8	111.9	80	105	3600	1 / 3	12.0	0.31
867102	3-3/16	113.3	80	105	3800	1 / 3	12.5	0.31
867104	3-1/4	114.0	80	105	3800	1 / 3	12.5	0.31
867106	3-5/16	116.0	80	105	3900	1 / 3	13.0	0.31
867108	3-3/8	119.0	86	110	4300	1 / 3	14.0	0.31
867110	3-7/16	120.0	86	110	4400	1 / 3	14.0	0.31
867112	3-1/2	121.0	86	110	4500	1 / 3	14.5	0.31
867114	3-9/16	124.0	86	110	4700	1 / 3	15.0	0.31
867116	3-5/8	126.0	86	110	4900	1 / 3	16.0	0.31
867118	3-11/16	129.0	86	110	5200	1 / 3	16.5	0.31
867120	3-3/4	132.0	86	120	5500	1 / 3	17.5	0.31
867122	3-13/16	134.0	86	120	5800	1 / 3	18.5	0.31
867124	3-7/8	135.0	86	120	5900	1 / 3	19.0	0.31
867126	3-15/16	138.0	86	120	6100	1 / 2	13.0	0.31
867128	4	139.0	86	120	6100	1 / 2	13.0	0.31
867130	4-1/16	142.0	86	120	6300	1 / 2	13.5	0.31
867132	4-1/8	143.0	95	120	6600	1 / 2	14.0	0.31
867134	4-3/16	145.0	95	120	6700	1 / 2	14.5	0.31
867136	4-1/4	147.0	95	120	6800	1 / 2	14.5	0.31
867138	4-5/16	148.0	95	120	6800	1 / 2	14.5	0.31
867140	4-3/8	149.0	95	120	6900	1 / 2	15.0	0.31
867142	4-7/16	152.0	95	120	7000	1 / 2	15.0	0.31
867144	4-1/2	155.0	95	120	7200	1 / 2	15.5	0.31

6 pt.

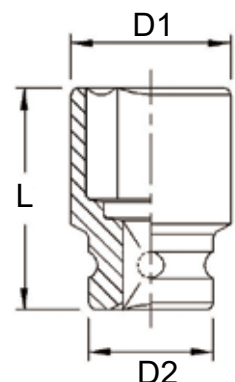
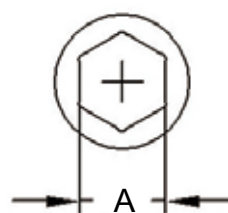

## SAE Deep Impact Sockets

Item No.	A inch	D1 mm	D2 mm	Length mm	Weight g	PCS inner/ctn	G.W. KGS	CUFT
869524	3/4	35.6	50	90	620	1 / 20	13.5	0.34
869525	25/32	36.9	50	90	630	1 / 20	13.5	0.34
869526	13/16	37.7	50	90	670	1 / 20	14.5	0.34
869528	7/8	39.4	50	90	700	1 / 20	15.0	0.34
869530	15/16	41.9	50	90	740	1 / 20	16.0	0.34
869532	1	43.6	50	90	750	1 / 20	16.0	0.34
869534	1-1/16	45.7	50	90	800	1 / 20	17.0	0.34
869536	1-1/8	47.7	50	90	840	1 / 20	18.0	0.34
869538	1-3/16	49.4	50	90	840	1 / 20	18.0	0.34
869540	1-1/4	52.0	52	90	900	1 / 20	19.0	0.34
869542	1-5/16	53.0	53	90	950	1 / 10	10.5	0.31
869544	1-3/8	55.6	52	90	1000	1 / 10	11.0	0.31
869546	1-7/16	57.4	54	90	1050	1 / 10	11.5	0.31
869548	1-1/2	59.4	54	90	1100	1 / 10	12.0	0.31
869550	1-9/16	61.4	54	90	1100	1 / 10	12.0	0.31
869552	1-5/8	63.1	54	90	1180	1 / 10	13.0	0.31
869554	1-11/16	65.1	54	90	1240	1 / 10	13.5	0.31
869556	1-3/4	67.8	54	90	1400	1 / 10	15.0	0.31
869558	1-13/16	69.4	54	100	1500	1 / 10	16.0	0.31
869560	1-7/8	71.4	54	100	1530	1 / 10	16.5	0.31
869562	1-15/16	73.1	54	100	1530	1 / 6	10.0	0.41
869564	2	75.2	54	100	1680	1 / 6	11.0	0.41
869566	2-1/16	76.9	54	100	1700	1 / 6	11.0	0.41
869568	2-1/8	79.4	54	100	1750	1 / 6	12.0	0.41
869570	2-3/16	80.7	55	110	2000	1 / 6	13.0	0.41
869572	2-1/4	82.7	57	110	2140	1 / 6	14.0	0.41
869574	2-5/16	85.7	57	110	2140	1 / 6	14.0	0.31
869576	2-3/8	86.9	60	110	2420	1 / 6	15.5	0.31
869578	2-7/16	88.9	60	110	2460	1 / 6	16.0	0.31
869580	2-1/2	90.7	60	120	2700	1 / 6	17.0	0.41
869582	2-9/16	93.2	65	120	2900	1 / 6	18.5	0.41
869584	2-5/8	95.2	65	120	3000	1 / 6	19.0	0.41
869586	2-11/16	96.9	65	120	3060	1 / 6	19.5	0.41
869588	2-3/4	99.4	70	125	3500	1 / 6	22.0	0.41
869590	2-13/16	101.0	70	125	3500	1 / 3	11.5	0.31
869592	2-7/8	103.0	70	125	3880	1 / 3	12.5	0.31
869594	2-15/16	106.0	70	150	4850	1 / 3	15.5	0.31
869596	3	107.0	70	150	4850	1 / 3	15.5	0.31
869598	3-1/16	110.0	70	150	5200	1 / 3	16.5	0.31
869600	3-1/8	112.0	70	150	5200	1 / 2	11.5	0.31
869602	3-3/16	113.0	80	150	5400	1 / 2	12.0	0.31
869604	3-1/4	114.0	80	150	5400	1 / 2	12.0	0.31
869606	3-5/16	116.0	80	150	5600	1 / 2	12.0	0.31
869608	3-3/8	118.0	86	160	6500	1 / 2	14.0	0.31
869610	3-7/16	120.0	86	160	6500	1 / 2	14.0	0.31
869612	3-1/2	122.0	86	160	6700	1 / 2	14.5	0.31
869614	3-9/16	124.0	86	160	7000	1 / 2	15.0	0.31
869616	3-5/8	128.0	86	160	7500	1 / 2	16.0	0.31
869618	3-11/16	130.0	86	160	7700	1 / 2	16.5	0.31
869620	3-3/4	132.0	86	160	8000	1 / 2	17.0	0.31
869622	3-13/16	134.0	86	160	8100	1 / 2	17.0	0.31
869624	3-7/8	136.0	86	160	8300	1 / 2	17.5	0.31
869626	3-15/16	138.0	86	160	8500	1 / 2	18.0	0.31
869628	4	139.0	86	160	8600	1 / 2	18.0	0.31
869630	4-1/16	142.0	86	160	8800	1 / 2	18.5	0.31
869632	4-1/8	143.0	95	160	9100	1 / 2	19.0	0.39
869634	4-3/16	145.0	95	160	9300	1 / 2	19.5	0.39
869636	4-1/4	147.0	95	160	9450	1 / 2	20.0	0.39
869638	4-5/16	148.0	95	160	9450	1 / 2	20.0	0.39
869640	4-3/8	149.0	95	160	9800	1 / 2	20.5	0.39
869642	4-7/16	152.0	95	160	10000	1 / 2	21.0	0.39
869644	4-1/2	155.0	95	160	10300	1 / 2	21.5	0.39

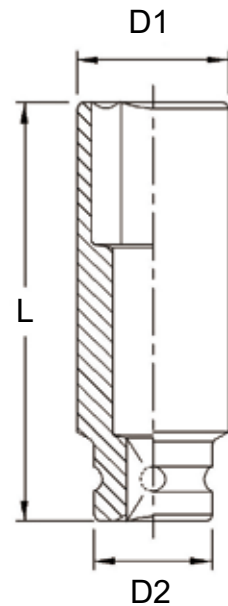
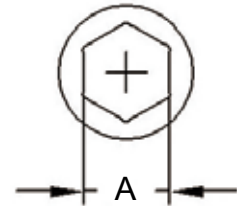

Impact Sockets



# Impact Sockets

## Metric Thin Wall Impact Sockets

Item No.	A	D1	D2	Length mm	Weight g	PCS inner/ctn	G.W. KGS	CUFT
	mm	mm	mm					
848022	22	35.4	50	68	550	1 / 30	18.0	0.52
848023	23	36.7	50	68	560	1 / 30	18.0	0.52
848024	24	37.9	50	68	570	1 / 30	18.0	0.52
848025	25	39.1	50	68	570	1 / 30	19.0	0.52
848026	26	40.4	50	68	580	1 / 30	19.0	0.52
848027	27	41.7	50	73	590	1 / 30	19.0	0.52
848028	28	42.9	50	73	620	1 / 30	20.0	0.52
848029	29	44.1	50	73	630	1 / 30	20.0	0.52
848030	30	45.4	50	73	650	1 / 30	20.5	0.52
848032	32	47.0	50	73	660	1 / 30	21.0	0.52
848033	33	48.0	50	76	670	1 / 30	21.5	0.52
848034	34	49.0	50	76	690	1 / 30	22.0	0.52
848035	35	50.0	50	76	700	1 / 30	22.0	0.52
848036	36	52.9	52	76	710	1 / 30	22.5	0.52
848038	38	54.4	52	80	730	1 / 30	23.0	0.52
848041	41	59.2	52	80	770	1 / 30	24.0	0.52



## SAE Deep Thin Wall Impact Sockets

Item No.	A	D1	D2	Length mm	Weight g	PCS inner/ctn	G.W. KGS	CUFT
	inch	mm	mm					
869534T	1-1/16	43	50	90	650	1 / 20	14.0	0.34
869536T	1-1/8	45	50	90	700	1 / 20	15.0	0.34
869540T	1-1/4	49	52	90	750	1 / 20	16.0	0.34

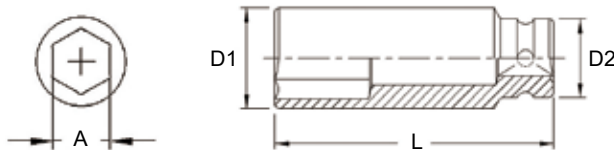

## Impact Adapters

Item No.	Female Drive	Male Drive	Length mm	Weight g	PCS inner/ctn	G.W. KGS	CUFT
841006	1"	3/4" w/Pin Hole	75	580	1 / 30	18.5	0.52
841006B	1"	3/4" w/Steel Ball	75	580	1 / 30	18.5	0.52
841012	1"	1-1/2" w/Pin Hole	80	920	1 / 30	28.5	0.52
841012B	1"	1-1/2" w/Steel Ball	80	920	1 / 30	28.5	0.52



## Impact Universal Joints

Item No.	Type	Outside Diameter	Length mm	Weight g	PCS inner/ctn	G.W. KGS	CUFT
		mm					
840808	w/Pin Hole	52mm	130	1100	1 / 20	23.5	0.52
840808B	w/Steel Ball	52mm	130	1100	1 / 20	23.5	0.52



## Impact Extension Bars

Item No. (Previous No.)	Length mm	Weight g	PCS inner/ctn	G.W. KGS	CUFT
840150	150 w/Pin Hole	1230	2 / 12	16.0	0.34
840150B	150 w/Steel Ball	1230	2 / 12	16.0	0.34
840200 (841064)	200 w/Pin Hole	1560	2 / 12	20.0	0.34
840200B (841064B)	200 w/Steel Ball	1560	2 / 12	20.0	0.34
840250	250 w/Pin Hole	1900	2 / 6	12.5	0.34
840250B	250 w/Steel Ball	1900	2 / 6	12.5	0.34
840400	400 w/Pin Hole	2920	1 / 6	18.5	0.41
840400B	400 w/Steel Ball	2920	1 / 6	18.5	0.41



# Impact Socket Sets

1"

## CM-805M 5 Piece 1" Dr. Metric Impact Socket Set

Previous Item No.: CM-106M

Item No.	Size	Item No.	Size
<b>1" Dr. 6pt Impact Socket:</b>			
847032	32mm	847038	38mm
847035	35mm	847041	41mm
847036	36mm		Metal Box

4330 g 6 sets / 27 Kgs / 0.47 CUFT



6 pt.

## CM-805S 5 Piece 1" Dr. SAE Impact Socket Set

Previous Item No.: CM-025-2

Item No.	Size	Item No.	Size
<b>1" Dr. 6pt Impact Socket:</b>			
867036	1-1/8"	867048	1-1/2"
867040	1-1/4"	867052	1-5/8"
867044	1-3/8"		Metal Box

4330 g 6 sets / 27 Kgs / 0.47 CUFT



6 pt.

## CM-809M 9 Piece 1" Dr. Metric Impact Socket Set

Previous Item No.: CM-110M

Item No.	Size	Item No.	Size
<b>1" Dr. 6pt Impact Socket:</b>			
847024	24mm	847038	38mm
847027	27mm	847041	41mm
847030	30mm	847046	46mm
847032	32mm	847050	50mm
847035	35mm		Metal Box

7250 g 4 sets / 30 Kgs / 0.6 CUFT



6 pt.

## CM-809S 9 Piece 1" Dr. SAE Impact Socket Set

Previous Item No.: CM-029

Item No.	Size	Item No.	Size
<b>1" Dr. 6pt Impact Socket:</b>			
867032	1"	867052	1-5/8"
867036	1-1/8"	867056	1-3/4"
867040	1-1/4"	867060	1-7/8"
867044	1-3/8"	867064	2"
867048	1-1/2"		Metal Box

7250 g 4 sets / 30 Kgs / 0.6 CUFT



6 pt.

Impact Sockets



**1"**

# Impact Socket Sets

## CM-808M 8 Piece 1" Dr. Metric Impact Socket Set

Item No.	Size	Item No.	Size
<b>1" Dr. 6pt Impact Socket:</b>			
847022	22mm	847032	32mm
847024	24mm	847033	33mm
847027	27mm	847035	35mm
847030	30mm	847038	38mm

Metal Box

6000 g

4 sets / 25 Kgs / 0.6 CUFT



6 pt.



## CM-808S 8 Piece 1" Dr. SAE Impact Socket Set

Item No.	Size	Item No.	Size
<b>1" Dr. 6pt Impact Socket:</b>			
867028	7/8"	867036	1-1/8"
867030	15/16"	867038	1-3/16"
867032	1"	867040	1-1/4"
867034	1-1/16"	867048	1-1/2"

Metal Box

5900 g

4 sets / 24.5 Kgs / 0.6 CUFT



6 pt.



## CM-808M3 8 Piece 1" Dr. Metric Impact Socket Set

Item No.	Size	Item No.	Size
<b>1" Dr. 6pt Impact Socket:</b>			
847027	27mm	847038	38mm
847032	32mm	847041	41mm
847035	35mm		

**1" Dr. Budd Wheel Impact Socket:**

846017S	17mm
846019S	19mm
846021S	21mm

Metal Box

6500 g

4 sets / 27 Kgs / 0.6 CUFT

Previous Item No.: CM-108M3



6 pt.



## CM-808S3 8 Piece 1" Dr. SAE Impact Socket Set

Item No.	Size	Item No.	Size
<b>1" Dr. 6pt Impact Socket:</b>			
867034	1-1/16"	867040	1-1/4"
867036	1-1/8"	867044	1-3/8"
867038	1-3/16"	867048	1-1/2"

**1" Dr. Budd Wheel Impact Socket:**

866024S	3/4"
866026S	13/16"

Metal Box

6500 g

4 sets / 27 Kgs / 0.6 CUFT

Previous Item No.: CM-108S3



6 pt.



# Impact Socket Sets

1"

## CD-807M 7 Piece 1" Dr. Metric Deep Impact Socket Set

Previous Item No.: CM-107DM

Item No.	Size	Item No.	Size
<b>1" Dr. 6pt Deep Impact Socket:</b>			
849524	24mm	849534	34mm
849527	27mm	849535	35mm
849530	30mm	849538	38mm
<b>1" Dr. Budd Wheel Impact Socket:</b>			
849517S	17mm	Metal Box	
7000 g	4 sets / 29 Kgs / 0.62 CUFT		



6 pt.  
□

## CD-807S 7 Piece 1" Dr. SAE Deep Impact Socket Set

Previous Item No.: CM-037-1

Item No.	Size	Item No.	Size
<b>1" Dr. 6pt Deep Impact Socket:</b>			
869530	15/16"	869536	1-1/8"
869532	1"	869540	1-1/4"
869534	1-1/16"	869548	1-1/2"
<b>1" Dr. Budd Wheel Impact Socket:</b>			
869526S	13/16"	Metal Box	
7000 g	4 sets / 29 Kgs / 0.62 CUFT		



6 pt.  
□

## CD-808M2 8 Piece 1" Dr. Metric Deep Impact Socket Set

Previous Item No.: CM-109DM

Item No.	Size	Item No.	Size
<b>1" Dr. 6pt Deep Impact Socket:</b>			
849527	27mm	849538	38mm
849532	32mm	849541	41mm
849535	35mm		
<b>1" Dr. Budd Wheel Impact Socket:</b>			
849517S	17mm	849522S	22mm
849521S	21mm	Metal Box	
8650 g	2 sets / 18.3 Kgs / 0.4 CUFT		



6 pt.  
□

## CD-808S2 8 Piece 1" Dr. SAE Deep Impact Socket Set

NEW

Item No.	Size	Item No.	Size
<b>1" Dr. 6pt Deep Impact Socket:</b>			
869532	1"	869544	1-3/8"
869534	1-1/16"	869548	1-1/2"
869536	1-1/8"	869552	1-5/8"
869540	1-1/4"		
<b>1" Dr. Budd Wheel Impact Socket:</b>			
869526S	13/16"	Metal Box	
8650 g	2 sets / 18.3 Kgs / 0.4 CUFT		



6 pt.  
□

Impact Sockets

**1"**

# Impact Socket Sets

## CD-808MD 8 Piece 1" Dr. Metric Deep Impact Socket Set

Item No.	Size	Item No.	Size
<b>1" Dr. 6pt Deep Impact Socket:</b>			
849522	22mm	849532	32mm
849524	24mm	849533	33mm
849527	27mm	849535	35mm
849530	30mm	849538	38mm
Metal Box			
8250 g	2 sets / 17.5 Kgs / 0.4 CUFT		

**6 pt.**

## CD-808SD 8 Piece 1" Dr. SAE Deep Impact Socket Set

Item No.	Size	Item No.	Size
<b>1" Dr. 6pt Deep Impact Socket:</b>			
869528	7/8"	869536	1-1/8"
869530	15/16"	869538	1-3/16"
869532	1"	869540	1-1/4"
869534	1-1/16"	869548	1-1/2"
Metal Box			
7750 g	2 sets / 16.5 Kgs / 0.4 CUFT		

**6 pt.**

## CD-808M5 8 Piece 1" Dr. Metric Deep Impact Socket Set Previous Item No.: CD-108M5

Item No.	Size	Item No.	Size
<b>1" Dr. 6pt Impact Socket:</b>			
847027	27mm	847033	33mm
847030	30mm		
<b>1" Dr. 6pt Deep Impact Socket:</b>			
849535	35mm	849541	41mm
849538	38mm		
<b>1" Dr. Budd Wheel Impact Socket:</b>			
846019S	19mm	846021S	21mm
Metal Box			
7250 g	2 sets / 15.5 Kgs / 0.4 CUFT		

**6 pt.**

## CD-808S5 8 Piece 1" Dr. SAE Deep Impact Socket Set Previous Item No.: CD-108S5

Item No.	Size	Item No.	Size
<b>1" Dr. 6pt Impact Socket:</b>			
867034	1-1/16"	867040	1-1/4"
867036	1-1/8"		
<b>1" Dr. 6pt Deep Impact Socket:</b>			
869542	1-5/16"	869548	1-1/2"
869544	1-3/8"		
<b>1" Dr. Budd Wheel Impact Socket:</b>			
866024S	3/4"	866026S	13/16"
Metal Box			
7000 g	4 sets / 29 Kgs / 0.62 CUFT		

**6 pt.**

Made of Chrome Molybdenum Steel

A-63

## IS-817M 17 Piece 1" Dr. Metric Impact Socket Set

Item No.	Size	Item No.	Size
<b>1" Dr. 6pt Impact Socket:</b>			
847024	24mm	847046	46mm
847027	27mm	847050	50mm
847030	30mm	847054	54mm
847032	32mm	847055	55mm
847033	33mm	847060	60mm
847035	35mm	847065	65mm
847036	36mm	847070	70mm
847038	38mm	847075	75mm
847041	41mm		Blow Case

21.6 Kg 1 set / 22.5 Kgs / 1.41 CUFT



6 pt.

## IS-817S 17 Piece 1" Dr. SAE Impact Socket Set

Item No.	Size	Item No.	Size
<b>1" Dr. 6pt Impact Socket:</b>			
867046	1-7/16"	867070	2-3/16"
867048	1-1/2"	867072	2-1/4"
867052	1-5/8"	867076	2-3/8"
867054	1-11/16"	867080	2-1/2"
867056	1-3/4"	867084	2-5/8"
867058	1-13/16"	867088	2-3/4"
867060	1-7/8"	867094	2-15/16"
867064	2"	867100	3-1/8"
867068	2-1/8"		Blow Case

27.7 Kg 1 set / 28.5 Kgs / 1.41 CUFT



6 pt.

Impact Sockets

**1"**

# Impact Socket Sets

## TR-811M 11 Piece 1" Dr. Metric Truck Wheel Impact Socket Set

Item No.	Size	Item No.	Size
<b>1" Dr. 6pt Impact Socket:</b>			
847027	27mm	847032	32mm
847030	30mm		
<b>1" Dr. 6pt Deep Impact Socket:</b>			
849533	33mm	849538	38mm
849535	35mm	849541	41mm
849536	36mm		
<b>1" Dr. Budd Wheel Impact Socket:</b>			
846017S	17mm	846021S	21mm
846020S	20mm	Blow Case	
9350 g	2 sets / 20 Kgs / 0.95 CUFT		



## TR-811S 11 Piece 1" Dr. SAE Truck Wheel Impact Socket Set

Item No.	Size	Item No.	Size
<b>1" Dr. 6pt Impact Socket:</b>			
867028	7/8"	867032	1"
867030	15/16"	867038	1-3/16"
<b>1" Dr. 6pt Deep Impact Socket:</b>			
869556	1-3/4"		
<b>1" Dr. 6pt Deep Thin Wall Impact Socket:</b>			
869534T	1-1/16"	869540T	1-1/4"
869536T	1-1/8"		
<b>1" Dr. Budd Wheel Impact Socket:</b>			
866026S	13/16"	866030S	15/16"
<b>1" Dr. Deep Budd Wheel Impact Socket:</b>			
869548B	1-1/2"	Blow Case	
8600 g	2 sets / 18.5 Kgs / 0.95 CUFT		



## TR-811MS 11 Piece 1" Dr. Metric & SAE Truck Wheel Impact Socket Set

Item No.	Size	Item No.	Size
<b>1" Dr. 6pt Deep Impact Socket:</b>			
849533	33mm	849538	38mm
849535	35mm	849541	41mm
<b>1" Dr. 6pt Deep Thin Wall Impact Socket:</b>			
869534T	1-1/16"	869540T	1-1/4"
869536T	1-1/8"		
<b>1" Dr. Budd Wheel Impact Socket:</b>			
846017S	17mm	866026S	13/16"
846021S	21mm		
<b>1" Dr. Deep Budd Wheel Impact Socket:</b>			
869548B	1-1/2"	Blow Case	
9850 g	2 sets / 21 Kgs / 0.95 CUFT		



- These 1" & 3/4" Dr. impact socket sets designed for servicing truck wheels.
- The most popular SAE and Metric impact socket sizes for truck wheel fasteners.
- 4-Point impact sockets for inner Budd-style square fasteners on truck wheels.
- Special 1-1/2" Hex deep impact socket designed for outer cap nuts on Budd-style truck wheels.
- Deep Thin Wall impact sockets designed for truck wheel servicing when removing Dayton Style Lug Nuts that are deeply recessed and where space is very limited.
- Metric impact socket set for servicing tires and wheels on a complete range of European and Japanese trucks with metric wheel fasteners.

Made of Chrome Molybdenum Steel

**ENIUS**  
PROFESSIONAL TOOLS

A-65

## Metric Jumbo Impact Sockets

Item No.	A mm	D1 mm	D2 mm	Length mm	Weight g
938441	41	68	86	80	2100
938442	42	69	86	80	2100
938443	43	70	86	80	2100
938446	46	74	86	84	2200
938450	50	79	86	84	2300
938452	52	82	86	84	2300
938454	54	84	86	84	2350
938455	55	86	86	90	2500
938458	58	89	86	90	2600
938460	60	92	86	90	2700
938463	63	96	86	95	3000
938465	65	98	86	95	3050
938470	70	104	86	100	3400
938475	75	110	86	105	3800
938477	77	113	86	105	4100
938478	78	114	86	105	4150
938480	80	116	86	110	4300
938485	85	123	86	110	4600
938490	90	129	86	112	5050
938495	95	136	127	112	7350
938500	100	142	127	115	7800
938505	105	148	127	120	8500
938510	110	154	127	124	9250
938515	115	160	127	128	9900
938520	120	167	127	132	10900
938525	125	174	127	136	11850
938530	130	180	127	140	12700
938535	135	186	127	145	13750
938540	140	192	127	150	14900
938545	145	198	127	155	16000
938550	150	204	127	160	17300
938555	155	210	127	165	18600
938560	160	218	127	170	20600
938565	165	224	127	175	22000

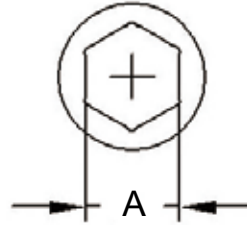

## SAE Jumbo Impact Sockets

Item No.	A inch	D1 mm	D2 mm	Length mm	Weight g
938652	1-5/8	68	86	80	2100
938654	1-11/16	70	86	80	2100
938656	1-3/4	72	86	80	2150
938658	1-13/16	74	86	84	2200
938660	1-7/8	76	86	84	2250
938662	1-15/16	78	86	84	2250
938664	2	80	86	84	2300
938666	2-1/16	82	86	84	2300
938668	2-1/8	84	86	84	2350
938670	2-3/16	86	86	90	2500
938672	2-1/4	88	86	90	2600
938674	2-5/16	90	86	90	2650
938676	2-3/8	92	86	90	2700
938678	2-7/16	94	86	95	2900
938680	2-1/2	96	86	95	3000
938682	2-9/16	98	86	95	3050
938684	2-5/8	100	86	100	3250
938686	2-11/16	102	86	100	3350
938688	2-3/4	104	86	100	3400
938690	2-13/16	106	86	105	3700
938692	2-7/8	108	86	105	3750
938694	2-15/16	110	86	105	3800
938696	3	112	86	105	4000
938698	3-1/16	114	86	105	4050
938700	3-1/8	116	86	110	4300
938702	3-3/16	118	86	110	4400
938704	3-1/4	120	86	110	4500

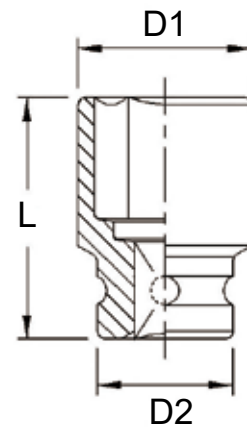

• Size more than 3-5/16" on the next page.

**1 1/2**

# Jumbo Impact Sockets

## SAE Jumbo Impact Sockets

Item No.	A inch	D1 mm	D2 mm	Length mm	Weight g
938706	3-5/16	122	86	110	4600
938708	3-3/8	124	86	110	4650
938710	3-7/16	126	86	112	4900
938712	3-1/2	128	86	112	5000
938714	3-9/16	129	86	112	5050
938716	3-5/8	132	86	112	5200
938718	3-11/16	134	86	112	5250
938720	3-3/4	136	127	112	7350
938722	3-13/16	138	127	115	7550
938724	3-7/8	140	127	115	7750
938726	3-15/16	142	127	115	7800
938728	4	144	127	120	8250
938730	4-1/16	146	127	120	8450
938732	4-1/8	148	127	120	8500
938734	4-3/16	150	127	120	8700
938736	4-1/4	152	127	124	9150
938738	4-5/16	154	127	124	9250
938740	4-3/8	156	127	124	9450
938742	4-7/16	158	127	124	9550
938744	4-1/2	160	127	128	9900
938746	4-9/16	162	127	128	10100
938748	4-5/8	164	127	132	10600
938750	4-11/16	166	127	132	10850
938752	4-3/4	167	127	132	10900
938754	4-13/16	170	127	132	11150
938756	4-7/8	172	127	136	11600
938758	4-15/16	174	127	136	11850
938760	5	176	127	140	12300
938762	5-1/16	178	127	140	12600
938764	5-1/8	180	127	140	12700
938766	5-3/16	182	127	140	12850
938768	5-1/4	184	127	145	13600
938770	5-5/16	186	127	145	13750
938772	5-3/8	188	127	145	14000
938774	5-7/16	190	127	150	14750
938776	5-1/2	192	127	150	14900
938778	5-9/16	194	127	150	15050
938780	5-5/8	196	127	155	15850
938782	5-11/16	198	127	155	16000
938784	5-3/4	200	127	155	16300
938786	5-13/16	202	127	160	17100
938788	5-7/8	204	127	160	17300
938790	5-15/16	206	127	160	17650
938792	6	208	127	160	17900
938794	6-1/16	210	127	165	18600
938796	6-1/8	212	127	165	18950
938798	6-3/16	214	127	165	19350
938800	6-1/4	216	127	170	20200
938802	6-5/16	218	127	170	20600
938804	6-3/8	220	127	170	20800
938806	6-7/16	222	127	170	21000
938808	6-1/2	224	127	175	22000

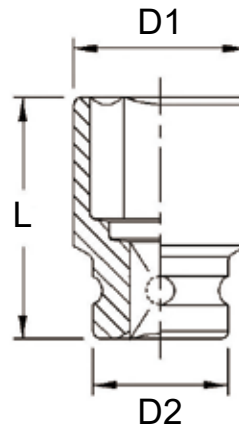
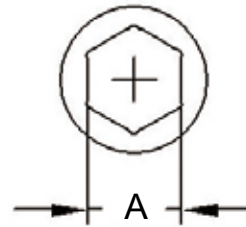

6 pt.



## Impact Adapters

Item No.	Female Drive	Male Drive	Length mm	Weight g	PCS	G.W. KGS	CUFT
938008	1-1/2"	1" / Pin Hole	98	2500	6	16.0	0.41
938008B	1-1/2"	1" / Steel Ball	98	2500	6	16.0	0.41
938020	1-1/2"	2-1/2"	125	4000	6	25.0	0.41

## Impact Universal Joint (Quick Release)

Item No.	Outside Diameter	Length mm	Weight g	PCS	G.W. KGS	CUFT
940909	86mm	175	4400	5	23.0	0.30



Made of Chrome Molybdenum Steel

## Metric Deep Jumbo Impact Sockets

Item No.	A mm	D1 mm	D2 mm	Length mm	Weight g
939441	41	68	86	120	2850
939442	42	69	86	120	2900
939443	43	70	86	120	2900
939446	46	74	86	130	3200
939450	50	79	86	140	3600
939452	52	82	86	140	3750
939454	54	84	86	140	3800
939455	55	86	86	150	4200
939458	58	89	86	150	4350
939460	60	92	86	150	4600
939463	63	96	86	150	4850
939465	65	98	86	150	4950
939470	70	104	86	150	5350
939475	75	110	86	160	6200
939480	80	116	86	170	7050
939485	85	123	86	170	7700
939490	90	129	86	180	8750
939495	95	136	127	180	11550
939500	100	142	127	190	12800
939505	105	148	127	190	13700
939510	110	154	127	200	14900
939515	115	160	127	200	15800
939520	120	167	127	210	17900
939525	125	174	127	210	19000
939530	130	180	127	210	19950
939535	135	186	127	220	22100
939540	140	192	127	220	23150
939545	145	198	127	220	24200
939550	150	204	127	230	26600
939555	155	210	127	230	28000
939560	160	218	127	230	29800
939565	165	224	127	230	31000

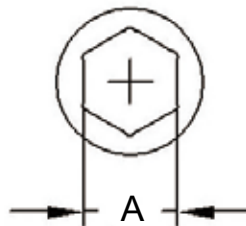

## SAE Deep Jumbo Impact Sockets

Item No.	A inch	D1 mm	D2 mm	Length mm	Weight g
939652	1-5/8	68	86	120	2850
939654	1-11/16	70	86	120	2900
939656	1-3/4	72	86	120	2950
939658	1-13/16	74	86	130	3200
939660	1-7/8	76	86	130	3250
939662	1-15/16	78	86	130	3350
939664	2	80	86	140	3650
939666	2-1/16	82	86	140	3750
939668	2-1/8	84	86	140	3800
939670	2-3/16	86	86	150	4200
939672	2-1/4	88	86	150	4300
939674	2-5/16	90	86	150	4400
939676	2-3/8	92	86	150	4600
939678	2-7/16	94	86	150	4700
939680	2-1/2	96	86	150	4850
939682	2-9/16	98	86	150	4950
939684	2-5/8	100	86	150	5050
939686	2-11/16	102	86	150	5250
939688	2-3/4	104	86	150	5350
939690	2-13/16	106	86	160	5900
939692	2-7/8	108	86	160	6050
939694	2-15/16	110	86	160	6200
939696	3	112	86	170	6850
939698	3-1/16	114	86	170	7000
939700	3-1/8	116	86	170	7050
939702	3-3/16	118	86	170	7300
939704	3-1/4	120	86	170	7400

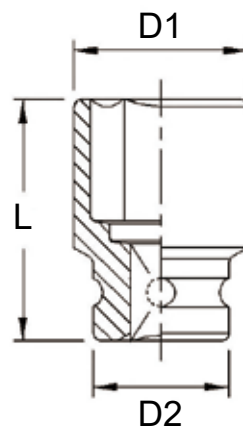

• Size more than 3-5/16" on the next page.

Impact Sockets



**1 1/2**

# Deep Jumbo Impact Sockets

## SAE Deep Jumbo Impact Sockets

Item No.	A inch	D1 mm	D2 mm	Length mm	Weight g
939706	3-5/16	122	86	170	7650
939708	3-3/8	124	86	170	7800
939710	3-7/16	126	86	170	8050
939712	3-1/2	128	86	170	8200
939714	3-9/16	129	86	180	8750
939716	3-5/8	132	86	180	9100
939718	3-11/16	134	86	180	9300
939720	3-3/4	136	127	180	11550
939722	3-13/16	138	127	180	11700
939724	3-7/8	140	127	180	12000
939726	3-15/16	142	127	190	12800
939728	4	144	127	190	13100
939730	4-1/16	146	127	190	13450
939732	4-1/8	148	127	190	13700
939734	4-3/16	150	127	190	13850
939736	4-1/4	152	127	190	14050
939738	4-5/16	154	127	200	14900
939740	4-3/8	156	127	200	15300
939742	4-7/16	158	127	200	15600
939744	4-1/2	160	127	200	15800
939746	4-9/16	162	127	200	16150
939748	4-5/8	164	127	200	16550
939750	4-11/16	166	127	200	17050
939752	4-3/4	167	127	210	17900
939754	4-13/16	170	127	210	18350
939756	4-7/8	172	127	210	18500
939758	4-15/16	174	127	210	19000
939760	5	176	127	210	19300
939762	5-1/16	178	127	210	19750
939764	5-1/8	180	127	210	19950
939766	5-3/16	182	127	210	20350
939768	5-1/4	184	127	210	20700
939770	5-5/16	186	127	220	22100
939772	5-3/8	188	127	220	22700
939774	5-7/16	190	127	220	22900
939776	5-1/2	192	127	220	23150
939778	5-9/16	194	127	220	23550
939780	5-5/8	196	127	220	23800
939782	5-11/16	198	127	220	24200
939784	5-3/4	200	127	220	24700
939786	5-13/16	202	127	220	24950
939788	5-7/8	204	127	230	26600
939790	5-15/16	206	127	230	27250
939792	6	208	127	230	27800
939794	6-1/16	210	127	230	28000
939796	6-1/8	212	127	230	28500
939798	6-3/16	214	127	230	29200
939800	6-1/4	216	127	230	29500
939802	6-5/16	218	127	230	29800
939804	6-3/8	220	127	230	30300
939806	6-7/16	222	127	230	30800
939808	6-1/2	224	127	230	31000

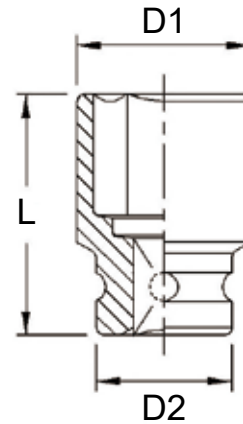
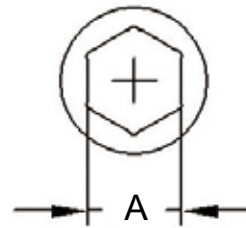

6 pt.



## Sliding T-Handle

Item No.	Length mm	Weight g	PCS 	G.W. KGS	CUFT 
980090	915	8500	2	18.0	0.45



## Impact Extension Bars

Item No.	Length mm	Weight g	PCS 	G.W. KGS	CUFT 
938175	175	4000	5	21.0	0.44
938250	250	4800	4	20.0	0.30
938330	330	6150	2	13.5	0.31



**ENIUS**  
PROFESSIONAL TOOLS

Made of Chrome Molybdenum Steel

# Jumbo Impact Sockets

2 1/2"

6 pt.

## Metric Jumbo Impact Sockets

Item No.	A mm	D1 mm	D2 mm	Length mm	Weight g
920460	60	98	127	125	6800
920463	63	102	127	125	6850
920465	65	104	127	125	6850
920470	70	110	127	125	6900
920475	75	116	127	125	7000
920480	80	123	127	125	7200
920485	85	129	127	135	7900
920490	90	135	127	135	8200
920495	95	142	127	140	8950
920500	100	148	127	145	9700
920505	105	154	127	150	10450
920510	110	160	127	155	11300
920515	115	166	127	160	12200
920520	120	173	127	160	12900
920525	125	179	175	165	19000
920530	130	185	175	170	20000
920535	135	192	175	175	21400
920540	140	198	175	180	22800
920545	145	204	175	185	24200
920550	150	210	175	190	25600
920555	155	216	175	195	27000
920560	160	223	175	200	29100
920565	165	229	175	205	30800
920570	170	235	175	210	32400
920575	175	242	175	210	33800
920580	180	248	175	215	35600
920585	185	254	175	220	38000
920590	190	260	175	220	39000
920595	195	266	175	225	41100
920600	200	273	175	225	42600
920605	205	279	175	230	44900
920610	210	285	175	235	47300
920615	215	292	175	240	50400
920620	220	298	175	245	53000
920625	225	304	175	250	55800
920630	230	310	175	255	58600
920635	235	316	175	260	61700

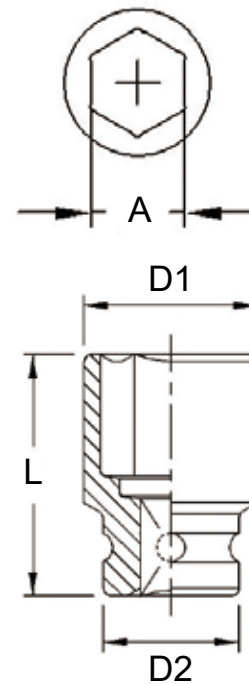

## Impact Adapter

Item No.	Female Drive	Male Drive	Length mm	Weight g	PCS	G.W. KGS	CUFT
920012	2-1/2"	1-1/2"	135	7500	2	16.0	0.30

## Impact Extension Bars

Item No.	Male Drive	Length mm	Weight g	PCS	G.W. KGS	CUFT
920250	2-1/2"	250	10000	1	11.0	0.30
920320	2-1/2"	320	15500	1	16.5	0.31



Impact Sockets

**2 1/2**

# Jumbo Impact Sockets

## SAE Jumbo Impact Sockets

Item No.	A inch	D1 mm	D2 mm	Length mm	Weight g
920776	2-3/8	98	127	125	6800
920778	2-7/16	100	127	125	6800
920780	2-1/2	102	127	125	6850
920782	2-9/16	104	127	125	6850
920784	2-5/8	106	127	125	6900
920786	2-11/16	108	127	125	6900
920788	2-3/4	110	127	125	6900
920790	2-13/16	112	127	125	7000
920792	2-7/8	114	127	125	7000
920794	2-15/16	116	127	125	7000
920796	3	118	127	125	7100
920798	3-1/16	120	127	125	7100
920800	3-1/8	123	127	125	7200
920802	3-3/16	124	127	125	7200
920804	3-1/4	126	127	125	7200
920806	3-5/16	128	127	135	7850
920808	3-3/8	130	127	135	7950
920810	3-7/16	132	127	135	8100
920812	3-1/2	134	127	135	8150
920814	3-9/16	135	127	135	8200
920816	3-5/8	138	127	135	8400
920818	3-11/16	140	127	135	8500
920820	3-3/4	142	127	140	8950
920822	3-13/16	144	127	140	9050
920824	3-7/8	145	127	140	9100
920826	3-15/16	148	127	145	9700
920828	4	150	127	145	9800
920830	4-1/16	152	127	150	10350
920832	4-1/8	154	127	150	10450
920834	4-3/16	155	127	150	10500
920836	4-1/4	158	127	155	11200
920838	4-5/16	160	127	155	11300
920840	4-3/8	162	127	155	11500
920842	4-7/16	164	127	155	11650
920844	4-1/2	166	127	160	12200
920846	4-9/16	168	127	160	12450
920848	4-5/8	170	127	160	12600
920850	4-11/16	172	127	160	12800
920852	4-3/4	173	127	160	12900
920854	4-13/16	175	127	160	13000
920856	4-7/8	178	175	165	18900
920858	4-15/16	179	175	165	19000
920860	5	182	175	165	19350
920862	5-1/16	183	175	165	19400
920864	5-1/8	185	175	170	20000
920866	5-3/16	188	175	170	20400
920868	5-1/4	189	175	170	20500
920870	5-5/16	192	175	175	21400
920872	5-3/8	193	175	175	21500
920874	5-7/16	195	175	175	21700
920876	5-1/2	198	175	180	22800
920878	5-9/16	200	175	180	23000
920880	5-5/8	202	175	180	23300
920882	5-11/16	204	175	185	24200
920884	5-3/4	205	175	185	24300
920886	5-13/16	208	175	185	24700
920888	5-7/8	210	175	190	25600
920890	5-15/16	212	175	190	26000

• Size more than 6" on the next page.

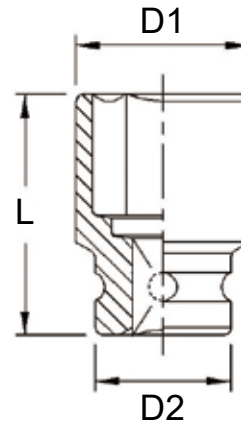
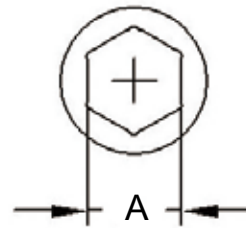

6 pt.



**\*\*Please Note\*\***

Any sockets with a drive size of 2-1/2" or higher are not stock items and will have to be custom ordered. Please allow for lead times of up to 60 days

## SAE Jumbo Impact Sockets

Item No.	A inch	D1 mm	D2 mm	Length mm	Weight g
920892	6	213	175	190	26100
920894	6-1/16	216	175	195	27000
920896	6-1/8	218	175	195	27200
920898	6-3/16	219	175	195	27700
920900	6-1/4	222	175	195	28200
920902	6-5/16	223	175	200	29100
920904	6-3/8	225	175	200	29400
920906	6-7/16	228	175	200	29900
920908	6-1/2	229	175	205	30800
920910	6-9/16	232	175	205	31400
920912	6-5/8	233	175	205	31500
920914	6-11/16	235	175	210	32400
920916	6-3/4	238	175	210	33000
920918	6-13/16	239	175	210	33100
920920	6-7/8	242	175	210	33800
920922	6-15/16	243	175	210	33900
920924	7	245	175	210	34100
920926	7-1/16	248	175	215	35600
920928	7-1/8	249	175	215	35800
920930	7-3/16	252	175	215	36400
920932	7-1/4	253	175	215	36600
920934	7-5/16	254	175	220	38000
920936	7-3/8	256	175	220	38200
920938	7-7/16	259	175	220	38900
920940	7-1/2	260	175	220	39000
920942	7-9/16	263	175	220	39700
920944	7-5/8	265	175	220	39900
920946	7-11/16	266	175	225	41100
920948	7-3/4	269	175	225	41800
920950	7-13/16	272	175	225	42500
920952	7-7/8	273	175	225	42600
920954	7-15/16	275	175	225	42900
920956	8	276	175	225	43000
920958	8-1/16	279	175	230	44900
920960	8-1/8	280	175	230	45000
920962	8-3/16	283	175	230	45800
920964	8-1/4	285	175	235	47300
920966	8-5/16	286	175	235	47600
920968	8-3/8	289	175	235	48200
920970	8-7/16	292	175	240	50400
920972	8-1/2	293	175	240	50600
920974	8-9/16	295	175	240	50800
920976	8-5/8	298	175	245	53000
920978	8-11/16	299	175	245	53200
920980	8-3/4	300	175	245	53400
920982	8-13/16	303	175	245	54100
920984	8-7/8	304	175	250	55800
920986	8-15/16	306	175	250	56200
920988	9	309	175	250	57000
920990	9-1/16	310	175	255	58600
920992	9-1/8	313	175	255	59600
920994	9-3/16	314	175	255	59700
920996	9-1/4	316	175	260	61700

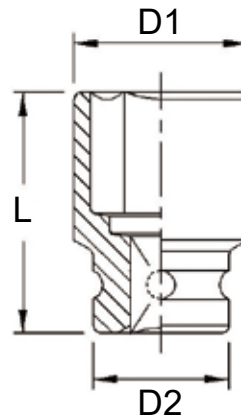
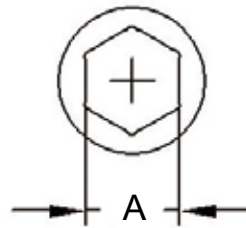

### \*\*Please Note\*\*

Any sockets with a drive size of 2-1/2" or higher are not stock items and will have to be custom ordered. Please allow for lead times of up to 60 days

Impact Sockets

**3 1/2**

# Jumbo Impact Sockets

## Metric Jumbo Impact Sockets

Item No.	A mm	D1 mm	D2 mm	Length mm	Weight g
928105	105	160	175	175	18400
928110	110	166	175	175	18650
928115	115	172	175	180	19400
928120	120	180	175	185	20800
928125	125	186	175	190	21900
928130	130	192	175	195	23100
928135	135	198	175	200	24300
928140	140	204	175	205	25650
928145	145	210	200	210	31500
928150	150	216	200	210	32600
928155	155	222	200	215	34200
928160	160	230	200	220	36700
928165	165	236	200	225	38700
928170	170	242	200	225	39750
928175	175	248	200	230	41800
928180	180	254	200	230	42900
928185	185	260	200	235	45100
928190	190	268	200	240	48450
928195	195	274	200	240	49500
928200	200	280	200	245	52000
928205	205	286	200	250	54500
928210	210	292	200	255	57000
928215	215	298	200	260	59800
928220	220	304	200	265	62500
928225	225	312	200	265	65000
928230	230	318	200	270	68000
928235	235	324	200	275	70800

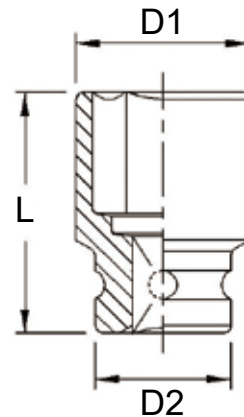
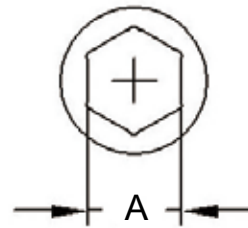

### \*\*Please Note\*\*

Any sockets with a drive size of 2-1/2" or higher are not stock items and will have to be custom ordered. Please allow for lead times of up to 60 days

**6 pt.**

## SAE Jumbo Impact Sockets

Item No.	A inch	D1 mm	D2 mm	Length mm	Weight g
928332	4-1/8	160	175	175	18400
928334	4-3/16	162	175	175	18600
928336	4-1/4	164	175	175	18600
928338	4-5/16	166	175	175	18650
928340	4-3/8	168	175	175	18850
928342	4-7/16	170	175	175	18900
928344	4-1/2	172	175	180	19400
928346	4-9/16	174	175	180	19600
928348	4-5/8	176	175	180	19700
928350	4-11/16	178	175	180	20000
928352	4-3/4	180	175	185	20800
928354	4-13/16	182	175	185	20900
928356	4-7/8	184	175	185	21000
928358	4-15/16	186	175	190	21900
928360	5	188	175	190	22000
928362	5-1/16	190	175	190	22300
928364	5-1/8	192	175	195	23100
928366	5-3/16	194	175	195	23200
928368	5-1/4	196	175	195	23500
928370	5-5/16	198	175	200	24300
928372	5-3/8	200	175	200	24600
928374	5-7/16	202	175	200	24850
928376	5-1/2	204	175	205	25650
928378	5-9/16	206	175	205	25900
928380	5-5/8	208	175	205	26300
928382	5-11/16	210	200	210	31500
928384	5-3/4	212	200	210	32100
928386	5-13/16	214	200	210	32300
928388	5-7/8	216	200	210	32600
928390	5-15/16	218	200	210	33000
928392	6	220	200	210	33400
928394	6-1/16	222	200	215	34200
928396	6-1/8	224	200	215	34650
928398	6-3/16	226	200	215	35100
928400	6-1/4	228	200	215	35400
928402	6-5/16	230	200	220	36700
928404	6-3/8	232	200	220	37000
928406	6-7/16	234	200	220	37350
928408	6-1/2	236	200	225	38700
928410	6-9/16	238	200	225	39000
928412	6-5/8	240	200	225	39500
928414	6-11/16	242	200	225	39750
928416	6-3/4	244	200	225	40000
928418	6-13/16	246	200	225	40500
928420	6-7/8	248	200	230	41800
928422	6-15/16	250	200	230	42400

• Size more than 7" on the next page.

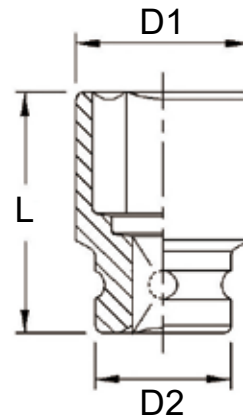
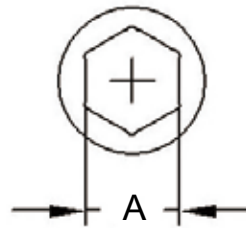

### \*\*Please Note\*\*

Any sockets with a drive size of 2-1/2" or higher are not stock items and will have to be custom ordered. Please allow for lead times of up to 60 days

3 1/2

# Jumbo Impact Sockets

## SAE Jumbo Impact Sockets

Item No.	A inch	D1 mm	D2 mm	Length mm	Weight g
928424	7	252	200	230	42600
928426	7-1/16	254	200	230	42900
928428	7-1/8	256	200	230	43450
928430	7-3/16	258	200	230	43700
928432	7-1/4	260	200	235	45100
928434	7-5/16	262	200	235	45700
928436	7-3/8	264	200	235	46200
928438	7-7/16	266	200	235	46500
928440	7-1/2	268	200	240	48450
928442	7-9/16	270	200	240	48700
928444	7-5/8	272	200	240	49000
928446	7-11/16	274	200	240	49500
928448	7-3/4	276	200	240	49800
928450	7-13/16	278	200	240	50400
928452	7-7/8	280	200	245	52000
928454	7-15/16	282	200	245	52300
928456	8	284	200	245	52850
928458	8-1/16	286	200	250	54500
928460	8-1/8	288	200	250	55200
928462	8-3/16	290	200	250	55450
928464	8-1/4	292	200	255	57000
928466	8-5/16	294	200	255	57700
928468	8-3/8	296	200	255	58000
928470	8-7/16	298	200	260	59800
928472	8-1/2	300	200	260	60500
928474	8-9/16	302	200	260	60800
928476	8-5/8	304	200	265	62500
928478	8-11/16	306	200	265	63300
928480	8-3/4	308	200	265	64000
928482	8-13/16	310	200	265	64300
928484	8-7/8	312	200	265	65000
928486	8-15/16	314	200	265	65300
928488	9	316	200	265	65700
928490	9-1/16	318	200	270	68000
928492	9-1/8	320	200	270	68400
928494	9-3/16	322	200	270	69200
928496	9-1/4	324	200	275	70800

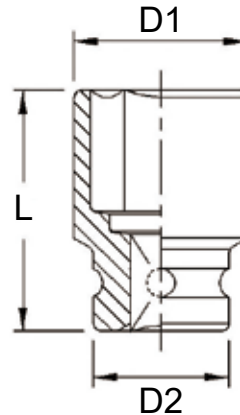
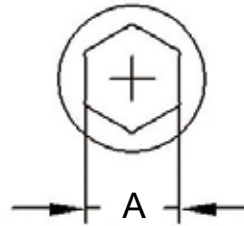

6 pt.





### \*\*Please Note\*\*

Any sockets with a drive size of 2-1/2" or higher are not stock items and will have to be custom ordered. Please allow for lead times of up to 60 days

# #5 Spline Drive Impact Sockets

5



## #5 Spline Dr. Metric Impact Sockets

Item No.	A mm	D1 mm	D2 mm	Length mm	Weight g	PCS 	G.W. KGS	CUFT 
547022	22	38	60	70	680	24	17.0	0.44
547024	24	40	60	70	700	24	18.0	0.44
547025	25	42	60	70	720	24	18.0	0.44
547027	27	44	60	70	730	24	18.5	0.44
547029	29	46	60	70	750	24	19.0	0.44
547030	30	48	60	70	760	24	19.0	0.44
547032	32	50	60	75	810	24	20.5	0.44
547033	33	52	60	75	840	24	21.0	0.44
547035	35	54	60	77	870	24	22.0	0.44
547038	38	58	60	81	950	10	10.5	0.31
547041	41	62	60	81	1030	10	11.5	0.31
547046	46	68	60	86	1200	10	13.0	0.31

6 pt.



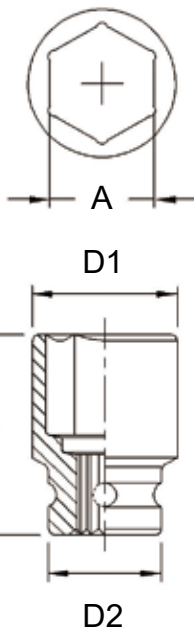

## #5 Spline Dr. SAE Impact Sockets

Item No.	A inch	D1 mm	D2 mm	Length mm	Weight g	PCS 	G.W. KGS	CUFT 
567028	7/8	38	60	70	680	24	17.0	0.44
567030	15/16	40	60	70	700	24	18.0	0.44
567032	1	42	60	70	720	24	18.5	0.44
567034	1-1/16	44	60	70	730	24	18.5	0.44
567036	1-1/8	46	60	70	750	24	19.0	0.44
567038	1-3/16	48	60	70	760	24	19.0	0.44
567040	1-1/4	50	60	75	810	24	20.5	0.44
567042	1-5/16	52	60	75	820	24	21.0	0.44
567044	1-3/8	54	60	77	840	24	22.0	0.44
567046	1-7/16	56	60	77	870	24	22.5	0.44
567048	1-1/2	58	60	81	920	24	23.5	0.44
567050	1-9/16	60	60	81	950	24	24.0	0.44
567052	1-5/8	62	60	81	1030	10	11.0	0.31
567054	1-11/16	64	60	81	1050	10	11.5	0.31
567056	1-3/4	66	60	86	1150	10	12.5	0.31
567058	1-13/16	68	60	86	1200	10	13.5	0.31
567060	1-7/8	70	60	89	1260	10	14.0	0.31
567062	1-15/16	72	60	89	1340	6	9.0	0.41
567064	2	74	60	89	1400	6	9.5	0.41
567068	2-1/8	78	60	94	1600	6	11.0	0.41
567070	2-3/16	80	60	95	1700	6	11.5	0.41
567072	2-1/4	82	60	98	1830	6	12.0	0.41
567076	2-3/8	86	60	100	2000	6	13.5	0.41
567080	2-1/2	90	60	100	2050	6	14.0	0.41
567084	2-5/8	94	60	105	2380	6	15.5	0.41
567088	2-3/4	98	60	105	2420	6	16.0	0.41
567096	3	106	60	105	3030	6	19.5	0.41





## #5 Spline Dr. Metric & SAE Budd Wheel Sockets

ITEM NO.	A Square	D1 mm	D2 mm	Length mm	Weight g	PCS 	G.W. KGS	CUFT 
546017S	17mm	40	60	70	750	24	19.0	0.44
546019S	19mm	42	60	70	750	24	19.0	0.44
546020S	20mm	43	60	70	760	24	19.0	0.44
546021S	21mm	44	60	70	760	24	19.0	0.44
566024S	3/4"	42	60	70	750	24	19.0	0.44
566026S	13/16"	44	60	70	850	24	19.5	0.44
566030S	15/16"	48	60	70	890	24	20.0	0.44

6 pt.



## #5 Spline Dr. SAE Deep Budd Wheel Sockets

ITEM NO.	A Hex	D1 mm	D2 mm	Length mm	Weight g	PCS 	G.W. KGS	CUFT 
569548B	1-1/2"	58	60	115	1330	10	14.5	0.30

6 pt.

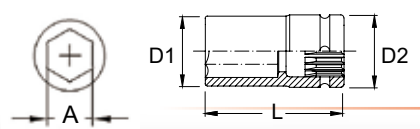



Made of Chrome Molybdenum Steel

Impact Sockets







## #5 Spline Dr. Metric Deep Impact Sockets

Item No.	A mm	D1 mm	D2 mm	Length mm	Weight g	PCS 	G.W. KGS	CUFT 
549522	22	38	60	100	820	20	19.5	0.52
549524	24	40	60	100	850	20	20.0	0.52
549525	25	42	60	100	890	20	20.5	0.52
549527	27	44	60	100	920	20	21.0	0.52
549529	29	46	60	100	960	20	21.0	0.52
549530	30	48	60	100	990	20	22.0	0.52
549532	32	50	60	100	1030	20	22.5	0.52
549533	33	52	60	100	1110	10	12.0	0.31
549535	35	54	60	100	1150	10	12.5	0.31
549538	38	58	60	100	1190	10	13.0	0.31
549541	41	62	60	100	1270	10	14.0	0.31
549546	46	68	60	110	1400	10	15.0	0.31



6  
pt.

## #5 Spline Dr. SAE Deep Impact Sockets

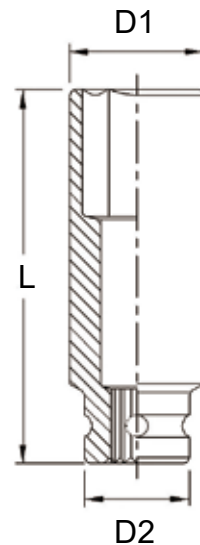
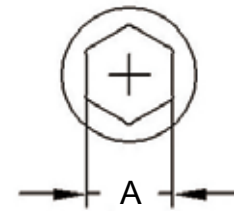
Item No.	A inch	D1 mm	D2 mm	Length mm	Weight g	PCS 	G.W. KGS	CUFT 
569528	7/8	38	60	100	820	20	19.5	0.52
569530	15/16	40	60	100	850	20	20.0	0.52
569532	1	42	60	100	890	20	20.5	0.52
569534	1-1/16	44	60	100	920	20	21.0	0.52
569536	1-1/8	46	60	100	960	20	21.0	0.52
569538	1-3/16	48	60	100	990	20	22.0	0.52
569540	1-1/4	50	60	100	1030	20	22.5	0.52
569542	1-5/16	52	60	100	1060	10	11.5	0.31
569544	1-3/8	54	60	100	1100	10	12.0	0.31
569546	1-7/16	56	60	100	1140	10	12.5	0.31
569548	1-1/2	58	60	100	1180	10	13.0	0.31
569550	1-9/16	60	60	100	1200	10	13.0	0.31
569552	1-5/8	62	60	100	1230	10	13.5	0.31
569554	1-11/16	64	60	100	1250	10	14.0	0.31
569556	1-3/4	66	60	105	1280	10	14.5	0.31
569558	1-13/16	68	60	110	1400	10	15.0	0.31
569560	1-7/8	70	60	110	1500	10	16.0	0.31
569562	1-15/16	72	60	110	1600	6	11.5	0.31
569564	2	74	60	110	1700	6	12.5	0.31
569568	2-1/8	78	60	110	1800	6	13.0	0.31
569570	2-3/16	80	60	120	2100	6	13.5	0.31
569572	2-1/4	82	60	120	2200	6	15.0	0.31
569576	2-3/8	86	60	120	2400	6	16.0	0.31
569580	2-1/2	90	60	130	2600	6	18.0	0.31
569584	2-5/8	94	60	130	3050	6	19.0	0.31
569588	2-3/4	98	60	135	3400	3	10.5	0.31
569596	3	106	60	150	4450	3	15.0	0.31



## #5 Spline Dr. Deep Thin Wall Impact Sockets

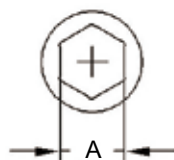

ITEM NO.	A Hex	D1 mm	D2 mm	Length mm	Weight g	PCS 	G.W. KGS	CUFT 
569534T	1-1/16"	40	60	100	850	10	10.0	0.31
569536T	1-1/8"	42	60	100	910	10	10.5	0.31
569540T	1-1/4"	46	60	100	950	10	10.5	0.31

6  
pt.

# #5 Spline Drive Impact Sockets



5

## Impact Adapters

Item No.	Female Drive	Male Drive	Length mm	Weight g	PCS 	G.W. KGS	CUFT 
841005	1"	#5	100	1050	20	22.0	0.34
540508	#5	1"	80	768	30	24.0	0.52





## Impact Universal Joint

Item No.	Outside Diameter	Length mm	Weight g	PCS 	G.W. KGS	CUFT 
540505	60mm	160	1710	10	18.0	0.41





## Impact Extension Bars

Item No.	Length mm	Weight g	PCS 	G.W. KGS	CUFT 
540200	200	2140	5	12.0	0.30
540380	380	4000	5	21.0	0.39



## TR-511S 11 Piece #5 Spline Dr. SAE Truck Wheel Impact Socket Set

Item No.	Size	Item No.	Size
<b>#5 Spline Dr. 6pt Impact Socket:</b>			
567028	7/8"	567032	1"
567030	15/16"	567038	1-3/16"
<b>#5 Spline Dr. 6pt Deep Impact Socket:</b>			
569556	1-3/4"		
<b>#5 Spline Dr. 6pt Deep Thin Wall Impact Socket:</b>			
569534T	1-1/16"	569540T	1-1/4"
569536T	1-1/8"		
<b>#5 Spline Dr. Budd Wheel Impact Socket:</b>			
566026S	13/16"	566030S	15/16"
<b>#5 Spline Dr. Deep Budd Wheel Impact Socket:</b>			
569548B	1-1/2"	Blow Case	

 10.7 Kg  2 sets / 22.5 Kgs / 0.95 CUFT





6 pt.



## TR-511MS 11 Piece #5 Spline Dr. Metric & SAE Truck Wheel Impact Socket Set

Item No.	Size	Item No.	Size
<b>#5 Spline Dr. 6pt Deep Impact Socket:</b>			
549533	33mm	549538	38mm
549535	35mm	549541	41mm
<b>#5 Spline Dr. 6pt Deep Thin Wall Impact Socket:</b>			
569534T	1-1/16"	569540T	1-1/4"
569536T	1-1/8"		
<b>#5 Spline Dr. Budd Wheel Impact Socket:</b>			
546017S	17mm	566026S	13/16"
546021S	21mm		
<b>#5 Spline Dr. Deep Budd Wheel Impact Socket:</b>			
569548B	1-1/2"	Blow Case	

 11.8 Kg  2 sets / 24.5 Kgs / 0.95 CUFT



6 pt.



- These #5 Spline Dr. impact socket sets designed for servicing truck wheels.
- The most popular SAE and Metric impact socket sizes for truck wheel fasteners.
- 4-Point impact sockets for inner Budd-style square fasteners on truck wheels.
- Special 1-1/2" Hex deep impact socket designed for outer cap nuts on Budd-style truck wheels.
- Deep Thin Wall impact sockets designed for truck wheel servicing when removing Dayton Style Lug Nuts that are deeply recessed and where space is very limited.
- Metric impact socket set for servicing tired and wheels on a complete range of European and Japanese trucks with metric wheel fasteners.

Impact Sockets

**GENIUS<sup>®</sup>**

*Hand Sockets*



**GENIUS TOOLS**  
[www.geniustools.net](http://www.geniustools.net)

## Metric Hand Sockets

Item No.	A mm	D1 mm	D2 mm	Length mm	Weight g	PCS	G.W. KGS	CUFT
						inner/ctn		
222503	3	5.4	12	25	9	20 / 600	7.0	0.38
222504	4	6.7	12	25	9	20 / 600	7.0	0.38
2225045	4.5	7.3	12	25	9	20 / 600	7.0	0.38
222505	5	7.9	12	25	10	20 / 600	7.5	0.38
2225055	5.5	8.5	12	25	10	20 / 600	7.5	0.38
222506	6	9.2	12	25	11	20 / 600	8.0	0.38
222507	7	10.7	12	25	11	20 / 600	8.5	0.38
222508	8	12.0	12	25	12	20 / 600	9.0	0.38
222509	9	13.0	13	25	14	20 / 600	10.5	0.38
222510	10	14.0	14	25	16	20 / 600	11.0	0.38
222511	11	16.0	16	25	20	20 / 600	15.0	0.38
222512	12	17.0	17	25	25	20 / 400	12.0	0.39
222513	13	18.0	18	25	25	20 / 400	12.0	0.39
222514	14	20.0	20	25	35	20 / 400	16.0	0.39

6 pt.



## SAE Hand Sockets

Item No.	A inch	D1 mm	D2 mm	Length mm	Weight g	PCS	G.W. KGS	CUFT
						inner/ctn		
282504	1/8	5.6	12	25	9	20 / 600	7.0	0.38
282506	3/16	7.6	12	25	9	20 / 600	7.0	0.38
282507	7/32	8.6	12	25	10	20 / 600	7.5	0.38
282508	1/4	9.6	12	25	11	20 / 600	8.0	0.38
282509	9/32	10.9	12	25	12	20 / 600	8.5	0.38
282510	5/16	12.0	12	25	12	20 / 600	9.0	0.38
282511	11/32	13.0	13	25	15	20 / 600	11.0	0.38
282512	3/8	14.0	14	25	17	20 / 600	11.5	0.38
282514	7/16	16.0	16	25	20	20 / 600	13.5	0.38
282516	1/2	18.0	18	25	25	20 / 600	17.0	0.38
282518	9/16	20.0	20	25	35	20 / 400	16.0	0.39

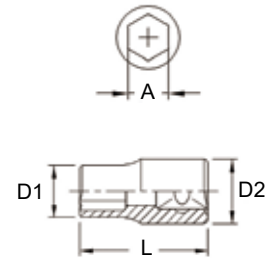

## Metric Deep Hand Sockets

Item No.	A size	D1 mm	D2 mm	Length mm	Weight g	PCS	G.W. KGS	CUFT
						inner/ctn		
225204	4	6.7	12.0	50	16	10 / 200	4.5	0.39
2252045	4.5	7.3	12.0	50	17	10 / 200	4.5	0.39
225205	5	7.9	12.0	50	18	10 / 200	4.5	0.39
2252055	5.5	8.5	12.0	50	19	10 / 200	4.5	0.39
225206	6	9.2	12.0	50	20	10 / 200	5.0	0.39
225207	7	10.7	12.0	50	20	10 / 200	5.0	0.39
225208	8	11.8	11.2	50	20	10 / 200	5.0	0.39
225209	9	12.8	12.0	50	25	10 / 200	6.0	0.39
225210	10	14.3	12.5	50	30	10 / 200	7.0	0.39
225211	11	15.8	13.0	50	35	10 / 200	8.0	0.39
225212	12	16.8	13.5	50	35	10 / 200	8.5	0.39
225213	13	18.8	14.0	50	50	10 / 200	11.5	0.60
225214	14	19.8	14.5	50	50	10 / 200	11.5	0.60

6 pt.



## SAE Deep Hand Sockets

Item No.	A inch	D1 mm	D2 mm	Length mm	Weight g	PCS	G.W. KGS	CUFT
						inner/ctn		
285206	3/16	7.6	12.0	50	17	10 / 200	4.5	0.39
285207	7/32	8.6	12.0	50	17	10 / 200	4.5	0.39
285208	1/4	9.6	12.0	50	20	10 / 200	5.0	0.39
285209	9/32	10.9	12.0	50	20	10 / 200	5.0	0.39
285210	5/16	11.8	11.2	50	20	10 / 200	5.0	0.39
285211	11/32	12.8	12.0	50	25	10 / 200	6.0	0.39
285212	3/8	13.8	12.5	50	30	10 / 200	7.0	0.39
285214	7/16	15.8	13.0	50	30	10 / 200	7.0	0.39
285216	1/2	17.8	14.0	50	40	10 / 200	9.5	0.60
285218	9/16	19.8	15.0	50	45	10 / 200	11.0	0.60

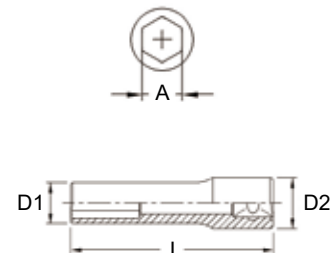



# Hand Sockets

## Metric Hand Sockets (12-Point)

Item No.	A mm	D1 mm	D2 mm	Length mm	Weight g	PCS	G.W. KGS	CUFT
						inner/ctn		
232505	5	7.9	12	25	10	20 / 600	7.5	0.38
2325055	5.5	8.5	12	25	10	20 / 600	8.0	0.38
232506	6	9.2	12	25	11	20 / 600	8.0	0.38
232507	7	10.7	12	25	11	20 / 600	8.5	0.38
232508	8	12.0	12	25	12	20 / 600	9.0	0.38
232509	9	13.0	13	25	13	20 / 600	10.0	0.38
232510	10	14.0	14	25	15	20 / 600	11.0	0.38
232511	11	16.0	16	25	20	20 / 600	13.5	0.38
232512	12	17.0	17	25	20	20 / 400	11.5	0.39
232513	13	18.0	18	25	25	20 / 400	13.0	0.39
232514	14	20.0	20	25	30	20 / 400	16.0	0.39



12 pt.

## SAE Hand Sockets (12-Point)

Item No.	A mm	D1 mm	D2 mm	Length mm	Weight g	PCS	G.W. KGS	CUFT
						inner/ctn		
272506	3/16	7.6	12	25	10	20 / 600	7.5	0.38
272507	7/32	8.6	12	25	10	20 / 600	8.0	0.38
272508	1/4	9.6	12	25	11	20 / 600	8.5	0.38
272509	9/32	10.9	12	25	11	20 / 600	8.5	0.38
272510	5/16	12.0	12	25	12	20 / 600	9.0	0.38
272511	11/32	13.0	13	25	14	20 / 600	10.5	0.38
272512	3/8	14.0	14	25	16	20 / 600	11.0	0.38
272514	7/16	16.0	16	25	20	20 / 600	13.5	0.38
272516	1/2	18.0	18	25	25	20 / 600	18.0	0.38
272518	9/16	20.0	20	25	30	20 / 400	15.5	0.39

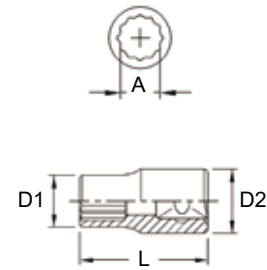

## Metric Deep Hand Sockets (12-Point)

Item No.	A mm	D1 mm	D2 mm	Length mm	Weight g	PCS	G.W. KGS	CUFT
						inner/ctn		
235205	5	7.9	12.0	50	17	10 / 200	5.0	0.39
2352055	5.5	8.5	12.0	50	17	10 / 200	5.0	0.39
235206	6	9.2	12.0	50	18	10 / 200	5.0	0.39
235207	7	10.7	12.0	50	20	10 / 200	5.5	0.39
235208	8	11.8	11.2	50	20	10 / 200	5.5	0.39
235209	9	12.8	12.0	50	25	10 / 200	6.0	0.39
235210	10	14.3	12.5	50	30	10 / 200	7.5	0.39
235211	11	15.8	13.0	50	30	10 / 200	7.5	0.39
235212	12	16.8	13.5	50	35	10 / 200	8.5	0.39
235213	13	18.8	14.0	50	45	10 / 200	10.5	0.60
235214	14	19.8	14.5	50	45	10 / 200	10.5	0.60



12 pt.

## SAE Deep Hand Sockets (12-Point)

Item No.	A inch	D1 mm	D2 mm	Length mm	Weight g	PCS	G.W. KGS	CUFT
						inner/ctn		
275206	3/16	7.6	12.0	50	17	10 / 200	5.0	0.39
275207	7/32	8.6	12.0	50	17	10 / 200	5.0	0.39
275208	1/4	9.6	12.0	50	20	10 / 200	6.0	0.39
275209	9/32	10.9	12.0	50	20	10 / 200	6.0	0.39
275210	5/16	11.8	11.2	50	20	10 / 200	6.0	0.39
275211	11/32	12.8	12.0	50	25	10 / 200	6.5	0.39
275212	3/8	13.8	12.5	50	30	10 / 200	7.5	0.39
275214	7/16	15.8	13.0	50	30	10 / 200	7.5	0.39
275216	1/2	17.8	14.0	50	40	10 / 200	9.5	0.60
275218	9/16	19.8	15.0	50	45	10 / 200	10.5	0.60

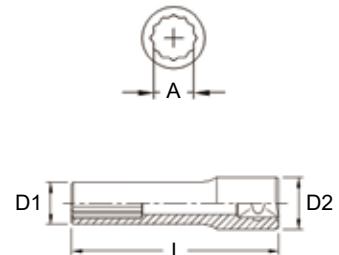



## E-Star Hand Sockets

Item No.	A Size	D1 mm	D2 mm	Length mm	Weight g	PCS	G.W. KGS	CUFT
						inner/ctn		
252504	E-4	6.0	12	22	9	20 / 600	7.0	0.38
252505	E-5	7.1	12	22	10	20 / 600	7.0	0.38
252506	E-6	8.3	12	22	10	20 / 600	7.0	0.38
252507	E-7	9.0	12	22	10	20 / 600	7.5	0.38
252508	E-8	10.5	12	22	12	20 / 600	8.0	0.38
252510	E-10	13.0	13	22	15	20 / 600	11.0	0.38
252511	E-11	14.0	14	22	20	20 / 600	13.5	0.38

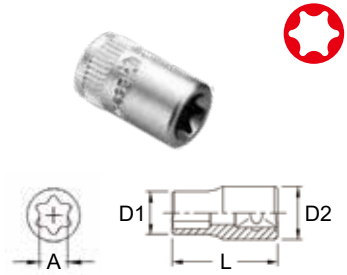

**NEW**

## E-Star Deep Hand Sockets

Item No.	A Size	D1 mm	D2 mm	Length mm	Weight g	PCS	G.W. KGS	CUFT
						inner/ctn		
255204	E-4	6.0	12	50	17	10 / 200	4.5	0.39
255205	E-5	7.1	12	50	18	10 / 200	4.5	0.39
255206	E-6	8.3	12	50	20	10 / 200	5.0	0.39
255207	E-7	9.0	12	50	20	10 / 200	5.0	0.39
255208	E-8	10.5	12	50	20	10 / 200	5.0	0.39
255210	E-10	12.0	13	50	25	10 / 200	6.0	0.39
255211	E-11	13.0	14	50	30	10 / 200	7.0	0.39

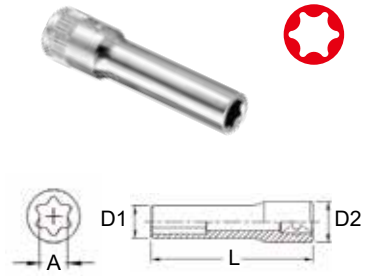

## Metric & SAE Universal Hand Sockets (12-Point)

Item No.	A size	D1 mm	D2 mm	Length mm	Weight g	PCS	G.W. KGS	CUFT
						inner/ctn		
253506	6	9.2	14	33	20	10 / 200	5.5	0.60
253507	7	10.5	14	33	20	10 / 200	5.5	0.60
253508	8	12.0	14	34	20	10 / 200	5.5	0.60
253509	9	13.0	14	34	20	10 / 200	5.5	0.60
253510	10	14.0	14	35	20	10 / 200	5.5	0.60
253511	11	16.0	14	36	25	10 / 200	6.0	0.60
253512	12	17.0	14	37	25	10 / 200	6.5	0.60
253513	13	18.0	14	37	25	10 / 200	7.0	0.60
253514	14	19.0	14	37	25	10 / 200	7.0	0.60
263708	1/4	9.7	14	33	20	10 / 200	5.5	0.60
263710	5/16	12.0	14	34	20	10 / 200	5.5	0.60
263712	3/8	14.0	14	35	20	10 / 200	6.0	0.60
263714	7/16	16.0	14	36	25	10 / 200	6.0	0.60
263716	1/2	18.0	14	37	25	10 / 200	7.0	0.60
263718	9/16	19.0	14	37	25	10 / 200	7.0	0.60

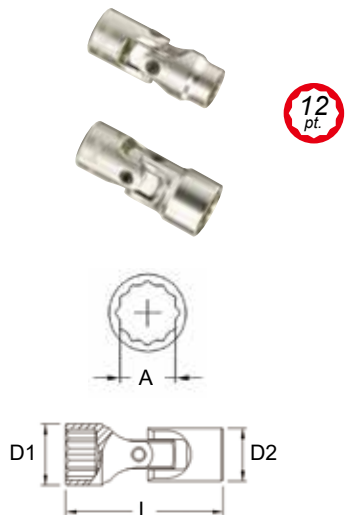

## Slotted Head Hand Sockets

Item No.	A mm	D mm	Length mm	Weight g	PCS	G.W. KGS	CUFT
					inner/ctn		
222640	0.8 x 4.0	12	25	9	20 / 600	7.5	0.38
222655	1.0 x 5.5	12	25	10	20 / 600	8.0	0.38
222665	1.2 x 6.5	12	25	11	20 / 600	8.5	0.38
222680	1.2 x 8.0	12	25	11	20 / 600	8.5	0.38
222685	1.6 x 8.5	12	25	11	20 / 600	8.5	0.38
222695	1.6 x 9.7	12	25	12	20 / 600	9.5	0.38

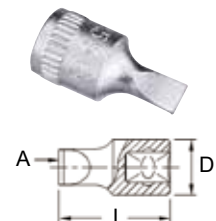

## Philips Head Hand Sockets

Item No.	A size	D mm	Length mm	Weight g	PCS	G.W. KGS	CUFT
					inner/ctn		
222601	#1	12	25	9	20 / 600	7.5	0.38
222602	#2	12	25	10	20 / 600	8.0	0.38
222603	#3	12	25	11	20 / 600	8.5	0.38
222604	#4	12	25	12	20 / 600	9.5	0.38

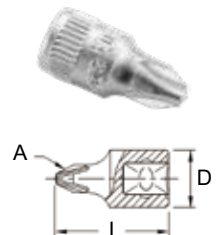



## Metric & SAE Hex Head Hand Sockets

Item No.	A size	D mm	Length mm	Weight g	PCS	G.W. KGS	CUFT
					inner/ctn		
232803	3	12	25	9	20 / 600	7.0	0.38
232804	4	12	25	10	20 / 600	7.0	0.38
232805	5	12	25	11	20 / 600	8.0	0.38
232806	6	12	25	12	20 / 600	8.0	0.38
232807	7	12	25	13	20 / 600	9.0	0.38
232808	8	12	25	14	20 / 600	9.5	0.38
232809	9	12	25	15	20 / 600	10.0	0.38
232810	10	12	25	16	20 / 600	11.0	0.38
272804	1/8	12	25	9	20 / 600	7.5	0.38
272805	5/32	12	25	10	20 / 600	7.5	0.38
272806	3/16	12	25	10	20 / 600	7.5	0.38
272807	7/32	12	25	11	20 / 600	8.0	0.38
272808	1/4	12	25	12	20 / 600	9.0	0.38
272809	9/32	12	25	12	20 / 600	9.0	0.38
272810	5/16	12	25	12	20 / 600	9.5	0.38
272812	3/8	12	25	14	20 / 600	9.5	0.38

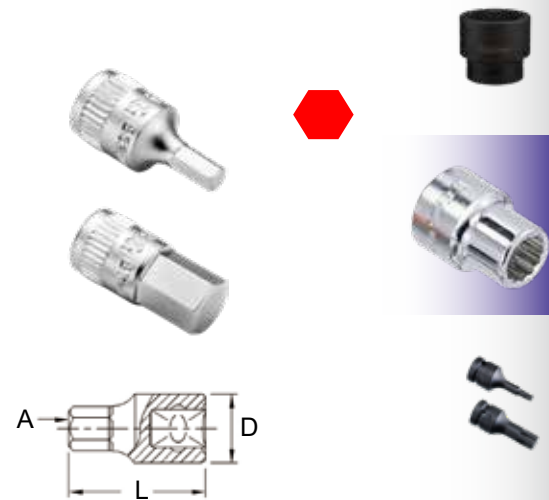

## Double Square Hand Sockets (8-Point)

Item No.	A size	D1 mm	D2 mm	Length mm	Weight g	PCS	G.W. KGS	CUFT
						inner/ctn		
242508	8	14	14	25	18	20 / 400	9.0	0.39
242510	10	17	17	25	25	20 / 400	12.0	0.39
262508	1/4"	12	12	25	12	20 / 400	6.0	0.39
262510	5/16"	14	14	25	17	20 / 400	9.0	0.39
262512	3/8"	17	17	25	30	20 / 400	13.0	0.39

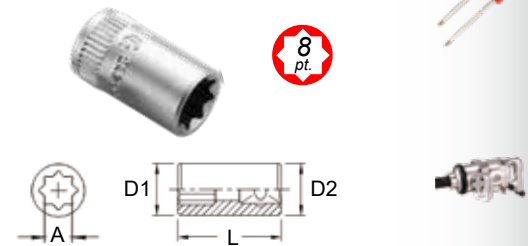

## 72 Teeth Reversible Ratchet

Item No.	Length mm	Weight g	PCS inner/ctn	G.W. KGS	CUFT
280272	140	130	20 / 120	15.5	0.92

## 72 Teeth Reversible Ratchet

Item No.	Length mm	Weight g	PCS inner/ctn	G.W. KGS	CUFT
280272P	160	130	20 / 160	22.0	1.60

## 72 Teeth Reversible Ratchet

Item No.	Length mm	Weight g	PCS inner/ctn	G.W. KGS	CUFT
280272S	165	140	1 / 50	8.0	0.30

## 36 Teeth Ratchet w/ Quick Release

Item No.	Length mm	Weight g	PCS inner/ctn	G.W. KGS	CUFT
280231R	130	130	1 / 100	15.5	0.44

## 36 Teeth Ratchet w/ Quick Release

Item No.	Length mm	Weight g	PCS inner/ctn	G.W. KGS	CUFT
280231P	160	130	1 / 50	8.0	0.30

## 36 Teeth Ratchet w/ Quick Release

Item No.	Length mm	Weight g	PCS inner/ctn	G.W. KGS	CUFT
280231S	165	140	30 / 60	9.5	0.48

## 24 Teeth Reversible Ratchet

Item No.	Length mm	Weight g	PCS inner/ctn	G.W. KGS	CUFT
280222R	140	140	40 / 160	23.0	1.50



## 72 Teeth 1/4 & 3/8" Double Drive Ratchet

Item No.	Length mm	Weight g	PCS inner/ctn	G.W. KGS	CUFT
380371	140	270	5 / 60	18.0	1.65



## Hinge Handle

Item No.	Length mm	Weight g	PCS inner/ctn	G.W. KGS	CUFT
280226	155	100	10 / 120	13.0	0.30



## Hinge Handle

Item No.	Length mm	Weight g	PCS inner/ctn	G.W. KGS	CUFT
280226A	150	110	10 / 100	13.0	0.30



## Hinge Handle

Item No.	Length mm	Weight g	PCS inner/ctn	G.W. KGS	CUFT
280226P	180	110	5 / 100	12.0	0.59



## Hinge Handle

Item No.	Length mm	Weight g	PCS inner/ctn	G.W. KGS	CUFT
280226S	180	110	5 / 100	12.0	0.59



## 72 Teeth Rotor Ratchet

Item No.	Length mm	Weight g	PCS inner/ctn	G.W. KGS	CUFT
281802	145	120	20 / 80	12.5	0.59



## 72 Teeth Rotor Ratchet

Item No.	Length mm	Weight g	PCS inner/ctn	G.W. KGS	CUFT
281802P	165	130	30 / 60	10.5	0.48



## 72 Teeth Rotor Ratchet

Item No.	Length mm	Weight g	PCS inner/ctn	G.W. KGS	CUFT
281802S	175	175	20 / 40	7.5	0.48



## 72 Teeth Flex Head Ratchet

Item No.	Length mm	Weight g	PCS inner/ctn	G.W. KGS	CUFT
282262	170	160	30 / 60	10.5	0.48



## 72 Teeth Flex Head Ratchet

Item No.	Length mm	Weight g	PCS inner/ctn	G.W. KGS	CUFT
282262P	190	160	30 / 60	10.5	0.48



## 72 Teeth Flex Head Ratchet

Item No.	Length mm	Weight g	PCS inner/ctn	G.W. KGS	CUFT
282262S	195	190	20 / 40	8.0	0.48

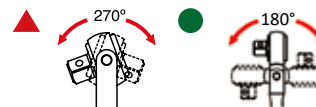





## Socket Driver

Item No.	Length mm	Weight g	PCS inner/ctn	G.W. KGS	CUFT
220150	140	70	5 / 100	8.0	0.59

## Folding Socket Driver

Item No.	Length mm	Weight g	PCS inner/ctn	G.W. KGS	CUFT
220160	180	110	5 / 100	12.5	0.59

## Socket Driver

Item No.	Length mm	Weight g	PCS inner/ctn	G.W. KGS	CUFT
506+0175	175	110	5 / 50	6.5	0.62

## Universal Joint

Item No.	Length mm	Weight g	PCS inner/ctn	G.W. KGS	CUFT
280070	40	35	20 / 400	13.0	0.39

## Bit Holders

Item No.	Hex Shank	Length mm	Weight g	PCS inner/ctn	G.W. KGS	CUFT
282408	1/4"	25	13	20 / 600	8.5	0.38
283508	1/4"	35	19	10 / 300	7.0	0.38
283510	5/16"	35	20	10 / 300	8.0	0.38

## Adapter

Item No.	Female Drive	Male Drive	Length mm	Weight g	PCS inner/ctn	G.W. KGS	CUFT
280030	1/4"	3/8"	25	15.0	20 / 600	10.0	0.38

## Sliding T-Handle

Item No.	Length mm	Weight g	PCS inner/ctn	G.W. KGS	CUFT
280020	150	65	10 / 200	12.5	0.52

## Extension Bars

Item No.	Length mm	Weight g	PCS inner/ctn	G.W. KGS	CUFT
220002	50	25	25 / 400	11.0	0.30
220003	75	35	25 / 400	15.0	0.30
220004	100	45	20 / 240	12.0	0.30
220006	150	65	20 / 240	17.0	0.30
220009	225	95	20 / 200	20.5	0.41
220012	300	125	15 / 180	24.0	0.52

## Wobble Extension Bars

Item No.	Length mm	Weight g	PCS inner/ctn	G.W. KGS	CUFT
220002B	50	25	25 / 400	11.0	0.30
<b>NEW</b> 220003B	75	35	25 / 400	15.0	0.30
220004B	100	45	20 / 240	12.0	0.30
220006B	150	65	20 / 240	17.0	0.30
220009B	225	95	20 / 200	20.0	0.41
<b>NEW</b> 220012B	300	125	15 / 180	24.0	0.52

## BE-22406 3 Piece 1/4" Dr. Wobble Extension Bar Set

Item No.	Size
220002B	50mmL (2"L)
220004B	100mmL (4"L)
220006B	150mmL (6"L)

Sliding Card

130 g 20x8 160 sets / 22 Kgs / 1.6 CUFT



## US-209M 9 Piece 1/4" Dr. Metric Universal Hand Socket Set (12-Point)

Item No.	Size	Item No.	Size
<b>1/4" Dr. 12pt Universal Hand Socket:</b>			
253506	6mm	253511	11mm
253507	7mm	253512	12mm
253508	8mm	253513	13mm
253509	9mm	253514	14mm
253510	10mm	Socket Holder	



12 pt.

190 g 20x4 80 sets / 16.5 Kgs / 1.6 CUFT

## US-206S 6 Piece 1/4" Dr. SAE Universal Hand Socket Set (12-Point)

Item No.	Size	Item No.	Size
<b>1/4" Dr. 12pt Universal Hand Socket:</b>			
263708	1/4"	263714	7/16"
263710	5/16"	263716	1/2"
263712	3/8"	263718	9/16"
Socket Holder			



12 pt.

140 g 15x8 120 sets / 18 Kgs / 1.6 CUFT

## TW-211M 11 Piece 1/4" Dr. Metric Hand Socket Set (12-Point)

Item No.	Size	Item No.	Size
<b>1/4" Dr. 12pt Hand Socket:</b>			
232505	5mm	232510	10mm
2325055	5.5mm	232511	11mm
232506	6mm	232512	12mm
232507	7mm	232513	13mm
232508	8mm	232514	14mm
232509	9mm	Socket Holder	



12 pt.

240 g 10x6 60 sets / 15.5 Kgs / 1.58 CUFT

## TW-210S 10 Piece 1/4" Dr. SAE Hand Socket Set (12-Point)

Item No.	Size	Item No.	Size
<b>1/4" Dr. 12pt Hand Socket:</b>			
272506	3/16"	272511	11/32"
272507	7/32"	272512	3/8"
272508	1/4"	272514	7/16"
272509	9/32"	272516	1/2"
272510	5/16"	272518	9/16"
Socket Holder			



12 pt.

210 g 10x6 60 sets / 14 Kgs / 1.58 CUFT

## TW-211MD 11 Piece 1/4" Dr. Metric Deep Hand Socket Set (12-Point)

Item No.	Size	Item No.	Size
<b>1/4" Dr. 12pt Deep Hand Socket:</b>			
235205	5mm	235210	10mm
2352055	5.5mm	235211	11mm
235206	6mm	235212	12mm
235207	7mm	235213	13mm
235208	8mm	235214	14mm
235209	9mm	Socket Holder	



12 pt.

370 g 5x4 20 sets / 8.5 Kgs / 0.71 CUFT



# Hand Socket Sets

## TW-210SD 10 Piece 1/4" Dr. SAE Deep Hand Socket Set (12-Point)

Item No.	Size	Item No.	Size
<b>1/4" Dr. 12pt Deep Hand Socket:</b>			
275206	3/16"	275211	11/32"
275207	7/32"	275212	3/8"
275208	1/4"	275214	7/16"
275209	9/32"	275216	1/2"
275210	5/16"	275218	9/16"
Socket Holder			

320 g 5x4 20 sets / 8.5 Kgs / 0.71 CUFT



12 pt.

## GS-214M 14 Piece 1/4" Dr. Metric Hand Socket Set

Item No.	Size	Item No.	Size
<b>1/4" Dr. 6pt Hand Socket:</b>			
222503	3mm	222508	8mm
222504	4mm	222509	9mm
2225045	4.5mm	222510	10mm
222505	5mm	222511	11mm
2225055	5.5mm	222512	12mm
222506	6mm	222513	13mm
222507	7mm	222514	14mm
Socket Holder			

285 g 10x6 60 sets / 18 Kgs / 1.58 CUFT



NEW

6 pt.

## GS-211S 11 Piece 1/4" Dr. SAE Hand Socket Set

Item No.	Size	Item No.	Size
<b>1/4" Dr. 6pt Hand Socket:</b>			
282504	1/8"	282511	11/32"
282506	3/16"	282512	3/8"
282507	7/32"	282514	7/16"
282508	1/4"	282516	1/2"
282509	9/32"	282518	9/16"
282510	5/16"	Socket Holder	

225 g 10x6 60 sets / 14.5 Kgs / 1.58 CUFT



NEW

6 pt.

## GD-211M 11 Piece 1/4" Dr. Metric Deep Hand Socket Set

Item No.	Size	Item No.	Size
<b>1/4" Dr. 6pt Deep Hand Socket:</b>			
225204	4mm	225209	9mm
225205	5mm	225210	10mm
2252055	5.5mm	225211	11mm
225206	6mm	225212	12mm
225207	7mm	225213	13mm
225208	8mm	Socket Holder	

400 g 5x4 20 sets / 9 Kgs / 0.71 CUFT



6 pt.

## GD-210S 10 Piece 1/4" Dr. SAE Deep Hand Socket Set

Item No.	Size	Item No.	Size
<b>1/4" Dr. 6pt Deep Hand Socket:</b>			
285206	3/16"	285211	11/32"
285207	7/32"	285212	3/8"
285208	1/4"	285214	7/16"
285209	9/32"	285216	1/2"
285210	5/16"	285218	9/16"
Socket Holder			

360 g 5x4 20 sets / 8.5 Kgs / 0.71 CUFT



6 pt.

## GD-220M 20 Piece 1/4" Dr. Metric Deep Hand Socket Set

Item No.	Size	Item No.	Size
<b>1/4" Dr. 6pt Deep Hand Socket:</b>			
225204	4mm	225209	9mm
2252045	4.5mm	225210	10mm
225205	5mm	225211	11mm
2252055	5.5mm	225212	12mm
225206	6mm	225213	13mm
225207	7mm	225214	14mm
225208	8mm		

### 1/4" Dr. Accessory:

220150	Socket Driver	220002	Extension Bar, 50mmL
280070	Universal Joint	220004	Extension Bar, 100mmL
280020	Sliding T-Handle	280226A	Hinge Handle
280222R	24T Reversible Ratchet		
Metal Box			

1400 g 10 sets / 15 Kgs / 0.77 CUFT



6 pt.

## GD-217S 17 Piece 1/4" Dr. SAE Deep Hand Socket Set

Item No.	Size	Item No.	Size
<b>1/4" Dr. 6pt Deep Hand Socket:</b>			
285206	3/16"	285211	11/32"
285207	7/32"	285212	3/8"
285208	1/4"	285214	7/16"
285209	9/32"	285216	1/2"
285210	5/16"	285218	9/16"

### 1/4" Dr. Accessory:

220150	Socket Driver	220002	Extension Bar, 2"L
280070	Universal Joint	220004	Extension Bar, 4"L
280020	Sliding T-Handle	280226A	Hinge Handle
280222R	24T Reversible Ratchet		
Metal Box			

1350 g 10 sets / 14.5 Kgs / 0.77 CUFT



6 pt.

## GS-220M 20 Piece 1/4" Dr. Metric Hand Socket Set

Item No.	Size	Item No.	Size
<b>1/4" Dr. 6pt Hand Socket:</b>			
222503	3mm	222508	8mm
222504	4mm	222509	9mm
2225045	4.5mm	222510	10mm
222505	5mm	222511	11mm
222506	6mm	222512	12mm
222507	7mm		

### 1/4" Dr. Double Square Hand Socket:

242508	8mm	242510	10mm
--------	-----	--------	------

### 1/4" Dr. Accessory:

220150	Socket Driver	220002	Extension Bar, 50mmL
280070	Universal Joint	220004	Extension Bar, 100mmL
280226A	Hinge Handle		
280020	Sliding T-Handle		
280222R	24T Reversible Ratchet		
Metal Box			

1250 g 10 sets / 13.5 Kgs / 0.77 CUFT



6 pt.

Hand Sockets



# Hand Socket Sets

## GS-217M 17 Piece 1/4" Dr. Metric Hand Socket Set

Item No.	Size	Item No.	Size
<b>1/4" Dr. 6pt Hand Socket:</b>			
222503	3mm	222508	8mm
222504	4mm	222509	9mm
2225045	4.5mm	222510	10mm
222505	5mm	222511	11mm
2225055	5.5mm	222512	12mm
222506	6mm	222513	13mm
222507	7mm	222514	14mm
<b>1/4" Dr. Double Square Hand Socket:</b>			
242508	8mm	242510	10mm

750 g      20 sets / 16 Kgs / 0.88 CUFT



6 pt.  
8 pt.

## GS-215S 15 Piece 1/4" Dr. SAE Hand Socket Set

Item No.	Size	Item No.	Size
<b>1/4" Dr. 6pt Hand Socket:</b>			
282504	1/8"	282511	11/32"
282506	3/16"	282512	3/8"
282507	7/32"	282514	7/16"
282508	1/4"	282516	1/2"
282509	9/32"	282518	9/16"
282510	5/16"		
<b>1/4" Dr. Double Square Hand Socket:</b>			
262508	1/4"	262512	3/8"
262510	5/16"		

700 g      20 sets / 15 Kgs / 0.88 CUFT



6 pt.  
8 pt.

## GS-221M 21 Piece 1/4" Dr. Metric Deep Hand Socket Set

Item No.	Size	Item No.	Size
<b>1/4" Dr. 6pt Hand Socket:</b>			
222505	5mm	222509	9mm
2225055	5.5mm	222510	10mm
222506	6mm	222511	11mm
222507	7mm	222512	12mm
222508	8mm	222513	13mm
<b>1/4" Dr. 6pt Deep Hand Socket:</b>			
225206	6mm	225210	10mm
225207	7mm	225211	11mm
225208	8mm	225212	12mm
225209	9mm	225213	13mm
<b>1/4" Dr. Accessory:</b>			
220150	Socket Driver		
220002	Extension Bar, 50mmL		
280272	72T Reversible Ratchet		
Blow Case			

830 g      20 sets / 18 Kgs / 1.5 CUFT



6 pt.

## GS-216S 16 Piece 1/4" Dr. SAE Hand Socket Set

Item No.	Size	Item No.	Size
<b>1/4" Dr. 6pt Hand Socket:</b>			
282504	1/8"	282511	11/32"
282506	3/16"	282512	3/8"
282507	7/32"	282514	7/16"
282508	1/4"	282516	1/2"
282509	9/32"	282518	9/16"
282510	5/16"		

### 1/4" Dr. Double Square Hand Socket:

262508	1/4"	262512	3/8"
262510	5/16"		

### 1/4" Dr. Accessory:

- 280226A Hinge Handle
- 220002 Extension Bar, 2"L
- Metal Box

750 g 20 sets / 16 Kgs / 0.88 CUFT



6 pt.

8 pt.

## GS-218M 18 Piece 1/4" Dr. Metric Hand Socket Set

Item No.	Size	Item No.	Size
<b>1/4" Dr. 6pt Hand Socket:</b>			
222503	3mm	222508	8mm
222504	4mm	222509	9mm
2225045	4.5mm	222510	10mm
222505	5mm	222511	11mm
2225055	5.5mm	222512	12mm
222506	6mm	222513	13mm
222507	7mm	222514	14mm

### 1/4" Dr. Double Square Hand Socket:

242508	8mm	242510	10mm
--------	-----	--------	------

### 1/4" Dr. Accessory:

- 280226A Hinge Handle
- 220002 Extension Bar, 50mmL
- Metal Box

770 g 20 sets / 16.5 Kgs / 0.88 CUFT



6 pt.

8 pt.

## GS-219M 19 Piece 1/4" Dr. Metric Hand Socket Set

Item No.	Size	Item No.	Size
<b>1/4" Dr. 6pt Hand Socket:</b>			
222504	4mm	222508	8mm
2225045	4.5mm	222509	9mm
222505	5mm	222510	10mm
2225055	5.5mm	222511	11mm
222506	6mm	222512	12mm
222507	7mm		

### 1/4" Dr. Double Square Hand Socket:

242508	8mm	242510	10mm
--------	-----	--------	------

### 1/4" Dr. Accessory:

- 220150 Socket Driver
- 280070 Universal Joint
- 280020 Sliding T-Handle
- 280222R 24T Reversible Ratchet
- Metal Box

1150 g 10 sets / 12.5 Kgs / 0.77 CUFT



6 pt.

8 pt.



# Hand Socket Sets

## GS-239M 39 Piece 1/4" Dr. Metric Hand Socket Set

Item No.	Size	Item No.	Size
<b>1/4" Dr. 6pt Hand Socket:</b>			
222503	3mm	222508	8mm
222504	4mm	222509	9mm
2225045	4.5mm	222510	10mm
222505	5mm	222511	11mm
2225055	5.5mm	222512	12mm
222506	6mm	222513	13mm
222507	7mm	222514	14mm
<b>1/4" Dr. Head Hand Socket:</b>			
222601	#1 Philips	222695	1.6 x 9.7mm Slotted
222602	#2 Philips	232803	3mm Hex
222603	#3 Philips	232804	4mm Hex
222604	#4 Philips	232805	5mm Hex
222640	0.8 x 4.0mm Slotted	232806	6mm Hex
222655	1.0 x 5.5mm Slotted	232807	7mm Hex
222665	1.2 x 6.5mm Slotted	232808	8mm Hex
222280	1.2 x 8.0mm Slotted	232809	9mm Hex
222685	1.6 x 8.5mm Slotted	232810	10mm Hex
<b>1/4" Dr. Double Square Hand Socket:</b>			
242508	8mm	242510	10mm
<b>1/4" Dr. Accessory:</b>			
280070	Universal Joint	220004	Extension Bar, 100mmL
280020	Sliding T-Handle	220150	Socket Driver
280222R	24T Reversible Ratchet		
	Metal Box		

1400 g 10 sets / 15 Kgs / 0.77 CUFT

## GS-237S 37 Piece 1/4" Dr. Metric Hand Socket Set

Item No.	Size	Item No.	Size
<b>1/4" Dr. 6pt Hand Socket:</b>			
282504	1/8"	282511	11/32"
282506	3/16"	282512	3/8"
282507	7/32"	282514	7/16"
282508	1/4"	282516	1/2"
282509	9/32"	282518	9/16"
282510	5/16"		
<b>1/4" Dr. Head Hand Socket:</b>			
222601	#1 Philips	222695	1.6 x 9.7mm Slotted
222602	#2 Philips	272804	1/8" Hex
222603	#3 Philips	272805	5/32" Hex
222604	#4 Philips	272806	3/16" Hex
222640	0.8 x 4.0mm Slotted	272807	7/32" Hex
222655	1.0 x 5.5mm Slotted	272808	1/4" Hex
222665	1.2 x 6.5mm Slotted	272809	9/32" Hex
222280	1.2 x 8.0mm Slotted	272810	5/16" Hex
222685	1.6 x 8.5mm Slotted	272812	3/8" Hex
<b>1/4" Dr. Double Square Hand Socket:</b>			
262508	1/4"	262512	3/8"
262510	5/16"		
<b>1/4" Dr. Accessory:</b>			
280070	Universal Joint	220004	Extension Bar, 4"L
280020	Sliding T-Handle	220150	Socket Driver
280222R	24T Reversible Ratchet		
	Metal Box		

1350 g 10 sets / 14.5 Kgs / 0.77 CUFT



Made of Chrome Vanadium Steel



## EU-228S 28 Piece 1/4" Dr. SAE Hand Socket Set

Item No.	Size	Item No.	Size
<b>1/4" Dr. 6pt Hand Socket:</b>			
282504	1/8"	282511	11/32"
282506	3/16"	282512	3/8"
282507	7/32"	282514	7/16"
282508	1/4"	282516	1/2"
282509	9/32"	282518	9/16"
282510	5/16"		
<b>1/4" Hex Shank Screwdriver Bit:</b>			
1140	0.6 x 4.0mm Slotted	1103	#3 Philips
1160	1.0 x 6.0mm Slotted	3108	1/8" Hex
1170	1.2 x 7.0mm Slotted	3110	5/32" Hex
1101	#1 Philips	3112	3/16" Hex
1102	#2 Philips	3114	7/32" Hex
<b>1/4" Dr. Accessory:</b>			
506+0175	Socket Driver	220002	Extension Bar, 2"L
280070	Universal Joint	220006	Extension Bar, 6"L
282408	Bit Holder	280020	Sliding T-Handle
280231S	36T Quick Release Ratchet		
	Blow Case		



870 g      20 sets / 18.5 Kgs / 1.5 CUFT

## GS-229M 29 Piece 1/4" Dr. Metric Hand Socket Set

SAE sizes: GS-229S also available

Item No.	Size	Item No.	Size
<b>1/4" Dr. 6pt Hand Socket:</b>			
222504	4mm	222509	9mm
2225045	4.5mm	222510	10mm
222505	5mm	222511	11mm
2225055	5.5mm	222512	12mm
222506	6mm	222513	13mm
222507	7mm	222514	14mm
222508	8mm		
<b>1/4" Dr. Philips Head Hand Socket:</b>			
222601	#1	222603	#3
222602	#2		
<b>1/4" Dr. Slotted Head Hand Socket:</b>			
222640	0.8 x 4.0mm	222680	1.2 x 8.0mm
222655	1.0 x 5.5mm		
<b>1/4" Dr. Hex Head Hand Socket:</b>			
232803	3mm	232806	6mm
232804	4mm	232808	8mm
232805	5mm		
<b>1/4" Dr. Accessory:</b>			
220002	Extension Bar, 50mmL		
220150	Socket Driver		
280020	Sliding T-Handle		
280070	Universal Joint		
280222R	24T Reversible Ratchet		
	Blow Case		



850 g      20 sets / 18 Kgs / 1.5 CUFT





# Hand Socket Sets

## EU-228M 28 Piece 1/4" Dr. Metric Hand Socket Set

Item No.	Size	Item No.	Size
<b>1/4" Dr. 6pt Hand Socket:</b>			
222504	4mm	222509	9mm
222505	5mm	222510	10mm
2225055	5.5mm	222511	11mm
222506	6mm	222512	12mm
222507	7mm	222513	13mm
222508	8mm		
<b>1/4" Hex Shank Screwdriver Bit:</b>			
1140	0.6 x 4.0mm Slotted	1101	#1 Philips
1160	1.0 x 6.0mm Slotted	1102	#2 Philips
1170	1.2 x 7.0mm Slotted	1103	#3 Philips
2133	3mm Hex	2135	5mm Hex
2134	4mm Hex	2136	6mm Hex
<b>1/4" Dr. Accessory:</b>			
506+0175	Socket Driver	220002	Extension Bar, 50mmL
280070	Universal Joint	220006	Extension Bar, 150mmL
282408	Bit Holder	280020	Sliding T-Handle
280231S	36T Quick Release Ratchet		
	Blow Case		

870 g      20 sets / 18.5 Kgs / 1.5 CUFT



## EU-230MS 30 Piece 1/4" Dr. Metric & SAE Hand Socket Set

Item No.	Size	Item No.	Size
<b>1/4" Dr. 6pt Hand Socket:</b>			
222503	3mm	222514	14mm
222504	4mm	282504	1/8"
222505	5mm	282506	3/16"
2225055	5.5mm	282507	7/32"
222506	6mm	282508	1/4"
222507	7mm	282509	9/32"
222508	8mm	282510	5/16"
222509	9mm	282511	11/32"
222510	10mm	282512	3/8"
222511	11mm	282514	7/16"
222512	12mm	282516	1/2"
222513	13mm	282518	9/16"
<b>1/4" Dr. Accessory:</b>			
506+0175	Socket Driver	220002	Extension Bar, 50mmL
280070	Universal Joint	220006	Extension Bar, 150mmL
280020	Sliding T-Handle		
280231S	36T Quick Release Ratchet		
	Blow Case		

1030 g      20 sets / 22 Kgs / 1.5 CUFT



## EU-232M 32 Piece 1/4" Dr. Metric Deep Hand Socket Set

Item No.	Size	Item No.	Size
<b>1/4" Dr. 6pt Hand Socket:</b>			
222503	3mm	222509	9mm
222504	4mm	222510	10mm
222505	5mm	222511	11mm
2225055	5.5mm	222512	12mm
222506	6mm	222513	13mm
222507	7mm	222514	14mm
222508	8mm		

<b>1/4" Dr. 6pt Deep Hand Socket:</b>			
225204	4mm	225209	9mm
225205	5mm	225210	10mm
2252055	5.5mm	225211	11mm
225206	6mm	225212	12mm
225207	7mm	225213	13mm
225208	8mm	225214	14mm

<b>1/4" Dr. Accessory:</b>			
506+0175	Socket Driver	220002	Extension Bar, 50mmL
280070	Universal Joint	220004	Extension Bar, 100mmL
280020	Sliding T-Handle	220006	Extension Bar, 150mmL
280231S	36T Quick Release Ratchet		

Blow Case

1450 g 12 sets / 18.5 Kgs / 1.59 CUFT



6 pt.

## EU-240M 40 Piece 1/4" Dr. Metric Hand Socket Set

Item No.	Size	Item No.	Size
<b>1/4" Dr. 6pt Hand Socket:</b>			
222505	5mm	222510	10mm
2225055	5.5mm	222511	11mm
222506	6mm	222512	12mm
222507	7mm	222513	13mm
222508	8mm	222514	14mm
222509	9mm		

<b>1/4" Hex Shank Screwdriver Bit:</b>			
1101	#1 Philips	1140	0.6 x 4.0mm Slotted
1102	#2 Philips	1160	1.0 x 6.0mm Slotted
1103	#3 Philips	1170	1.2 x 7.0mm Slotted
1211	#1 Posidriv	7108	T-8 Tamperproof Star
1212	#2 Posidriv	7110	T-10 Tamperproof Star
1213	#3 Posidriv	7115	T-15 Tamperproof Star
2133	3mm Hex	7120	T-20 Tamperproof Star
2134	4mm Hex	7125	T-25 Tamperproof Star
2135	5mm Hex	7127	T-27 Tamperproof Star
2136	6mm Hex	7130	T-30 Tamperproof Star
2137	7mm Hex	7140	T-40 Tamperproof Star
2138	8mm Hex		

<b>1/4" Dr. Accessory:</b>			
506+0175	Socket Driver	220002	Extension Bar, 50mmL
280070	Universal Joint	220004	Extension Bar, 100mmL
282408	1/4" Hex Shank Bit Holder		
280272P	72T Reversible Ratchet		

Blow Case

1000 g 10 sets / 11 Kgs / 0.82 CUFT



6 pt.





# Hand Socket Sets

## TW-242MS 42 Piece 1/4" Dr. Metric & SAE Deep Hand Socket Set (12-Point)

Item No.	Size	Item No.	Size
<b>1/4" Dr. 12pt Hand Socket:</b>			
232506	6mm	272507	7/32"
232507	7mm	272508	1/4"
232508	8mm	272509	9/32"
232509	9mm	272510	5/16"
232510	10mm	272511	11/32"
232511	11mm	272512	3/8"
232512	12mm	272514	7/16"
232513	13mm	272516	1/2"
232514	14mm	272518	9/16"
272506	3/16"		

Item No.	Size	Item No.	Size
<b>1/4" Dr. 12pt Deep Hand Socket:</b>			
235205	5mm	235214	14mm
2352055	5.5mm	275208	1/4"
235206	6mm	275209	9/32"
235207	7mm	275210	5/16"
235208	8mm	275211	11/32"
235209	9mm	275212	3/8"
235210	10mm	275214	7/16"
235211	11mm	275216	1/2"
235212	12mm	275218	9/16"
235213	13mm		

1470 g 12 sets / 18.5 Kgs / 1.16 CUFT

Item No.	Size
<b>1/4" Dr. Accessory:</b>	
280070	Universal Joint
220002	Extension Bar, 50mmL
220006	Extension Bar, 150mmL
280231R	36T Quick Release Ratchet Blow Case



12 pt.

## GS-244MS 44 Piece 1/4" Dr. Metric & SAE Deep Hand Socket Set

Item No.	Size	Item No.	Size
<b>1/4" Dr. 6pt Hand Socket:</b>			
222503	3mm	222514	14mm
222504	4mm	282506	3/16"
222505	5mm	282507	7/32"
2225055	5.5mm	282508	1/4"
222506	6mm	282509	9/32"
222507	7mm	282510	5/16"
222508	8mm	282511	11/32"
222509	9mm	282512	3/8"
222510	10mm	282514	7/16"
222511	11mm	282516	1/2"
222512	12mm	282518	9/16"
222513	13mm		

Item No.	Size	Item No.	Size
<b>1/4" Dr. 6pt Deep Hand Socket:</b>			
2252055	5.5mm	225214	14mm
225206	6mm	285208	1/4"
225207	7mm	285209	9/32"
225208	8mm	285210	5/16"
225209	9mm	285211	11/32"
225210	10mm	285212	3/8"
225211	11mm	285214	7/16"
225212	12mm	285216	1/2"
225213	13mm	285218	9/16"

1600 g 12 sets / 20.5 Kgs / 1.59 CUFT

Item No.	Size
<b>1/4" Dr. Accessory:</b>	
220002	Extension Bar, 50mmL
220006	Extension Bar, 150mmL
280272	72T Reversible Ratchet Blow Case



6 pt.

## TW-230M 30 Piece 1/4" Dr. Metric Deep Hand Socket Set (6 & 12-Point)

Item No.	Size	Item No.	Size
----------	------	----------	------

### 1/4" Dr. 12pt Hand Socket:

232505	5mm	232510	10mm
2325055	5.5mm	232511	11mm
232506	6mm	232512	12mm
232507	7mm	232513	13mm
232508	8mm	232514	14mm
232509	9mm		

### 1/2" Dr. 6pt Deep Hand Socket:

225204	4mm	225209	9mm
225205	5mm	225210	10mm
2252055	5.5mm	225211	11mm
225206	6mm	225212	12mm
225207	7mm	225213	13mm
225208	8mm	225214	14mm

### 1/4" Dr. Accessory:

280070	Universal Joint	220002	Extension Bar, 50mmL
280020	Sliding T-Handle	220004	Extension Bar, 100mmL
506+0175	Socket Driver	220006	Extension Bar, 150mmL
280231S	36T Quick Release Ratchet		
	Plastic Tray		



(192W x 203D)



1220 g 10 sets / 13.5 Kgs / 0.93 CUFT

## XV-246M 46 Piece 1/4" Dr. Metric Hand Socket Set

Item No.	Size	Item No.	Size	Item No.	Size
----------	------	----------	------	----------	------

### 1/4" Dr. 6pt Hand Socket:

V2040	4mm	V2090	9mm
V2045	4.5mm	V2100	10mm
V2050	5mm	V2111	11mm
V2055	5.5mm	V2112	12mm
V2060	6mm	V2113	13mm
V2070	7mm	V2114	14mm
V2080	8mm		

### 1/4" Dr. Philips Bit Socket, 37mmL:

V2401	#1	V2403	#3
V2402	#2		

### 1/4" Dr. Posidriv Bit Socket, 37mmL:

V2501	#1	V2503	#3
V2502	#2		

### 1/4" Dr. Slotted Bit Socket, 37mmL:

V2340	0.6 x 4.0mm	V2370	1.2 x 7.0mm
V2355	0.8 x 5.5mm		

### 1/4" Dr. Metric Hex Bit Socket, 37mmL:

V2230	3mm	V2260	6mm
V2240	4mm	V2270	7mm
V2250	5mm	V2280	8mm

### 1/4" Dr. Star Bit Socket, 37mmL:

V2608	T-8	V2625	T-25
V2610	T-10	V2630	T-30
V2615	T-15	V2640	T-40
V2620	T-20		

### Hex Key Wrench:

VHK05	1.27mm	VHK20	2.0mm
VHK15	1.5mm	VHK25	2.5mm



1300 g 12 sets / 17 Kgs / 1.16 CUFT



# Hand Socket Sets

## TW-227MS 27 Piece 1/4" Dr. Metric & SAE Hand Socket Set (12-Point)

Item No.	Size	Item No.	Size
<b>1/4" Dr. 12pt Hand Socket:</b>			
232505	5mm	272506	3/16"
2325055	5.5mm	272507	7/32"
232506	6mm	272508	1/4"
232507	7mm	272509	9/32"
232508	8mm	272510	5/16"
232509	9mm	272511	11/32"
232510	10mm	272512	3/8"
232511	11mm	272514	7/16"
232512	12mm	272516	1/2"
232513	13mm	272518	9/16"
232514	14mm		

### 1/4" Dr. Accessory:

280070	Universal Joint	220002	Extension Bar, 50mmL
280020	Sliding T-Handle	220006	Extension Bar, 150mmL
506+0175	Socket Driver		
280231S	36T Quick Release Ratchet		
	Plastic Tray		



(192W x 203D)



1000 g 10 sets / 11 Kgs / 0.93 CUFT

## GS-255MS 55 Piece 1/4" Dr. Metric & SAE Deep Hand Socket Set

Item No.	Size	Item No.	Size
<b>1/4" Dr. 6pt Hand Socket:</b>			
222503	3mm	282504	1/8"
222504	4mm	282506	3/16"
2225045	4.5mm	282507	7/32"
222505	5mm	282508	1/4"
2225055	5.5mm	282509	9/32"
222506	6mm	282510	5/16"
222507	7mm	282511	11/32"
222508	8mm	282512	3/8"
222509	9mm	282514	7/16"
222510	10mm	282516	1/2"
222511	11mm	282518	9/16"
222512	12mm		
222513	13mm		
222514	14mm		

### 1/4" Dr. 6pt Deep Hand Socket:

225204	4mm	285206	3/16"
2252045	4.5mm	285207	7/32"
225205	5mm	285208	1/4"
2252055	5.5mm	285209	9/32"
225206	6mm	285210	5/16"
225207	7mm	285211	11/32"
225208	8mm	285212	3/8"
225209	9mm	285214	7/16"
225210	10mm	285216	1/2"
225211	11mm	285218	9/16"
225212	12mm		
225213	13mm		
225214	14mm		

Item No.	Size
220002	Extension Bar, 50mmL
220003	Extension Bar, 75mmL
220004	Extension Bar, 100mmL
220006	Extension Bar, 150mmL
280070	Universal Joint
280030	Adapter, 1/4"F x 3/8"M
283508	1/4" Hex Shank Bit Holder
	Blow Case



1750 g 12 sets / 22 Kgs / 1.59 CUFT

Made of Chrome Vanadium Steel



## Metric Hand Sockets

Item No.	A	D1	D2	Length mm	Weight g	PCS inner/ctn	G.W. KGS	CUFT 
	mm	mm	mm					
323206	6	9.5	18.8	28	25	20 / 300	10.0	0.69
323207	7	10.8	18.8	28	25	20 / 300	10.0	0.69
323208	8	12.0	18.8	28	25	20 / 300	10.0	0.69
323209	9	13.3	18.8	28	30	20 / 300	10.0	0.69
323210	10	14.5	18.8	28	30	20 / 300	10.5	0.69
323211	11	15.8	18.8	30	35	20 / 300	11.5	0.69
323212	12	17.0	18.8	30	35	20 / 300	12.0	0.69
323213	13	18.3	19.8	30	40	20 / 300	13.0	0.69
323214	14	19.8	19.0	30	40	20 / 300	13.0	0.69
323215	15	20.8	19.0	30	40	20 / 300	13.0	0.69
323216	16	22.0	20.0	30	40	20 / 300	13.5	0.69
323217	17	23.3	21.0	32	50	20 / 300	16.0	0.69
323218	18	24.8	22.5	32	55	20 / 300	18.0	0.69
323219	19	25.8	23.0	32	60	20 / 300	19.5	0.69
323220	20	26.8	24.0	32	70	20 / 300	22.0	0.69
323221	21	27.8	25.0	32	75	20 / 300	25.0	0.69
323222	22	29.8	26.0	32	90	20 / 300	30.0	0.69

6 pt.



## SAE Hand Sockets

Item No.	A	D1	D2	Length mm	Weight g	PCS inner/ctn	G.W. KGS	CUFT 
	inch	mm	mm					
383208	1/4	9.9	18.8	28	25	20 / 300	10.0	0.69
383210	5/16	11.9	18.8	28	25	20 / 300	10.0	0.69
383211	11/32	12.9	18.8	28	30	20 / 300	10.0	0.69
383212	3/8	13.9	18.8	28	30	20 / 300	10.0	0.69
383214	7/16	15.9	18.8	30	35	20 / 300	11.5	0.69
383216	1/2	17.9	18.8	30	35	20 / 300	12.0	0.69
383218	9/16	19.8	19.0	30	35	20 / 300	12.0	0.69
383219	19/32	20.8	19.0	30	40	20 / 300	13.5	0.69
383220	5/8	22.0	20.0	30	40	20 / 300	14.0	0.69
383222	11/16	23.3	21.5	32	50	20 / 300	17.5	0.69
383224	3/4	25.8	23.0	32	65	20 / 300	21.5	0.69
383225	25/32	26.8	24.0	32	70	20 / 300	23.0	0.69
383226	13/16	27.8	24.5	32	70	20 / 300	23.0	0.69
383228	7/8	29.8	26.0	32	75	20 / 300	25.0	0.69

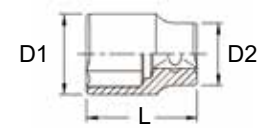
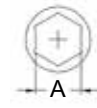

## E-Star Hand Sockets

Item No.	A	D1	D2	Length mm	Weight g	PCS inner/ctn	G.W. KGS	CUFT 
	Size	mm	mm					
353510	E-10	12.2	17	28	20	20 / 300	8.5	0.69
353511	E-11	13.0	17	28	25	20 / 300	8.5	0.69
353512	E-12	14.3	17	28	25	20 / 300	8.5	0.69
353514	E-14	16.3	18	28	30	20 / 300	10.0	0.69
353516	E-16	18.3	20	28	40	20 / 300	13.0	0.69
353518	E-18	20.5	22	30	55	20 / 300	18.0	0.69
353520	E-20	22.5	24	30	65	20 / 300	22.0	0.69

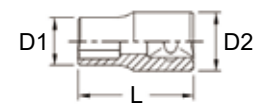
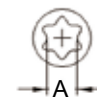

**NEW**

## E-Star Deep Hand Sockets

Item No.	A	D1	D2	Length mm	Weight g	PCS inner/ctn	G.W. KGS	CUFT 
	Size	mm	mm					
356310	E-10	12.2	17	63	50	10 / 200	11.0	0.60
356311	E-11	13.0	17	63	55	10 / 200	12.0	0.60
356312	E-12	14.3	17	63	65	10 / 200	14.0	0.60
356314	E-14	16.3	18	63	75	10 / 200	16.0	0.60
356316	E-16	18.3	20	63	90	10 / 200	19.0	0.60
356318	E-18	20.5	22	63	110	10 / 140	16.5	0.44
356320	E-20	22.5	24	63	130	10 / 140	19.0	0.44

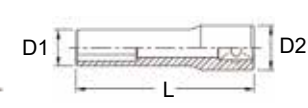
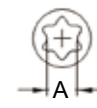

Hand Sockets

3/8

## Metric Deep Hand Sockets

Item No.	A mm	D1 mm	D2 mm	Length mm	Weight g	PCS	G.W. KGS	CUFT
						inner/ctn		
326306	6	9.5	18.8	63	50	10 / 200	12.0	0.60
326307	7	10.8	18.8	63	55	10 / 200	13.0	0.60
326308	8	12.0	18.8	63	55	10 / 200	13.0	0.60
326309	9	13.3	18.8	63	60	10 / 200	14.0	0.60
326310	10	14.5	18.8	63	65	10 / 200	15.0	0.60
326311	11	15.8	18.8	63	75	10 / 200	16.0	0.60
326312	12	17.0	18.8	63	75	10 / 200	16.0	0.60
326313	13	18.3	19.8	63	75	10 / 200	17.0	0.60
326314	14	19.8	19.0	63	75	10 / 200	17.0	0.60
326315	15	20.8	19.0	63	75	10 / 200	17.0	0.60
326316	16	22.0	20.0	63	80	10 / 200	18.0	0.60
326317	17	23.8	21.5	63	100	10 / 200	23.5	0.60
326318	18	24.8	22.5	63	100	10 / 120	14.0	0.52
326319	19	25.8	23.0	63	110	10 / 120	15.0	0.52
326320	20	26.8	24.0	63	130	10 / 120	17.0	0.52
326321	21	27.8	25.0	63	140	10 / 120	17.5	0.52
326322	22	29.8	26.0	63	150	10 / 120	19.5	0.52

## SAE Deep Hand Sockets

Item No.	A inch	D1 mm	D2 mm	Length mm	Weight g	PCS	G.W. KGS	CUFT
						inner/ctn		
386308	1/4	9.9	18.8	63	50	10 / 200	12.0	0.60
386310	5/16	11.9	18.8	63	50	10 / 200	13.0	0.60
386311	11/32	12.9	18.8	63	60	10 / 200	14.0	0.60
386312	3/8	13.9	18.8	63	60	10 / 200	14.0	0.60
386314	7/16	15.9	18.8	63	65	10 / 200	15.0	0.60
386316	1/2	17.9	18.8	63	70	10 / 200	16.0	0.60
386318	9/16	19.8	19.0	63	75	10 / 200	17.0	0.60
386319	19/32	20.8	19.0	63	85	10 / 200	18.0	0.60
386320	5/8	22.0	20.0	63	85	10 / 200	19.0	0.60
386322	11/16	23.8	21.5	63	100	10 / 200	21.0	0.60
386324	3/4	25.8	23.0	63	110	10 / 120	14.0	0.52
386325	25/32	26.8	24.0	63	130	10 / 120	17.0	0.52
386326	13/16	27.8	24.5	63	140	10 / 120	17.5	0.52
386328	7/8	29.8	26.0	63	150	10 / 120	19.0	0.52

## GS-332M 32 Piece 3/8" Dr. Metric Deep Hand Socket Set

Item No.	Size	Item No.	Size
<b>3/8" Dr. 6pt Hand Socket:</b>			
323207	7mm	323215	15mm
323208	8mm	323216	16mm
323209	9mm	323217	17mm
323210	10mm	323218	18mm
323211	11mm	323219	19mm
323212	12mm	323220	20mm
323213	13mm	323221	21mm
323214	14mm	323222	22mm
<b>3/8" Dr. 6pt Deep Hand Socket:</b>			
326307	7mm	326315	15mm
326308	8mm	326316	16mm
326309	9mm	326317	17mm
326310	10mm	326318	18mm
326311	11mm	326319	19mm
326312	12mm	326320	20mm
326313	13mm	326321	21mm
326314	14mm	326322	22mm

Plastic Tray

2700 g 5 sets / 14.5 Kgs / 0.93 CUFT



(192W x 406D)

6 pt.

6 pt.

1/3

## Metric Hand Sockets (12-Point)

Item No.	A mm	D1 mm	D2 mm	Length mm	Weight g	PCS inner/ctn	G.W.		CUFT
							KGS		
333206	6	9.5	18.8	28	25	20 / 300	10.0		0.69
333207	7	10.8	18.8	28	25	20 / 300	10.0		0.69
333208	8	12.0	18.8	28	25	20 / 300	10.0		0.69
333209	9	13.3	18.8	28	30	20 / 300	11.0		0.69
333210	10	14.5	18.8	28	30	20 / 300	11.5		0.69
333211	11	15.8	18.8	30	30	20 / 300	11.5		0.69
333212	12	17.0	18.8	30	35	20 / 300	11.5		0.69
333213	13	18.3	19.8	30	40	20 / 300	13.0		0.69
333214	14	19.8	19.0	30	40	20 / 300	13.0		0.69
333215	15	20.8	19.0	30	40	20 / 300	13.0		0.69
333216	16	22.0	20.0	30	40	20 / 300	13.0		0.69
333217	17	23.3	21.0	32	45	20 / 300	16.0		0.69
333218	18	24.8	22.5	32	55	20 / 300	18.0		0.69
333219	19	25.8	23.0	32	55	20 / 300	18.0		0.69
333220	20	26.8	24.0	32	65	20 / 300	21.5		0.69
333221	21	27.8	25.0	32	70	20 / 300	22.0		0.69
333222	22	29.8	26.0	32	90	20 / 300	28.0		0.69

12 pt.



## SAE Hand Sockets (12-Point)

Item No.	A inch	D1 mm	D2 mm	Length mm	Weight g	PCS inner/ctn	G.W.		CUFT
							KGS		
373208	1/4	9.9	18.8	28	25	20 / 300	10.0		0.69
373210	5/16	11.9	18.8	28	25	20 / 300	10.0		0.69
373211	11/32	12.9	18.8	28	30	20 / 300	10.0		0.69
373212	3/8	13.9	18.8	28	30	20 / 300	10.0		0.69
373214	7/16	15.9	18.8	30	30	20 / 300	11.5		0.69
373216	1/2	17.9	18.8	30	35	20 / 300	12.5		0.69
373218	9/16	19.8	19.0	30	35	20 / 300	12.5		0.69
373219	19/32	20.8	19.0	30	40	20 / 300	13.0		0.69
373220	5/8	22.0	20.0	30	40	20 / 300	13.0		0.69
373222	11/16	23.3	21.5	32	50	20 / 300	17.0		0.69
373224	3/4	25.8	23.0	32	55	20 / 300	19.0		0.69
373225	25/32	26.8	24.0	32	65	20 / 300	22.0		0.69
373226	13/16	27.8	24.5	32	65	20 / 300	22.5		0.69
373228	7/8	29.8	26.0	32	85	20 / 300	27.0		0.69

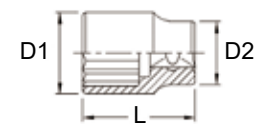
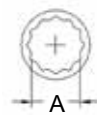

## TW-308M 8 Piece 3/8" Dr. Metric Hand Socket Set (12-Point)

Item No.	Size	Item No.	Size
<b>3/8" Dr. 12pt Hand Socket:</b>			
333208	8mm	333213	13mm
333210	10mm	333214	14mm
333211	11mm	333217	17mm
333212	12mm	333219	19mm

Socket Holder

370 g 6x6 36 sets / 14.3 Kgs / 1.41 CUFT

**NEW**



12 pt.

## TW-308S 8 Piece 3/8" Dr. SAE Impact Socket Set (12-Point)

Item No.	Size	Item No.	Size
<b>3/8" Dr. 12pt Hand Socket:</b>			
373210	5/16"	373218	9/16"
373212	3/8"	373220	5/8"
373214	7/16"	373222	11/16"
373216	1/2"	373224	3/4"

Socket Holder

350 g 6x6 36 sets / 13.6 Kgs / 1.41 CUFT

**NEW**



12 pt.

Hand Sockets



## Metric Deep Hand Sockets (12-Point)

Item No.	A mm	D1 mm	D2 mm	Length mm	Weight g	PCS	G.W. KGS	CUFT
						inner/ctn		
336306	6	9.5	18.8	63	50	10 / 200	12.0	0.60
336307	7	10.8	18.8	63	50	10 / 200	12.0	0.60
336308	8	12.0	18.8	63	50	10 / 200	12.0	0.60
336309	9	13.3	18.8	63	55	10 / 200	13.0	0.60
336310	10	14.5	18.8	63	65	10 / 200	15.0	0.60
336311	11	15.8	18.8	63	65	10 / 200	15.0	0.60
336312	12	17.0	18.8	63	70	10 / 200	15.0	0.60
336313	13	18.3	19.8	63	75	10 / 200	16.0	0.60
336314	14	19.8	19.0	63	75	10 / 200	16.0	0.60
336315	15	20.8	19.0	63	75	10 / 200	16.0	0.60
336316	16	22.0	20.0	63	80	10 / 200	17.5	0.60
336317	17	23.8	21.5	63	95	10 / 200	21.0	0.60
336318	18	24.8	22.5	63	110	10 / 120	14.5	0.52
336319	19	25.8	23.0	63	110	10 / 120	14.5	0.52
336320	20	26.8	24.0	63	120	10 / 120	16.5	0.52
336321	21	27.8	25.0	63	120	10 / 120	17.0	0.52
336322	22	29.8	26.0	63	150	10 / 120	19.0	0.52

## SAE Deep Hand Sockets (12-Point)

Item No.	A inch	D1 mm	D2 mm	Length mm	Weight g	PCS	G.W. KGS	CUFT
						inner/ctn		
376308	1/4	9.9	18.8	63	55	10 / 200	12.0	0.60
376310	5/16	11.9	18.8	63	55	10 / 200	12.0	0.60
376311	11/32	12.9	18.8	63	55	10 / 200	12.0	0.60
376312	3/8	13.9	18.8	63	60	10 / 200	13.0	0.60
376314	7/16	15.9	18.8	63	65	10 / 200	14.0	0.60
376316	1/2	17.9	18.8	63	70	10 / 200	15.0	0.60
376318	9/16	19.8	19.0	63	70	10 / 200	15.0	0.60
376319	19/32	20.8	19.0	63	70	10 / 200	15.0	0.60
376320	5/8	22.0	20.0	63	80	10 / 200	17.0	0.60
376322	11/16	23.8	21.5	63	95	10 / 200	21.0	0.60
376324	3/4	25.8	23.0	63	100	10 / 120	14.5	0.52
376325	25/32	26.8	24.0	63	110	10 / 120	15.5	0.52
376326	13/16	27.8	24.5	63	120	10 / 120	16.5	0.52
376328	7/8	29.8	26.0	63	150	10 / 120	19.0	0.52

## Metric Universal Hand Sockets (12-Point)

Item No.	A mm	D1 mm	D2 mm	Length mm	Weight g	PCS	G.W. KGS	CUFT
						inner/ctn		
355610	10	14.5	19	51	55	10 / 200	13.0	0.60
355611	11	16.0	19	51	55	10 / 200	13.0	0.60
355612	12	17.0	19	51	55	10 / 200	13.0	0.60
355613	13	18.0	19	51	55	10 / 200	13.0	0.60
355614	14	20.0	19	52	60	10 / 200	13.0	0.60
355615	15	22.0	19	53	65	10 / 200	14.0	0.60
355616	16	22.0	19	54	65	10 / 200	14.0	0.60
355617	17	24.0	19	54	70	10 / 200	15.0	0.60
355618	18	26.0	19	56	75	10 / 200	16.0	0.60
355619	19	26.0	19	56	75	10 / 200	17.0	0.60

## SAE Universal Hand Sockets (12-Point)

Item No.	A inch	D1 mm	D2 mm	Length mm	Weight g	PCS	G.W. KGS	CUFT
						inner/ctn		
365612	3/8	14.0	19	51	55	10 / 200	13.0	0.60
365614	7/16	16.0	19	51	55	10 / 200	13.0	0.60
365616	1/2	18.0	19	51	55	10 / 200	13.0	0.60
365618	9/16	20.0	19	52	55	10 / 200	13.0	0.60
365620	5/8	22.0	19	54	60	10 / 200	14.0	0.60
365622	11/16	24.0	19	56	65	10 / 200	14.0	0.60
365624	3/4	26.0	19	56	70	10 / 200	15.0	0.60

12 pt.

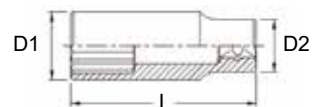
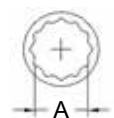

12 pt.

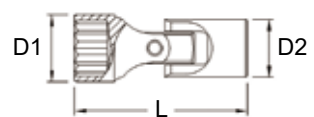

## Universal Joint

Item No.	Outside Diameter	Length mm	Weight g	PCS	G.W. KGS	CUFT
				inner/ctn		
380070	18mm	54	70	10 / 200	15.0	0.60



## Adapters

Item No.	Female Drive	Male Drive	Length mm	Weight g	PCS	G.W. KGS	CUFT
					inner/ctn		
320020	3/8"	1/4"	30	30	20 / 300	10.0	0.69
320040	3/8"	1/2"	35	50	20 / 300	16.0	0.69



## Extension Bars

Item No.	Length mm	Weight g	PCS	G.W. KGS	CUFT
			inner/ctn		
320025	25	30	20 / 120	4.5	0.52
320050	50	50	10 / 200	11.0	0.60
320075	75	75	10 / 140	12.0	0.44
<b>NEW</b> 320125	125	120	10 / 120	15.5	0.30
320150	150	145	10 / 120	19.0	0.30
320200	200	190	10 / 100	20.0	0.34
320250	250	240	10 / 80	20.5	0.44
<b>NEW</b> 320300	300	285	5 / 60	18.0	0.52



## Wobble Extension Bars

Item No.	Length mm	Weight g	PCS	G.W. KGS	CUFT
			inner/ctn		
320002B	50	45	10 / 200	10.0	0.60
320003B	75	60	10 / 140	10.0	0.44
<b>NEW</b> 320005B	125	105	10 / 120	13.5	0.30
320006B	150	110	10 / 120	15.0	0.30
320008B	200	150	10 / 100	16.0	0.34
<b>NEW</b> 320010B	250	185	10 / 80	16.0	0.44
320012B	300	220	5 / 60	14.5	0.52
320018B	450	315	1 / 50	17.0	0.43



## BE-32306 3 Piece 3/8" Dr. Wobble Extension Bar Set

Item No.	Size
320002B	50mmL (2"L)
320003B	75mmL (3"L)
320006B	150mmL (6"L)

Sliding Card

225 g 15x8 120 sets / 28 Kgs / 1.6 CUFT



## BE-2349 9 Piece 1/4", 3/8" & 1/2" Dr. Wobble Extension Bar Set

Item No.	Size
<b>Wobble Extension Bar:</b>	
220002B	1/4" Dr. 50mmL (2"L)
220004B	1/4" Dr. 100mmL (4"L)
220006B	1/4" Dr. 150mmL (6"L)
320002B	3/8" Dr. 45mmL (1-3/4"L)
320003B	3/8" Dr. 75mmL (3"L)
320006B	3/8" Dr. 150mmL (6"L)
420002B	1/2" Dr. 50mmL (2"L)
420005B	1/2" Dr. 125mmL (5"L)
420010B	1/2" Dr. 250mmL (10"L)

Plastic Tray

1200 g 10 sets / 13 Kgs / 0.93 CUFT



(192W x 203D)

1/6

3/8

# Hand Sockets

## Bit Holders

Item No.	Hex Shank	Length mm	Weight g	PCS		G.W. KGS	CUFT
				inner/ctn			
383908	1/4"	39	40	10 / 200		9.0	0.60
384608	1/4"	46	50	10 / 200		11.0	0.60
383910	5/16"	39	40	10 / 200		9.5	0.60
384610	5/16"	46	50	10 / 200		11.0	0.60
383912	3/8"	39	55	10 / 200		12.5	0.52
323910	10mm	39	60	10 / 200		13.0	0.52

## Spark Plug Sockets

Item No.	Size		Type	Length mm	Weight g	PCS		G.W. KGS	CUFT
	mm	inch				inner/ctn			
326014	14.0	-	12pt	63	70	10 / 200		16.0	0.60
326016	16.0	5/8"	6pt	63	100	10 / 200		21.0	0.60
326021	20.6	13/16"	6pt	63	140	10 / 120		18.0	0.52

## Swivel Spark Plug Sockets

Item No.	Size		Length mm	Weight g	PCS		G.W. KGS	CUFT
	mm	inch			inner/ctn			
318516	16.0	5/8"	90	140	15 / 90		13.5	0.92
318521	20.6	13/16"	90	200	15 / 90		19.0	0.92

## Sliding T-Handle

Item No.	Length mm	Weight g	PCS		G.W. KGS	CUFT
			inner/ctn			
380030	250	300	5 / 70		17.0	0.44

## L-Handle

Item No.	Length mm	Weight g	PCS		G.W. KGS	CUFT
			inner/ctn			
320160L	160	160	10 / 100		17.0	0.34

## T-Handles (Ball Joint)

Item No.	Length mm	Weight g	PCS		G.W. KGS	CUFT
			inner/ctn			
323503T	350	400	1 / 20		9.0	0.45
325003T	500	500	1 / 20		11.0	0.46

## T-Handles (Quick Release)

Item No.	Length mm	Weight g	PCS		G.W. KGS	CUFT
			inner/ctn			
324203	420	540	1 / 40		22.5	0.40
327003	700	800	1 / 20		17.0	0.44

## T-Handles (Universal Joint)

Item No.	Length mm	Weight g	PCS		G.W. KGS	CUFT
			inner/ctn			
324203U	420	560	1 / 40		23.5	0.40
327003U	700	800	1 / 20		17.0	0.44

## Speed Handle

Item No.	Length mm	Weight g	PCS		G.W. KGS	CUFT
			inner/ctn			
380400	400	500	1 / 20		11.0	1.24



12 pt.

6 pt.



6 pt.



## 36 Teeth Ratchet w/ Quick Release

Item No.	Length mm	Weight g	PCS inner/ctn	G.W. KGS	CUFT
380331R	180	310	1 / 50	16.5	0.50



## 36 Teeth Ratchet w/ Quick Release

Item No.	Length mm	Weight g	PCS inner/ctn	G.W. KGS	CUFT
380331P	210	310	1 / 40	13.5	0.44



## 36 Teeth Ratchet w/ Quick Release

Item No.	Length mm	Weight g	PCS inner/ctn	G.W. KGS	CUFT
380331S	220	320	1 / 40	14.0	0.44



## 24 Teeth Reversible Ratchet

Item No.	Length mm	Weight g	PCS inner/ctn	G.W. KGS	CUFT
380333R	180	340	1 / 50	16.0	0.50



## Hinge Handle

Item No.	Length mm	Weight g	PCS inner/ctn	G.W. KGS	CUFT
380336A	200	300	5 / 70	22.0	0.44



## Hinge Handles

Item No.	Length mm	Weight g	PCS inner/ctn	G.W. KGS	CUFT
380336	200	240	5 / 50	13.0	0.34
380338	255	290	5 / 30	10.0	0.34



## Hinge Handles

Item No.	Length mm	Weight g	PCS inner/ctn	G.W. KGS	CUFT
380336P	230	250	5 / 50	13.5	0.41
380338P	280	300	5 / 30	10.0	0.34



## Hinge Handles

Item No.	Length mm	Weight g	PCS inner/ctn	G.W. KGS	CUFT
380336S	240	250	5 / 50	13.5	0.62
380338S	280	330	5 / 30	11.0	0.34



## 72 Teeth Reversible Ratchet

Item No.	Length mm	Weight g	PCS inner/ctn	G.W. KGS	CUFT
380372	200	310	10 / 40	13.5	0.71



## 72 Teeth Reversible Ratchet

Item No.	Length mm	Weight g	PCS inner/ctn	G.W. KGS	CUFT
380372P	225	310	10 / 40	13.5	0.71



## 72 Teeth Reversible Ratchet

Item No.	Length mm	Weight g	PCS inner/ctn	G.W. KGS	CUFT
380372S	225	330	1 / 40	14.0	0.60



**72 Teeth Stubby Ratchet**

Item No.	Length mm	Weight g	PCS inner/ctn	G.W. KGS	CUFT
380370	100	190	15 / 90	18.0	0.92



**72 Teeth 1/4 & 3/8" Double Drive Ratchet**

Item No.	Length mm	Weight g	PCS inner/ctn	G.W. KGS	CUFT
380371	140	270	5 / 60	18.0	1.65



**72 Teeth Rotor Ratchet**

Item No.	Length mm	Weight g	PCS inner/ctn	G.W. KGS	CUFT
381803	225	410	10 / 40	17.5	0.71



**72 Teeth Rotor Ratchet**

Item No.	Length mm	Weight g	PCS inner/ctn	G.W. KGS	CUFT
381803P	250	400	10 / 60	25.0	1.58



**72 Teeth Rotor Ratchet**

Item No.	Length mm	Weight g	PCS inner/ctn	G.W. KGS	CUFT
381803S	260	400	10 / 60	25.0	1.58



**72 Teeth Flex Head Ratchets**

Item No.	Length mm	Weight g	PCS inner/ctn	G.W. KGS	CUFT
383363	230	370	10 / 40	16.0	0.71
383338	280	410	10 / 60	26.0	1.21



**72 Teeth Flex Head Ratchets**

Item No.	Length mm	Weight g	PCS inner/ctn	G.W. KGS	CUFT
383363P	250	400	10 / 60	23.5	1.58
383338P	300	420	15 / 60	26.5	1.50



**72 Teeth Flex Head Ratchets**

Item No.	Length mm	Weight g	PCS inner/ctn	G.W. KGS	CUFT
383363S	260	370	10 / 60	23.5	1.58
383338S	310	420	15 / 60	26.5	1.50



**24 Teeth Flex Head Ratchet**

Item No.	Length mm	Weight g	PCS inner/ctn	G.W. KGS	CUFT
380375	255	400	5 / 50	21.0	0.62



**72 Teeth Bent Handle Flex Head Ratchet**

Item No.	Length mm	Weight g	PCS inner/ctn	G.W. KGS	CUFT
383383L	270	410	10 / 60	26.0	1.21



**72 Teeth Bent Handle Flex Head Ratchet**

Item No.	Length mm	Weight g	PCS inner/ctn	G.W. KGS	CUFT
383383P	310	420	15 / 60	26.5	1.50



**72 Teeth Bent Handle Flex Head Ratchet**

Item No.	Length mm	Weight g	PCS inner/ctn	G.W. KGS	CUFT
383383S	310	420	15 / 60	26.5	1.50

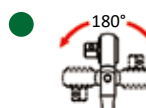
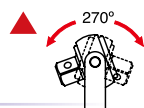

## GS-308M 8 Piece 3/8" Dr. Metric Hand Socket Set

SAE size: GS-308S also available

Item No.	Size	Item No.	Size
<b>3/8" Dr. 6pt Hand Socket:</b>			
323208	8mm	323213	13mm
323210	10mm	323214	14mm
323211	11mm	323217	17mm
323212	12mm	323219	19mm
Socket Holder			

380 g 6x6 36 sets / 14.7 Kgs / 1.41 CUFT



6 pt.

## GS-312M 12 Piece 3/8" Dr. Metric Hand Socket Set

Item No.	Size	Item No.	Size
<b>3/8" Dr. 6pt Hand Socket:</b>			
323208	8mm	323214	14mm
323209	9mm	323215	15mm
323210	10mm	323216	16mm
323211	11mm	323217	17mm
323212	12mm	323218	18mm
323213	13mm	323219	19mm
Socket Holder			

600 g 8x4 32 sets / 20.5 Kgs / 1.14 CUFT



6 pt.

## GS-314S 14 Piece 3/8" Dr. SAE Hand Socket Set

Item No.	Size	Item No.	Size
<b>3/8" Dr. 6pt Hand Socket:</b>			
383208	1/4"	383219	19/32"
383210	5/16"	383220	5/8"
383211	11/32"	383222	11/16"
383212	3/8"	383224	3/4"
383214	7/16"	383225	25/32"
383216	1/2"	383226	13/16"
383218	9/16"	383228	7/8"
Socket Holder			

800 g 20x1 20 sets / 17 Kgs / 0.92 CUFT



6 pt.

## US-310M 10 Piece 3/8" Dr. Metric Universal Hand Socket Set (12-Point)

Item No.	Size	Item No.	Size
<b>3/8" Dr. 12pt Universal Hand Socket:</b>			
355610	10mm	355615	15mm
355611	11mm	355616	16mm
355612	12mm	355617	17mm
355613	13mm	355618	18mm
355614	14mm	355619	19mm
Socket Holder			

670 g 5x6 30 sets / 21 Kgs / 1.21 CUFT



12 pt.

## US-307S 7 Piece 3/8" Dr. SAE Universal Hand Socket Set (12-Point)

Item No.	Size	Item No.	Size
<b>3/8" Dr. 12pt Universal Hand Socket:</b>			
365612	3/8"	365620	5/8"
365614	7/16"	365622	11/16"
365616	1/2"	365624	3/4"
365618	9/16"	Socket Holder	

480 g 5x4 20 sets / 11 Kgs / 0.71 CUFT



12 pt.

3/8

# Hand Socket Sets

## GD-312M 12 Piece 3/8" Dr. Metric Deep Hand Socket Set

Item No.	Size	Item No.	Size
<b>3/8" Dr. 6pt Deep Hand Socket:</b>			
326308	8mm	326314	14mm
326309	9mm	326315	15mm
326310	10mm	326316	16mm
326311	11mm	326317	17mm
326312	12mm	326318	18mm
326313	13mm	326319	19mm
Socket Holder			

1050 g

6x4 24 sets / 26.2 Kgs / 1.5 CUFT



6 pt.

## GS-314SD 14 Piece 3/8" Dr. SAE Deep Hand Socket Set

Item No.	Size	Item No.	Size
<b>3/8" Dr. 6pt Deep Hand Socket:</b>			
386308	1/4"	386319	19/32"
386310	5/16"	386320	5/8"
386311	11/32"	386322	11/16"
386312	3/8"	386324	3/4"
386314	7/16"	386325	25/32"
386316	1/2"	386326	13/16"
386318	9/16"	386328	7/8"
Socket Holder			

1400 g

12x1 12 sets / 18 Kgs / 0.73 CUFT



6 pt.

## GS-331M 31 Piece 3/8" Dr. Metric Deep Hand Socket Set

Item No.	Size	Item No.	Size
<b>3/8" Dr. 6pt Hand Socket:</b>			
323208	8mm	323214	14mm
323209	9mm	323215	15mm
323210	10mm	323216	16mm
323211	11mm	323217	17mm
323212	12mm	323218	18mm
323213	13mm	323219	19mm
<b>3/8" Dr. 6pt Deep Hand Socket:</b>			
326308	8mm	326314	14mm
326309	9mm	326315	15mm
326310	10mm	326316	16mm
326311	11mm	326317	17mm
326312	12mm	326318	18mm
326313	13mm	326319	19mm

### 3/8" Dr. Accessory:

380070	Universal Joint
380338P	Hinge Handle
320025	Extension Bar, 25mmL
320075	Extension Bar, 75mmL
320150	Extension Bar, 150mmL
320250	Extension Bar, 250mmL
380331R	36T Quick Release Ratchet
Blow Case	

3300 g

6 sets / 20.8 Kgs / 1.12 CUFT



6 pt.

## TW-316M 16 Piece 3/8" Dr. Metric Hand Socket Set (12-Point)

Item No.	Size	Item No.	Size
<b>3/8" Dr. 12pt Hand Socket:</b>			
333206	6mm	333214	14mm
333207	7mm	333215	15mm
333208	8mm	333216	16mm
333209	9mm	333217	17mm
333210	10mm	333218	18mm
333211	11mm	333219	19mm
333212	12mm	333220	20mm
333213	13mm	333221	21mm
Socket Holder			



12 pt.

900 g 20x1 20 sets / 19 Kgs / 0.73 CUFT

## TW-314S 14 Piece 3/8" Dr. SAE Hand Socket Set (12-Point)

Item No.	Size	Item No.	Size
<b>3/8" Dr. 12pt Hand Socket:</b>			
373208	1/4"	373219	19/32"
373210	5/16"	373220	5/8"
373211	11/32"	373222	11/16"
373212	3/8"	373224	3/4"
373214	7/16"	373225	25/32"
373216	1/2"	373226	13/16"
373218	9/16"	373228	7/8"
Socket Holder			



12 pt.

800 g 20x1 20 sets / 17 Kgs / 0.92 CUFT

## TW-316MD 16 Piece 3/8" Dr. Metric Deep Hand Socket Set (12-Point)

Item No.	Size	Item No.	Size
<b>3/8" Dr. 12pt Deep Hand Socket:</b>			
336306	6mm	336314	14mm
336307	7mm	336315	15mm
336308	8mm	336316	16mm
336309	9mm	336317	17mm
336310	10mm	336318	18mm
336311	11mm	336319	19mm
336312	12mm	336320	20mm
336313	13mm	336321	21mm
Socket Holder			

6-point: GD-316M also available



12 pt.

1600 g 12x1 12 sets / 20 Kgs / 0.73 CUFT

## TW-314SD 14 Piece 3/8" Dr. SAE Deep Hand Socket Set (12-Point)

Item No.	Size	Item No.	Size
<b>3/8" Dr. 12pt Deep Hand Socket:</b>			
376308	1/4"	376319	19/32"
376310	5/16"	376320	5/8"
376311	11/32"	376322	11/16"
376312	3/8"	376324	3/4"
376314	7/16"	376325	25/32"
376316	1/2"	376326	13/16"
376318	9/16"	376328	7/8"
Socket Holder			



12 pt.

1400 g 12x1 12 sets / 18 Kgs / 0.73 CUFT





# Hand Socket Sets

## GS-313M 13 Piece 3/8" Dr. Metric Deep Hand Socket Set

Item No.	Size	Item No.	Size
<b>3/8" Dr. 6pt Deep Hand Socket:</b>			
326308	8mm	326313	13mm
326310	10mm	326314	14mm
326311	11mm	326317	17mm
326312	12mm	326319	19mm
<b>3/8" Dr. Spark Plug Socket:</b>			
326016	16.0mm	326021	20.6mm
<b>3/8" Dr. Accessory:</b>			
320075	Extension Bar, 75mmL		
320150	Extension Bar, 150mmL		
380333R	24T Reversible Ratchet		
Metal Box			

1900 g 10 sets / 20 Kgs / 0.77 CUFT



6 pt.

## GS-313S 13 Piece 3/8" Dr. SAE Deep Hand Socket Set

Item No.	Size	Item No.	Size
<b>3/8" Dr. 6pt Deep Hand Socket:</b>			
386310	5/16"	386318	9/16"
386312	3/8"	386320	5/8"
386314	7/16"	386322	11/16"
386316	1/2"	386324	3/4"
<b>3/8" Dr. Spark Plug Socket:</b>			
326016	5/8"	326021	13/16"
<b>3/8" Dr. Accessory:</b>			
320075	Extension Bar, 3"L		
320150	Extension Bar, 6"L		
380333R	24T Reversible Ratchet		
Metal Box			

1900 g 10 sets / 20 Kgs / 0.77 CUFT



6 pt.

## GS-320S 20 Piece 3/8" Dr. SAE Hand Socket Set

Item No.	Size	Item No.	Size
<b>3/8" Dr. 6pt Hand Socket:</b>			
383208	1/4"	383219	19/32"
383210	5/16"	383220	5/8"
383212	3/8"	383222	11/16"
383214	7/16"	383224	3/4"
383216	1/2"	383225	25/32"
383218	9/16"		
<b>3/8" Dr. Spark Plug Socket:</b>			
326016	5/8"	326021	13/16"
<b>3/8" Dr. Accessory:</b>			
320075	Extension Bar, 3"L		
320200	Extension Bar, 8"L		
380030	Sliding T-Handle		
380336A	Hinge Handle		
380333R	24T Reversible Ratchet		
Metal Box			

3000 g 6 sets / 19 Kgs / 0.7 CUFT



6 pt.



## GS-318M1 18 Piece 3/8" Dr. Metric Hand Socket Set

Item No.	Size	Item No.	Size
<b>3/8" Dr. 6pt Hand Socket:</b>			
323206	6mm	323214	14mm
323207	7mm	323215	15mm
323208	8mm	323216	16mm
323210	10mm	323217	17mm
323211	11mm	323219	19mm
323212	12mm	323221	21mm
323213	13mm		

### 3/8" Dr. Accessory:

320075	Extension Bar, 75mmL
320150	Extension Bar, 150mmL
380030	Sliding T-Handle
326021	20.6mm Spark Plug Socket
380333R	24T Reversible Ratchet
	Metal Box

2400 g 10 sets / 25 Kgs / 0.77 CUFT

Previous Item No.: GS-319M1

SAE size: GS-318S1 also available  
12pt: TW-318M1 & S1 also available



6 pt.

## GS-318M2 18 Piece 3/8" Dr. Metric Hand Socket Set

Item No.	Size	Item No.	Size
<b>3/8" Dr. 6pt Hand Socket:</b>			
323206	6mm	323214	14mm
323207	7mm	323215	15mm
323208	8mm	323216	16mm
323210	10mm	323217	17mm
323211	11mm	323219	19mm
323212	12mm	323222	22mm
323213	13mm		

### 3/8" Dr. Accessory:

320075	Extension Bar, 75mmL
320150	Extension Bar, 150mmL
380030	Sliding T-Handle
326021	20.6mm Spark Plug Socket
380333R	24T Reversible Ratchet
	Metal Box

2400 g 10 sets / 25 Kgs / 0.77 CUFT

Previous Item No.: GS-319M2



6 pt.

## GS-320M 20 Piece 3/8" Dr. Metric Hand Socket Set

Item No.	Size	Item No.	Size
<b>3/8" Dr. 6pt Hand Socket:</b>			
323206	6mm	323213	13mm
323208	8mm	323214	14mm
323209	9mm	323215	15mm
323210	10mm	323216	16mm
323211	11mm	323217	17mm
323212	12mm		

### 3/8" Dr. Spark Plug Socket:

326016	16.0mm	326021	20.6mm
--------	--------	--------	--------

### 3/8" Dr. Accessory:

320075	Extension Bar, 75mmL	380336A	Hinge Handle
320200	Extension Bar, 200mmL	380030	Sliding T-Handle
380333R	24T Reversible Ratchet		
	Metal Box		

3000 g 6 sets / 19 Kgs / 0.7 CUFT



6 pt.

Hand Sockets



**3/8**

# Hand Socket Sets

## GS-332MS 32 Piece 3/8" Dr. Metric & SAE Hand Socket Set

Item No.	Size	Item No.	Size
<b>3/8" Dr. 6pt Hand Socket:</b>			
323206	6mm	323219	19mm
323207	7mm	323221	21mm
323208	8mm	383208	1/4"
323209	9mm	383210	5/16"
323210	10mm	383212	3/8"
323211	11mm	383214	7/16"
323212	12mm	383216	1/2"
323213	13mm	383218	9/16"
323214	14mm	383220	5/8"
323215	15mm	383222	11/16"
323216	16mm	383224	3/4"
323217	17mm	383226	13/16"
323218	18mm	383228	7/8"

### 3/8" Dr. Accessory:

380030	Sliding T-Handle	320075	Extension Bar, 75mmL
380070	Universal Joint	320150	Extension Bar, 150mmL
380336A	Hinge Handle		
380333R	24T Reversible Ratchet		
Metal Box			

3450 g 6 sets / 22 Kgs / 0.7 CUFT



6 pt.

## GS-347MS 47 Piece 3/8" Dr. Metric & SAE Hand Socket Set

Item No.	Size	Item No.	Size
<b>3/8" Dr. 6pt Hand Socket:</b>			
323206	6mm	323219	19mm
323207	7mm	383208	1/4"
323208	8mm	383210	5/16"
323209	9mm	383212	3/8"
323210	10mm	383214	7/16"
323211	11mm	383216	1/2"
323212	12mm	383218	9/16"
323213	13mm	383220	5/8"
323214	14mm	383222	11/16"
323215	15mm	383224	3/4"
323216	16mm	383226	13/16"
323217	17mm	383228	7/8"
323218	18mm		

### 3/8" Dr. 6pt Deep Hand Socket:

326310	10mm	386312	3/8"
326311	11mm	386314	7/16"
326312	12mm	386316	1/2"
326313	13mm	386318	9/16"
326314	14mm	386320	5/8"
326315	15mm	386322	11/16"
326316	16mm	386324	3/4"
326317	17mm	386326	13/16"
326318	18mm	386328	7/8"
326319	19mm		

### 3/8" Dr. Accessory:

320075	Extension Bar, 75mmL
320150	Extension Bar, 150mmL
380372	72T Reversible Ratchet
Blow Case	

3750 g 4 sets / 16 Kgs / 1.07 CUFT



6 pt.

Made of Chrome Vanadium Steel

**ENIUS**  
PROFESSIONAL TOOLS

B-33



## AC-359 59 Piece 3/8" Dr. Metric Hand Socket & Bit Set (12-Point)

Item No.	Size	Item No.	Size	Item No.	Size
<b>3/8" Dr. 12pt Hand Socket:</b>			<b>Accessory:</b>		
333206	6mm	333215	15mm	320075	3/8" Dr. Extension Bar, 75mmL
333207	7mm	333216	16mm	320200	3/8" Dr. Extension Bar, 200mmL
333208	8mm	333217	17mm	380070	3/8" Dr. Universal Joint
333209	9mm	333218	18mm	320040	Adapter, 3/8"F x 1/2"M
333210	10mm	333219	19mm	326016	3/8" Dr. 16.0mm Spark Plug Socket
333211	11mm	333220	20mm	326021	3/8" Dr. 20.6mm Spark Plug Socket
333212	12mm	333221	21mm	380333R	3/8" Dr. 24T Reversible Ratchet
333213	13mm	333222	22mm	383908	3/8" Dr. 1/4" Hex Shank Bit Holder
333214	14mm			280150	1/4" Hex Shank Bit Holder with Handle
<b>3/8" Dr. 12pt Deep Hand Socket:</b>					Blow Case
336308	8mm	336314	14mm		
336310	10mm	336315	15mm		
336311	11mm	336317	17mm		
336312	12mm	336319	19mm		
336313	13mm				
<b>1/4" Hex Shank Screwdriver Bit, 30mmL:</b>					
1101	#1 Phillips	1150	0.8 x 5.0mm Slotted		
1102	#2 Phillips	1160	1.0 x 6.0mm Slotted		
1103	#3 Phillips	1170	1.2 x 7.0mm Slotted		
1211	#1 Posidriv	7110	T-10 Tamperproof Star		
1212	#2 Posidriv	7115	T-15 Tamperproof Star		
1213	#3 Posidriv	7120	T-20 Tamperproof Star		
2133	3mm	7125	T-25 Tamperproof Star		
2134	4mm	7130	T-30 Tamperproof Star		
2135	5mm	7140	T-40 Tamperproof Star		
2136	6mm	283045A	T-45 Tamperproof Star		
2137	7mm	283050A	T-50 Tamperproof Star		
2138	8mm	283055A	T-55 Tamperproof Star		



3400 g 4 sets / 14.5 Kgs / 1.07 CUFT

## EU-335M 35 Piece 3/8" Dr. Metric Deep Hand Socket Set (6 & 12-Point)

Item No.	Size	Item No.	Size	Item No.	Size
<b>3/8" Dr. 12pt Hand Socket:</b>			<b>3/8" Dr. Accessory:</b>		
333207	7mm	333215	15mm	320150	Extension Bar, 150mmL
333208	8mm	333216	16mm	320250	Extension Bar, 250mmL
333209	9mm	333217	17mm	380070	Universal Joint
333210	10mm	333218	18mm	380030	Sliding T-Handle
333211	11mm	333219	19mm	380331S	36T Quick Release Ratchet
333212	12mm	333221	21mm		Plastic Tray
333213	13mm	333222	22mm		
333214	14mm				
<b>3/8" Dr. 6pt Deep Hand Socket:</b>					
326307	7mm	326315	15mm		
326308	8mm	326316	16mm		
326309	9mm	326317	17mm		
326310	10mm	326318	18mm		
326311	11mm	326319	19mm		
326312	12mm	326321	21mm		
326313	13mm	326322	22mm		
326314	14mm				



(192W x 406D)

3450 g 5 sets / 18.5 Kgs / 0.93 CUFT

Hand Sockets



3/8

# Hand Socket Sets

## AC-359A 59 Piece 3/8" Dr. Metric Hand Socket & Bit Set

Item No.	Size	Item No.	Size	Item No.	Size
<b>3/8" Dr. 6pt Hand Socket:</b>					
323206	6mm	323215	15mm	320075	3/8" Dr. Extension Bar, 75mmL
323207	7mm	323216	16mm	320200	3/8" Dr. Extension Bar, 200mmL
323208	8mm	323217	17mm	380070	3/8" Dr. Universal Joint
323209	9mm	323218	18mm	320040	Adapter, 3/8"F x 1/2"M
323210	10mm	323219	19mm	326016	3/8" Dr. 16.0mm Spark Plug Socket
323211	11mm	323220	20mm	326021	3/8" Dr. 20.6mm Spark Plug Socket
323212	12mm	323221	21mm	380333R	3/8" Dr. 24T Reversible Ratchet
323213	13mm	323222	22mm	383908	3/8" Dr. 1/4" Hex Shank Bit Holder
323214	14mm			280150	1/4" Hex Shank Bit Holder with Handle
<b>3/8" Dr. 6pt Deep Hand Socket:</b>					
326308	8mm	326314	14mm	Blow Case	
326310	10mm	326315	15mm		
326311	11mm	326317	17mm		
326312	12mm	326319	19mm		
326313	13mm				
<b>1/4" Hex Shank Screwdriver Bit, 30mmL:</b>					
1101	#1 Philips	1150	0.8 x 5.0mm Slotted		
1102	#2 Philips	1160	1.0 x 6.0mm Slotted		
1103	#3 Philips	1170	1.2 x 7.0mm Slotted		
1211	#1 Posidriv	7110	T-10 Tamperproof Star		
1212	#2 Posidriv	7115	T-15 Tamperproof Star		
1213	#3 Posidriv	7120	T-20 Tamperproof Star		
2133	3mm	7125	T-25 Tamperproof Star		
2134	4mm	7130	T-30 Tamperproof Star		
2135	5mm	7140	T-40 Tamperproof Star		
2136	6mm	283045A	T-45 Tamperproof Star		
2137	7mm	283050A	T-50 Tamperproof Star		
2138	8mm	283055A	T-55 Tamperproof Star		

3400 g 4 sets / 14.5 Kgs / 1.07 CUFT



## GD-308M 8 Piece 3/8" Dr. Metric Deep Hand Socket Set

Item No.	Size	Item No.	Size
<b>3/8" Dr. 6pt Deep Hand Socket:</b>			
326308	8mm	326313	13mm
326310	10mm	326314	14mm
326311	11mm	326317	17mm
326312	12mm	326319	19mm
Socket Holder			

700 g 4x4 16 sets / 12.2 Kgs / 0.71 CUFT



SAE size: GD-308S also available

## TW-308MD 8 Piece 3/8" Dr. Metric Deep Hand Socket Set (12-Point)

Item No.	Size	Item No.	Size
<b>3/8" Dr. 12pt Deep Hand Socket:</b>			
336308	8mm	336313	13mm
336310	10mm	336314	14mm
336311	11mm	336317	17mm
336312	12mm	336319	19mm
Socket Holder			

700 g 4x4 16 sets / 12.2 Kgs / 0.71 CUFT



SAE size: TW-308SD also available

## EU-319M 19 Piece 3/8" Dr. Metric Hand Socket Set

Item No.	Size	Item No.	Size
<b>3/8" Dr. 6pt Hand Socket:</b>			
323208	8mm	323215	15mm
323209	9mm	323216	16mm
323210	10mm	323217	17mm
323211	11mm	323218	18mm
323212	12mm	323219	19mm
323213	13mm	323221	21mm
323214	14mm	323222	22mm

### 3/8" Dr. Accessory:

320025	Extension Bar, 25mmL
320075	Extension Bar, 75mmL
320250	Extension Bar, 250mmL
380070	Universal Joint
380372P	72T Reversible Ratchet Blow Case

1850 g 10 sets / 19.5 Kgs / 1.16 CUFT



6 pt.

## EU-354M 54 Piece 3/8" Dr. Metric Hand Socket & Hex Bit Socket Set

Item No.	Size	Item No.	Size
<b>3/8" Dr. 6pt Hand Socket:</b>			
323207	7mm	323215	15mm
323208	8mm	323216	16mm
323209	9mm	323217	17mm
323210	10mm	323218	18mm
323211	11mm	323219	19mm
323212	12mm	323221	21mm
323213	13mm	323222	22mm
323214	14mm		

### 3/8" Dr. 12pt Deep Hand Socket:

336307	7mm	336315	15mm
336308	8mm	336316	16mm
336309	9mm	336317	17mm
336310	10mm	336318	18mm
336311	11mm	336319	19mm
336312	12mm	336321	21mm
336313	13mm	336322	22mm
336314	14mm		

### 3/8" Dr. Hex Bit Socket, 50mmL:

308+2133	3mm	310+2147	7mm
308+2134	4mm	310+2148	8mm
308+2135	5mm	340+2150	10mm
308+2136	6mm		

### Screwdriver Bit, 30mmL

1101	1/4"H x #1 Phillips	1155	1/4"H x 0.8 x 5.5mm
1102	1/4"H x #2 Phillips	1165	1/4"H x 1.0 x 6.5mm
1103	1/4"H x #3 Phillips	1280	5/16"H x 1.2 x 8.0mm
1124	5/16"H x #4 Phillips	1290	5/16"H x 1.6 x 9.0mm

5100 g 4 sets / 21.5 Kgs / 1.65 CUFT

Item No.	Size
<b>3/8" Dr. Accessory:</b>	
320150	Extension Bar, 150mmL
320250	Extension Bar, 250mmL
380030	Sliding T-Handle
380070	Universal Joint
380400	Speed Handle
380338S	Hinge Handle
383908	1/4" Hex Shank Bit Holder
383910	5/16" Hex Shank Bit Holder
380331S	36T Quick Release Ratchet Blow Case



6 pt.

12 pt.



**1/4****3/8**

# Hand Socket Sets

## GS-2343MS 43 Piece 1/4" & 3/8" Dr. Metric & SAE Hand Socket Set

Item No.	Size	Item No.	Size
<b>1/4" Dr. 6pt Hand Socket:</b>			
222504	4mm	282504	1/8"
2225045	4.5mm	282506	3/16"
222505	5mm	282507	7/32"
222506	6mm	282508	1/4"
222507	7mm	282509	9/32"
222508	8mm	282510	5/16"
222509	9mm	282511	11/32"
222510	10mm	282512	3/8"
222511	11mm	282514	7/16"
222512	12mm	282516	1/2"

Item No.	Size	Item No.	Size
<b>3/8" Dr. 6pt Hand Socket:</b>			
323209	9mm	383212	3/8"
323210	10mm	383214	7/16"
323211	11mm	383216	1/2"
323212	12mm	383218	9/16"
323213	13mm	383220	5/8"
323214	14mm	383222	11/16"
323216	16mm	383224	3/4"
323217	17mm		
323219	19mm		

Item No.	Size
<b>Accessory:</b>	
220150	1/4" Dr. Socket Driver
326021	3/8" Dr. 20.6mm Spark Plug Socket
320075	3/8" Dr. Extension Bar, 75mmL
320200	3/8" Dr. Extension Bar, 200mmL
320020	3/8" Dr. Adapter, 3/8"F x 1/4"M
380030	3/8" Dr. Sliding T-Handle
380333R	3/8" Dr. 24T Reversible Ratchet Metal Box

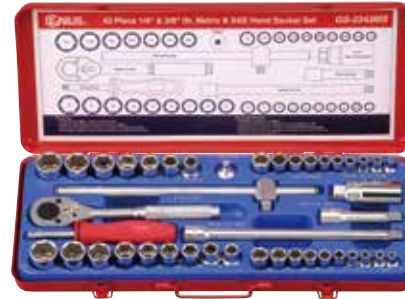
**6 pt.**

3000 g      6 sets / 19 Kgs / 0.7 CUFT

## GS-2353M 53 Piece 1/4" & 3/8" Dr. Metric Deep Hand Socket Set

Item No.	Size	Item No.	Size
<b>1/4" Dr. 6pt Hand Socket:</b>			
222504	4mm	222509	9mm
2225045	4.5mm	222510	10mm
222505	5mm	222511	11mm
2225055	5.5mm	222512	12mm
222506	6mm	222513	13mm
222507	7mm	222514	14mm
222508	8mm		
<b>1/4" Dr. 6pt Deep Hand Socket:</b>			
225205	5mm	225210	10mm
225206	6mm	225211	11mm
225207	7mm	225212	12mm
225208	8mm	225213	13mm
225209	9mm	225214	14mm

<b>3/8" Dr. 6pt Hand Socket:</b>			
323206	6mm	323213	13mm
323207	7mm	323214	14mm
323208	8mm	323215	15mm
323209	9mm	323216	16mm
323210	10mm	323217	17mm
323211	11mm	323218	18mm
323212	12mm	323219	19mm

<b>3/8" Dr. 6pt Deep Hand Socket:</b>			
326310	10mm	326315	15mm
326311	11mm	326316	16mm
326312	12mm	326317	17mm
326313	13mm	326318	18mm
326314	14mm	326319	19mm

Item No.	Size
<b>Accessory:</b>	
220002	1/4" Dr. Extension Bar, 50mmL
220006	1/4" Dr. Extension Bar, 150mmL
280272	1/4" Dr. Reversible Ratchet
320075	3/8" Dr. Extension Bar, 75mmL
320150	3/8" Dr. Extension Bar, 150mmL
380372	3/8" Dr. 72T Reversible Ratchet Blow Case

**6 pt.**

3400 g      6 sets / 21.5 Kgs / 1.12 CUFT

Made of Chrome Vanadium Steel

**ENIUS**<sup>®</sup>  
PROFESSIONAL TOOLS

**B-37**

## Metric Hand Sockets

Item No.	A mm	D1 mm	D2 mm	Length mm	Weight g	PCS	G.W. KGS	CUFT
						inner/ctn		
423808	8	12.8	23.3	38	55	10 / 200	12.0	0.59
423809	9	14.0	23.3	38	55	10 / 200	12.0	0.59
423810	10	14.9	23.3	38	55	10 / 200	13.0	0.59
423811	11	15.6	23.3	38	55	10 / 200	13.0	0.59
423812	12	17.8	23.3	38	60	10 / 200	13.0	0.59
423813	13	18.8	23.3	38	60	10 / 200	14.0	0.59
423814	14	20.4	23.3	38	65	10 / 200	14.0	0.59
423815	15	21.5	23.3	38	65	10 / 200	15.0	0.59
423816	16	22.8	23.8	38	70	10 / 200	16.0	0.59
423817	17	23.8	23.0	38	70	10 / 200	16.0	0.59
423818	18	25.8	24.0	38	80	10 / 200	17.0	0.59
423819	19	26.8	25.0	40	85	10 / 200	19.0	0.59
423820	20	27.8	26.0	40	95	10 / 200	21.0	0.59
423821	21	29.5	27.5	40	100	10 / 150	17.5	0.52
423822	22	29.8	28.0	42	120	10 / 150	20.5	0.52
423823	23	31.7	29.0	42	130	10 / 150	22.0	0.52
423824	24	32.8	30.0	44	150	10 / 150	23.5	0.52
423825	25	33.8	31.0	44	160	10 / 100	17.0	0.62
423826	26	35.5	32.5	44	180	10 / 100	19.0	0.62
423827	27	36.7	33.5	46	190	10 / 100	21.0	0.62
423828	28	37.8	35.0	46	200	10 / 100	22.0	0.62
423829	29	37.8	36.0	46	220	10 / 100	23.0	0.62
423830	30	40.8	37.0	46	240	10 / 100	26.0	0.62
423831	31	41.8	38.0	46	260	10 / 100	27.0	0.62
423832	32	42.8	39.5	46	260	10 / 100	28.0	0.62
423833	33	43.8	40.5	46	290	10 / 100	30.0	0.62
423834	34	45.8	42.0	46	310	5 / 50	17.0	0.41
423835	35	46.8	43.0	48	340	5 / 30	11.0	0.34
423836	36	47.8	44.5	48	370	5 / 30	12.0	0.34
423837	37	49.0	45.0	48	380	5 / 30	12.5	0.34
423838	38	50.5	47.0	48	410	5 / 30	13.0	0.34
423839	39	51.7	47.0	50	440	5 / 30	14.5	0.34
423840	40	52.8	48.0	55	510	5 / 30	16.5	0.34
423841	41	53.8	48.0	55	520	5 / 30	17.0	0.34

6 pt.

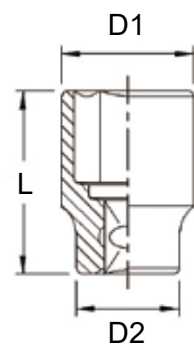
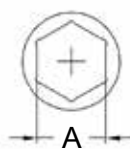

## SAE Hand Sockets

Item No.	A inch	D1 mm	D2 mm	Length mm	Weight g	PCS	G.W. KGS	CUFT
						inner/ctn		
483810	5/16	12.8	23.3	38	55	10 / 200	12.0	0.59
483812	3/8	14.7	23.3	38	55	10 / 200	12.0	0.59
483814	7/16	16.7	23.3	38	55	10 / 200	13.0	0.59
483816	1/2	18.6	23.3	38	60	10 / 200	13.0	0.59
483818	9/16	20.6	23.3	38	60	10 / 200	14.0	0.59
483819	19/32	21.5	23.3	38	65	10 / 200	15.0	0.59
483820	5/8	22.6	23.8	38	70	10 / 200	16.0	0.59
483821	21/32	23.8	22.8	38	70	10 / 200	16.0	0.59
483822	11/16	24.8	23.0	38	70	10 / 200	17.0	0.59
483824	3/4	26.8	25.0	40	85	10 / 200	19.0	0.59
483825	25/32	27.8	26.0	40	95	10 / 200	21.0	0.59
483826	13/16	28.8	27.5	40	110	10 / 150	17.5	0.52
483828	7/8	30.8	28.0	42	120	10 / 150	20.5	0.52
483830	15/16	32.8	30.0	44	150	10 / 150	23.5	0.52
483832	1	34.8	31.5	44	170	10 / 100	18.0	0.62
483834	1-1/16	36.8	33.5	46	190	10 / 100	21.0	0.62
483836	1-1/8	38.8	35.5	46	220	10 / 100	23.0	0.62
483838	1-3/16	40.8	37.0	46	240	10 / 100	25.0	0.62
483840	1-1/4	42.8	39.5	46	260	10 / 100	27.0	0.62
483842	1-5/16	44.0	40.5	46	290	5 / 50	15.5	0.41
483844	1-3/8	46.6	43.0	48	350	5 / 50	17.5	0.41
483846	1-7/16	48.0	44.5	48	380	5 / 50	20.0	0.41
483848	1-1/2	50.6	47.0	48	410	5 / 30	13.5	0.34
483850	1-9/16	52.6	48.0	55	510	5 / 30	15.5	0.34
483852	1-5/8	53.8	48.0	55	520	5 / 30	16.0	0.34

Hand Sockets





## Metric Deep Hand Sockets

Item No.	A mm	D1 mm	D2 mm	Length mm	Weight g	PCS		G.W. KGS	CUFT 
						inner/ctn			
427808	8	12.8	23.3	78	110	10 / 140	18.0	0.44	
427809	9	14.0	23.3	78	120	10 / 140	18.0	0.44	
427810	10	14.9	23.3	78	120	10 / 140	18.0	0.44	
427811	11	16.6	23.3	78	120	10 / 140	19.0	0.44	
427812	12	17.8	23.3	78	120	10 / 140	19.0	0.44	
427813	13	18.8	23.3	78	130	10 / 140	19.0	0.44	
427814	14	20.4	23.3	78	130	10 / 140	20.5	0.44	
427815	15	21.5	23.3	78	140	10 / 140	20.5	0.44	
427816	16	22.8	23.8	78	150	10 / 140	22.0	0.44	
427817	17	23.8	23.0	78	150	10 / 120	19.0	0.52	
427818	18	25.8	24.0	78	160	10 / 120	20.5	0.52	
427819	19	26.8	25.0	78	170	10 / 120	21.5	0.52	
427820	20	27.8	26.0	78	180	10 / 120	22.5	0.52	
427821	21	29.5	27.5	78	190	10 / 120	24.0	0.52	
427822	22	29.8	28.0	78	220	10 / 120	28.0	0.52	
427823	23	31.8	29.0	78	240	10 / 60	15.5	0.45	
427824	24	32.8	30.5	78	240	10 / 60	15.5	0.45	
427825	25	34.5	31.0	78	250	10 / 60	16.0	0.45	
427826	26	35.8	32.5	78	280	10 / 60	18.5	0.45	
427827	27	36.8	33.5	78	290	10 / 60	19.0	0.45	
427828	28	37.8	35.0	78	310	10 / 60	19.5	0.45	
427829	29	39.5	36.0	78	330	5 / 50	17.5	0.62	
427830	30	40.5	37.0	78	360	5 / 50	19.5	0.62	
427831	31	41.8	38.0	78	390	5 / 50	21.0	0.62	
427832	32	42.8	39.5	78	410	5 / 50	22.0	0.62	
427833	33	43.8	40.5	78	430	5 / 50	22.5	0.62	
427834	34	45.8	42.0	78	480	5 / 50	25.5	0.62	
427835	35	46.8	43.0	78	500	5 / 50	26.5	0.62	
427836	36	47.8	44.5	78	510	5 / 50	27.0	0.62	
427837	37	49.0	45.0	78	560	1 / 30	18.0	0.52	
427838	38	50.5	47.0	78	590	1 / 30	19.0	0.52	
427839	39	51.7	47.0	78	650	1 / 30	21.0	0.52	
427840	40	52.8	48.0	78	720	1 / 30	23.0	0.52	
427841	41	53.8	48.0	78	750	1 / 30	24.0	0.52	

6 pt.



## SAE Deep Hand Sockets

Item No.	A inch	D1 mm	D2 mm	Length mm	Weight g	PCS		G.W. KGS	CUFT 
						inner/ctn			
487810	5/16	12.8	23.3	78	120	10 / 140	18.0	0.44	
487812	3/8	14.7	23.8	78	120	10 / 140	18.0	0.44	
487814	7/16	16.7	23.3	78	120	10 / 140	19.0	0.44	
487816	1/2	18.6	23.3	78	120	10 / 140	19.0	0.44	
487818	9/16	20.6	23.3	78	130	10 / 140	20.5	0.44	
487819	19/32	21.5	23.3	78	140	10 / 140	20.5	0.44	
487820	5/8	22.6	23.8	78	150	10 / 140	22.0	0.44	
487822	11/16	24.8	23.0	78	160	10 / 120	20.0	0.52	
487824	3/4	26.8	25.0	78	170	10 / 120	21.5	0.52	
487825	25/32	27.8	26.0	78	180	10 / 120	24.0	0.52	
487826	13/16	28.8	27.5	78	200	10 / 120	25.0	0.52	
487828	7/8	29.8	28.0	78	230	10 / 120	29.0	0.52	
487830	15/16	32.8	30.0	78	240	10 / 60	15.5	0.45	
487832	1	34.8	31.5	78	260	10 / 60	17.0	0.45	
487834	1-1/16	36.8	33.5	78	290	10 / 60	19.0	0.45	
487836	1-1/8	38.8	35.5	78	330	10 / 60	21.0	0.45	
487838	1-3/16	40.8	37.0	78	360	5 / 50	19.5	0.62	
487840	1-1/4	42.8	39.5	78	410	5 / 50	22.0	0.62	
487842	1-5/16	43.8	40.5	78	410	1 / 30	14.0	0.52	
487844	1-3/8	46.8	43.0	78	500	1 / 30	16.0	0.52	
487846	1-7/16	48.0	44.5	78	520	1 / 30	17.0	0.52	
487848	1-1/2	50.6	47.0	78	590	1 / 30	19.0	0.52	
487850	1-9/16	52.6	48.0	78	720	1 / 30	23.0	0.52	
487852	1-5/8	53.8	48.0	78	750	1 / 30	24.0	0.52	

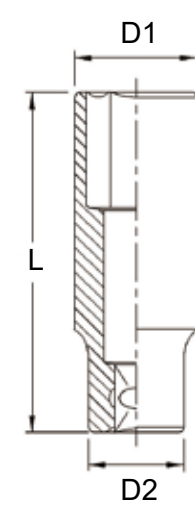

## Metric Hand Sockets (12-Point)

Item No.	A mm	D1 mm	D2 mm	Length mm	Weight g	PCS inner/ctn	G.W. KGS	CUFT
433808	8	12.8	23.3	38	55	10 / 200	12.0	0.59
433809	9	14.0	23.3	38	55	10 / 200	12.0	0.59
433810	10	15.3	23.3	38	55	10 / 200	13.0	0.59
433811	11	16.5	23.3	38	55	10 / 200	13.0	0.59
433812	12	17.8	23.3	38	60	10 / 200	13.0	0.59
433813	13	19.0	23.3	38	60	10 / 200	14.0	0.59
433814	14	20.3	23.3	38	60	10 / 200	14.0	0.59
433815	15	21.5	23.3	38	65	10 / 200	15.0	0.59
433816	16	22.8	23.8	38	70	10 / 200	16.0	0.59
433817	17	23.8	23.0	38	75	10 / 200	16.0	0.59
433818	18	25.8	24.0	38	80	10 / 200	17.0	0.59
433819	19	26.8	25.0	40	85	10 / 200	19.0	0.59
433820	20	27.8	26.0	40	90	10 / 200	21.0	0.59
433821	21	29.5	27.5	40	100	10 / 150	17.5	0.52
433822	22	29.8	28.0	42	120	10 / 150	20.5	0.52
433823	23	31.8	29.0	42	130	10 / 150	22.0	0.52
433824	24	32.8	30.0	44	140	10 / 150	23.5	0.52
433825	25	33.8	31.0	44	150	10 / 100	17.0	0.62
433826	26	35.8	32.5	44	170	10 / 100	19.0	0.62
433827	27	36.8	33.5	46	190	10 / 100	21.0	0.62
433828	28	37.8	35.0	46	200	10 / 100	21.0	0.62
433829	29	37.8	36.0	46	210	10 / 100	22.0	0.62
433830	30	40.8	37.0	46	230	10 / 100	25.0	0.62
433831	31	41.7	38.0	46	250	10 / 100	26.0	0.62
433832	32	42.8	39.5	46	260	10 / 100	27.0	0.62
433833	33	43.8	40.5	46	270	10 / 100	28.0	0.62
433834	34	45.5	42.0	46	310	5 / 50	17.0	0.41
433835	35	45.8	43.0	48	340	5 / 30	11.0	0.34
433836	36	47.8	44.5	48	370	5 / 30	12.0	0.34
433837	37	47.8	45.0	48	380	5 / 30	12.5	0.34
433838	38	50.5	47.0	48	410	5 / 30	13.0	0.34
433839	39	51.7	47.0	50	440	5 / 30	14.5	0.34
433840	40	52.8	48.0	55	510	5 / 30	16.5	0.34
433841	41	53.8	48.0	55	520	5 / 30	17.0	0.34



## SAE Hand Sockets (12-Point)

Item No.	A inch	D1 mm	D2 mm	Length mm	Weight g	PCS inner/ctn	G.W. KGS	CUFT
473810	5/16	12.7	23.3	38	55	10 / 200	12.0	0.59
473812	3/8	14.7	23.3	38	55	10 / 200	12.0	0.59
473814	7/16	16.7	23.3	38	55	10 / 200	13.0	0.59
473816	1/2	18.6	23.3	38	60	10 / 200	14.0	0.59
473818	9/16	20.6	23.3	38	60	10 / 200	14.0	0.59
473819	19/32	21.6	23.3	38	65	10 / 200	15.0	0.59
473820	5/8	22.6	23.8	38	70	10 / 200	16.0	0.59
473821	21/32	23.8	22.8	38	85	10 / 200	17.0	0.59
473822	11/16	24.8	23.0	38	85	10 / 200	17.0	0.59
473824	3/4	26.8	25.0	40	85	10 / 200	18.0	0.59
473825	25/32	27.8	26.0	40	90	10 / 200	19.0	0.59
473826	13/16	28.8	27.5	40	100	10 / 150	17.5	0.52
473828	7/8	29.8	28.0	42	120	10 / 150	20.5	0.52
473830	15/16	32.8	30.0	44	140	10 / 150	23.5	0.52
473832	1	34.8	31.5	44	160	10 / 100	18.0	0.62
473834	1-1/16	36.8	33.5	46	190	10 / 100	21.0	0.62
473836	1-1/8	37.8	35.5	46	210	10 / 100	23.0	0.62
473838	1-3/16	40.8	37.0	46	240	10 / 100	25.0	0.62
473840	1-1/4	42.8	39.5	46	260	10 / 100	27.5	0.62
473842	1-5/16	43.8	40.5	46	290	5 / 50	15.5	0.41
473844	1-3/8	46.0	43.0	48	350	5 / 50	17.5	0.41
473846	1-7/16	48.0	44.5	48	380	5 / 50	20.0	0.41
473848	1-1/2	50.6	47.0	48	410	5 / 30	13.5	0.34
473850	1-9/16	52.6	48.0	55	510	5 / 30	16.5	0.34
473852	1-5/8	53.8	48.0	55	520	5 / 30	17.0	0.34

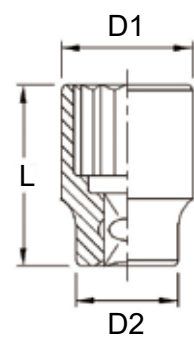
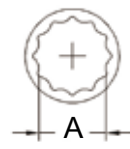

Hand Sockets



## Metric Deep Hand Sockets (12-Point)

Item No.	A mm	D1 mm	D2 mm	Length mm	Weight g	PCS inner/ctn	G.W. KGS	CUFT
437808	8	12.8	23.3	78	110	10 / 140	18.0	0.44
437809	9	14.0	23.3	78	120	10 / 140	18.0	0.44
437810	10	15.3	23.3	78	120	10 / 140	18.0	0.44
437811	11	16.5	23.3	78	120	10 / 140	18.0	0.44
437812	12	17.8	23.3	78	120	10 / 140	18.0	0.44
437813	13	19.0	23.3	78	130	10 / 140	19.0	0.44
437814	14	20.3	23.3	78	130	10 / 140	19.0	0.44
437815	15	21.5	23.3	78	140	10 / 140	20.5	0.44
437816	16	22.8	23.8	78	140	10 / 140	22.0	0.44
437817	17	23.8	23.0	78	140	10 / 120	19.0	0.52
437818	18	25.8	24.0	78	150	10 / 120	20.0	0.52
437819	19	26.8	25.0	78	160	10 / 120	21.0	0.52
437820	20	27.8	26.0	78	170	10 / 120	22.5	0.52
437821	21	29.5	27.5	78	180	10 / 120	24.0	0.52
437822	22	29.8	28.0	78	220	10 / 120	28.0	0.52
437823	23	31.8	29.0	78	240	10 / 60	15.5	0.45
437824	24	32.8	30.0	78	240	10 / 60	15.5	0.45
437825	25	33.8	31.0	78	240	10 / 60	16.0	0.45
437826	26	35.8	32.5	78	260	10 / 60	17.0	0.45
437827	27	36.8	33.5	78	280	10 / 60	18.0	0.45
437828	28	37.8	35.0	78	290	10 / 60	19.0	0.45
437829	29	37.8	36.0	78	320	5 / 50	17.5	0.62
437830	30	40.8	37.0	78	350	5 / 50	18.5	0.62
437831	31	41.8	38.0	78	360	5 / 50	19.5	0.62
437832	32	42.8	39.5	78	390	5 / 50	21.0	0.62
437833	33	43.8	40.5	78	430	5 / 50	22.5	0.62
437834	34	44.8	42.0	78	480	5 / 50	25.5	0.62
437835	35	46.8	43.0	78	500	5 / 50	26.5	0.62
437836	36	47.8	44.5	78	510	5 / 50	27.0	0.62
437837	37	47.8	45.0	78	560	1 / 30	18.0	0.52
437838	38	50.5	47.0	78	590	1 / 30	19.0	0.52
437839	39	51.7	47.0	78	650	1 / 30	21.0	0.52
437840	40	52.8	48.0	78	720	1 / 30	23.0	0.52
437841	41	53.8	48.0	78	750	1 / 30	24.0	0.52

## SAE Deep Hand Sockets (12-Point)

Item No.	A inch	D1 mm	D2 mm	Length mm	Weight g	PCS inner/ctn	G.W. KGS	CUFT
477810	5/16	12.8	23.3	78	110	10 / 140	18.0	0.44
477812	3/8	14.7	23.3	78	110	10 / 140	18.0	0.44
477814	7/16	16.7	23.3	78	120	10 / 140	19.0	0.44
477816	1/2	18.6	23.3	78	120	10 / 140	19.0	0.44
477818	9/16	20.6	23.3	78	140	10 / 140	20.5	0.44
477819	19/32	21.5	23.3	78	140	10 / 140	20.5	0.44
477820	5/8	22.6	23.8	78	160	10 / 140	24.0	0.44
477822	11/16	23.8	23.0	78	160	10 / 120	20.0	0.52
477824	3/4	26.8	25.0	78	160	10 / 120	21.0	0.52
477825	25/32	27.8	26.0	78	170	10 / 120	22.0	0.52
477826	13/16	28.8	27.5	78	200	10 / 120	25.5	0.52
477828	7/8	29.8	28.0	78	220	10 / 120	28.0	0.52
477830	15/16	32.8	30.0	78	220	10 / 60	15.0	0.45
477832	1	33.8	31.5	78	230	10 / 60	15.5	0.45
477834	1-1/16	36.8	33.5	78	280	10 / 60	19.0	0.45
477836	1-1/8	37.8	35.5	78	330	10 / 60	21.0	0.45
477838	1-3/16	40.8	37.0	78	350	5 / 50	18.5	0.62
477840	1-1/4	42.8	39.5	78	400	5 / 50	21.0	0.62
477842	1-5/16	43.8	40.5	78	410	1 / 30	14.0	0.52
477844	1-3/8	46.8	43.0	78	500	1 / 30	16.0	0.52
477846	1-7/16	47.8	44.5	78	520	1 / 30	17.0	0.52
477848	1-1/2	50.6	47.0	78	590	1 / 30	19.0	0.52
477850	1-9/16	52.6	48.0	78	720	1 / 30	23.0	0.52
477852	1-5/8	53.8	48.0	78	750	1 / 30	24.0	0.52

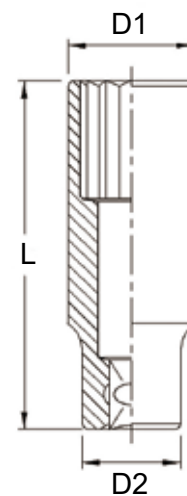

## E-Star Hand Sockets

Item No.	A Size	D1 mm	D2 mm	Length mm	Weight g	PCS	G.W. KGS	CUFT
						inner/ctn		
454508	E-8	11	22	38	50	10 / 200	12.0	0.59
454510	E-10	13	22	38	50	10 / 200	12.0	0.59
454511	E-11	14	22	38	50	10 / 200	12.0	0.59
454512	E-12	15	22	38	55	10 / 200	12.0	0.59
454514	E-14	17	22	38	55	10 / 200	12.0	0.59
454516	E-16	19	22	38	60	10 / 200	13.0	0.59
454518	E-18	21	24	40	80	10 / 200	17.0	0.59
454520	E-20	23	26	40	95	10 / 200	21.0	0.59
454522	E-22	25	26	40	100	10 / 200	21.5	0.59
454524	E-24	27	28	40	120	10 / 150	19.5	0.52
454526	E-26	30	27	44	140	10 / 150	22.0	0.52
454528	E-28	32	29	44	160	10 / 150	26.0	0.52
454530	E-30	34	31	46	190	10 / 100	21.0	0.62
454532	E-32	36	33	46	210	10 / 100	23.0	0.62

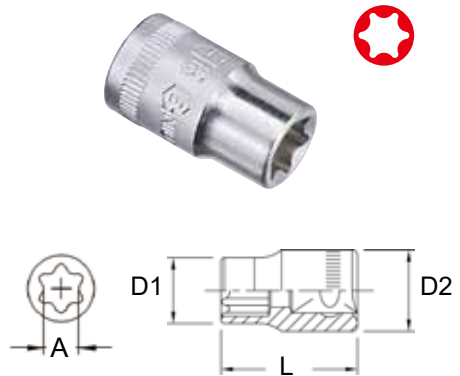

## E-Star Deep Hand Sockets

Item No.	A Size	D1 mm	D2 mm	Length mm	Weight g	PCS	G.W. KGS	CUFT
						inner/ctn		
457808	E-8	11	23.5	78	110	10 / 140	16.0	0.44
457810	E-10	13	23.5	78	110	10 / 140	17.0	0.44
457811	E-11	14	23.5	78	120	10 / 140	18.0	0.44
457812	E-12	15	23.5	78	120	10 / 140	18.0	0.44
457814	E-14	17	23.5	78	130	10 / 140	20.0	0.44
457816	E-16	19	23.5	78	140	10 / 140	21.0	0.44
457818	E-18	21	24	78	150	10 / 140	22.0	0.44
457820	E-20	23	26	78	180	10 / 120	23.0	0.52
457822	E-22	25	26	78	190	10 / 120	24.0	0.52
457824	E-24	27	28	78	220	10 / 120	28.0	0.52
457826	E-26	30	27	78	250	10 / 60	16.0	0.45
457828	E-28	32	29	78	280	10 / 60	18.0	0.45
457830	E-30	34	31	78	310	10 / 60	20.0	0.45
457832	E-32	36	33	78	350	10 / 60	22.0	0.45



## Adapters

Item No.	Female Drive	Male Drive	Length mm	Weight g	PCS	G.W. KGS	CUFT
					inner/ctn		
420033	1/2"	3/8"	38	65	10 / 200	14.0	0.59
420066	1/2"	3/4"	41	100	10 / 200	21.5	0.59



## Bit Holders

Item No.	Hex Shank	Length mm	Weight g	PCS	G.W. KGS	CUFT
				inner/ctn		
484108	1/4"	41	55	10 / 200	13.0	0.52
484808	1/4"	48	60	10 / 200	14.0	0.52
484110	5/16"	41	60	10 / 200	14.0	0.52
484810	5/16"	48	65	10 / 200	15.0	0.52
484112	3/8"	41	70	10 / 200	16.0	0.52
484314	7/16"	43	90	10 / 200	20.0	0.52
484516	1/2"	45	95	10 / 200	21.0	0.52
424110	10mm	41	70	10 / 200	16.0	0.52
424312	12mm	43	90	10 / 200	19.5	0.52
424514	14mm	45	100	10 / 200	21.0	0.52



## Speed Handles

Item No.	Length mm	Weight g	PCS	G.W. KGS	CUFT
			inner/ctn		
480420	420	660	1 / 30	21.0	1.65
480490	490	850	1 / 20	17.5	1.25



**Universal Joint**

Item No.	Outside Diameter		Length mm	Weight g	PCS inner/ctn	G.W. KGS	CUFT
	mm	inch					
480070	25mm		78	160	10 / 120	19.0	0.52



**Spark Plug Sockets**

Item No.	Size		Length mm	Weight g	PCS inner/ctn	G.W. KGS	CUFT
	mm	inch					
427016	16.0	5/8"	70	110	10 / 140	16.0	0.44
427021	20.6	13/16"	70	160	10 / 120	20.5	0.52



**Swivel Spark Plug Sockets**

Item No.	Size		Length mm	Weight g	PCS inner/ctn	G.W. KGS	CUFT
	mm	inch					
418516	16.0	5/8"	95	160	15 / 90	15.5	0.92
418521	20.6	13/16"	95	210	15 / 90	21.0	0.92



**T-Handle Spark Plug Sockets**

Item No.	Size		Type	Length mm	Weight g	PCS inner/ctn	G.W. KGS	CUFT
	mm (inch)							
4238014T	14.0		12pt	380	400	15 / 30	13.0	1.13
4238016T	16.0 (5/8")		6pt	380	420	15 / 30	14.0	1.13
4238021T	20.6 (13/16")		6pt	380	480	15 / 30	16.0	1.13
4253014T	14.0		12pt	530	470	1 / 15	8.0	0.46
4253016T	16.0 (5/8")		6pt	530	530	1 / 15	9.0	0.46
4253021T	20.6 (13/16")		6pt	530	600	1 / 15	10.0	0.46



**T-Handles (Ball Joint)**

Item No.	Length mm	Weight g	PCS inner/ctn	G.W. KGS	CUFT
425004T	500	500	1 / 20	11.0	0.46



**T-Handles (Quick Release)**

Item No.	Length mm	Weight g	PCS inner/ctn	G.W. KGS	CUFT
427004	700	1130	1 / 15	18.0	0.44



**T-Handles (Universal Joint)**

Item No.	Length mm	Weight g	PCS inner/ctn	G.W. KGS	CUFT
427004U	700	1230	1 / 15	19.5	0.44



**Sliding T-Handle**

Item No.	Length mm	Weight g	PCS inner/ctn	G.W. KGS	CUFT



**L-Handle**

Item No.	Length mm	Weight g	PCS inner/ctn	G.W. KGS	CUFT





## 36 Teeth Ratchet w/ Quick Release

Item No.	Length mm	Weight g	PCS inner/ctn	G.W. KGS	CUFT
480431R	255	630	1 / 30	21.0	0.65



## 36 Teeth Ratchet w/ Quick Release

Item No.	Length mm	Weight g	PCS inner/ctn	G.W. KGS	CUFT
480431P	275	660	1 / 40	27.5	0.92



## 36 Teeth Ratchet w/ Quick Release

Item No.	Length mm	Weight g	PCS inner/ctn	G.W. KGS	CUFT
480431S	285	610	1 / 40	25.5	0.92



## 24 Teeth Reversible Ratchet

Item No.	Length mm	Weight g	PCS inner/ctn	G.W. KGS	CUFT
480444R	250	570	1 / 30	19.0	0.65



## 24 Teeth Sanitary Ratchet

Item No.	Length mm	Weight g	PCS inner/ctn	G.W. KGS	CUFT
480444H	275	590	10 / 40	26.5	1.50

• Used with 1/2" Square Head could be effectively operated as the function of 1/2" Reversible Ratchet



## 24 Teeth "Spud" Reversible Ratchet

Item No.	Length mm	Weight g	PCS inner/ctn	G.W. KGS	CUFT
480415	380	680	1 / 30	23.0	0.95



## Hinge Handle

Item No.	Length mm	Weight g	PCS inner/ctn	G.W. KGS	CUFT
480446	380	630	5 / 30	20.0	0.45



## Hinge Handle

Item No.	Length mm	Weight g	PCS inner/ctn	G.W. KGS	CUFT
480446A	380	730	5 / 30	23.0	0.45



## Hinge Handles

Item No.	Length mm	Weight g	PCS inner/ctn	G.W. KGS	CUFT
480446P	410	670	1 / 30	22.0	0.69
480448P	620	1040	1 / 20	22.5	0.85



## Hinge Handles

Item No.	Length mm	Weight g	PCS inner/ctn	G.W. KGS	CUFT
480446S	420	700	1 / 30	22.0	0.69
480448S	630	1070	1 / 20	22.5	0.85





## 72 Teeth Reversible Ratchet

Item No.	Length mm	Weight g	PCS inner/ctn	G.W. KGS	CUFT
480472	245	510	5 / 30	16.5	1.21

## 72 Teeth Reversible Ratchet

Item No.	Length mm	Weight g	PCS inner/ctn	G.W. KGS	CUFT
480472P	275	510	5 / 30	16.5	1.21

## 72 Teeth Reversible Ratchet

Item No.	Length mm	Weight g	PCS inner/ctn	G.W. KGS	CUFT
480472S	285	520	1 / 40	22.0	0.92

## 72 Teeth Flex Head Ratchet

Item No.	Length mm	Weight g	PCS inner/ctn	G.W. KGS	CUFT
484464	400	900	1 / 20	19.0	0.62

## 72 Teeth Flex Head Ratchets

Item No.	Length mm	Weight g	PCS inner/ctn	G.W. KGS	CUFT
484464P	430	850	1 / 20	18.0	0.62
484468P	650	1190	1 / 20	24.0	0.82

## 72 Teeth Flex Head Ratchets

Item No.	Length mm	Weight g	PCS inner/ctn	G.W. KGS	CUFT
484464S	430	850	1 / 20	18.0	0.74
484468S	650	1150	1 / 20	24.0	0.82

## 72 Teeth Rotor Ratchet

Item No.	Length mm	Weight g	PCS inner/ctn	G.W. KGS	CUFT
481804	280	700	10 / 30	22.0	0.95

## 72 Teeth Rotor Ratchet

Item No.	Length mm	Weight g	PCS inner/ctn	G.W. KGS	CUFT
481804P	320	690	10 / 40	28.5	1.39

## 72 Teeth Rotor Ratchet

Item No.	Length mm	Weight g	PCS inner/ctn	G.W. KGS	CUFT
481804S	320	920	10 / 30	28.5	1.16

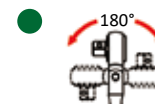
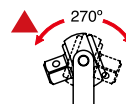

## Extension Bars

Item No. (Previous No.)	Length mm	Weight g	PCS inner/ctn	G.W. KGS	CUFT
424050	50	95	10 / 200	20.0	0.60
424075	75	125	10 / 140	18.0	0.44
424125	125	190	5 / 60	12.5	0.30
<b>NEW</b> 424150	150	220	5 / 60	14.2	0.30
<b>NEW</b> 424200	200	285	5 / 60	18.0	0.52
424250 (424320)	250	350	5 / 60	22.0	0.52
<b>NEW</b> 424300	300	420	5 / 40	17.8	0.38



## Wobble Extension Bars

Item No.	Length mm	Weight g	PCS inner/ctn	G.W. KGS	CUFT
420002B	50	95	10 / 200	19.5	0.60
420003B	75	120	10 / 140	18.5	0.44
420005B	125	185	5 / 60	12.0	0.30
<b>NEW</b> 420006B	150	200	5 / 60	13.0	0.30
420008B	200	275	5 / 60	14.5	0.52
420010B	250	335	5 / 60	17.5	0.52
<b>NEW</b> 420012B	300	400	5 / 40	17.0	0.38
420015B	375	450	1 / 30	15.0	0.45
<b>NEW</b> 420018B	450	520	1 / 30	16.5	0.30
420024B	600	770	1 / 20	15.0	0.30
<b>NEW</b> 420036B	900	1050	1 / 15	16.0	0.34



## EX-2349 9 Piece 1/4", 3/8" & 1/2" Dr. Extension Bar Set

Item No.	Size	Item No.	Size
220002	1/4" Dr. 50mmL	320150	3/8" Dr. 150mmL
220004	1/4" Dr. 100mmL	424050	1/2" Dr. 50mmL
220006	1/4" Dr. 150mmL	424125	1/2" Dr. 125mmL
320050	3/8" Dr. 50mmL	424250	1/2" Dr. 250mmL
320075	3/8" Dr. 75mmL		Plastic Tray

1200 g      10 sets / 13 Kgs / 0.93 CUFT



(192W x 203D)



## BE-2349 9 Piece 1/4", 3/8" & 1/2" Dr. Wobble Extension Bar Set

Item No.	Size	Item No.	Size
220002B	1/4" Dr. 50mmL	320006B	3/8" Dr. 150mmL
220004B	1/4" Dr. 100mmL	420002B	1/2" Dr. 50mmL
220006B	1/4" Dr. 150mmL	420005B	1/2" Dr. 125mmL
320002B	3/8" Dr. 50mmL	420010B	1/2" Dr. 250mmL
320003B	3/8" Dr. 75mmL		Plastic Tray

1200 g      10 sets / 13 Kgs / 0.93 CUFT



(192W x 203D)



## BE-42305 3 Piece 1/2" Dr. Wobble Extension Bar Set

Item No.	Size
420002B	50mmL (2"L)
420003B	75mmL (3"L)
420005B	125mmL (5"L)

Sliding Card

370 g      10x8 80 sets / 30.5 Kgs / 1.6 CUFT







## BE-42510 3 Piece 1/2" Dr. Wobble Extension Bar Set

Item No.	Size
420002B	50mmL (2"L)
420005B	125mmL (5"L)
420010B	250mmL (10"L)

Sliding Card

600 g 12x4 48 sets / 29 Kgs / 1.5 CUFT



## GS-412M 12 Piece 1/2" Dr. Metric Hand Socket Set

Item No.	Size	Item No.	Size
<b>1/2" Dr. 6pt Hand Socket:</b>			
423808	8mm	423814	14mm
423809	9mm	423815	15mm
423810	10mm	423816	16mm
423811	11mm	423817	17mm
423812	12mm	423818	18mm
423813	13mm	423819	19mm

Socket Holder

950 g 6x3 18 sets / 18 Kgs / 1.16 CUFT



6 pt.

## GS-412S 12 Piece 1/2" Dr. SAE Hand Socket Set

Item No.	Size	Item No.	Size
<b>1/2" Dr. 6pt Hand Socket:</b>			
483810	5/16"	483822	11/16"
483812	3/8"	483824	3/4"
483814	7/16"	483826	13/16"
483816	1/2"	483828	7/8"
483818	9/16"	483830	15/16"
483820	5/8"	483832	1"

Socket Holder

1200 g 6x3 18 sets / 22.5 Kgs / 1.16 CUFT



6 pt.

## GD-412M 12 Piece 1/2" Dr. Metric Deep Hand Socket Set

Item No.	Size	Item No.	Size
<b>1/2" Dr. 6pt Deep Hand Socket:</b>			
427808	8mm	427814	14mm
427809	9mm	427815	15mm
427810	10mm	427816	16mm
427811	11mm	427817	17mm
427812	12mm	427818	18mm
427813	13mm	427819	19mm

Socket Holder

1900 g 12x1 12 sets / 24 Kgs / 1.16 CUFT



6 pt.

## GD-412S 12 Piece 1/2" Dr. SAE Deep Hand Socket Set

Item No.	Size	Item No.	Size
<b>1/2" Dr. 6pt Deep Hand Socket:</b>			
487810	5/16"	487822	11/16"
487812	3/8"	487824	3/4"
487814	7/16"	487826	13/16"
487816	1/2"	487828	7/8"
487818	9/16"	487830	15/16"
487820	5/8"	487832	1"

Socket Holder

2250 g 12x1 12 sets / 28 Kgs / 1.16 CUFT



6 pt.

## GS-410RM 10 Piece 1/2" Dr. Metric Hand Socket Set

Item No.	Size	Item No.	Size
<b>1/2" Dr. 6pt Hand Socket:</b>			
423810	10mm	423817	17mm
423811	11mm	423819	19mm
423812	12mm	423821	21mm
423813	13mm	423822	22mm
423814	14mm	423824	24mm
Socket Holder			



6 pt.

950 g 6x3 18 sets / 18 Kgs / 1.16 CUFT

## GD-410M 10 Piece 1/2" Dr. Metric Deep Hand Socket Set

Previous Item No.: GS-410DM

Item No.	Size	Item No.	Size
<b>1/2" Dr. 6pt Deep Hand Socket:</b>			
427810	10mm	427817	17mm
427811	11mm	427819	19mm
427812	12mm	427821	21mm
427813	13mm	427822	22mm
427814	14mm	427824	24mm
Metal Box			



6 pt.

1900 g 10 sets / 20 Kgs / 0.52 CUFT

## GS-416M 16 Piece 1/2" Dr. Metric Hand Socket Set

Item No.	Size	Item No.	Size
<b>1/2" Dr. 6pt Hand Socket:</b>			
423808	8mm	423817	17mm
423810	10mm	423819	19mm
423811	11mm	423821	21mm
423812	12mm	423822	22mm
423813	13mm	423824	24mm
423814	14mm	423827	27mm
423816	16mm		

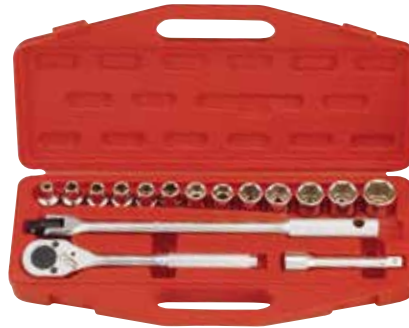

6 pt.

<b>1/2" Dr. Accessory:</b>			
424125	Extension Bar, 125mmL	480446A	Hinge Handle
480444R	24T Reversible Ratchet		Blow Case

3750 g 4 sets / 16 Kgs / 0.93 CUFT

## GS-416S 16 Piece 1/2" Dr. SAE Hand Socket Set

Item No.	Size	Item No.	Size
<b>1/2" Dr. 6pt Hand Socket:</b>			
483810	5/16"	483824	3/4"
483812	3/8"	483826	13/16"
483814	7/16"	483828	7/8"
483816	1/2"	483830	15/16"
483818	9/16"	483832	1"
483820	5/8"	483834	1-1/16"
483822	11/16"		

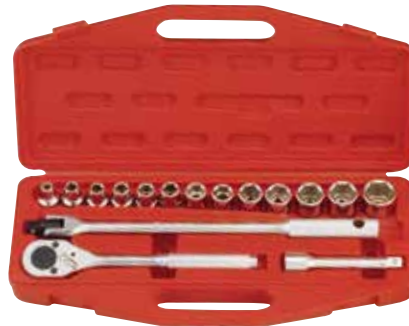

6 pt.

<b>1/2" Dr. Accessory:</b>			
424125	Extension Bar, 5"L	480446A	Hinge Handle
480444R	24T Reversible Ratchet		Blow Case

3750 g 4 sets / 16 Kgs / 0.93 CUFT



# Hand Socket Sets

## GS-415M2 15 Piece 1/2" Dr. Metric Hand Socket Set

Item No.	Size	Item No.	Size
<b>1/2" Dr. 6pt Hand Socket:</b>			
423810	10mm	423818	18mm
423811	11mm	423819	19mm
423812	12mm	423821	21mm
423813	13mm	423822	22mm
423814	14mm	423824	24mm
423815	15mm	423827	27mm
423816	16mm	423830	30mm
423817	17mm	Socket Holder	

1600 g 8x1 8 sets / 13.8 Kgs / 0.7 CUFT



6 pt.



## GS-415S2 15 Piece 1/2" Dr. SAE Hand Socket Set

Item No.	Size	Item No.	Size
<b>1/2" Dr. 6pt Hand Socket:</b>			
483810	5/16"	483826	13/16"
483812	3/8"	483828	7/8"
483814	7/16"	483830	15/16"
483816	1/2"	483832	1"
483818	9/16"	483834	1-1/16"
483820	5/8"	483836	1-1/8"
483822	11/16"	483840	1-1/4"
483824	3/4"	Socket Holder	

1850 g 8x1 8 sets / 15.8 Kgs / 0.7 CUFT



6 pt.

## GD-408M1 8 Piece 1/2" Dr. Metric Deep Hand Socket Set

Item No.	Size	Item No.	Size
<b>1/2" Dr. 6pt Hand Socket:</b>			
427810	10mm	427817	17mm
427813	13mm	427819	19mm
427814	14mm	427822	22mm
427815	15mm		

**1/2" Dr. Accessory:**  
480444R 24T Reversible Ratchet  
Metal Box

2500 g 6 sets / 16 Kgs / 0.69 CUFT



6 pt.



## GD-408S1 8 Piece 1/2" Dr. SAE Deep Hand Socket Set

Item No.	Size	Item No.	Size
<b>1/2" Dr. 6pt Hand Socket:</b>			
487816	1/2"	487824	3/4"
487818	9/16"	487826	13/16"
487820	5/8"	487828	7/8"
487822	11/16"		

**1/2" Dr. Accessory:**  
480444R 24T Reversible Ratchet  
Metal Box

2500 g 6 sets / 16 Kgs / 0.69 CUFT



6 pt.



## GS-417M 17 Piece 1/2" Dr. Metric Hand Socket Set

Item No.	Size	Item No.	Size
<b>1/2" Dr. 6pt Hand Socket:</b>			
423810	10mm	423819	19mm
423811	11mm	423822	22mm
423812	12mm	423824	24mm
423813	13mm	423827	27mm
423814	14mm	423830	30mm
423815	15mm	423832	32mm
423817	17mm		
<b>1/2" Dr. Accessory:</b>			
424250	Extension Bar, 250mmL	480040	Sliding T-Handle
480444R	24T Reversible Ratchet	480070	Universal Joint
	Metal Box		

4150 g 6 sets / 26 Kgs / 0.95 CUFT



6 pt.

## GS-417S 17 Piece 1/2" Dr. SAE Hand Socket Set

Item No.	Size	Item No.	Size
<b>1/2" Dr. 6pt Hand Socket:</b>			
483812	3/8"	483826	13/16"
483814	7/16"	483828	7/8"
483816	1/2"	483830	15/16"
483818	9/16"	483832	1"
483820	5/8"	483836	1-1/8"
483822	11/16"	483840	1-1/4"
483824	3/4"		
<b>1/2" Dr. Accessory:</b>			
424250	Extension Bar, 10"L	480040	Sliding T-Handle
480444R	24T Reversible Ratchet	480070	Universal Joint
	Metal Box		

4150 g 6 sets / 26 Kgs / 0.95 CUFT



6 pt.

## GS-418M 18 Piece 1/2" Dr. Metric Hand Socket Set

Item No.	Size	Item No.	Size
<b>1/2" Dr. 6pt Hand Socket:</b>			
423808	8mm	423816	16mm
423809	9mm	423817	17mm
423810	10mm	423818	18mm
423812	12mm	423819	19mm
423813	13mm	423821	21mm
423814	14mm	423823	23mm
423815	15mm	423826	26mm
<b>1/2" Dr. Accessory:</b>			
424125	Extension Bar, 125mmL	480446A	Hinge Handle
480444R	24T Reversible Ratchet	480446PP	Pin Handle
	Metal Box		

3900 g 6 sets / 25 Kgs / 0.92 CUFT



6 pt.



# Hand Socket Sets

## GS-418S 18 Piece 1/2" Dr. SAE Hand Socket Set

Item No.	Size	Item No.	Size
<b>1/2" Dr. 6pt Hand Socket:</b>			
483810	5/16"	483822	11/16"
483812	3/8"	483824	3/4"
483814	7/16"	483825	25/32"
483816	1/2"	483826	13/16"
483818	9/16"	483828	7/8"
483819	19/32"	483830	15/16"
483820	5/8"	483832	1"

### 1/2" Dr. Accessory:

424125	Extension Bar, 5"L	480446A	Hinge Handle
480444R	24T Reversible Ratchet Metal Box	480446PP	Pin Handle

3900 g

6 sets / 25 Kgs / 0.92 CUFT



6 pt.



## GS-422M 22 Piece 1/2" Dr. Metric Hand Socket Set

Item No.	Size	Item No.	Size
<b>1/2" Dr. 6pt Hand Socket:</b>			
423809	9mm	423818	18mm
423810	10mm	423819	19mm
423812	12mm	423821	21mm
423813	13mm	423823	23mm
423814	14mm	423825	25mm
423815	15mm	423826	26mm
423816	16mm	423829	29mm
423817	17mm	423832	32mm

### 1/2" Dr. Accessory:

424125	Extension Bar, 125mmL	480040	Sliding T-Handle
424250	Extension Bar, 250mmL	480070	Universal Joint
480444R	24T Reversible Ratchet Metal Box	427021	20.6mm Spark Plug Socket

5150 g

4 sets / 22 Kgs / 0.88 CUFT



6 pt.

## GS-422S 22 Piece 1/2" Dr. SAE Hand Socket Set

Item No.	Size	Item No.	Size
<b>1/2" Dr. 6pt Hand Socket:</b>			
483812	3/8"	483824	3/4"
483814	7/16"	483825	25/32"
483816	1/2"	483826	13/16"
483818	9/16"	483828	7/8"
483819	19/32"	483830	15/16"
483820	5/8"	483832	1"
483821	21/32"	483836	1-1/8"
483822	11/16"	483840	1-1/4"

### 1/2" Dr. Accessory:

424125	Extension Bar, 5"L	480070	Universal Joint
424250	Extension Bar, 10"L	480040	Sliding T-Handle
480444R	24T Reversible Ratchet Metal Box	427021	13/16" Spark Plug Socket

5150 g

4 sets / 22 Kgs / 0.88 CUFT



6 pt.

## GS-422M2 22 Piece 1/2" Dr. Metric Hand Socket Set

Item No.	Size	Item No.	Size
<b>1/2" Dr. 6pt Hand Socket:</b>			
423810	10mm	423819	19mm
423811	11mm	423820	20mm
423812	12mm	423821	21mm
423813	13mm	423822	22mm
423814	14mm	423824	24mm
423815	15mm	423827	27mm
423816	16mm	423830	30mm
423817	17mm	423832	32mm

### 1/2" Dr. Accessory:

424125	Extension Bar, 125mmL	480040	Sliding T-Handle
424250	Extension Bar, 250mmL	480070	Universal Joint
480444R	24T Reversible Ratchet Metal Box	427021	20.6mm Spark Plug Socket

5150 g

4 sets / 22 Kgs / 0.88 CUFT



6 pt.

## GS-422M3 22 Piece 1/2" Dr. Metric Hand Socket Set

Item No.	Size	Item No.	Size
<b>1/2" Dr. 6pt Hand Socket:</b>			
423808	8mm	423817	17mm
423810	10mm	423818	18mm
423811	11mm	423819	19mm
423812	12mm	423822	22mm
423813	13mm	423824	24mm
423814	14mm	423827	27mm
423815	15mm	423830	30mm
423816	16mm	423832	32mm

### 1/2" Dr. Accessory:

424125	Extension Bar, 125mmL	480040	Sliding T-Handle
424250	Extension Bar, 250mmL	480070	Universal Joint
480444R	24T Reversible Ratchet Metal Box	427021	20.6mm Spark Plug Socket

5150 g

4 sets / 22 Kgs / 0.88 CUFT



6 pt.

## GS-422M4 22 Piece 1/2" Dr. Metric Hand Socket Set

Item No.	Size	Item No.	Size
<b>1/2" Dr. 6pt Hand Socket:</b>			
423808	8mm	423817	17mm
423810	10mm	423819	19mm
423811	11mm	423821	21mm
423812	12mm	423822	22mm
423813	13mm	423824	24mm
423814	14mm	423827	27mm
423815	15mm	423830	30mm
423816	16mm	423832	32mm

### 1/2" Dr. Accessory:

424125	Extension Bar, 125mmL	480040	Sliding T-Handle
424250	Extension Bar, 250mmL	480070	Universal Joint
480444R	24T Reversible Ratchet Metal Box	427021	20.6mm Spark Plug Socket

5150 g

4 sets / 22 Kgs / 0.88 CUFT



6 pt.

1/2

# Hand Socket Sets

## GS-424M3 24 Piece 1/2" Dr. Metric Hand Socket Set

Item No.	Size	Item No.	Size
<b>1/2" Dr. 6pt Hand Socket:</b>			
423810	10mm	423819	19mm
423811	11mm	423821	21mm
423812	12mm	423822	22mm
423813	13mm	423823	23mm
423814	14mm	423824	24mm
423815	15mm	423827	27mm
423816	16mm	423830	30mm
423817	17mm	423832	32mm
423818	18mm		

### 1/2" Dr. Accessory:

424125	Extension Bar, 125mmL	480040	Sliding T-Handle
424250	Extension Bar, 250mmL	480070	Universal Joint
480446A	Hinge Handle	427021	20.6mm Spark Plug Socket
480444R	24T Reversible Ratchet		
	Metal Box		

6270 g 4 sets / 26 Kgs / 0.88 CUFT



6 pt.

## GS-424M5 24 Piece 1/2" Dr. Metric Hand Socket Set

Previous Item No.: GS-424M4

Item No.	Size	Item No.	Size
<b>1/2" Dr. 6pt Hand Socket:</b>			
423808	8mm	423818	18mm
423810	10mm	423819	19mm
423811	11mm	423820	20mm
423812	12mm	423821	21mm
423813	13mm	423822	22mm
423814	14mm	423824	24mm
423815	15mm	423827	27mm
423816	16mm	423830	30mm
423817	17mm	423832	32mm

### 1/2" Dr. Accessory:

424125	Extension Bar, 125mmL	480040	Sliding T-Handle
424250	Extension Bar, 250mmL	480070	Universal Joint
480444R	24T Reversible Ratchet	480420	Speed Handle
	Metal Box		

6000 g 4 sets / 25 Kgs / 0.88 CUFT



6 pt.

## GS-424S5 24 Piece 1/2" Dr. SAE Hand Socket Set

Previous Item No.: GS-424S4

Item No.	Size	Item No.	Size
<b>1/2" Dr. 6pt Hand Socket:</b>			
483810	5/16"	483825	25/32"
483812	3/8"	483826	13/16"
483814	7/16"	483828	7/8"
483816	1/2"	483830	15/16"
483818	9/16"	483832	1"
483819	19/32"	483834	1-1/16"
483820	5/8"	483836	1-1/8"
483822	11/16"	483838	1-3/16"
483824	3/4"	483840	1-1/4"

### 1/2" Dr. Accessory:

424125	Extension Bar, 5"L	480040	Sliding T-Handle
424250	Extension Bar, 10"L	480070	Universal Joint
480444R	24T Reversible Ratchet	480420	Speed Handle
	Metal Box		

6000 g 4 sets / 25 Kgs / 0.88 CUFT



6 pt.

Made of Chrome Vanadium Steel

**ENIUS**  
PROFESSIONAL TOOLS

B-53

## XVS-424M 24 Piece 1/2" Dr. Metric Hand Socket Set

Item No.	Size	Item No.	Size
<b>1/2" Dr. 6pt Hand Socket:</b>			
V4208	8mm	V4217	17mm
V4209	9mm	V4218	18mm
V4210	10mm	V4219	19mm
V4211	11mm	V4221	21mm
V4212	12mm	V4222	22mm
V4213	13mm	V4224	24mm
V4214	14mm	V4227	27mm
V4215	15mm	V4230	30mm
V4216	16mm	V4232	32mm

### 1/2" Dr. Accessory:

V4E05	Extension Bar, 125mmL	V4S12	Sliding T-Handle
V4E10	Extension Bar, 250mmL	V4UJ4	Universal Joint
VS4R10	24T Quick Release Ratchet Metal Box	V4S16	16.0mm Spark Plug Socket

4800 g 4 sets / 21 Kgs / 0.88 CUFT



6 pt.



## XV-424MW 24 Piece 1/2" Dr. Metric Hand Socket Set (12-Point)

Item No.	Size	Item No.	Size
<b>1/2" Dr. 12pt Hand Socket:</b>			
V4308	8mm	V4317	17mm
V4309	9mm	V4318	18mm
V4310	10mm	V4319	19mm
V4311	11mm	V4321	21mm
V4312	12mm	V4322	22mm
V4313	13mm	V4324	24mm
V4314	14mm	V4327	27mm
V4315	15mm	V4330	30mm
V4316	16mm	V4332	32mm

### 1/2" Dr. Accessory:

V4E05	Extension Bar, 125mmL	V4S12	Sliding T-Handle
V4E10	Extension Bar, 250mmL	V4UJ4	Universal Joint
VS4R10	24T Quick Release Ratchet Metal Box	V4S16	16.0mm Spark Plug Socket

4800 g 4 sets / 21 Kgs / 0.88 CUFT



12 pt.



## XV-424MW4 24 Piece 1/2" Dr. Metric Hand Socket Set (12-Point)

Item No.	Size	Item No.	Size
<b>1/2" Dr. 12pt Hand Socket:</b>			
V4308	8mm	V4317	17mm
V4309	9mm	V4318	18mm
V4310	10mm	V4319	19mm
V4311	11mm	V4321	21mm
V4312	12mm	V4322	22mm
V4313	13mm	V4324	24mm
V4314	14mm	V4327	27mm
V4315	15mm	V4330	30mm
V4316	16mm	V4332	32mm

### 1/2" Dr. Accessory:

V4E05	Extension Bar, 125mmL	V4S12	Sliding T-Handle
V4E10	Extension Bar, 250mmL	V4UJ4	Universal Joint
V4R10	24T Quick Release Ratchet Blow Case	V4S21	20.6mm Spark Plug Socket

4000 g 4 sets / 17 Kgs / 1.07 CUFT



12 pt.





# Hand Socket Sets

## GS-424M 24 Piece 1/2" Dr. Metric Hand Socket Set

Item No.	Size	Item No.	Size
<b>1/2" Dr. 6pt Hand Socket:</b>			
423808	8mm	423817	17mm
423809	9mm	423818	18mm
423810	10mm	423819	19mm
423811	11mm	423821	21mm
423812	12mm	423822	22mm
423813	13mm	423824	24mm
423814	14mm	423827	27mm
423815	15mm	423830	30mm
423816	16mm	423832	32mm
<b>1/2" Dr. Accessory:</b>			
424125	Extension Bar, 125mmL	480040	Sliding T-Handle
424250	Extension Bar, 250mmL	480070	Universal Joint
480444R	24T Reversible Ratchet	427021	20.6mm Spark Plug Socket
Blow Case			

5000 g 4 sets / 21 Kgs / 1.07 CUFT



6 pt.

## GS-424MA 24 Piece 1/2" Dr. Metric Hand Socket Set

Item No.	Size	Item No.	Size
<b>1/2" Dr. 6pt Hand Socket:</b>			
423808	8mm	423817	17mm
423809	9mm	423818	18mm
423810	10mm	423819	19mm
423811	11mm	423821	21mm
423812	12mm	423822	22mm
423813	13mm	423824	24mm
423814	14mm	423827	27mm
423815	15mm	423830	30mm
423816	16mm	423832	32mm
<b>1/2" Dr. Accessory:</b>			
424125	Extension Bar, 125mmL	480040	Sliding T-Handle
424250	Extension Bar, 250mmL	480070	Universal Joint
480431R	36T Quick Release Ratchet	427021	20.6mm Spark Plug Socket
Blow Case			

5000 g 4 sets / 21 Kgs / 1.07 CUFT



6 pt.

## XV-424M 24 Piece 1/2" Dr. Metric Hand Socket Set

Item No.	Size	Item No.	Size
<b>1/2" Dr. 6pt Hand Socket:</b>			
V4208	8mm	V4217	17mm
V4209	9mm	V4218	18mm
V4210	10mm	V4219	19mm
V4211	11mm	V4221	21mm
V4212	12mm	V4222	22mm
V4213	13mm	V4224	24mm
V4214	14mm	V4227	27mm
V4215	15mm	V4230	30mm
V4216	16mm	V4232	32mm
<b>1/2" Dr. Accessory:</b>			
V4E05	Extension Bar, 125mmL	V4S12	Sliding T-Handle
V4E10	Extension Bar, 250mmL	V4UJ4	Universal Joint
V4R10	24T Quick Release Ratchet	V4S21	20.6mm Spark Plug Socket
Blow Case			

4000 g 4 sets / 17 Kgs / 1.07 CUFT



6 pt.

Made of Chrome Vanadium Steel





## GS-424S 24 Piece 1/2" Dr. SAE Hand Socket Set

Item No.	Size	Item No.	Size
<b>1/2" Dr. 6pt Hand Socket:</b>			
483810	5/16"	483825	25/32"
483812	3/8"	483826	13/16"
483814	7/16"	483828	7/8"
483816	1/2"	483830	15/16"
483818	9/16"	483832	1"
483819	19/32"	483834	1-1/16"
483820	5/8"	483836	1-1/8"
483822	11/16"	483838	1-3/16"
483824	3/4"	483840	1-1/4"
<b>1/2" Dr. Accessory:</b>			
424125	Extension Bar, 5"L	480040	Sliding T-Handle
424250	Extension Bar, 10"L	480070	Universal Joint
480444R	24T Reversible Ratchet	427021	13/16" Spark Plug Socket
Blow Case			



6 pt.

5000 g 4 sets / 21 Kgs / 1.07 CUFT

## EU-2454M 54 Piece 1/4" & 1/2" Dr. Metric Hand Socket & Bit Set

Item No.	Size	Item No.	Size	Item No.	Size
<b>1/4" Dr. 6pt Hand Socket:</b>					
222505	5mm	222510	10mm	<b>Accessory:</b>	
2225055	5.5mm	222511	11mm	220002	1/4" Dr. Extension Bar, 50mmL
222506	6mm	222512	12mm	220004	1/4" Dr. Extension Bar, 100mmL
222507	7mm	222513	13mm	280070	1/4" Dr. Universal Joint
222508	8mm	222514	14mm	280231S	1/4" Dr. 36T Quick Release Ratchet
222509	9mm			506+0175	1/4" Dr. Socket Driver
<b>1/2" Dr. 6pt Hand Socket:</b>					
423810	10mm	423819	19mm	282408	1/4" Dr. 1/4" Hex Shank Bit Holder
423811	11mm	423821	21mm	424125	1/2" Dr. Extension Bar, 125mmL
423812	12mm	423822	22mm	480431S	1/2" Dr. 36T Quick Release Ratchet
423813	13mm	423824	24mm	Blow Case	
423814	14mm	423827	27mm		
423816	16mm	423830	30mm		
423817	17mm	423832	32mm		
423818	18mm				
<b>1/4" Hex Shank Screwdriver Bit:</b>					
1140	0.6 x 4.0mm Slotted	1101	#1 Philips		
1160	1.0 x 6.0mm Slotted	1102	#2 Philips		
1170	1.2 x 7.0mm Slotted	1103	#3 Philips		
6110	T-10 Star	1211	#1 Posidriv		
6115	T-15 Star	1212	#2 Posidriv		
6120	T-20 Star	1213	#3 Posidriv		
6125	T-25 Star	2133	3mm Hex		
6127	T-27 Star	2134	4mm Hex		
6130	T-30 Star	2135	5mm Hex		
6140	T-40 Star	2136	6mm Hex		



6 pt.



3650 g 4 sets / 15.5 Kgs / 0.85 CUFT



# Hand Socket Sets

## EU-422M 22 Piece 1/2" Dr. Metric Hand Socket Set

Item No.	Size	Item No.	Size
<b>1/2" Dr. 6pt Hand Socket:</b>			
423808	8mm	423818	18mm
423810	10mm	423819	19mm
423811	11mm	423821	21mm
423812	12mm	423822	22mm
423813	13mm	423823	23mm
423814	14mm	423824	24mm
423815	15mm	423827	27mm
423816	16mm	423830	30mm
423817	17mm	423832	32mm

**1/2" Dr. Accessory:**  
 424125 Extension Bar, 125mmL 480070 Universal Joint  
 424250 Extension Bar, 250mmL 480472P 72T Reversible Ratchet  
 Blow Case

3650 g 4 sets / 15.5 Kgs / 0.85 CUFT



6 pt.



## EU-421S 21 Piece 1/2" Dr. SAE Hand Socket Set (12-Point)

Item No.	Size	Item No.	Size
<b>1/2" Dr. 12pt Hand Socket:</b>			
473812	3/8"	473826	13/16"
473814	7/16"	473828	7/8"
473816	1/2"	473830	15/16"
473818	9/16"	473832	1"
473819	19/32"	473834	1-1/16"
473820	5/8"	473836	1-1/8"
473822	11/16"	473838	1-3/16"
473824	3/4"	473840	1-1/4"

**1/2" Dr. Accessory:**  
 424125 Extension Bar, 5"L 480070 Universal Joint  
 424250 Extension Bar, 10"L 480040 Sliding T-Handle  
 480431S 36T Quick Release Ratchet  
 Blow Case

4450 g 4 sets / 19 Kgs / 1.07 CUFT



12 pt.



## EU-426M 26 Piece 1/2" Dr. Metric Hand Socket Set

Item No.	Size	Item No.	Size
<b>1/2" Dr. 6pt Hand Socket:</b>			
423810	10mm	423821	21mm
423811	11mm	423822	22mm
423812	12mm	423823	23mm
423813	13mm	423824	24mm
423814	14mm	423826	26mm
423815	15mm	423827	27mm
423816	16mm	423828	28mm
423817	17mm	423830	30mm
423818	18mm	423832	32mm
423819	19mm	423834	34mm
423820	20mm		

**1/2" Dr. Accessory:**  
 424125 Extension Bar, 125mmL 480070 Universal Joint  
 424250 Extension Bar, 250mmL 480040 Sliding T-Handle  
 480431S 36T Quick Release Ratchet  
 Blow Case

5200 g 4 sets / 22 Kgs / 1.07 CUFT



6 pt.



Made of Chrome Vanadium Steel



## GS-416MA 16 Piece 1/2" Dr. Metric Hand Socket Set

Item No.	Size	Item No.	Size
<b>1/2" Dr. 6pt Hand Socket:</b>			
423808	8mm	423817	17mm
423810	10mm	423819	19mm
423811	11mm	423821	21mm
423812	12mm	423822	22mm
423813	13mm	423824	24mm
423814	14mm	423827	27mm
423816	16mm		

### 1/2" Dr. Accessory:

- 480446A Hinge Handle
- 424125 Extension Bar, 125mmL
- 480472 72T Reversible Ratchet

Metal Box

3700 g 6 sets / 23.5 Kgs / 0.92 CUFT



6 pt.

## GS-424M6 24 Piece 1/2" Dr. Metric Hand Socket Set

Previous Item No.: GS-425M

Item No.	Size	Item No.	Size
<b>1/2" Dr. 6pt Hand Socket:</b>			
423808	8mm	423817	17mm
423809	9mm	423818	18mm
423810	10mm	423819	19mm
423811	11mm	423821	21mm
423812	12mm	423822	22mm
423813	13mm	423824	24mm
423814	14mm	423827	27mm
423815	15mm	423830	30mm
423816	16mm	423832	32mm

### 1/2" Dr. Accessory:

- 424125 Extension Bar, 125mmL
- 424250 Extension Bar, 250mmL
- 480444R 24T Reversible Ratchet
- 480070 Universal Joint
- 480446A Hinge Handle
- 427021 20.6mm Spark Plug Socket

Metal Box

6500 g 4 sets / 27 Kgs / 0.88 CUFT



6 pt.

## GS-424S6 24 Piece 1/2" Dr. SAE Hand Socket Set

Previous Item No.: GS-425S

Item No.	Size	Item No.	Size
<b>1/2" Dr. 6pt Hand Socket:</b>			
483810	5/16"	483825	25/32"
483812	3/8"	483826	13/16"
483814	7/16"	483828	7/8"
483816	1/2"	483830	15/16"
483818	9/16"	483832	1"
483819	19/32"	483834	1-1/16"
483820	5/8"	483836	1-1/8"
483822	11/16"	483838	1-3/16"
483824	3/4"	483840	1-1/4"

### 1/2" Dr. Accessory:

- 424125 Extension Bar, 5"L
- 424250 Extension Bar, 10"L
- 480444R 24T Reversible Ratchet
- 480070 Universal Joint
- 480446A Hinge Handle
- 427021 13/16" Spark Plug Socket

Metal Box

6500 g 4 sets / 27 Kgs / 0.88 CUFT



6 pt.



# Hand Socket Sets

## GS-427M 27 Piece 1/2" Dr. Metric Hand Socket Set

Item No.	Size	Item No.	Size
<b>1/2" Dr. 6pt Hand Socket:</b>			
423810	10mm	423821	21mm
423811	11mm	423822	22mm
423812	12mm	423823	23mm
423813	13mm	423824	24mm
423814	14mm	423826	26mm
423815	15mm	423827	27mm
423816	16mm	423828	28mm
423817	17mm	423830	30mm
423818	18mm	423832	32mm
423819	19mm		

### 1/2" Dr. Accessory:

424125	Extension Bar, 125mmL
424250	Extension Bar, 250mmL
480070	Universal Joint
480040	Sliding T-Handle
427021	20.6mm Spark Plug Socket
480446A	Hinge Handle
480446PP	Pin Handle
480444R	24T Reversible Ratchet
Metal Box	

6750 g

4 sets / 28 Kgs / 0.88 CUFT

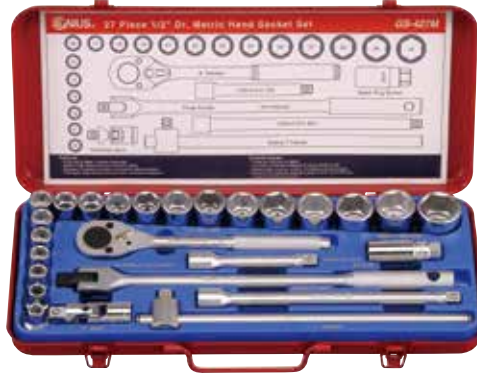

6 pt.



## GS-427S 27 Piece 1/2" Dr. SAE Hand Socket Set

Item No.	Size	Item No.	Size
<b>1/2" Dr. 6pt Hand Socket:</b>			
483810	5/16"	483825	25/32"
483812	3/8"	483826	13/16"
483814	7/16"	483828	7/8"
483816	1/2"	483830	15/16"
483818	9/16"	483832	1"
483819	19/32"	483834	1-1/16"
483820	5/8"	483836	1-1/8"
483821	21/32"	483838	1-3/16"
483822	11/16"	483840	1-1/4"
483824	3/4"		

### 1/2" Dr. Accessory:

424125	Extension Bar, 5"L
424250	Extension Bar, 10"L
480070	Universal Joint
480040	Sliding T-Handle
427021	13/16" Spark Plug Socket
480446A	Hinge Handle
480446PP	Pin Handle
480444R	24T Reversible Ratchet
Metal Box	

6750 g

4 sets / 28 Kgs / 0.88 CUFT

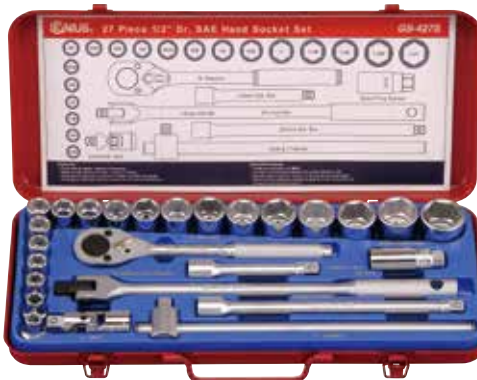

6 pt.



Made of Chrome Vanadium Steel

**ENIUS**  
PROFESSIONAL TOOLS

B-59

## GS-439M 39 Piece 1/2" Dr. Metric Hand Socket Set

Item No.	Size	Item No.	Size
<b>1/2" Dr. 6pt Hand Socket:</b>			
423809	9mm	423819	19mm
423810	10mm	423820	20mm
423811	11mm	423821	21mm
423812	12mm	423822	22mm
423813	13mm	423823	23mm
423814	14mm	423824	24mm
423815	15mm	423826	26mm
423816	16mm	423827	27mm
423817	17mm	423830	30mm
423818	18mm	423832	32mm

<b>1/2" Dr. 6pt Deep Hand Socket:</b>			
427809	9mm	427816	16mm
427810	10mm	427817	17mm
427811	11mm	427818	18mm
427812	12mm	427819	19mm
427813	13mm	427820	20mm
427814	14mm	427821	21mm
427815	15mm	427822	22mm

### Accessory:

320042	2-way Adapter, 3/8"F x 1/2"M
424125	1/2" Dr. Extension Bar, 125mmL
424323	1/2" Dr. Extension Bar, 250mmL
480070	1/2" Dr. Universal Joint
480431R	1/2" Dr. 36T Quick Release Ratchet
	Blow Case

6900 g 3 sets / 22 Kgs / 1.16 CUFT



## GS-432S 32 Piece 1/2" Dr. SAE Hand Socket Set

Item No.	Size	Item No.	Size
<b>1/2" Dr. 6pt Hand Socket:</b>			
483812	3/8"	483825	25/32"
483814	7/16"	483826	13/16"
483816	1/2"	483828	7/8"
483818	9/16"	483830	15/16"
483819	19/32"	483832	1"
483820	5/8"	483834	1-1/16"
483822	11/16"	483836	1-1/8"
483824	3/4"	483840	1-1/4"

<b>1/2" Dr. 6pt Deep Hand Socket:</b>			
487812	3/8"	487822	11/16"
487814	7/16"	487824	3/4"
487816	1/2"	487825	25/32"
487818	9/16"	487826	13/16"
487819	19/32"	487828	7/8"
487820	5/8"		

### Accessory:

320042	2-way Adapter, 3/8"F x 1/2"M
424125	1/2" Dr. Extension Bar, 5"L
424323	1/2" Dr. Extension Bar, 10"L
480070	1/2" Dr. Universal Joint
480431R	1/2" Dr. 36T Quick Release Ratchet
	Blow Case

6100 g 3 sets / 19.5 Kgs / 1.16 CUFT





# Hand Socket Sets

## DS-440M 40 Piece 1/2" Dr. Metric Deep Hand Socket Set

Item No.	Size	Item No.	Size
<b>1/2" Dr. 6pt Hand Socket:</b>			
423809	9mm	423819	19mm
423810	10mm	423820	20mm
423811	11mm	423821	21mm
423812	12mm	423822	22mm
423813	13mm	423823	23mm
423814	14mm	423824	24mm
423815	15mm	423826	26mm
423816	16mm	423827	27mm
423817	17mm	423830	30mm
423818	18mm		
<b>1/2" Dr. 6pt Deep Hand Socket:</b>			
427809	9mm	427819	19mm
427810	10mm	427820	20mm
427811	11mm	427821	21mm
427812	12mm	427822	22mm
427813	13mm	427823	23mm
427814	14mm	427824	24mm
427815	15mm	427826	26mm
427816	16mm	427827	27mm
427817	17mm	427830	30mm
427818	18mm		

### 1/2" Dr. Accessory:

424125	Extension Bar, 125mmL
480070	Universal Joint
	Blow Case

7000 g 3 sets / 22 Kgs / 1.16 CUFT



6 pt.



## DS-434S 34 Piece 1/2" Dr. SAE Deep Hand Socket Set

Item No.	Size	Item No.	Size
<b>1/2" Dr. 6pt Hand Socket:</b>			
483810	5/16"	483826	13/16"
483812	3/8"	483828	7/8"
483814	7/16"	483830	15/16"
483816	1/2"	483832	1"
483818	9/16"	483834	1-1/16"
483820	5/8"	483836	1-1/8"
483822	11/16"	483838	1-3/16"
483824	3/4"	483840	1-1/4"
<b>1/2" Dr. 6pt Deep Hand Socket:</b>			
487810	5/16"	487826	13/16"
487812	3/8"	487828	7/8"
487814	7/16"	487830	15/16"
487816	1/2"	487832	1"
487818	9/16"	487834	1-1/16"
487820	5/8"	487836	1-1/8"
487822	11/16"	487838	1-3/16"
487824	3/4"	487840	1-1/4"

### 1/2" Dr. Accessory:

424125	Extension Bar, 5"L
480070	Universal Joint
	Blow Case

7000 g 3 sets / 22 Kgs / 1.16 CUFT



6 pt.



## GS-446MS 46 Piece 1/2" Dr. Metric & SAE Hand Socket Set

Item No.	Size	Item No.	Size
<b>1/2" Dr. 6pt Hand Socket:</b>			
423808	8mm	423827	27mm
423809	9mm	423828	28mm
423810	10mm	423830	30mm
423811	11mm	423832	32mm
423812	12mm	483812	3/8"
423813	13mm	483814	7/16"
423814	14mm	483816	1/2"
423815	15mm	483818	9/16"
423816	16mm	483820	5/8"
423817	17mm	483822	11/16"
423818	18mm	483824	3/4"
423819	19mm	483826	13/16"
423820	20mm	483828	7/8"
423821	21mm	483830	15/16"
423822	22mm	483832	1"
423823	23mm	483836	1-1/8"
423824	24mm	483838	1-3/16"
423825	25mm	483840	1-1/4"
423826	26mm		

### 1/2" Dr. Accessory:

424125	Extension Bar, 125mmL
424250	Extension Bar, 250mmL
480446PP	Pin Handle
480446A	Hinge Handle
480070	Universal Joint
480040	Sliding T-Handle
427016	16.0 mm Spark Plug Socket
427021	20.6mm Spark Plug Socket
480444R	24T Reversible Ratchet
	Metal Box

9800 g      2 sets / 21 Kgs / 0.73 CUFT



6 pt.

## TW-412M 12 Piece 1/2" Dr. Metric Hand Socket Set (12-Point)

Item No.	Size	Item No.	Size
<b>1/2" Dr. 12pt Hand Socket:</b>			
433808	8mm	433814	14mm
433809	9mm	433815	15mm
433810	10mm	433816	16mm
433811	11mm	433817	17mm
433812	12mm	433818	18mm
433813	13mm	433819	19mm

Socket Holder

950 g      6x3 18 sets / 18 Kgs / 1.16 CUFT

SAE size: TW-412S also available

12 pt.

**NEW**



## TW-412MD 12 Piece 1/2" Dr. Metric Deep Hand Socket Set (12-Point)

Item No.	Size	Item No.	Size
<b>1/2" Dr. 12pt Deep Hand Socket:</b>			
437808	8mm	437814	14mm
437809	9mm	437815	15mm
437810	10mm	437816	16mm
437811	11mm	437817	17mm
437812	12mm	437818	18mm
437813	13mm	437819	19mm

Socket Holder

1900 g      12x1 12 sets / 24 Kgs / 1.16 CUFT

SAE size: TW-412SD also available

12 pt.

**NEW**







# Hand Socket Sets

## TW-415M 15 Piece 1/2" Dr. Metric Hand Socket Set (12-Point)

Item No.	Size	Item No.	Size
<b>1/2" Dr. 12pt Hand Socket:</b>			
433810	10mm	433818	18mm
433811	11mm	433819	19mm
433812	12mm	433821	21mm
433813	13mm	433822	22mm
433814	14mm	433824	24mm
433815	15mm	433827	27mm
433816	16mm	433830	30mm
433817	17mm	Metal Tray	

1600 g 8x1 8 sets / 13.8 Kgs / 0.7 CUFT



## TW-415S 15 Piece 1/2" Dr. SAE Hand Socket Set (12-Point)

Previous Item No.: TW-414S

Item No.	Size	Item No.	Size
<b>1/2" Dr. 12pt Hand Socket:</b>			
473810	5/16"	473826	13/16"
473812	3/8"	473828	7/8"
473814	7/16"	473830	15/16"
473816	1/2"	473832	1"
473818	9/16"	473834	1-1/16"
473820	5/8"	473836	1-1/8"
473822	11/16"	473840	1-1/4"
473824	3/4"	Metal Tray	

1850 g 8x1 8 sets / 15.8 Kgs / 0.7 CUFT



## TW-408M1 8 Piece 1/2" Dr. Metric Deep Hand Socket Set (12-Point)

Item No.	Size	Item No.	Size
<b>1/2" Dr. 12pt Hand Socket:</b>			
437810	10mm	437817	17mm
437813	13mm	437819	19mm
437814	14mm	437822	22mm
437815	15mm		

**1/2" Dr. Accessory:**  
480444R 24T Reversible Ratchet  
Metal Box

2500 g 6 sets / 16 Kgs / 0.69 CUFT



## TW-408S1 8 Piece 1/2" Dr. SAE Deep Hand Socket Set (12-Point)

Item No.	Size	Item No.	Size
<b>1/2" Dr. 12pt Hand Socket:</b>			
477816	1/2"	477824	3/4"
477818	9/16"	477826	13/16"
477820	5/8"	477828	7/8"
477822	11/16"		

**1/2" Dr. Accessory:**  
480444R 24T Reversible Ratchet  
Metal Box

2500 g 6 sets / 16 Kgs / 0.69 CUFT



## TW-416M 16 Piece 1/2" Dr. Metric Hand Socket Set (12-Point)

Item No.	Size	Item No.	Size
<b>1/2" Dr. 12pt Hand Socket:</b>			
433808	8mm	433817	17mm
433810	10mm	433819	19mm
433811	11mm	433821	21mm
433812	12mm	433822	22mm
433813	13mm	433824	24mm
433814	14mm	433827	27mm
433816	16mm		

### 1/2" Dr. Accessory:

424125	Extension Bar, 125mmL
480446A	Hinge Handle
480444R	24T Reversible Ratchet

Blow Case

3380 g 4 sets / 14.5 Kgs / 0.93 CUFT

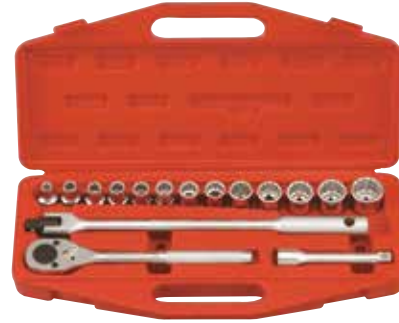

12 pt.

## TW-416S 16 Piece 1/2" Dr. SAE Hand Socket Set (12-Point)

Item No.	Size	Item No.	Size
<b>1/2" Dr. 12pt Hand Socket:</b>			
473810	5/16"	473824	3/4"
473812	3/8"	473826	13/16"
473814	7/16"	473828	7/8"
473816	1/2"	473830	15/16"
473818	9/16"	473832	1"
473820	5/8"	473834	1-1/16"
473822	11/16"		

### 1/2" Dr. Accessory:

424125	Extension Bar, 5"L
480446A	Hinge Handle
480444R	24T Reversible Ratchet

Blow Case

3750 g 4 sets / 16 Kgs / 0.93 CUFT

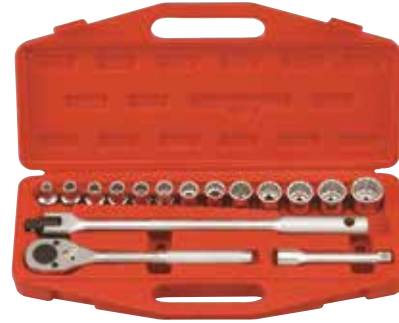

12 pt.

## TW-423M 23 Piece 1/2" Dr. Metric Hand Socket Set (12-Point)

Item No.	Size	Item No.	Size
<b>1/2" Dr. 12pt Hand Socket:</b>			
433808	8mm	433818	18mm
433810	10mm	433819	19mm
433811	11mm	433821	21mm
433812	12mm	433822	22mm
433813	13mm	433823	23mm
433814	14mm	433824	24mm
433815	15mm	433827	27mm
433816	16mm	433830	30mm
433817	17mm	433832	32mm

### 1/2" Dr. Accessory:

424125	Extension Bar, 125mmL
424250	Extension Bar, 250mmL
480070	Universal Joint
480040	Sliding T-Handle
480431S	36T Quick Release Ratchet

Plastic Tray

4180 g 5 sets / 22 Kgs / 0.93 CUFT



(192W x 406D)

12 pt.

1/3



# Hand Socket Sets

## TW-416MAM 16 Piece 1/2" Dr. Metric Hand Socket Set (12-Point)

Item No.	Size	Item No.	Size
<b>1/2" Dr. 12pt Hand Socket:</b>			
433808	8mm	433817	17mm
433810	10mm	433819	19mm
433811	11mm	433821	21mm
433812	12mm	433822	22mm
433813	13mm	433824	24mm
433814	14mm	433827	27mm
433816	16mm		

### 1/2" Dr. Accessory:

- 424125 Extension Bar, 125mmL
- 480472 72T Reversible Ratchet
- 480446A Hinge Handle
- Metal Box

3750 g 6 sets / 23.5 Kgs / 0.92 CUFT



12 pt.

## TW-418M 18 Piece 1/2" Dr. Metric Hand Socket Set (12-Point)

Item No.	Size	Item No.	Size
<b>1/2" Dr. 12pt Hand Socket:</b>			
433808	8mm	433816	16mm
433809	9mm	433817	17mm
433810	10mm	433818	18mm
433812	12mm	433819	19mm
433813	13mm	433821	21mm
433814	14mm	433823	23mm
433815	15mm	433826	26mm

### 1/2" Dr. Accessory:

- 424125 Extension Bar, 125mmL
- 480446A Hinge Handle
- 480446PP Pin Handle
- 480444R 24T Reversible Ratchet
- Metal Box

3900 g 6 sets / 24.5 Kgs / 0.92 CUFT



12 pt.

## TW-418S 18 Piece 1/2" Dr. SAE Hand Socket Set (12-Point)

Item No.	Size	Item No.	Size
<b>1/2" Dr. 12pt Hand Socket:</b>			
473810	5/16"	473822	11/16"
473812	3/8"	473824	3/4"
473814	7/16"	473825	25/32"
473816	1/2"	473826	13/16"
473818	9/16"	473828	7/8"
473819	19/32"	473830	15/16"
473820	5/8"	473832	1"

### 1/2" Dr. Accessory:

- 424125 Extension Bar, 5"L
- 480446A Hinge Handle
- 480446PP Pin Handle
- 480444R 24T Reversible Ratchet
- Metal Box

3900 g 6 sets / 24.5 Kgs / 0.92 CUFT



12 pt.

## TW-422M1 22 Piece 1/2" Dr. Metric Hand Socket Set (12-Point)

Item No.	Size	Item No.	Size
<b>1/2" Dr. 12pt Hand Socket:</b>			
433808	8mm	433817	17mm
433810	10mm	433819	19mm
433811	11mm	433821	21mm
433812	12mm	433822	22mm
433813	13mm	433824	24mm
433814	14mm	433827	27mm
433815	15mm	433830	30mm
433816	16mm	433832	32mm

### 1/2" Dr. Accessory:

424125	Extension Bar, 125mmL	480040	Sliding T-Handle
424250	Extension Bar, 250mmL	480070	Universal Joint
480444R	24T Reversible Ratchet Metal Box	427021	20.6mm Spark Plug Socket

5150 g 4 sets / 22 Kgs / 0.88 CUFT



12 pt.

## TW-424M5 24 Piece 1/2" Dr. Metric Hand Socket Set (12-Point)

Previous Item No.: TW-424M4

Item No.	Size	Item No.	Size
<b>1/2" Dr. 12pt Hand Socket:</b>			
433808	8mm	433818	18mm
433810	10mm	433819	19mm
433811	11mm	433820	20mm
433812	12mm	433821	21mm
433813	13mm	433822	22mm
433814	14mm	433824	24mm
433815	15mm	433827	27mm
433816	16mm	433830	30mm
433817	17mm	433832	32mm

### 1/2" Dr. Accessory:

424125	Extension Bar, 125mmL	480070	Universal Joint
424250	Extension Bar, 250mmL	480446A	Hinge Handle
480444R	24T Reversible Ratchet Metal Box	427021	20.6mm Spark Plug Socket

6000 g 4 sets / 25 Kgs / 0.88 CUFT



12 pt.

## TW-424S5 24 Piece 1/2" Dr. SAE Hand Socket Set (12-Point)

Previous Item No.: TW-424S4

Item No.	Size	Item No.	Size
<b>1/2" Dr. 12pt Hand Socket:</b>			
473810	5/16"	473825	25/32"
473812	3/8"	473826	13/16"
473814	7/16"	473828	7/8"
473816	1/2"	473830	15/16"
473818	9/16"	473832	1"
473819	19/32"	473834	1-1/16"
473820	5/8"	473836	1-1/8"
473822	11/16"	473838	1-3/16"
473824	3/4"	473840	1-1/4"

### 1/2" Dr. Accessory:

424125	Extension Bar, 5"L	480040	Sliding T-Handle
424250	Extension Bar, 10"L	480070	Universal Joint
480444R	24T Reversible Ratchet Metal Box	427021	13/16" Spark Plug Socket

6000 g 4 sets / 25 Kgs / 0.88 CUFT



12 pt.



# Hand Socket Sets

## TW-424M 24 Piece 1/2" Dr. Metric Hand Socket Set (12-Point)

Item No.	Size	Item No.	Size
<b>1/2" Dr. 12pt Hand Socket:</b>			
433808	8mm	433817	17mm
433809	9mm	433818	18mm
433810	10mm	433819	19mm
433811	11mm	433821	21mm
433812	12mm	433822	22mm
433813	13mm	433824	24mm
433814	14mm	433827	27mm
433815	15mm	433830	30mm
433816	16mm	433832	32mm

### 1/2" Dr. Accessory:

424125	Extension Bar, 125mmL	480040	Sliding T-Handle
424250	Extension Bar, 250mmL	480070	Universal Joint
480444R	24T Reversible Ratchet Blow Case	427021	20.6mm Spark Plug Socket

5000 g

4 sets / 21 Kgs / 1.07 CUFT



12 pt.



## TW-424S 24 Piece 1/2" Dr. SAE Hand Socket Set (12-Point)

Item No.	Size	Item No.	Size
<b>1/2" Dr. 12pt Hand Socket:</b>			
473810	5/16"	473825	25/32"
473812	3/8"	473826	13/16"
473814	7/16"	473828	7/8"
473816	1/2"	473830	15/16"
473818	9/16"	473832	1"
473819	19/32"	473834	1-1/16"
473820	5/8"	473836	1-1/8"
473822	11/16"	473838	1-3/16"
473824	3/4"	473840	1-1/4"

### 1/2" Dr. Accessory:

424125	Extension Bar, 5"L	480040	Sliding T-Handle
424250	Extension Bar, 10"L	480070	Universal Joint
480444R	24T Reversible Ratchet Blow Case	427021	13/16" Spark Plug Socket

5000 g

4 sets / 21 Kgs / 1.07 CUFT



12 pt.



## GS-417MB 1/2" Dr. 17 Piece Metric Hand Socket Set

Item No.	Size	Item No.	Size
<b>1/2" Dr. 6pt Hand Socket:</b>			
423808	8mm	423818	18mm
423810	10mm	423819	19mm
423811	11mm	423821	21mm
423812	12mm	423822	22mm
423813	13mm	423824	24mm
423814	14mm	423827	27mm
423815	15mm	423830	30mm
423816	16mm	423832	32mm
423817	17mm		Blow Case

2150 g

8 sets / 18.2 Kgs / 0.94 CUFT

12-point: TW-417MB also available

SAE size: GS-417SB & TW-417SB also available



6 pt.



## TW-439M 39 Piece 1/2" Dr. Metric Hand Socket Set (12-Point)

Item No.	Size	Item No.	Size
<b>1/2" Dr. 12pt Hand Socket:</b>			
433809	9mm	433819	19mm
433810	10mm	433820	20mm
433811	11mm	433821	21mm
433812	12mm	433822	22mm
433813	13mm	433823	23mm
433814	14mm	433824	24mm
433815	15mm	433826	26mm
433816	16mm	433827	27mm
433817	17mm	433830	30mm
433818	18mm	433832	32mm

Item No.	Size	Item No.	Size
<b>1/2" Dr. 12pt Deep Hand Socket:</b>			
437809	9mm	437816	16mm
437810	10mm	437817	17mm
437811	11mm	437818	18mm
437812	12mm	437819	19mm
437813	13mm	437820	20mm
437814	14mm	437821	21mm
437815	15mm	437822	22mm

**Accessory:**  
 320042 2-way Adapter, 3/8"F x 1/2"M  
 424125 1/2" Dr. Extension Bar, 125mmL  
 424323 1/2" Dr. Extension Bar, 250mmL  
 480070 1/2" Dr. Universal Joint  
 480431R 1/2" Dr. 36T Quick Release Ratchet  
 Blow Case

6750 g 3 sets / 21 Kgs / 1.16 CUFT



## TW-432S 32 Piece 1/2" Dr. SAE Hand Socket Set (12-Point)

Item No.	Size	Item No.	Size
<b>1/2" Dr. 12pt Hand Socket:</b>			
473812	3/8"	473825	25/32"
473814	7/16"	473826	13/16"
473816	1/2"	473828	7/8"
473818	9/16"	473830	15/16"
473819	19/32"	473832	1"
473820	5/8"	473834	1-1/16"
473822	11/16"	473836	1-1/8"
473824	3/4"	473840	1-1/4"

Item No.	Size	Item No.	Size
<b>1/2" Dr. 12pt Deep Hand Socket:</b>			
477812	3/8"	477822	11/16"
477814	7/16"	477824	3/4"
477816	1/2"	477825	25/32"
477818	9/16"	477826	13/16"
477819	19/32"	477828	7/8"
477820	5/8"		

**Accessory:**  
 320042 2-way Adapter, 3/8"F x 1/2"M  
 424125 1/2" Dr. Extension Bar, 5"L  
 424323 1/2" Dr. Extension Bar, 10"L  
 480070 1/2" Dr. Universal Joint  
 480431R 1/2" Dr. 36T Quick Release Ratchet  
 Blow Case

6000 g 3 sets / 19 Kgs / 1.16 CUFT





# Hand Socket Sets

## TW-446MS 46 Piece 1/2" Dr. Metric & SAE Hand Socket Set (12-Point)

Item No.	Size	Item No.	Size
<b>1/2" Dr. 12pt Hand Socket:</b>			
433808	8mm	433827	27mm
433809	9mm	433828	28mm
433810	10mm	433830	30mm
433811	11mm	433832	32mm
433812	12mm	473812	3/8"
433813	13mm	473814	7/16"
433814	14mm	473816	1/2"
433815	15mm	473818	9/16"
433816	16mm	473820	5/8"
433817	17mm	473822	11/16"
433818	18mm	473824	3/4"
433819	19mm	473826	13/16"
433820	20mm	473828	7/8"
433821	21mm	473830	15/16"
433822	22mm	473832	1"
433823	23mm	473836	1-1/8"
433824	24mm	473838	1-3/16"
433825	25mm	473840	1-1/4"
433826	26mm		

### 1/2" Dr. Accessory:

424125	Extension Bar, 125mmL
424250	Extension Bar, 250mmL
480040	Sliding T-Handle
480070	Universal Joint
480446PP	Pin Handle
480446A	Hinge Handle
427016	16.0mm Spark Plug Socket
427021	20.6mm Spark Plug Socket
480444R	24T Reversible Ratchet
	Metal Box

9800 g 2 sets / 21 Kgs / 0.73 CUFT



12 pt.

## SS-425M 25 Piece 1/2" Dr. Metric Hand Socket Set

Item No.	Size	Item No.	Size
<b>1/2" Dr. 6pt Hand Socket:</b>			
423808	8mm	423821	21mm
423809	9mm	423822	22mm
423810	10mm	423823	23mm
423811	11mm	423824	24mm
423812	12mm	423825	25mm
423813	13mm	423826	26mm
423814	14mm	423827	27mm
423815	15mm	423828	28mm
423816	16mm	423829	29mm
423817	17mm	423830	30mm
423818	18mm	423832	32mm
423819	19mm	423836	36mm
423820	20mm		Plastic Tray

3500 g 3 sets / 12 Kgs / 0.82 CUFT



(192W x 406D)

6 pt.

1/3

## SS-422S 22 Piece 1/2" Dr. SAE Hand Socket Set

Item No.	Size	Item No.	Size
<b>1/2" Dr. 6pt Hand Impact Socket:</b>			
483810	5/16"	483828	7/8"
483812	3/8"	483830	15/16"
483814	7/16"	483832	1"
483816	1/2"	483834	1-1/16"
483818	9/16"	483836	1-1/8"
483819	19/32"	483838	1-3/16"
483820	5/8"	483840	1-1/4"
483822	11/16"	483842	1-5/16"
483824	3/4"	483844	1-3/8"
483825	25/32"	483846	1-7/16"
483826	13/16"	483848	1-1/2"

Plastic Tray

4000 g

3 sets / 13 Kgs / 0.82 CUFT



(192W x 406D)

6 pt.

1/3

## DS-424M 24 Piece 1/2" Dr. Metric Deep Hand Socket Set

Previous Item No.: DS-425M

Item No.	Size	Item No.	Size
<b>1/2" Dr. 6pt Deep Hand Socket:</b>			
427808	8mm	427820	20mm
427809	9mm	427821	21mm
427810	10mm	427822	22mm
427811	11mm	427823	23mm
427812	12mm	427824	24mm
427813	13mm	427825	25mm
427814	14mm	427826	26mm
427815	15mm	427827	27mm
427816	16mm	427828	28mm
427817	17mm	427830	30mm
427818	18mm	427832	32mm
427819	19mm	427836	36mm

Blow-mold Tray

7000 g

3 sets / 22 Kgs / 0.82 CUFT



(192W x 406D)

6 pt.

1/3

## DS-422S 22 Piece 1/2" Dr. SAE Deep Hand Socket Set

Item No.	Size	Item No.	Size
<b>1/2" Dr. 6pt Deep Hand Socket:</b>			
487810	5/16"	487828	7/8"
487812	3/8"	487830	15/16"
487814	7/16"	487832	1"
487816	1/2"	487834	1-1/16"
487818	9/16"	487836	1-1/8"
487819	19/32"	487838	1-3/16"
487820	5/8"	487840	1-1/4"
487822	11/16"	487842	1-5/16"
487824	3/4"	487844	1-3/8"
487825	25/32"	487846	1-7/16"
487826	13/16"	487848	1-1/2"

Plastic Tray

6700 g

3 sets / 21 Kgs / 0.82 CUFT



(192W x 406D)

6 pt.

1/3





# Hand Socket Sets

## MS-435M 35 Piece 1/2" Dr. Metric Deep Hand Socket Set (6 & 12-Point)

Item No.	Size	Item No.	Size
<b>1/2" Dr. 12pt Hand Socket:</b>			
433810	10mm	433819	19mm
433812	12mm	433821	21mm
433813	13mm	433822	22mm
433814	14mm	433824	24mm
433815	15mm	433827	27mm
433816	16mm	433830	30mm
433817	17mm	433832	32mm
433818	18mm		

<b>1/2" Dr. 6pt Deep Hand Socket:</b>			
427810	10mm	427819	19mm
427812	12mm	427821	21mm
427813	13mm	427822	22mm
427814	14mm	427824	24mm
427815	15mm	427827	27mm
427816	16mm	427830	30mm
427817	17mm	427832	32mm
427818	18mm		

- 1/2" Dr. Accessory:**
- 420002B Wobble Extension Bar, 50mmL
  - 420003B Wobble Extension Bar, 75mmL
  - 420005B Wobble Extension Bar, 125mmL
  - 420010B Wobble Extension Bar, 250mmL
  - 480070 Universal Joint
- Plastic Tray

5900 g 3 sets / 19.5 Kgs / 1.35 CUFT



(285W x 410D x 50H)



## MS-437M 37 Piece 1/2" Dr. Metric Hand Socket Set

Item No.	Size	Item No.	Size
<b>1/2" Dr. 6pt Hand Socket:</b>			
423808	8mm	423818	18mm
423809	9mm	423819	19mm
423810	10mm	423821	21mm
423811	11mm	423822	22mm
423812	12mm	423824	24mm
423813	13mm	423827	27mm
423814	14mm	423830	30mm
423815	15mm	423832	32mm
423816	16mm	423836	36mm
423817	17mm		

<b>1/2" Dr. E-Star Hand Socket:</b>			
454510	E-10	454518	E-18
454511	E-11	454520	E-20
454512	E-12	454522	E-22
454514	E-14	454524	E-24
454516	E-16		

- 1/2" Dr. Accessory:**
- 424050 Extension Bar, 50mmL 480070 Universal Joint
  - 424125 Extension Bar, 125mmL 420033 Adapter, 1/2" F x 3/8" M
  - 424250 Extension Bar, 250mmL 427016 16.0mm Spark Plug Socket
  - 480446P Hinge Handle 427021 20.6mm Spark Plug Socket
  - 480431S 36T Quick Release Ratchet
- Plastic Tray

5700 g 3 sets / 19 Kgs / 1.35 CUFT



(285W x 410D x 50H)



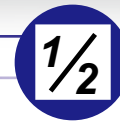

## TX-409 9 Piece 1/2" Dr. Star Hand Socket Set

Item No.	Size	Item No.	Size
<b>1/2" Dr. Star Hand Socket:</b>			
454510	E-10	454518	E-18
454511	E-11	454520	E-20
454512	E-12	454522	E-22
454514	E-14	454524	E-24
454516	E-16	Metal Box	



800 g 20 sets / 17 Kgs / 0.64 CUFT

## TX-23414 14 Piece 1/4", 3/8" & 1/2" Dr. Star Hand Socket Set

Item No.	Size	Item No.	Size	Item No.	Size
<b>1/4" Dr. E-Star Hand Socket:</b>			<b>1/2" Dr. E-Star Hand Socket:</b>		
252504	E-4	252507	E-7	454518	E-18
252505	E-5	252508	E-8	454520	E-20
252506	E-6			454522	E-22
<b>3/8" Dr. E-Star Hand Socket:</b>			454524	E-24	
353510	E-10	353514	E-14	Socket Holder	
353511	E-11	353516	E-16		
353512	E-12				



710 g 10x4 40 sets / 29.5 Kgs / 1.6 CUFT

## TX-2315 15 Piece 1/4" & 3/8" Dr. Star Hand Socket Set

Item No.	Size	Item No.	Size	Item No.	Size
<b>1/4" Dr. E-Star Hand Socket:</b>			<b>Accessory:</b>		
252504	E-4	252508	E-8	380020	3/8" Dr. Adapter, 3/8"F x 1/4"M
252505	E-5	252510	E-10	Socket Holder	
252506	E-6	252511	E-11		
252507	E-7				
<b>3/8" Dr. E-Star Hand Socket:</b>					
353510	E-10	353516	E-16		
353511	E-11	353518	E-18		
353512	E-12	353520	E-20		
353514	E-14				



510 g 10x4 40 sets / 21.5 Kgs / 1.6 CUFT

## TX-414 14 Piece 1/2" Dr. Star Hand Socket Set

Item No.	Size	Item No.	Size
<b>1/2" Dr. E-Star Hand Socket:</b>			
454508	E-8	454520	E-20
454510	E-10	454522	E-22
454511	E-11	454524	E-24
454512	E-12	454526	E-26
454514	E-14	454528	E-28
454516	E-16	454530	E-30
454518	E-18	454532	E-32
Socket Holder			



1500 g 10x1 10 sets / 16 Kgs / 0.6 CUFT

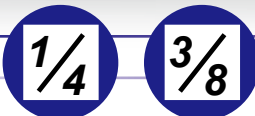

# Star Hand Socket Sets

## TX-2356 56 Piece Complete Star Type Wrench Set

Item No.	Size	Item No.	Size
<b>1/4" Dr. E-Star Hand Socket:</b>			
252504	E-4	252507	E-7
252505	E-5	252508	E-8
252506	E-6		
<b>3/8" Dr. E-Star Hand Socket:</b>			
353510	E-10	353516	E-16
353511	E-11	353518	E-18
353512	E-12	353520	E-20
353514	E-14		
<b>3/8" Dr. Tamperproof Star Bit Socket:</b>			
310+7145	T-45	340+7155	T-55
310+7150	T-50		
<b>L-Shaped Star Wrench:</b>			
580506	T-6	580627	T-27
580507	T-7	580730	T-30
580508	T-8	580840	T-40
580509	T-9	580845	T-45
580510	T-10	580950	T-50
580615	T-15	581055	T-55
580620	T-20	581260	T-60
580625	T-25	581470	T-70
<b>Star Screwdriver w/Plastic Handle:</b>			
592+6606	T-6	593+6925	T-25
592+6607	T-7	594+6827	T-27
592+6608	T-8	594+6830	T-30
592+6609	T-9	595+6840	T-40
593+6710	T-10	595+6845	T-45
593+6715	T-15	595+6850	T-50
593+6920	T-20		

3650 g 4 sets / 15.5 Kgs / 1.65 CUFT

## Tamperproof Star Bit, 30mmL:

Item No.	Size
7107	1/4" Hex Shank T-7
7108	1/4" Hex Shank T-8
7109	1/4" Hex Shank T-9
7110	1/4" Hex Shank T-10
7115	1/4" Hex Shank T-15
7120	1/4" Hex Shank T-20
7125	1/4" Hex Shank T-25
7127	1/4" Hex Shank T-27
7130	1/4" Hex Shank T-30
7140	1/4" Hex Shank T-40

## Accessory:

283508	1/4" Dr. 1/4" Hex Shank Bit Holder
380371	1/4" & 3/8" Double Drive Ratchet Blow Case



## TX-2319 19 Piece 1/4" & 3/8" Dr. Star Hand Socket Set

Item No.	Size	Item No.	Size	Item No.	Size
<b>1/4" Dr. E-Star Hand Socket:</b>					
252504	E-4	252508	E-8		
252505	E-5	252510	E-10		
252506	E-6	252511	E-11		
252507	E-7				
<b>3/8" Dr. E-Star Hand Socket:</b>					
353510	E-10	353516	E-16		
353511	E-11	353518	E-18		
353512	E-12	353520	E-20		
353514	E-14				

1600 g 10 sets / 17 Kgs / 0.77 CUFT

Item No.	Size
220160	1/4" Dr. Folding Socket Driver
320020	3/8" Dr. Adapter, 3/8" F x 1/4" M
320075	3/8" Dr. Extension Bar, 75mmL
320150	3/8" Dr. Extension Bar, 150mmL
380333R	3/8" Dr. Reversible Ratchet Handle Metal Box



# Hand Socket Sets

1/4

1/2

## AC-2487 87 Piece 1/4" & 1/2" Dr. Metric Master Tools Set (6 & 12-Point)

Item No.	Size	Item No.	Size	Item No.	Size
<b>1/4" Dr. 6pt Hand Socket:</b>					
222503	3mm	222508	8mm	220002	1/4" Dr. Extension Bar, 50mmL
222504	4mm	222509	9mm	220004	1/4" Dr. Extension Bar, 100mmL
2225045	4.5mm	222510	10mm	280020	1/4" Dr. Sliding T-Handle
222505	5mm	222511	11mm	280070	1/4" Dr. Universal Joint
2225055	5.5mm	222512	12mm	280222R	1/4" Dr. 24T Reverible Ratchet
222506	6mm	222513	13mm	220150	1/4" Dr. Socket Driver
222507	7mm	222514	14mm	282408	1/4" Dr. 1/4" Hex Shank Bit Holder
<b>1/4" Dr. 6pt Deep Hand Socket:</b>					
225206	6mm	225210	10mm	424125	1/2" Dr. Extension Bar, 125mmL
225207	7mm	225211	11mm	424250	1/2" Dr. Extension Bar , 250mmL
225208	8mm	225212	12mm	480070	1/2" Dr. Universal Joint
225209	9mm	225213	13mm	427016	1/2" Dr. 16.0mm Spark Plug Socket
<b>1/2" Dr. 12pt Hand Socket:</b>					
433810	10mm	433821	21mm	427021	1/2" Dr. 20.6mm Spark Plug Socket
433813	13mm	433822	22mm	484810	1/2" Dr. 5/16" Hex Shank Bit Holder
433815	15mm	433823	23mm	480444R	1/2" Dr. 24T Reverible Ratchet
433816	16mm	433824	24mm	Blow Case	
433817	17mm	433827	27mm		
433818	18mm	433830	30mm		
433819	19mm	433832	32mm		
433820	20mm				
<b>1/2" Dr. 12pt Deep Hand Socket:</b>					
437814	14mm	437817	17mm		
437816	16mm	437819	19mm		
<b>1/4" Hex Shank Screwdriver Bit, 30mmL:</b>					
1140	0.6 x 4.0mm Slotted	1211	#1 Posidriv		
1155	0.8 x 5.5mm Slotted	1212	#2 Posidriv		
1165	1.0 x 6.5mm Slotted	7108	T-8 Tamperproof Star		
1101	#1 Philips	7110	T-10 Tamperproof Star		
1102	#2 Philips	7115	T-15 Tamperproof Star		
2133	3mm Hex	7120	T-20 Tamperproof Star		
2134	4mm Hex	7125	T-25 Tamperproof Star		
2135	5mm Hex	7130	T-30 Tamperproof Star		
2136	6mm Hex				
<b>5/16" Hex Shank Screwdriver Bit, 30mmL:</b>					
2148	8mm Hex	213080	1.6 x 8.0mm Slotted		
2930100	10mm Hex	2130100	1.6 x 10.0mm Slotted		
2930120	12mm Hex	2130120	2.0 x 12.0mm Slotted		
2930140	14mm Hex	1123	#3 Philips		
6240	T-40 Star	1124	#4 Philips		
6245	T-45 Star	1223	#3 Posidriv		
6250	T-50 Star	1224	#4 Posidriv		
223055	T-55 Star				

6120 g 4 sets / 25.5 Kgs / 1.65 CUFT



Hand Sockets

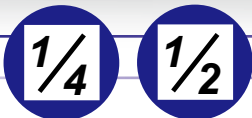

# Hand Socket Sets

## AC-2487A 87 Piece 1/4" & 1/2" Dr. Metric Master Tools Set

Item No.	Size	Item No.	Size	Item No.	Size
<b>1/4" Dr. 6pt Hand Socket:</b>					
222503	3mm	222508	8mm	220002	1/4" Dr. Extension Bar, 50mmL
222504	4mm	222509	9mm	220004	1/4" Dr. Extension Bar, 100mmL
2225045	4.5mm	222510	10mm	280020	1/4" Dr. Sliding T-Handle
222505	5mm	222511	11mm	280070	1/4" Dr. Universal Joint
2225055	5.5mm	222512	12mm	280231S	1/4" Dr. 36T Quick Release Ratchet
222506	6mm	222513	13mm	506+0175	1/4" Dr. Socket Driver
222507	7mm	222514	14mm	282408	1/4" Dr. 1/4" Hex Shank Bit Holder
<b>1/4" Dr. 6pt Deep Hand Socket:</b>					
225206	6mm	225210	10mm	424125	1/2" Dr. Extension Bar, 125mmL
225207	7mm	225211	11mm	424250	1/2" Dr. Extension Bar, 250mmL
225208	8mm	225212	12mm	480070	1/2" Dr. Universal Joint
225209	9mm	225213	13mm	427016	1/2" Dr. 16.0mm Spark Plug Socket
<b>1/2" Dr. 6pt Hand Socket:</b>					
423810	10mm	423819	19mm	427021	1/2" Dr. 20.6mm Spark Plug Socket
423812	12mm	423821	21mm	484810	1/2" Dr. 5/16" Hex Shank Bit Holder
423813	13mm	423822	22mm	480431S	1/2" Dr. 36T Quick Release Ratchet
423814	14mm	423824	24mm	Blow Case	
423815	15mm	423827	27mm		
423816	16mm	423830	30mm		
423817	17mm	423832	32mm		
423818	18mm				
<b>1/2" Dr. 6pt Deep Hand Socket:</b>					
427810	10mm	427817	17mm		
427813	13mm	427819	19mm		
<b>1/4" Hex Shank Screwdriver Bit, 30mmL:</b>					
1140	0.6 x 4.0mm Slotted	1211	#1 Posidriv		
1155	0.8 x 5.5mm Slotted	1212	#2 Posidriv		
1165	1.0 x 6.5mm Slotted	6108	T-8 Star		
1101	#1 Philips	6110	T-10 Star		
1102	#2 Philips	6115	T-15 Star		
2133	3mm Hex	6120	T-20 Star		
2134	4mm Hex	6125	T-25 Star		
2135	5mm Hex	6130	T-30 Star		
2136	6mm Hex				
<b>5/16" Hex Shank Screwdriver Bit, 30mmL:</b>					
2148	8mm Hex	1290	1.6 x 9.0mm Slotted		
2930100	10mm Hex	2130100	1.6 x 10.0mm Slotted		
2930120	12mm Hex	2130120	2.0 x 12.0mm Slotted		
2930140	14mm Hex	1123	#3 Philips		
6240	T-40 Star	1124	#4 Philips		
6245	T-45 Star	1223	#3 Posidriv		
6250	T-50 Star	1224	#4 Posidriv		
223055	T-55 Star				

6120 g 4 sets / 25.5 Kgs / 1.65 CUFT



# Hand Socket Sets



## AC-23117 117 Piece 1/4" & 3/8" Dr. Metric & SAE Tool Set

Item No.	Pcs	Description	Item No.	Pcs	Description
222504	12	1/4" Dr. 6-Point Metric Hand Sockets:	726010	6	Metric Combination Wrenches:
222513		4, 4.5, 5, 5.5, 6, 7, 8, 9, 10, 11, 12, 13mm	726018		10, 12, 13, 15, 17, 18mm
282506	9	1/4" Dr. 6-Point SAE Hand Sockets:	737012	7	SAE Combination Wrenches:
282516		3/16, 7/32, 1/4, 9/32, 5/16, 11/32, 3/8, 7/16, 1/2"	737024		3/8, 7/16, 1/2, 9/16, 5/8, 11/16, 3/4"
323209	8	3/8" Dr. 6-Point Metric Hand Sockets:	HK-009M	9	Metric L-Shaped Hex Wrenches:
323218		9, 10, 12, 13, 14, 15, 17, 18mm			1.5, 2, 2.5, 3, 4, 5, 6, 8, 10mm
383210	9	3/8" Dr. 6-Point SAE Hand Sockets:	550601	3	6" Linesman, 6" Longnose &
383224		5/16, 11/32, 3/8, 7/16, 1/2, 9/16, 5/8, 11/16, 3/4"	550603		6" Diagonal Cutting
QB-011	11	1/4" Hex Shank Square Bits:	220002	1	1/4" Dr. Extension Bar, 50mmL(2"L)
		S#1(3pcs), S#2(5pcs), S#3(3pcs)	220160	1	1/4" Dr. Folding Socket Driver
PB-011	11	1/4" Hex Shank Phillips Bits: #0, 1, 2(3pcs), 3(2pcs)	282408	1	1/4" Dr. Hex Bit Holder
		1/4" Hex Shank Posidriv Bits: #0, 1, 2, 3	286008M	1	1/4" Dr. Insert Bit Holder
SB-011	11	1/4" Hex Shank Slotted Bits:	280150	1	1/4" Hex Shank Bit Holder with Handle
		0.5x3(2pcs), 0.6x4(2pcs), 0.8x5(2pcs), 1.0x6(2pcs)	320075	2	3/8" Dr. Hand Extension Bars:
		1/4" Hex Shank Metric Hex Bits: 3, 4, 5mm	320150		75mmL(3"), 150mmL(6"L)
TB-011	11	1/4" Hex Shank Star Bits: T-10, 15, 20, 25, 27, 30, 40	320020	1	3/8" Dr. Adapter, 3/8"F x 1/4"M
		1/4" Hex Shank Metric Hex Bits: 6, 7, 8mm	380372	1	3/8" Dr. 72 Teeth Reversible Ratchet
		1/4" Hex Shank 1/4" Dr. Adapter			Blow Case

5600 g

3 sets / 18 Kgs / 2.06 CUFT



AC-23117



AC-234125

## AC-234125 125 Piece 1/4", 3/8" & 1/2" Dr. Metric Tool Set

Item No.	Pcs	Description	Item No.	Pcs	Description
222504	12	1/4" Dr. 6-Point Metric Hand Sockets:	HK-009M	9	Metric L-Shaped Hex Wrenches:
222513		4, 4.5, 5, 5.5, 6, 7, 8, 9, 10, 11, 12, 13mm			1.5, 2, 2.5, 3, 4, 5, 6, 8, 10mm
323206	14	3/8" Dr. 6-Point Metric Hand Sockets:	550601	3	6" Linesman, 6" Longnose &
323219		6, 7, 8, 9, 10, 11, 12, 13, 14, 15, 16, 17, 18, 19mm	550603		6" Diagonal Cutting
423811	17	1/2" Dr. 6-Point Metric Hand Sockets:	220002	1	1/4" Dr. Extension Bar, 50mmL
423827		11, 12, 13, 14, 15, 16, 17, 18, 19, 20, 21, 22, 23, 24, 25, 26, 27mm	220160	1	1/4" Dr. Folding Socket Driver
QB-011	11	1/4" Hex Shank Square Bits:	282408	1	1/4" Dr. Hex Bit Holder
		S#1(3pcs), 2(5pcs), 3(3pcs)	286008M	1	1/4" Dr. Insert Bit Holder
PB-011	11	1/4" Hex Shank Phillips Bits: #0, 1, 2(3pcs), 3(2pcs)	280150	1	1/4" Hex Shank Bit Holder with Handle
		1/4" Hex Shank Posidriv Bits: #0, 1, 2, 3	320075	2	3/8" Dr. Hand Extension Bars:
SB-011	11	1/4" Hex Shank Slotted Bits:	320150		75 & 150mmL
		0.5x3(2pcs), 0.6x4(2pcs), 0.8x5(2pcs), 1.0x6(2pcs)	320020	1	3/8" Dr. Adapter, 3/8"F x 1/4"M
		1/4" Hex Shank Metric Hex Bits: 3, 4, 5mm	380372	1	3/8" Dr. 72 Teeth Reversible Ratchet
TB-011	11	1/4" Hex Shank Star Bits: T-10, 15, 20, 25, 27, 30, 40	424125	2	1/2" Dr. Hand Extension Bars:
		1/4" Hex Shank Metric Hex Bits: 6, 7, 8mm	424250		125 & 250mmL
		1/4" Hex Shank 1/4" Dr. Adapter	427016	2	1/2" Dr. Spark Plug Sockets:
			427021		16.0 & 20.6mm
726006	11	Metric Combination Wrenches: 6, 7, 8, 9, 10,	480472	1	1/2" Dr. 72 Teeth Reversible Ratchet
726019		11, 12, 13, 14, 17, 19mm			Blow Case

7600 g

3 sets / 23.8 Kgs / 1.41 CUFT



# Hand Socket Sets

## AC234161S 161 Piece 1/4", 3/8" & 1/2" Dr. Metric & SAE Master Set (Rubber Handle)

Item No.	Pcs	Description	Item No.	Pcs	Description
222504	11	1/4" Dr. 6-Point Metric Hand Sockets:	27206P	3	1/4" Hex Shank Spinner Handle:
222512		4, 4.5, 5, 5.5, 6, 7, 8, 9, 10, 11, 12mm	27406P		1/4", 3/8" & 1/2" Dr.
282504	7	1/4" Dr. 6-Point SAE Hand Sockets:	726008	12	Metric Combination Wrenches: 8, 9, 10,
282511		1/8, 3/16, 7/32, 1/4, 9/32, 5/16, 11/32"	726019		11, 12, 13, 14, 15, 16, 17, 18, 19mm
252504	6	1/4" Dr. Star Hand Sockets:	HK-009MB	9	Metric L-Shaped Wobble Hex Wrenches:
252510		E4, 5, 6, 7, 8, 10	550601	3	1.5, 2, 2.5, 3, 4, 5, 6, 8, 10mm
225208	6	1/4" Dr. 6-Point Metric Deep Hand Sockets:	550603	3	6" Linesman, 6" Longnose &
225214		8, 9, 10, 12, 13, 14mm	220002	2	6" Diagonal Cutting
323213	7	3/8" Dr. 6-Point Metric Hand Sockets:	220006		1/4" Dr. Hand Extension Bars:
323219		13, 14, 15, 16, 17, 18, 19mm	280231S	1	50mmL(2"), 150mmL(6"L)
373212	9	3/8" Dr. 12-Point SAE Hand Sockets:	280070	1	1/4" Dr. 36T Quick Release Ratchet
373228		3/8, 7/16, 1/2, 9/16, 5/8, 11/16, 3/4, 13/16, 7/8"	506+0175	1	1/4" Dr. Hand Universible Joint
353512	5	3/8" Dr. Star Hand Socket:	282408	1	1/4" Dr. Socket Driver
353520		E12, 14, 16, 18, 20	286008	1	1/4" Dr. Hex Bit Holder
423820	7	1/2" Dr. 6-Point Metric Hand Sockets:	320075	1	1/4" Dr. Magnetic Bit Holder Adapter
423832		20, 21, 22, 24, 27, 30, 32 mm	380331S	1	3/8" Dr. Hand Extension Bar, 75mmL(3"L)
473830	4	1/2" Dr. 12-Point SAE Hand Sockets:	326014	3	3/8" Dr. 36T Quick Release Ratchet
473840		15/16, 1, 1-1/16, 1-1/4"	326021		3/8" Dr. Spark Plug Sockets:
417817	3	1/2" Dr. 6-Point Metric Deep Impact Sockets:	380070	1	14.0, 16.0 & 20.6mm
417821		17, 19, 21mm	424128	2	3/8" Dr. Hand Universal Joint
SB-111SP	10	1/4" Hex Shank Bits: #0, #1, #2, #3,	424253		1/2" Dr. Hand Extension Bars:
		0.5x3.0, 0.6x4.0, 0.8x5.0, 1.0x6.0, 1.2x7.0mm	320042	1	125mmL(5"), 250mmL(10"L)
	1	1/4" Hex Shank 1/4" Square Adapter	480431S	1	2-way Adapter, 3/8"F x 1/2"M
1210	4	1/4" Hex Shank Posidriv Bits:	480070	1	1/2" Dr. 36T Quick Release Ratchet
1213		#0, #1, #2, #3			1/2" Dr. Hand Universal Joint
SB-211MH	8	1/4" Hex Shank Hex Bits:			
		2, 2.5, 3, 4, 5, 6, 7, 8mm			
	3	1/4" Hex Shank Triple Square Bits: M4, M5, M6			
SB-711TP	11	1/4" Hex Shank Star Bits:			
		T6, 7, 8, 9, 10, 15, 20, 25, 27, 30, 40			
SB-811TP	11	1/4" Hex Shank Tamperproof Star Bits:			
		T7, 8, 9, 10, 15, 20, 25, 27, 30, 40, 45			
283050A	3	1/4" Hex Shank Tamperproof Star Bits:			
283060A		T50, 55, 60			

11.1 Kg

2 sets / 23.0 Kgs / 1.60 CUFT



AC234161P



AC234161A



AC234161R



Made of Chrome Vanadium Steel



## Metric Hand Sockets

Item No.	A mm	D1 mm	D2 mm	Length mm	Weight g	PCS		G.W. KGS	CUFT
						inner/ctn			
625217	17	27.0	37.8	51	220	5 / 50	12.0	0.34	
625218	18	28.0	37.8	51	230	5 / 50	12.5	0.34	
625219	19	29.5	37.8	51	240	5 / 50	13.0	0.34	
625220	20	30.7	37.8	51	240	5 / 50	13.0	0.34	
625221	21	32.0	37.8	51	240	5 / 50	13.0	0.34	
625222	22	33.0	39.8	51	270	5 / 50	15.0	0.34	
625223	23	34.5	39.8	51	270	5 / 50	15.0	0.34	
625224	24	35.7	39.8	51	280	5 / 50	15.0	0.34	
625225	25	37.0	39.8	54	300	5 / 50	16.0	0.34	
625226	26	38.0	40.8	54	320	5 / 50	17.0	0.34	
625227	27	39.5	41.8	54	320	5 / 50	17.0	0.41	
625228	28	40.8	38.0	54	320	5 / 50	17.0	0.41	
625229	29	41.8	39.0	54	320	5 / 50	17.0	0.41	
625230	30	42.8	40.0	54	330	5 / 50	17.5	0.41	
625231	31	44.5	41.0	54	340	5 / 50	18.0	0.41	
625232	32	45.8	42.0	57	390	5 / 30	13.0	0.34	
625233	33	47.0	43.0	57	400	5 / 30	13.0	0.34	
625234	34	48.0	43.0	57	420	5 / 30	13.5	0.34	
625235	35	50.0	44.0	57	440	5 / 30	14.5	0.34	
625236	36	51.0	44.0	57	460	5 / 30	15.0	0.34	
625237	37	52.0	44.0	57	470	5 / 30	15.0	0.34	
625238	38	53.0	44.0	57	470	5 / 30	15.0	0.34	
625239	39	54.5	44.0	58	500	5 / 30	16.0	0.34	
625240	40	55.7	44.0	58	530	5 / 30	17.0	0.34	
625241	41	57.0	44.0	58	550	5 / 30	17.5	0.34	
625242	42	58.0	44.0	61	560	1 / 20	12.0	0.39	
625243	43	59.5	44.0	61	580	1 / 20	13.0	0.39	
625244	44	60.7	44.0	63	640	1 / 20	14.0	0.39	
625245	45	62.0	44.0	63	640	1 / 20	14.0	0.39	
625246	46	63.0	44.0	63	650	1 / 20	14.0	0.39	
625247	47	64.0	44.0	64	700	1 / 20	15.0	0.39	
625248	48	65.7	44.0	65	720	1 / 20	15.5	0.39	
625249	49	67.0	44.0	65	730	1 / 20	15.5	0.39	
625250	50	68.0	44.0	68	780	1 / 20	17.0	0.39	
625251	51	69.0	44.0	68	780	1 / 20	17.0	0.39	
625252	52	70.7	54.0	70	1000	1 / 20	21.0	0.39	
625253	53	72.0	54.0	70	1030	1 / 10	11.5	0.43	
625254	54	73.0	54.0	73	1080	1 / 10	12.0	0.43	
625255	55	74.5	54.0	73	1100	1 / 10	12.0	0.43	
625256	56	75.7	54.0	73	1130	1 / 10	12.5	0.43	
625257	57	77.0	54.0	73	1150	1 / 10	12.5	0.43	
625258	58	78.0	54.0	73	1210	1 / 10	13.0	0.43	
625259	59	79.5	60.0	73	1290	1 / 10	14.0	0.43	
625260	60	80.7	60.0	80	1450	1 / 10	15.5	0.43	
625261	61	82.0	60.0	80	1450	1 / 10	15.5	0.43	
625262	62	83.0	60.0	80	1480	1 / 10	16.0	0.43	
625263	63	84.5	60.0	80	1580	1 / 10	17.0	0.43	
625264	64	85.7	60.0	80	1580	1 / 10	17.0	0.43	
625265	65	87.0	60.0	85	1700	1 / 10	18.0	0.43	
625266	66	88.0	60.0	85	1700	1 / 6	11.0	0.41	
625267	67	89.0	60.0	85	1700	1 / 6	11.0	0.41	
625268	68	90.7	60.0	85	1800	1 / 6	12.0	0.41	
625269	69	92.0	60.0	85	1900	1 / 6	12.5	0.41	
625270	70	93.0	60.0	90	2000	1 / 6	13.0	0.41	
625271	71	94.5	60.0	90	2100	1 / 6	13.5	0.41	
625272	72	95.7	60.0	90	2130	1 / 6	13.5	0.41	
625273	73	97.0	60.0	90	2160	1 / 6	14.0	0.41	
625274	74	98.0	60.0	90	2180	1 / 6	14.0	0.41	
625275	75	99.0	60.0	90	2200	1 / 6	14.0	0.41	
625276	76	101.0	60.0	90	2270	1 / 6	14.0	0.41	

6 pt.

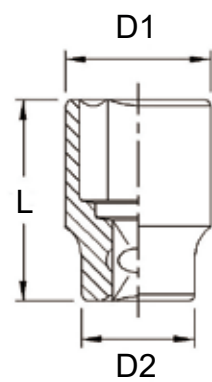
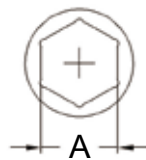

Hand Sockets





# Hand Sockets

## SAE Hand Sockets

Item No.	A inch	D1 mm	D2 mm	Length mm	Weight g	PCS		G.W. KGS	CUFT
						inner/ctn			
685222	11/16	27.6	37.8	51	240	5 / 50	13.0	0.34	
685224	3/4	29.6	37.8	51	240	5 / 50	13.0	0.34	
685225	25/32	30.5	37.8	51	240	5 / 50	13.0	0.34	
685226	13/16	31.5	37.8	51	240	5 / 50	13.0	0.34	
685228	7/8	33.0	39.8	51	270	5 / 50	15.0	0.34	
685230	15/16	35.5	39.8	51	280	5 / 50	15.0	0.34	
685232	1	37.5	39.8	54	310	5 / 50	16.5	0.34	
685234	1-1/16	39.5	41.8	54	320	5 / 50	17.0	0.41	
685236	1-1/8	41.8	39.0	54	320	5 / 50	17.0	0.41	
685238	1-3/16	42.8	40.0	54	330	5 / 50	17.5	0.41	
685240	1-1/4	45.4	42.0	57	390	5 / 30	13.0	0.34	
685242	1-5/16	47.0	43.0	57	400	5 / 30	13.0	0.34	
685244	1-3/8	49.5	44.0	57	440	5 / 30	14.5	0.34	
685246	1-7/16	51.0	44.0	57	460	5 / 30	15.0	0.34	
685248	1-1/2	53.0	44.0	57	470	5 / 30	15.0	0.34	
685250	1-9/16	55.4	44.0	58	540	5 / 30	17.0	0.34	
685252	1-5/8	57.0	44.0	58	550	5 / 30	17.5	0.34	
685254	1-11/16	59.3	44.0	61	580	1 / 20	13.0	0.39	
685256	1-3/4	61.0	44.0	63	640	1 / 20	14.0	0.39	
685258	1-13/16	63.0	44.0	63	650	1 / 20	14.0	0.39	
685260	1-7/8	65.3	44.0	65	730	1 / 20	15.5	0.39	
685262	1-15/16	67.0	44.0	65	730	1 / 20	15.5	0.39	
685264	2	69.0	44.0	68	780	1 / 20	17.0	0.39	
685266	2-1/16	71.0	54.0	70	1000	1 / 20	21.0	0.39	
685268	2-1/8	73.0	54.0	73	1080	1 / 10	12.0	0.43	
685270	2-3/16	75.0	54.0	73	1100	1 / 10	12.0	0.43	
685272	2-1/4	77.0	54.0	73	1150	1 / 10	12.5	0.43	
685274	2-5/16	79.2	60.0	73	1310	1 / 10	14.0	0.43	
685276	2-3/8	81.0	60.0	80	1450	1 / 10	15.5	0.43	
685278	2-7/16	83.0	60.0	80	1480	1 / 10	16.0	0.43	
685280	2-1/2	85.0	60.0	80	1520	1 / 10	16.5	0.43	
685282	2-9/16	87.0	60.0	85	1700	1 / 10	18.0	0.43	
685284	2-5/8	89.0	60.0	85	1700	1 / 6	11.0	0.41	
685286	2-11/16	90.7	60.0	85	1800	1 / 6	12.0	0.41	
685288	2-3/4	93.0	60.0	90	2000	1 / 6	13.0	0.41	
685290	2-13/16	94.0	60.0	90	2100	1 / 6	13.5	0.41	
685292	2-7/8	97.0	60.0	90	2160	1 / 6	14.0	0.41	
685294	2-15/16	99.0	60.0	90	2200	1 / 6	14.0	0.41	
685296	3	101.0	60.0	90	2270	1 / 6	14.0	0.41	



## SS-619S 3/4" Dr. 19 Piece SAE Hand Socket Set

Item No.	Size	Item No.	Size
<b>3/4" Dr. 6pt Hand Socket:</b>			
685224	3/4"	685246	1-7/16"
685226	13/16"	685248	1-1/2"
685228	7/8"	685252	1-5/8"
685230	15/16"	685256	1-3/4"
685232	1"	685260	1-7/8"
685234	1-1/16"	685264	2"
685236	1-1/8"	685268	2-1/8"
685240	1-1/4"	685270	2-3/16"
685242	1-5/16"	685272	2-1/4"
685244	1-3/8"		Blow Case

10.5 Kg      2 sets / 22 Kgs / 0.92 CUFT



## Metric Deep Hand Sockets

Item No.	A mm	D1 mm	D2 mm	Length mm	Weight g	PCS inner/ctn	G.W. KGS	CUFT
629517	17	27.0	37.8	90	340	1 / 30	11.5	0.52
629518	18	28.0	37.8	90	360	1 / 30	12.0	0.52
629519	19	29.5	37.8	90	370	1 / 30	12.5	0.52
629520	20	30.7	37.8	90	380	1 / 30	12.5	0.52
629521	21	32.0	37.8	90	390	1 / 30	13.0	0.52
629522	22	33.0	39.8	90	440	1 / 30	14.5	0.52
629523	23	34.5	39.8	90	450	1 / 30	15.0	0.52
629524	24	35.7	39.8	90	460	1 / 30	15.0	0.52
629525	25	37.0	39.8	90	480	1 / 30	15.5	0.52
629526	26	38.0	40.8	90	500	1 / 30	16.0	0.52
629527	27	39.5	41.8	90	520	1 / 30	16.5	0.52
629528	28	40.8	38.0	90	520	1 / 30	16.5	0.52
629529	29	42.0	39.0	90	530	1 / 30	17.0	0.52
629530	30	43.0	40.0	90	530	1 / 30	17.0	0.52
629531	31	44.5	41.0	90	540	1 / 30	17.0	0.52
629532	32	45.7	42.0	90	590	1 / 30	19.0	0.52
629533	33	47.0	43.0	90	630	1 / 30	20.0	0.52
629534	34	48.0	43.0	90	640	1 / 30	20.0	0.52
629535	35	49.5	44.0	90	680	1 / 30	21.5	0.52
629536	36	50.7	44.0	90	720	1 / 30	22.5	0.52
629537	37	52.0	44.0	90	720	1 / 30	22.5	0.52
629538	38	53.0	44.0	90	740	1 / 30	23.5	0.52
629539	39	54.5	44.0	90	740	1 / 30	23.5	0.52
629540	40	55.7	44.0	90	790	1 / 30	25.0	0.52
629541	41	57.0	44.0	90	830	1 / 10	9.5	0.31
629542	42	58.0	44.0	90	850	1 / 10	9.5	0.31
629543	43	59.5	44.0	90	890	1 / 10	10.0	0.31
629544	44	60.7	44.0	90	910	1 / 10	10.0	0.31
629545	45	62.0	44.0	95	940	1 / 10	10.5	0.31
629546	46	63.0	44.0	95	1000	1 / 10	11.0	0.31
629547	47	64.0	44.0	95	1060	1 / 10	11.5	0.31
629548	48	65.7	44.0	100	1120	1 / 10	12.0	0.31
629549	49	67.0	44.0	100	1150	1 / 10	12.5	0.31
629550	50	68.0	44.0	100	1180	1 / 10	13.0	0.31
629551	51	69.0	44.0	100	1200	1 / 10	13.0	0.31
629552	52	70.7	44.0	100	1300	1 / 6	9.0	0.41
629553	53	72.0	54.0	100	1370	1 / 6	9.5	0.41
629554	54	73.0	54.0	100	1420	1 / 6	9.5	0.41
629555	55	74.5	54.0	100	1500	1 / 6	10.0	0.41
629556	56	75.7	54.0	100	1550	1 / 6	10.0	0.41
629557	57	77.0	54.0	100	1570	1 / 6	10.5	0.41
629558	58	78.0	54.0	100	1600	1 / 6	11.0	0.41
629559	59	79.5	60.0	100	1700	1 / 6	11.5	0.41
629560	60	80.7	60.0	105	1800	1 / 6	12.0	0.41
629561	61	82.0	60.0	105	1900	1 / 6	12.5	0.41
629562	62	83.0	60.0	105	1950	1 / 6	13.0	0.41
629563	63	84.5	60.0	105	2000	1 / 6	13.0	0.41
629564	64	85.7	60.0	105	2090	1 / 6	13.5	0.41
629565	65	87.0	60.0	105	2110	1 / 6	13.5	0.41
629566	66	88.0	60.0	105	2130	1 / 6	14.0	0.41
629567	67	89.0	60.0	105	2160	1 / 6	14.0	0.41
629568	68	90.7	60.0	105	2270	1 / 6	14.5	0.41
629569	69	92.0	60.0	105	2300	1 / 6	15.0	0.41
629570	70	93.0	60.0	110	2420	1 / 6	15.5	0.41
629571	71	94.5	60.0	110	2550	1 / 3	8.5	0.31
629572	72	95.7	60.0	110	2580	1 / 3	9.0	0.31
629573	73	97.0	60.0	110	2610	1 / 3	9.0	0.31
629574	74	98.0	60.0	110	2640	1 / 3	9.0	0.31
629575	75	99.0	60.0	110	2650	1 / 3	9.0	0.31
629576	76	99.0	60.0	110	2790	1 / 3	9.5	0.31

6 pt.

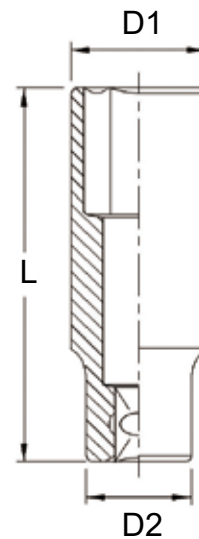
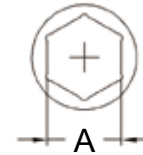



# Hand Sockets

## SAE Deep Hand Sockets

Item No.	A	D1	D2	Length mm	Weight g	PCS inner/ctn	G.W. KGS	CUFT
	inch	mm	mm					
689522	11/16	27.6	37.8	90	340	1 / 30	11.5	0.52
689524	3/4	29.6	37.8	90	370	1 / 30	12.5	0.52
689525	25/32	30.5	37.8	90	380	1 / 30	12.5	0.52
689526	13/16	31.5	37.8	90	390	1 / 30	13.0	0.52
689528	7/8	33.0	39.8	90	440	1 / 30	14.5	0.52
689530	15/16	35.5	39.8	90	460	1 / 30	15.0	0.52
689532	1	37.5	39.8	90	490	1 / 30	16.0	0.52
689534	1-1/16	39.5	41.8	90	520	1 / 30	16.5	0.52
689536	1-1/8	41.5	39.0	90	530	1 / 30	17.0	0.52
689538	1-3/16	42.8	40.0	90	530	1 / 30	17.0	0.52
689540	1-1/4	45.4	42.0	90	590	1 / 30	19.0	0.52
689542	1-5/16	47.0	43.0	90	630	1 / 30	20.0	0.52
689544	1-3/8	49.4	44.0	90	680	1 / 30	21.5	0.52
689546	1-7/16	51.0	44.0	90	720	1 / 30	22.5	0.52
689548	1-1/2	53.0	44.0	90	740	1 / 30	23.5	0.52
689550	1-9/16	55.4	44.0	90	790	1 / 30	25.0	0.52
689552	1-5/8	57.0	44.0	90	830	1 / 10	9.5	0.31
689554	1-11/16	59.3	44.0	90	890	1 / 10	10.0	0.31
689556	1-3/4	61.0	44.0	95	940	1 / 10	10.5	0.31
689558	1-13/16	63.0	44.0	95	1000	1 / 10	11.0	0.31
689560	1-7/8	65.3	44.0	100	1120	1 / 10	12.0	0.31
689562	1-15/16	67.0	44.0	100	1150	1 / 10	12.5	0.31
689564	2	69.0	44.0	100	1200	1 / 10	13.0	0.31
689566	2-1/16	71.0	44.0	100	1300	1 / 6	9.0	0.41
689568	2-1/8	73.0	54.0	100	1420	1 / 6	9.5	0.41
689570	2-3/16	75.0	54.0	100	1500	1 / 6	10.0	0.41
689572	2-1/4	77.0	54.0	100	1570	1 / 6	10.5	0.41
689574	2-5/16	79.2	60.0	100	1700	1 / 6	11.5	0.41
689576	2-3/8	81.0	60.0	105	1800	1 / 6	12.0	0.41
689578	2-7/16	83.0	60.0	105	1950	1 / 6	13.0	0.41
689580	2-1/2	85.0	60.0	105	2000	1 / 6	13.0	0.41
689582	2-9/16	87.0	60.0	105	2110	1 / 6	13.5	0.41
689584	2-5/8	89.0	60.0	105	2160	1 / 6	14.0	0.41
689586	2-11/16	91.0	60.0	105	2270	1 / 6	14.5	0.41
689588	2-3/4	93.0	60.0	110	2420	1 / 6	15.5	0.41
689590	2-13/16	95.0	60.0	110	2550	1 / 3	8.5	0.31
689592	2-7/8	97.0	60.0	110	2610	1 / 3	9.0	0.31
689594	2-15/16	99.0	60.0	110	2650	1 / 3	9.0	0.31
689596	3	99.0	60.0	110	2790	1 / 3	9.5	0.31

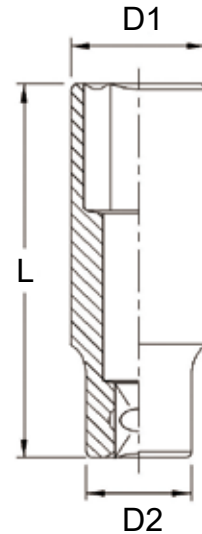
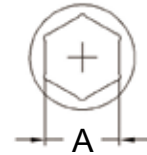

## GS-617AS 3/4" Dr. 17 Piece SAE Hand Socket Set

Item No.	Size	Item No.	Size
<b>3/4" Dr. 6pt Hand Socket:</b>			
685228	7/8"	685246	1-7/16"
685230	15/16"	685248	1-1/2"
685232	1"	685252	1-5/8"
685234	1-1/16"	685256	1-3/4"
685236	1-1/8"	685260	1-7/8"
685240	1-1/4"	685264	2"
685244	1-3/8"		

### Accessory:

620150	Extension Bar, 6"L
620200	Extension Bar, 8"L
680060	Sliding T-Handle
680666R	24T Reversible Ratchet
	Metal Box



12 Kg

1 set / 13 Kgs / 0.46 CUFT



## Metric Hand Sockets (12-Point)

Item No.	A mm	D1 mm	D2 mm	Length mm	Weight g	PCS		G.W. KGS	CUFT 
						inner/ctn			
635217	17	27.0	37.8	51	210	5 / 50	12.0	0.34	
635218	18	28.0	37.8	51	220	5 / 50	12.0	0.34	
635219	19	29.5	37.8	51	230	5 / 50	12.5	0.34	
635220	20	30.7	37.8	51	240	5 / 50	13.0	0.34	
635221	21	32.0	37.8	51	240	5 / 50	13.0	0.34	
635222	22	33.0	39.8	51	260	5 / 50	14.0	0.34	
635223	23	34.5	39.8	51	270	5 / 50	14.5	0.34	
635224	24	35.7	39.8	51	270	5 / 50	15.0	0.34	
635225	25	37.0	39.8	51	300	5 / 50	16.0	0.34	
635226	26	38.0	39.8	54	310	5 / 50	16.5	0.34	
635227	27	39.5	41.8	54	310	5 / 50	16.5	0.41	
635228	28	40.8	38.0	54	310	5 / 50	16.5	0.41	
635229	29	41.8	39.0	54	310	5 / 50	16.5	0.41	
635230	30	42.8	40.0	54	320	5 / 50	17.0	0.41	
635231	31	43.8	41.0	54	340	5 / 50	18.0	0.41	
635232	32	45.8	42.0	57	370	5 / 30	12.0	0.34	
635233	33	46.0	43.0	57	380	5 / 30	12.5	0.34	
635234	34	48.0	43.0	57	400	5 / 30	13.0	0.34	
635235	35	49.5	44.0	57	430	5 / 30	14.0	0.34	
635236	36	50.7	44.0	57	430	5 / 30	14.0	0.34	
635237	37	51.0	44.0	57	450	5 / 30	14.5	0.34	
635238	38	53.0	44.0	57	450	5 / 30	14.5	0.34	
635239	39	54.5	44.0	58	500	5 / 30	16.0	0.34	
635240	40	55.7	44.0	58	510	5 / 30	16.5	0.34	
635241	41	57.0	44.0	58	520	5 / 30	16.5	0.34	
635242	42	58.0	44.0	61	520	1 / 20	11.5	0.39	
635243	43	59.5	44.0	61	570	1 / 20	12.5	0.39	
635244	44	60.7	44.0	63	580	1 / 20	12.5	0.39	
635245	45	61.0	44.0	63	600	1 / 20	13.0	0.39	
635246	46	63.0	44.0	63	610	1 / 20	13.0	0.39	
635247	47	63.5	44.0	63	650	1 / 20	14.0	0.39	
635248	48	65.7	44.0	65	670	1 / 20	14.5	0.39	
635249	49	67.0	44.0	65	680	1 / 20	14.5	0.39	
635250	50	68.0	44.0	68	740	1 / 20	16.0	0.39	
635251	51	69.0	44.0	68	770	1 / 20	16.5	0.39	
635252	52	70.7	54.0	70	940	1 / 20	20.0	0.39	
635253	53	72.0	54.0	70	980	1 / 10	11.0	0.43	
635254	54	73.0	54.0	73	1030	1 / 10	11.5	0.43	
635255	55	74.5	54.0	73	1040	1 / 10	11.5	0.43	
635256	56	75.7	54.0	73	1070	1 / 10	12.0	0.43	
635257	57	77.0	54.0	73	1090	1 / 10	12.0	0.43	
635258	58	78.0	54.0	73	1180	1 / 10	13.0	0.43	
635259	59	79.0	60.0	73	1240	1 / 10	13.5	0.43	
635260	60	80.7	60.0	80	1370	1 / 10	15.0	0.43	
635261	61	82.0	60.0	80	1380	1 / 10	15.0	0.43	
635262	62	83.0	60.0	80	1390	1 / 10	15.0	0.43	
635263	63	84.0	60.0	80	1400	1 / 10	15.0	0.43	
635264	64	85.7	60.0	80	1540	1 / 10	16.5	0.43	
635265	65	87.0	60.0	85	1550	1 / 10	16.5	0.43	
635266	66	88.0	60.0	85	1550	1 / 6	10.5	0.41	
635267	67	89.0	60.0	85	1620	1 / 6	11.0	0.41	
635268	68	90.7	60.0	85	1680	1 / 6	11.0	0.41	
635269	69	92.0	60.0	85	1740	1 / 6	11.5	0.41	
635270	70	93.0	60.0	90	1790	1 / 6	12.0	0.41	

12 pt.

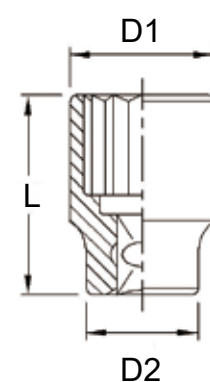

## E-Star Hand Sockets

Item No.	A Size	D1 mm	D2 mm	Length mm	Weight g	PCS		G.W. KGS	CUFT 
						inner/ctn			
655018	E-18	23	44	50	300	5 / 50	16.0	0.41	
655020	E-20	25	44	50	305	5 / 50	16.0	0.41	
655022	E-22	27	44	50	310	5 / 50	16.5	0.41	
655024	E-24	29	44	50	315	5 / 50	17.0	0.41	
655026	E-26	31	44	55	335	5 / 50	18.0	0.41	
655028	E-28	33	44	60	365	5 / 30	12.0	0.38	
655030	E-30	35	44	60	370	5 / 30	12.0	0.38	
655032	E-32	38	44	60	395	5 / 30	13.0	0.38	

E-Star

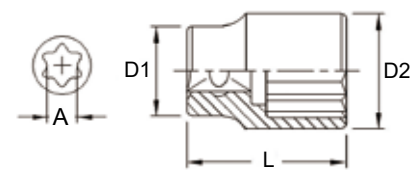

Deep E-Star Hand Sockets are also available

Made of Chrome Molybdenum Steel

## SAE Hand Sockets (12-Point)

Item No.	A inch	D1 mm	D2 mm	Length mm	Weight g	PCS inner/ctn	G.W. KGS	CUFT
675222	11/16	27.6	37.8	51	220	5 / 50	12.0	0.34
675224	3/4	29.6	37.8	51	230	5 / 50	12.5	0.34
675225	25/32	30.5	37.8	51	240	5 / 50	13.0	0.34
675226	13/16	31.5	37.8	51	240	5 / 50	13.0	0.34
675228	7/8	33.0	39.8	51	260	5 / 50	14.0	0.34
675230	15/16	35.5	39.8	51	270	5 / 50	15.0	0.34
675232	1	37.5	39.8	54	300	5 / 50	16.0	0.34
675234	1-1/16	39.5	41.8	54	310	5 / 50	16.5	0.41
675236	1-1/8	41.8	39.0	54	310	5 / 50	16.5	0.41
675238	1-3/16	42.8	40.0	54	320	5 / 50	17.0	0.41
675240	1-1/4	45.8	42.0	57	370	5 / 30	12.0	0.34
675242	1-5/16	46.0	43.0	57	380	5 / 30	12.5	0.34
675244	1-3/8	50.0	44.0	57	430	5 / 30	14.0	0.34
675246	1-7/16	51.0	44.0	57	440	5 / 30	14.0	0.34
675248	1-1/2	53.0	44.0	57	450	5 / 30	14.5	0.34
675250	1-9/16	55.4	44.0	58	510	5 / 30	16.5	0.34
675252	1-5/8	57.0	44.0	58	520	5 / 30	16.5	0.34
675254	1-11/16	59.3	44.0	61	570	1 / 20	12.5	0.39
675256	1-3/4	61.0	44.0	63	600	1 / 20	13.0	0.39
675258	1-13/16	63.0	44.0	63	610	1 / 20	13.0	0.39
675260	1-7/8	65.3	44.0	65	670	1 / 20	14.5	0.39
675262	1-15/16	67.0	44.0	65	680	1 / 20	14.5	0.39
675264	2	69.0	44.0	68	770	1 / 20	16.5	0.39
675266	2-1/16	71.0	54.0	70	940	1 / 20	20.0	0.39
675268	2-1/8	73.0	54.0	73	1030	1 / 10	11.5	0.43
675270	2-3/16	75.0	54.0	73	1040	1 / 10	11.5	0.43
675272	2-1/4	77.0	54.0	73	1090	1 / 10	12.0	0.43
675274	2-5/16	79.0	60.0	73	1240	1 / 10	13.5	0.43
675276	2-3/8	81.0	60.0	80	1370	1 / 10	15.0	0.43
675278	2-7/16	83.0	60.0	80	1390	1 / 10	15.0	0.43
675280	2-1/2	84.0	60.0	80	1400	1 / 10	15.0	0.43
675282	2-9/16	87.0	60.0	85	1550	1 / 10	16.5	0.43
675284	2-5/8	89.0	60.0	85	1550	1 / 6	10.5	0.41
675286	2-11/16	91.0	60.0	85	1680	1 / 6	11.0	0.41
675288	2-3/4	93.0	60.0	90	1790	1 / 6	12.0	0.41



12 pt.

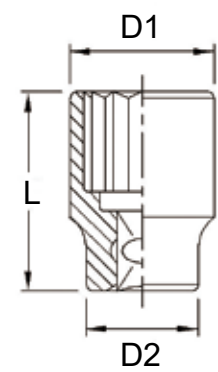
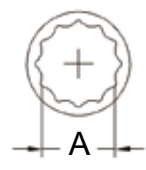

## Extension Bars

Item No.	Length mm	Weight g	PCS inner/ctn	G.W. KGS	CUFT
620100	100	440	1 / 30	14.0	0.52
620150	150	600	1 / 20	13.0	0.52
620200	200	740	1 / 20	15.8	0.62
620250	250	890	2 / 20	19.0	0.62
620400	400	1340	1 / 15	21.5	0.43



## Adapters

Item No.	Female Drive	Male Drive	Length mm	Weight g	PCS inner/ctn	G.W. KGS	CUFT
620604	3/4"	1/2"	63	270	5 / 50	15.0	0.34
620608	3/4"	1"	65	380	1 / 30	12.5	0.38



## Universal Joint

Item No.	Outside Diameter	Length mm	Weight g	PCS inner/ctn	G.W. KGS	CUFT
680606	44mm	110	620	1 / 12	8.5	0.30



## L-Handles

Item No.	Length inch (mm)	Weight g	PCS inner/ctn	G.W. KGS	CUFT
620330L	14" (355)	1480	1 / 12	19.0	0.55
620400L	16" (400)	1600	1 / 12	20.5	0.69



## 24 Teeth Ratchet Head

Item No.	Length mm	Weight g	PCS inner/ctn	G.W. KGS	CUFT
680666	260	1790	1 / 12	22.5	0.77



## 24 Teeth Ratchet Head with Tube Handle

Item No.	Length mm	Weight g	PCS inner/ctn	G.W. KGS	CUFT	Head No.	Handle No.
680666RA	510	2680	1 / 8	23.0	0.88	680666	680350



## 24 Teeth Ratchet with Metal Handle

Item No.	Length mm	Weight g	PCS inner/ctn	G.W. KGS	CUFT
680666R	500	1900	1 / 12	25.0	1.16



## 36 Teeth Ratchet with Plastic Handle

Item No.	Length mm	Weight g	PCS inner/ctn	G.W. KGS	CUFT
680610S	610	2670	1 / 6	17.0	0.60



## Hinge Handle

Item No.	Length mm	Weight g	PCS inner/ctn	G.W. KGS	CUFT
680446A	620	1620	1 / 10	17.0	0.45



## Hinge Head

Item No.	Length mm	Weight g	PCS inner/ctn	G.W. KGS	CUFT
680446	320	1460	1 / 12	18.5	0.70



## Hinge Head with Tube Handle

Item No.	Length mm	Weight g	PCS inner/ctn	G.W. KGS	CUFT	Head No.	Handle No.
680446E	560	2420	1 / 10	25.5	0.45	680446	680350
680446E58	790	4000	1 / 6	25.0	1.39	680446	680580
680446E85	1060	4600	1 / 5	24.0	1.66	680446	680850



## 48 Teeth Ratchet Head

Item No.	Length mm	Weight g	PCS inner/ctn	G.W. KGS	CUFT
680672	290	1970	1 / 12	25.0	0.77



## 48 Teeth Ratchet Head with Tube Handle

Item No.	Length mm	Weight g	PCS inner/ctn	G.W. KGS	CUFT	Head No.	Handle No.
680672E	530	2930	1 / 12	31.0	1.16	680672	680350
680672E58	760	3650	1 / 6	23.0	1.39	680672	680580
680672E85	1030	4420	1 / 6	27.5	1.66	680672	680850



## Tube Handles

Item No.	Length mm	Weight g	PCS inner/ctn	G.W. KGS	CUFT
680350	350	960	1 / 15	15.5	0.31
680580	580	1610	1 / 10	17.0	0.30
680850	850	2340	1 / 10	24.5	0.44



## Sliding T-Handle

Item No.	Length mm	Weight g	PCS inner/ctn	G.W. KGS	CUFT
680060	500	1650	1 / 12	21.0	1.16





# Hand Socket Sets

## GS-615M 15 Piece 3/4" Dr. Metric Hand Socket Set

Item No.	Size	Item No.	Size
<b>3/4" Dr. 6pt Hand Socket:</b>			
625227	27mm	625241	41mm
625230	30mm	625246	46mm
625232	32mm	625250	50mm
625233	33mm	625255	55mm
625235	35mm	625260	60mm
625236	36mm	625263	63mm
625238	38mm		

### 3/4" Dr. Accessory:

620150	Extension Bar, 150mmL
680060	Sliding T-Handle
	Metal Box

12 Kg

1 set / 13 Kgs / 0.46 CUFT



6 pt.

## GS-615S 15 Piece 3/4" Dr. SAE Hand Socket Set

Item No.	Size	Item No.	Size
<b>3/4" Dr. 6pt Hand Socket:</b>			
685232	1"	685260	1-7/8"
685236	1-1/8"	685264	2"
685240	1-1/4"	685268	2-1/8"
685244	1-3/8"	685272	2-1/4"
685248	1-1/2"	685276	2-3/8"
685252	1-5/8"	685280	2-1/2"
685256	1-3/4"		

### 3/4" Dr. Accessory:

620150	Extension Bar, 6"L
680060	Sliding T-Handle
	Metal Box

12 Kg

1 set / 13 Kgs / 0.46 CUFT



6 pt.

## GS-627M 27 Piece 3/4" Dr. Metric Hand Socket Set

Item No.	Size	Item No.	Size
<b>3/4" Dr. 6pt Hand Socket:</b>			
625217	17mm	625236	36mm
625219	19mm	625237	37mm
625220	20mm	625238	38mm
625221	21mm	625240	40mm
625222	22mm	625241	41mm
625223	23mm	625245	45mm
625224	24mm	625246	46mm
625227	27mm	625248	48mm
625230	30mm	625250	50mm
625231	31mm	625254	54mm
625232	32mm	625255	55mm
625233	33mm	625257	57mm
625234	34mm	625260	60mm
625235	35mm		Blow Case

16.5 Kg

1 set / 18 Kgs / 0.91 CUFT



6 pt.

## GS-617M 17 Piece 3/4" Dr. Metric Hand Socket Set

Item No.	Size	Item No.	Size
<b>3/4" Dr. 6pt Hand Socket:</b>			
625221	21mm	625235	35mm
625222	22mm	625236	36mm
625223	23mm	625238	38mm
625224	24mm	625241	41mm
625227	27mm	625246	46mm
625230	30mm	625250	50mm
625232	32mm		
<b>3/4" Dr. Accessory:</b>			
620150	Extension Bar, 150mmL		
620200	Extension Bar, 200mmL		
680060	Sliding T-Handle		
680666R	24T Reversible Ratchet		
Metal Box			

12 Kg 1 set / 13 Kgs / 0.46 CUFT



6 pt.

## GS-617S 17 Piece 3/4" Dr. SAE Hand Socket Set

Item No.	Size	Item No.	Size
<b>3/4" Dr. 6pt Hand Socket:</b>			
685226	13/16"	685244	1-3/8"
685228	7/8"	685246	1-7/16"
685230	15/16"	685248	1-1/2"
685232	1"	685252	1-5/8"
685234	1-1/16"	685256	1-3/4"
685236	1-1/8"	685260	1-7/8"
685240	1-1/4"		
<b>3/4" Dr. Accessory:</b>			
620150	Extension Bar, 6"L		
620200	Extension Bar, 8"L		
680060	Sliding T-Handle		
680666R	24T Reversible Ratchet		
Metal Box			

12 Kg 1 set / 13 Kgs / 0.46 CUFT



6 pt.

## GS-627S 27 Piece 3/4" Dr. SAE Hand Socket Set

Item No.	Size	Item No.	Size
<b>3/4" Dr. 6pt Hand Socket:</b>			
685224	3/4"	685250	1-9/16"
685225	25/32"	685252	1-5/8"
685226	13/16"	685254	1-11/16"
685228	7/8"	685256	1-3/4"
685230	15/16"	685258	1-13/16"
685232	1"	685260	1-7/8"
685234	1-1/16"	685262	1-15/16"
685236	1-1/8"	685264	2"
685238	1-3/16"	685266	2-1/16"
685240	1-1/4"	685268	2-1/8"
685242	1-5/16"	685270	2-3/16"
685244	1-3/8"	685272	2-1/4"
685246	1-7/16"	685276	2-3/8"
685248	1-1/2"	Blow Case	

18 Kg 1 set / 19 Kgs / 0.91 CUFT



6 pt.





# Hand Socket Sets

## EU-615M 15 Piece 3/4" Dr. Metric Hand Socket Set

Item No.	Size	Item No.	Size
<b>3/4" Dr. 6pt Hand Socket:</b>			
625222	22mm	625234	34mm
625224	24mm	625236	36mm
625227	27mm	625241	41mm
625230	30mm	625246	46mm
625232	32mm	625250	50mm
625233	33mm		

### 3/4" Dr. Accessory:

620200	Extension Bar, 200mmL
620400	Extension Bar, 400mmL
680060	Sliding T-Handle
680610S	36T Reversible Ratchet
	Blow Case

13 Kg

1 set / 14 Kgs / 0.91 CUFT



6 pt.



## TW-625M 25 Piece 3/4" Dr. Metric Hand Socket Set (12-Point)

Item No.	Size	Item No.	Size
<b>3/4" Dr. 12pt Hand Socket:</b>			
635219	19mm	635233	33mm
635221	21mm	635234	34mm
635222	22mm	635235	35mm
635223	23mm	635236	36mm
635224	24mm	635238	38mm
635227	27mm	635241	41mm
635228	28mm	635246	46mm
635229	29mm	635250	50mm
635230	30mm	635255	55mm
635232	32mm		

### 3/4" Dr. Accessory:

680060	Sliding T-Handle	620100	Extension Bar, 100mmL
680446	Hinge Head	620200	Extension Bar, 200mmL
680666	Ratchet Head	680350	Extension Tube, 350mmL

Blow Case

17.5 Kg

1 set / 18.5 Kgs / 1.14 CUFT



12 pt.



## TW-625S 25 Piece 3/4" Dr. SAE Hand Socket Set (12-Point)

Item No.	Size	Item No.	Size
<b>3/4" Dr. 12pt Hand Socket:</b>			
675224	3/4"	675246	1-7/16"
675226	13/16"	675248	1-1/2"
675228	7/8"	675252	1-5/8"
675230	15/16"	675256	1-3/4"
675232	1"	675260	1-7/8"
675234	1-1/16"	675264	2"
675236	1-1/8"	675268	2-1/8"
675240	1-1/4"	675270	2-3/16"
675242	1-5/16"	675272	2-1/4"
675244	1-3/8"		

### 3/4" Dr. Accessory:

680060	Sliding T-Handle	620100	Extension Bar, 4"L
680446	Hinge Head	620200	Extension Bar, 8"L
680666	Ratchet Head	680350	Extension Tube, 14"L

Blow Case

19 Kg

1 set / 20 Kgs / 1.14 CUFT



12 pt.





Made of Chrome Molybdenum Steel



## TW-626MS 26 Piece 3/4" Dr. Metric & SAE Hand Socket Set (6 & 12-Point)

Item No.	Size	Item No.	Size
<b>3/4" Dr. 12pt Hand Socket:</b>			
635222	22mm	635236	36mm
635224	24mm	635238	38mm
635227	27mm	635241	41mm
635230	30mm	635246	46mm
635232	32mm	635250	50mm
<b>3/4" Dr. 6pt Hand Socket:</b>			
685228	7/8"	685244	1-3/8"
685230	15/16"	685246	1-7/16"
685232	1"	685252	1-5/8"
685236	1-1/8"	685256	1-3/4"
685238	1-3/16"	685260	1-7/8"
685242	1-5/16"	685264	2"
<b>3/4" Dr. Accessory:</b>			
620100	Extension Bar, 100mmL		
620200	Extension Bar, 200mmL		
680446A	Hinge Handle		
680060	Sliding T-Handle		
Blow Case / Metal Box			

 22 Kg     
  B 1 set / 23 Kgs / 1.14 CUFT  
 M 1 set / 23 Kgs / 1.04 CUFT





Metal Case is also available

6 pt.  
12 pt.

## TW-628MS 28 Piece 3/4" Dr. Metric & SAE Hand Socket Set (6 & 12-Point)

Item No.	Size	Item No.	Size
<b>3/4" Dr. 12pt Hand Socket:</b>			
635222	22mm	635236	36mm
635224	24mm	635238	38mm
635227	27mm	635241	41mm
635230	30mm	635246	46mm
635232	32mm	635250	50mm
<b>3/4" Dr. 6pt Hand Socket:</b>			
685228	7/8"	685244	1-3/8"
685230	15/16"	685246	1-7/16"
685232	1"	685252	1-5/8"
685236	1-1/8"	685256	1-3/4"
685238	1-3/16"	685260	1-7/8"
685242	1-5/16"	685264	2"
<b>3/4" Dr. Accessory:</b>			
620100	Extension Bar, 100mmL		
620200	Extension Bar, 200mmL		
680446	Hinge Head		
680060	Sliding T-Handle		
680350	Extension Tube, 350mmL		
680666	24T Ratchet Head		
Blow Case			

 19 Kg     
  1 set / 20 Kgs / 1.14 CUFT



6 pt.  
12 pt.



## Metric Hand Sockets

Item No.	A mm	D1 mm	D2 mm	Length mm	Weight g	PCS	G.W. KGS	CUFT
						inner/ctn		
827017	17	29.0	50	60	450	1 / 30	14.5	0.38
827018	18	30.3	50	60	460	1 / 30	15.0	0.38
827019	19	31.6	50	60	470	1 / 30	15.0	0.38
827020	20	32.9	50	60	470	1 / 30	15.0	0.38
827021	21	34.1	50	60	490	1 / 30	16.0	0.38
827022	22	35.4	50	60	490	1 / 30	16.0	0.38
827023	23	36.6	50	60	490	1 / 30	16.0	0.38
827024	24	37.9	50	60	500	1 / 30	16.0	0.38
827025	25	39.2	50	60	500	1 / 30	16.0	0.38
827026	26	40.4	50	60	500	1 / 30	16.0	0.38
827027	27	41.7	50	60	510	1 / 30	16.5	0.38
827028	28	42.9	50	60	510	1 / 30	16.5	0.38
827029	29	44.2	50	60	520	1 / 30	16.5	0.38
827030	30	45.4	50	62	540	1 / 30	17.0	0.38
827031	31	46.7	50	62	540	1 / 30	17.0	0.38
827032	32	48.0	52	63	600	1 / 30	19.0	0.38
827033	33	49.2	53	63	630	1 / 30	20.0	0.38
827034	34	50.4	54	63	660	1 / 30	21.0	0.38
827035	35	51.7	54	63	660	1 / 30	21.0	0.38
827036	36	52.9	50	67	660	1 / 30	21.0	0.38
827037	37	54.2	50	67	670	1 / 30	21.0	0.38
827038	38	55.4	52	67	670	1 / 30	21.0	0.38
827039	39	56.7	52	67	670	1 / 30	21.0	0.38
827040	40	57.9	54	67	730	1 / 20	15.5	0.39
827041	41	59.1	54	70	790	1 / 20	17.0	0.39
827042	42	60.4	54	70	790	1 / 20	17.0	0.39
827043	43	61.6	54	70	800	1 / 20	17.0	0.39
827044	44	62.9	54	70	830	1 / 20	17.5	0.39
827045	45	64.1	54	70	850	1 / 20	18.0	0.39
827046	46	65.4	54	70	900	1 / 20	19.0	0.39
827047	47	66.7	54	70	900	1 / 20	19.0	0.39
827048	48	67.9	54	70	920	1 / 20	19.5	0.39
827049	49	69.2	54	70	980	1 / 20	20.0	0.39
827050	50	70.4	54	70	1000	1 / 20	21.0	0.39
827051	51	71.7	54	70	1000	1 / 10	11.0	0.43
827052	52	72.9	54	82	1200	1 / 10	13.0	0.43
827053	53	74.2	54	82	1200	1 / 10	13.0	0.43
827054	54	75.4	54	82	1250	1 / 10	13.5	0.43
827055	55	76.7	55	87	1400	1 / 10	15.0	0.43
827056	56	78.0	55	87	1400	1 / 10	15.0	0.43
827057	57	79.2	57	87	1450	1 / 10	15.5	0.43
827058	58	80.4	57	87	1500	1 / 10	16.0	0.43
827059	59	81.7	57	87	1580	1 / 10	17.0	0.43
827060	60	82.9	60	91	1700	1 / 6	11.0	0.41
827061	61	84.1	60	91	1700	1 / 6	11.0	0.41
827062	62	85.4	60	91	1700	1 / 6	11.0	0.41
827063	63	86.7	60	91	1740	1 / 6	11.5	0.41
827064	64	88.0	60	91	1740	1 / 6	11.5	0.41
827065	65	89.2	65	95	2070	1 / 6	13.5	0.41
827066	66	90.4	65	95	2070	1 / 6	13.5	0.41
827067	67	91.7	65	95	2080	1 / 6	13.5	0.41
827068	68	92.9	65	95	2280	1 / 6	14.5	0.41
827069	69	94.1	65	95	2340	1 / 6	15.0	0.41
827070	70	95.4	70	100	2450	1 / 6	16.0	0.41
827071	71	96.6	70	100	2550	1 / 6	16.5	0.41
827072	72	97.8	70	100	2600	1 / 6	16.5	0.41
827073	73	99.1	70	100	2680	1 / 6	17.0	0.41
827074	74	100.3	70	100	2740	1 / 6	17.5	0.41
827075	75	101.6	70	105	2800	1 / 6	18.0	0.41

6 pt.

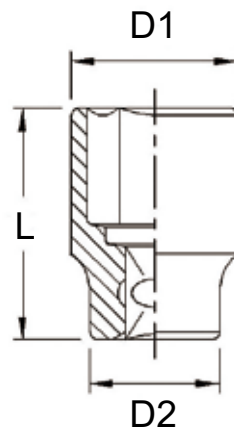
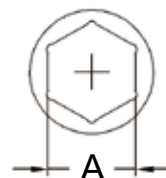

• Size more than 76mm on the next page.

## Metric Hand Sockets

Item No.	A mm	D1 mm	D2 mm	Length mm	Weight g	PCS inner/ctn	G.W. KGS	CUFT
827076	76	103.0	70	105	2800	1 / 6	18.0	0.41
827077	77	104.4	70	105	2900	1 / 6	18.5	0.41
827078	78	105.8	70	105	3000	1 / 6	19.0	0.41
827079	79	107.2	70	105	3440	1 / 6	21.5	0.41
827080	80	107.9	80	105	3450	1 / 6	22.0	0.41
827082	82	109.3	80	105	3550	1 / 3	12.0	0.31
827083	83	110.0	80	105	3650	1 / 3	12.0	0.31
827085	85	114.1	86	110	3820	1 / 3	12.5	0.31
827090	90	120.4	86	110	4120	1 / 3	13.5	0.31
827095	95	128.0	86	120	5100	1 / 3	16.0	0.31
827100	100	134.0	86	120	5500	1 / 2	12.0	0.31
827105	105	139.0	95	120	6200	1 / 2	13.5	0.31
827110	110	144.0	95	120	6500	1 / 2	14.0	0.31
827115	115	149.5	95	120	7000	1 / 2	15.0	0.31

6 pt.



## GS-816M 16 Piece 1" Dr. Metric Hand Socket Set (6 & 12-Point)

Item No.	Size	Item No.	Size
<b>1" Dr. 12pt Hand Socket:</b>			
837036	36mm	837046	46mm
837038	38mm	837050	50mm
837041	41mm	837055	55mm
837043	43mm		
<b>1" Dr. 6-Point Metric Hand Socket:</b>			
827060	60mm	827075	75mm
827065	65mm	827080	80mm
827070	70mm		
<b>1" Dr. Accessory:</b>			
820200	Extension Bar, 200mmL		
820400	Extension Bar, 400mmL		
880063	Sliding T-Handle		
880888R	24T Reversible Ratchet		
	Metal Box		

36 Kg 1 set / 37 Kgs / 0.82 CUFT



6 pt.

12 pt.

## GS-816S 16 Piece 1" Dr. SAE Hand Socket Set (6 & 12-Point)

Item No.	Size	Item No.	Size
<b>1" Dr. 12pt Hand Socket:</b>			
877046	1-7/16"	877060	1-7/8"
877048	1-1/2"	877064	2"
877054	1-11/16"	877072	2-1/4"
<b>1" Dr. 6-Point Metric Hand Socket:</b>			
887076	2-3/8"	887088	2-3/4"
887080	2-1/2"	887094	2-15/16"
887084	2-5/8"	887100	3-1/8"
<b>1" Dr. Accessory:</b>			
820200	Extension Bar, 8"L		
820400	Extension Bar, 16"L		
880063	Sliding T-Handle		
880888R	24T Reversible Ratchet		
	Metal Box		

37 Kg 1 set / 38 Kgs / 0.82 CUFT



6 pt.

12 pt.



# Hand Sockets

## SAE Hand Sockets

Item No.	A inch	D1 mm	D2 mm	Length mm	Weight g	PCS		G.W. KGS	CUFT 
						inner/ctn			
887024	3/4	31.6	50	60	470	1 / 30	15.0	0.38	
887025	25/32	32.9	50	60	470	1 / 30	15.0	0.38	
887026	13/16	33.7	50	60	490	1 / 30	16.0	0.38	
887028	7/8	35.4	50	60	490	1 / 30	16.0	0.38	
887030	15/16	37.9	50	60	500	1 / 30	16.0	0.38	
887032	1	39.6	50	60	500	1 / 30	16.0	0.38	
887034	1-1/16	41.7	50	60	510	1 / 30	16.5	0.38	
887036	1-1/8	43.7	50	60	520	1 / 30	16.5	0.38	
887038	1-3/16	45.4	50	62	540	1 / 30	17.0	0.38	
887040	1-1/4	48.0	52	63	600	1 / 30	19.0	0.38	
887042	1-5/16	49.2	53	63	630	1 / 30	20.0	0.38	
887044	1-3/8	51.7	54	63	660	1 / 30	21.0	0.38	
887046	1-7/16	53.4	50	67	670	1 / 30	21.0	0.38	
887048	1-1/2	55.4	52	67	670	1 / 30	21.0	0.38	
887050	1-9/16	57.9	54	67	730	1 / 20	15.5	0.39	
887052	1-5/8	59.1	54	70	790	1 / 20	17.0	0.39	
887054	1-11/16	61.6	54	70	800	1 / 20	17.0	0.39	
887056	1-3/4	63.8	54	70	850	1 / 20	18.0	0.39	
887058	1-13/16	65.4	54	70	900	1 / 20	19.0	0.39	
887060	1-7/8	67.9	54	70	920	1 / 20	19.5	0.39	
887062	1-15/16	69.1	54	70	980	1 / 10	11.0	0.31	
887064	2	71.2	54	70	1000	1 / 10	11.0	0.43	
887066	2-1/16	72.9	54	82	1180	1 / 10	13.0	0.43	
887068	2-1/8	75.4	54	82	1250	1 / 10	13.5	0.43	
887070	2-3/16	76.7	55	87	1350	1 / 10	14.5	0.43	
887072	2-1/4	79.2	57	87	1450	1 / 10	15.5	0.43	
887074	2-5/16	81.7	57	87	1660	1 / 10	17.5	0.43	
887076	2-3/8	82.9	60	91	1700	1 / 6	11.0	0.41	
887078	2-7/16	85.4	60	91	1700	1 / 6	11.0	0.41	
887080	2-1/2	86.7	60	91	1740	1 / 6	11.5	0.41	
887082	2-9/16	89.2	65	95	2070	1 / 6	13.5	0.41	
887084	2-5/8	91.2	65	95	2080	1 / 6	13.5	0.41	
887086	2-11/16	92.9	65	95	2280	1 / 6	14.5	0.41	
887088	2-3/4	95.4	70	100	2450	1 / 6	16.0	0.41	
887090	2-13/16	96.8	70	100	2550	1 / 6	16.5	0.41	
887092	2-7/8	99.1	70	100	2680	1 / 6	17.0	0.41	
887094	2-15/16	101.6	70	105	2800	1 / 6	18.0	0.41	
887096	3	103.0	70	105	2800	1 / 6	18.0	0.41	
887098	3-1/16	105.8	70	105	3000	1 / 6	19.0	0.41	
887100	3-1/8	107.8	80	105	3440	1 / 3	11.5	0.31	
887102	3-3/16	109.3	80	105	3450	1 / 3	11.5	0.31	
887104	3-1/4	110.0	80	105	3650	1 / 3	12.0	0.31	
887106	3-5/16	112.0	80	105	3730	1 / 3	12.0	0.31	
887108	3-3/8	114.0	86	110	3820	1 / 3	12.5	0.31	
887110	3-7/16	116.0	86	110	4000	1 / 3	13.0	0.31	
887112	3-1/2	118.0	86	110	4120	1 / 3	13.5	0.31	
887114	3-9/16	120.0	86	110	4120	1 / 3	13.5	0.31	
887116	3-5/8	124.0	86	110	4300	1 / 3	13.5	0.31	
887118	3-11/16	126.0	86	110	4700	1 / 3	15.0	0.31	
887120	3-3/4	128.0	86	120	5100	1 / 3	16.0	0.31	
887122	3-13/16	129.0	86	120	5300	1 / 3	17.0	0.31	
887124	3-7/8	131.9	86	120	5400	1 / 3	17.0	0.31	
887126	3-15/16	133.9	86	120	5500	1 / 2	12.0	0.31	
887128	4	135.9	86	120	5600	1 / 2	12.0	0.31	
887130	4-1/16	137.9	86	120	5800	1 / 2	12.5	0.31	
887132	4-1/8	139.0	95	120	6200	1 / 2	13.5	0.31	
887134	4-3/16	141.0	95	120	6300	1 / 2	13.5	0.31	
887136	4-1/4	143.0	95	120	6400	1 / 2	14.0	0.31	
887138	4-5/16	144.0	95	120	6500	1 / 2	14.0	0.31	
887140	4-3/8	146.0	95	120	6700	1 / 2	14.5	0.31	
887142	4-7/16	148.0	95	120	6800	1 / 2	14.5	0.31	
887144	4-1/2	149.5	95	120	7000	1 / 2	15.0	0.31	

6 pt.

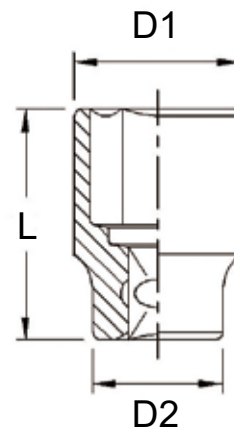
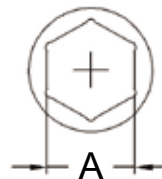

## Metric Hand Sockets (12-Point)

Item No.	A mm	D1 mm	D2 mm	Length mm	Weight g	PCS	G.W. KGS	CUFT 
						inner/ctn		
837017	17	29.0	50	60	440	1 / 30	14.5	0.38
837018	18	30.3	50	60	450	1 / 30	14.5	0.38
837019	19	31.6	50	60	460	1 / 30	15.0	0.38
837020	20	32.9	50	60	460	1 / 30	15.0	0.38
837021	21	34.1	50	60	480	1 / 30	15.5	0.38
837022	22	35.4	50	60	480	1 / 30	15.5	0.38
837023	23	36.6	50	60	480	1 / 30	15.5	0.38
837024	24	37.9	50	60	480	1 / 30	15.5	0.38
837025	25	39.2	50	60	480	1 / 30	15.5	0.38
837026	26	40.4	50	60	490	1 / 30	16.0	0.38
837027	27	41.7	50	60	490	1 / 30	16.0	0.38
837028	28	42.9	50	60	500	1 / 30	16.0	0.38
837029	29	44.2	50	60	510	1 / 30	16.5	0.38
837030	30	45.4	50	62	530	1 / 30	17.0	0.38
837031	31	46.7	50	62	530	1 / 30	17.0	0.38
837032	32	48.0	52	63	580	1 / 30	18.5	0.38
837033	33	49.2	53	63	620	1 / 30	19.5	0.38
837034	34	50.4	54	63	620	1 / 30	19.5	0.38
837035	35	51.7	54	63	630	1 / 30	20.0	0.38
837036	36	52.9	50	67	630	1 / 30	20.0	0.38
837037	37	54.2	50	67	630	1 / 30	20.0	0.38
837038	38	55.4	52	67	650	1 / 30	20.5	0.38
837039	39	56.7	52	67	650	1 / 30	20.5	0.38
837040	40	57.9	54	67	700	1 / 20	15.0	0.39
837041	41	59.1	54	70	750	1 / 20	16.0	0.39
837042	42	60.4	54	70	750	1 / 20	16.0	0.39
837043	43	61.6	54	70	780	1 / 20	16.5	0.39
837044	44	62.9	54	70	800	1 / 20	17.0	0.39
837045	45	64.1	54	70	830	1 / 20	17.5	0.39
837046	46	65.4	54	70	860	1 / 20	18.5	0.39
837047	47	66.7	54	70	860	1 / 20	18.5	0.39
837048	48	67.9	54	70	870	1 / 20	18.5	0.39
837049	49	69.2	54	70	920	1 / 20	19.5	0.39
837050	50	70.4	54	70	970	1 / 20	20.5	0.39
837051	51	71.7	54	70	970	1 / 10	11.0	0.43
837052	52	72.9	54	82	1140	1 / 10	12.5	0.43
837053	53	74.2	54	82	1200	1 / 10	13.0	0.43
837054	54	75.4	54	82	1230	1 / 10	13.5	0.43
837055	55	76.7	55	87	1300	1 / 10	14.0	0.43
837056	56	78.0	55	87	1320	1 / 10	14.0	0.43
837057	57	79.2	57	87	1440	1 / 10	15.5	0.43
837058	58	80.4	57	87	1440	1 / 10	15.5	0.43
837059	59	81.7	57	87	1510	1 / 10	16.0	0.43
837060	60	82.9	60	91	1620	1 / 6	11.0	0.41
837061	61	84.1	60	91	1650	1 / 6	11.0	0.41
837062	62	85.4	60	91	1680	1 / 6	11.0	0.41
837063	63	86.7	60	91	1720	1 / 6	11.5	0.41
837064	64	88.0	60	91	1830	1 / 6	12.0	0.41
837065	65	89.2	65	95	2000	1 / 6	13.0	0.41
837066	66	90.4	65	95	2000	1 / 6	13.0	0.41
837067	67	91.7	65	95	2000	1 / 6	13.0	0.41
837068	68	92.9	65	95	2230	1 / 6	14.0	0.41
837069	69	94.1	65	95	2280	1 / 6	14.0	0.41
837070	70	95.4	70	100	2350	1 / 6	15.0	0.41
837071	71	96.6	70	100	2450	1 / 6	16.0	0.41
837072	72	97.8	70	100	2500	1 / 6	16.0	0.41
837073	73	99.1	70	100	2580	1 / 6	16.5	0.41
837074	74	100.3	70	100	2610	1 / 6	16.5	0.41
837075	75	101.6	70	105	2720	1 / 6	17.5	0.41
837076	76	103.0	70	105	2720	1 / 6	17.5	0.41
837077	77	104.4	70	105	2800	1 / 6	18.0	0.41
837078	78	105.8	70	105	2840	1 / 6	18.0	0.41
837079	79	107.2	70	105	3200	1 / 6	20.0	0.41
837080	80	107.9	80	105	3200	1 / 6	20.0	0.41
837082	82	109.3	80	105	3350	1 / 3	11.0	0.31
837083	83	110.0	80	105	3510	1 / 3	11.5	0.31
837085	85	114.1	86	110	3600	1 / 3	12.0	0.31
837090	90	120.4	86	110	3800	1 / 3	12.5	0.31
837095	95	128.0	86	120	4700	1 / 3	15.0	0.31

12 pt.

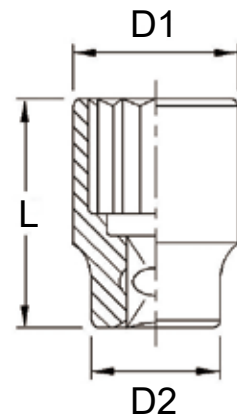
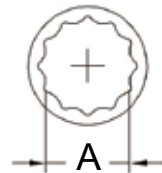



# Hand Sockets

## SAE Hand Sockets (12-Point)

Item No.	A	D1	D2	Length mm	Weight g	PCS	G.W. KGS	CUFT 
	inch	mm	mm			inner/ctn		
877024	3/4	31.6	50	60	460	1 / 30	15.0	0.38
877025	25/32	32.9	50	60	460	1 / 30	15.0	0.38
877026	13/16	33.7	50	60	480	1 / 30	15.5	0.38
877028	7/8	35.4	50	60	480	1 / 30	15.5	0.38
877030	15/16	37.9	50	60	480	1 / 30	15.5	0.38
877032	1	39.6	50	60	490	1 / 30	16.0	0.38
877034	1-1/16	41.7	50	60	490	1 / 30	16.0	0.38
877036	1-1/8	43.7	50	60	510	1 / 30	16.5	0.38
877038	1-3/16	45.4	50	62	530	1 / 30	17.0	0.38
877040	1-1/4	48.0	52	63	580	1 / 30	18.5	0.38
877042	1-5/16	49.2	53	63	620	1 / 30	19.5	0.38
877044	1-3/8	51.7	54	63	630	1 / 30	20.0	0.38
877046	1-7/16	53.4	50	67	630	1 / 30	20.0	0.38
877048	1-1/2	55.4	52	67	650	1 / 30	20.5	0.38
877050	1-9/16	57.9	54	67	700	1 / 20	15.0	0.39
877052	1-5/8	59.1	54	70	750	1 / 20	16.0	0.39
877054	1-11/16	61.6	54	70	780	1 / 20	16.5	0.39
877056	1-3/4	63.8	54	70	830	1 / 20	17.5	0.39
877058	1-13/16	65.4	54	70	860	1 / 20	18.5	0.39
877060	1-7/8	67.9	54	70	870	1 / 20	18.5	0.39
877062	1-15/16	69.1	54	70	920	1 / 10	10.0	0.31
877064	2	71.2	54	70	970	1 / 10	11.0	0.43
877066	2-1/16	72.9	54	82	1140	1 / 10	12.5	0.43
877068	2-1/8	75.4	54	82	1230	1 / 10	13.5	0.43
877070	2-3/16	76.7	55	87	1300	1 / 10	14.0	0.43
877072	2-1/4	79.2	57	87	1440	1 / 10	15.5	0.43
877074	2-5/16	81.7	57	87	1510	1 / 10	16.0	0.43
877076	2-3/8	82.9	60	91	1620	1 / 6	11.0	0.41
877078	2-7/16	85.4	60	91	1720	1 / 6	11.5	0.41
877080	2-1/2	86.7	60	91	1720	1 / 6	11.5	0.41
877082	2-9/16	89.2	65	95	2000	1 / 6	13.0	0.41
877084	2-5/8	91.2	65	95	2000	1 / 6	13.0	0.41
877086	2-11/16	92.9	65	95	2230	1 / 6	14.0	0.41
877088	2-3/4	95.4	70	100	2350	1 / 6	15.0	0.41
877090	2-13/16	96.8	70	100	2450	1 / 6	16.0	0.41
877092	2-7/8	99.1	70	100	2580	1 / 6	16.5	0.41
877094	2-15/16	101.6	70	105	2720	1 / 6	17.5	0.41
877096	3	103.0	70	105	2720	1 / 6	17.5	0.41
877098	3-1/16	105.8	70	105	2840	1 / 6	18.0	0.41
877100	3-1/8	107.9	80	105	3200	1 / 3	11.0	0.31
877102	3-3/16	109.3	80	105	3200	1 / 3	11.0	0.31
877104	3-1/4	110.0	80	105	3510	1 / 3	11.5	0.31
877106	3-5/16	112.0	80	105	3560	1 / 3	11.5	0.31
877108	3-3/8	114.0	86	110	3600	1 / 3	12.0	0.31
877110	3-7/16	116.0	86	110	3700	1 / 3	12.0	0.31
877112	3-1/2	118.0	86	110	3800	1 / 3	12.5	0.31
877114	3-9/16	120.0	86	110	3800	1 / 3	12.5	0.31
877116	3-5/8	124.0	86	110	4000	1 / 3	13.0	0.31
877118	3-11/16	126.0	86	110	4400	1 / 3	14.0	0.31
877120	3-3/4	128.0	86	120	4700	1 / 3	15.0	0.31

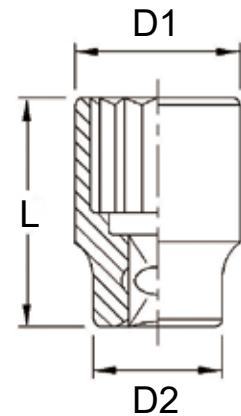
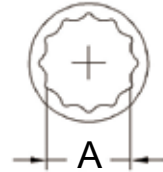

## Adapters

Item No.	Female Drive	Male Drive	Length mm	Weight g	PCS inner/ctn	G.W. KGS	CUFT
821006	1"	3/4"	75	600	1 / 30	19.0	0.52
821012	1"	1-1/2"	80	870	1 / 30	27.0	0.52



## Extension Bars

Item No.	Length mm	Weight g	PCS inner/ctn	G.W. KGS	CUFT
820150	150	1180	2 / 12	15.0	0.34
820200	200	1470	2 / 12	18.5	0.34
820250	250	1750	1 / 6	11.5	0.34
820400	400	2580	1 / 6	16.5	0.41



## Universal Joint

Item No.	Outside Diameter	Length mm	Weight g	PCS inner/ctn	G.W. KGS	CUFT
880808	52mm	130	1050	1 / 12	14.0	0.30



## 24 Teeth Ratchet Head with Tube Handle

Item No.	Length mm	Weight g	PCS inner/ctn	G.W. KGS	CUFT	Head No.	Handle No.
880888R	800	4100	1 / 6	25.0	1.39	880888	680580



## Hinge Head

Item No.	Length mm	Weight g	PCS inner/ctn	G.W. KGS	CUFT
880846	350	2230	1 / 10	23.0	0.70



## Hinge Head with Tube Handle

Item No.	Length mm	Weight g	PCS inner/ctn	G.W. KGS	CUFT	Head No.	Handle No.
880846E	815	4000	1 / 6	25.0	1.39	880846	680580



## 48 Teeth Ratchet Head

Item No.	Length mm	Weight g	PCS inner/ctn	G.W. KGS	CUFT
880872	290	2000	1 / 12	26.0	0.77



## 48 Teeth Ratchet Head with Tube Handle

Item No.	Length mm	Weight g	PCS inner/ctn	G.W. KGS	CUFT	Head No.	Handle No.
880872E	760	3670	1 / 6	23.0	1.39	880872	680580



## Tube Handles

Item No.	Length mm	Weight g	PCS inner/ctn	G.W. KGS	CUFT
680350	350	960	1 / 15	15.5	0.31
680580	580	1610	1 / 10	17.0	0.30
680850	850	2340	1 / 10	24.5	0.44



## Sliding T-Handles

Item No.	Length mm	Weight g	PCS inner/ctn	G.W. KGS	CUFT
880063	630	4100	1 / 6	26.0	1.39
880080	750	4500	1 / 6	28.0	1.39







# Hand Socket Sets

## L-Handle

Item No.	Length inch (mm)	Weight g	PCS inner/ctn	G.W. KGS	CUFT
820650L	26" (650)	5100	1 / 5	26.5	1.41



## GS-815M 15 Piece 1" Dr. Metric Hand Socket Set

Item No.	Size	Item No.	Size
<b>1" Dr. 6pt Hand Socket:</b>			
827030	30mm	827041	41mm
827032	32mm	827046	46mm
827033	33mm	827050	50mm
827035	35mm	827055	55mm
827036	36mm	827060	60mm
827038	38mm	827063	63mm

### 1" Dr. Accessory:

820150	Extension Bar, 150mmL
820200	Extension Bar, 200mmL
880888R	24T Reversible Ratchet

Metal Box

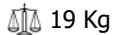

19 Kg



1 set / 20 Kgs / 0.82 CUFT



6 pt.



## GS-815M1 15 Piece 1" Dr. Metric Hand Socket Set

Item No.	Size	Item No.	Size
<b>1" Dr. 6pt Hand Socket:</b>			
827030	30mm	827041	41mm
827032	32mm	827046	46mm
827033	33mm	827050	50mm
827035	35mm	827055	55mm
827036	36mm	827060	60mm
827038	38mm	827065	65mm

### 1" Dr. Accessory:

820150	Extension Bar, 150mmL
820200	Extension Bar, 200mmL
880888R	24T Reversible Ratchet

Metal Box



24 Kg



1 set / 25 Kgs / 0.82 CUFT



6 pt.



## GS-815S 15 Piece 1" Dr. SAE Hand Socket Set

Item No.	Size	Item No.	Size
<b>1" Dr. 6pt Hand Socket:</b>			
887036	1-1/8"	887060	1-7/8"
887040	1-1/4"	887064	2"
887044	1-3/8"	887068	2-1/8"
887048	1-1/2"	887072	2-1/4"
887052	1-5/8"	887076	2-3/8"
887056	1-3/4"	887080	2-1/2"

### 1" Dr. Accessory:

820150	Extension Bar, 6"L
820200	Extension Bar, 8"L
880888R	24T Reversible Ratchet

Metal Box



20 Kg



1 set / 21 Kgs / 0.82 CUFT



6 pt.



## GS-817M 17 Piece 1" Dr. Metric Hand Socket Set

Item No.	Size	Item No.	Size
<b>1" Dr. 6pt Hand Socket:</b>			
827024	24mm	827046	46mm
827027	27mm	827050	50mm
827030	30mm	827054	54mm
827032	32mm	827055	55mm
827033	33mm	827060	60mm
827035	35mm	827065	65mm
827036	36mm	827070	70mm
827038	38mm	827075	75mm
827041	41mm	Blow Case	

20 Kg

1 set / 21 Kgs / 1.41 CUFT



6 pt.

## GS-817S 17 Piece 1" Dr. SAE Hand Socket Set

Item No.	Size	Item No.	Size
<b>1" Dr. 6pt Hand Socket:</b>			
887046	1-7/16"	887070	2-3/16"
887048	1-1/2"	887072	2-1/4"
887052	1-5/8"	887076	2-3/8"
887054	1-11/16"	887080	2-1/2"
887056	1-3/4"	887084	2-5/8"
887058	1-13/16"	887088	2-3/4"
887060	1-7/8"	887094	2-15/16"
887064	2"	887100	3-1/8"
887068	2-1/8"	Blow Case	

26 Kg

1 set / 27 Kgs / 1.41 CUFT



6 pt.

**GENIUS<sup>®</sup>**

*Bit Sockets, Bits &  
Screwdrivers*



**GENIUS TOOLS**  
[www.geniustools.net](http://www.geniustools.net)

# Head Drivers

3/8

## Slotted Head Drivers

Item No.	T x W mm	D mm	Length mm	Weight g	PCS inner/ctn	G.W. KGS	CUFT
3452P055	1.0 x 5.5	19	52	45	10 / 200	10.0	0.60
3452P08	1.2 x 8.0	19	52	45	10 / 200	10.0	0.60
3452P10	1.6 x 10.0	19	52	50	10 / 200	11.0	0.60
3460P055	1.0 x 5.5	19	60	50	10 / 200	11.0	0.60
3460P08	1.2 x 8.0	19	60	50	10 / 200	11.0	0.60
3460P10	1.6 x 10.0	19	60	60	10 / 200	13.0	0.60
3476P055	1.0 x 5.5	19	76	80	10 / 140	12.0	0.44
3476P08	1.2 x 8.0	19	76	80	10 / 140	12.0	0.44
3476P10	1.6 x 10.0	19	76	95	10 / 140	14.5	0.44

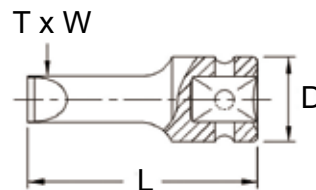

## Philips Head Drivers

Item No.	A Size	D mm	Length mm	Weight g	PCS inner/ctn	G.W. KGS	CUFT
3452R01	#1	19	52	45	10 / 200	10.0	0.60
3452R02	#2	19	52	45	10 / 200	10.0	0.60
3452R03	#3	19	52	45	10 / 200	10.0	0.60
3452R04	#4	19	52	50	10 / 200	11.0	0.60
3460R01	#1	19	60	50	10 / 200	11.0	0.60
3460R02	#2	19	60	50	10 / 200	11.0	0.60
3460R03	#3	19	60	50	10 / 200	11.0	0.60
3460R04	#4	19	60	60	10 / 200	13.0	0.60
3476R01	#1	19	76	75	10 / 140	11.5	0.44
3476R02	#2	19	76	80	10 / 140	12.5	0.44
3476R03	#3	19	76	80	10 / 140	12.5	0.44
3476R04	#4	19	76	95	10 / 140	14.5	0.44

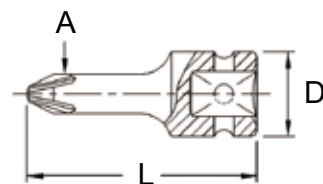

## TX-321 21 Piece 3/8" Dr. Star Head Driver Component Set

Item No.	Size	Item No.	Size
<b>3/8" Dr. Head Driver, 60mmL</b>			
3460R01	#1 Philips	3460S20	T-20 Star
3460R02	#2 Philips	3460S25	T-25 Star
3460R03	#3 Philips	3460S27	T-27 Star
3460R04	#4 Philips	3460S30	T-30 Star
3460P055	1.0 x 5.5mm Slotted	3460S40	T-40 Star
3460P08	1.2 x 8.0mm Slotted	3460S45	T-45 Star
3460P10	1.6 x 10.0mm Slotted	3460S50	T-50 Star
3460S10	T-10 Star	3460S55	T-55 Star
3460S15	T-15 Star	3460S60	T-60 Star

### 3/8" Dr. Accessory:

340075B	Impact Extension Bar, 75mmL
380030	Sliding T-Handle
380333R	24T Reversible Ratchet
Metal Box	

2450 g 6 sets / 16 Kgs / 0.7 CUFT



Bit Sockets

3/8

# Head Drivers

## Star Head Drivers

Item No.	A Size	D mm	Length mm	Weight g	PCS inner/ctn	G.W. KGS	CUFT
3452S10	T-10	19	52	45	10 / 200	10.0	0.60
3452S15	T-15	19	52	45	10 / 200	10.0	0.60
3452S20	T-20	19	52	45	10 / 200	10.0	0.60
3452S25	T-25	19	52	45	10 / 200	10.0	0.60
3452S27	T-27	19	52	45	10 / 200	10.0	0.60
3452S30	T-30	19	52	45	10 / 200	10.0	0.60
3452S40	T-40	19	52	45	10 / 200	10.0	0.60
3452S45	T-45	19	52	50	10 / 200	10.5	0.60
3452S50	T-50	19	52	50	10 / 200	11.0	0.60
3452S55	T-55	20	52	60	10 / 200	13.0	0.60
3452S60	T-60	20	52	70	10 / 200	15.0	0.60
3460S10	T-10	19	60	50	10 / 200	11.0	0.60
3460S15	T-15	19	60	50	10 / 200	11.0	0.60
3460S20	T-20	19	60	50	10 / 200	11.0	0.60
3460S25	T-25	19	60	50	10 / 200	11.0	0.60
3460S27	T-27	19	60	50	10 / 200	11.0	0.60
3460S30	T-30	19	60	50	10 / 200	11.0	0.60
3460S40	T-40	19	60	50	10 / 200	11.0	0.60
3460S45	T-45	19	60	55	10 / 200	12.0	0.60
3460S50	T-50	19	60	60	10 / 200	13.0	0.60
3460S55	T-55	20	60	70	10 / 200	15.0	0.60
3460S60	T-60	20	60	80	10 / 200	17.0	0.60
3476S10	T-10	19	76	75	10 / 140	11.5	0.44
3476S15	T-15	19	76	75	10 / 140	11.5	0.44
3476S20	T-20	19	76	75	10 / 140	11.5	0.44
3476S25	T-25	19	76	75	10 / 140	11.5	0.44
3476S27	T-27	19	76	80	10 / 140	12.5	0.44
3476S30	T-30	19	76	80	10 / 140	12.5	0.44
3476S40	T-40	19	76	80	10 / 140	12.5	0.44
3476S45	T-45	19	76	85	10 / 140	13.0	0.44
3476S50	T-50	19	76	90	10 / 140	13.5	0.44
3476S55	T-55	20	76	110	10 / 140	16.5	0.44
3476S60	T-60	20	76	130	10 / 140	19.0	0.44



### TX-311 11 Piece 3/8" Dr. Star Head Driver Set

Item No.	Size	Item No.	Size
<b>3/8" Dr. Star Head Driver, 60mmL</b>			
3460S10	T-10	3460S40	T-40
3460S15	T-15	3460S45	T-45
3460S20	T-20	3460S50	T-50
3460S25	T-25	3460S55	T-55
3460S27	T-27	3460S60	T-60
3460S30	T-30	Socket Holder	

580 g 20x2 40 sets / 24.5 Kgs / 1.21 CUFT



### TH-311M 11 Piece 3/8" Dr. Metric Hex Head Driver Set

Item No.	Size	Item No.	Size
<b>3/8" Dr. Metric Hex Head Driver, 60mmL</b>			
346004	4mm	346010	10mm
346005	5mm	346012	12mm
346006	6mm	346014	14mm
346007	7mm	346016	16mm
346008	8mm	346017	17mm
346009	9mm	Socket Holder	

600 g 20x2 40 sets / 25 Kgs / 1.21 CUFT



Made of Chrome Molybdenum Steel

# Head Drivers

3/8

## Metric Hex Head Drivers

Item No.	A mm	D mm	Length mm	Weight g	PCS inner/ctn	G.W. KGS	CUFT
345204	4	19	52	40	10 / 200	9.0	0.60
345205	5	19	52	40	10 / 200	9.0	0.60
345206	6	19	52	40	10 / 200	9.0	0.60
345207	7	19	52	45	10 / 200	10.0	0.60
345208	8	19	52	50	10 / 200	11.0	0.60
345209	9	19	52	55	10 / 200	12.0	0.60
345210	10	20	52	60	10 / 200	13.0	0.60
345212	12	20	52	70	10 / 200	15.0	0.60
345214	14	20	52	85	10 / 200	18.0	0.60
345216	16	20	52	100	10 / 200	21.0	0.60
345217	17	20	52	110	10 / 200	23.0	0.60
346004	4	19	60	45	10 / 200	10.0	0.60
346005	5	19	60	45	10 / 200	10.0	0.60
346006	6	19	60	50	10 / 200	11.0	0.60
346007	7	19	60	50	10 / 200	11.0	0.60
346008	8	19	60	55	10 / 200	12.0	0.60
346009	9	19	60	60	10 / 200	13.0	0.60
346010	10	20	60	70	10 / 200	15.0	0.60
346012	12	20	60	80	10 / 200	17.0	0.60
346014	14	20	60	95	10 / 200	20.0	0.60
346016	16	20	60	100	10 / 200	21.0	0.60
346017	17	20	60	120	10 / 200	25.0	0.60
347604	4	19	76	55	10 / 140	9.0	0.44
347605	5	19	76	55	10 / 140	9.0	0.44
347606	6	19	76	55	10 / 140	9.0	0.44
347607	7	19	76	65	10 / 140	10.0	0.44
347608	8	19	76	70	10 / 140	11.0	0.44
347609	9	19	76	80	10 / 140	12.0	0.44
347610	10	20	76	90	10 / 140	13.0	0.44
347612	12	20	76	110	10 / 140	15.5	0.44
347614	14	20	76	130	10 / 140	19.0	0.44
347616	16	20	76	150	10 / 140	22.5	0.44
347617	17	20	76	160	10 / 140	23.5	0.44



## SAE Hex Head Drivers

Item No.	A inch	D mm	Length mm	Weight g	PCS inner/ctn	G.W. KGS	CUFT
365205	5/32	19	52	40	10 / 200	9.0	0.60
365206	3/16	19	52	40	10 / 200	9.0	0.60
365207	7/32	19	52	40	10 / 200	9.0	0.60
365208	1/4	19	52	45	10 / 200	10.0	0.60
365210	5/16	19	52	50	10 / 200	11.0	0.60
365212	3/8	19	52	60	10 / 200	13.0	0.60
365214	7/16	20	52	70	10 / 200	15.0	0.60
365216	1/2	20	52	80	10 / 200	17.0	0.60
365218	9/16	20	52	90	10 / 200	19.0	0.60
365220	5/8	20	52	100	10 / 200	21.0	0.60

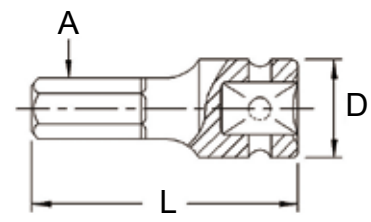

## TH-310S 10 Piece 3/8" Dr. SAE Hex Head Driver Set

Item No.	Size	Item No.	Size
<b>3/8" Dr. Hex Head Driver, 52mmL</b>			
365205	5/32"	365212	3/8"
365206	3/16"	365214	7/16"
365207	7/32"	365216	1/2"
365208	1/4"	365218	9/16"
365210	5/16"	365220	5/8"

Metal Box

900 g

20 sets / 21 Kgs / 0.88 CUFT



Bit Sockets

3/8

# Head Driver Sets

## TH-310M 10 Piece 3/8" Dr. Metric Hex Head Driver Set

Item No.	Size	Item No.	Size
<b>3/8" Dr. Hex Head Driver, 52mmL</b>			
345204	4mm	345210	10mm
345205	5mm	345212	12mm
345206	6mm	345214	14mm
345207	7mm	345216	16mm
345208	8mm	345217	17mm

Metal Box  
 900 g 20 sets / 21 Kgs / 0.88 CUFT



## TH-312M 12 Piece 3/8" Dr. Metric Hex Head Driver Set

Item No.	Size	Item No.	Size
<b>3/8" Dr. Hex Head Driver, 52mmL</b>			
345204	4mm	345210	10mm
345205	5mm	345212	12mm
345206	6mm	345214	14mm
345207	7mm	345216	16mm
345208	8mm	345217	17mm

**3/8" Dr. Accessory:**  
 380030 Sliding T-Handle  
 380333R 24T Reversible Ratchet  
 Metal Box

1800 g 10 sets / 19 Kgs / 0.77 CUFT



## TH-312S 12 Piece 3/8" Dr. SAE Hex Head Driver Set

Item No.	Size	Item No.	Size
<b>3/8" Dr. Hex Head Driver, 52mmL</b>			
365205	5/32"	365212	3/8"
365206	3/16"	365214	7/16"
365207	7/32"	365216	1/2"
365208	1/4"	365218	9/16"
365210	5/16"	365220	5/8"

**3/8" Dr. Accessory:**  
 380030 Sliding T-Handle  
 380333R 24T Reversible Ratchet  
 Metal Box

1800 g 10 sets / 19 Kgs / 0.77 CUFT



## TH-321M 21 Piece 3/8" Dr. Metric Hex Head Driver Component Set

Item No.	Size	Item No.	Size
<b>3/8" Dr. Head Driver, 60mmL</b>			
3460R01	#1 Philips	346006	6mm Hex
3460R02	#2 Philips	346007	7mm Hex
3460R03	#3 Philips	346008	8mm Hex
3460R04	#4 Philips	346009	9mm Hex
3460P055	1.0 x 5.5mm Slotted	346010	10mm Hex
3460P08	1.2 x 8.0mm Slotted	346012	12mm Hex
3460P10	1.6 x 10.0mm Slotted	346014	14mm Hex
346004	4mm Hex	346016	16mm Hex
346005	5mm Hex	346017	17mm Hex

**3/8" Dr. Accessory:**  
 340075B Impact Extension Bar, 75mmL  
 380030 Sliding T-Handle  
 380333R 24T Reversible Ratchet  
 Metal Box

2650 g 6 sets / 17 Kgs / 0.7 CUFT



Made of Chrome Molybdenum Steel



# Head Drivers

3/8

## Triple Square Head Drivers

Item No.	A Size	D mm	Length mm	Weight g	PCS inner/ctn	G.W. KGS	CUFT
3452T05	M5	19	52	45	10 / 200	10.0	0.60
3452T06	M6	19	52	45	10 / 200	10.0	0.60
3452T08	M8	19	52	50	10 / 200	11.0	0.60
3452T10	M10	20	52	60	10 / 200	13.0	0.60
3452T12	M12	20	52	65	10 / 200	14.0	0.60
3460T05	M5	19	60	50	10 / 200	11.0	0.60
3460T06	M6	19	60	50	10 / 200	11.0	0.60
3460T08	M8	19	60	55	10 / 200	12.0	0.60
3460T10	M10	20	60	65	10 / 200	14.0	0.60
3460T12	M12	20	60	75	10 / 200	16.0	0.60
3476T05	M5	19	76	80	10 / 140	12.5	0.44
3476T06	M6	19	76	80	10 / 140	12.5	0.44
3476T08	M8	19	76	90	10 / 140	13.5	0.44
3476T10	M10	20	76	110	10 / 140	16.5	0.44
3476T12	M12	20	76	130	10 / 140	19.5	0.44

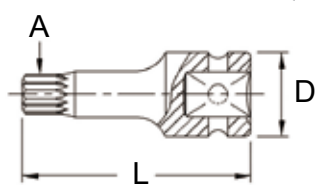

## TM-305 5 Piece 3/8" Dr. Triple Square Head Driver Set

Item No.	Size	Item No.	Size
<b>3/8" Dr. Triple Square Head Driver, 76mmL</b>			
3476T05	M5	3476T10	M10
3476T06	M6	3476T12	M12
3476T08	M8		Metal Box

650 g 20 sets / 14 Kgs / 0.67 CUFT



## MS-065S 65 Piece 3/8" Dr. Head Driver & Impact Socket Set

Item No.	Size	Item No.	Size	Item No.	Size
<b>3/8" Dr. 6pt Swivel Impact Socket (CR-V):</b>			<b>3/8" Dr. 6pt Impact Socket (CR-Mo):</b>		
380J21	5/16"	380025	9/16"	363210	5/16"
380022	3/8"	380026	5/8"	363211	11/32"
380023	7/16"	380027	11/16"	363212	3/8"
380024	1/2"	380028	3/4"	363214	7/16"
<b>3/8" Dr. Head Driver, 52mmL:</b>			363216	1/2"	
3452P055	1.0 x 5.5mm	365210	5/16" Hex	363218	9/16"
3452P08	1.2 x 8.0mm	365212	3/8" Hex	363219	19/32"
3452P10	1.6 x 10.0mm	365214	7/16" Hex	363220	5/8"
3452R01	#1 Philips	365216	1/2" Hex	363222	11/16"
3452R02	#2 Philips	365218	9/16" Hex	363224	3/4"
3452R03	#3 Philips	365220	5/8" Hex	363225	25/32"
3452R04	#4 Philips	3452S10	T-10 Star	363226	13/16"
345204	4mm Hex	3452S15	T-15 Star	363228	7/8"
345205	5mm Hex	3452S20	T-20 Star	<b>3/8" Dr. Accessory:</b>	
345206	6mm Hex	3452S25	T-25 Star	700007	Impact Driver
345207	7mm Hex	3452S27	T-27 Star		Plastic Tray
345208	8mm Hex	3452S30	T-30 Star		
345209	9mm Hex	3452S40	T-40 Star		
345210	10mm Hex	3452S45	T-45 Star		
345212	12mm Hex	3452S50	T-50 Star		
345214	14mm Hex	3452S55	T-55 Star		
345216	16mm Hex	3452T05	M5 Triple Square		
345217	17mm Hex	3452T06	M6 Triple Square		
365205	5/32" Hex	3452T08	M8 Triple Square		
365206	3/16" Hex	3452T10	M10 Triple Square		
365207	7/32" Hex	3452T12	M12 Triple Square		
365208	1/4" Hex				

5000 g 3 sets / 16 Kgs / 1.35 CUFT



(285W x 410D x 50H)

Made of Chrome Molybdenum Steel

Bit Sockets



1/2

# Head Drivers

## Slotted Head Drivers

Item No.	T x W	D	Length	Weight	PCS	G.W.	CUFT
	mm						
4460P08	1.2 x 8.0	24	60	65	10 / 140	9.5	0.44
4460P10	1.6 x 10.0	24	60	70	10 / 140	11.0	0.44
4460P12	2.0 x 12.0	24	60	80	10 / 140	12.0	0.44
4460P14	2.5 x 14.0	24	60	90	10 / 140	13.5	0.44
4460P16	2.5 x 16.0	24	60	95	10 / 140	15.0	0.44
4476P08	1.2 x 8.0	24	76	75	10 / 140	11.5	0.44
4476P10	1.6 x 10.0	24	76	85	10 / 140	13.0	0.44
4476P12	2.0 x 12.0	24	76	95	10 / 140	15.0	0.44
4476P14	2.5 x 14.0	24	76	110	10 / 140	16.5	0.44
4476P16	2.5 x 16.0	24	76	120	10 / 140	18.0	0.44

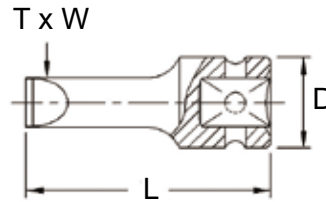

## Philips Head Drivers

Item No.	A	D	Length	Weight	PCS	G.W.	CUFT
	Size						
4460R01	#1	24	60	70	10 / 140	11.0	0.44
4460R02	#2	24	60	70	10 / 140	11.0	0.44
4460R03	#3	24	60	70	10 / 140	11.0	0.44
4460R04	#4	24	60	80	10 / 140	12.0	0.44
4476R01	#1	24	76	75	10 / 140	11.5	0.44
4476R02	#2	24	76	75	10 / 140	11.5	0.44
4476R03	#3	24	76	80	10 / 140	12.0	0.44
4476R04	#4	24	76	85	10 / 140	13.0	0.44

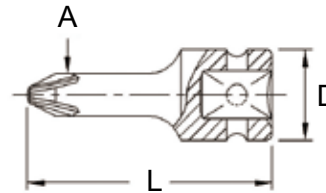

## Star Head Drivers

Item No.	A	D	Length	Weight	PCS	G.W.	CUFT
	Size						
4460S10	T-10	24	60	60	10 / 140	9.5	0.44
4460S15	T-15	24	60	60	10 / 140	9.5	0.44
4460S20	T-20	24	60	60	10 / 140	9.5	0.44
4460S25	T-25	24	60	60	10 / 140	9.5	0.44
4460S27	T-27	24	60	60	10 / 140	9.5	0.44
4460S30	T-30	24	60	65	10 / 140	11.5	0.44
4460S40	T-40	24	60	70	10 / 140	11.5	0.44
4460S45	T-45	24	60	70	10 / 140	11.5	0.44
4460S50	T-50	26	60	90	10 / 140	13.5	0.44
4460S55	T-55	26	60	100	10 / 140	15.0	0.44
4460S60	T-60	26	60	105	10 / 140	16.5	0.44
4460S70	T-70	26	60	115	10 / 140	17.0	0.44
4460S80	T-80	26	60	125	10 / 140	18.5	0.44
4476S10	T-10	24	76	60	10 / 140	9.5	0.44
4476S15	T-15	24	76	60	10 / 140	9.5	0.44
4476S20	T-20	24	76	60	10 / 140	9.5	0.44
4476S25	T-25	24	76	60	10 / 140	9.5	0.44
4476S27	T-27	24	76	70	10 / 140	11.0	0.44
4476S30	T-30	24	76	70	10 / 140	11.0	0.44
4476S40	T-40	24	76	75	10 / 140	11.5	0.44
4476S45	T-45	24	76	75	10 / 140	11.5	0.44
4476S50	T-50	26	76	100	10 / 140	14.5	0.44
4476S55	T-55	26	76	110	10 / 140	16.5	0.44
4476S60	T-60	26	76	130	10 / 140	19.0	0.44
4476S70	T-70	26	76	145	10 / 140	21.5	0.44

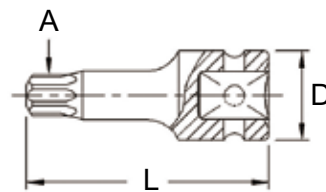

# Head Drivers

1/2

## Metric & SAE Hex Head Drivers

Item No.	A		Length mm	Weight g	PCS inner/ctn	G.W. KGS	CUFT 
	mm	inch					
446004	4	24	60	70	10 / 140	11.0	0.44
446005	5	24	60	70	10 / 140	11.0	0.44
446006	6	24	60	70	10 / 140	11.0	0.44
446007	7	24	60	75	10 / 140	11.5	0.44
446008	8	24	60	75	10 / 140	11.5	0.44
446009	9	24	60	80	10 / 140	12.5	0.44
446010	10	26	60	100	10 / 140	15.0	0.44
<b>NEW</b> 446011	11	26	60	105	10 / 140	16.0	0.44
446012	12	26	60	110	10 / 140	16.5	0.44
446013	13	26	60	115	10 / 120	15.5	0.52
446014	14	26	60	120	10 / 120	16.5	0.52
<b>NEW</b> 446015	15	26	60	130	10 / 120	16.5	0.52
446016	16	28	60	150	10 / 120	19.0	0.52
446017	17	28	60	160	10 / 120	20.0	0.52
<b>NEW</b> 446018	18	28	60	165	10 / 120	21.0	0.52
446019	19	28	60	170	10 / 120	21.5	0.52
<b>NEW</b> 446020	20	28	60	185	10 / 120	23.0	0.52
446021	21	28	60	190	10 / 120	24.0	0.52
<b>NEW</b> 446022	22	28	60	195	10 / 120	24.0	0.52
<b>NEW</b> 446024	24	28	60	195	10 / 120	24.0	0.52
447604	4	24	76	70	10 / 140	10.8	0.44
447605	5	24	76	70	10 / 140	10.8	0.44
447606	6	24	76	75	10 / 140	11.5	0.44
447607	7	24	76	80	10 / 140	12.2	0.44
447608	8	24	76	85	10 / 140	13.0	0.44
447609	9	24	76	90	10 / 140	13.5	0.44
447610	10	26	76	110	10 / 140	16.5	0.44
447612	12	26	76	130	10 / 140	19.0	0.44
447614	14	26	76	150	10 / 120	19.0	0.52
447616	16	28	76	185	10 / 120	23.0	0.52
447617	17	28	76	195	10 / 120	24.5	0.52
<b>NEW</b> 447618	18	28	76	210	10 / 80	17.8	0.38
447619	19	28	76	225	10 / 80	19.0	0.38
447621	21	28	76	250	10 / 80	21.0	0.38
466005	5/32	24	60	65	10 / 140	10.0	0.44
466006	3/16	24	60	65	10 / 140	10.0	0.44
<b>NEW</b> 466007	7/32	24	60	70	10 / 140	11.0	0.44
466008	1/4	24	60	70	10 / 140	11.0	0.44
466010	5/16	24	60	75	10 / 140	11.5	0.44
466012	3/8	26	60	85	10 / 140	13.0	0.44
466014	7/16	26	60	110	10 / 140	16.5	0.44
466016	1/2	26	60	120	10 / 140	18.0	0.44
466018	9/16	26	60	130	10 / 120	16.5	0.52
466020	5/8	28	60	150	10 / 120	19.0	0.52
466022	11/16	28	60	160	10 / 120	20.5	0.52
466024	3/4	28	60	180	10 / 120	22.5	0.52
466026	13/16	28	60	190	10 / 120	24.0	0.52

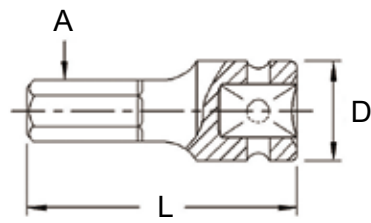
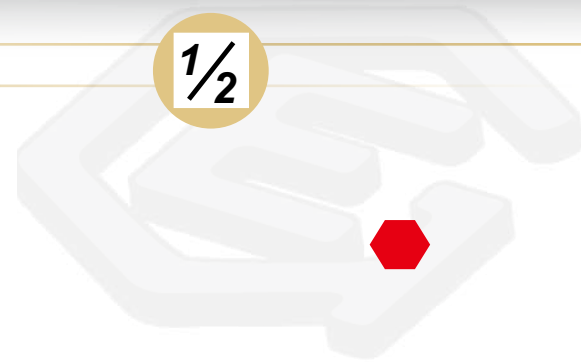

## Triple Square Head Drivers

Item No.	A		Length mm	Weight g	PCS inner/ctn	G.W. KGS	CUFT 
	Size	mm					
4460T05	M5	24	60	70	10 / 140	11.0	0.44
4460T06	M6	24	60	70	10 / 140	11.0	0.44
4460T08	M8	24	60	75	10 / 140	11.5	0.44
4460T10	M10	26	60	90	10 / 140	13.5	0.44
4460T12	M12	26	60	100	10 / 140	15.0	0.44
<b>NEW</b> 4460T14	M14	26	60	115	10 / 140	17.0	0.44
<b>NEW</b> 4460T16	M16	28	60	145	10 / 120	18.5	0.52
<b>NEW</b> 4460T18	M18	28	60	165	10 / 120	21.0	0.52
<b>NEW</b> 4460T19	M19	28	60	170	10 / 120	21.5	0.52
4476T05	M5	24	76	75	10 / 140	11.5	0.44
4476T06	M6	24	76	75	10 / 140	11.5	0.44
4476T08	M8	24	76	80	10 / 140	12.5	0.44
4476T10	M10	26	76	110	10 / 140	16.5	0.44
4476T12	M12	26	76	120	10 / 140	18.0	0.44
4476T14	M14	26	76	140	10 / 120	18.0	0.52
4476T16	M16	28	76	170	10 / 120	21.5	0.52
<b>NEW</b> 4476T18	M18	28	76	220	10 / 120	27.5	0.52
<b>NEW</b> 4476T19	M19	28	76	230	10 / 120	28.5	0.52

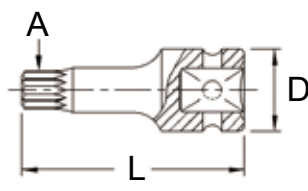

Made of Chrome Molybdenum Steel

Bit Sockets

1/2

# Head Driver Sets

## TM-405 5 Piece 1/2" Dr. Triple Square Head Driver Set

Item No.	Size	Item No.	Size
<b>1/2" Dr. Triple Square Head Driver, 76mmL</b>			
4476T05	M5	4476T10	M10
4476T06	M6	4476T12	M12
4476T08	M8		Metal Box
700 g		20 sets / 15 Kgs / 0.67 CUFT	



## TH-411M 11 Piece 1/2" Dr. Metric Hex Head Driver Set

Item No.	Size	Item No.	Size
<b>1/2" Dr. Hex Head Driver, 60mmL</b>			
446005	5mm	446012	12mm
446006	6mm	446014	14mm
446007	7mm	446016	16mm
446008	8mm	446017	17mm
446009	9mm	446019	19mm
446010	10mm		Socket Holder
1300 g		12x1 12 sets / 17 Kgs / 0.73 CUFT	



## TH-410S 10 Piece 1/2" Dr. SAE Hex Head Driver Set

Item No.	Size	Item No.	Size
<b>1/2" Dr. Hex Head Driver, 60mmL</b>			
466006	3/16"	466014	7/16"
466007	7/32"	466016	1/2"
466008	1/4"	466018	9/16"
466010	5/16"	466020	5/8"
466012	3/8"	466024	3/4"
Socket Holder			
1150 g		12x1 12 sets / 15 Kgs / 0.73 CUFT	



## TH-408MD 8 Piece 1/2" Dr. Metric Hex Head Driver Set SAE size: TH-408SD also available

Item No.	Size	Item No.	Size
<b>1/2" Dr. Hex Head Driver, 76mmL</b>			
447605	5mm	447612	12mm
447606	6mm	447614	14mm
447608	8mm	447617	17mm
447610	10mm	447619	19mm
Socket Holder			
1150 g		20x1 20 sets / 24 Kgs / 0.73 CUFT	



## WH-408MD 8 Piece 1/2" Dr. Metric Wobble Hex Head Driver Set SAE size: WH-408SD also available

Item No.	Size	Item No.	Size
<b>1/2" Dr. Wobble Hex Head Driver, 76mmL</b>			
4476W05	5mm	4476W12	12mm
4476W06	6mm	4476W14	14mm
4476W08	8mm	4476W17	17mm
4476W10	10mm	4476W19	19mm
Socket Holder			
1050 g		20x1 20 sets / 22 Kgs / 0.73 CUFT	



# Head Driver Sets

1/2

## TX-415 15 Piece 1/2" Dr. Star Head Driver Component Set

Item No.	Size	Item No.	Size
<b>1/2" Dr. Star Head Driver, 60mmL</b>			
4460S10	T-10	4460S40	T-40
4460S15	T-15	4460S45	T-45
4460S20	T-20	4460S50	T-50
4460S25	T-25	4460S55	T-55
4460S27	T-27	4460S60	T-60
4460S30	T-30	4460S70	T-70

### 1/2" Dr. Accessory:

480032MB	Impact Extension Bar, 75mmL
480040	Sliding T-Handle
480444R	24T Reversible Ratchet
Metal Box	

3150 g

6 sets / 20 Kgs / 0.7 CUFT



## TH-415H 15 Piece 1/2" Dr. Metric Hex Head Driver Set

Item No.	Size	Item No.	Size
<b>1/2" Dr. Hex Head Driver, 60mmL</b>			
446004	4mm	446012	12mm
446005	5mm	446014	14mm
446006	6mm	446017	17mm
446008	8mm	446019	19mm
446010	10mm		

### Accessory:

700288	1.2 x 8.0mm Slotted Bit	700292	#2 Philips Bit
700290	1.6 x 10.0mm Slotted Bit	700293	#3 Philips Bit
464110	1/2" Dr. 5/16" Hex Bit Holder		
700008	1/2" Dr. Impact Driver		
Metal Box			

3000 g

6 sets / 19 Kgs / 0.65 CUFT



## ID-424M 24 Piece 1/2" Dr. Metric Impact Driver Set

Item No.	Size	Item No.	Size
<b>1/2" Dr. 6pt Impact Socket:</b>			
444008	8mm	444014	14mm
444010	10mm	444017	17mm
444011	11mm	444019	19mm
444012	12mm	444021	21mm
444013	13mm	444022	22mm

### 1/2" Dr. Head Driver, 60mmL

4460P10	1.6 x 10.0mm Slotted	4460R04	#4 Philips
4460P12	2.0 x 12.0mm Slotted	446005	5mm Hex
4460P14	2.5 x 14.0mm Slotted	446006	6mm Hex
4460P16	2.5 x 16.0mm Slotted	446007	7mm Hex
4460R01	#1 Philips	446008	8mm Hex
4460R02	#2 Philips	446010	10mm Hex
4460R03	#3 Philips		

### 1/2" Dr. Accessory:

700008	Impact Driver	Blow Case
--------	---------------	-----------

3000 g

5 sets / 16 Kgs / 0.6 CUFT

SAE size: ID-424S also available



6 pt.



Bit Sockets

1/2

# Head Driver Sets

## TH-408M 8 Piece 1/2" Dr. Metric Hex Head Driver Set

Item No.	Size	Item No.	Size
<b>1/2" Dr. Hex Head Driver, 60mmL</b>			
446005	5mm	446012	12mm
446006	6mm	446014	14mm
446008	8mm	446017	17mm
446010	10mm	446019	19mm
Metal Box			
1200 g	20 sets / 25 Kgs / 0.88 CUFT		



## TH-408S 8 Piece 1/2" Dr. SAE Hex Head Driver Set

Item No.	Size	Item No.	Size
<b>1/2" Dr. Hex Head Driver, 60mmL</b>			
466006	3/16"	466014	7/16"
466008	1/4"	466018	9/16"
466010	5/16"	466022	11/16"
466012	3/8"	466024	3/4"
Metal Box			
1200 g	20 sets / 25 Kgs / 0.88 CUFT		



## TH-412H 12 Piece 1/2" Dr. Metric Hex Head Driver Set

Item No.	Size	Item No.	Size
<b>1/2" Dr. Hex Head Driver, 60mmL</b>			
446004	4mm	446012	12mm
446005	5mm	446014	14mm
446006	6mm	446017	17mm
446008	8mm	446019	19mm
446010	10mm		
<b>1/2" Dr. Accessory:</b>			
480032MB	Impact Extension Bar, 75mmL		
480040	Sliding T-Handle		
480444R	24T Reversible Ratchet		
Blow Case			
2800 g	6 sets / 18 Kgs / 1.16 CUFT		



## TH-412S 12 Piece 1/2" Dr. SAE Hex Head Driver Set

Item No.	Size	Item No.	Size
<b>1/2" Dr. Hex Head Driver, 60mmL</b>			
466005	5/32"	466014	7/16"
466006	3/16"	466016	1/2"
466008	1/4"	466020	5/8"
466010	5/16"	466024	3/4"
466012	3/8"		
<b>1/2" Dr. Accessory:</b>			
480032MB	Impact Extension Bar, 3\"/>		
480040	Sliding T-Handle		
480444R	24T Reversible Ratchet		
Blow Case			
2800 g	6 sets / 18 Kgs / 1.16 CUFT		



# Head Drivers

3/4

## Metric & SAE Hex Head Drivers

Item No.	A mm	D mm	Length mm	Weight g	PCS inner/ctn	G.W. KGS	CUFT
648814	14	40	88	350	1 / 30	11.5	0.52
648817	17	40	88	390	1 / 30	13.0	0.52
648819	19	44	88	490	1 / 30	15.5	0.52
648821	21	44	88	510	1 / 30	16.0	0.52
648822	22	44	88	520	1 / 30	16.5	0.52
648824	24	44	88	560	1 / 30	18.0	0.52
648827	27	44	88	600	1 / 30	19.0	0.52
648830	30	44	88	650	1 / 30	20.5	0.52
648832	32	44	88	700	1 / 30	22.0	0.52
668824	3/4	44	88	480	1 / 30	15.5	0.52
668826	13/16	44	88	500	1 / 30	16.0	0.52
668828	7/8	44	88	520	1 / 30	16.5	0.52
668830	15/16	44	88	550	1 / 30	17.5	0.52
668832	1	44	88	570	1 / 30	18.0	0.52
668834	1-1/16	44	88	600	1 / 30	19.0	0.52
668836	1-1/8	44	88	630	1 / 30	20.0	0.52
668838	1-3/16	44	88	660	1 / 30	21.0	0.52
668840	1-1/4	44	88	700	1 / 30	22.0	0.52

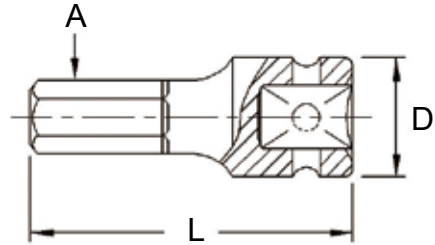

**NEW**

## TH-609M 9 Piece 3/4" Dr. Metric Hex Head Driver Set

SAE size: TH-609S also available

Item No.	Size	Item No.	Size
<b>3/4" Dr. Hex Head Driver, 88mmL</b>			
648814	14mm	648824	24mm
648817	17mm	648827	27mm
648819	19mm	648830	30mm
648821	21mm	648832	32mm
648822	22mm		Metal Box

5580 g 4 sets / 23.5 Kgs / 0.62 CUFT



## Metric & SAE Hex Bit Sockets

Item No.	A mm	D mm	Length mm	Weight g	PCS inner/ctn	G.W. KGS	CUFT
619+2914	14	38	80	380	1 / 20	8.5	0.34
619+2916	16	38	80	390	1 / 20	9.0	0.34
619+2917	17	38	80	400	1 / 20	9.0	0.34
619+2918	18	38	80	410	1 / 20	9.0	0.34
619+2919	19	38	80	420	1 / 20	9.5	0.34
622+2922	22	40	85	500	1 / 20	11.0	0.34
622+2924	24	40	85	530	1 / 20	11.5	0.34
627+2927	27	44	90	740	1 / 20	16.0	0.34
627+2930	30	44	90	770	1 / 20	16.5	0.34
627+2932	32	44	90	800	1 / 20	17.0	0.34
619+3936	9/16	38	80	390	1 / 20	9.0	0.34
619+3940	5/8	38	80	400	1 / 20	9.0	0.34
619+3948	3/4	38	80	410	1 / 20	9.5	0.34
622+3952	13/16	40	85	500	1 / 20	11.0	0.34
622+3956	7/8	40	85	520	1 / 20	11.5	0.34
622+3960	15/16	40	85	530	1 / 20	11.5	0.34
622+3964	1	40	85	550	1 / 20	12.0	0.34
627+3968	1-1/16	44	90	740	1 / 20	16.0	0.34
627+3972	1-1/8	44	90	760	1 / 20	16.0	0.34
627+3976	1-3/16	44	90	780	1 / 20	16.5	0.34
627+3980	1-1/4	44	90	800	1 / 20	17.0	0.34

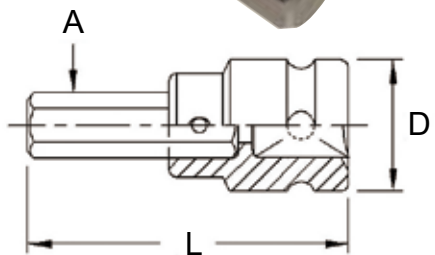

Bit Sockets



Made of Chrome Molybdenum Steel

3/4

# Head Drivers

## Star Bit Sockets

Item No.	A Size	D mm	Length mm	Weight g	PCS inner/ctn	G.W. KGS	CUFT
619+6980	T-80	38	95	430	1 / 20	9.5	0.34
619+6990	T-90	38	95	440	1 / 20	10.0	0.34
619+6995	T-100	38	95	450	1 / 20	10.0	0.34

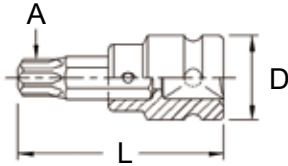

## Triple Square Bit Sockets

Item No.	A Size	D mm	Length mm	Weight g	PCS inner/ctn	G.W. KGS	CUFT
619+9916	M16	38	95	430	1 / 20	9.5	0.34
619+9918	M18	38	95	440	1 / 20	10.0	0.34

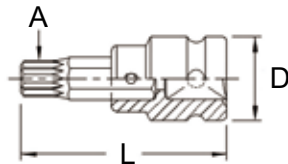

## BS-614H 14 Piece 3/4" Dr. Metric Hex Bit Socket Set

Item No.	Size	Item No.	Size
2914	19H x 14mm	2922	22H x 22mm
2916	19H x 16mm	2924	22H x 24mm
2917	19H x 17mm	2927	27H x 27mm
2918	19H x 18mm	2930	27H x 30mm
2919	19H x 19mm	2932	27H x 32mm

### Accessory:

- 619+ 3/4" Dr. 19H Bit Holder
- 622+ 3/4" Dr. 22H Bit Holder
- 627+ 3/4" Dr. 27H Bit Holder
- 570740 4mm Hex Key Wrench

Blow Case

3100 g 8 sets / 26 Kgs / 0.88 CUFT



## BS-615H 16 Piece 3/4" Dr. SAE Hex Bit Socket Set

Item No.	Size	Item No.	Size
3936	19H x 9/16"	3964	22H x 1"
3940	19H x 5/8"	3968	27H x 1-1/16"
3948	19H x 3/4"	3972	27H x 1-1/8"
3952	22H x 13/16"	3976	27H x 1-3/16"
3956	22H x 7/8"	3980	27H x 1-1/4"
3960	22H x 15/16"		

### Accessory:

- 619+ 3/4" Dr. 19H Bit Holder
- 622+ 3/4" Dr. 22H Bit Holder
- 627+ 3/4" Dr. 27H Bit Holder
- 570740 4mm Hex Key Wrench

Blow Case

3500 g 8 sets / 29 Kgs / 0.88 CUFT



# Head Drivers

1"

## Metric Hex Bit Sockets

Item No.	A mm	D mm	Length mm	Weight g	PCS inner/ctn	G.W. KGS	CUFT
819+2916	16	50	85	600	1 / 20	13.0	0.34
819+2917	17	50	85	610	1 / 20	13.0	0.34
819+2918	18	50	85	620	1 / 20	13.5	0.34
819+2919	19	50	85	630	1 / 20	13.5	0.34
822+2922	22	50	90	680	1 / 20	14.5	0.34
822+2924	24	50	90	700	1 / 20	15.0	0.34
827+2927	27	52	95	900	1 / 20	19.0	0.34
827+2930	30	52	95	930	1 / 20	19.5	0.34
827+2932	32	52	95	960	1 / 20	20.0	0.34
832+2933	33	52	100	1120	1 / 20	23.5	0.34
832+2936	36	52	100	1170	1 / 20	24.5	0.34



## SAE Hex Bit Sockets

Item No.	A inch	D mm	Length mm	Weight g	PCS inner/ctn	G.W. KGS	CUFT
819+3940	5/8	50	85	610	1 / 20	13.0	0.34
819+3948	3/4	50	85	630	1 / 20	13.5	0.34
822+3952	13/16	50	90	670	1 / 20	14.5	0.34
822+3956	7/8	50	90	690	1 / 20	15.0	0.34
822+3960	15/16	50	90	700	1 / 20	15.0	0.34
822+3964	1	50	90	720	1 / 20	15.5	0.34
827+3968	1-1/16	52	95	900	1 / 20	19.0	0.34
827+3972	1-1/8	52	95	920	1 / 20	19.5	0.34
827+3976	1-3/16	52	95	940	1 / 20	19.5	0.34
827+3980	1-1/4	52	95	960	1 / 20	20.0	0.34
832+3984	1-5/16	52	100	1120	1 / 20	23.5	0.34
832+3988	1-3/8	52	100	1150	1 / 20	24.0	0.34

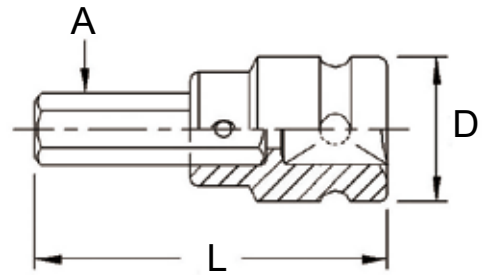

## BS-816H 16 Piece 1" Dr. Metric Hex Bit Socket Set

Item No.	Size	Item No.	Size
<b>Hex Bit:</b>			
2916	19H x 16mm	2927	27H x 27mm
2917	19H x 17mm	2930	27H x 30mm
2918	19H x 18mm	2932	27H x 32mm
2919	19H x 19mm	2933	32H x 33mm
2922	22H x 22mm	2936	32H x 36mm
2924	22H x 24mm		

### Accessory:

819+	1" Dr. 19H Bit Holder	827+	1" Dr. 27H Bit Holder
822+	1" Dr. 22H Bit Holder	832+	1" Dr. 32H Bit Holder
570740	4mm Hex Key Wrench		
	Blow Case		

5250 g 4 sets / 22 Kgs / 0.85 CUFT



## BS-817H 17 Piece 1" Dr. SAE Hex Bit Socket Set

Item No.	Size	Item No.	Size
<b>Hex Bit:</b>			
3940	19H x 5/8"	3968	27H x 1-1/16"
3948	19H x 3/4"	3972	27H x 1-1/8"
3952	22H x 13/16"	3976	27H x 1-3/16"
3956	22H x 7/8"	3980	27H x 1-1/4"
3960	22H x 15/16"	3984	32H x 1-5/16"
3964	22H x 1"	3988	32H x 1-3/8"

### Accessory:

819+	1" Dr. 19H Bit Holder	827+	1" Dr. 27H Bit Holder
822+	1" Dr. 22H Bit Holder	832+	1" Dr. 32H Bit Holder
570740	4mm Hex Key Wrench		
	Blow Case		

5750 g 4 sets / 24 Kgs / 0.85 CUFT





3/4

1"

# Head Drivers

## 1" Dr. Metric Hex Head Drivers

Item No.	A mm	D mm	Length mm	Weight g	PCS inner/ctn	G.W. KGS	CUFT
849819	19	52	98	680	1 / 20	14.5	0.34
849821	21	52	98	720	1 / 20	15.5	0.34
849822	22	52	98	740	1 / 20	16.0	0.34
849824	24	52	98	770	1 / 20	16.5	0.34
849826	26	52	98	800	1 / 20	17.0	0.34
849827	27	52	98	830	1 / 20	17.5	0.34
849830	30	52	98	890	1 / 20	19.0	0.34
849832	32	52	98	930	1 / 20	19.5	0.34
849833	33	52	98	960	1 / 20	20.0	0.34
849836	36	52	98	1020	1 / 20	21.5	0.34

## 1" Dr. SAE Hex Head Drivers

Item No.	A inch	D mm	Length mm	Weight g	PCS inner/ctn	G.W. KGS	CUFT
869824	3/4	52	98	680	1 / 20	14.5	0.34
869826	13/16	52	98	700	1 / 20	15.0	0.34
869828	7/8	52	98	730	1 / 20	15.5	0.34
869830	15/16	52	98	750	1 / 20	16.0	0.34
869832	1	52	98	800	1 / 20	17.0	0.34
869834	1-1/16	52	98	830	1 / 20	17.5	0.34
869836	1-1/8	52	98	850	1 / 20	18.0	0.34
869838	1-3/16	52	98	900	1 / 20	19.0	0.34
869840	1-1/4	52	98	930	1 / 20	19.5	0.34
869842	1-5/16	52	98	960	1 / 20	20.0	0.34
869844	1-3/8	52	98	1020	1 / 20	21.5	0.34

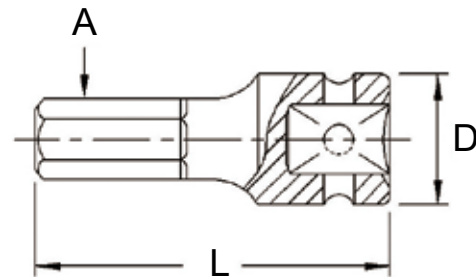

## BS-6817H 17 Piece 3/4" & 1" Dr. Metric Hex Bit Socket Set

Item No.	Size	Item No.	Size
<b>Hex Bit:</b>			
2914	19H x 14mm	2924	22H x 24mm
2916	19H x 16mm	2927	27H x 27mm
2917	19H x 17mm	2930	27H x 30mm
2918	19H x 18mm	2932	27H x 32mm
2919	19H x 19mm	2933	32H x 33mm
2922	22H x 22mm	2936	32H x 36mm
<b>Accessory:</b>			
619+	3/4" Dr. 19H Bit Holder	827+	1" Dr. 27H Bit Holder
622+	3/4" Dr. 22H Bit Holder	832+	1" Dr. 32H Bit Holder
570740	4mm Hex Key Wrench		
Blow Case			

5000 g 4 sets / 21 Kgs / 0.85 CUFT



## BS-6818H 18 Piece 3/4" & 1" Dr. SAE Hex Bit Socket Set

Item No.	Size	Item No.	Size
<b>Hex Bit:</b>			
3936	19H x 9/16"	3968	27H x 1-1/16"
3940	19H x 5/8"	3972	27H x 1-1/8"
3948	19H x 3/4"	3976	27H x 1-3/16"
3952	22H x 13/16"	3980	27H x 1-1/4"
3956	22H x 7/8"	3984	32H x 1-5/16"
3960	22H x 15/16"	3988	32H x 1-3/8"
3964	22H x 1"		
<b>Accessory:</b>			
619+	3/4" Dr. 19H Bit Holder	827+	1" Dr. 27H Bit Holder
622+	3/4" Dr. 22H Bit Holder	832+	1" Dr. 32H Bit Holder
570740	4mm Hex Key Wrench		
Blow Case			

5500 g 4 sets / 23 Kgs / 0.85 CUFT



# Head Drivers

1 1/2

## 1-1/2" Dr. Metric Hex Bit Sockets

Item No.	A mm	D mm	Length mm	Weight g	PCS inner/ctn	G.W. KGS	CUFT
941+3027	27	86	110	2610	1 / 6	16.5	0.34
941+3030	30	86	110	2640	1 / 6	16.5	0.34
941+3032	32	86	110	2660	1 / 6	17.0	0.34
941+3036	36	86	110	2710	1 / 6	17.0	0.34
941+3038	38	86	110	2740	1 / 6	17.5	0.34
941+3041	41	86	115	2870	1 / 6	18.0	0.34
941+3046	46	86	115	2940	1 / 6	18.5	0.34
941+3050	50	86	120	3120	1 / 6	20.0	0.34
941+3055	55	86	125	3360	1 / 6	21.0	0.34
941+3060	60	86	130	3660	1 / 6	23.0	0.34



## Metric Hex Impact Screwdriver Bits

Item No.	Size mm	Hex Shank	Length mm	Weight g	PCS inner/ctn	G.W. KGS	CUFT
2914	14	19mm	45	80	10 / 140	12.5	0.44
2916	16	19mm	45	95	10 / 140	14.5	0.44
2917	17	19mm	45	100	10 / 140	15.0	0.44
2918	18	19mm	45	110	10 / 140	16.5	0.44
2919	19	19mm	45	120	10 / 140	18.0	0.44
2922	22	22mm	50	160	10 / 140	23.5	0.44
2924	24	22mm	50	180	10 / 120	22.5	0.52
2927	27	27mm	55	270	10 / 60	17.5	0.45
2930	30	27mm	55	300	10 / 60	19.0	0.45
2932	32	27mm	55	330	10 / 60	21.0	0.45
2933	33	32mm	60	430	5 / 50	22.5	0.34
2936	36	32mm	60	480	5 / 50	25.0	0.34
3027	27	41mm	60	510	1 / 30	15.0	0.38
3030	30	41mm	60	540	1 / 30	17.0	0.38
3032	32	41mm	60	560	1 / 30	18.0	0.38
3036	36	41mm	60	610	1 / 30	19.0	0.38
3038	38	41mm	60	640	1 / 30	20.0	0.38
3041	41	41mm	65	770	1 / 20	16.5	0.39
3046	46	41mm	65	840	1 / 20	18.0	0.39
3050	50	41mm	70	1020	1 / 20	21.5	0.39
3055	55	41mm	75	1260	1 / 10	13.5	0.31
3060	60	41mm	80	1560	1 / 10	16.5	0.31

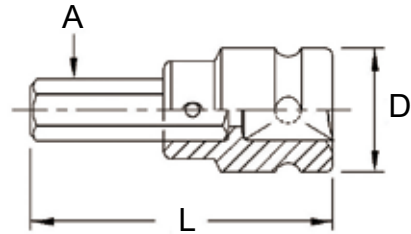

## SAE Hex Impact Screwdriver Bits

Item No.	Size inch	Hex Shank	Length mm	Weight g	PCS inner/ctn	G.W. KGS	CUFT
3936	9/16	19mm	45	90	10 / 140	13.5	0.44
3940	5/8	19mm	45	95	10 / 140	14.5	0.44
3948	3/4	19mm	45	110	10 / 140	16.5	0.44
3952	13/16	22mm	50	150	10 / 140	22.0	0.44
3956	7/8	22mm	50	170	10 / 140	25.0	0.44
3960	15/16	22mm	50	180	10 / 120	22.5	0.52
3964	1"	22mm	50	200	10 / 120	25.0	0.52
3968	1-1/16"	27mm	55	270	10 / 60	17.0	0.45
3972	1-1/8"	27mm	55	290	10 / 60	18.5	0.45
3976	1-3/16"	27mm	55	310	10 / 60	19.5	0.45
3980	1-1/4	27mm	55	330	10 / 60	21.0	0.45
3984	1-5/16	32mm	60	430	5 / 50	22.5	0.34
3988	1-3/8	32mm	60	460	5 / 50	24.0	0.34



Bit Sockets

1/4

# Slotted & Philips Bit Sockets

## Slotted Bit Sockets

Item No.	Size mm	Length mm	Weight g	PCS		G.W. KGS	CUFT 
				inner/ctn			
208+1130	0.5 x 3.0	45	20	20 / 600	13.0	0.38	
208+1140	0.6 x 4.0	45	20	20 / 600	13.0	0.38	
208+1150	0.8 x 5.0	45	20	20 / 600	13.0	0.38	
208+1155	0.8 x 5.5	45	20	20 / 600	13.0	0.38	
208+1160	1.0 x 6.0	45	20	20 / 600	13.0	0.38	
208+1170	1.2 x 7.0	45	20	20 / 600	13.0	0.38	
208+1330	0.5 x 3.0	70	25	40 / 480	13.0	0.30	
208+1340	0.6 x 4.0	70	25	40 / 480	13.0	0.30	
208+1350	0.8 x 5.0	70	25	40 / 480	13.0	0.30	
208+1360	1.0 x 6.0	70	30	40 / 480	15.5	0.30	
208+1530	0.5 x 3.0	100	35	30 / 360	14.0	0.30	
208+1540	0.6 x 4.0	100	35	30 / 360	14.0	0.30	
208+1550	0.8 x 5.0	100	35	30 / 360	14.0	0.30	
208+1560	1.0 x 6.0	100	35	30 / 360	14.0	0.30	
208+1630	0.5 x 3.0	140	45	10 / 150	8.0	0.52	
208+1640	0.6 x 4.0	140	45	10 / 150	8.0	0.52	
208+1650	0.8 x 5.0	140	45	10 / 150	8.0	0.52	
208+1660	1.0 x 6.0	140	45	10 / 150	8.0	0.52	

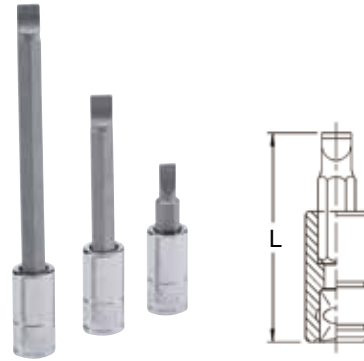

## Philips Bit Sockets

Item No.	Size	Length mm	Weight g	PCS		G.W. KGS	CUFT 
				inner/ctn			
208+1100	#0	45	20	20 / 600	13.0	0.38	
208+1101	#1	45	20	20 / 600	13.0	0.38	
208+1102	#2	45	20	20 / 600	13.0	0.38	
208+1103	#3	45	20	20 / 600	13.0	0.38	
208+1301	#1	70	25	40 / 480	13.0	0.30	
208+1302	#2	70	30	40 / 480	15.5	0.30	
208+1303	#3	70	30	40 / 480	15.5	0.30	
208+1501	#1	100	35	30 / 360	14.0	0.30	
208+1502	#2	100	35	30 / 360	14.0	0.30	
208+1503	#3	100	35	30 / 360	14.0	0.30	
208+1601	#1	140	45	10 / 150	8.0	0.52	
208+1602	#2	140	45	10 / 150	8.0	0.52	
208+1603	#3	140	45	10 / 150	8.0	0.52	

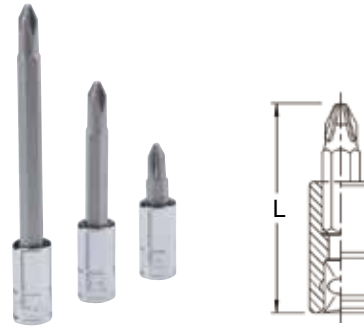

## BS-214PL 14 Piece 1/4" Dr. Slotted & Philips Bit Socket Set

Item No.	Size	Item No.	Size
<b>1/4" Dr. Bit Socket, 45mmL:</b>			
208+1130	0.5 x 3.0mm	208+1101	#1 Philips
208+1140	0.6 x 4.0mm	208+1102	#2 Philips
208+1150	0.8 x 5.0mm	208+1103	#3 Philips
208+1160	1.0 x 6.0mm		
<b>1/4" Dr. Bit Socket, 140mmL:</b>			
208+1630	0.5 x 3.0mm	208+1601	#1 Philips
208+1640	0.6 x 4.0mm	208+1602	#2 Philips
208+1650	0.8 x 5.0mm	208+1603	#3 Philips
208+1660	1.0 x 6.0mm		Blow Case

 800 g

 10 sets / 9 Kgs / 0.82 CUFT



# Hex & Wobble Hex Bit Sockets

1/4

## Metric Hex Bit Sockets

Item No.	Size mm	Length mm	Weight g	PCS		G.W. KGS	CUFT 
				inner/ctn			
208+2122	2	45	20	20 / 600	13.0	0.38	
208+2125	2.5	45	20	20 / 600	13.0	0.38	
208+2133	3	45	20	20 / 600	13.0	0.38	
208+2134	4	45	20	20 / 600	13.0	0.38	
208+2135	5	45	20	20 / 600	13.0	0.38	
208+2136	6	45	20	20 / 600	13.0	0.38	
208+2137	7	45	20	20 / 600	14.5	0.38	
208+2138	8	45	25	20 / 600	15.5	0.38	
208+2322	2	70	25	40 / 480	13.0	0.30	
208+2325	2.5	70	25	40 / 480	13.0	0.30	
208+2333	3	70	30	40 / 480	15.5	0.30	
208+2334	4	70	30	40 / 480	15.5	0.30	
208+2335	5	70	30	40 / 480	15.5	0.30	
208+2336	6	70	30	40 / 480	15.5	0.30	
208+2522	2	100	35	30 / 360	14.0	0.30	
208+2525	2.5	100	35	30 / 360	14.0	0.30	
208+2533	3	100	35	30 / 360	14.0	0.30	
208+2534	4	100	35	30 / 360	14.0	0.30	
208+2535	5	100	35	30 / 360	14.0	0.30	
208+2536	6	100	40	30 / 360	15.5	0.30	
208+2622	2	140	45	10 / 150	8.0	0.52	
208+2625	2.5	140	45	10 / 150	8.0	0.52	
208+2633	3	140	45	10 / 150	8.0	0.52	
208+2634	4	140	45	10 / 150	8.0	0.52	
208+2635	5	140	45	10 / 150	8.0	0.52	
208+2636	6	140	45	10 / 150	8.0	0.52	



## Metric Wobble Hex Bit Sockets

Item No.	Size mm	Length mm	Weight g	PCS		G.W. KGS	CUFT 
				inner/ctn			
208+4133	3	45	20	20 / 600	13.0	0.38	
208+4134	4	45	20	20 / 600	13.0	0.38	
208+4135	5	45	20	20 / 600	13.0	0.38	
208+4136	6	45	20	20 / 600	13.0	0.38	
208+4333	3	70	30	40 / 480	15.5	0.30	
208+4334	4	70	30	40 / 480	15.5	0.30	
208+4335	5	70	30	40 / 480	15.5	0.30	
208+4336	6	70	30	40 / 480	15.5	0.30	
208+4533	3	100	35	30 / 360	14.0	0.30	
208+4534	4	100	35	30 / 360	14.0	0.30	
208+4535	5	100	35	30 / 360	14.0	0.30	
208+4536	6	100	35	30 / 360	14.0	0.30	
208+4633	3	140	45	10 / 150	8.0	0.52	
208+4634	4	140	45	10 / 150	8.0	0.52	
208+4635	5	140	45	10 / 150	8.0	0.52	
208+4636	6	140	45	10 / 150	8.0	0.52	

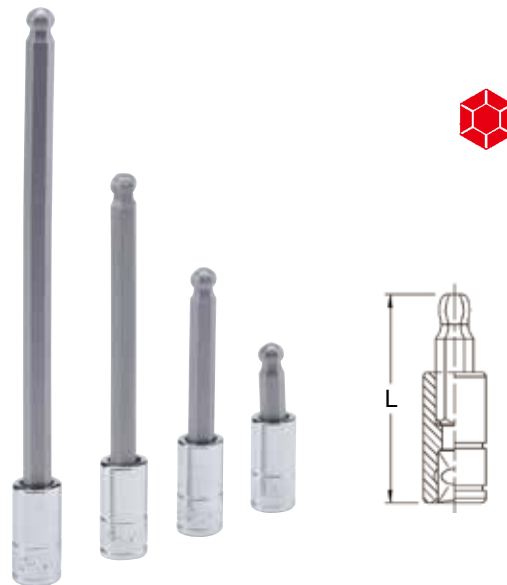

Bit Sockets

1/4

# Hex & Wobble Hex Bit Sockets

## SAE Hex Bit Sockets

Item No.	Size inch	Length mm	Weight g	PCS inner/ctn	G.W. KGS	CUFT
208+3104	1/16	45	20	20 / 600	13.0	0.38
208+3105	5/64	45	20	20 / 600	13.0	0.38
208+3106	3/32	45	20	20 / 600	13.0	0.38
208+3107	7/64	45	20	20 / 600	13.0	0.38
208+3108	1/8	45	20	20 / 600	13.0	0.38
208+3110	5/32	45	20	20 / 600	13.0	0.38
208+3112	3/16	45	20	20 / 600	13.0	0.38
208+3114	7/32	45	20	20 / 600	13.0	0.38
208+3116	1/4	45	25	20 / 600	16.0	0.38
208+3304	1/16	70	25	40 / 480	13.0	0.30
208+3305	5/64	70	25	40 / 480	13.0	0.30
208+3306	3/32	70	25	40 / 480	13.0	0.30
208+3307	7/64	70	25	40 / 480	13.0	0.30
208+3308	1/8	70	30	40 / 480	15.5	0.30
208+3310	5/32	70	30	40 / 480	15.5	0.30
208+3312	3/16	70	30	40 / 480	15.5	0.30
208+3314	7/32	70	30	40 / 480	15.5	0.30
208+3316	1/4	70	30	40 / 480	15.5	0.30
208+3504	1/16	100	35	30 / 360	14.0	0.30
208+3505	5/64	100	35	30 / 360	14.0	0.30
208+3506	3/32	100	35	30 / 360	14.0	0.30
208+3507	7/64	100	35	30 / 360	14.0	0.30
208+3508	1/8	100	35	30 / 360	14.0	0.30
208+3510	5/32	100	35	30 / 360	14.0	0.30
208+3512	3/16	100	35	30 / 360	14.0	0.30
208+3514	7/32	100	40	30 / 360	15.5	0.30
208+3516	1/4	100	40	30 / 360	15.5	0.30
208+3604	1/16	140	45	10 / 150	8.0	0.52
208+3605	5/64	140	45	10 / 150	8.0	0.52
208+3606	3/32	140	45	10 / 150	8.0	0.52
208+3607	7/64	140	45	10 / 150	8.0	0.52
208+3608	1/8	140	45	10 / 150	8.0	0.52
208+3610	5/32	140	45	10 / 150	8.0	0.52
208+3612	3/16	140	45	10 / 150	8.0	0.52
208+3614	7/32	140	45	10 / 150	8.0	0.52
208+3616	1/4	140	45	10 / 150	8.0	0.52

## SAE Wobble Hex Bit Sockets

Item No.	Size inch	Length mm	Weight g	PCS inner/ctn	G.W. KGS	CUFT
208+5108	1/8	45	20	20 / 600	13.0	0.38
208+5110	5/32	45	20	20 / 600	13.0	0.38
208+5112	3/16	45	20	20 / 600	13.0	0.38
208+5114	7/32	45	20	20 / 600	13.0	0.38
208+5116	1/4	45	20	20 / 600	13.0	0.38
208+5308	1/8	70	30	40 / 480	15.5	0.30
208+5310	5/32	70	30	40 / 480	15.5	0.30
208+5312	3/16	70	30	40 / 480	15.5	0.30
208+5314	7/32	70	30	40 / 480	15.5	0.30
208+5316	1/4	70	30	40 / 480	15.5	0.30
208+5508	1/8	100	35	30 / 360	14.0	0.30
208+5510	5/32	100	35	30 / 360	14.0	0.30
208+5512	3/16	100	35	30 / 360	14.0	0.30
208+5514	7/32	100	35	30 / 360	14.0	0.30
208+5516	1/4	100	40	30 / 360	15.5	0.30
208+5608	1/8	140	45	10 / 150	8.0	0.52
208+5610	5/32	140	45	10 / 150	8.0	0.52
208+5612	3/16	140	45	10 / 150	8.0	0.52
208+5614	7/32	140	45	10 / 150	8.0	0.52
208+5616	1/4	140	45	10 / 150	8.0	0.52

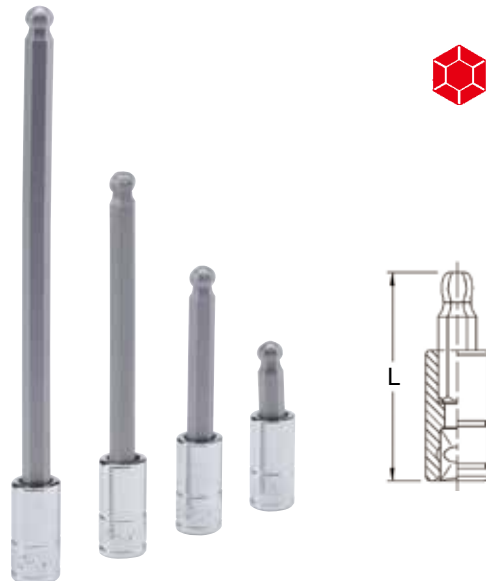
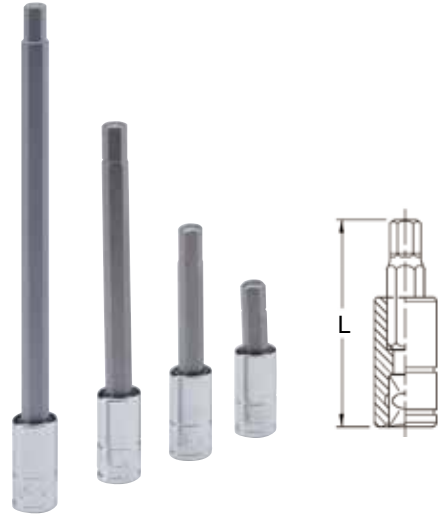

# Star & Ribe Bit Sockets

1/4

## Star Bit Sockets

Item No.	Size	Length mm	Weight g	PCS		G.W. KGS	CUFT
				inner	ctn		
208+6106	T-6	45	20	20	600	13.0	0.38
208+6107	T-7	45	20	20	600	13.0	0.38
208+6108	T-8	45	20	20	600	13.0	0.38
208+6109	T-9	45	20	20	600	13.0	0.38
208+6110	T-10	45	20	20	600	13.0	0.38
208+6115	T-15	45	20	20	600	13.0	0.38
208+6120	T-20	45	20	20	600	13.0	0.38
208+6125	T-25	45	20	20	600	13.0	0.38
208+6127	T-27	45	20	20	600	13.0	0.38
208+6130	T-30	45	20	20	600	13.0	0.38
208+6140	T-40	45	25	20	600	16.0	0.38
208+6306	T-6	70	25	40	480	13.0	0.30
208+6307	T-7	70	25	40	480	13.0	0.30
208+6308	T-8	70	25	40	480	13.0	0.30
208+6309	T-9	70	25	40	480	13.0	0.30
208+6310	T-10	70	25	40	480	13.0	0.30
208+6315	T-15	70	30	40	480	15.5	0.30
208+6320	T-20	70	30	40	480	15.5	0.30
208+6325	T-25	70	30	40	480	15.5	0.30
208+6327	T-27	70	30	40	480	15.5	0.30
208+6330	T-30	70	30	40	480	15.5	0.30
208+6340	T-40	70	30	40	480	15.5	0.30
208+6506	T-6	100	35	30	360	14.0	0.30
208+6507	T-7	100	35	30	360	14.0	0.30
208+6508	T-8	100	35	30	360	14.0	0.30
208+6509	T-9	100	35	30	360	14.0	0.30
208+6510	T-10	100	35	30	360	14.0	0.30
208+6515	T-15	100	35	30	360	14.0	0.30
208+6520	T-20	100	35	30	360	14.0	0.30
208+6525	T-25	100	35	30	360	14.0	0.30
208+6527	T-27	100	35	30	360	14.0	0.30
208+6530	T-30	100	35	30	360	14.0	0.30
208+6540	T-40	100	40	30	360	15.5	0.30
208+6606	T-6	140	45	10	150	8.0	0.52
208+6607	T-7	140	45	10	150	8.0	0.52
208+6608	T-8	140	45	10	150	8.0	0.52
208+6609	T-9	140	45	10	150	8.0	0.52
208+6610	T-10	140	45	10	150	8.0	0.52
208+6615	T-15	140	45	10	150	8.0	0.52
208+6620	T-20	140	45	10	150	8.0	0.52
208+6625	T-25	140	45	10	150	8.0	0.52
208+6627	T-27	140	45	10	150	8.0	0.52
208+6630	T-30	140	45	10	150	8.0	0.52
208+6640	T-40	140	45	10	150	8.0	0.52

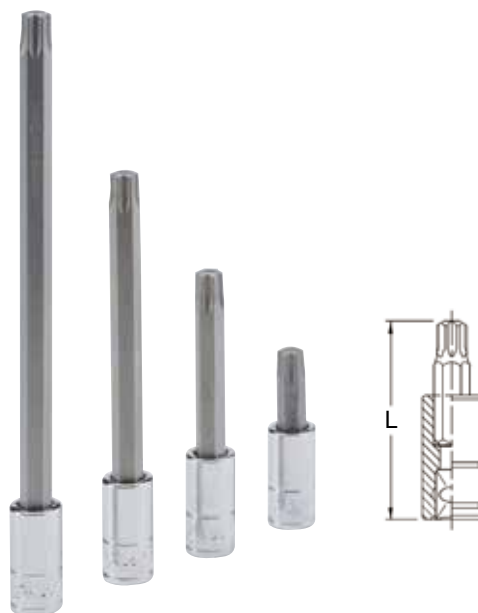

## Ribe Bit Sockets

Item No.	Size	Length mm	Weight g	PCS		G.W. KGS	CUFT
				inner	ctn		
208+9004	M4	45	20	20	600	13.0	0.38
208+9005	M5	45	20	20	600	13.0	0.38
208+9006	M6	45	20	20	600	13.0	0.38
208+9204	M4	70	25	40	480	13.0	0.30
208+9205	M5	70	30	40	480	15.5	0.30
208+9206	M6	70	30	40	480	15.5	0.30
208+9404	M4	100	35	30	360	14.0	0.30
208+9405	M5	100	35	30	360	14.0	0.30
208+9406	M6	100	35	30	360	14.0	0.30

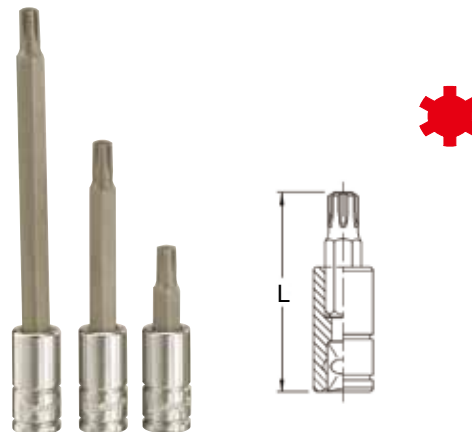

Bit Sockets



# Tamperproof Star & Triple Square Bit Sockets

## Tamperproof Star Bit Sockets

Item No.	Size	Length mm	Weight g	PCS		G.W. KGS	CUFT 
				inner/ctn			
208+7107	T-7	45	20	20 / 600	13.0	0.38	
208+7108	T-8	45	20	20 / 600	13.0	0.38	
208+7109	T-9	45	20	20 / 600	13.0	0.38	
208+7110	T-10	45	20	20 / 600	13.0	0.38	
208+7115	T-15	45	20	20 / 600	13.0	0.38	
208+7120	T-20	45	20	20 / 600	13.0	0.38	
208+7125	T-25	45	20	20 / 600	13.0	0.38	
208+7127	T-27	45	20	20 / 600	13.0	0.38	
208+7130	T-30	45	20	20 / 600	13.0	0.38	
208+7140	T-40	45	20	20 / 600	13.0	0.38	
208+7307	T-7	70	25	40 / 480	13.0	0.30	
208+7308	T-8	70	25	40 / 480	13.0	0.30	
208+7309	T-9	70	25	40 / 480	13.0	0.30	
208+7310	T-10	70	25	40 / 480	13.0	0.30	
208+7315	T-15	70	30	40 / 480	15.5	0.30	
208+7320	T-20	70	30	40 / 480	15.5	0.30	
208+7325	T-25	70	30	40 / 480	15.5	0.30	
208+7327	T-27	70	30	40 / 480	15.5	0.30	
208+7330	T-30	70	30	40 / 480	15.5	0.30	
208+7340	T-40	70	30	40 / 480	15.5	0.30	
208+7507	T-7	100	35	30 / 360	14.0	0.30	
208+7508	T-8	100	35	30 / 360	14.0	0.30	
208+7509	T-9	100	35	30 / 360	14.0	0.30	
208+7510	T-10	100	35	30 / 360	14.0	0.30	
208+7515	T-15	100	35	30 / 360	14.0	0.30	
208+7520	T-20	100	35	30 / 360	14.0	0.30	
208+7525	T-25	100	35	30 / 360	14.0	0.30	
208+7527	T-27	100	35	30 / 360	14.0	0.30	
208+7530	T-30	100	35	30 / 360	14.0	0.30	
208+7540	T-40	100	40	30 / 360	15.5	0.30	
208+7607	T-7	140	45	10 / 150	8.0	0.52	
208+7608	T-8	140	45	10 / 150	8.0	0.52	
208+7609	T-9	140	45	10 / 150	8.0	0.52	
208+7610	T-10	140	45	10 / 150	8.0	0.52	
208+7615	T-15	140	45	10 / 150	8.0	0.52	
208+7620	T-20	140	45	10 / 150	8.0	0.52	
208+7625	T-25	140	45	10 / 150	8.0	0.52	
208+7627	T-27	140	45	10 / 150	8.0	0.52	
208+7630	T-30	140	45	10 / 150	8.0	0.52	
208+7640	T-40	140	45	10 / 150	8.0	0.52	

## Triple Square Bit Sockets

Item No.	Size	Length mm	Weight g	PCS		G.W. KGS	CUFT 
				inner/ctn			
208+8104	M4	45	20	20 / 600	13.0	0.38	
208+8105	M5	45	20	20 / 600	13.0	0.38	
208+8106	M6	45	20	20 / 600	13.0	0.38	
208+8304	M4	70	25	40 / 480	13.0	0.30	
208+8305	M5	70	30	40 / 480	15.5	0.30	
208+8306	M6	70	30	40 / 480	15.5	0.30	
208+8504	M4	100	35	30 / 360	14.0	0.30	
208+8505	M5	100	35	30 / 360	14.0	0.30	
208+8506	M6	100	35	30 / 360	14.0	0.30	
208+8604	M4	140	45	10 / 150	8.0	0.52	
208+8605	M5	140	45	10 / 150	8.0	0.52	
208+8606	M6	140	45	10 / 150	8.0	0.52	



# Pentacle & Spanner Bit Sockets

1/4

## Pentacle Bit Sockets

Item No.	Size	Length mm	Weight g	PCS	G.W. KGS	CUFT
				inner/ctn		
208+5008	T-8	45	20	20 / 600	13.0	0.38
208+5010	T-10	45	20	20 / 600	13.0	0.38
208+5015	T-15	45	20	20 / 600	13.0	0.38
208+5020	T-20	45	20	20 / 600	13.0	0.38
208+5025	T-25	45	20	20 / 600	13.0	0.38
208+5027	T-27	45	20	20 / 600	13.0	0.38
208+5030	T-30	45	20	20 / 600	13.0	0.38
208+5208	T-8	70	25	40 / 480	13.0	0.30
208+5210	T-10	70	25	40 / 480	13.0	0.30
208+5215	T-15	70	30	40 / 480	15.5	0.30
208+5220	T-20	70	30	40 / 480	15.5	0.30
208+5225	T-25	70	30	40 / 480	15.5	0.30
208+5227	T-27	70	30	40 / 480	15.5	0.30
208+5230	T-30	70	30	40 / 480	15.5	0.30
208+5408	T-8	100	35	30 / 360	14.0	0.30
208+5410	T-10	100	35	30 / 360	14.0	0.30
208+5415	T-15	100	35	30 / 360	14.0	0.30
208+5420	T-20	100	35	30 / 360	14.0	0.30
208+5425	T-25	100	35	30 / 360	14.0	0.30
208+5427	T-27	100	35	30 / 360	14.0	0.30
208+5430	T-30	100	35	30 / 360	14.0	0.30

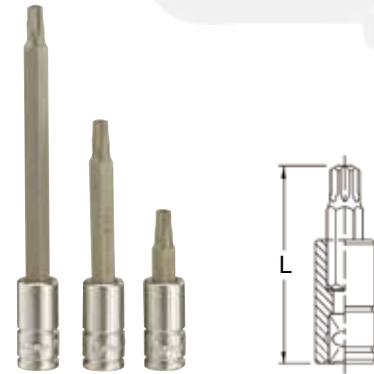

## Spanner Bit Sockets

Item No.	Size	Length mm	Weight g	PCS	G.W. KGS	CUFT
				inner/ctn		
208+9054	SP4	45	20	20 / 600	13.0	0.38
208+9056	SP6	45	20	20 / 600	13.0	0.38
208+9058	SP8	45	20	20 / 600	13.0	0.38
208+9060	SP10	45	20	20 / 600	14.0	0.38
208+9062	SP12	45	20	20 / 600	14.0	0.38
208+9064	SP14	45	25	20 / 600	14.5	0.38
208+9254	SP4	70	25	40 / 480	13.0	0.30
208+9256	SP6	70	25	40 / 480	13.0	0.30
208+9258	SP8	70	30	40 / 480	15.0	0.30
208+9260	SP10	70	30	40 / 480	15.0	0.30
208+9262	SP12	70	30	40 / 480	15.0	0.30
208+9264	SP14	70	35	40 / 480	18.0	0.30

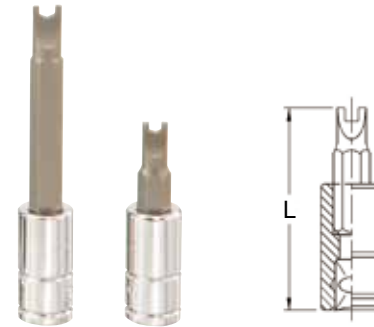

## BS-206S 6 Piece 1/4" Dr. Spanner Bit Socket Set

Item No.	Size	Item No.	Size
<b>1/4" Dr. Spanner Bit Socket, 45mmL:</b>			
208+9054	SP4	208+9060	SP10
208+9056	SP6	208+9062	SP12
208+9058	SP8	208+9064	SP14

Socket Holder

160 g 10x6 60 sets / 11 Kgs / 0.92 CUFT



Bit Sockets



3/8

# Slotted & Philips Bit Sockets

## Slotted Bit Sockets

Item No.	Size mm	Length mm	Weight g	PCS		G.W. KGS	CUFT 
				inner	ctn		
308+1140	0.6 x 4.0	50	40	20	240	11.0	0.30
308+1150	0.8 x 5.0	50	40	20	240	11.0	0.30
308+1160	1.0 x 6.0	50	40	20	240	11.0	0.30
310+1280	1.2 x 8.0	50	50	20	240	13.0	0.30
310+1290	1.6 x 9.0	50	50	20	240	13.0	0.30
308+1540	0.6 x 4.0	110	55	10	200	12.0	0.59
308+1550	0.8 x 5.0	110	55	10	200	12.0	0.59
308+1560	1.0 x 6.0	110	55	10	200	12.0	0.59
310+1580	1.2 x 8.0	110	70	10	200	15.0	0.59
310+1590	1.6 x 9.0	110	70	10	200	15.0	0.59
308+1640	0.6 x 4.0	140	65	10	150	11.0	0.52
308+1650	0.8 x 5.0	140	65	10	150	11.0	0.52
308+1660	1.0 x 6.0	140	65	10	150	11.0	0.52
310+1680	1.2 x 8.0	140	85	10	150	14.0	0.52
310+1690	1.6 x 9.0	140	85	10	150	14.0	0.52
308+1740	0.6 x 4.0	180	75	10	100	8.0	0.62
308+1750	0.8 x 5.0	180	75	10	100	8.0	0.62
308+1760	1.0 x 6.0	180	75	10	100	8.0	0.62
310+1780	1.2 x 8.0	180	100	10	100	10.5	0.62
310+1790	1.6 x 9.0	180	100	10	100	10.5	0.62
308+1840	0.6 x 4.0	220	85	10	100	10.0	0.62
308+1850	0.8 x 5.0	220	85	10	100	10.0	0.62
308+1860	1.0 x 6.0	220	85	10	100	10.0	0.62
310+1880	1.2 x 8.0	220	120	10	100	13.0	0.62
310+1890	1.6 x 9.0	220	120	10	100	13.0	0.62

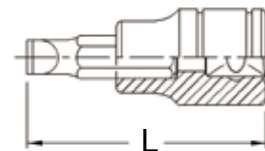

## Philips Bit Sockets

Item No.	Size	Length mm	Weight g	PCS		G.W. KGS	CUFT 
				inner	ctn		
308+1101	#1	50	40	20	240	11.0	0.30
308+1102	#2	50	40	20	240	11.0	0.30
308+1103	#3	50	40	20	240	11.0	0.30
310+1124	#4	50	45	20	240	12.0	0.30
308+1501	#1	110	55	10	200	12.0	0.59
308+1502	#2	110	55	10	200	12.0	0.59
308+1503	#3	110	55	10	200	12.0	0.59
310+1504	#4	110	70	10	200	15.0	0.59
308+1601	#1	140	65	10	150	11.0	0.52
308+1602	#2	140	65	10	150	11.0	0.52
308+1603	#3	140	65	10	150	11.0	0.52
310+1604	#4	140	85	10	150	14.0	0.52
308+1701	#1	180	75	10	100	8.0	0.62
308+1702	#2	180	75	10	100	8.0	0.62
308+1703	#3	180	75	10	100	8.0	0.62
310+1704	#4	180	100	10	100	10.5	0.62
308+1801	#1	220	85	10	100	10.0	0.62
308+1802	#2	220	85	10	100	10.0	0.62
308+1803	#3	220	85	10	100	10.0	0.62
310+1804	#4	220	120	10	100	13.0	0.62

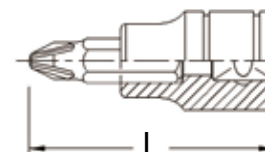

# Hex Bit Sockets

3/8

## Metric Hex Bit Sockets

Item No.	Size mm	Length mm	Weight g	PCS	G.W. KGS	CUFT
				inner/ctn		
308+2133	3	50	40	20 / 240	10.0	0.30
308+2134	4	50	40	20 / 240	10.5	0.30
308+2135	5	50	40	20 / 240	10.5	0.30
308+2136	6	50	40	20 / 240	10.5	0.30
310+2147	7	50	45	20 / 240	12.5	0.30
310+2148	8	50	50	20 / 240	12.5	0.30
339+2149	9	50	60	20 / 240	15.5	0.30
340+2150	10	50	65	20 / 240	17.5	0.30
341+2151	11	50	75	20 / 240	19.0	0.30
342+2152	12	50	80	20 / 240	20.0	0.30
308+2533	3	110	55	10 / 200	12.0	0.59
308+2534	4	110	55	10 / 200	12.0	0.59
308+2535	5	110	55	10 / 200	12.0	0.59
308+2536	6	110	55	10 / 200	12.0	0.59
310+2547	7	110	70	10 / 200	15.0	0.59
310+2548	8	110	70	10 / 200	15.5	0.59
339+2549	9	110	90	10 / 200	19.0	0.59
340+2550	10	110	100	10 / 200	22.0	0.59
341+2551	11	110	120	10 / 200	25.0	0.59
342+2552	12	110	130	10 / 200	27.5	0.59
308+2633	3	140	65	10 / 150	10.5	0.52
308+2634	4	140	65	10 / 150	10.5	0.52
308+2635	5	140	65	10 / 150	11.0	0.52
308+2636	6	140	65	10 / 150	11.0	0.52
310+2647	7	140	85	10 / 150	14.0	0.52
310+2648	8	140	90	10 / 150	14.0	0.52
339+2649	9	140	110	10 / 150	18.5	0.52
340+2650	10	140	130	10 / 150	20.5	0.52
341+2651	11	140	150	10 / 150	24.5	0.52
342+2652	12	140	170	10 / 150	26.5	0.52
308+2733	3	180	75	10 / 100	8.0	0.62
308+2734	4	180	75	10 / 100	8.0	0.62
308+2735	5	180	75	10 / 100	8.0	0.62
308+2736	6	180	75	10 / 100	8.0	0.62
310+2747	7	180	100	10 / 100	10.5	0.62
310+2748	8	180	100	10 / 100	10.5	0.62
339+2749	9	180	130	10 / 100	14.0	0.62
340+2750	10	180	150	10 / 100	15.5	0.62
341+2751	11	180	180	10 / 100	18.5	0.62
342+2752	12	180	200	10 / 100	20.5	0.62
308+2836	6	220	85	10 / 100	9.5	0.62
310+2847	7	220	120	10 / 100	13.0	0.62
310+2848	8	220	120	10 / 100	13.0	0.62
339+2849	9	220	160	10 / 100	17.0	0.62
340+2850	10	220	180	10 / 100	19.0	0.62
341+2851	11	220	220	10 / 100	23.0	0.62
342+2852	12	220	250	10 / 100	26.0	0.62

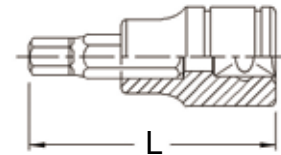

### BS-310HM 10 Piece 3/8" Dr. Metric Hex Bit Socket Set

Item No.	Size	Item No.	Size
<b>3/8" Dr. Hex Bit Socket, 50mmL:</b>			
308+2133	3mm	310+2148	8mm
308+2134	4mm	339+2149	9mm
308+2135	5mm	340+2150	10mm
308+2136	6mm	341+2151	11mm
310+2147	7mm	342+2152	12mm
Socket Holder			



600 g

5x4 20 sets / 13 Kgs / 0.71 CUFT

Bit Sockets

3/8



# Hex Bit Sockets

## SAE Hex Bit Sockets

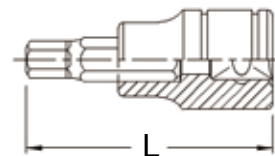
Item No.	Size inch	Length mm	Weight g	PCS		G.W. KGS	CUFT 
				inner	ctn		
308+3108	1/8	50	40	20	240	11.0	0.30
308+3110	5/32	50	40	20	240	11.0	0.30
308+3112	3/16	50	40	20	240	11.0	0.30
308+3114	7/32	50	40	20	240	11.0	0.30
308+3116	1/4	50	40	20	240	11.0	0.30
310+3128	9/32	50	45	20	240	12.0	0.30
310+3130	5/16	50	50	20	240	13.0	0.30
312+3134	3/8	50	65	20	240	17.0	0.30
314+3138	7/16	50	75	20	240	19.0	0.30
316+3142	1/2	50	95	20	240	24.0	0.45
308+3508	1/8	110	55	10	200	12.0	0.59
308+3510	5/32	110	55	10	200	12.0	0.59
308+3512	3/16	110	55	10	200	12.0	0.59
308+3514	7/32	110	55	10	200	12.0	0.59
308+3516	1/4	110	55	10	200	12.0	0.59
310+3518	9/32	110	70	10	200	15.0	0.59
310+3520	5/16	110	70	10	200	15.0	0.59
312+3524	3/8	110	100	10	200	21.0	0.59
314+3528	7/16	110	120	20	160	21.0	0.44
316+3532	1/2	110	160	20	160	27.0	0.44
308+3608	1/8	140	65	10	150	11.0	0.52
308+3610	5/32	140	65	10	150	11.0	0.52
308+3612	3/16	140	65	10	150	11.0	0.52
308+3614	7/32	140	65	10	150	11.0	0.52
308+3616	1/4	140	65	10	150	11.0	0.52
310+3618	9/32	140	85	10	150	14.0	0.52
310+3620	5/16	140	90	10	150	15.0	0.52
312+3624	3/8	140	130	10	150	20.5	0.52
314+3628	7/16	140	160	10	150	25.0	0.52
316+3632	1/2	140	200	10	100	21.0	0.34
308+3708	1/8	180	75	10	100	8.0	0.62
308+3710	5/32	180	75	10	100	8.0	0.62
308+3712	3/16	180	75	10	100	8.0	0.62
308+3714	7/32	180	75	10	100	8.0	0.62
308+3716	1/4	180	75	10	100	8.0	0.62
310+3718	9/32	180	100	10	100	10.5	0.62
310+3720	5/16	180	100	10	100	10.5	0.62
312+3724	3/8	180	140	10	100	15.0	0.62
314+3728	7/16	180	180	10	100	18.5	0.62
316+3732	1/2	180	220	10	80	18.0	0.44
308+3816	1/4	220	85	10	100	10.0	0.62
310+3818	9/32	220	120	10	100	13.0	0.62
310+3820	5/16	220	120	10	100	13.0	0.62
312+3824	3/8	220	170	10	100	18.0	0.62
314+3828	7/16	220	220	10	100	23.0	0.62
316+3832	1/2	220	280	10	80	24.0	0.44



### BS-310HS 10 Piece 3/8" Dr. SAE Hex Bit Socket Set

Item No.	Size	Item No.	Size
<b>3/8" Dr. Hex Bit Socket, 50mmL:</b>			
308+3108	1/8"	310+3128	9/32"
308+3110	5/32"	310+3130	5/16"
308+3112	3/16"	312+3134	3/8"
308+3114	7/32"	314+3138	7/16"
308+3116	1/4"	316+3142	1/2"
Socket Holder			
 600 g	 5x4 20 sets / 13 Kgs / 0.71 CUFT		



Made of High Speed Tool Steel

**ENIUS**<sup>®</sup>  
PROFESSIONAL TOOLS

C-25

# Wobble Hex Bit Sockets

3/8

## Metric Wobble Hex Bit Sockets

Item No.	Size mm	Length mm	Weight g	PCS	G.W. KGS	CUFT
				inner/ctn		
308+4133	3	50	40	20 / 240	11.0	0.30
308+4134	4	50	40	20 / 240	11.0	0.30
308+4135	5	50	40	20 / 240	11.0	0.30
308+4136	6	50	40	20 / 240	11.0	0.30
310+4147	7	50	45	20 / 240	12.0	0.30
310+4148	8	50	50	20 / 240	13.0	0.30
339+4149	9	50	60	20 / 240	15.5	0.30
340+4150	10	50	65	20 / 240	17.0	0.30
308+4533	3	110	55	10 / 200	12.0	0.59
308+4534	4	110	55	10 / 200	12.0	0.59
308+4535	5	110	55	10 / 200	12.0	0.59
308+4536	6	110	55	10 / 200	12.0	0.59
310+4547	7	110	70	10 / 200	15.0	0.59
310+4548	8	110	75	10 / 200	15.5	0.59
339+4549	9	110	90	10 / 200	19.0	0.59
340+4550	10	110	100	10 / 200	21.0	0.59
308+4633	3	140	65	10 / 150	11.0	0.52
308+4634	4	140	65	10 / 150	11.0	0.52
308+4635	5	140	65	10 / 150	11.0	0.52
308+4636	6	140	65	10 / 150	11.0	0.52
310+4647	7	140	85	10 / 150	14.0	0.52
310+4648	8	140	90	10 / 150	14.5	0.52
339+4649	9	140	120	10 / 150	18.5	0.52
340+4650	10	140	130	10 / 150	20.5	0.52
308+4733	3	180	75	10 / 100	8.0	0.62
308+4734	4	180	75	10 / 100	8.0	0.62
308+4735	5	180	75	10 / 100	8.0	0.62
308+4736	6	180	75	10 / 100	8.0	0.62
310+4747	7	180	100	10 / 100	10.5	0.62
310+4748	8	180	100	10 / 100	10.5	0.62
339+4749	9	180	130	10 / 100	14.0	0.62
340+4750	10	180	150	10 / 100	15.5	0.62
308+4836	6	220	85	10 / 100	9.5	0.62
310+4847	7	220	120	10 / 100	13.0	0.62
310+4848	8	220	120	10 / 100	13.0	0.62
339+4849	9	220	160	10 / 100	17.0	0.62
340+4850	10	220	180	10 / 100	19.0	0.62

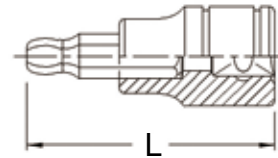

### BS-308WH 8 Piece 3/8" Dr. Metric Wobble Hex Bit Socket Set

Item No.	Size	Item No.	Size
<b>3/8" Dr. Wobble Hex Bit Socket, 50mmL:</b>			
308+4133	3mm	310+4147	7mm
308+4134	4mm	310+4148	8mm
308+4135	5mm	339+4149	9mm
308+4136	6mm	340+4150	10mm
Socket Holder			

500 g 36x1 36 sets / 19 Kgs / 0.64 CUFT



### BS-308WHL 8 Piece 3/8" Dr. Metric Wobble Hex Bit Socket Set

Item No.	Size	Item No.	Size
<b>3/8" Dr. Wobble Hex Bit Socket, 140mmL:</b>			
308+4633	3mm	310+4647	7mm
308+4634	4mm	310+4648	8mm
308+4635	5mm	339+4649	9mm
308+4636	6mm	340+4650	10mm
Socket Holder			

750 g 20x1 20 sets / 16 Kgs / 0.73 CUFT



Made of High Speed Tool Steel

3/8

# Wobble Hex Bit Socket Sets

## SAE Wobble Hex Bit Sockets

Item No.	Size inch	Length mm	Weight g	PCS inner/ctn	G.W. KGS	CUFT
308+5108	1/8	50	40	20 / 240	11.0	0.30
308+5110	5/32	50	40	20 / 240	11.0	0.30
308+5112	3/16	50	40	20 / 240	11.0	0.30
308+5114	7/32	50	40	20 / 240	11.0	0.30
308+5116	1/4	50	40	20 / 240	11.0	0.30
310+5118	9/32	50	50	20 / 240	13.0	0.30
310+5120	5/16	50	50	20 / 240	13.0	0.30
312+5124	3/8	50	65	20 / 240	17.0	0.30
308+5508	1/8	110	55	10 / 200	12.0	0.59
308+5510	5/32	110	55	10 / 200	12.0	0.59
308+5512	3/16	110	55	10 / 200	12.0	0.59
308+5514	7/32	110	55	10 / 200	12.0	0.59
308+5516	1/4	110	55	10 / 200	12.0	0.59
310+5518	9/32	110	70	10 / 200	15.0	0.59
310+5520	5/16	110	70	10 / 200	15.0	0.59
312+5524	3/8	110	100	10 / 200	21.0	0.59
308+5608	1/8	140	65	10 / 150	11.0	0.52
308+5610	5/32	140	65	10 / 150	11.0	0.52
308+5612	3/16	140	65	10 / 150	11.0	0.52
308+5614	7/32	140	65	10 / 150	11.0	0.52
308+5616	1/4	140	65	10 / 150	11.0	0.52
310+5618	9/32	140	85	10 / 150	14.0	0.52
310+5620	5/16	140	90	10 / 150	14.5	0.52
312+5624	3/8	140	130	10 / 150	20.5	0.52
308+5708	1/8	180	75	10 / 100	8.0	0.62
308+5710	5/32	180	75	10 / 100	8.0	0.62
308+5712	3/16	180	75	10 / 100	8.0	0.62
308+5714	7/32	180	75	10 / 100	8.0	0.62
308+5716	1/4	180	75	10 / 100	8.0	0.62
310+5718	9/32	180	100	10 / 100	10.5	0.62
310+5720	5/16	180	100	10 / 100	10.5	0.62
312+5724	3/8	180	140	10 / 100	15.0	0.62
308+5816	1/4	220	85	10 / 100	10.0	0.62
310+5818	9/32	220	120	10 / 100	13.0	0.62
310+5820	5/16	220	120	10 / 100	13.0	0.62
312+5824	3/8	220	170	10 / 100	18.0	0.62

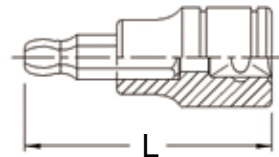

### BS-308WHS 8 Piece 3/8" Dr. SAE Wobble Hex Bit Socket Set

Item No.	Size	Item No.	Size
<b>3/8" Dr. Wobble Hex Bit Socket, 50mmL:</b>			
308+5108	1/8"	308+5116	1/4"
308+5110	5/32"	310+5118	9/32"
308+5112	3/16"	310+5120	5/16"
308+5114	7/32"	312+5124	3/8"
Socket Holder			

470 g 36x1 36 sets / 18 Kgs / 0.64 CUFT



### BS-308WSL 8 Piece 3/8" Dr. SAE Wobble Hex Bit Socket Set

Item No.	Size	Item No.	Size
<b>3/8" Dr. Wobble Hex Bit Socket, 110mmL:</b>			
308+5508	1/8"	308+5516	1/4"
308+5510	5/32"	310+5518	9/32"
308+5512	3/16"	310+5520	5/16"
308+5514	7/32"	312+5524	3/8"
Socket Holder			

600 g 20x1 20 sets / 13 Kgs / 0.73 CUFT



# Star Bit Sockets

3/8

## Star Bit Sockets

Item No.	Size	Length mm	Weight g	PCS		G.W. KGS	CUFT
				inner	ctn		
308+6110	T-10	50	40	20	240	11.0	0.30
308+6115	T-15	50	40	20	240	11.0	0.30
308+6120	T-20	50	40	20	240	11.0	0.30
308+6125	T-25	50	40	20	240	11.0	0.30
308+6127	T-27	50	40	20	240	11.0	0.30
308+6130	T-30	50	50	20	240	11.0	0.30
308+6140	T-40	50	50	20	240	11.0	0.30
310+6245	T-45	50	45	20	240	12.0	0.30
310+6250	T-50	50	50	20	240	13.0	0.30
340+6255	T-55	50	65	20	240	17.0	0.30
308+6510	T-10	110	55	10	200	12.0	0.59
308+6515	T-15	110	55	10	200	12.0	0.59
308+6520	T-20	110	55	10	200	12.0	0.59
308+6525	T-25	110	55	10	200	12.0	0.59
308+6527	T-27	110	55	10	200	12.0	0.59
308+6530	T-30	110	55	10	200	12.0	0.59
308+6540	T-40	110	55	10	200	12.0	0.59
310+6545	T-45	110	70	10	200	15.0	0.59
310+6550	T-50	110	70	10	200	15.0	0.59
340+6555	T-55	110	100	10	200	22.0	0.59
308+6610	T-10	140	65	10	150	11.0	0.52
308+6615	T-15	140	65	10	150	11.0	0.52
308+6620	T-20	140	65	10	150	11.0	0.52
308+6625	T-25	140	65	10	150	11.0	0.52
308+6627	T-27	140	65	10	150	11.0	0.52
308+6630	T-30	140	65	10	150	11.0	0.52
308+6640	T-40	140	65	10	150	11.0	0.52
310+6645	T-45	140	90	10	150	14.5	0.52
310+6650	T-50	140	90	10	150	14.5	0.52
340+6655	T-55	140	130	10	150	20.5	0.52
308+6710	T-10	180	75	10	100	8.0	0.62
308+6715	T-15	180	75	10	100	8.0	0.62
308+6720	T-20	180	75	10	100	8.0	0.62
308+6725	T-25	180	75	10	100	8.0	0.62
308+6727	T-27	180	75	10	100	8.0	0.62
308+6730	T-30	180	75	10	100	8.0	0.62
308+6740	T-40	180	75	10	100	8.0	0.62
310+6745	T-45	180	100	10	100	10.5	0.62
310+6750	T-50	180	100	10	100	10.5	0.62
340+6755	T-55	180	150	10	100	15.5	0.62
308+6810	T-10	220	85	10	100	10.0	0.62
308+6815	T-15	220	85	10	100	10.0	0.62
308+6820	T-20	220	85	10	100	10.0	0.62
308+6825	T-25	220	85	10	100	10.0	0.62
308+6827	T-27	220	85	10	100	10.0	0.62
308+6830	T-30	220	85	10	100	10.0	0.62
308+6840	T-40	220	85	10	100	10.0	0.62
310+6845	T-45	220	120	10	100	13.0	0.62
310+6850	T-50	220	120	10	100	13.0	0.62
340+6855	T-55	220	180	10	100	19.0	0.62

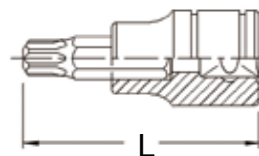

Bit Sockets

3/8

# Tamperproof Star Bit Sockets

## Tamperproof Star Bit Sockets

Item No.	Size	Length mm	Weight g	PCS inner/ctn	G.W. KGS	CUFT
						
308+7110	T-10	50	40	20 / 240	11.0	0.30
308+7115	T-15	50	40	20 / 240	11.0	0.30
308+7120	T-20	50	40	20 / 240	11.0	0.30
308+7125	T-25	50	40	20 / 240	11.0	0.30
308+7127	T-27	50	40	20 / 240	11.0	0.30
308+7130	T-30	50	40	20 / 240	11.0	0.30
308+7140	T-40	50	40	20 / 240	11.0	0.30
310+7145	T-45	50	45	20 / 240	12.0	0.30
310+7150	T-50	50	50	20 / 240	13.0	0.30
340+7155	T-55	50	65	20 / 240	17.0	0.30
308+7510	T-10	110	55	10 / 200	12.0	0.59
308+7515	T-15	110	55	10 / 200	12.0	0.59
308+7520	T-20	110	55	10 / 200	12.0	0.59
308+7525	T-25	110	55	10 / 200	12.0	0.59
308+7527	T-27	110	55	10 / 200	12.0	0.59
308+7530	T-30	110	55	10 / 200	12.0	0.59
308+7540	T-40	110	55	10 / 200	12.0	0.59
310+7545	T-45	110	70	10 / 200	15.0	0.59
310+7550	T-50	110	70	10 / 200	15.0	0.59
340+7555	T-55	110	100	10 / 200	21.0	0.59
308+7610	T-10	140	65	10 / 150	11.0	0.52
308+7615	T-15	140	65	10 / 150	11.0	0.52
308+7620	T-20	140	65	10 / 150	11.0	0.52
308+7625	T-25	140	65	10 / 150	11.0	0.52
308+7627	T-27	140	65	10 / 150	11.0	0.52
308+7630	T-30	140	65	10 / 150	11.0	0.52
308+7640	T-40	140	65	10 / 150	11.0	0.52
310+7645	T-45	140	90	10 / 150	15.0	0.52
310+7650	T-50	140	90	10 / 150	15.0	0.52
340+7655	T-55	140	130	10 / 150	20.5	0.52
308+7710	T-10	180	75	10 / 100	8.0	0.62
308+7715	T-15	180	75	10 / 100	8.0	0.62
308+7720	T-20	180	75	10 / 100	8.0	0.62
308+7725	T-25	180	75	10 / 100	8.0	0.62
308+7727	T-27	180	75	10 / 100	8.0	0.62
308+7730	T-30	180	75	10 / 100	8.0	0.62
308+7740	T-40	180	75	10 / 100	8.0	0.62
310+7745	T-45	180	100	10 / 100	10.5	0.62
310+7750	T-50	180	100	10 / 100	10.5	0.62
340+7755	T-55	180	150	10 / 100	15.5	0.62
308+7810	T-10	220	85	10 / 100	10.0	0.62
308+7815	T-15	220	85	10 / 100	10.0	0.62
308+7820	T-20	220	85	10 / 100	10.0	0.62
308+7825	T-25	220	85	10 / 100	10.0	0.62
308+7827	T-27	220	85	10 / 100	10.0	0.62
308+7830	T-30	220	85	10 / 100	10.0	0.62
308+7840	T-40	220	85	10 / 100	10.0	0.62
310+7845	T-45	220	120	10 / 100	13.0	0.62
310+7850	T-50	220	120	10 / 100	13.0	0.62
340+7855	T-55	220	180	10 / 100	19.0	0.62

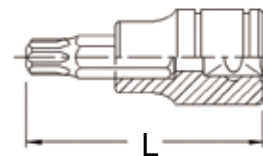

Made of High Speed Tool Steel

**ENIUS**<sup>®</sup>  
PROFESSIONAL TOOLS

C-29

# Triple Square Bit Sockets

3/8

## Triple Square Bit Sockets

Item No.	Size	Length mm	Weight g	PCS	G.W. KGS	CUFT
				inner/ctn		
308+8104	M4	50	40	20 / 240	11.0	0.30
308+8105	M5	50	40	20 / 240	11.0	0.30
308+8106	M6	50	40	20 / 240	11.0	0.30
310+8108	M8	50	45	20 / 240	12.0	0.30
340+8110	M10	50	65	20 / 240	17.0	0.30
342+8112	M12	50	75	20 / 240	19.0	0.30
344+8114	M14	50	90	20 / 240	23.0	0.38
308+8504	M4	110	55	10 / 200	12.0	0.59
308+8505	M5	110	55	10 / 200	12.0	0.59
308+8506	M6	110	55	10 / 200	12.0	0.59
310+8508	M8	110	70	10 / 200	15.0	0.59
340+8510	M10	110	100	10 / 200	21.0	0.59
342+8512	M12	110	130	10 / 200	27.0	0.59
344+8514	M14	110	150	20 / 160	26.0	0.44
308+8604	M4	140	65	10 / 150	11.0	0.52
308+8605	M5	140	65	10 / 150	11.0	0.52
308+8606	M6	140	65	10 / 150	11.0	0.52
310+8608	M8	140	85	10 / 150	14.0	0.52
340+8610	M10	140	130	10 / 150	21.0	0.52
342+8612	M12	140	170	10 / 150	27.0	0.52
344+8614	M14	140	200	10 / 100	21.0	0.34
308+8704	M4	180	75	10 / 100	8.0	0.62
308+8705	M5	180	75	10 / 100	8.0	0.62
308+8706	M6	180	75	10 / 100	8.0	0.62
310+8708	M8	180	100	10 / 100	10.5	0.62
340+8710	M10	180	150	10 / 100	15.5	0.62
342+8712	M12	180	200	10 / 100	20.5	0.62
344+8714	M14	180	240	10 / 80	20.0	0.44
308+8804	M4	220	85	10 / 100	9.5	0.62
308+8805	M5	220	85	10 / 100	9.5	0.62
308+8806	M6	220	85	10 / 100	9.5	0.62
310+8808	M8	220	120	10 / 100	13.0	0.62
340+8810	M10	220	180	10 / 100	19.0	0.62
342+8812	M12	220	240	10 / 100	25.0	0.62
344+8814	M14	220	290	10 / 80	24.5	0.44

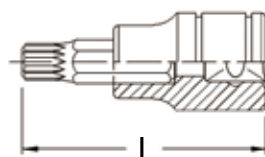

### BS-307M 7 Piece 3/8" Dr. Triple Square Bit Socket Set

Item No.	Size	Item No.	Size
<b>3/8" Dr. Triple Square Bit Socket, 50mmL:</b>			
308+8104	M4	340+8110	M10
308+8105	M5	342+8112	M12
308+8106	M6	344+8114	M14
310+8108	M8	Socket Holder	

430 g 20x1 20 sets / 9.5 Kgs / 0.44 CUFT



### BS-307ML 7 Piece 3/8" Dr. Triple Square Bit Socket Set

Item No.	Size	Item No.	Size
<b>3/8" Dr. Triple Square Bit Socket, 110mmL:</b>			
308+8504	M4	340+8510	M10
308+8505	M5	342+8512	M12
308+8506	M6	344+8514	M14
310+8508	M8	Socket Holder	

720 g 20x1 20 sets / 15.5 Kgs / 0.73 CUFT



Bit Sockets



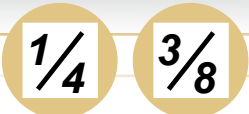

# Pentacle Bit Sockets

## Pentacle Bit Sockets

Item No.	Size	Length mm	Weight g	PCS		G.W. KGS	CUFT
				inner/ctn			
308+5008	T-8	50	40	20 / 240	11.0	0.30	
308+5010	T-10	50	40	20 / 240	11.0	0.30	
308+5015	T-15	50	40	20 / 240	11.0	0.30	
308+5020	T-20	50	40	20 / 240	11.0	0.30	
308+5025	T-25	50	40	20 / 240	11.0	0.30	
308+5027	T-27	50	40	20 / 240	11.0	0.30	
308+5030	T-30	50	40	20 / 240	11.0	0.30	
310+5040	T-40	50	45	20 / 240	12.0	0.30	
310+5045	T-45	50	45	20 / 240	12.0	0.30	
340+5050	T-50	50	70	20 / 240	17.0	0.30	
342+5055	T-55	50	70	20 / 240	17.0	0.30	
308+5208	T-8	76	40	10 / 120	6.0	0.30	
308+5210	T-10	76	40	10 / 120	6.0	0.30	
308+5215	T-15	76	40	10 / 120	6.0	0.30	
308+5220	T-20	76	40	10 / 120	6.0	0.30	
308+5225	T-25	76	40	10 / 120	6.0	0.30	
308+5227	T-27	76	40	10 / 120	6.0	0.30	
308+5230	T-30	76	45	10 / 120	6.5	0.30	
310+5240	T-40	76	60	10 / 120	8.0	0.30	
310+5245	T-45	76	60	10 / 120	8.0	0.30	
340+5250	T-50	76	75	10 / 120	10.0	0.30	
342+5255	T-55	76	90	10 / 120	12.0	0.30	
308+5408	T-8	110	55	10 / 200	12.0	0.59	
308+5410	T-10	110	55	10 / 200	12.0	0.59	
308+5415	T-15	110	55	10 / 200	12.0	0.59	
308+5420	T-20	110	55	10 / 200	12.0	0.59	
308+5425	T-25	110	55	10 / 200	12.0	0.59	
308+5427	T-27	110	55	10 / 200	12.0	0.59	
308+5430	T-30	110	55	10 / 200	12.0	0.59	
310+5440	T-40	110	70	10 / 200	15.0	0.59	
310+5445	T-45	110	70	10 / 200	15.0	0.59	
340+5450	T-50	110	100	10 / 200	21.0	0.59	
342+5455	T-55	110	100	10 / 200	21.0	0.59	

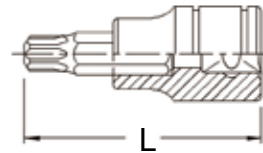

### BS-311PL 11 Piece 3/8" Dr. Pentacle Bit Socket Set

Item No.	Size	Item No.	Size
<b>3/8" Dr. Pentacle Bit Socket, 110mmL:</b>			
308+5408	T-8	308+5430	T-30
308+5410	T-10	310+5440	T-40
308+5415	T-15	310+5445	T-45
308+5420	T-20	340+5450	T-50
308+5425	T-25	342+5455	T-55
308+5427	T-27	Socket Holder	

850 g 20x1 20 sets / 18 Kgs / 0.73 CUFT



### BS-2311P 11 Piece 1/4" & 3/8" Dr. Pentacle Bit Socket Set

Item No.	Size	Item No.	Size
<b>1/4" Dr. Pentacle Bit Socket, 45mmL:</b>			
208+5008	T-8	208+5025	T-25
208+5010	T-10	208+5027	T-27
208+5015	T-15	208+5030	T-30
208+5020	T-20		
<b>3/8" Dr. Pentacle Bit Socket, 50mmL:</b>			
310+5040	T-40	340+5050	T-50
310+5045	T-45	342+5055	T-55
Socket Holder			

450 g 5x4 20 sets / 10 Kgs / 0.71 CUFT



# Ribe Bit Sockets

1/4

3/8

1/2

## Ribe Bit Sockets

Item No.	Size	Length mm	Weight g	PCS		G.W. KGS	CUFT
				inner/ctn			
308+9004	M4	50	40	20 / 240	11.0	0.30	
308+9005	M5	50	40	20 / 240	11.0	0.30	
308+9006	M6	50	40	20 / 240	11.0	0.30	
310+9007	M7	50	45	20 / 240	12.0	0.30	
310+9008	M8	50	45	20 / 240	12.0	0.30	
340+9009	M9	50	65	20 / 240	17.0	0.30	
340+9010	M10	50	65	20 / 240	17.0	0.30	
342+9012	M12	50	75	20 / 240	19.0	0.30	
344+9013	M13	50	90	10 / 120	12.0	0.30	
344+9014	M14	50	90	10 / 120	12.0	0.30	
308+9204	M4	76	45	10 / 120	6.5	0.30	
308+9205	M5	76	45	10 / 120	6.5	0.30	
308+9206	M6	76	45	10 / 120	6.5	0.30	
310+9207	M7	76	60	10 / 120	8.0	0.30	
310+9208	M8	76	60	10 / 120	8.0	0.30	
340+9209	M9	76	75	10 / 120	10.0	0.30	
340+9210	M10	76	80	10 / 120	10.5	0.30	
342+9212	M12	76	95	10 / 120	12.5	0.30	
344+9213	M13	76	120	10 / 120	16.0	0.30	
344+9214	M14	76	130	10 / 120	16.5	0.30	
308+9404	M4	110	55	10 / 200	12.0	0.59	
308+9405	M5	110	55	10 / 200	12.0	0.59	
308+9406	M6	110	55	10 / 200	12.0	0.59	
310+9407	M7	110	70	10 / 200	15.0	0.59	
310+9408	M8	110	70	10 / 200	15.0	0.59	
340+9409	M9	110	100	10 / 200	21.0	0.59	
340+9410	M10	110	100	10 / 200	21.0	0.59	
342+9412	M12	110	130	10 / 200	27.0	0.59	
344+9413	M13	110	150	20 / 160	26.0	0.44	
344+9414	M14	110	150	20 / 160	26.0	0.44	

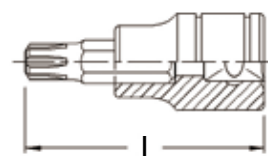

## BS-2310S 10 Piece 1/4" & 3/8" Dr. Ribe Bit Socket Set

Item No. Size Item No. Size

### 1/4" Dr. Ribe Bit Socket, 45mmL:

208+9004 M4 208+9006 M6  
208+9005 M5

### 3/8" Dr. Ribe Bit Socket, 50mmL:

310+9207 M7 342+9212 M12  
310+9208 M8 344+9213 M13  
340+9209 M9 344+9214 M14  
340+9210 M10 Socket Holder

800 g 5x6 30 sets / 24.5 Kgs / 1.21 CUFT



## BS-3411S 11 Piece 3/8" & 1/2" Dr. Ribe Bit Socket Set

Item No. Size Item No. Size

### 3/8" Dr. Ribe Bit Socket, 50mmL:

308+9004 M4 310+9008 M8  
308+9005 M5 340+9009 M9  
308+9006 M6 340+9010 M10  
310+9007 M7

### 1/2" Dr. Ribe Bit Socket, 80mmL:

442+9212 M12 444+9214 M14  
444+9213 M13 446+9216 M16  
Socket Holder

1100 g 20x1 20 sets / 23 Kgs / 1.01 CUFT



Bit Sockets

**1/4**   **3/8**

# Bit Socket Sets

## BS-207S 7 Piece 1/4" Dr. Slotted & Philips Bit Socket Set

Item No.	Size	Item No.	Size
<b>1/4" Dr. Bit Socket, 45mmL:</b>			
208+1130	0.5 x 3.0mm	208+1101	#1 Philips
208+1140	0.6 x 4.0mm	208+1102	#2 Philips
208+1150	0.8 x 5.0mm	208+1103	#3 Philips
208+1160	1.0 x 6.0mm		Socket Holder

240 g   10x6 60 sets / 15.5 Kgs / 0.92 CUFT



## BS-207L 7 Piece 1/4" Dr. Slotted & Philips Bit Socket Set

Item No.	Size	Item No.	Size
<b>1/4" Dr. Bit Socket, 100mmL:</b>			
208+1530	0.5 x 3.0mm	208+1501	#1 Philips
208+1540	0.6 x 4.0mm	208+1502	#2 Philips
208+1550	0.8 x 5.0mm	208+1503	#3 Philips
208+1560	1.0 x 6.0mm		Socket Holder

350 g   6x6 36 sets / 13.5 Kgs / 0.92 CUFT



## BS-309S 9 Piece 3/8" Dr. Slotted & Philips Bit Socket Set

Item No.	Size	Item No.	Size
<b>3/8" Dr. Bit Socket, 50mmL:</b>			
308+1140	0.6 x 4.0mm	308+1101	#1 Philips
308+1150	0.8 x 5.0mm	308+1102	#2 Philips
308+1160	1.0 x 6.0mm	308+1103	#3 Philips
310+1280	1.2 x 8.0mm	310+1124	#4 Philips
310+1290	1.6 x 9.0mm		Socket Holder

500 g   20x1 20 sets / 11 Kgs / 0.73 CUFT



## BS-309L 9 Piece 3/8" Dr. Slotted & Philips Bit Socket Set

Item No.	Size	Item No.	Size
<b>3/8" Dr. Bit Socket, 110mmL:</b>			
308+1540	0.6 x 4.0mm	308+1501	#1 Philips
308+1550	0.8 x 5.0mm	308+1502	#2 Philips
308+1560	1.0 x 6.0mm	308+1503	#3 Philips
310+1580	1.2 x 8.0mm	310+1504	#4 Philips
310+1590	1.6 x 9.0mm		Socket Holder

650 g   20x1 20 sets / 14 Kgs / 0.73 CUFT



## BS-318PL 18 Piece 3/8" Dr. Slotted & Philips Bit Socket Set

Item No.	Size	Item No.	Size
<b>3/8" Dr. Bit Socket, 50mmL:</b>			
308+1140	0.6 x 4.0mm	308+1101	#1 Philips
308+1150	0.8 x 5.0mm	308+1102	#2 Philips
308+1160	1.0 x 6.0mm	308+1103	#3 Philips
310+1280	1.2 x 8.0mm	310+1124	#4 Philips
310+1290	1.6 x 9.0mm		

Item No.	Size	Item No.	Size
<b>3/8" Dr. Bit Socket, 180mmL:</b>			
308+1740	0.6 x 4.0mm	308+1701	#1 Philips
308+1750	0.8 x 5.0mm	308+1702	#2 Philips
308+1760	1.0 x 6.0mm	308+1703	#3 Philips
310+1780	1.2 x 8.0mm	310+1704	#4 Philips
310+1790	1.6 x 9.0mm		Blow Case

1450 g   10 sets / 15.5 Kgs / 1.16 CUFT



# Hex Bit Socket Sets

1/4

3/8

## BS-310HM 10 Piece 3/8" Dr. Metric Hex Bit Socket Set

Item No.	Size	Item No.	Size
<b>3/8" Dr. Hex Bit Socket, 50mmL:</b>			
308+2133	3mm	310+2148	8mm
308+2134	4mm	339+2149	9mm
308+2135	5mm	340+2150	10mm
308+2136	6mm	341+2151	11mm
310+2147	7mm	342+2152	12mm
Socket Holder			

600 g

5x4 20 sets / 13 Kgs / 0.71 CUFT



## BS-310HML 10 Piece 3/8" Dr. Metric Hex Bit Socket Set

Item No.	Size	Item No.	Size
<b>3/8" Dr. Hex Bit Socket, 110mmL:</b>			
308+2533	3mm	310+2548	8mm
308+2534	4mm	339+2549	9mm
308+2535	5mm	340+2550	10mm
308+2536	6mm	341+2551	11mm
310+2547	7mm	342+2552	12mm
Socket Holder			

900 g

20x1 20 sets / 19 Kgs / 0.73 CUFT



## BS-2312H 12 Piece 1/4" & 3/8" Dr. Metric Hex Bit Socket Set

Item No.	Size	Item No.	Size
<b>1/4" Dr. Hex Bit Socket, 45mmL:</b>			
208+2122	2mm	208+2134	4mm
208+2125	2.5mm	208+2135	5mm
208+2133	3mm	208+2136	6mm
<b>3/8" Dr. Hex Bit Socket, 50mmL:</b>			
310+2147	7mm	340+2150	10mm
310+2148	8mm	341+2151	11mm
339+2149	9mm	342+2152	12mm
Socket Holder			

600 g

20x2 40 sets / 25 Kgs / 1.08 CUFT



## BS-2312HL 12 Piece 1/4" & 3/8" Dr. Metric Hex Bit Socket Set

Item No.	Size	Item No.	Size
<b>1/4" Dr. Hex Bit Socket, 100mmL:</b>			
208+2522	2mm	208+2534	4mm
208+2525	2.5mm	208+2535	5mm
208+2533	3mm	208+2536	6mm
<b>3/8" Dr. Hex Bit Socket, 110mmL:</b>			
310+2547	7mm	340+2550	10mm
310+2548	8mm	341+2551	11mm
339+2549	9mm	342+2552	12mm
Socket Holder			

900 g

20x1 20 sets / 19 Kgs / 0.73 CUFT



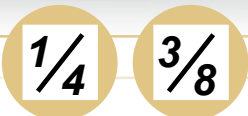

# Hex Bit Socket Sets

## BS-310HS 10 Piece 3/8" Dr. SAE Hex Bit Socket Set

Item No.	Size	Item No.	Size
<b>3/8" Dr. Hex Bit Socket, 50mmL:</b>			
308+3108	1/8"	310+3128	9/32"
308+3110	5/32"	310+3130	5/16"
308+3112	3/16"	312+3134	3/8"
308+3114	7/32"	314+3138	7/16"
308+3116	1/4"	316+3142	1/2"
Socket Holder			

600 g      5x4 20 sets / 13 Kgs / 0.71 CUFT



## BS-310HSL 10 Piece 3/8" Dr. SAE Hex Bit Socket Set

Item No.	Size	Item No.	Size
<b>3/8" Dr. Hex Bit Socket, 140mmL:</b>			
308+3608	1/8"	310+3618	9/32"
308+3610	5/32"	310+3620	5/16"
308+3612	3/16"	312+3624	3/8"
308+3614	7/32"	314+3628	7/16"
308+3616	1/4"	316+3632	1/2"
Socket Holder			

1100 g      20x1 20 sets / 23 Kgs / 0.73 CUFT



## BS-2314H 14 Piece 1/4" & 3/8" Dr. SAE Hex Bit Socket Set

Item No.	Size	Item No.	Size
<b>1/4" Dr. Hex Bit Socket, 45mmL:</b>			
208+3104	1/16"	208+3110	5/32"
208+3105	5/64"	208+3112	3/16"
208+3106	3/32"	208+3114	7/32"
208+3107	7/64"	208+3116	1/4"
208+3108	1/8"		
<b>3/8" Dr. Hex Bit Socket, 50mmL:</b>			
310+3128	9/32"	314+3138	7/16"
310+3130	5/16"	316+3142	1/2"
312+3134	3/8"	Socket Holder	

620 g      20x2 40 sets / 26 Kgs / 1.08 CUFT



## BS-2314HL 14 Piece 1/4" & 3/8" Dr. SAE Hex Bit Socket Set

Item No.	Size	Item No.	Size
<b>1/4" Dr. Hex Bit Socket, 100mmL:</b>			
208+3504	1/16"	208+3510	5/32"
208+3505	5/64"	208+3512	3/16"
208+3506	3/32"	208+3514	7/32"
208+3507	7/64"	208+3516	1/4"
208+3508	1/8"		
<b>3/8" Dr. Hex Bit Socket, 110mmL:</b>			
310+3518	9/32"	314+3528	7/16"
310+3520	5/16"	316+3532	1/2"
312+3524	3/8"	Socket Holder	

950 g      20x1 20 sets / 20 Kgs / 0.73 CUFT



# Hex Bit Socket Sets

1/4

3/8

## BS-320HMX 20 Piece 3/8" Dr. Metric Hex Bit Socket Set

Item No.	Size	Item No.	Size
<b>3/8" Dr. Hex Bit Socket, 50mmL:</b>			
308+2133	3mm	310+2148	8mm
308+2134	4mm	339+2149	9mm
308+2135	5mm	340+2150	10mm
308+2136	6mm	341+2151	11mm
310+2147	7mm	342+2152	12mm
<b>3/8" Dr. Hex Bit Socket, 180mmL:</b>			
308+2733	3mm	310+2748	8mm
308+2734	4mm	339+2749	9mm
308+2735	5mm	340+2750	10mm
308+2736	6mm	341+2751	11mm
310+2747	7mm	342+2752	12mm

Blow Case

2050 g

10 sets / 21.5 Kgs / 1.16 CUFT



## BS-320HSX 20 Piece 3/8" Dr. SAE Hex Bit Socket Set

Item No.	Size	Item No.	Size
<b>3/8" Dr. Hex Bit Socket, 50mmL:</b>			
308+3108	1/8"	310+3118	9/32"
308+3110	5/32"	310+3120	5/16"
308+3112	3/16"	312+3124	3/8"
308+3114	7/32"	314+3128	7/16"
308+3116	1/4"	316+3132	1/2"
<b>3/8" Dr. Hex Bit Socket, 180mmL:</b>			
308+3708	1/8"	310+3718	9/32"
308+3710	5/32"	310+3720	5/16"
308+3712	3/16"	312+3724	3/8"
308+3714	7/32"	314+3728	7/16"
308+3716	1/4"	316+3732	1/2"

Blow Case

2150 g

10 sets / 22.5 Kgs / 1.16 CUFT



## BS-2324HL 24 Piece 1/4" & 3/8" Dr. Metric Hex Bit Socket Set

Item No.	Size	Item No.	Size
<b>1/4" Dr. Hex Bit Socket:</b>			
208+2122	2mm, 45mmL	208+2622	2mm, 140mmL
208+2125	2.5mm, 45mmL	208+2625	2.5mm, 140mmL
208+2133	3mm, 45mmL	208+2633	3mm, 140mmL
208+2134	4mm, 45mmL	208+2634	4mm, 140mmL
208+2135	5mm, 45mmL	208+2635	5mm, 140mmL
208+2136	6mm, 45mmL	208+2636	6mm, 140mmL
<b>3/8" Dr. Hex Bit Socket:</b>			
310+2147	7mm, 50mmL	310+2647	7mm, 140mmL
310+2148	8mm, 50mmL	310+2648	8mm, 140mmL
339+2149	9mm, 50mmL	339+2649	9mm, 140mmL
340+2150	10mm, 50mmL	340+2650	10mm, 140mmL
341+2151	11mm, 50mmL	341+2651	11mm, 140mmL
342+2152	12mm, 50mmL	342+2652	12mm, 140mmL

Blow Case

1700 g

10 sets / 18 Kgs / 1.16 CUFT



Bit Sockets

**1/4**      **3/8**

# Hex Bit Socket Sets

## BS-2328HL 28 Piece 1/4" & 3/8 "Dr. SAE Hex Bit Socket Set

Item No.	Size	Item No.	Size
<b>1/4" Dr. Hex Bit Socket:</b>			
208+3104	1/16", 45mmL	208+3604	1/16", 140mmL
208+3105	5/64", 45mmL	208+3605	5/64", 140mmL
208+3106	3/32", 45mmL	208+3606	3/32", 140mmL
208+3107	7/64", 45mmL	208+3607	7/64", 140mmL
208+3108	1/8", 45mmL	208+3608	1/8", 140mmL
208+3110	5/32", 45mmL	208+3610	5/32", 140mmL
208+3112	3/16", 45mmL	208+3612	3/16", 140mmL
208+3114	7/32", 45mmL	208+3614	7/32", 140mmL
208+3116	1/4", 45mmL	208+3616	1/4", 140mmL
<b>3/8" Dr. Hex Bit Socket:</b>			
310+3128	9/32", 50mmL	310+3618	9/32", 140mmL
310+3130	5/16", 50mmL	310+3620	5/16", 140mmL
312+3134	3/8", 50mmL	312+3624	3/8", 140mmL
314+3138	7/16", 50mmL	314+3628	7/16", 140mmL
316+3142	1/2", 50mmL	316+3632	1/2", 140mmL

Blow Case  
 1800 g      10 sets / 19 Kgs / 1.16 CUFT



## TX-2353 53 Piece 1/4" & 3/8" Dr. Complete Bit Socket Set

Item No.	Size	Item No.	Size
<b>1/4" Dr. Bit Socket, 45mmL:</b>			
208+1130	0.5 x 3.0mm Slotted	208+2122	2mm Hex
208+1140	0.6 x 4.0mm Slotted	208+2125	2.5mm Hex
208+1101	#1 Philips	208+2133	3mm Hex
208+1102	#2 Philips	208+2134	4mm Hex
208+3104	1/16" Hex	208+6106	T-6 Star
208+3105	5/64" Hex	208+6107	T-7 Star
208+3106	3/32" Hex	208+6108	T-8 Star
208+3107	7/64" Hex	208+6109	T-9 Star
208+3108	1/8" Hex	208+6110	T-10 Star
208+3110	5/32" Hex	208+6115	T-15 Star
<b>3/8" Dr. Bit Socket, 50mmL:</b>			
308+1150	0.8 x 5.0mm Slotted	308+3112	3/16" Hex
308+1160	1.0 x 6.0mm Slotted	308+3114	7/32" Hex
310+1280	1.2 x 8.0mm Slotted	308+3116	1/4" Hex
308+1103	#3 Philips	310+3128	9/32" Hex
310+1124	#4 Philips	310+3130	5/16" Hex
308+2135	5mm Hex	312+3134	3/8" Hex
308+2136	6mm Hex	314+3138	7/16" Hex
310+2147	7mm Hex	316+3142	1/2" Hex
310+2148	8mm Hex	308+6120	T-20 Star
340+2150	10mm Hex	308+6125	T-25 Star
342+2152	12mm Hex	308+6127	T-27 Star
308+8104	M4 Triple Square	308+6130	T-30 Star
308+8105	M5 Triple Square	308+6140	T-40 Star
308+8106	M6 Triple Square	310+6245	T-45 Star
310+8108	M8 Triple Square	310+6250	T-50 Star
340+8110	M10 Triple Square	340+6255	T-55 Star
342+8112	M12 Triple Square	Plastic Tray	

2500 g      5 sets / 13.5 Kgs / 0.93 CUFT



(192W x 406D)



# Wobble Hex Bit Socket Sets

1/4

3/8

## BS-308WH 8 Piece 3/8" Dr. Metric Wobble Hex Bit Socket Set

Item No.	Size	Item No.	Size
<b>3/8" Dr. Wobble Hex Bit Socket, 50mmL:</b>			
308+4133	3mm	310+4147	7mm
308+4134	4mm	310+4148	8mm
308+4135	5mm	339+4149	9mm
308+4136	6mm	340+4150	10mm
Socket Holder			
500 g	36x1 36 sets / 19 Kgs / 0.64 CUFT		



## BS-308WHL 8 Piece 3/8" Dr. Metric Wobble Hex Bit Socket Set

Item No.	Size	Item No.	Size
<b>3/8" Dr. Wobble Hex Bit Socket, 140mmL:</b>			
308+4633	3mm	310+4647	7mm
308+4634	4mm	310+4648	8mm
308+4635	5mm	339+4649	9mm
308+4636	6mm	340+4650	10mm
Socket Holder			
750 g	20x1 20 sets / 16 Kgs / 0.73 CUFT		



## BS-2308WR 8 Piece 1/4" & 3/8" Dr. Metric Wobble Hex Bit Socket Set

Item No.	Size	Item No.	Size
<b>1/4" Dr. Wobble Hex Bit Socket, 45mmL:</b>			
208+4133	3mm	208+4135	5mm
208+4134	4mm	208+4136	6mm
<b>3/8" Dr. Wobble Hex Bit Socket, 50mmL:</b>			
310+4147	7mm	339+4149	9mm
310+4148	8mm	340+4150	10mm
Socket Holder			
400 g	10x2 20 sets / 9 Kgs / 0.48 CUFT		



## BS-2308WH 8 Piece 1/4" & 3/8" Dr. Metric Wobble Hex Bit Socket Set

Item No.	Size	Item No.	Size
<b>1/4" Dr. Wobble Hex Bit Socket, 70mmL:</b>			
208+4333	3mm	208+4335	5mm
208+4334	4mm	208+4336	6mm
<b>3/8" Dr. Wobble Hex Bit Socket, 110mmL:</b>			
310+4547	7mm	339+4549	9mm
310+4548	8mm	340+4550	10mm
Socket Holder			
550 g	20x1 20 sets / 12 Kgs / 0.73 CUFT		





1/4

3/8

# Wobble Hex Bit Socket Sets

## BS-308WHS 8 Piece 3/8" Dr. SAE Wobble Hex Bit Socket Set

Item No.	Size	Item No.	Size
<b>3/8" Dr. Wobble Hex Bit Socket, 50mmL:</b>			
308+5108	1/8"	308+5116	1/4"
308+5110	5/32"	310+5118	9/32"
308+5112	3/16"	310+5120	5/16"
308+5114	7/32"	312+5124	3/8"
Socket Holder			
450 g	36x1 36 sets / 18 Kgs / 0.64 CUFT		



## BS-308WSL 8 Piece 3/8" Dr. SAE Wobble Hex Bit Socket Set

Item No.	Size	Item No.	Size
<b>3/8" Dr. Wobble Hex Bit Socket, 110mmL:</b>			
308+5508	1/8"	308+5516	1/4"
308+5510	5/32"	310+5518	9/32"
308+5512	3/16"	310+5520	5/16"
308+5514	7/32"	312+5524	3/8"
Socket Holder			
600 g	20x1 20 sets / 13 Kgs / 0.73 CUFT		



## BS-2308SR 8 Piece 1/4" & 3/8" Dr. SAE Wobble Hex Bit Socket Set

Item No.	Size	Item No.	Size
<b>1/4" Dr. Wobble Hex Bit Socket, 45mmL:</b>			
208+5108	1/8"	208+5114	7/32"
208+5110	5/32"	208+5116	1/4"
208+5112	3/16"		
<b>3/8" Dr. Wobble Hex Bit Socket, 50mmL:</b>			
310+5118	9/32"	312+5124	3/8"
310+5120	5/16"	Blow Case	
400 g	10x2 20 sets / 9 Kgs / 0.48 CUFT		



## BS-2308SW 8 Piece 1/4" & 3/8" Dr. SAE Wobble Hex Bit Socket Set

Item No.	Size	Item No.	Size
<b>1/4" Dr. Wobble Hex Bit Socket, 70mmL:</b>			
208+5308	1/8"	208+5314	7/32"
208+5310	5/32"	208+5316	1/4"
208+5312	3/16"		
<b>3/8" Dr. Wobble Hex Bit Socket, 110mmL:</b>			
310+5518	9/32"	312+5524	3/8"
310+5520	5/16"	Blow Case	
500 g	20x1 20 sets / 11 Kgs / 0.73 CUFT		



# Wobble Hex Bit Socket Sets

1/4

3/8

## BS-2316WH 16 Piece 1/4" & 3/8" Dr. Metric Wobble Hex Bit Socket Set

Item No.	Size	Item No.	Size
<b>1/4" Dr. Wobble Hex Bit Socket:</b>			
208+4133	3mm, 45mmL	208+4633	3mm, 140mmL
208+4134	4mm, 45mmL	208+4634	4mm, 140mmL
208+4135	5mm, 45mmL	208+4635	5mm, 140mmL
208+4136	6mm, 45mmL	208+4636	6mm, 140mmL
<b>3/8" Dr. Wobble Hex Bit Socket:</b>			
310+4147	7mm, 50mmL	310+4647	7mm, 140mmL
310+4148	8mm, 50mmL	310+4648	8mm, 140mmL
339+4149	9mm, 50mmL	339+4649	9mm, 140mmL
340+4150	10mm, 50mmL	340+4650	10mm, 140mmL

Blow Case

1200 g

10 sets / 13 Kgs / 0.82 CUFT



## BS-2316WS 16 Piece 1/4" & 3/8" Dr. SAE Wobble Hex Bit Socket Set

Item No.	Size	Item No.	Size
<b>1/4" Dr. Wobble Hex Bit Socket:</b>			
208+5108	1/8", 45mmL	208+5608	1/8", 140mmL
208+5110	5/32", 45mmL	208+5610	5/32", 140mmL
208+5112	3/16", 45mmL	208+5612	3/16", 140mmL
208+5114	7/32", 45mmL	208+5614	7/32", 140mmL
208+5116	1/4", 45mmL	208+5616	1/4", 140mmL
<b>3/8" Dr. Wobble Hex Bit Socket:</b>			
310+5118	9/32", 50mmL	310+5618	9/32", 140mmL
310+5120	5/16", 50mmL	310+5620	5/16", 140mmL
312+5124	3/8", 50mmL	312+5624	3/8", 140mmL

Blow Case

1100 g

10 sets / 12 Kgs / 0.82 CUFT



## BS-316WHX 16 Piece 3/8" Dr. Metric Wobble Hex Bit Socket Set

Item No.	Size	Item No.	Size
<b>3/8" Dr. Wobble Hex Bit Socket, 50mmL:</b>			
308+4133	3mm	310+4147	7mm
308+4134	4mm	310+4148	8mm
308+4135	5mm	339+4149	9mm
308+4136	6mm	340+4150	10mm
<b>3/8" Dr. Wobble Hex Bit Socket, 180mmL:</b>			
308+4733	3mm	310+4747	7mm
308+4734	4mm	310+4748	8mm
308+4735	5mm	339+4749	9mm
308+4736	6mm	340+4750	10mm

Blow Case

1700 g

10 sets / 18 Kgs / 1.16 CUFT



Bit Sockets

**3/8**      **1/2**

# Wobble Hex Bit Socket Sets

## BS-316WSX 16 Piece 3/8" Dr. SAE Wobble Hex Bit Socket Set

Item No.	Size	Item No.	Size
<b>3/8" Dr. Wobble Hex Bit Socket, 50mmL:</b>			
308+5108	1/8"	308+5116	1/4"
308+5110	5/32"	310+5118	9/32"
308+5112	3/16"	310+5120	5/16"
308+5114	7/32"	312+5124	3/8"
<b>3/8" Dr. Wobble Hex Bit Socket, 180mmL:</b>			
308+5708	1/8"	308+5716	1/4"
308+5710	5/32"	310+5718	9/32"
308+5712	3/16"	310+5720	5/16"
308+5714	7/32"	312+5724	3/8"
Blow Case			
1650 g	10 sets / 17.5 Kgs / 1.16 CUFT		



## BS-3416WM 16 Piece 3/8" & 1/2" Dr. Metric Wobble Hex Bit Socket Set

Item No.	Size	Item No.	Size
<b>3/8" Dr. Wobble Hex Bit Socket:</b>			
308+4133	3mm, 50mmL	308+4633	3mm, 140mmL
308+4134	4mm, 50mmL	308+4634	4mm, 140mmL
308+4135	5mm, 50mmL	308+4635	5mm, 140mmL
308+4136	6mm, 50mmL	308+4636	6mm, 140mmL
<b>1/2" Dr. Wobble Hex Bit Socket:</b>			
410+4347	7mm, 80mmL	410+4647	7mm, 150mmL
410+4348	8mm, 80mmL	410+4648	8mm, 150mmL
439+4349	9mm, 80mmL	439+4649	9mm, 150mmL
440+4350	10mm, 80mmL	440+4650	10mm, 150mmL
Blow Case			
1600 g	10 sets / 17 Kgs / 1.16 CUFT		



## BS-3416WS 16 Piece 3/8" & 1/2" Dr. SAE Wobble Hex Bit Socket Set

Item No.	Size	Item No.	Size
<b>3/8" Dr. Wobble Hex Bit Socket:</b>			
308+5108	1/8", 50mmL	308+5608	1/8", 140mmL
308+5110	5/32", 50mmL	308+5610	5/32", 140mmL
308+5112	3/16", 50mmL	308+5612	3/16", 140mmL
308+5114	7/32", 50mmL	308+5614	7/32", 140mmL
308+5116	1/4", 50mmL	308+5616	1/4", 140mmL
<b>1/2" Dr. Wobble Hex Bit Socket:</b>			
410+5318	9/32", 80mmL	410+5618	9/32", 150mmL
410+5320	5/16", 80mmL	410+5620	5/16", 150mmL
412+5324	3/8", 80mmL	412+5624	3/8", 150mmL
Blow Case			
1450 g	10 sets / 15.5 Kgs / 1.16 CUFT		



Made of High Speed Tool Steel



# Star Bit Socket Sets

1/4

3/8

## BS-2314T 14 Piece 1/4" & 3/8" Dr. Star Bit Socket Set

Item No.	Size	Item No.	Size
<b>1/4" Dr. Star Bit Socket, 45mmL:</b>			
208+6106	T-6	208+6120	T-20
208+6107	T-7	208+6125	T-25
208+6108	T-8	208+6127	T-27
208+6109	T-9	208+6130	T-30
208+6110	T-10	208+6140	T-40
208+6115	T-15		
<b>3/8" Dr. Star Bit Socket, 50mmL:</b>			
310+6245	T-45	340+6255	T-55
310+6250	T-50	Socket Holder	
480 g	20x2	40 sets / 20.5 Kgs / 1.08 CUFT	



## BS-2314TL 14 Piece 1/4" & 3/8" Dr. Star Bit Socket Set

Item No.	Size	Item No.	Size
<b>1/4" Dr. Star Bit Socket, 100mmL:</b>			
208+6506	T-6	208+6520	T-20
208+6507	T-7	208+6525	T-25
208+6508	T-8	208+6527	T-27
208+6509	T-9	208+6530	T-30
208+6510	T-10	208+6540	T-40
208+6515	T-15		
<b>3/8" Dr. Star Bit Socket, 110mmL:</b>			
310+6545	T-45	340+6555	T-55
310+6550	T-50	Socket Holder	
750 g	20x1	20 sets / 16 Kgs / 0.73 CUFT	



## BS-2328TL 28 Piece 1/4" & 3/8" Dr. Star Bit Socket Set

Item No.	Size	Item No.	Size
<b>1/4" Dr. Star Bit Socket:</b>			
208+6106	T-6, 45mmL	208+6606	T-6, 140mmL
208+6107	T-7, 45mmL	208+6607	T-7, 140mmL
208+6108	T-8, 45mmL	208+6608	T-8, 140mmL
208+6109	T-9, 45mmL	208+6609	T-9, 140mmL
208+6110	T-10, 45mmL	208+6610	T-10, 140mmL
208+6115	T-15, 45mmL	208+6615	T-15, 140mmL
208+6120	T-20, 45mmL	208+6620	T-20, 140mmL
208+6125	T-25, 45mmL	208+6625	T-25, 140mmL
208+6127	T-27, 45mmL	208+6627	T-27, 140mmL
208+6130	T-30, 45mmL	208+6630	T-30, 140mmL
208+6140	T-40, 45mmL	208+6640	T-40, 140mmL
<b>3/8" Dr. Bit Socket, 50mmL:</b>			
310+6245	T-45 Star	310+6645	T-45 Star
310+6250	T-50 Star	310+6650	T-50 Star
340+6255	T-55 Star	340+6655	T-55 Star
Blow Case			
1600 g	10 sets	17 Kgs / 1.16 CUFT	



Bit Sockets

**3/8**      **1/2**

# Star Bit Socket Sets

## BS-310T 10 Piece 3/8" Dr. Star Bit Socket Set

Item No.	Size	Item No.	Size
<b>3/8" Dr. Star Bit Socket, 50mmL:</b>			
308+6110	T-10	308+6130	T-30
308+6115	T-15	308+6140	T-40
308+6120	T-20	310+6245	T-45
308+6125	T-25	310+6250	T-50
308+6127	T-27	340+6255	T-55
Socket Holder			

500 g      5x4 20 sets / 11 Kgs / 0.71 CUFT

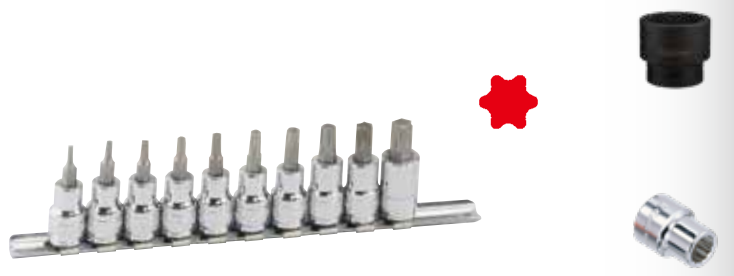

## BS-310TL 10 Piece 3/8" Dr. Star Bit Socket Set

Item No.	Size	Item No.	Size
<b>3/8" Dr. Star Bit Socket, 110mmL:</b>			
308+6510	T-10	308+6530	T-30
308+6515	T-15	308+6540	T-40
308+6520	T-20	310+6545	T-45
308+6525	T-25	310+6550	T-50
308+6527	T-27	340+6555	T-55
Socket Holder			

720 g      20x1 20 sets / 15.5 Kgs / 0.73 CUFT



## BS-320TX 20 Piece 3/8" Dr. Star Bit Socket Set

Item No.	Size	Item No.	Size
<b>3/8" Dr. Star Bit Socket, 50mmL:</b>			
308+6110	T-10	308+6130	T-30
308+6115	T-15	308+6140	T-40
308+6120	T-20	310+6245	T-45
308+6125	T-25	310+6250	T-50
308+6127	T-27	340+6255	T-55
<b>3/8" Dr. Star Bit Socket, 180mmL:</b>			
308+6710	T-10	308+6730	T-30
308+6715	T-15	308+6740	T-40
308+6720	T-20	310+6745	T-45
308+6725	T-25	310+6750	T-50
308+6727	T-27	340+6755	T-55
Blow Case			

1800 g      10 sets / 19 Kgs / 1.16 CUFT



## BS-3424T 24 Piece 3/8" & 1/2" Dr. Star Bit Socket Set

Item No.	Size	Item No.	Size
<b>3/8" Dr. Star Bit Socket:</b>			
308+6110	T-10, 50mmL	308+6610	T-10, 140mmL
308+6115	T-15, 50mmL	308+6615	T-15, 140mmL
308+6120	T-20, 50mmL	308+6620	T-20, 140mmL
308+6125	T-25, 50mmL	308+6625	T-25, 140mmL
308+6127	T-27, 50mmL	308+6627	T-27, 140mmL
308+6130	T-30, 50mmL	308+6630	T-30, 140mmL
308+6140	T-40, 50mmL	308+6640	T-40, 140mmL
<b>1/2" Dr. Star Bit Socket:</b>			
410+6345	T-45, 80mmL	410+6645	T-45, 150mmL
410+6350	T-50, 80mmL	410+6650	T-50, 150mmL
440+6355	T-55, 80mmL	440+6655	T-55, 150mmL
442+6360	T-60, 80mmL	442+6660	T-60, 150mmL
444+6370	T-70, 80mmL	444+6670	T-70, 150mmL
Plastic Tray			

2650 g      5 sets / 14.5 Kgs / 0.93 CUFT



(192W x 406D)

Made of High Speed Tool Steel



# Tamperproof Star Bit Socket Sets

1/4

3/8

## BS-310TA 10 Piece 3/8" Dr. Tamperproof Star Bit Socket Set

Item No. Size Item No. Size

### 3/8" Dr. Tamperproof Star Bit Socket, 50mmL:

308+7110	T-10	308+7130	T-30
308+7115	T-15	308+7140	T-40
308+7120	T-20	310+7145	T-45
308+7125	T-25	310+7150	T-50
308+7127	T-27	340+7155	T-55

Socket Holder

500 g

5x4 20 sets / 11 Kgs / 0.71 CUFT



## BS-310TAL 10 Piece 3/8" Dr. Tamperproof Star Bit Socket Set

Item No. Size Item No. Size

### 3/8" Dr. Tamperproof Star Bit Socket, 110mmL:

308+7510	T-10	308+7530	T-30
308+7515	T-15	308+7540	T-40
308+7520	T-20	310+7545	T-45
308+7525	T-25	310+7550	T-50
308+7527	T-27	340+7555	T-55

Socket Holder

750 g

20x1 20 sets / 16 Kgs / 0.73 CUFT



## BS-320TAX 20 Piece 3/8" Dr. Tamperproof Star Bit Socket Set

Item No. Size Item No. Size

### 3/8" Dr. Tamperproof Star Bit Socket, 50mmL:

308+7110	T-10	308+7130	T-30
308+7115	T-15	308+7140	T-40
308+7120	T-20	310+7145	T-45
308+7125	T-25	310+7150	T-50
308+7127	T-27	340+7155	T-55

### 3/8" Dr. Tamperproof Star Bit Socket, 180mmL:

308+7710	T-10	308+7730	T-30
308+7715	T-15	308+7740	T-40
308+7720	T-20	310+7745	T-45
308+7725	T-25	310+7750	T-50
308+7727	T-27	340+7755	T-55

Blow Case

1850 g

10 sets / 19.5 Kgs / 1.16 CUFT



## BS-2326TAL 26 Piece 1/4" & 3/8" Dr. Tamperproof Star Bit Socket Set

Item No. Size Item No. Size

### 1/4" Dr. Tamperproof Star Bit Socket:

208+7107	T-7, 45mmL	208+7607	T-7, 140mmL
208+7108	T-8, 45mmL	208+7608	T-8, 140mmL
208+7109	T-9, 45mmL	208+7609	T-9, 140mmL
208+7110	T-10, 45mmL	208+7610	T-10, 140mmL
208+7115	T-15, 45mmL	208+7615	T-15, 140mmL
208+7120	T-20, 45mmL	208+7620	T-20, 140mmL
208+7125	T-25, 45mmL	208+7625	T-25, 140mmL
208+7127	T-27, 45mmL	208+7627	T-27, 140mmL
208+7130	T-30, 45mmL	208+7630	T-30, 140mmL
208+7140	T-40, 45mmL	208+7640	T-40, 140mmL

### 3/8" Dr. Tamperproof Star Bit Socket:

310+7145	T-45, 50mmL	310+7645	T-45, 140mmL
310+7150	T-50, 50mmL	310+7650	T-50, 140mmL
340+7155	T-55, 50mmL	340+7655	T-55, 140mmL

Blow Case

1550 g

10 sets / 16.5 Kgs / 1.16 CUFT



1/4 3/8 1/2

# Tamperproof Star Bit Socket Sets

## BS-2313TP 13 Piece 1/4" & 3/8" Dr. Tamperproof Star Bit Socket Set

Item No.	Size	Item No.	Size
<b>1/4" Dr. Tamperproof Star Bit Socket, 45mmL:</b>			
208+7107	T-7	208+7120	T-20
208+7108	T-8	208+7125	T-25
208+7109	T-9	208+7127	T-27
208+7110	T-10	208+7130	T-30
208+7115	T-15	208+7140	T-40
<b>3/8" Dr. Tamperproof Star Bit Socket, 50mmL:</b>			
310+7145	T-45	340+7155	T-55
310+7150	T-50	Socket Holder	
470 g	20x2 40 sets / 20 Kgs / 1.08 CUFT		



## BS-2313TA 13 Piece 1/4" & 3/8" Dr. Tamperproof Star Bit Socket Set

Item No.	Size	Item No.	Size
<b>1/4" Dr. Tamperproof Star Bit Socket, 70mmL:</b>			
208+7307	T-7	208+7320	T-20
208+7308	T-8	208+7325	T-25
208+7309	T-9	208+7327	T-27
208+7310	T-10	208+7330	T-30
208+7315	T-15	208+7340	T-40
<b>3/8" Dr. Tamperproof Star Bit Socket, 110mmL:</b>			
310+7545	T-45	340+7555	T-55
310+7550	T-50	Socket Holder	
620 g	20x1 20 sets / 13.5 Kgs / 0.73 CUFT		



## BS-23441 41 Piece 1/4", 3/8" & 1/2" Dr. Complete Star Bit Socket Set

Item No.	Size	Item No.	Size
<b>Star Hand Socket:</b>			
252504	1/4" Dr. E-4	353511	3/8" Dr. E-11
252505	1/4" Dr. E-5	353512	3/8" Dr. E-12
252506	1/4" Dr. E-6	353514	3/8" Dr. E-14
252507	1/4" Dr. E-7	353516	3/8" Dr. E-16
252508	1/4" Dr. E-8	454518	1/2" Dr. E-18
353510	3/8" Dr. E-10	454520	1/2" Dr. E-20
<b>Star Bit Socket:</b>			
208+6107	1/4" Dr. T-7, 45mmL	208+6130	1/4" Dr. T-30, 45mmL
208+6108	1/4" Dr. T-8, 45mmL	308+6140	3/8" Dr. T-40, 50mmL
208+6109	1/4" Dr. T-9, 45mmL	310+6245	3/8" Dr. T-45, 50mmL
208+6110	1/4" Dr. T-10, 45mmL	310+6250	3/8" Dr. T-50, 50mmL
208+6115	1/4" Dr. T-15, 45mmL	340+6255	3/8" Dr. T-55, 50mmL
208+6120	1/4" Dr. T-20, 45mmL	442+6260	1/2" Dr. T-60, 60mmL
208+6125	1/4" Dr. T-25, 45mmL	444+6270	1/2" Dr. T-70, 60mmL
208+6127	1/4" Dr. T-27, 45mmL		
<b>Tamperproof Star Bit Socket:</b>			
208+7108	1/4" Dr. T-8, 45mmL	208+7130	1/4" Dr. T-30, 45mmL
208+7109	1/4" Dr. T-9, 45mmL	308+7140	3/8" Dr. T-40, 50mmL
208+7110	1/4" Dr. T-10, 45mmL	310+7145	3/8" Dr. T-45, 50mmL
208+7115	1/4" Dr. T-15, 45mmL	310+7150	3/8" Dr. T-50, 50mmL
208+7120	1/4" Dr. T-20, 45mmL	340+7155	3/8" Dr. T-55, 50mmL
208+7125	1/4" Dr. T-25, 45mmL	442+7160	1/2" Dr. T-60, 60mmL
208+7127	1/4" Dr. T-27, 45mmL	444+7170	1/2" Dr. T-70, 60mmL
<b>Blow Case</b>			



2050 g 10 sets / 21.5 Kgs / 1.16 CUFT

Made of High Speed Tool Steel

**ENIUS**  
PROFESSIONAL TOOLS

C-45

# Triple Square Bit Sockets Sets

3/8

1/2

## BS-307M 7 Piece 3/8" Dr. Triple Square Bit Socket Set

Item No.	Size	Item No.	Size
<b>3/8" Dr. Triple Square Bit Socket, 50mmL:</b>			
308+8104	M4	340+8110	M10
308+8105	M5	342+8112	M12
308+8106	M6	344+8114	M14
310+8108	M8	Socket Holder	

430 g 20x1 20 sets / 9.5 Kgs / 0.44 CUFT



## BS-307ML 7 Piece 3/8" Dr. Triple Square Bit Socket Set

Item No.	Size	Item No.	Size
<b>3/8" Dr. Triple Square Bit Socket, 110mmL:</b>			
308+8504	M4	340+8510	M10
308+8505	M5	342+8512	M12
308+8506	M6	344+8514	M14
310+8508	M8	Socket Holder	

720 g 20x1 20 sets / 15.5 Kgs / 0.73 CUFT



## BS-314MX 14 Piece 3/8" Dr. Triple Square Bit Socket Set

Item No.	Size	Item No.	Size
<b>3/8" Dr. Triple Square Bit Socket, 50mmL:</b>			
308+8104	M4	340+8110	M10
308+8105	M5	342+8112	M12
308+8106	M6	344+8114	M14
310+8108	M8		
<b>3/8" Dr. Triple Square Bit Socket, 180mmL:</b>			
308+8704	M4	340+8710	M10
308+8705	M5	342+8712	M12
308+8706	M6	344+8714	M14
310+8708	M8	Blow Case	

1800 g 10 sets / 19 Kgs / 1.16 CUFT



## BS-3416M 16 Piece 3/8" & 1/2" Dr. Triple Square Bit Socket Set

Item No.	Size	Item No.	Size
<b>3/8" Dr. Triple Square Bit Socket:</b>			
308+8104	M4, 50mmL	308+8604	M4, 140mmL
308+8105	M5, 50mmL	308+8605	M5, 140mmL
308+8106	M6, 50mmL	308+8606	M6, 140mmL
<b>1/2" Dr. Triple Square Bit Socket:</b>			
410+8308	M8, 80mmL	410+8608	M8, 150mmL
440+8310	M10, 80mmL	440+8610	M10, 150mmL
442+8312	M12, 80mmL	442+8612	M12, 150mmL
444+8314	M14, 80mmL	444+8614	M14, 150mmL
446+8316	M16, 80mmL	446+8616	M16, 150mmL
Blow Case			

2300 g 10 sets / 24 Kgs / 1.16 CUFT



Bit Sockets





# Triple Square Bit Sockets Sets

## BS-2307TS 7 Piece 1/4" & 3/8" Dr. Triple Square Bit Socket Set

Item No.	Size	Item No.	Size
<b>1/4" Dr. Triple Square Bit Socket, 45mmL:</b>			
208+8104	M4	208+8106	M6
208+8105	M5		
<b>3/8" Dr. Triple Square Bit Socket, 50mmL:</b>			
310+8108	M8	342+8112	M12
340+8110	M10	344+8114	M14
Socket Holder			

450 g 20x1 20 sets / 10 Kgs / 0.48 CUFT



## BS-2307TL 7 Piece 1/4" & 3/8" Dr. Triple Square Bit Socket Set

Item No.	Size	Item No.	Size
<b>1/4" Dr. Triple Square Bit Socket, 100mmL:</b>			
208+8504	M4	208+8506	M6
208+8505	M5		
<b>3/8" Dr. Triple Square Bit Socket, 110mmL:</b>			
310+8508	M8	342+8512	M12
340+8510	M10	344+8514	M14
Socket Holder			

680 g 20x1 20 sets / 14.5 Kgs / 0.73 CUFT



## BS-2314TR 14 Piece 1/4" & 3/8" Dr. Triple Square Bit Socket Set

Item No.	Size	Item No.	Size
<b>1/4" Dr. Triple Square Bit Socket:</b>			
208+8104	M4, 45mmL	208+8604	M4, 140mmL
208+8105	M5, 45mmL	208+8605	M5, 140mmL
208+8106	M6, 45mmL	208+8606	M6, 140mmL
<b>3/8" Dr. Triple Square Bit Socket:</b>			
310+8108	M8, 50mmL	310+8608	M8, 140mmL
340+8110	M10, 50mmL	340+8610	M10, 140mmL
342+8112	M12, 50mmL	342+8612	M12, 140mmL
344+8114	M14, 50mmL	344+8614	M14, 140mmL
Blow Case			

1250 g 10 sets / 13.5 Kgs / 0.82 CUFT



## TH-3416 16 Piece 3/8" & 1/2" Dr. Auto Repair Bit Socket Set

Item No.	Size	Item No.	Size
<b>3/8" Dr. Bit Socket:</b>			
308+2336	6mm Hex, 70mmL	310+8508	M8, 105mmL
308+2536	6mm Hex, 105mmL	340+8610	M10, 140mmL
310+2547	7mm Hex, 105mmL	342+8612	M12, 140mmL
310+2548	8mm Hex, 105mmL		
<b>1/2" Dr. Bit Socket:</b>			
410+2785	5mm Hex, 180mmL	440+2570	10mm Hex, 140mmL
410+2676	6mm Hex, 160mmL	442+2172	12mm Hex, 60mmL
410+2896	6mm Hex, 250mmL	447+2177	17mm Hex, 60mmL
410+2568	8mm Hex, 120mmL	440+6555	T-55 Star, 105mmL
410+2898	8mm Hex, 240mmL	Blow Case	

2400 g 6 sets / 15.5 Kgs / 1.21 CUFT



# Slotted & Philips Bit Sockets

1/2

## Slotted Bit Sockets

Item No.	Size mm	Length mm	Weight g	PCS		G.W. KGS	CUFT
				inner/ctn			
408+1165	1.0 x 6.5	55	60	10 / 120	8.5	0.30	
408+1170	1.2 x 7.0	55	60	10 / 120	8.5	0.30	
410+1280	1.2 x 8.0	55	65	10 / 120	9.0	0.30	
410+1290	1.6 x 9.0	55	65	10 / 120	9.0	0.30	
440+1292	2.0 x 12.0	60	85	10 / 120	11.5	0.30	
442+1294	2.5 x 14.0	60	110	10 / 120	14.5	0.30	
444+1296	2.5 x 16.0	60	120	10 / 120	16.0	0.30	
410+1480	1.2 x 8.0	80	80	10 / 200	17.0	0.59	
410+1490	1.6 x 9.0	80	110	10 / 200	23.0	0.59	
440+1492	2.0 x 12.0	80	140	10 / 150	22.0	0.52	
442+1494	2.5 x 14.0	80	140	10 / 150	22.0	0.52	
444+1496	2.5 x 16.0	80	170	10 / 150	26.5	0.52	
410+1580	1.2 x 8.0	110	95	10 / 200	20.0	0.59	
410+1590	1.6 x 9.0	110	130	10 / 200	27.0	0.59	
440+1592	2.0 x 12.0	110	170	10 / 100	18.0	0.62	
442+1594	2.5 x 14.0	110	170	10 / 100	18.0	0.62	
444+1596	2.5 x 16.0	110	210	10 / 100	22.0	0.62	
410+1680	1.2 x 8.0	150	110	10 / 150	17.5	0.52	
410+1690	1.6 x 9.0	150	110	10 / 150	17.5	0.52	
440+1692	2.0 x 12.0	150	150	10 / 100	16.0	0.62	
442+1694	2.5 x 14.0	150	200	10 / 100	21.0	0.62	
444+1696	2.5 x 16.0	150	230	10 / 100	24.0	0.62	
410+1780	1.2 x 8.0	190	120	10 / 100	12.5	0.62	
410+1790	1.6 x 9.0	190	120	10 / 100	12.5	0.62	
440+1792	2.0 x 12.0	190	170	10 / 100	17.5	0.62	
442+1794	2.5 x 14.0	190	230	10 / 80	19.0	0.44	
444+1796	2.5 x 16.0	190	280	5 / 50	15.0	0.62	
410+1880	1.2 x 8.0	230	140	10 / 100	15.0	0.62	
410+1890	1.6 x 9.0	230	140	10 / 100	15.0	0.62	
440+1892	2.0 x 12.0	230	200	10 / 100	21.0	0.62	
442+1894	2.5 x 14.0	230	270	10 / 80	23.0	0.44	
444+1896	2.5 x 16.0	230	320	5 / 50	17.0	0.62	

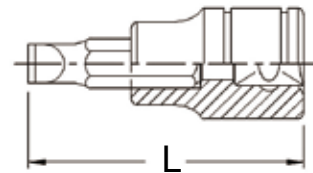

## Philips Bit Sockets

Item No.	Size	Length mm	Weight g	PCS		G.W. KGS	CUFT
				inner/ctn			
408+1102	#2	55	60	10 / 120	8.5	0.30	
408+1103	#3	55	60	10 / 120	8.5	0.30	
410+1124	#4	55	65	10 / 120	9.0	0.30	
408+1302	#2	80	70	10 / 200	15.0	0.59	
408+1303	#3	80	70	10 / 200	15.0	0.59	
410+1404	#4	80	80	10 / 200	17.0	0.59	
408+1502	#2	110	75	10 / 200	16.0	0.59	
408+1503	#3	110	75	10 / 200	16.0	0.59	
410+1504	#4	110	95	10 / 200	20.0	0.59	
408+1602	#2	150	85	10 / 150	14.0	0.52	
408+1603	#3	150	85	10 / 150	14.0	0.52	
410+1604	#4	150	110	10 / 150	17.5	0.52	
408+1702	#2	190	100	10 / 100	10.5	0.62	
408+1703	#3	190	100	10 / 100	10.5	0.62	
410+1704	#4	190	120	10 / 100	13.0	0.62	
408+1802	#2	230	110	10 / 100	12.0	0.62	
408+1803	#3	230	110	10 / 100	12.0	0.62	
410+1804	#4	230	140	10 / 100	15.0	0.62	

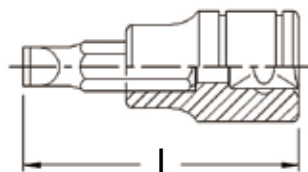

Bit Sockets

1/2

# Hex Bit Sockets

## Metric Hex Bit Sockets

Item No.	Size mm	Length mm	Weight g	PCS	G.W. KGS	CUFT 
				inner/ctn		
408+2134	4	55	55	10 / 120	8.0	0.30
408+2135	5	55	60	10 / 120	8.5	0.30
408+2136	6	55	60	10 / 120	8.5	0.30
410+2147	7	55	65	10 / 120	9.0	0.30
410+2148	8	55	65	10 / 120	9.0	0.30
439+2149	9	55	80	10 / 120	11.0	0.30
440+2150	10	55	85	10 / 120	11.5	0.30
441+2151	11	55	100	10 / 120	14.0	0.30
442+2152	12	55	110	10 / 120	14.5	0.30
408+2334	4	80	65	10 / 200	14.0	0.59
408+2335	5	80	70	10 / 200	15.0	0.59
408+2336	6	80	70	10 / 200	15.0	0.59
410+2347	7	80	80	10 / 200	17.0	0.59
410+2348	8	80	80	10 / 200	17.0	0.59
439+2349	9	80	95	10 / 200	20.0	0.59
440+2350	10	80	100	10 / 200	21.0	0.59
441+2351	11	80	120	10 / 150	19.0	0.52
442+2352	12	80	130	10 / 150	20.5	0.52
443+2353	13	80	140	10 / 150	22.0	0.52
444+2354	14	80	150	10 / 150	23.5	0.52
446+2356	16	80	200	10 / 100	21.0	0.34
447+2357	17	80	210	10 / 100	22.0	0.34
449+2359	19	80	250	10 / 100	26.0	0.62
408+2534	4	110	75	10 / 200	16.0	0.59
408+2535	5	110	75	10 / 200	16.0	0.59
408+2536	6	110	75	10 / 200	16.0	0.59
410+2547	7	110	90	10 / 200	19.0	0.59
410+2548	8	110	95	10 / 200	20.0	0.59
439+2549	9	110	110	10 / 200	23.0	0.59
440+2550	10	110	120	10 / 200	25.0	0.59
441+2551	11	110	140	10 / 100	15.0	0.62
442+2552	12	110	160	10 / 100	17.0	0.62
443+2553	13	110	170	10 / 100	18.0	0.62
444+2554	14	110	190	10 / 100	20.0	0.62
446+2556	16	110	250	10 / 100	26.0	0.62
447+2557	17	110	270	10 / 80	23.0	0.44
449+2559	19	110	320	10 / 80	27.0	0.44
408+2634	4	150	85	10 / 150	14.0	0.52
408+2635	5	150	85	10 / 150	14.0	0.52
408+2636	6	150	85	10 / 150	14.0	0.52
410+2647	7	150	110	10 / 150	17.5	0.52
410+2648	8	150	110	10 / 150	17.5	0.52
439+2649	9	150	120	10 / 150	19.0	0.52
440+2650	10	150	140	10 / 150	22.0	0.52
441+2651	11	150	170	10 / 100	18.0	0.62
442+2652	12	150	190	10 / 100	20.0	0.62
443+2653	13	150	210	10 / 100	22.0	0.62
444+2654	14	150	230	10 / 100	24.0	0.62
446+2656	16	150	320	10 / 80	27.0	0.44
447+2657	17	150	340	5 / 50	18.0	0.62
449+2659	19	150	400	5 / 50	21.0	0.62

• 190 & 230mmL Bit Sockets on the next page.

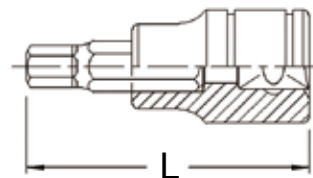

# Hex Bit Sockets

1/2

## Metric Hex Bit Sockets

Item No.	Size mm	Length mm	Weight g	PCS		G.W. KGS	CUFT 
				inner	ctn		
408+2734	4	190	100	10	100	10.5	0.62
408+2735	5	190	100	10	100	10.5	0.62
408+2736	6	190	100	10	100	10.5	0.62
410+2747	7	190	130	10	100	13.5	0.62
410+2748	8	190	130	10	100	13.5	0.62
439+2749	9	190	150	10	100	16.0	0.62
440+2750	10	190	170	10	100	17.5	0.62
441+2751	11	190	200	10	80	16.5	0.44
442+2752	12	190	230	10	80	19.0	0.44
443+2753	13	190	250	5	50	13.0	0.62
444+2754	14	190	280	5	50	15.0	0.62
446+2756	16	190	390	5	50	20.0	0.62
447+2757	17	190	410	5	50	21.0	0.62
449+2759	19	190	480	5	40	20.0	0.44
408+2836	6	230	140	10	100	15.0	0.62
410+2847	7	230	140	10	100	15.0	0.62
410+2848	8	230	140	10	100	15.0	0.62
439+2849	9	230	170	10	100	18.0	0.62
440+2850	10	230	200	10	100	21.0	0.62
441+2851	11	230	230	10	80	19.5	0.44
442+2852	12	230	270	10	80	23.0	0.44
443+2853	13	230	290	5	50	15.5	0.62
444+2854	14	230	320	5	50	17.0	0.62
446+2856	16	230	460	5	50	24.0	0.62
447+2857	17	230	490	5	50	25.5	0.62
449+2859	19	230	570	5	40	24.0	0.44

## SAE Hex Bit Sockets

Item No.	Size inch	Length mm	Weight g	PCS		G.W. KGS	CUFT 
				inner	ctn		
408+3112	3/16	55	60	10	120	8.5	0.30
408+3114	7/32	55	60	10	120	8.5	0.30
408+3116	1/4	55	60	10	120	8.5	0.30
410+3128	9/32	55	65	10	120	9.0	0.30
410+3130	5/16	55	70	10	120	9.5	0.30
412+3134	3/8	55	85	10	120	11.5	0.30
414+3138	7/16	55	100	10	120	14.0	0.30
416+3142	1/2	55	120	10	120	16.0	0.30
408+3310	5/32	80	65	10	200	14.0	0.59
408+3312	3/16	80	70	10	200	15.0	0.59
408+3314	7/32	80	70	10	200	15.0	0.59
408+3316	1/4	80	70	10	200	15.0	0.59
410+3318	9/32	80	80	10	200	17.0	0.59
410+3320	5/16	80	80	10	200	17.0	0.59
412+3324	3/8	80	100	10	200	21.0	0.59
414+3328	7/16	80	120	10	150	19.0	0.52
416+3332	1/2	80	140	10	150	22.0	0.52
418+3336	9/16	80	150	10	150	23.5	0.52
420+3340	5/8	80	190	10	100	20.0	0.34
422+3344	11/16	80	210	10	100	22.0	0.34
424+3348	3/4	80	250	10	100	26.0	0.62

• 110, 150, 190 & 230mmL Bit Sockets on the next page.

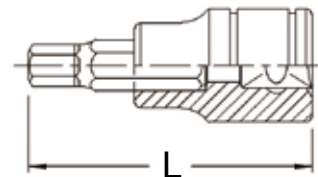

1/2

# Hex Bit Sockets

## SAE Hex Bit Sockets

Item No.	Size inch	Length mm	Weight g	PCS		G.W. KGS	CUFT
				inner/ctn			
408+3510	5/32	110	75	10 / 200		16.0	0.59
408+3512	3/16	110	75	10 / 200		16.0	0.59
408+3514	7/32	110	75	10 / 200		16.0	0.59
408+3516	1/4	110	75	10 / 200		16.0	0.59
410+3518	9/32	110	90	10 / 200		19.0	0.59
410+3520	5/16	110	100	10 / 200		21.0	0.59
412+3524	3/8	110	120	10 / 200		25.0	0.59
414+3528	7/16	110	140	10 / 150		22.0	0.52
416+3532	1/2	110	170	10 / 100		18.0	0.62
418+3536	9/16	110	190	10 / 100		20.0	0.62
420+3540	5/8	110	250	10 / 100		26.0	0.62
422+3544	11/16	110	280	10 / 80		23.0	0.44
424+3548	3/4	110	320	10 / 80		27.0	0.44
408+3610	5/32	150	85	10 / 150		14.0	0.52
408+3612	3/16	150	85	10 / 150		14.0	0.52
408+3614	7/32	150	85	10 / 150		14.0	0.52
408+3616	1/4	150	85	10 / 150		14.0	0.52
410+3618	9/32	150	110	10 / 150		17.5	0.52
410+3620	5/16	150	110	10 / 150		17.5	0.52
412+3624	3/8	150	140	10 / 150		23.0	0.52
414+3628	7/16	150	170	10 / 100		18.5	0.62
416+3632	1/2	150	200	10 / 100		21.0	0.62
418+3636	9/16	150	230	10 / 100		24.0	0.62
420+3640	5/8	150	320	10 / 80		26.5	0.44
422+3644	11/16	150	350	5 / 50		18.5	0.62
424+3648	3/4	150	370	5 / 50		19.5	0.62
408+3710	5/32	190	100	10 / 100		10.5	0.62
408+3712	3/16	190	100	10 / 100		10.5	0.62
408+3714	7/32	190	100	10 / 100		10.5	0.62
408+3716	1/4	190	100	10 / 100		10.5	0.62
410+3718	9/32	190	120	10 / 100		12.5	0.62
410+3720	5/16	190	120	10 / 100		12.5	0.62
412+3724	3/8	190	160	10 / 100		17.0	0.62
414+3728	7/16	190	190	10 / 80		16.0	0.44
416+3732	1/2	190	240	5 / 50		12.5	0.62
418+3736	9/16	190	370	5 / 50		19.5	0.62
420+3740	5/8	190	380	5 / 50		19.5	0.62
422+3744	11/16	190	420	5 / 50		21.5	0.62
424+3748	3/4	190	450	5 / 40		18.5	0.44
408+3816	1/4	230	110	10 / 100		12.0	0.62
410+3818	9/32	230	140	10 / 100		15.0	0.62
410+3820	5/16	230	140	10 / 100		15.0	0.62
412+3824	3/8	230	190	10 / 100		20.0	0.62
414+3828	7/16	230	240	10 / 80		20.0	0.44
416+3832	1/2	230	290	5 / 50		15.5	0.62
418+3836	9/16	230	330	5 / 50		17.5	0.62
420+3840	5/8	230	460	5 / 50		24.0	0.62
422+3844	11/16	230	500	5 / 50		26.0	0.62
424+3848	3/4	230	570	5 / 40		24.0	0.44

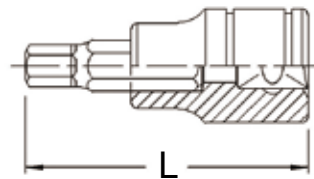

Made of High Speed Tool Steel

# Wobble Hex Bit Sockets

1/2



## Metric Wobble Hex Bit Sockets

Item No.	Size mm	Length mm	Weight g	PCS		G.W. KGS	CUFT 
				inner	ctn		
408+4335	5	80	65	10	200	14.0	0.59
408+4336	6	80	70	10	200	15.0	0.59
410+4347	7	80	80	10	200	17.0	0.59
410+4348	8	80	80	10	200	17.0	0.59
439+4349	9	80	100	10	200	21.0	0.59
440+4350	10	80	110	10	200	23.0	0.59
408+4535	5	110	75	10	200	16.0	0.59
408+4536	6	110	75	10	200	16.0	0.59
410+4547	7	110	90	10	200	19.0	0.59
410+4548	8	110	90	10	200	19.0	0.59
439+4549	9	110	110	10	200	23.0	0.59
440+4550	10	110	130	10	200	27.0	0.59
408+4635	5	150	85	10	150	14.0	0.52
408+4636	6	150	85	10	150	14.0	0.52
410+4647	7	150	110	10	150	17.5	0.52
410+4648	8	150	110	10	150	17.5	0.52
439+4649	9	150	140	10	150	22.0	0.52
440+4650	10	150	160	10	150	25.0	0.52
408+4735	5	190	100	10	100	10.5	0.62
408+4736	6	190	100	10	100	10.5	0.62
410+4747	7	190	120	10	100	12.5	0.62
410+4748	8	190	120	10	100	12.5	0.62
439+4749	9	190	150	10	100	16.0	0.62
440+4750	10	190	170	10	100	17.5	0.62
408+4836	6	230	110	10	100	12.0	0.62
410+4847	7	230	140	10	100	15.0	0.62
410+4848	8	230	140	10	100	15.0	0.62
439+4849	9	230	180	10	100	19.0	0.62
440+4850	10	230	210	10	100	22.0	0.62

## SAE Wobble Hex Bit Sockets

Item No.	Size inch	Length mm	Weight g	PCS		G.W. KGS	CUFT 
				inner	ctn		
408+5312	3/16	80	65	10	200	14.0	0.59
408+5314	7/32	80	70	10	200	15.0	0.59
408+5316	1/4	80	70	10	200	15.0	0.59
410+5318	9/32	80	80	10	200	17.0	0.59
410+5320	5/16	80	80	10	200	17.0	0.59
412+5324	3/8	80	110	10	200	23.0	0.59
408+5512	3/16	110	75	10	200	16.0	0.59
408+5514	7/32	110	75	10	200	16.0	0.59
408+5516	1/4	110	75	10	200	16.0	0.59
410+5518	9/32	110	90	10	200	19.0	0.59
410+5520	5/16	110	95	10	200	20.0	0.59
412+5524	3/8	110	130	10	200	27.0	0.59
408+5612	3/16	150	85	10	150	14.0	0.52
408+5614	7/32	150	85	10	150	14.0	0.52
408+5616	1/4	150	85	10	150	14.0	0.52
410+5618	9/32	150	110	10	150	17.5	0.52
410+5620	5/16	150	110	10	150	17.5	0.52
412+5624	3/8	150	150	10	150	23.5	0.52
408+5712	3/16	190	100	10	100	10.5	0.62
408+5714	7/32	190	100	10	100	10.5	0.62
408+5716	1/4	190	100	10	100	10.5	0.62
410+5718	9/32	190	120	10	100	12.5	0.62
410+5720	5/16	190	120	10	100	12.5	0.62
412+5724	3/8	190	160	10	100	17.0	0.62
408+5816	1/4	230	110	10	100	12.0	0.62
410+5818	9/32	230	140	10	100	15.0	0.62
410+5820	5/16	230	140	10	100	15.0	0.62
412+5824	3/8	230	200	10	100	21.0	0.62

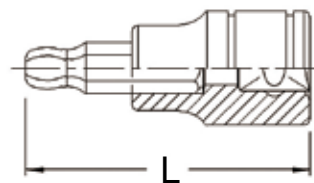

Bit Sockets

1/2

# Pentacle & Ribe Bit Sockets

## Pentacle Bit Sockets

Item No.	Size mm	Length mm	Weight g	PCS		G.W. KGS	CUFT 
				inner/ctn			
408+5020	T-20	55	60	10 / 120	8.5	0.30	
408+5025	T-25	55	60	10 / 120	8.5	0.30	
408+5027	T-27	55	60	10 / 120	8.5	0.30	
408+5030	T-30	55	60	10 / 120	8.5	0.30	
410+5040	T-40	55	60	10 / 120	8.5	0.30	
410+5045	T-45	55	70	10 / 120	9.0	0.30	
440+5050	T-50	55	80	10 / 120	11.0	0.30	
442+5055	T-55	55	110	10 / 120	14.0	0.30	
408+5220	T-20	80	65	10 / 200	14.0	0.59	
408+5225	T-25	80	65	10 / 200	14.0	0.59	
408+5227	T-27	80	65	10 / 200	14.0	0.59	
408+5230	T-30	80	70	10 / 200	15.0	0.59	
410+5240	T-40	80	80	10 / 200	17.0	0.59	
410+5245	T-45	80	80	10 / 200	17.0	0.59	
440+5250	T-50	80	110	10 / 200	23.0	0.59	
442+5255	T-55	80	140	10 / 150	22.0	0.52	
408+5420	T-20	110	75	10 / 200	16.0	0.59	
408+5425	T-25	110	75	10 / 200	16.0	0.59	
408+5427	T-27	110	75	10 / 200	16.0	0.59	
408+5430	T-30	110	75	10 / 200	16.0	0.59	
410+5440	T-40	110	90	10 / 200	19.0	0.59	
410+5445	T-45	110	90	10 / 200	19.0	0.59	
440+5450	T-50	110	130	10 / 200	27.0	0.59	
442+5455	T-55	110	170	10 / 100	18.0	0.62	

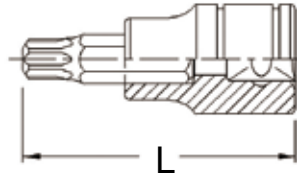

## Ribe Bit Sockets

Item No.	Size mm	Length mm	Weight g	PCS		G.W. KGS	CUFT 
				inner/ctn			
408+9004	M4	55	60	10 / 120	8.5	0.30	
408+9005	M5	55	60	10 / 120	8.5	0.30	
408+9006	M6	55	60	10 / 120	8.5	0.30	
410+9007	M7	55	70	10 / 120	9.0	0.30	
410+9008	M8	55	70	10 / 120	9.0	0.30	
440+9009	M9	55	80	10 / 120	11.0	0.30	
440+9010	M10	55	80	10 / 120	11.0	0.30	
442+9012	M12	55	110	10 / 120	14.0	0.30	
444+9013	M13	55	120	10 / 120	15.5	0.30	
444+9014	M14	55	120	10 / 120	15.5	0.30	
446+9016	M16	55	150	10 / 120	19.0	0.30	
408+9204	M4	80	65	10 / 200	14.0	0.59	
408+9205	M5	80	65	10 / 200	14.0	0.59	
408+9206	M6	80	70	10 / 200	15.0	0.59	
410+9207	M7	80	80	10 / 200	17.0	0.59	
410+9208	M8	80	80	10 / 200	17.0	0.59	
440+9209	M9	80	110	10 / 200	23.0	0.59	
440+9210	M10	80	110	10 / 200	23.0	0.59	
442+9212	M12	80	140	10 / 150	22.0	0.52	
444+9213	M13	80	160	10 / 150	25.0	0.52	
444+9214	M14	80	160	10 / 150	25.0	0.52	
446+9216	M16	80	200	10 / 100	21.0	0.34	
408+9404	M4	110	75	10 / 200	16.0	0.59	
408+9405	M5	110	75	10 / 200	16.0	0.59	
408+9406	M6	110	80	10 / 200	17.0	0.59	
410+9407	M7	110	90	10 / 200	19.0	0.59	
410+9408	M8	110	90	10 / 200	19.0	0.59	
440+9409	M9	110	130	10 / 200	27.0	0.59	
440+9410	M10	110	130	10 / 200	27.0	0.59	
442+9412	M12	110	170	10 / 100	18.0	0.62	
444+9413	M13	110	210	10 / 100	22.0	0.62	
444+9414	M14	110	210	10 / 100	22.0	0.62	
446+9416	M16	110	250	10 / 100	26.0	0.62	

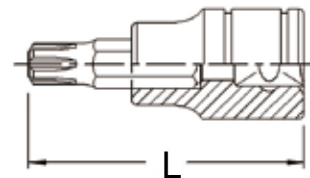

# Star Bit Sockets

1/2

## Star Bit Sockets

Item No.	Size	Length mm	Weight g	PCS		G.W. KGS	CUFT
				inner	ctn		
408+6120	T-20	55	60	10	120	8.5	0.30
408+6125	T-25	55	60	10	120	8.5	0.30
408+6127	T-27	55	60	10	120	8.5	0.30
408+6130	T-30	55	60	10	120	8.5	0.30
408+6140	T-40	55	60	10	120	8.5	0.30
410+6245	T-45	55	65	10	120	9.0	0.30
410+6250	T-50	55	65	10	120	9.0	0.30
440+6255	T-55	55	90	10	120	12.0	0.30
442+6260	T-60	60	120	10	120	15.5	0.30
444+6270	T-70	60	130	10	120	17.0	0.30
408+6320	T-20	80	65	10	200	14.0	0.59
408+6325	T-25	80	65	10	200	14.0	0.59
408+6327	T-27	80	65	10	200	14.0	0.59
408+6330	T-30	80	70	10	200	15.0	0.59
408+6340	T-40	80	70	10	200	15.0	0.59
410+6345	T-45	80	80	10	200	17.0	0.59
410+6350	T-50	80	80	10	200	17.0	0.59
440+6355	T-55	80	110	10	200	23.0	0.59
442+6360	T-60	80	140	10	150	22.0	0.52
444+6370	T-70	80	170	10	150	26.5	0.52
408+6520	T-20	110	75	10	200	16.0	0.59
408+6525	T-25	110	75	10	200	16.0	0.59
408+6527	T-27	110	75	10	200	16.0	0.59
408+6530	T-30	110	75	10	200	16.0	0.59
408+6540	T-40	110	75	10	200	16.0	0.59
410+6545	T-45	110	95	10	200	20.0	0.59
410+6550	T-50	110	95	10	200	20.0	0.59
440+6555	T-55	110	130	10	200	27.0	0.59
442+6560	T-60	110	170	10	100	18.0	0.62
444+6570	T-70	110	210	10	100	22.0	0.62
408+6620	T-20	150	85	10	150	14.0	0.52
408+6625	T-25	150	85	10	150	14.0	0.52
408+6627	T-27	150	85	10	150	14.0	0.52
408+6630	T-30	150	85	10	150	14.0	0.52
408+6640	T-40	150	85	10	150	14.0	0.52
410+6645	T-45	150	110	10	150	17.5	0.52
410+6650	T-50	150	110	10	150	17.5	0.52
440+6655	T-55	150	160	10	150	25.0	0.52
442+6660	T-60	150	210	10	100	22.0	0.62
444+6670	T-70	150	260	10	100	27.0	0.62
408+6720	T-20	190	100	10	100	10.5	0.62
408+6725	T-25	190	100	10	100	10.5	0.62
408+6727	T-27	190	100	10	100	10.5	0.62
408+6730	T-30	190	100	10	100	10.5	0.62
408+6740	T-40	190	100	10	100	10.5	0.62
410+6745	T-45	190	120	10	100	12.5	0.62
410+6750	T-50	190	120	10	100	12.5	0.62
440+6755	T-55	190	170	10	100	17.5	0.62
442+6760	T-60	190	230	10	80	19.0	0.44
444+6770	T-70	190	280	5	50	15.0	0.62
408+6830	T-30	230	110	10	100	12.0	0.62
408+6840	T-40	230	110	10	100	12.0	0.62
410+6845	T-45	230	140	10	100	15.0	0.62
410+6850	T-50	230	140	10	100	15.0	0.62
440+6855	T-55	230	210	10	100	22.0	0.62
442+6860	T-60	230	280	10	80	23.5	0.44
444+6870	T-70	230	360	5	50	19.0	0.62

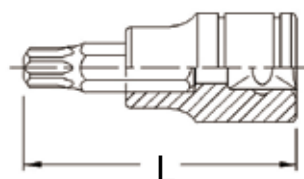

Bit Sockets



1/2

# Tamperproof Star Bit Sockets

## Tamperproof Star Bit Sockets

Item No.	Size	Length mm	Weight g	PCS inner/ctn	G.W. KGS	CUFT
						
408+7120	T-20	55	60	10 / 120	8.5	0.30
408+7125	T-25	55	60	10 / 120	8.5	0.30
408+7127	T-27	55	60	10 / 120	8.5	0.30
408+7130	T-30	55	60	10 / 120	8.5	0.30
408+7140	T-40	55	60	10 / 120	8.5	0.30
410+7145	T-45	55	70	10 / 120	9.5	0.30
410+7150	T-50	55	70	10 / 120	9.5	0.30
440+7155	T-55	55	90	10 / 120	12.0	0.30
442+7160	T-60	60	120	10 / 120	15.5	0.30
444+7170	T-70	60	130	10 / 120	17.0	0.30
408+7320	T-20	80	65	10 / 200	14.0	0.59
408+7325	T-25	80	65	10 / 200	14.0	0.59
408+7327	T-27	80	65	10 / 200	14.0	0.59
408+7330	T-30	80	70	10 / 200	15.0	0.59
408+7340	T-40	80	70	10 / 200	15.0	0.59
410+7345	T-45	80	80	10 / 200	17.0	0.59
410+7350	T-50	80	80	10 / 200	17.0	0.59
440+7355	T-55	80	110	10 / 200	23.0	0.59
442+7360	T-60	80	140	10 / 150	22.0	0.52
444+7370	T-70	80	170	10 / 150	26.5	0.52
408+7520	T-20	110	75	10 / 200	16.0	0.59
408+7525	T-25	110	75	10 / 200	16.0	0.59
408+7527	T-27	110	75	10 / 200	16.0	0.59
408+7530	T-30	110	75	10 / 200	16.0	0.59
408+7540	T-40	110	75	10 / 200	16.0	0.59
410+7545	T-45	110	90	10 / 200	19.0	0.59
410+7550	T-50	110	95	10 / 200	19.0	0.59
440+7555	T-55	110	130	10 / 200	27.0	0.59
442+7560	T-60	110	170	10 / 100	18.0	0.62
444+7570	T-70	110	210	10 / 100	22.0	0.62
408+7620	T-20	150	85	10 / 150	14.0	0.52
408+7625	T-25	150	85	10 / 150	14.0	0.52
408+7627	T-27	150	85	10 / 150	14.0	0.52
408+7630	T-30	150	85	10 / 150	14.0	0.52
408+7640	T-40	150	85	10 / 150	14.0	0.52
410+7645	T-45	150	110	10 / 150	17.5	0.52
410+7650	T-50	150	110	10 / 150	17.5	0.52
440+7655	T-55	150	160	10 / 150	25.0	0.52
442+7660	T-60	150	210	10 / 100	22.0	0.62
444+7670	T-70	150	260	10 / 100	27.0	0.62
408+7720	T-20	190	100	10 / 100	10.5	0.62
408+7725	T-25	190	100	10 / 100	10.5	0.62
408+7727	T-27	190	100	10 / 100	10.5	0.62
408+7730	T-30	190	100	10 / 100	10.5	0.62
408+7740	T-40	190	100	10 / 100	10.5	0.62
410+7745	T-45	190	120	10 / 100	12.5	0.62
410+7750	T-50	190	120	10 / 100	12.5	0.62
440+7755	T-55	190	170	10 / 100	17.5	0.62
442+7760	T-60	190	230	10 / 80	19.0	0.44
444+7770	T-70	190	280	5 / 50	15.0	0.62
408+7830	T-30	230	110	10 / 100	12.0	0.62
408+7840	T-40	230	110	10 / 100	12.0	0.62
410+7845	T-45	230	140	10 / 100	15.0	0.62
410+7850	T-50	230	140	10 / 100	15.0	0.62
440+7855	T-55	230	210	10 / 100	22.0	0.62
442+7860	T-60	230	280	10 / 80	23.5	0.44
444+7870	T-70	230	360	5 / 50	19.0	0.62

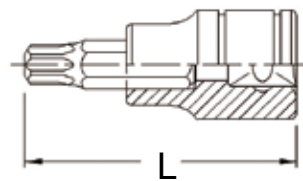

# Triple Square Bit Sockets

1/2

## Triple Square Bit Sockets

Item No.	Size	Length mm	Weight g	PCS	G.W. KGS	CUFT
				inner/ctn		
408+8104	M4	55	55	10 / 120	8.0	0.30
408+8105	M5	55	60	10 / 120	8.5	0.30
408+8106	M6	55	60	10 / 120	8.5	0.30
410+8108	M8	55	65	10 / 120	9.0	0.30
440+8110	M10	55	85	10 / 120	11.5	0.30
442+8112	M12	55	100	10 / 120	14.0	0.30
444+8114	M14	55	125	10 / 120	16.0	0.30
446+8116	M16	60	160	10 / 100	17.0	0.34
449+8118	M18	60	200	10 / 100	21.0	0.34
408+8304	M4	80	65	10 / 200	14.0	0.59
408+8305	M5	80	65	10 / 200	14.0	0.59
408+8306	M6	80	70	10 / 200	15.0	0.59
410+8308	M8	80	80	10 / 200	17.0	0.59
440+8310	M10	80	110	10 / 200	23.0	0.59
442+8312	M12	80	140	10 / 150	22.0	0.52
444+8314	M14	80	160	10 / 150	25.0	0.52
446+8316	M16	80	200	10 / 100	21.0	0.34
449+8318	M18	80	260	5 / 50	13.0	0.34
408+8504	M4	110	75	10 / 200	16.0	0.59
408+8505	M5	110	75	10 / 200	16.0	0.59
408+8506	M6	110	80	10 / 200	17.0	0.59
410+8508	M8	110	90	10 / 200	19.0	0.59
440+8510	M10	110	130	10 / 200	27.0	0.59
442+8512	M12	110	170	10 / 100	18.0	0.62
444+8514	M14	110	210	10 / 100	22.0	0.62
446+8516	M16	110	250	10 / 100	26.0	0.62
408+8604	M4	150	85	10 / 150	14.0	0.52
408+8605	M5	150	85	10 / 150	14.0	0.52
408+8606	M6	150	90	10 / 150	14.5	0.52
410+8608	M8	150	110	10 / 150	17.5	0.52
440+8610	M10	150	150	10 / 150	23.5	0.52
442+8612	M12	150	210	10 / 100	22.0	0.62
444+8614	M14	150	260	10 / 100	27.0	0.62
446+8616	M16	150	320	10 / 80	27.0	0.44
408+8704	M4	190	100	10 / 100	10.5	0.62
408+8705	M5	190	100	10 / 100	10.5	0.62
408+8706	M6	190	100	10 / 100	10.5	0.62
410+8708	M8	190	120	10 / 100	12.5	0.62
440+8710	M10	190	170	10 / 100	17.5	0.62
442+8712	M12	190	230	10 / 80	19.0	0.44
444+8714	M14	190	280	5 / 50	15.0	0.62
446+8716	M16	190	390	5 / 50	20.0	0.62
408+8806	M6	230	110	10 / 100	12.0	0.62
410+8808	M8	230	140	10 / 100	15.0	0.62
440+8810	M10	230	210	10 / 100	22.0	0.62
442+8812	M12	230	280	10 / 80	23.5	0.44
444+8814	M14	230	340	5 / 50	18.0	0.62
446+8816	M16	230	430	5 / 50	22.5	0.62

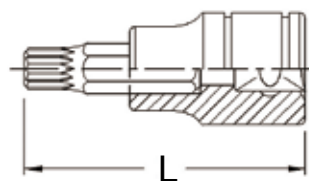

Bit Sockets

**3/8**   **1/2**

# Bit Socket Sets

## BS-410M 10 Piece 1/2" Dr. Triple Square Bit Socket Set

Item No.	Size	Item No.	Size
<b>1/2" Dr. Triple Square Bit Socket, 55mmL:</b>			
408+8105	M5	440+8110	M10
408+8106	M6	442+8112	M12
410+8108	M8	444+8114	M14
<b>1/2" Dr. Triple Square Bit Socket, 110mmL:</b>			
408+8506	M6	440+8510	M10
410+8508	M8	442+8512	M12
Socket Holder			

1130 g   12x1 12 sets / 14.5 Kgs / 0.69 CUFT



## BS-408PE 8 Piece 1/2" Dr. Pentacle Bit Socket Set

Item No.	Size	Item No.	Size
<b>1/2" Dr. Bit Socket, 55mmL:</b>			
408+5020	T-20	410+5040	T-40
408+5025	T-25	410+5045	T-45
408+5027	T-27	440+5050	T-50
408+5030	T-30	442+5055	T-55
Socket Holder			

650 g   5x4 20 sets / 14 Kgs / 0.71 CUFT



## BS-407P 7 Piece 1/2" Dr. Slotted & Philips Bit Socket Set

Item No.	Size	Item No.	Size
<b>1/2" Dr. Bit Socket, 55mmL:</b>			
408+1170	1.2 x 7.0mm	408+1102	#2 Philips
410+1280	1.2 x 8.0mm	408+1103	#3 Philips
410+1290	1.6 x 9.0mm	410+1124	#4 Philips
440+1292	2.0 x 12.0mm(60mmL)	Socket Holder	

570 g   5x4 20 sets / 12.5 Kgs / 0.71 CUFT



## BS-3424P 24 Piece 3/8" & 1/2" Dr. Slotted & Philips Bit Socket Set

Item No.	Size	Item No.	Size
<b>3/8" Dr. Bit Socket:</b>			
308+1140	0.6 x 4.0mm, 50mmL	308+1640	0.6 x 4.0mm, 140mmL
308+1150	0.8 x 5.0mm, 50mmL	308+1650	0.8 x 5.0mm, 140mmL
308+1160	1.0 x 6.0mm, 50mmL	308+1660	1.0 x 6.0mm, 140mmL
310+1280	1.2 x 8.0mm, 50mmL	310+1680	1.2 x 8.0mm, 140mmL
310+1290	1.6 x 9.0mm, 50mmL	310+1690	1.6 x 9.0mm, 140mmL
308+1101	#1 Philips, 50mmL	308+1601	#1 Philips, 140mmL
308+1102	#2 Philips, 50mmL	308+1602	#2 Philips, 140mmL
<b>1/2" Dr. Bit Socket:</b>			
440+1492	2.0 x 12.0mm, 80mmL	440+1692	2.0 x 12.0mm, 150mmL
442+1494	2.5 x 14.0mm, 80mmL	442+1694	2.5 x 14.0mm, 150mmL
444+1496	2.5 x 16.0mm, 80mmL	444+1696	2.5 x 16.0mm, 150mmL
408+1303	#3 Philips, 80mmL	408+1603	#3 Philips, 150mmL
410+1404	#4 Philips, 80mmL	410+1604	#4 Philips, 150mmL

2500 g   5 sets / 13.5 Kgs / 0.93 CUFT



(192W x 406D)



# Hex Bit Socket Sets

1/2

## BS-407H 7 Piece 1/2" Dr. SAE Hex Bit Socket Set

Item No.	Size	Item No.	Size
<b>1/2" Dr. Hex Bit Socket, 80mmL:</b>			
410+3320	5/16"	418+3336	9/16"
412+3324	3/8"	420+3340	5/8"
414+3328	7/16"	424+3348	3/4"
416+3332	1/2"	Socket Holder	

1150 g 3x4 12 sets / 15 Kgs / 0.71 CUFT



## BS-408H 8 Piece 1/2" Dr. Metric Hex Bit Socket Set

Item No.	Size	Item No.	Size
<b>1/2" Dr. Hex Bit Socket, 55mmL:</b>			
408+2134	4mm	410+2148	8mm
408+2135	5mm	439+2149	9mm
408+2136	6mm	440+2150	10mm
410+2147	7mm	442+2152	12mm
Socket Holder			

630 g 5x4 20 sets / 13.5 Kgs / 0.71 CUFT



## BS-409L 9 Piece 1/2" Dr. Metric Hex Bit Socket Set

Item No.	Size	Item No.	Size
<b>1/2" Dr. Hex Bit Socket:</b>			
408+2134	4mm, 55mmL	408+2535	5mm, 110mmL
408+2135	5mm, 55mmL	408+2536	6mm, 110mmL
408+2136	6mm, 55mmL	410+2548	8mm, 110mmL
410+2148	8mm, 55mmL	440+2650	10mm, 150mmL
440+2150	10mm, 55mmL	Socket Holder	

900 g 10x1 10 sets / 10 Kgs / 0.77 CUFT



## MS-442B 42 Piece 1/2" Dr. Complete Bit Socket Set

Item No.	Size	Item No.	Size
<b>1/2" Dr. Hex Bit Socket:</b>			
408+2135	5mm, 55mmL	447+2357	17mm, 80mmL
408+2136	6mm, 55mmL	449+2359	19mm, 80mmL
410+2147	7mm, 55mmL	408+2535	5mm, 110mmL
410+2148	8mm, 55mmL	408+2536	6mm, 110mmL
439+2149	9mm, 55mmL	410+2547	7mm, 110mmL
440+2150	10mm, 55mmL	410+2548	8mm, 110mmL
442+2152	12mm, 55mmL	440+2550	10mm, 110mmL
444+2354	14mm, 80mmL	442+2552	12mm, 110mmL
<b>1/2" Dr. Star Bit Socket:</b>			
408+6130	T-30, 55mmL	408+6530	T-30, 110mmL
408+6140	T-40, 55mmL	408+6540	T-40, 110mmL
410+6245	T-45, 55mmL	410+6545	T-45, 110mmL
410+6250	T-50, 55mmL	410+6550	T-50, 110mmL
440+6255	T-55, 55mmL	440+6555	T-55, 110mmL
442+6260	T-60, 60mmL	442+6560	T-60, 110mmL
444+6270	T-70, 60mmL	444+6570	T-70, 110mmL
<b>1/2" Dr. Triple Square Bit Socket:</b>			
408+8106	M6, 55mmL	449+8118	M18, 60mmL
410+8108	M8, 55mmL	410+8508	M8, 110mmL
440+8110	M10, 55mmL	440+8510	M10, 110mmL
442+8112	M12, 55mmL	442+8512	M12, 110mmL
444+8114	M14, 55mmL	444+8514	M14, 110mmL
446+8116	M16, 60mmL	446+8516	M16, 110mmL

Plastic Tray

5100 g 3 sets / 17 Kgs / 1.35 CUFT



(285W x 410D x 50H)

**3/8**   **1/2**

# Hex Bit Socket Sets

## BS-409H 9 Piece 1/2" Dr. Metric Hex Bit Socket Set

Item No.	Size	Item No.	Size
<b>1/2" Dr. Hex Bit Socket, 80mmL:</b>			
408+2334	4mm	440+2350	10mm
408+2335	5mm	442+2352	12mm
408+2336	6mm	444+2354	14mm
410+2347	7mm	447+2357	17mm
410+2348	8mm	Blow Case	

1170 g   20 sets / 24.5 Kgs / 1.5 CUFT



## BS-3428H 28 Piece 3/8" & 1/2" Dr. Metric Hex Bit Socket Set

Item No.	Size	Item No.	Size
<b>3/8" Dr. Hex Bit Socket:</b>			
308+2133	3mm, 50mmL	308+2633	3mm, 140mmL
308+2134	4mm, 50mmL	308+2634	4mm, 140mmL
308+2135	5mm, 50mmL	308+2635	5mm, 140mmL
308+2136	6mm, 50mmL	308+2636	6mm, 140mmL
310+2147	7mm, 50mmL	310+2647	7mm, 140mmL
310+2148	8mm, 50mmL	310+2648	8mm, 140mmL

Item No.	Size	Item No.	Size
<b>1/2" Dr. Hex Bit Socket:</b>			
439+2349	9mm, 80mmL	439+2649	9mm, 150mmL
440+2350	10mm, 80mmL	440+2650	10mm, 150mmL
441+2351	11mm, 80mmL	441+2651	11mm, 150mmL
442+2352	12mm, 80mmL	442+2652	12mm, 150mmL
443+2353	13mm, 80mmL	443+2653	13mm, 150mmL
444+2354	14mm, 80mmL	444+2654	14mm, 150mmL
446+2356	16mm, 80mmL	446+2656	16mm, 150mmL
447+2357	17mm, 80mmL	447+2657	17mm, 150mmL

Blow Case

4600 g   5 sets / 24 Kgs / 1.21 CUFT



## BS-3424H 24 Piece 3/8" & 1/2" Dr. SAE Hex Bit Socket Set

Item No.	Size	Item No.	Size
<b>3/8" Dr. Hex Bit Socket:</b>			
308+3108	1/8", 50mmL	308+3608	1/8", 140mmL
308+3110	5/32", 50mmL	308+3610	5/32", 140mmL
308+3112	3/16", 50mmL	308+3612	3/16", 140mmL
308+3114	7/32", 50mmL	308+3614	7/32", 140mmL
308+3116	1/4", 50mmL	308+3616	1/4", 140mmL
310+3128	9/32", 50mmL	310+3618	9/32", 140mmL
310+3130	5/16", 50mmL	310+3620	5/16", 140mmL

Item No.	Size	Item No.	Size
<b>1/2" Dr. Hex Bit Socket:</b>			
412+3324	3/8", 80mmL	412+3624	3/8", 150mmL
414+3328	7/16", 80mmL	414+3628	7/16", 150mmL
416+3332	1/2", 80mmL	416+3632	1/2", 150mmL
418+3336	9/16", 80mmL	418+3636	9/16", 150mmL
420+3340	5/8", 80mmL	420+3640	5/8", 150mmL

Plastic Tray

3250 g   5 sets / 17.5 Kgs / 0.93 CUFT



(192W x 406D)



# Star Bit Socket Sets

3/8

1/2

## BS-408T 8 Piece 1/2" Dr. Star Bit Socket Set

Item No.	Size	Item No.	Size
<b>1/2" Dr. Star Bit Socket, 55mmL:</b>			
408+6120	T-20	408+6140	T-40
408+6125	T-25	410+6245	T-45
408+6127	T-27	410+6250	T-50
408+6130	T-30	440+6255	T-55
Socket Holder			

630 g 5x4 20 sets / 13.5 Kgs / 0.71 CUFT



## BS-409T 9 Piece 1/2" Dr. Star Bit Socket Set

Item No.	Size	Item No.	Size
<b>1/2" Dr. Star Bit Socket, 80mmL:</b>			
408+6320	T-20	410+6345	T-45
408+6325	T-25	410+6350	T-50
408+6327	T-27	440+6355	T-55
408+6330	T-30	442+6360	T-60
408+6340	T-40	Blow Case	

930 g 20 sets / 19.5 Kgs / 1.5 CUFT



## BS-3424T 24 Piece 3/8" & 1/2" Dr. Star Bit Socket Set

Item No.	Size	Item No.	Size
<b>3/8" Dr. Star Bit Socket:</b>			
308+6110	T-10, 50mmL	308+6610	T-10, 140mmL
308+6115	T-15, 50mmL	308+6615	T-15, 140mmL
308+6120	T-20, 50mmL	308+6620	T-20, 140mmL
308+6125	T-25, 50mmL	308+6625	T-25, 140mmL
308+6127	T-27, 50mmL	308+6627	T-27, 140mmL
308+6130	T-30, 50mmL	308+6630	T-30, 140mmL
308+6140	T-40, 50mmL	308+6640	T-40, 140mmL
<b>1/2" Dr. Star Bit Socket:</b>			
410+6345	T-45, 80mmL	410+6645	T-45, 150mmL
410+6350	T-50, 80mmL	410+6650	T-50, 150mmL
440+6355	T-55, 80mmL	440+6655	T-55, 150mmL
442+6360	T-60, 80mmL	442+6660	T-60, 150mmL
444+6370	T-70, 80mmL	444+6670	T-70, 150mmL

Plastic Tray

2650 g 5 sets / 14.5 Kgs / 0.93 CUFT



(192W x 406D)

## TX-412 12 Piece 1/2" Dr. Bit Socket Set

Item No.	Size	Item No.	Size
<b>1/2" Dr. Bit Socket:</b>			
408+2735	5mm Hex, 190mmL	410+6550	T-50 Star, 110mmL
408+2536	6mm Hex, 110mmL	444+6670	T-70 Star, 150mmL
410+2547	7mm Hex, 110mmL	408+8506	M6 Triple Square, 110mmL
410+2548	8mm Hex, 110mmL	410+8508	M8 Triple Square, 110mmL
408+6540	T-40 Star, 110mmL	440+8510	M10 Triple Square, 110mmL
410+6545	T-45 Star, 110mmL	442+8512	M12 Triple Square, 110mmL

Plastic Tray

1600 g 10 sets / 17 Kgs / 0.93 CUFT



(192W x 203D)

Bit Sockets

**3/8**   **1/2**

# Tamperproof Star Bit Socket Sets

## BS-410TA 10 Piece 1/2" Dr. Tamperproof Star Bit Socket Set

Item No.	Size	Item No.	Size
<b>1/2" Dr. Tamperproof Star Bit Socket, 55mmL:</b>			
408+7120	T-20	408+7140	T-40
408+7125	T-25	410+7145	T-45
408+7127	T-27	410+7150	T-50
408+7130	T-30	440+7155	T-55
<b>1/2" Dr. Bit Socket, 60mmL:</b>			
442+7160	T-60	444+7170	T-70
Socket Holder			

900 g   5x3 15 sets / 14.5 Kgs / 0.95 CUFT



## BS-410TB 10 Piece 1/2" Dr. Tamperproof Star Bit Socket Set

Item No.	Size	Item No.	Size
<b>1/2" Dr. Tamperproof Star Bit Socket, 110mmL:</b>			
408+7520	T-20	410+7545	T-45
408+7525	T-25	410+7550	T-50
408+7527	T-27	440+7555	T-55
408+7530	T-30	442+7560	T-60
408+7540	T-40	444+7570	T-70
Socket Holder			

1250 g   12x1 12 sets / 16 Kgs / 0.69 CUFT



## BS-410TC 10 Piece 1/2" Dr. Tamperproof Star Bit Socket Set

Item No.	Size	Item No.	Size
<b>1/2" Dr. Tamperproof Star Bit Socket, 150mmL:</b>			
408+7620	T-20	410+7645	T-45
408+7625	T-25	410+7650	T-50
408+7627	T-27	440+7655	T-55
408+7630	T-30	442+7660	T-60
408+7640	T-40	444+7670	T-70
Socket Holder			

1400 g   10x1 10 sets / 15 Kgs / 0.77 CUFT



## BS-3424TA 24 Piece 3/8" & 1/2" Dr. Tamperproof Star Bit Socket Set

Item No.	Size	Item No.	Size
<b>3/8" Dr. Star Bit Socket:</b>			
308+7110	T-10, 50mmL	308+7610	T-10, 140mmL
308+7115	T-15, 50mmL	308+7615	T-15, 140mmL
308+7120	T-20, 50mmL	308+7620	T-20, 140mmL
308+7125	T-25, 50mmL	308+7625	T-25, 140mmL
308+7127	T-27, 50mmL	308+7627	T-27, 140mmL
308+7130	T-30, 50mmL	308+7630	T-30, 140mmL
308+7140	T-40, 50mmL	308+7640	T-40, 140mmL
<b>1/2" Dr. Star Bit Socket:</b>			
410+7345	T-45, 80mmL	410+7645	T-45, 150mmL
410+7350	T-50, 80mmL	410+7650	T-50, 150mmL
440+7355	T-55, 80mmL	440+7655	T-55, 150mmL
442+7360	T-60, 80mmL	442+7660	T-60, 150mmL
444+7370	T-70, 80mmL	444+7670	T-70, 150mmL

Plastic Tray

2650 g   5 sets / 14.5 Kgs / 0.93 CUFT



(192W x 406D)



# Slotted Screwdriver Bits

## Slotted Screwdriver Bits

Item No.	Size mm	Hex Shank	Length mm	Weight g	PCS inner/ctn	G.W. KGS	CUFT 
1130	0.5 x 3.0	1/4"	30	8	100 / 600	6.0	0.30
1140	0.6 x 4.0	1/4"	30	8	100 / 600	6.0	0.30
1150	0.8 x 5.0	1/4"	30	8	100 / 600	6.0	0.30
1155	0.8 x 5.5	1/4"	30	8	100 / 600	6.0	0.30
1160	1.0 x 6.0	1/4"	30	8	100 / 600	6.0	0.30
1165	1.0 x 6.5	1/4"	30	8	100 / 600	6.0	0.30
1170	1.2 x 7.0	1/4"	30	8	100 / 600	6.0	0.30
1250	0.8 x 5.0	5/16"	30	11	100 / 600	8.0	0.30
1255	0.8 x 5.5	5/16"	30	11	100 / 600	8.0	0.30
1260	1.0 x 6.0	5/16"	30	11	100 / 600	8.0	0.30
1265	1.0 x 6.5	5/16"	30	11	100 / 600	8.0	0.30
1280	1.2 x 8.0	5/16"	30	11	100 / 600	8.0	0.30
1290	1.6 x 9.0	5/16"	30	11	100 / 600	8.0	0.30
1292	2.0 x 12.0	10mm	36	20	20 / 240	6.0	0.30
1294	2.5 x 14.0	12mm	36	30	20 / 240	8.0	0.30
1296	2.5 x 16.0	14mm	36	40	20 / 240	10.0	0.30
1330	0.5 x 3.0	1/4"	56	15	100 / 600	10.0	0.30
1340	0.6 x 4.0	1/4"	56	15	100 / 600	10.0	0.30
1350	0.8 x 5.0	1/4"	56	15	100 / 600	10.0	0.30
1360	1.0 x 6.0	1/4"	56	15	100 / 600	10.0	0.30
1470	1.2 x 7.0	5/16"	56	20	100 / 600	13.0	0.30
1480	1.2 x 8.0	5/16"	56	20	100 / 600	13.0	0.30
1490	1.6 x 9.0	5/16"	56	20	100 / 600	13.0	0.30
1492	2.0 x 12.0	10mm	56	35	20 / 300	11.5	0.52
1494	2.5 x 14.0	12mm	56	50	20 / 300	16.0	0.52
1496	2.5 x 16.0	14mm	56	65	20 / 300	20.5	0.52
1465	1.2 x 6.5	1/4"	75	25	20 / 400	11.0	0.59
1530	0.5 x 3.0	1/4"	88	25	20 / 400	11.0	0.59
1540	0.6 x 4.0	1/4"	88	25	20 / 400	11.0	0.59
1550	0.8 x 5.0	1/4"	88	25	20 / 400	11.0	0.59
1560	1.0 x 6.0	1/4"	88	25	20 / 400	11.0	0.59
1580	1.2 x 8.0	5/16"	88	35	20 / 400	15.0	0.59
1590	1.6 x 9.0	5/16"	88	35	20 / 400	15.0	0.59
1592	2.0 x 12.0	10mm	88	55	25 / 200	12.0	0.44
1594	2.5 x 14.0	12mm	88	85	25 / 200	18.0	0.44
1596	2.5 x 16.0	14mm	88	100	25 / 200	21.0	0.44
1630	0.5 x 3.0	1/4"	125	35	20 / 300	11.5	0.52
1640	0.6 x 4.0	1/4"	125	35	20 / 300	11.5	0.52
1650	0.8 x 5.0	1/4"	125	35	20 / 300	11.5	0.52
1660	1.0 x 6.0	1/4"	125	35	20 / 300	11.5	0.52
1680	1.2 x 8.0	5/16"	125	50	20 / 300	16.0	0.52
1690	1.6 x 9.0	5/16"	125	50	20 / 300	16.0	0.52
1692	2.0 x 12.0	10mm	125	80	10 / 150	13.0	0.52
1694	2.5 x 14.0	12mm	125	120	10 / 150	19.0	0.52
1696	2.5 x 16.0	14mm	125	150	10 / 150	23.5	0.52
1740	0.6 x 4.0	1/4"	160	45	20 / 200	9.5	0.62
1750	0.8 x 5.0	1/4"	160	45	20 / 200	9.5	0.62
1760	1.0 x 6.0	1/4"	160	45	20 / 200	9.5	0.62
1780	1.2 x 8.0	5/16"	160	65	20 / 200	13.5	0.62
1790	1.6 x 9.0	5/16"	160	65	20 / 200	13.5	0.62
1792	2.0 x 12.0	10mm	160	100	10 / 100	11.0	0.62
1794	2.5 x 14.0	12mm	160	150	10 / 100	16.0	0.62
1796	2.5 x 16.0	14mm	160	200	10 / 100	21.0	0.62
1965	1.2 x 6.5	1/4"	175	50	20 / 200	12.0	0.62
1840	0.6 x 4.0	1/4"	200	55	20 / 200	12.0	0.62
1850	0.8 x 5.0	1/4"	200	55	20 / 200	12.0	0.62
1860	1.0 x 6.0	1/4"	200	55	20 / 200	12.0	0.62
1880	1.2 x 8.0	5/16"	200	80	20 / 200	17.0	0.62
1890	1.6 x 9.0	5/16"	200	80	20 / 200	17.0	0.62
1892	2.0 x 12.0	10mm	200	130	10 / 100	14.0	0.62
1894	2.5 x 14.0	12mm	200	190	10 / 100	20.0	0.62
1896	2.5 x 16.0	14mm	200	250	10 / 100	26.0	0.62
1980	1.2 x 8.0	5/16"	260	110	10 / 100	12.0	0.62
1990	1.6 x 10.0	10mm	285	190	10 / 120	24.0	0.52





## Phillips Screwdriver Bits

Item No.	Size	Hex Shank	Length mm	Weight g	PCS		G.W. KGS	CUFT 
					inner/ctn			
1100	#0	1/4"	30	8	100 / 600	6.0	0.30	
1101	#1	1/4"	30	8	100 / 600	6.0	0.30	
1102	#2	1/4"	30	8	100 / 600	6.0	0.30	
1103	#3	1/4"	30	8	100 / 600	6.0	0.30	
1121	#1	5/16"	30	11	100 / 600	8.0	0.30	
1122	#2	5/16"	30	11	100 / 600	8.0	0.30	
1123	#3	5/16"	30	11	100 / 600	8.0	0.30	
1124	#4	5/16"	30	11	100 / 600	8.0	0.30	
1301	#1	1/4"	56	15	50 / 600	10.0	0.30	
1302	#2	1/4"	56	15	50 / 600	10.0	0.30	
1303	#3	1/4"	56	15	50 / 600	10.0	0.30	
1402	#2	5/16"	56	20	50 / 600	13.0	0.30	
1403	#3	5/16"	56	20	50 / 600	13.0	0.30	
1404	#4	5/16"	56	20	50 / 600	13.0	0.30	
1501	#1	1/4"	88	25	30 / 360	10.0	0.30	
1502	#2	1/4"	88	25	30 / 360	10.0	0.30	
1503	#3	1/4"	88	25	30 / 360	10.0	0.30	
1504	#4	5/16"	88	40	30 / 360	14.5	0.30	
1601	#1	1/4"	125	35	20 / 300	11.5	0.52	
1602	#2	1/4"	125	35	20 / 300	11.5	0.52	
1603	#3	1/4"	125	35	20 / 300	11.5	0.52	
1604	#4	5/16"	125	55	20 / 300	17.5	0.52	
1701	#1	1/4"	160	45	20 / 200	10.0	0.62	
1702	#2	1/4"	160	45	20 / 200	10.0	0.62	
1703	#3	1/4"	160	45	20 / 200	10.0	0.62	
1704	#4	5/16"	160	70	20 / 200	15.0	0.62	
1801	#1	1/4"	200	55	20 / 200	12.0	0.62	
1802	#2	1/4"	200	55	20 / 200	12.0	0.62	
1803	#3	1/4"	200	55	20 / 200	12.0	0.62	
1804	#4	5/16"	200	90	20 / 200	19.0	0.62	
1902	#2	1/4"	275	75	10 / 120	10.0	0.52	
1903	#3	5/16"	285	130	10 / 120	14.0	0.52	



## SB-221SP 21 Piece Slotted & Phillips Screwdriver Bit Set

Item No.	Size	Item No.	Size
<b>Screwdriver Bit, 30mmL:</b>			
1130	0.5 x 3.0mm	1170	1.2 x 7.0mm
1140	0.6 x 4.0mm	1100	#0 Philips
1150	0.8 x 5.0mm	1101	#1 Philips
1155	0.8 x 5.5mm	1102	#2 Philips
1160	1.0 x 6.0mm	1103	#3 Philips
<b>Screwdriver Bit, 160mmL:</b>			
1740	0.6 x 4.0mm	1701	#1 Philips
1750	0.8 x 5.0mm	1702	#2 Philips
1760	1.0 x 6.0mm	1703	#3 Philips
1780	1.2 x 8.0mm	1704	#4 Philips
1790	1.6 x 9.0mm		

### Accessory:

- 280120 3in1 Handgrip
- 280002B Socket Holder Adapter
- Pouch Bag

 880 g  20 sets / 18.5 Kgs / 0.88 CUFT



# Hex Screwdriver Bits

## Metric Hex Screwdriver Bits

Item No.	Size mm	Hex Shank	Length mm	Weight g	PCS inner/ctn	G.W. KGS	CUFT 
2122	2	1/4"	30	8	100 / 600	6.0	0.30
2125	2.5	1/4"	30	8	100 / 600	6.0	0.30
2133	3	1/4"	30	8	100 / 600	6.0	0.30
2134	4	1/4"	30	8	100 / 600	6.0	0.30
2135	5	1/4"	30	8	100 / 600	6.0	0.30
2136	6	1/4"	30	8	100 / 600	6.0	0.30
2137	7	1/4"	30	8	100 / 600	7.0	0.30
2138	8	1/4"	30	8	100 / 600	7.0	0.30
2143	3	5/16"	30	11	100 / 600	8.0	0.30
2144	4	5/16"	30	11	100 / 600	8.0	0.30
2145	5	5/16"	30	11	100 / 600	8.0	0.30
2146	6	5/16"	30	11	100 / 600	8.0	0.30
2147	7	5/16"	30	11	100 / 600	8.0	0.30
2148	8	5/16"	30	11	100 / 600	8.0	0.30
2149	9	9mm	30	18	50 / 300	6.5	0.30
2150	10	10mm	30	20	50 / 300	7.0	0.30
2151	11	11mm	30	25	50 / 300	8.5	0.30
2152	12	12mm	30	30	50 / 300	10.0	0.30
2H3004	4	10mm	30	15	100 / 600	10.0	0.30
2H3005	5	10mm	30	15	100 / 600	10.0	0.30
2H3006	6	10mm	30	15	100 / 600	10.0	0.30
2H3007	7	10mm	30	18	100 / 600	11.0	0.30
2H3008	8	10mm	30	20	100 / 600	12.5	0.30
2H3010	10	10mm	30	20	100 / 600	12.5	0.30
2H3012	12	10mm	30	25	100 / 600	15.5	0.30
2322	2	1/4"	56	15	50 / 600	10.0	0.30
2325	2.5	1/4"	56	15	50 / 600	10.0	0.30
2333	3	1/4"	56	15	50 / 600	10.0	0.30
2334	4	1/4"	56	15	50 / 600	10.0	0.30
2335	5	1/4"	56	15	50 / 600	10.0	0.30
2336	6	1/4"	56	15	50 / 600	10.0	0.30
2347	7	5/16"	56	20	50 / 600	13.0	0.30
2348	8	5/16"	56	20	50 / 600	13.0	0.30
2349	9	9mm	56	30	20 / 300	10.0	0.52
2350	10	10mm	56	40	20 / 300	13.0	0.52
2351	11	11mm	56	45	20 / 300	14.5	0.52
2352	12	12mm	56	55	20 / 300	17.5	0.52
2353	13	13mm	56	65	20 / 300	20.5	0.52
2354	14	14mm	56	75	20 / 300	23.5	0.52
2356	16	16mm	56	100	10 / 150	16.0	0.52
2357	17	17mm	56	110	10 / 150	17.5	0.52
2359	19	19mm	56	140	10 / 150	22.0	0.52
2H7504	4	10mm	75	43	50 / 400	18.5	0.44
2H7505	5	10mm	75	43	50 / 400	18.5	0.44
2H7506	6	10mm	75	45	50 / 400	19.0	0.44
2H7507	7	10mm	75	48	50 / 400	20.0	0.44
2H7508	8	10mm	75	48	50 / 400	20.0	0.44
2H7510	10	10mm	75	50	50 / 400	21.0	0.44
2H7512	12	10mm	75	70	50 / 400	28.0	0.44
2522	2	1/4"	88	25	20 / 400	11.0	0.59
2525	2.5	1/4"	88	25	20 / 400	11.0	0.59
2533	3	1/4"	88	25	20 / 400	11.0	0.59
2534	4	1/4"	88	25	20 / 400	11.0	0.59
2535	5	1/4"	88	25	20 / 400	11.0	0.59
2536	6	1/4"	88	25	20 / 400	11.0	0.59
2547	7	5/16"	88	35	20 / 400	15.0	0.59
2548	8	5/16"	88	35	20 / 400	15.0	0.59
2549	9	9mm	88	50	25 / 200	11.0	0.44
2550	10	10mm	88	60	25 / 200	13.0	0.44
2551	11	11mm	88	70	25 / 200	15.0	0.44
2552	12	12mm	88	85	25 / 200	18.0	0.44
2553	13	13mm	88	95	25 / 200	20.0	0.44
2554	14	14mm	88	120	25 / 200	25.0	0.44
2556	16	16mm	88	160	10 / 100	17.0	0.62
2557	17	17mm	88	170	10 / 100	18.0	0.62
2559	19	19mm	88	180	10 / 100	19.0	0.62



# Hex Screwdriver Bits

## Metric Hex Screwdriver Bits

Item No.	Size mm	Hex Shank	Length mm	Weight g	PCS inner/ctn	G.W. KGS	CUFT 
2622	2	1/4"	125	35	20 / 300	11.5	0.52
2625	2.5	1/4"	125	35	20 / 300	11.5	0.52
2633	3	1/4"	125	35	20 / 300	11.5	0.52
2634	4	1/4"	125	35	20 / 300	11.5	0.52
2635	5	1/4"	125	35	20 / 300	11.5	0.52
2636	6	1/4"	125	35	20 / 300	11.5	0.52
2647	7	5/16"	125	50	20 / 300	16.0	0.52
2648	8	5/16"	125	55	20 / 300	16.0	0.52
2649	9	9mm	125	70	10 / 150	11.5	0.52
2650	10	10mm	125	85	10 / 150	13.5	0.52
2651	11	11mm	125	100	10 / 150	16.0	0.52
2652	12	12mm	125	120	10 / 150	19.0	0.52
2653	13	13mm	125	140	10 / 150	22.0	0.52
2654	14	14mm	125	160	10 / 150	25.0	0.52
2656	16	16mm	125	220	10 / 80	18.5	0.44
2657	17	17mm	125	240	10 / 80	20.5	0.44
2659	19	19mm	125	300	10 / 80	25.0	0.44
2722	2	1/4"	160	45	20 / 200	10.0	0.62
2725	2.5	1/4"	160	45	20 / 200	10.0	0.62
2733	3	1/4"	160	45	20 / 200	10.0	0.62
2734	4	1/4"	160	45	20 / 200	10.0	0.62
2735	5	1/4"	160	45	20 / 200	10.0	0.62
2736	6	1/4"	160	45	20 / 200	10.0	0.62
2747	7	5/16"	160	55	20 / 200	12.0	0.62
2748	8	5/16"	160	70	20 / 200	15.0	0.62
2749	9	9mm	160	90	10 / 100	10.0	0.62
2750	10	10mm	160	110	10 / 100	12.0	0.62
2751	11	11mm	160	130	10 / 100	14.0	0.62
2752	12	12mm	160	150	10 / 100	16.0	0.62
2753	13	13mm	160	170	10 / 100	18.0	0.62
2754	14	14mm	160	190	10 / 100	20.0	0.62
2756	16	16mm	160	280	10 / 60	18.0	0.30
2757	17	17mm	160	310	10 / 60	19.5	0.30
2759	19	19mm	160	350	10 / 60	22.0	0.30
2833	3	1/4"	200	55	20 / 200	12.0	0.62
2834	4	1/4"	200	55	20 / 200	12.0	0.62
2835	5	1/4"	200	55	20 / 200	12.0	0.62
2836	6	1/4"	200	55	20 / 200	12.0	0.62
2847	7	5/16"	200	85	20 / 200	18.0	0.62
2848	8	5/16"	200	85	20 / 200	18.0	0.62
2849	9	9mm	200	110	10 / 100	12.0	0.62
2850	10	10mm	200	130	10 / 100	14.0	0.62
2851	11	11mm	200	160	10 / 100	17.0	0.62
2852	12	12mm	200	190	10 / 100	20.0	0.62
2853	13	13mm	200	230	10 / 100	24.0	0.62
2854	14	14mm	200	260	10 / 100	27.0	0.62
2856	16	16mm	200	350	10 / 60	22.0	0.30
2857	17	17mm	200	390	10 / 60	24.5	0.30
2859	19	19mm	200	490	5 / 60	30.5	0.44



# Hex Screwdriver Bits

## SAE Hex Screwdriver Bits

Item No.	Size inch	Hex Shank	Length mm	Weight g	PCS inner/ctn	G.W. KGS	CUFT 
3104	1/16	1/4"	30	8	100 / 600	6.0	0.30
3105	5/64	1/4"	30	8	100 / 600	6.0	0.30
3106	3/32	1/4"	30	8	100 / 600	6.0	0.30
3107	7/64	1/4"	30	8	100 / 600	6.0	0.30
3108	1/8	1/4"	30	8	100 / 600	6.0	0.30
3110	5/32	1/4"	30	8	100 / 600	6.0	0.30
3112	3/16	1/4"	30	8	100 / 600	6.0	0.30
3114	7/32	1/4"	30	8	100 / 600	6.0	0.30
3116	1/4	1/4"	30	8	100 / 600	6.0	0.30
3118	1/8	5/16"	30	11	100 / 600	8.0	0.30
3120	5/32	5/16"	30	11	100 / 600	8.0	0.30
3122	3/16	5/16"	30	11	100 / 600	8.0	0.30
3124	7/32	5/16"	30	11	100 / 600	8.0	0.30
3126	1/4	5/16"	30	11	100 / 600	8.0	0.30
3128	9/32	5/16"	30	11	100 / 600	8.0	0.30
3130	5/16	5/16"	30	11	100 / 600	8.0	0.30
3134	3/8	3/8"	30	20	50 / 300	7.0	0.30
3138	7/16	7/16"	30	25	50 / 300	8.5	0.30
3142	1/2	1/2"	30	30	50 / 300	10.0	0.30
3304	1/16	1/4"	56	15	50 / 600	10.0	0.30
3305	5/64	1/4"	56	15	50 / 600	10.0	0.30
3306	3/32	1/4"	56	15	50 / 600	10.0	0.30
3307	7/64	1/4"	56	15	50 / 600	10.0	0.30
3308	1/8	1/4"	56	15	50 / 600	10.0	0.30
3310	5/32	1/4"	56	15	50 / 600	10.0	0.30
3312	3/16	1/4"	56	15	50 / 600	10.0	0.30
3314	7/32	1/4"	56	15	50 / 600	10.0	0.30
3316	1/4	1/4"	56	15	50 / 600	10.0	0.30
3318	9/32	5/16"	56	20	50 / 600	13.0	0.30
3320	5/16	5/16"	56	20	50 / 600	13.0	0.30
3324	3/8	3/8"	56	35	20 / 300	11.5	0.52
3328	7/16	7/16"	56	45	20 / 300	14.5	0.52
3332	1/2	1/2"	56	60	20 / 300	19.0	0.52
3336	9/16	9/16"	56	75	20 / 300	23.5	0.52
3340	5/8	5/8"	56	95	10 / 150	15.5	0.52
3344	11/16	11/16"	56	110	10 / 150	17.5	0.52
3348	3/4	3/4"	56	140	10 / 150	22.0	0.52
3504	1/16	1/4"	88	25	20 / 400	11.0	0.59
3505	5/64	1/4"	88	25	20 / 400	11.0	0.59
3506	3/32	1/4"	88	25	20 / 400	11.0	0.59
3507	7/64	1/4"	88	25	20 / 400	11.0	0.59
3508	1/8	1/4"	88	25	20 / 400	11.0	0.59
3510	5/32	1/4"	88	25	20 / 400	11.0	0.59
3512	3/16	1/4"	88	25	20 / 400	11.0	0.59
3514	7/32	1/4"	88	25	20 / 400	11.0	0.59
3516	1/4	1/4"	88	25	20 / 400	11.0	0.59
3518	9/32	5/16"	88	35	20 / 400	15.0	0.59
3520	5/16	5/16"	88	35	20 / 400	15.5	0.59
3524	3/8	3/8"	88	55	25 / 200	12.0	0.44
3528	7/16	7/16"	88	75	25 / 200	16.0	0.44
3532	1/2	1/2"	88	95	25 / 200	20.0	0.44
3536	9/16	9/16"	88	110	25 / 200	23.0	0.44
3540	5/8	5/8"	88	160	10 / 100	17.0	0.62
3544	11/16	11/16"	88	170	10 / 100	18.0	0.62
3548	3/4	3/4"	88	190	10 / 100	20.0	0.62

• 125, 160, & 200mmL Screwdriver Bits on the next page.



# Hex Screwdriver Bits

## SAE Hex Screwdriver Bits

Item No.	Size inch	Hex Shank	Length mm	Weight g	PCS inner/ctn	G.W. KGS	CUFT 
3604	1/16	1/4"	125	35	20 / 300	11.5	0.52
3605	5/64	1/4"	125	35	20 / 300	11.5	0.52
3606	3/32	1/4"	125	35	20 / 300	11.5	0.52
3607	7/64	1/4"	125	35	20 / 300	11.5	0.52
3608	1/8	1/4"	125	35	20 / 300	11.5	0.52
3610	5/32	1/4"	125	35	20 / 300	11.5	0.52
3612	3/16	1/4"	125	35	20 / 300	11.5	0.52
3614	7/32	1/4"	125	35	20 / 300	11.5	0.52
3616	1/4	1/4"	125	35	20 / 300	11.5	0.52
3618	9/32	5/16"	125	50	20 / 300	16.0	0.52
3620	5/16	5/16"	125	50	20 / 300	16.0	0.52
3624	3/8	3/8"	125	80	10 / 150	13.0	0.52
3628	7/16	7/16"	125	100	10 / 150	16.0	0.52
3632	1/2	1/2"	125	130	10 / 150	20.0	0.52
3636	9/16	9/16"	125	150	10 / 150	23.5	0.52
3640	5/8	5/8"	125	230	10 / 80	19.0	0.44
3644	11/16	11/16"	125	250	10 / 80	21.0	0.44
3648	3/4	3/4"	125	270	10 / 80	23.0	0.44
3704	1/16	1/4"	160	45	20 / 200	9.5	0.62
3705	5/64	1/4"	160	45	20 / 200	9.5	0.62
3706	3/32	1/4"	160	45	20 / 200	9.5	0.62
3707	7/64	1/4"	160	45	20 / 200	9.5	0.62
3708	1/8	1/4"	160	45	20 / 200	9.5	0.62
3710	5/32	1/4"	160	45	20 / 200	9.5	0.62
3712	3/16	1/4"	160	45	20 / 200	9.5	0.62
3714	7/32	1/4"	160	45	20 / 200	9.5	0.62
3716	1/4	1/4"	160	45	20 / 200	9.5	0.62
3718	9/32	5/16"	160	65	20 / 200	13.5	0.62
3720	5/16	5/16"	160	65	20 / 200	13.5	0.62
3724	3/8	3/8"	160	100	10 / 100	10.5	0.62
3728	7/16	7/16"	160	130	10 / 100	13.5	0.62
3732	1/2	1/2"	160	160	10 / 100	17.0	0.62
3736	9/16	9/16"	160	190	10 / 100	19.5	0.62
3740	5/8	5/8"	160	290	10 / 60	18.0	0.30
3744	11/16	11/16"	160	320	10 / 60	19.5	0.30
3748	3/4	3/4"	160	350	10 / 60	21.5	0.30
3808	1/8	1/4"	200	55	20 / 200	12.0	0.62
3810	5/32	1/4"	200	55	20 / 200	12.0	0.62
3812	3/16	1/4"	200	55	20 / 200	12.0	0.62
3814	7/32	1/4"	200	55	20 / 200	12.0	0.62
3816	1/4	1/4"	200	55	20 / 200	12.0	0.62
3818	9/32	5/16"	200	80	20 / 200	17.0	0.62
3820	5/16	5/16"	200	80	20 / 200	17.0	0.62
3824	3/8	3/8"	200	120	10 / 100	13.5	0.62
3828	7/16	7/16"	200	160	10 / 100	17.5	0.62
3832	1/2	1/2"	200	200	10 / 100	21.5	0.62
3836	9/16	9/16"	200	240	10 / 100	25.0	0.62
3840	5/8	5/8"	200	360	10 / 60	23.0	0.30
3844	11/16	11/16"	200	400	10 / 60	25.0	0.30
3848	3/4	3/4"	200	430	10 / 60	27.0	0.30



Made of High Speed Tool Steel

# Wobble Hex Screwdriver Bits

## Metric Wobble Hex Screwdriver Bits

Item No.	Size mm	Hex Shank	Length mm	Weight g	PCS inner/ctn	G.W. KGS	CUFT 
4133	3	1/4"	30	8	100 / 600	6.0	0.30
4134	4	1/4"	30	8	100 / 600	6.0	0.30
4135	5	1/4"	30	8	100 / 600	6.0	0.30
4136	6	1/4"	30	8	100 / 600	6.0	0.30
4147	7	5/16"	30	11	100 / 600	8.0	0.30
4148	8	5/16"	30	11	100 / 600	8.0	0.30
4149	9	9mm	30	18	50 / 300	6.5	0.30
4150	10	10mm	30	20	50 / 300	7.0	0.30
4333	3	1/4"	56	15	50 / 600	10.0	0.30
4334	4	1/4"	56	15	50 / 600	10.0	0.30
4335	5	1/4"	56	15	50 / 600	10.0	0.30
4336	6	1/4"	56	15	50 / 600	10.0	0.30
4347	7	5/16"	56	20	50 / 600	13.0	0.30
4348	8	5/16"	56	20	50 / 600	13.0	0.30
4349	9	9mm	56	30	20 / 300	10.0	0.52
4350	10	10mm	56	35	20 / 300	11.5	0.52
4533	3	1/4"	88	25	20 / 400	11.0	0.59
4534	4	1/4"	88	25	20 / 400	11.0	0.59
4535	5	1/4"	88	25	20 / 400	11.0	0.59
4536	6	1/4"	88	25	20 / 400	11.0	0.59
4547	7	5/16"	88	35	20 / 400	15.0	0.59
4548	8	5/16"	88	35	20 / 400	15.0	0.59
4549	9	9mm	88	50	25 / 200	11.0	0.44
4550	10	10mm	88	60	25 / 200	13.0	0.44
4633	3	1/4"	125	35	20 / 300	11.5	0.52
4634	4	1/4"	125	35	20 / 300	11.5	0.52
4635	5	1/4"	125	35	20 / 300	11.5	0.52
4636	6	1/4"	125	35	20 / 300	11.5	0.52
4647	7	5/16"	125	50	20 / 300	16.0	0.52
4648	8	5/16"	125	50	20 / 300	16.0	0.52
4649	9	9mm	125	70	10 / 150	11.5	0.52
4650	10	10mm	125	80	10 / 150	13.0	0.52
4733	3	1/4"	160	45	20 / 200	10.0	0.62
4734	4	1/4"	160	45	20 / 200	10.0	0.62
4735	5	1/4"	160	45	20 / 200	10.0	0.62
4736	6	1/4"	160	45	20 / 200	10.0	0.62
4747	7	5/16"	160	65	20 / 200	14.0	0.62
4748	8	5/16"	160	65	20 / 200	14.0	0.62
4749	9	9mm	160	90	10 / 100	10.0	0.62
4750	10	10mm	160	100	10 / 100	12.0	0.62
4833	3	1/4"	200	55	20 / 200	12.0	0.62
4834	4	1/4"	200	55	20 / 200	12.0	0.62
4835	5	1/4"	200	55	20 / 200	12.0	0.62
4836	6	1/4"	200	55	20 / 200	12.0	0.62
4847	7	5/16"	200	85	20 / 200	18.0	0.62
4848	8	5/16"	200	85	20 / 200	18.0	0.62
4849	9	9mm	200	110	10 / 100	12.0	0.62
4850	10	10mm	200	130	10 / 100	14.0	0.62

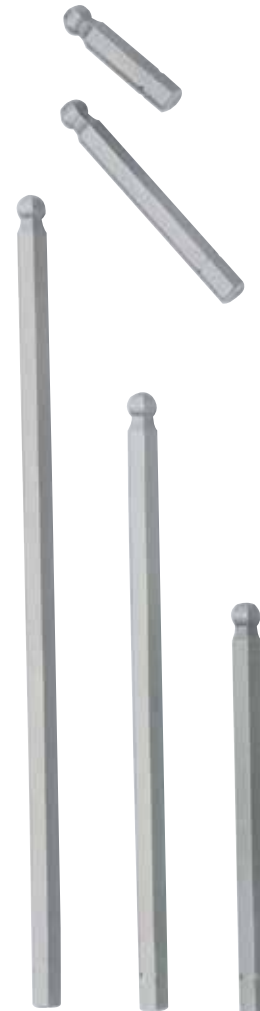

Screwdrivers

# Wobble Hex Screwdriver Bits

## SAE Wobble Hex Screwdriver Bits

Item No.	Size inch	Hex Shank	Length mm	Weight g	PCS inner/ctn	G.W. KGS	CUFT 
5108	1/8	1/4"	30	8	100 / 600	6.0	0.30
5110	5/32	1/4"	30	8	100 / 600	6.0	0.30
5112	3/16	1/4"	30	8	100 / 600	6.0	0.30
5114	7/32	1/4"	30	8	100 / 600	6.0	0.30
5116	1/4	1/4"	30	8	100 / 600	6.0	0.30
5118	9/32	5/16"	30	11	100 / 600	8.0	0.30
5120	5/16	5/16"	30	11	100 / 600	8.0	0.30
5124	3/8	3/8"	30	20	50 / 300	7.0	0.30
5308	1/8	1/4"	56	15	50 / 600	10.0	0.30
5310	5/32	1/4"	56	15	50 / 600	10.0	0.30
5312	3/16	1/4"	56	15	50 / 600	10.0	0.30
5314	7/32	1/4"	56	15	50 / 600	10.0	0.30
5316	1/4	1/4"	56	15	50 / 600	10.0	0.30
5318	9/32	5/16"	56	20	50 / 600	13.0	0.30
5320	5/16	5/16"	56	20	50 / 600	13.0	0.30
5324	3/8	3/8"	56	35	20 / 300	11.5	0.52
5508	1/8	1/4"	88	25	20 / 400	11.0	0.59
5510	5/32	1/4"	88	25	20 / 400	11.0	0.59
5512	3/16	1/4"	88	25	20 / 400	11.0	0.59
5514	7/32	1/4"	88	25	20 / 400	11.0	0.59
5516	1/4	1/4"	88	25	20 / 400	11.0	0.59
5518	9/32	5/16"	88	35	20 / 400	15.0	0.59
5520	5/16	5/16"	88	35	20 / 400	15.0	0.59
5524	3/8	3/8"	88	55	25 / 200	12.0	0.44
5608	1/8	1/4"	125	35	20 / 300	11.5	0.52
5610	5/32	1/4"	125	35	20 / 300	11.5	0.52
5612	3/16	1/4"	125	35	20 / 300	11.5	0.52
5614	7/32	1/4"	125	35	20 / 300	11.5	0.52
5616	1/4	1/4"	125	35	20 / 300	11.5	0.52
5618	9/32	5/16"	125	50	20 / 300	16.0	0.52
5620	5/16	5/16"	125	50	20 / 300	16.0	0.52
5624	3/8	3/8"	125	75	10 / 150	12.5	0.52
5708	1/8	1/4"	160	45	20 / 200	9.5	0.62
5710	5/32	1/4"	160	45	20 / 200	9.5	0.62
5712	3/16	1/4"	160	45	20 / 200	9.5	0.62
5714	7/32	1/4"	160	45	20 / 200	9.5	0.62
5716	1/4	1/4"	160	45	20 / 200	9.5	0.62
5718	9/32	5/16"	160	65	20 / 200	14.0	0.62
5720	5/16	5/16"	160	65	20 / 200	14.0	0.62
5724	3/8	3/8"	160	100	10 / 100	11.0	0.62
5808	1/8	1/4"	200	55	20 / 200	12.0	0.62
5810	5/32	1/4"	200	55	20 / 200	12.0	0.62
5812	3/16	1/4"	200	55	20 / 200	12.0	0.62
5814	7/32	1/4"	200	55	20 / 200	12.0	0.62
5816	1/4	1/4"	200	55	20 / 200	12.0	0.62
5818	9/32	5/16"	200	85	20 / 200	18.0	0.62
5820	5/16	5/16"	200	85	20 / 200	18.0	0.62
5824	3/8	3/8"	200	120	10 / 100	13.0	0.62



Made of High Speed Tool Steel

# Star Screwdriver Bits

## Star Screwdriver Bits

Item No.	Size	Hex Shank	Length mm	Weight g	PCS inner/ctn	G.W. KGS	CUFT 
6106	T-6	1/4"	30	8	100 / 600	6.0	0.30
6107	T-7	1/4"	30	8	100 / 600	6.0	0.30
6108	T-8	1/4"	30	8	100 / 600	6.0	0.30
6109	T-9	1/4"	30	8	100 / 600	6.0	0.30
6110	T-10	1/4"	30	8	100 / 600	6.0	0.30
6115	T-15	1/4"	30	8	100 / 600	6.0	0.30
6120	T-20	1/4"	30	8	100 / 600	6.0	0.30
6125	T-25	1/4"	30	8	100 / 600	6.0	0.30
6127	T-27	1/4"	30	8	100 / 600	6.0	0.30
6130	T-30	1/4"	30	8	100 / 600	6.0	0.30
6135	T-35	1/4"	30	8	100 / 600	6.0	0.30
6140	T-40	1/4"	30	8	100 / 600	6.0	0.30
6210	T-10	5/16"	30	11	100 / 600	8.0	0.30
6215	T-15	5/16"	30	11	100 / 600	8.0	0.30
6220	T-20	5/16"	30	11	100 / 600	8.0	0.30
6225	T-25	5/16"	30	11	100 / 600	8.0	0.30
6227	T-27	5/16"	30	11	100 / 600	8.0	0.30
6230	T-30	5/16"	30	11	100 / 600	8.0	0.30
6240	T-40	5/16"	30	11	100 / 600	8.0	0.30
6245	T-45	5/16"	30	11	100 / 600	8.0	0.30
6250	T-50	5/16"	30	11	100 / 600	8.0	0.30
6255	T-55	10mm	30	20	50 / 300	7.0	0.30
6260	T-60	12mm	36	35	25 / 300	11.0	0.30
6270	T-70	14mm	36	45	25 / 300	14.5	0.30
2T3015	T-15	10mm	30	13	100 / 600	9.0	0.30
2T3020	T-20	10mm	30	13	100 / 600	9.0	0.30
2T3025	T-25	10mm	30	13	100 / 600	9.0	0.30
2T3027	T-27	10mm	30	15	100 / 600	10.0	0.30
2T3030	T-30	10mm	30	15	100 / 600	10.0	0.30
2T3040	T-40	10mm	30	15	100 / 600	10.0	0.30
2T3045	T-45	10mm	30	18	100 / 600	11.5	0.30
2T3050	T-50	10mm	30	18	100 / 600	11.5	0.30
2T3055	T-55	10mm	30	20	100 / 600	13.0	0.30
6306	T-6	1/4"	56	15	50 / 600	10.0	0.30
6307	T-7	1/4"	56	15	50 / 600	10.0	0.30
6308	T-8	1/4"	56	15	50 / 600	10.0	0.30
6309	T-9	1/4"	56	15	50 / 600	10.0	0.30
6310	T-10	1/4"	56	15	50 / 600	10.0	0.30
6315	T-15	1/4"	56	15	50 / 600	10.0	0.30
6320	T-20	1/4"	56	15	50 / 600	10.0	0.30
6325	T-25	1/4"	56	15	50 / 600	10.0	0.30
6327	T-27	1/4"	56	15	50 / 600	10.0	0.30
6330	T-30	1/4"	56	15	50 / 600	10.0	0.30
6340	T-40	1/4"	56	15	50 / 600	10.0	0.30
6345	T-45	5/16"	56	20	50 / 600	13.0	0.30
6350	T-50	5/16"	56	20	50 / 600	13.0	0.30
6355	T-55	10mm	56	35	20 / 300	11.5	0.52
6360	T-60	12mm	56	50	20 / 300	16.0	0.52
6370	T-70	14mm	56	70	20 / 300	22.0	0.52
2T7515	T-15	10mm	75	43	50 / 400	18.0	0.44
2T7520	T-20	10mm	75	43	50 / 400	18.0	0.44
2T7525	T-25	10mm	75	43	50 / 400	18.0	0.44
2T7527	T-27	10mm	75	43	50 / 400	18.0	0.44
2T7530	T-30	10mm	75	43	50 / 400	18.0	0.44
2T7540	T-40	10mm	75	45	50 / 400	19.0	0.44
2T7545	T-45	10mm	75	45	50 / 400	19.0	0.44
2T7550	T-50	10mm	75	45	50 / 400	19.0	0.44
2T7555	T-55	10mm	75	50	50 / 400	20.5	0.44
2T7560	T-60	14mm	75	95	25 / 200	20.0	0.44
2T7570	T-70	14mm	75	95	25 / 200	20.0	0.44
2T11555	T-55	14mm	115	140	10 / 150	22.0	0.52

• 88, 125, 160, & 200mmL Screwdriver Bits on the next page.



Screwdrivers



## Star Screwdriver Bits

Item No.	Size	Hex Shank	Length mm	Weight g	PCS inner/ctn	G.W. KGS	CUFT 
6506	T-6	1/4"	88	25	20 / 400	11.0	0.59
6507	T-7	1/4"	88	25	20 / 400	11.0	0.59
6508	T-8	1/4"	88	25	20 / 400	11.0	0.59
6509	T-9	1/4"	88	25	20 / 400	11.0	0.59
6510	T-10	1/4"	88	25	20 / 400	11.0	0.59
6515	T-15	1/4"	88	25	20 / 400	11.0	0.59
6520	T-20	1/4"	88	25	20 / 400	11.0	0.59
6525	T-25	1/4"	88	25	20 / 400	11.0	0.59
6527	T-27	1/4"	88	25	20 / 400	11.0	0.59
6530	T-30	1/4"	88	25	20 / 400	11.0	0.59
6540	T-40	1/4"	88	25	20 / 400	11.0	0.59
6545	T-45	5/16"	88	35	20 / 400	15.0	0.59
6550	T-50	5/16"	88	35	20 / 400	15.0	0.59
6555	T-55	10mm	88	60	25 / 200	13.0	0.44
6560	T-60	12mm	88	85	25 / 200	18.0	0.44
6570	T-70	14mm	88	110	25 / 200	23.0	0.44
6606	T-6	1/4"	125	35	20 / 300	11.5	0.52
6607	T-7	1/4"	125	35	20 / 300	11.5	0.52
6608	T-8	1/4"	125	35	20 / 300	11.5	0.52
6609	T-9	1/4"	125	35	20 / 300	11.5	0.52
6610	T-10	1/4"	125	35	20 / 300	11.5	0.52
6615	T-15	1/4"	125	35	20 / 300	11.5	0.52
6620	T-20	1/4"	125	35	20 / 300	11.5	0.52
6625	T-25	1/4"	125	35	20 / 300	11.5	0.52
6627	T-27	1/4"	125	35	20 / 300	11.5	0.52
6630	T-30	1/4"	125	35	20 / 300	11.5	0.52
6640	T-40	1/4"	125	35	20 / 300	11.5	0.52
6645	T-45	5/16"	125	50	20 / 300	16.0	0.52
6650	T-50	5/16"	125	50	20 / 300	16.0	0.52
6655	T-55	10mm	125	85	10 / 150	14.0	0.52
6660	T-60	12mm	125	120	10 / 150	19.0	0.52
6670	T-70	14mm	125	160	10 / 150	25.0	0.52
6706	T-6	1/4"	160	45	20 / 200	9.5	0.62
6707	T-7	1/4"	160	45	20 / 200	9.5	0.62
6708	T-8	1/4"	160	45	20 / 200	9.5	0.62
6709	T-9	1/4"	160	45	20 / 200	9.5	0.62
6710	T-10	1/4"	160	45	20 / 200	9.5	0.62
6715	T-15	1/4"	160	45	20 / 200	9.5	0.62
6720	T-20	1/4"	160	45	20 / 200	9.5	0.62
6725	T-25	1/4"	160	45	20 / 200	9.5	0.62
6727	T-27	1/4"	160	45	20 / 200	9.5	0.62
6730	T-30	1/4"	160	45	20 / 200	9.5	0.62
6740	T-40	1/4"	160	45	20 / 200	9.5	0.62
6745	T-45	5/16"	160	65	20 / 200	13.5	0.62
6750	T-50	5/16"	160	65	20 / 200	13.5	0.62
6755	T-55	10mm	160	110	10 / 100	12.0	0.62
6760	T-60	12mm	160	160	10 / 100	17.0	0.62
6770	T-70	14mm	160	190	10 / 100	20.0	0.62
6806	T-6	1/4"	200	55	20 / 200	12.0	0.62
6807	T-7	1/4"	200	55	20 / 200	12.0	0.62
6808	T-8	1/4"	200	55	20 / 200	12.0	0.62
6809	T-9	1/4"	200	55	20 / 200	12.0	0.62
6810	T-10	1/4"	200	55	20 / 200	12.0	0.62
6815	T-15	1/4"	200	55	20 / 200	12.0	0.62
6820	T-20	1/4"	200	55	20 / 200	12.0	0.62
6825	T-25	1/4"	200	55	20 / 200	12.0	0.62
6827	T-27	1/4"	200	55	20 / 200	12.0	0.62
6830	T-30	1/4"	200	55	20 / 200	12.0	0.62
6840	T-40	1/4"	200	55	20 / 200	12.0	0.62
6845	T-45	5/16"	200	85	20 / 200	18.0	0.62
6850	T-50	5/16"	200	85	20 / 200	18.0	0.62
6855	T-55	10mm	200	120	10 / 100	13.0	0.62
6860	T-60	12mm	200	190	10 / 100	20.0	0.62
6870	T-70	14mm	200	260	10 / 100	27.0	0.62



# Tamperproof Star Screwdriver Bits



## Tamperproof Star Screwdriver Bits

Item No.	Size	Hex Shank	Length mm	Weight g	PCS inner/ctn	G.W. KGS	CUFT
7107	T-7	1/4"	30	8	100 / 600	6.0	0.30
7108	T-8	1/4"	30	8	100 / 600	6.0	0.30
7109	T-9	1/4"	30	8	100 / 600	6.0	0.30
7110	T-10	1/4"	30	8	100 / 600	6.0	0.30
7115	T-15	1/4"	30	8	100 / 600	6.0	0.30
7120	T-20	1/4"	30	8	100 / 600	6.0	0.30
7125	T-25	1/4"	30	8	100 / 600	6.0	0.30
7127	T-27	1/4"	30	8	100 / 600	6.0	0.30
7130	T-30	1/4"	30	8	100 / 600	6.0	0.30
7140	T-40	1/4"	30	8	100 / 600	6.0	0.30
7145	T-45	5/16"	30	11	100 / 600	8.0	0.30
7150	T-50	5/16"	30	11	100 / 600	8.0	0.30
7155	T-55	10mm	30	20	50 / 300	7.0	0.30
7160	T-60	12mm	36	30	25 / 300	10.5	0.30
7170	T-70	14mm	36	40	25 / 300	13.5	0.30
7307	T-7	1/4"	56	15	50 / 600	10.0	0.30
7308	T-8	1/4"	56	15	50 / 600	10.0	0.30
7309	T-9	1/4"	56	15	50 / 600	10.0	0.30
7310	T-10	1/4"	56	15	50 / 600	10.0	0.30
7315	T-15	1/4"	56	15	50 / 600	10.0	0.30
7320	T-20	1/4"	56	15	50 / 600	10.0	0.30
7325	T-25	1/4"	56	15	50 / 600	10.0	0.30
7327	T-27	1/4"	56	15	50 / 600	10.0	0.30
7330	T-30	1/4"	56	15	50 / 600	10.0	0.30
7340	T-40	1/4"	56	15	50 / 600	10.0	0.30
7345	T-45	5/16"	56	20	50 / 600	13.0	0.30
7350	T-50	5/16"	56	20	50 / 600	13.0	0.30
7355	T-55	10mm	56	35	20 / 300	11.5	0.52
7360	T-60	12mm	56	50	20 / 300	16.0	0.52
7370	T-70	14mm	56	65	20 / 300	20.5	0.52
7507	T-7	1/4"	88	25	20 / 400	11.0	0.59
7508	T-8	1/4"	88	25	20 / 400	11.0	0.59
7509	T-9	1/4"	88	25	20 / 400	11.0	0.59
7510	T-10	1/4"	88	25	20 / 400	11.0	0.59
7515	T-15	1/4"	88	25	20 / 400	11.0	0.59
7520	T-20	1/4"	88	25	20 / 400	11.0	0.59
7525	T-25	1/4"	88	25	20 / 400	11.0	0.59
7527	T-27	1/4"	88	25	20 / 400	11.0	0.59
7530	T-30	1/4"	88	25	20 / 400	11.0	0.59
7540	T-40	1/4"	88	25	20 / 400	11.0	0.59
7545	T-45	5/16"	88	35	20 / 400	15.0	0.59
7550	T-50	5/16"	88	35	20 / 400	15.0	0.59
7555	T-55	10mm	88	60	25 / 200	13.0	0.44
7560	T-60	12mm	88	85	25 / 200	18.0	0.44
7570	T-70	14mm	88	120	25 / 200	25.0	0.44
7607	T-7	1/4"	125	35	20 / 300	11.5	0.52
7608	T-8	1/4"	125	35	20 / 300	11.5	0.52
7609	T-9	1/4"	125	35	20 / 300	11.5	0.52
7610	T-10	1/4"	125	35	20 / 300	11.5	0.52
7615	T-15	1/4"	125	35	20 / 300	11.5	0.52
7620	T-20	1/4"	125	35	20 / 300	11.5	0.52
7625	T-25	1/4"	125	35	20 / 300	11.5	0.52
7627	T-27	1/4"	125	35	20 / 300	11.5	0.52
7630	T-30	1/4"	125	35	20 / 300	11.5	0.52
7640	T-40	1/4"	125	35	20 / 300	11.5	0.52
7645	T-45	5/16"	125	50	20 / 300	16.0	0.52
7650	T-50	5/16"	125	50	20 / 300	16.0	0.52
7655	T-55	10mm	125	80	10 / 150	13.0	0.52
7660	T-60	12mm	125	120	10 / 150	19.0	0.52
7670	T-70	14mm	125	160	10 / 150	25.0	0.52

• 160, 200, & 225mmL Screwdriver Bits on the next page.



# Tamperproof Star Screwdriver Bits

## Tamperproof Star Screwdriver Bits

Item No.	Size	Hex Shank	Length mm	Weight g	PCS inner/ctn	G.W. KGS	CUFT
7707	T-7	1/4"	160	45	20 / 200	10.0	0.62
7708	T-8	1/4"	160	45	20 / 200	10.0	0.62
7709	T-9	1/4"	160	45	20 / 200	10.0	0.62
7710	T-10	1/4"	160	45	20 / 200	10.0	0.62
7715	T-15	1/4"	160	45	20 / 200	10.0	0.62
7720	T-20	1/4"	160	45	20 / 200	10.0	0.62
7725	T-25	1/4"	160	45	20 / 200	10.0	0.62
7727	T-27	1/4"	160	45	20 / 200	10.0	0.62
7730	T-30	1/4"	160	45	20 / 200	10.0	0.62
7740	T-40	1/4"	160	45	20 / 200	10.0	0.62
7745	T-45	5/16"	160	65	20 / 200	14.0	0.62
7750	T-50	5/16"	160	65	20 / 200	14.0	0.62
7755	T-55	10mm	160	110	10 / 100	12.0	0.62
7760	T-60	12mm	160	150	10 / 100	16.0	0.62
7770	T-70	14mm	160	190	10 / 100	20.0	0.62
7807	T-7	1/4"	200	55	20 / 200	12.0	0.62
7808	T-8	1/4"	200	55	20 / 200	12.0	0.62
7809	T-9	1/4"	200	55	20 / 200	12.0	0.62
7810	T-10	1/4"	200	55	20 / 200	12.0	0.62
7815	T-15	1/4"	200	55	20 / 200	12.0	0.62
7820	T-20	1/4"	200	55	20 / 200	12.0	0.62
7825	T-25	1/4"	200	55	20 / 200	12.0	0.62
7827	T-27	1/4"	200	55	20 / 200	12.0	0.62
7830	T-30	1/4"	200	55	20 / 200	12.0	0.62
7840	T-40	1/4"	200	55	20 / 200	12.0	0.62
7845	T-45	5/16"	200	85	20 / 200	18.0	0.62
7850	T-50	5/16"	200	85	20 / 200	18.0	0.62
7855	T-55	10mm	200	130	10 / 100	14.0	0.62
7860	T-60	12mm	200	190	10 / 100	20.0	0.62
7870	T-70	14mm	200	260	10 / 100	27.0	0.62
7940	T-40	1/4"	225	60	20 / 200	13.0	0.62
7945	T-45	5/16"	225	95	20 / 200	20.0	0.62



## SB-224TOT 24 Piece Tamperproof Star Screwdriver Bit Set

Item No. Size Item No. Size

**Tamperproof Star Screwdriver Bit, 30mmL:**

7107	T-7	7120	T-20
7108	T-8	7125	T-25
7109	T-9	7127	T-27
7110	T-10	7130	T-30
7115	T-15	7140	T-40

**Tamperproof Star Screwdriver Bit, 160mmL:**

7707	T-7	7725	T-25
7708	T-8	7727	T-27
7709	T-9	7730	T-30
7710	T-10	7740	T-40
7715	T-15	7745	T-45
7720	T-20	7750	T-50

**Accessory:**

280120 3in1 Handgrip Pouch Bag      280002B Socket Holder Adapter

1000 g      20 sets / 21 Kgs / 0.88 CUFT



# Triple Square Screwdriver Bits

## Triple Square Screwdriver Bits

Item No.	Size	Hex Shank	Length mm	Weight g	PCS inner/ctn	G.W. KGS	CUFT 
8104	M4	1/4"	30	8	100 / 600	6.0	0.30
8105	M5	1/4"	30	8	100 / 600	6.0	0.30
8106	M6	1/4"	30	8	100 / 600	6.0	0.30
8108	M8	5/16"	30	11	100 / 600	8.0	0.30
8110	M10	10mm	30	20	50 / 300	7.0	0.30
8112	M12	12mm	30	30	50 / 300	10.0	0.30
8114	M14	14mm	30	35	50 / 300	11.5	0.30
8116	M16	16mm	36	60	20 / 240	15.5	0.30
8118	M18	19mm	36	75	20 / 240	19.0	0.30
2M3005	M5	10mm	30	15	100 / 600	10.0	0.30
2M3006	M6	10mm	30	15	100 / 600	10.0	0.30
2M3008	M8	10mm	30	17	100 / 600	11.0	0.30
2M3010	M10	10mm	30	17	100 / 600	13.0	0.30
2M3012	M12	10mm	30	20	100 / 600	13.0	0.30
8304	M4	1/4"	56	15	50 / 600	10.0	0.30
8305	M5	1/4"	56	15	50 / 600	10.0	0.30
8306	M6	1/4"	56	15	50 / 600	10.0	0.30
8308	M8	5/16"	56	20	50 / 600	13.0	0.30
8310	M10	10mm	56	35	20 / 300	11.5	0.52
8312	M12	12mm	56	55	20 / 300	17.5	0.52
8314	M14	14mm	56	70	20 / 300	22.0	0.52
8316	M16	16mm	56	90	20 / 300	28.0	0.52
8318	M18	19mm	56	120	10 / 120	15.5	0.30
2M7505	M5	10mm	75	45	50 / 400	19.0	0.44
2M7506	M6	10mm	75	45	50 / 400	19.0	0.44
2M7508	M8	10mm	75	45	50 / 400	19.0	0.44
2M7510	M10	10mm	75	50	50 / 400	21.0	0.44
2M7512	M12	10mm	75	65	50 / 400	26.5	0.44
8504	M4	1/4"	88	25	20 / 400	11.0	0.59
8505	M5	1/4"	88	25	20 / 400	11.0	0.59
8506	M6	1/4"	88	25	20 / 400	11.0	0.59
8508	M8	5/16"	88	35	20 / 400	15.0	0.59
8510	M10	10mm	88	60	25 / 200	13.0	0.44
8512	M12	12mm	88	85	25 / 200	18.0	0.44
8514	M14	14mm	88	110	25 / 200	23.0	0.44
8516	M16	16mm	88	150	10 / 100	16.0	0.62
8518	M18	19mm	88	200	5 / 60	13.0	0.30
8604	M4	1/4"	125	35	20 / 300	11.5	0.52
8605	M5	1/4"	125	35	20 / 300	11.5	0.52
8606	M6	1/4"	125	35	20 / 300	11.5	0.52
8608	M8	5/16"	125	55	20 / 300	17.5	0.52
8610	M10	10mm	125	85	10 / 150	13.5	0.52
8612	M12	12mm	125	120	10 / 150	19.0	0.52
8614	M14	14mm	125	160	10 / 150	25.0	0.52
8616	M16	16mm	125	210	10 / 80	18.0	0.44
8618	M18	19mm	125	240	5 / 60	18.5	0.30
8704	M4	1/4"	160	45	20 / 200	9.5	0.62
8705	M5	1/4"	160	45	20 / 200	9.5	0.62
8706	M6	1/4"	160	45	20 / 200	9.5	0.62
8708	M8	5/16"	160	65	20 / 200	13.5	0.62
8710	M10	10mm	160	110	10 / 100	11.0	0.62
8712	M12	12mm	160	150	10 / 100	16.0	0.62
8714	M14	14mm	160	200	10 / 100	21.0	0.62
8716	M16	16mm	160	280	10 / 60	18.0	0.30
8718	M18	19mm	160	380	5 / 50	20.0	0.41
8804	M4	1/4"	200	55	20 / 200	12.0	0.62
8805	M5	1/4"	200	55	20 / 200	12.0	0.62
8806	M6	1/4"	200	55	20 / 200	12.0	0.62
8808	M8	5/16"	200	85	20 / 200	18.0	0.62
8810	M10	10mm	200	130	10 / 100	14.0	0.62
8812	M12	12mm	200	190	10 / 100	20.0	0.62
8814	M14	14mm	200	260	10 / 100	27.0	0.62
8816	M16	16mm	200	340	10 / 60	21.5	0.30
8818	M18	19mm	200	470	5 / 50	24.5	0.41



# Triple Square & Square Screwdriver Bits

## Square Screwdriver Bits

Item No.	Size	Hex Shank	Length mm	Weight g	PCS inner/ctn	G.W. KGS	CUFT
9100	S# 0	1/4"	30	8	100 / 600	6.0	0.30
9101	S# 1	1/4"	30	8	100 / 600	6.0	0.30
9102	S# 2	1/4"	30	8	100 / 600	6.0	0.30
9103	S# 3	1/4"	30	8	100 / 600	6.0	0.30
9104	S# 4	1/4"	30	8	100 / 600	6.0	0.30
9300	S# 0	1/4"	56	15	50 / 600	10.0	0.30
9301	S# 1	1/4"	56	15	50 / 600	10.0	0.30
9302	S# 2	1/4"	56	15	50 / 600	10.0	0.30
9303	S# 3	1/4"	56	15	50 / 600	10.0	0.30
9304	S# 4	1/4"	56	15	50 / 600	10.0	0.30
9500	S# 0	1/4"	88	25	20 / 400	11.0	0.59
9501	S# 1	1/4"	88	25	20 / 400	11.0	0.59
9502	S# 2	1/4"	88	25	20 / 400	11.0	0.59
9503	S# 3	1/4"	88	25	20 / 400	11.0	0.59
9504	S# 4	1/4"	88	25	20 / 400	11.0	0.59
9600	S# 0	1/4"	125	35	20 / 300	11.5	0.52
9601	S# 1	1/4"	125	35	20 / 300	11.5	0.52
9602	S# 2	1/4"	125	35	20 / 300	11.5	0.52
9603	S# 3	1/4"	125	35	20 / 300	11.5	0.52
9604	S# 4	1/4"	125	35	20 / 300	11.5	0.52
9700	S# 0	1/4"	160	45	20 / 200	9.5	0.62
9701	S# 1	1/4"	160	45	20 / 200	9.5	0.62
9702	S# 2	1/4"	160	45	20 / 200	9.5	0.62
9703	S# 3	1/4"	160	45	20 / 200	9.5	0.62
9704	S# 4	1/4"	160	45	20 / 200	9.5	0.62
9800	S# 0	1/4"	200	55	20 / 200	12.0	0.62
9801	S# 1	1/4"	200	55	20 / 200	12.0	0.62
9802	S# 2	1/4"	200	55	20 / 200	12.0	0.62
9803	S# 3	1/4"	200	55	20 / 200	12.0	0.62
9804	S# 4	1/4"	200	55	20 / 200	12.0	0.62



## SB-225RHM 25 Piece Metric Hex & Square Screwdriver Bit Set

Item No.	Size	Item No.	Size
<b>Screwdriver Bit, 30mmL:</b>			
2122	2mm Hex	9100	#0 Square
2125	2.5mm Hex	9101	#1 Square
2133	3mm Hex	9102	#2 Square
2134	4mm Hex	9103	#3 Square
2135	5mm Hex	9104	#4 Square
2136	6mm Hex		
<b>Screwdriver Bit, 160mmL:</b>			
2722	2mm Hex	2748	8mm Hex
2725	2.5mm Hex	9700	#0 Square
2733	3mm Hex	9701	#1 Square
2734	4mm Hex	9702	#2 Square
2735	5mm Hex	9703	#3 Square
2736	6mm Hex	9704	#4 Square
2747	7mm Hex		

### Accessory:

280120 3in1 Handgrip

Pouch Bag

1050 g

20 sets / 22 Kgs / 0.88 CUFT



# Pentacle & Posidriv Screwdriver Bits

## Pentacle Screwdriver Bits

Item No.	Size	Hex Shank	Length mm	Weight g	PCS inner/ctn	G.W. KGS	CUFT
							
5008	T-8	1/4"	30	8	100 / 600	6.0	0.30
5010	T-10	1/4"	30	8	100 / 600	6.0	0.30
5015	T-15	1/4"	30	8	100 / 600	6.0	0.30
5020	T-20	1/4"	30	8	100 / 600	6.0	0.30
5025	T-25	1/4"	30	8	100 / 600	6.0	0.30
5027	T-27	1/4"	30	8	100 / 600	6.0	0.30
5030	T-30	1/4"	30	8	100 / 600	6.0	0.30
5040	T-40	5/16"	30	12	100 / 600	8.0	0.30
5045	T-45	5/16"	30	12	100 / 600	8.0	0.30
5050	T-50	10mm	30	20	50 / 300	7.0	0.30
5055	T-55	12mm	30	30	50 / 300	10.0	0.30
5208	T-8	1/4"	56	15	50 / 600	10.0	0.30
5210	T-10	1/4"	56	15	50 / 600	10.0	0.30
5215	T-15	1/4"	56	15	50 / 600	10.0	0.30
5220	T-20	1/4"	56	15	50 / 600	10.0	0.30
5225	T-25	1/4"	56	15	50 / 600	10.0	0.30
5227	T-27	1/4"	56	15	50 / 600	10.0	0.30
5230	T-30	1/4"	56	15	50 / 600	10.0	0.30
5240	T-40	5/16"	56	20	50 / 600	13.0	0.30
5245	T-45	5/16"	56	20	50 / 600	13.0	0.30
5250	T-50	10mm	56	40	20 / 300	12.5	0.52
5255	T-55	12mm	56	55	20 / 300	17.5	0.52
5408	T-8	1/4"	88	25	20 / 400	11.0	0.59
5410	T-10	1/4"	88	25	20 / 400	11.0	0.59
5415	T-15	1/4"	88	25	20 / 400	11.0	0.59
5420	T-20	1/4"	88	25	20 / 400	11.0	0.59
5425	T-25	1/4"	88	25	20 / 400	11.0	0.59
5427	T-27	1/4"	88	25	20 / 400	11.0	0.59
5430	T-30	1/4"	88	25	20 / 400	11.0	0.59
5440	T-40	5/16"	88	35	20 / 400	15.0	0.59
5445	T-45	5/16"	88	35	20 / 400	15.0	0.59
5450	T-50	10mm	88	60	25 / 200	12.5	0.44
5455	T-55	12mm	88	85	25 / 200	18.0	0.44



## Posidriv Screwdriver Bits

Item No.	Size	Hex Shank	Length mm	Weight g	PCS inner/ctn	G.W. KGS	CUFT
							
1210	#0	1/4"	30	8	100 / 600	6.0	0.30
1211	#1	1/4"	30	8	100 / 600	6.0	0.30
1212	#2	1/4"	30	8	100 / 600	6.0	0.30
1213	#3	1/4"	30	8	100 / 600	6.0	0.30
1221	#1	5/16"	30	12	100 / 600	8.0	0.30
1222	#2	5/16"	30	12	100 / 600	8.0	0.30
1223	#3	5/16"	30	12	100 / 600	8.0	0.30
1224	#4	5/16"	30	12	100 / 600	8.0	0.30
1311	#1	1/4"	56	15	50 / 600	10.0	0.30
1312	#2	1/4"	56	15	50 / 600	10.0	0.30
1313	#3	1/4"	56	15	50 / 600	10.0	0.30
1321	#1	5/16"	56	20	50 / 600	13.0	0.30
1322	#2	5/16"	56	20	50 / 600	13.0	0.30
1323	#3	5/16"	56	20	50 / 600	13.0	0.30
1324	#4	5/16"	56	20	50 / 600	13.0	0.30
1511	#1	1/4"	88	25	30 / 360	10.0	0.30
1512	#2	1/4"	88	25	30 / 360	10.0	0.30
1513	#3	1/4"	88	25	30 / 360	10.0	0.30
1524	#4	5/16"	88	40	25 / 300	13.0	0.30
1611	#1	1/4"	125	35	20 / 300	11.5	0.52
1612	#2	1/4"	125	35	20 / 300	11.5	0.52
1613	#3	1/4"	125	35	20 / 300	11.5	0.52
1624	#4	5/16"	125	55	20 / 300	17.5	0.52



# Ribe & Spanner Screwdriver Bits

## Ribe Screwdriver Bits

Item No.	Size	Hex Shank	Length mm	Weight g	PCS inner/ctn	G.W. KGS	CUFT 
9004	M4	1/4"	30	8	100 / 600	6.0	0.30
9005	M5	1/4"	30	8	100 / 600	6.0	0.30
9006	M6	1/4"	30	8	100 / 600	6.0	0.30
9007	M7	5/16"	30	12	100 / 600	8.0	0.30
9008	M8	5/16"	30	12	100 / 600	8.0	0.30
9009	M9	10mm	30	20	50 / 300	7.0	0.30
9010	M10	10mm	30	20	50 / 300	7.0	0.30
9012	M12	12mm	30	30	50 / 300	10.0	0.30
9013	M13	14mm	30	35	50 / 300	11.5	0.30
9014	M14	14mm	30	35	50 / 300	11.5	0.30
9016	M16	16mm	30	50	20 / 240	13.0	0.30
9204	M4	1/4"	56	15	50 / 600	10.0	0.30
9205	M5	1/4"	56	15	50 / 600	10.0	0.30
9206	M6	1/4"	56	15	50 / 600	10.0	0.30
9207	M7	5/16"	56	20	50 / 600	13.0	0.30
9208	M8	5/16"	56	20	50 / 600	13.0	0.30
9209	M9	10mm	56	40	20 / 300	12.5	0.52
9210	M10	10mm	56	40	20 / 300	12.5	0.52
9212	M12	12mm	56	55	20 / 300	17.5	0.52
9213	M13	14mm	56	70	20 / 300	21.0	0.52
9214	M14	14mm	56	70	20 / 300	21.0	0.52
9216	M16	16mm	56	70	20 / 300	21.0	0.52
9404	M4	1/4"	88	25	20 / 400	11.0	0.59
9405	M5	1/4"	88	25	20 / 400	11.0	0.59
9406	M6	1/4"	88	25	20 / 400	11.0	0.59
9407	M7	5/16"	88	35	20 / 400	13.0	0.59
9408	M8	5/16"	88	35	20 / 400	13.0	0.59
9409	M9	10mm	88	60	25 / 200	12.5	0.44
9410	M10	10mm	88	60	25 / 200	12.5	0.44
9412	M12	12mm	88	85	25 / 200	18.0	0.44
9413	M13	14mm	88	100	25 / 200	21.0	0.44
9414	M14	14mm	88	100	25 / 200	21.0	0.44
9416	M16	16mm	88	160	10 / 100	17.0	0.62



## Spanner Screwdriver Bits

Item No.	Size	Hex Shank	Length mm	Weight g	PCS inner/ctn	G.W. KGS	CUFT 
9054	SP4	1/4"	30	8	100 / 600	6.0	0.30
9056	SP6	1/4"	30	8	100 / 600	6.0	0.30
9058	SP8	1/4"	30	8	100 / 600	6.0	0.30
9060	SP10	1/4"	30	8	100 / 600	6.0	0.30
9062	SP12	1/4"	30	8	100 / 600	6.0	0.30
9064	SP14	1/4"	30	8	100 / 600	6.0	0.30
9254	SP4	1/4"	56	15	50 / 600	10.0	0.30
9256	SP6	1/4"	56	15	50 / 600	10.0	0.30
9258	SP8	1/4"	56	15	50 / 600	10.0	0.30
9260	SP10	1/4"	56	15	50 / 600	10.0	0.30
9262	SP12	1/4"	56	15	50 / 600	10.0	0.30
9264	SP14	1/4"	56	15	50 / 600	10.0	0.30



# Power Screwdriver Bits

## Slotted Power Screwdriver Bits

Item No.	Size mm	Hex Shank	Length mm	Weight g	PCS inner/ctn	G.W. KGS	CUFT 
205030	0.5 x 3.0	1/4"	50	12	100 / 600	8.5	0.30
205040	0.6 x 4.0	1/4"	50	12	100 / 600	8.5	0.30
205050	0.8 x 5.0	1/4"	50	12	100 / 600	8.5	0.30
205055	0.8 x 5.5	1/4"	50	12	100 / 600	8.5	0.30
205060	1.0 x 6.0	1/4"	50	12	100 / 600	8.5	0.30
205065	1.0 x 6.5	1/4"	50	12	100 / 600	8.5	0.30
205070	1.2 x 7.0	1/4"	50	12	100 / 600	8.5	0.30
217250	0.8 x 5.0	5/16"	72	30	100 / 300	10.0	0.30
217255	0.8 x 5.5	5/16"	72	30	100 / 300	10.0	0.30
217260	1.0 x 6.0	5/16"	72	30	100 / 300	10.0	0.30
217265	1.0 x 6.5	5/16"	72	30	100 / 300	10.0	0.30
217270	1.2 x 7.0	5/16"	72	30	100 / 300	10.0	0.30
217280	1.6 x 8.0	5/16"	72	30	100 / 300	10.0	0.30



50mmL



72mmL

## Philips Power Screwdriver Bits

Item No.	Size	Hex Shank	Length mm	Weight g	PCS inner/ctn	G.W. KGS	CUFT 
235000	#0	1/4"	50	12	100 / 600	8.5	0.30
235001	#1	1/4"	50	12	100 / 600	8.5	0.30
235002	#2	1/4"	50	12	100 / 600	8.5	0.30
235003	#3	1/4"	50	12	100 / 600	8.5	0.30
247201	#1	5/16"	72	30	100 / 300	10.0	0.30
247202	#2	5/16"	72	30	100 / 300	10.0	0.30
247203	#3	5/16"	72	30	100 / 300	10.0	0.30
247204	#4	5/16"	72	30	100 / 300	10.0	0.30



50mmL



72mmL

## Posidriv Power Screwdriver Bits

Item No.	Size	Hex Shank	Length mm	Weight g	PCS inner/ctn	G.W. KGS	CUFT 
255001	#1	1/4"	50	12	100 / 600	8.5	0.30
255002	#2	1/4"	50	12	100 / 600	8.5	0.30
255003	#3	1/4"	50	12	100 / 600	8.5	0.30
277201	#1	5/16"	72	30	100 / 300	10.0	0.30
277202	#2	5/16"	72	30	100 / 300	10.0	0.30
277203	#3	5/16"	72	30	100 / 300	10.0	0.30
277204	#4	5/16"	72	30	100 / 300	10.0	0.30



50mmL



72mmL

Screwdrivers



## Metric Hex Power Screwdriver Bits

Item No.	Size mm	Hex Shank	Length mm	Weight g	PCS inner/ctn	G.W. KGS	CUFT
265020	2	1/4"	50	12	100 / 600	8.5	0.30
265025	2.5	1/4"	50	12	100 / 600	8.5	0.30
265030	3	1/4"	50	12	100 / 600	8.5	0.30
265040	4	1/4"	50	12	100 / 600	8.5	0.30
265050	5	1/4"	50	12	100 / 600	8.5	0.30
265060	6	1/4"	50	12	100 / 600	8.5	0.30
297230	3	5/16"	72	30	100 / 300	10.0	0.30
297240	4	5/16"	72	30	100 / 300	10.0	0.30
297250	5	5/16"	72	30	100 / 300	10.0	0.30
297260	6	5/16"	72	30	100 / 300	10.0	0.30
297270	7	5/16"	72	30	100 / 300	10.0	0.30
297280	8	5/16"	72	30	100 / 300	10.0	0.30

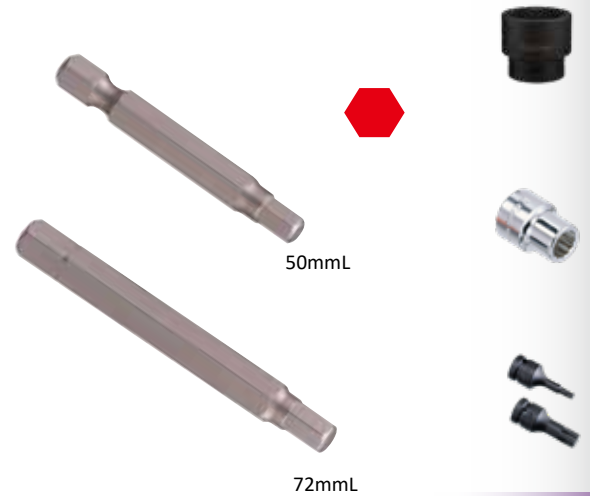

## SAE Hex Power Screwdriver Bits

Item No.	Size inch	Hex Shank	Length mm	Weight g	PCS inner/ctn	G.W. KGS	CUFT
275003	3/32	1/4"	50	12	100 / 600	8.5	0.30
275004	1/8	1/4"	50	12	100 / 600	8.5	0.30
275005	5/32	1/4"	50	12	100 / 600	8.5	0.30
275006	3/16	1/4"	50	12	100 / 600	8.5	0.30
275007	7/32	1/4"	50	12	100 / 600	8.5	0.30
275008	1/4	1/4"	50	12	100 / 600	8.5	0.30
297204	1/8	5/16"	72	30	100 / 300	10.0	0.30
297205	5/32	5/16"	72	30	100 / 300	10.0	0.30
297206	3/16	5/16"	72	30	100 / 300	10.0	0.30
297207	7/32	5/16"	72	30	100 / 300	10.0	0.30
297208	1/4	5/16"	72	30	100 / 300	10.0	0.30
297209	9/32	5/16"	72	30	100 / 300	10.0	0.30
297210	5/16	5/16"	72	30	100 / 300	10.0	0.30



## Star Power Screwdriver Bits

Item No.	Size	Hex Shank	Length mm	Weight g	PCS inner/ctn	G.W. KGS	CUFT
285008	T-8	1/4"	50	12	100 / 600	8.5	0.30
285010	T-10	1/4"	50	12	100 / 600	8.5	0.30
285015	T-15	1/4"	50	12	100 / 600	8.5	0.30
285020	T-20	1/4"	50	12	100 / 600	8.5	0.30
285025	T-25	1/4"	50	12	100 / 600	8.5	0.30
285027	T-27	1/4"	50	12	100 / 600	8.5	0.30
285030	T-30	1/4"	50	12	100 / 600	8.5	0.30
285040	T-40	1/4"	50	12	100 / 600	8.5	0.30
227210	T-10	5/16"	72	30	100 / 300	10.0	0.30
227215	T-15	5/16"	72	30	100 / 300	10.0	0.30
227220	T-20	5/16"	72	30	100 / 300	10.0	0.30
227225	T-25	5/16"	72	30	100 / 300	10.0	0.30
227227	T-27	5/16"	72	30	100 / 300	10.0	0.30
227230	T-30	5/16"	72	30	100 / 300	10.0	0.30
227240	T-40	5/16"	72	30	100 / 300	10.0	0.30
227245	T-45	5/16"	72	30	100 / 300	10.0	0.30
227250	T-50	5/16"	72	30	100 / 300	10.0	0.30



# Impact Screwdriver Bits

## Metric & SAE Hex Impact Screwdriver Bits

Item No.	Size mm	Hex Shank	Length mm	Weight g	PCS inner/ctn	G.W. KGS	CUFT
2914	14	19mm	45	80	10 / 140	12.5	0.44
2916	16	19mm	45	95	10 / 140	14.5	0.44
2917	17	19mm	45	100	10 / 140	15.0	0.44
2918	18	19mm	45	110	10 / 140	16.5	0.44
2919	19	19mm	45	120	10 / 140	18.0	0.44
2922	22	22mm	50	160	10 / 140	23.5	0.44
2924	24	22mm	50	180	10 / 120	22.5	0.52
2927	27	27mm	55	270	10 / 60	17.5	0.45
2930	30	27mm	55	300	10 / 60	19.0	0.45
2932	32	27mm	55	330	10 / 60	21.0	0.45
2933	33	32mm	60	430	5 / 50	22.5	0.34
2936	36	32mm	60	480	5 / 50	25.0	0.34
3027	27	41mm	60	510	1 / 30	15.0	0.38
3030	30	41mm	60	540	1 / 30	17.0	0.38
3032	32	41mm	60	560	1 / 30	18.0	0.38
3036	36	41mm	60	610	1 / 30	19.0	0.38
3038	38	41mm	60	640	1 / 30	20.0	0.38
3041	41	41mm	65	770	1 / 20	16.5	0.39
3046	46	41mm	65	840	1 / 20	18.0	0.39
3050	50	41mm	70	1020	1 / 20	21.5	0.39
3055	55	41mm	75	1260	1 / 10	13.5	0.31
3060	60	41mm	80	1560	1 / 10	16.5	0.31

Item No.	Size inch	Hex Shank	Length mm	Weight g	PCS inner/ctn	G.W. KGS	CUFT
3936	9/16	19mm	45	90	10 / 140	13.5	0.44
3940	5/8	19mm	45	95	10 / 140	14.5	0.44
3948	3/4	19mm	45	110	10 / 140	16.5	0.44
3952	13/16	22mm	50	150	10 / 140	22.0	0.44
3956	7/8	22mm	50	170	10 / 140	25.0	0.44
3960	15/16	22mm	50	180	10 / 120	22.5	0.52
3964	1"	22mm	50	200	10 / 120	25.0	0.52
3968	1-1/16"	27mm	55	270	10 / 60	17.0	0.45
3972	1-1/8"	27mm	55	290	10 / 60	18.5	0.45
3976	1-3/16"	27mm	55	310	10 / 60	19.5	0.45
3980	1-1/4	27mm	55	330	10 / 60	21.0	0.45
3984	1-5/16	32mm	60	430	5 / 50	22.5	0.34
3988	1-3/8	32mm	60	460	5 / 50	24.0	0.34

## Triple Square Impact Screwdriver Bits

Item No.	Size	Hex Shank	Length mm	Weight g	PCS inner/ctn	G.W. KGS	CUFT
9916	M16	19mm	60	130	10 / 140	19.0	0.44
9918	M18	19mm	60	140	10 / 140	20.5	0.44

## Star Impact Screwdriver Bits

Item No.	Size	Hex Shank	Length mm	Weight g	PCS inner/ctn	G.W. KGS	CUFT
6980	T-80	19mm	60	130	10 / 140	19.0	0.44
6990	T-90	19mm	60	130	10 / 140	19.0	0.44
6995	T-100	19mm	60	140	10 / 140	20.5	0.44

## Impact Bit Holders

Item No.	Drive	Hex Shank	Length mm	Weight g	PCS inner/ctn	G.W. KGS	CUFT
619+	3/4"	19mm	55	300	1 / 30	10.0	0.38
622+	3/4"	22mm	55	350	1 / 30	11.5	0.38
627+	3/4"	27mm	60	470	1 / 30	15.0	0.38
819+	1"	19mm	60	520	1 / 30	16.5	0.38
822+	1"	22mm	60	520	1 / 30	16.5	0.38
827+	1"	27mm	65	630	1 / 30	20.0	0.38
832+	1"	32mm	65	690	1 / 30	21.5	0.38
941+	1-1/2"	41mm	80	2100	1 / 10	22.0	0.43



## Bit Holders

Item No.	Drive	Hex Shank	Length mm	Weight g	PCS inner/ctn	G.W. KGS	CUFT 
208+	1/4"	1/4"	25	14	20 / 600	9.5	0.38
308+	3/8"	1/4"	28	30	20 / 300	10.0	0.69
310+	3/8"	5/16"	30	35	20 / 300	11.5	0.69
312+	3/8"	3/8"	30	45	20 / 300	14.5	0.69
314+	3/8"	7/16"	30	45	20 / 300	14.5	0.69
316+	3/8"	1/2"	30	60	20 / 300	19.0	0.69
339+	3/8"	9mm	30	45	20 / 300	14.5	0.69
340+	3/8"	10mm	30	45	20 / 300	14.5	0.69
341+	3/8"	11mm	30	50	20 / 300	16.0	0.69
342+	3/8"	12mm	30	50	20 / 300	16.0	0.69
344+	3/8"	14mm	30	60	20 / 300	19.0	0.69
408+	1/2"	1/4"	36	55	10 / 200	12.0	0.59
410+	1/2"	5/16"	38	60	10 / 200	13.0	0.59
412+	1/2"	3/8"	40	70	10 / 200	15.0	0.59
414+	1/2"	7/16"	40	85	10 / 200	18.0	0.59
416+	1/2"	1/2"	40	90	10 / 200	19.0	0.59
418+	1/2"	9/16"	40	90	10 / 200	19.0	0.59
420+	1/2"	5/8"	40	100	10 / 200	21.0	0.59
422+	1/2"	11/16"	40	110	10 / 200	23.0	0.59
424+	1/2"	3/4"	40	120	10 / 200	25.0	0.59
439+	1/2"	9mm	40	70	10 / 200	15.0	0.59
440+	1/2"	10mm	40	70	10 / 200	15.0	0.59
441+	1/2"	11mm	40	80	10 / 200	17.0	0.59
442+	1/2"	12mm	40	85	10 / 200	18.0	0.59
443+	1/2"	13mm	40	90	10 / 200	19.0	0.59
444+	1/2"	14mm	40	90	10 / 200	19.0	0.59
446+	1/2"	16mm	40	100	10 / 200	21.0	0.59
447+	1/2"	17mm	40	100	10 / 200	21.0	0.59
449+	1/2"	19mm	40	120	10 / 200	25.0	0.59



## Bit Holders (Quick Change)

Item No.	Drive	Hex Shank	Length mm	Weight g	PCS inner/ctn	G.W. KGS	CUFT 
283508	1/4"	1/4"	35	20	10 / 300	7.0	0.38
283510	1/4"	5/16"	35	25	10 / 300	8.0	0.38
383908	3/8"	1/4"	39	40	10 / 200	9.0	0.60
384608	3/8"	1/4"	46	50	10 / 200	11.0	0.60
383910	3/8"	5/16"	39	45	10 / 200	10.0	0.60
384610	3/8"	5/16"	46	55	10 / 200	12.0	0.60
383912	3/8"	3/8"	39	50	10 / 200	11.0	0.52
323910	3/8"	10mm	39	60	10 / 200	13.0	0.52
484108	1/2"	1/4"	41	60	10 / 200	13.0	0.52
484808	1/2"	1/4"	48	65	10 / 200	14.0	0.52
484110	1/2"	5/16"	41	65	10 / 200	14.0	0.52
484810	1/2"	5/16"	48	70	10 / 200	15.0	0.52
484112	1/2"	3/8"	41	75	10 / 200	16.0	0.52
484314	1/2"	7/16"	43	95	10 / 200	20.0	0.52
484516	1/2"	1/2"	45	100	10 / 200	21.0	0.52
424109	1/2"	9mm	41	63	10 / 200	13.5	0.52
424110	1/2"	10mm	41	75	10 / 200	16.0	0.52
424111	1/2"	11mm	41	80	10 / 200	17.0	0.52
424312	1/2"	12mm	43	90	10 / 200	19.0	0.52
424514	1/2"	14mm	45	100	10 / 200	21.0	0.52



## Spinner Handles

Item No.	Square Drive	Hex Drive	Length mm	Weight g	PCS inner/ctn	G.W. KGS	CUFT
272065	1/4"	1/4"	65	20	30 / 600	13.0	0.34
273065	3/8"	1/4"	65	30	20 / 480	15.5	0.41
274065	1/2"	1/4"	65	45	10 / 240	12.0	0.41
272140	1/4"	1/4"	140	50	20 / 240	13.0	0.30



### BE-2343 3 Piece Spinner Handle Set

**Item No. Description**

#### Spinner Handles

272065 1/4" Dr. 1/4" Hex Shank  
 273065 3/8" Dr. 1/4" Hex Shank  
 274065 1/2" Dr. 1/4" Hex Shank

Sliding Card

100 g 30x6 180 sets / 20 Kgs / 1.21 CUFT



## Spinner Handles (for Electric Drill)

Item No.	Square Drive	Hex Drive	L1 mm	Length mm	Weight g	PCS inner/ctn	G.W. KGS	CUFT
27206A	1/4"	1/4"	9.5	65	20	30 / 600	13.0	0.34
27306A	3/8"	1/4"	9.5	65	30	20 / 480	15.5	0.41
27406A	1/2"	1/4"	9.5	65	45	10 / 240	12.0	0.41
27206P	1/4"	1/4"	13	65	20	30 / 600	13.0	0.34
27306P	3/8"	1/4"	13	65	30	20 / 480	15.5	0.41
27406P	1/2"	1/4"	13	65	45	10 / 240	12.0	0.41

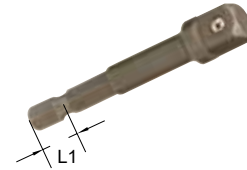

### BE-2343A 3 Piece Spinner Handle Set (for L1=9.5mm Electric Drill)

**Item No. Description**

#### Spinner Handles (for L1=9.5mm Electric Drill)

27206A 1/4" Dr. 1/4" Hex Shank  
 27306A 3/8" Dr. 1/4" Hex Shank  
 27406A 1/2" Dr. 1/4" Hex Shank

Sliding Card

100 g 30x6 180 sets / 20 Kgs / 1.21 CUFT

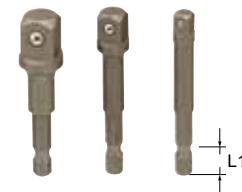

### BE-2343P 3 Piece Spinner Handle Set (for L1=13mm Electric Drill)

**Item No. Description**

#### Spinner Handles (for L1=13mm Electric Drill)

27206P 1/4" Dr. 1/4" Hex Shank  
 27306P 3/8" Dr. 1/4" Hex Shank  
 27406P 1/2" Dr. 1/4" Hex Shank

Sliding Card

100 g 30x6 180 sets / 20 Kgs / 1.21 CUFT

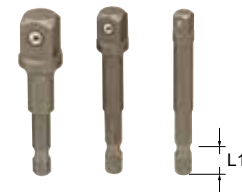

## OMNIDRIVE® 3 in 1 Handgrip

Item No.	Hex Shank	Hex Shank	Hex Shank	Length mm	Weight g	PCS inner/ctn	G.W. KGS	CUFT
280120	1/4"	1/4"	5/16"	120	130	10 / 80	14.0	1.60

Be versatile. The OMNIDRIVE 3-in-1 Handgrip grants users the ability to interchange bits with its 1/4" and 5/16" hex shank drivers while alternating between traditional screwdriver and T-handle style grips.

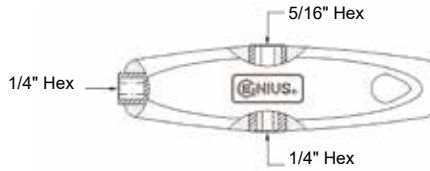

## OMNIDRIVE® 4 in 1 Handgrip

Item No.	Hex Shank	Hex Shank	Square Drive	Hex Shank	Length mm	Weight g	PCS inner/ctn	G.W. KGS	CUFT
280121M	1/4"	1/4"	1/4"	5/16"	120	160	10 / 80	16.0	1.60

Be versatile. The OMNIDRIVE 4-in-1 Handgrip grants users the ability to interchange bits with its 1/4" and 5/16" hex shank drivers and 1/4" square drive while alternating between traditional screwdriver and T-handle style grips.

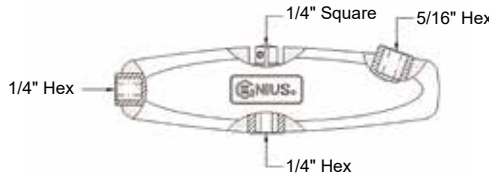

## T-Handle Ratcheting Screwdrivers

Item No.	Hex Shank	Shank Length mm	Overall Length mm	Weight g	PCS inner/ctn	G.W. KGS	CUFT
520+2982	1/4"	22	72	120	10 / 60	8.5	1.58
* 520+2983	1/4"	22	72	120	10 / 60	8.5	1.58
520+2985	1/4"	50	100	130	10 / 60	9.0	1.58
520+2988	1/4"	85	135	170	5 / 30	6.0	1.58
520+2990	1/4"	200	250	210	5 / 30	7.5	1.58

\* With quick release chuck



## Stubby Handle Ratcheting Screwdrivers

Item No.	Hex Shank	Shank Length mm	Overall Length mm	Weight g	PCS inner/ctn	G.W. KGS	CUFT
522+2982	1/4"	22	87	120	10 / 60	8.5	1.21
* 522+2983	1/4"	22	87	120	10 / 60	8.5	1.21
522+2985	1/4"	50	115	160	10 / 60	10.5	1.21

\* With quick release chuck



## Standard Handle Ratcheting Screwdrivers

Item No.	Hex Shank	Shank Length mm	Overall Length mm	Weight g	PCS inner/ctn	G.W. KGS	CUFT
524+2982	1/4"	22	162	150	10 / 60	10.0	2.06
* 524+2983	1/4"	22	162	150	10 / 60	10.0	2.06
524+2985	1/4"	50	190	160	10 / 60	11.0	2.06
524+2988	1/4"	85	225	180	10 / 60	12.0	2.06
524+2990	1/4"	200	340	240	10 / 60	16.0	2.06

\* With quick release chuck



## Pistol Grip Handle Ratcheting Screwdrivers

Item No.	Hex Shank	Shank Length mm	Overall Length mm	Weight g	PCS inner/ctn	G.W. KGS	CUFT
* 526+2983	1/4"	22	170	170	10 / 40	8.0	1.96
526+2985	1/4"	50	190	190	10 / 40	8.5	1.96
* 526+2986	1/4"	50	190	190	10 / 40	8.5	1.96
526+2988	1/4"	85	230	210	10 / 40	9.5	1.96

\* With quick release chuck



## Magnetic Bit Holder With Handle

Item No.	Hex Shank	L1 mm	Length mm	Weight g	PCS inner/ctn	G.W. KGS	CUFT
594+0230	1/4"	125	230	120	30 / 120	15.5	1.60

## Flexible Bit Holder With Handle

Item No.	Hex Shank	L1 mm	Length mm	Weight g	PCS inner/ctn	G.W. KGS	CUFT
594+0260	1/4"	150	260	120	10 / 60	8.5	1.21

## Flexible Spinner With Handle

Item No.	Hex Shank	L1 mm	Length mm	Weight g	PCS inner/ctn	G.W. KGS	CUFT
594+0250	1/4"	145	255	120	10 / 60	8.5	1.21

## Bit Holder With Handle

Item No.	Hex Shank	Length mm	Weight g	PCS inner/ctn	G.W. KGS	CUFT
280150	1/4"	150	85	5 / 100	12.0	1.21

## Magnetic Bit Holder Adapters

Item No.	Hex Shank	Hex Drive	Length mm	Weight g	PCS inner/ctn	G.W. KGS	CUFT
286008	1/4"	1/4"	60	25	20 / 400	11.0	0.39
286008M	1/4"	1/4"	60	25	20 / 400	11.0	0.39

- 286008 is direct fitting for electric and pneumatic impact wrenches

## Magnetic Bit Holder Adapters With Quick Release

Item No.	Hex Shank	Hex Drive	Length mm	Weight g	PCS inner/ctn	G.W. KGS	CUFT
285708	1/4"	1/4"	60	35	20 / 400	15.0	0.52
285708M	1/4"	1/4"	60	35	20 / 400	15.0	0.52

- Model with quick release chuck
- 285708 is direct fitting for electric and pneumatic impact wrenches

## Bit Holder Adapter

Item No.	Hex Shank	Hex Drive	Length mm	Weight g	PCS inner/ctn	G.W. KGS	CUFT
285608	1/4"	1/4"	60	30	20 / 400	13.5	0.52

## Magnetic Bit Holder With Handle

Item No.	Hex Shank	Length mm	Weight g	PCS inner/ctn	G.W. KGS	CUFT
280060	1/4"	60	45	50 / 200	10.0	1.39

## Socket Holder Adapter

Item No.	Square Drive	Hex Drive	Length mm	Weight g	PCS inner/ctn	G.W. KGS	CUFT
280002B	1/4"	1/4"	30	10	20 / 600	7.0	0.38



## Flexible Extension



Item No.	Male Drive	Female Drive	Length mm	Weight g	PCS inner/ctn	G.W. KGS	CUFT
282150	1/4"	1/4"	150	65	10 / 120	9.0	0.30

## Flexible Bit Holder



Item No.	Hex Shank	Female Drive	Length mm	Weight g	PCS inner/ctn	G.W. KGS	CUFT
282165	1/4"	1/4"	165	70	10 / 120	9.5	0.30

## Magnetic Bit Holders



Item No.	Hex Shank	Hex Drive	Length mm	Weight g	PCS inner/ctn	G.W. KGS	CUFT
0230	1/4"	1/4"	150	40	20 / 300	13.0	0.52
0233	1/4"	1/4"	250	80	10 / 210	18.0	0.44

## Flexible Extensions



Item No.	Square Drive	Hex Drive	Length mm	Weight g	PCS inner/ctn	G.W. KGS	CUFT
0250	1/4"	1/4"	170	65	20 / 300	20.5	0.52
0350	1/4"	1/4"	300	110	15 / 180	21.0	0.52

## Flexible Bit Holders



Item No.	Hex Shank	Hex Drive	Length mm	Weight g	PCS inner/ctn	G.W. KGS	CUFT
0260	1/4"	1/4"	180	75	20 / 300	23.5	0.52
0330	1/4"	1/4"	300	110	15 / 180	21.0	0.52

## GA-015A 15 Piece 1/4" Hex Shank Ratcheting Screwdriver Accessory Set

Item No.	Description
3516	1/4" Hex Shank Screwdriver Bit, 88mmL
3716	1/4" Hex Shank Screwdriver Bit, 160mmL
3916	1/4" Hex Shank Screwdriver Bit, 250mmL
285708M	1/4" Dr. 1/4" Hex Shank Magnetic Bit Holder Adapter
0230	1/4" Dr. 1/4" Hex Shank Magnetic Bit Holder, 150mmL
0233	1/4" Dr. 1/4" Hex Shank Magnetic Bit Holder, 250mmL
0250	1/4" Dr. 1/4" Hex Shank Flexible Extension, 170mmL
0350	1/4" Dr. 1/4" Hex Shank Flexible Extension, 300mmL
0330	1/4" Dr. 1/4" Hex Shank Flexible Bit Holder, 300mmL
272065	1/4" Dr. 1/4" Hex Shank Spinner Handle, 65mmL
272140	1/4" Dr. 1/4" Hex Shank Spinner Handle, 140mmL
280060	Magnetic Bit Holder With Handle
520+2983	T-Handle Ratcheting Screwdriver With Quick Release Chuck
524+2983	Standard Handle Ratcheting Screwdriver With Quick Release Chuck
285808	1/4" Dr. 1/4" Hex Shank Bit Holder Adapter
Blow Case	

1600 g 6 sets / 10.5 Kgs / 1.12 CUFT



# Screwdriver Bit Sets

## SB-111SP 11 Piece Slotted & Philips Screwdriver Bit Set

Item No.	Size	Item No.	Size
<b>Screwdriver Bit, 30mmL:</b>			
1130	0.5 x 3.0mm	1170	1.2 x 7.0mm
1140	0.6 x 4.0mm	1100	#0 Philips
1150	0.8 x 5.0mm	1101	#1 Philips
1155	0.8 x 5.5mm	1102	#2 Philips
1160	1.0 x 6.0mm	1103	#3 Philips

### Accessory:

280002B Socket Holder Adapter Plastic Holder

100 g 40x4 160 sets / 17 Kgs / 0.71 CUFT

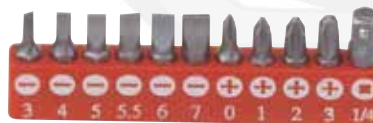

## SB-311SH 11 Piece SAE Hex Screwdriver Bit Set

Item No.	Size	Item No.	Size
<b>Screwdriver Bit, 30mmL:</b>			
3104	1/16" Hex Bit	3112	3/16" Hex Bit
3105	5/64" Hex Bit	3114	7/32" Hex Bit
3106	3/32" Hex Bit	3116	1/4" Hex Bit
3107	7/64" Hex Bit	273009	9/32" Hex Bit
3108	1/8" Hex Bit	273010	5/16" Hex Bit
3110	5/32" Hex Bit		Plastic Holder

100 g 40x4 160 sets / 17 Kgs / 0.71 CUFT



## SB-211MH 11 Piece Metric Hex & Triple Square Screwdriver Bit Set

Item No.	Size	Item No.	Size
<b>Screwdriver Bit, 30mmL:</b>			
2122	2mm Hex	263070	7mm Hex
2125	2.5mm Hex	263080	8mm Hex
2133	3mm Hex	8104	M4 Triple Square
2134	4mm Hex	8105	M5 Triple Square
2135	5mm Hex	8106	M6 Triple Square
2136	6mm Hex		Plastic Holder

100 g 40x4 160 sets / 17 Kgs / 0.71 CUFT

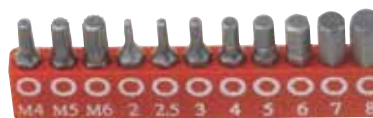

## SB-711TP 11 Piece Star Screwdriver Bit Set

Item No.	Size	Item No.	Size
<b>Screwdriver Bit, 30mmL:</b>			
6106	T-6 Star	6120	T-20 Star
6107	T-7 Star	6125	T-25 Star
6108	T-8 Star	6127	T-27 Star
6109	T-9 Star	6130	T-30 Star
6110	T-10 Star	6140	T-40 Star
6115	T-15 Star		Plastic Holder

100 g 40x4 160 sets / 17 Kgs / 0.71 CUFT



## SB-811TP 11 Piece Tamperproof Star Screwdriver Bit Set

Item No.	Size	Item No.	Size
<b>Screwdriver Bit, 30mmL:</b>			
7107	T-7 Tamperproof Star	7125	T-25 Tamperproof Star
7108	T-8 Tamperproof Star	7127	T-27 Tamperproof Star
7109	T-9 Tamperproof Star	7130	T-30 Tamperproof Star
7110	T-10 Tamperproof Star	7140	T-40 Tamperproof Star
7115	T-15 Tamperproof Star	283045A	T-45 Tamperproof Star
7120	T-20 Tamperproof Star		Plastic Holder

100 g 40x4 160 sets / 17 Kgs / 0.71 CUFT





# Screwdriver Bit Sets

## SB-220MH 20 Piece Metric Hex Screwdriver Bit Set

Item No.	Size	Item No.	Size
<b>Screwdriver Bit, 30mmL:</b>			
2122	2mm Hex	1150	0.8 x 5.0mm
2125	2.5mm Hex	1165	1.0 x 6.5mm
2133	3mm Hex	1101	#1 Philips
2134	4mm Hex	1102	#2 Philips
2135	5mm Hex	1103	#3 Philips
2136	6mm Hex		
<b>Screwdriver Bit, 160mmL:</b>			
2722	2mm Hex	2735	5mm Hex
2725	2.5mm Hex	2736	6mm Hex
2733	3mm Hex	2747	7mm Hex
2734	4mm Hex	2748	8mm Hex

### Accessory:

280120 3in1 Handgrip

Pouch Bag

810 g

20 sets / 17.5 Kgs / 0.88 CUFT



## SB-225RHM 25 Piece Metric Hex & Square Screwdriver Bit Set

Item No.	Size	Item No.	Size
<b>Screwdriver Bit, 30mmL:</b>			
2122	2mm Hex	9100	#0 Square
2125	2.5mm Hex	9101	#1 Square
2133	3mm Hex	9102	#2 Square
2134	4mm Hex	9103	#3 Square
2135	5mm Hex	9104	#4 Square
2136	6mm Hex		
<b>Screwdriver Bit, 160mmL:</b>			
2722	2mm Hex	2748	8mm Hex
2725	2.5mm Hex	9700	#0 Square
2733	3mm Hex	9701	#1 Square
2734	4mm Hex	9702	#2 Square
2735	5mm Hex	9703	#3 Square
2736	6mm Hex	9704	#4 Square
2747	7mm Hex		

### Accessory:

280120 3in1 Handgrip

Pouch Bag

1050 g

20 sets / 22 Kgs / 0.88 CUFT



## SB-218MWH 18 Piece Metric Wobble Hex Screwdriver Bit Set

Item No.	Size	Item No.	Size
<b>Screwdriver Bit, 30mmL:</b>			
1150	0.8 x 5.0mm	1103	#3 Philips
1160	1.0 x 6.0mm	4133	3mm Wobble Hex
1170	1.2 x 7.0mm	4134	4mm Wobble Hex
1101	#1 Philips	4135	5mm Wobble Hex
1102	#2 Philips	4136	6mm Wobble Hex
<b>Screwdriver Bit, 160mmL:</b>			
4733	3mm Hex	4736	6mm Hex
4734	4mm Hex	4747	7mm Hex
4735	5mm Hex	4748	8mm Hex

### Accessory:

280120 3in1 Handgrip

280002B Socket Holder Adapter

Pouch Bag

720 g

20 sets / 15.5 Kgs / 0.88 CUFT



# Screwdriver Bit Sets

## SB-223SH 23 Piece SAE Hex Screwdriver Bit Set

Item No.	Size	Item No.	Size
<b>Screwdriver Bit, 30mmL:</b>			
3104	1/16" Hex	3112	3/16" Hex
3105	5/64" Hex	3114	7/32" Hex
3106	3/32" Hex	3116	1/4" Hex
3107	7/64" Hex	273009	9/32" Hex
3108	1/8" Hex	273010	5/16" Hex
3110	5/32" Hex		
<b>Screwdriver Bit, 160mmL:</b>			
3704	1/16" Hex	3712	3/16" Hex
3705	5/64" Hex	3714	7/32" Hex
3706	3/32" Hex	3716	1/4" Hex
3707	7/64" Hex	3718	9/32" Hex
3710	5/32" Hex	3720	5/16" Hex

### Accessory:

280120	3in1 Handgrip	Pouch Bag
--------	---------------	-----------

950 g      20 sets / 20 Kgs / 0.88 CUFT



## SB-227RHS 27 Piece SAE Hex & Square Screwdriver Bit Set

Item No.	Size	Item No.	Size
<b>Screwdriver Bit, 30mmL:</b>			
3106	3/32" Hex	9100	#0 Square
3108	1/8" Hex	9101	#1 Square
3110	5/32" Hex	9102	#2 Square
3112	3/16" Hex	9103	#3 Square
3114	7/32" Hex	9104	#4 Square
3116	1/4" Hex		
<b>Screwdriver Bit, 160mmL:</b>			
3704	1/16" Hex	3718	9/32" Hex
3705	5/64" Hex	3720	5/16" Hex
3706	3/32" Hex	9700	#0 Square
3708	1/8" Hex	9701	#1 Square
3710	5/32" Hex	9702	#2 Square
3712	3/16" Hex	9703	#3 Square
3714	7/32" Hex	9704	#4 Square
3716	1/4" Hex		

### Accessory:

280120	3in1 Handgrip	Pouch Bag
--------	---------------	-----------

1120 g      20 sets / 23.5 Kgs / 0.88 CUFT



## SB-219SWH 19 Piece SAE Wobble Hex Screwdriver Bit Set

Item No.	Size	Item No.	Size
<b>Screwdriver Bit, 30mmL:</b>			
1150	0.8 x 5.0mm	5108	1/8" Wobble Hex
1165	1.0 x 6.5mm	5110	5/32" Wobble Hex
1101	#1 Philips	5112	3/16" Wobble Hex
1102	#2 Philips	5114	7/32" Wobble Hex
1103	#3 Philips	5116	1/4" Wobble Hex
<b>Screwdriver Bit, 160mmL:</b>			
5708	1/8" Wobble Hex	5716	1/4" Wobble Hex
5710	5/32" Wobble Hex	5718	9/32" Wobble Hex
5712	3/16" Wobble Hex	5720	5/16" Wobble Hex
5714	7/32" Wobble Hex		

### Accessory:

280120	3in1 Handgrip	280002B	Socket Holder Adapter
	Pouch Bag		

770 g      20 sets / 16.5 Kgs / 0.88 CUFT



## SB-225TO 25 Piece Star Screwdriver Bit Set

Item No.	Size	Item No.	Size
<b>Screwdriver Bit, 30mmL:</b>			
6106	T-6 Star	6120	T-20 Star
6107	T-7 Star	6125	T-25 Star
6108	T-8 Star	6127	T-27 Star
6109	T-9 Star	6130	T-30 Star
6110	T-10 Star	6140	T-40 Star
6115	T-15 Star		
<b>Screwdriver Bit, 160mmL:</b>			
6706	T-6 Star	6725	T-25 Star
6707	T-7 Star	6727	T-27 Star
6708	T-8 Star	6730	T-30 Star
6709	T-9 Star	6740	T-40 Star
6710	T-10 Star	6745	T-45 Star
6715	T-15 Star	6750	T-50 Star
6720	T-20 Star		

### Accessory:

280120 3in1 Handgrip Pouch Bag

1030 g 20 sets / 21.5 Kgs / 0.88 CUFT



## SB-224TOT 24 Piece Tamperproof Star Screwdriver Bit Set

Item No.	Size	Item No.	Size
<b>Tamperproof Star Screwdriver Bit, 30mmL:</b>			
7107	T-7	7120	T-20
7108	T-8	7125	T-25
7109	T-9	7127	T-27
7110	T-10	7130	T-30
7115	T-15	7140	T-40
<b>Tamperproof Star Screwdriver Bit, 160mmL:</b>			
7707	T-7	7725	T-25
7708	T-8	7727	T-27
7709	T-9	7730	T-30
7710	T-10	7740	T-40
7715	T-15	7745	T-45
7720	T-20	7750	T-50

### Accessory:

280120 3in1 Handgrip Pouch Bag 280002B Socket Holder Adapter

1000 g 20 sets / 21 Kgs / 0.88 CUFT



## SB-216TS 16 Piece Triple Square Screwdriver Bit Set

Item No.	Size	Item No.	Size
<b>Screwdriver Bit, 30mmL:</b>			
1150	0.8 x 5.0mm	1102	#2 Philips
1160	1.0 x 6.0mm	1103	#3 Philips
1170	1.2 x 7.0mm	8104	M4 Triple Square
1100	#0 Philips	8105	M5 Triple Square
1101	#1 Philips	8106	M6 Triple Square
<b>Screwdriver Bit, 160mmL:</b>			
8704	M4 Triple Square	8706	M6 Triple Square
8705	M5 Triple Square	8708	M8 Triple Square

### Accessory:

280120 3in1 Handgrip Pouch Bag 280002B Socket Holder Adapter

600 g 20 sets / 13.5 Kgs / 0.88 CUFT



# Screwdriver Bit Sets

## SC-237M 37 Piece Ratcheting Screwdriver & Bit Set

Item No.	Size	Item No.	Size
<b>Screwdriver Bit, 30mmL:</b>			
1130	0.5 x 3.0mm	6110	T-10 Star
1140	0.6 x 4.0mm	6115	T-15 Star
1150	0.8 x 5.0mm	6120	T-20 Star
1155	0.8 x 5.5mm	6125	T-25 Star
1160	1.0 x 6.0mm	6127	T-27 Star
1170	1.2 x 7.0mm	6130	T-30 Star
1101	#1 Philips	6140	T-40 Star
1102	#2 Philips	7110	T-10 Tamperproof Star
1103	#3 Philips	7115	T-15 Tamperproof Star
1211	#1 Posidriv	7120	T-20 Tamperproof Star
1212	#2 Posidriv	7125	T-25 Tamperproof Star
1213	#3 Posidriv	7127	T-27 Tamperproof Star
2122	2mm Hex	7130	T-30 Tamperproof Star
2125	2.5mm Hex	7140	T-40 Tamperproof Star
2133	3mm Hex	8104	M4 Triple Square
2134	4mm Hex	8105	M5 Triple Square
2135	5mm Hex	8106	M6 Triple Square
2136	6mm Hex		

### Accessory:

280002B 1/4" Dr. 1/4" Hex Drive Socket Holder Adapter  
 524+2988 1/4" Hex Shank Ratcheting Screwdriver  
 Blow Case

650 g

20 sets / 14 Kgs / 1.5 CUFT



## SC-234A 34 Piece Ratcheting Screwdriver & Bit Set

Item No.	Size	Item No.	Size
<b>Screwdriver Bit, 30mmL:</b>			
1140	0.6 x 4.0mm	3106	3/32" Hex
1150	0.8 x 5.0mm	3108	1/8" Hex
1155	0.8 x 5.5mm	3110	5/32" Hex
1160	1.0 x 6.0mm	3112	3/16" Hex
1165	1.0 x 6.5mm	3114	7/32" Hex
1170	1.2 x 7.0mm	3116	1/4" Hex
1101	#1 Philips	9101	S#1 Square
1102	#2 Philips	9102	S#2 Square
1103	#3 Philips	9103	S#3 Square
6110	T-10 Star	7110	T-10 Tamperproof Star
6115	T-15 Star	7115	T-15 Tamperproof Star
6120	T-20 Star	7120	T-20 Tamperproof Star
6125	T-25 Star	7125	T-25 Tamperproof Star
6127	T-27 Star	7127	T-27 Tamperproof Star
6130	T-30 Star	7130	T-30 Tamperproof Star
6140	T-40 Star	7140	T-40 Tamperproof Star

### Accessory:

280002B 1/4" Dr. 1/4" Hex Drive Socket Holder Adapter  
 524+2988 1/4" Hex Shank Ratcheting Screwdriver  
 Blow Case

700 g

20 sets / 15 Kgs / 1.5 CUFT



# Screwdriver Bit Sets

## TX-3440 40 Piece 3/8" & 1/2" Dr. 10mm Hex Shank Mechanics Bit Set

Item No.	Size	Item No.	Size
<b>10mm Hex Shank Screwdriver Bit:</b>			
2H3004	4mm Hex, 30mmL	2H7504	4mm Hex, 75mmL
2H3005	5mm Hex, 30mmL	2H7505	5mm Hex, 75mmL
2H3006	6mm Hex, 30mmL	2H7506	6mm Hex, 75mmL
2H3007	7mm Hex, 30mmL	2H7507	7mm Hex, 75mmL
2H3008	8mm Hex, 30mmL	2H7508	8mm Hex, 75mmL
2H3010	10mm Hex, 30mmL	2H7510	10mm Hex, 75mmL
2H3012	12mm Hex, 30mmL	2H7512	12mm Hex, 75mmL
2M3005	M5, 30mmL	2M7505	M5, 75mmL
2M3006	M6, 30mmL	2M7506	M6, 75mmL
2M3008	M8, 30mmL	2M7508	M8, 75mmL
2M3010	M10, 30mmL	2M7510	M10, 75mmL
2M3012	M12, 30mmL	2M7512	M12, 75mmL
2T3020	T-20 Star, 30mmL	2T7520	T-20 Star, 75mmL
2T3025	T-25 Star, 30mmL	2T7525	T-25 Star, 75mmL
2T3030	T-30 Star, 30mmL	2T7530	T-30 Star, 75mmL
2T3040	T-40 Star, 30mmL	2T7540	T-40 Star, 75mmL
2T3045	T-45 Star, 30mmL	2T7545	T-45 Star, 75mmL
2T3050	T-50 Star, 30mmL	2T7550	T-50 Star, 75mmL
2T3055	T-55 Star, 30mmL	2T7555	T-55 Star, 75mmL

**Accessory:**  
 323910 3/8" Dr. 10mm Hex Shank Bit Holder  
 424110 1/2" Dr. 10mm Hex Shank Bit Holder  
 Metal Box



2150 g 10 sets / 24 Kgs / 1.14 CUFT

## TX-23440 40 Piece 1/2", 3/8" Dr. & 1/2" Dr. Star Type Component Set

Item No.	Size	Item No.	Size
<b>E-Star Hand Socket:</b>			
252504	1/4" Dr. E-4	353512	3/8" Dr. E-12
252505	1/4" Dr. E-5	353514	3/8" Dr. E-14
252506	1/4" Dr. E-6	353516	3/8" Dr. E-16
252507	1/4" Dr. E-7	353518	3/8" Dr. E-18
252508	1/4" Dr. E-8	353520	3/8" Dr. E-20
353510	3/8" Dr. E-10		
<b>Star Key Wrench:</b>			
580509	T-9	580840	T-40
580510	T-10	580845	T-45
580615	T-15	580950	T-50
580620	T-20	581055	T-55
580625	T-25	581260	T-60
580627	T-27	581470	T-70
580730	T-30		
<b>1/4" Hex Shank Star Screwdriver Bit:</b>			
6109	T-9, 30mmL	6115	T-15, 30mmL
6110	T-10, 30mmL	6120	T-20, 30mmL
<b>10mm Hex Shank Star Screwdriver Bit:</b>			
2T3025	T-25, 30mmL	2T3040	T-40, 30mmL
2T3027	T-27, 30mmL	2T3045	T-45, 30mmL
2T3030	T-30, 30mmL	2T3050	T-50, 30mmL
<b>14 mm Hex Shank Star Screwdriver Bit:</b>			
2T11555	T-55, 115mmL	2T7570	T-70, 75mmL
2T7560	T-60, 75mmL		

**Accessory:**  
 282408 1/4" Dr. 1/4" Hex Shank Bit Holder  
 323910 3/8" Dr. 10mm Hex Shank Bit Holder  
 424514 1/2" Dr. 14mm Hex Shank Bit Holder  
 Metal Box



2750 g 6 sets / 17.5 Kgs / 0.72 CUFT



# Screwdriver Bit Sets

## SC-243 43 Piece 1/4" Hex Shank Screwdriver Bit Set

Item No.	Size	Item No.	Size
<b>1/4" Hex Shank Screwdriver Bit, 30mmL:</b>			
1130	0.5 x 3.0mm	1100	#0 Philips
1140	0.6 x 4.0mm	1101	#1 Philips
1150	0.8 x 5.0mm	1102	#2 Philips
1155	0.8 x 5.5mm	1103	#3 Philips
1160	1.0 x 6.0mm	6108	T-8 Star
1170	1.2 x 7.0mm	6110	T-10 Star
3106	3/32" Hex	6115	T-15 Star
3108	1/8" Hex	6120	T-20 Star
3110	5/32" Hex	6125	T-25 Star
3112	3/16" Hex	6127	T-27 Star
3114	7/32" Hex	6130	T-30 Star
3116	1/4" Hex	6140	T-40 Star
<b>1/4" Hex Shank Power Screwdriver Bit, 50mmL:</b>			
205030	0.5 x 3.0mm	235002	#2 Philips
205040	0.6 x 4.0mm	235003	#3 Philips
205050	0.8 x 5.0mm	265020	2mm Hex
205055	0.8 x 5.5mm	265025	2.5mm Hex
205060	1.0 x 6.0mm	265030	3mm Hex
205070	1.2 x 7.0mm	265040	4mm Hex
235000	#0 Philips	265050	5mm Hex
235001	#1 Philips	265060	6mm Hex

### Accessory:

285608	1/4" Dr. 1/4" Hex Shank Bit Holder Adapter
280150	1/4" Hex Shank Bit Holder With Handle
383908	3/8" Dr. 1/4" Hex Shank Bit Holder
Blow Case	

700 g

20 sets / 15 Kgs / 1.5 CUFT



SC-243



SC-243A



## SC-233 33 Piece 5/16" Hex Shank Screwdriver Bit Set

Item No.	Size	Item No.	Size	Item No.	Size
<b>5/16" Hex Shank Screwdriver Bit, 30mmL:</b>					
2143	3mm Hex	3128	9/32" Hex		
2144	4mm Hex	3130	5/16" Hex		
2145	5mm Hex	6210	T-10 Star		
2146	6mm Hex	6215	T-15 Star		
2147	7mm Hex	6220	T-20 Star		
2148	8mm Hex	6225	T-25 Star		
3118	1/8" Hex	6227	T-27 Star		
3120	5/32" Hex	6230	T-30 Star		
3122	3/16" Hex	6240	T-40 Star		
3124	7/32" Hex	6245	T-45 Star		
3126	1/4" Hex	6250	T-50 Star		

### 5/16" Hex Shank Power Screwdriver Bit, 72mmL:

217250	0.8 x 5.0mm	247201	#1 Philips
217255	0.8 x 5.5mm	247202	#2 Philips
217260	1.0 x 6.0mm	247203	#3 Philips
217270	1.2 x 7.0mm	247204	#4 Philips

Item No.	Size
<b>Accessory:</b>	
383910	3/8" Dr. 5/16" Hex Shank Bit Holder
320075	3/8" Dr. Hand Extension Bar, 75mmL
380333R	3/8" Dr. 24T Reversible Ratchet
Metal Box	



1500 g

12 sets / 19 Kgs / 1.01 CUFT

Made of High Speed Tool Steel

# Screwdriver Bit Sets

## TX-246M 46 Piece Metric Extra Long Screwdriver Bit With OMNIDRIVE® Set

Item No.	Size	Item No.	Size
<b>Screwdriver Bit, 160mmL:</b>			
1740	0.6 x 4.0mm	6707	T-7 Star
1750	0.8 x 5.0mm	6708	T-8 Star
1760	1.0 x 6.0mm	6709	T-9 Star
1780	1.2 x 8.0mm	6710	T-10 Star
1701	#1 Philips	6715	T-15 Star
1702	#2 Philips	6720	T-20 Star
1703	#3 Philips	6725	T-25 Star
1704	#4 Philips	6727	T-27 Star
2725	2.5mm Hex	6730	T-30 Star
2733	3mm Hex	6740	T-40 Star
2734	4mm Hex	6745	T-45 Star
2735	5mm Hex	6750	T-50 Star
2736	6mm Hex	8704	M4 Triple Square
2747	7mm Hex	8705	M5 Triple Square
2748	8mm Hex	8706	M6 Triple Square
6706	T-6 Star	8708	M8 Triple Square

### 1/4" Dr. 6pt Hand Socket:

222504	4mm	222509	9mm
222505	5mm	222510	10mm
222506	6mm	222511	11mm
222507	7mm	222512	12mm
222508	8mm	222513	13mm

2500 g

4 sets / 11 Kgs / 1.07 CUFT

Item No.	Size
<b>Accessory:</b>	
280120	OMNIDRIVE® 3in1 Handgrip
272065	1/4" Dr. Spinner Handle, 65mmL
272140	1/4" Dr. Spinner Handle, 140mmL
280070	1/4" Dr. Universal Joint Blow Case



## TX-246S 46 Piece SAE Extra Long Screwdriver Bit With OMNIDRIVE® Set

Item No.	Size	Item No.	Size
<b>Screwdriver Bit, 160mmL:</b>			
1740	0.6 x 4.0mm	6707	T-7 Star
1750	0.8 x 5.0mm	6708	T-8 Star
1760	1.0 x 6.0mm	6709	T-9 Star
1780	1.2 x 8.0mm	6710	T-10 Star
1701	#1 Philips	6715	T-15 Star
1702	#2 Philips	6720	T-20 Star
1703	#3 Philips	6725	T-25 Star
1704	#4 Philips	6727	T-27 Star
3708	1/8" Hex	6730	T-30 Star
3710	5/32" Hex	6740	T-40 Star
3712	3/16" Hex	6745	T-45 Star
3714	7/32" Hex	6750	T-50 Star
3716	1/4" Hex	8704	M4 Triple Square
3718	9/32" Hex	8705	M5 Triple Square
3720	5/16" Hex	8706	M6 Triple Square
6706	T-6 Star	8708	M8 Triple Square

### 1/4" Dr. 6pt Hand Socket:

282504	1/8"	282510	5/16"
282506	3/16"	282511	11/32"
282507	7/32"	282512	3/8"
282508	1/4"	282514	7/16"
282509	9/32"	282516	1/2"

2500 g

4 sets / 11 Kgs / 1.07 CUFT

Item No.	Size
<b>Accessory:</b>	
280120	OMNIDRIVE® 3in1 Handgrip
272065	1/4" Dr. Spinner Handle, 65mmL
272140	1/4" Dr. Spinner Handle, 140mmL
280070	1/4" Dr. Universal Joint Blow Case



# Screwdriver Bit Sets

## SB-252M 52 Piece Metric Screwdriver Bit With OMNIDRIVE® Set

### Screwdriver Bit, 30mmL:

Item No.	Size
1130	0.5 x 3.0mm
1140	0.6 x 4.0mm
1150	0.8 x 5.0mm
1155	0.8 x 5.5mm
1160	1.0 x 6.0mm
1170	1.2 x 7.0mm
1100	#0 Philips
1101	#1 Philips
1102	#2 Philips
1103	#3 Philips
2122	2mm Hex
2125	2.5mm Hex
2133	3mm Hex
2134	4mm Hex
2135	5mm Hex
2136	6mm Hex

### 1/4" Dr. 6pt Hand Socket:

Item No.	Size
222503	3mm
222504	4mm
2225045	4.5mm
222505	5mm
2225055	5.5mm

### Item No. Size

263070	7mm Hex
263080	8mm Hex
6106	T-6 Star
6107	T-7 Star
6108	T-8 Star
6109	T-9 Star
6110	T-10 Star
6115	T-15 Star
6120	T-20 Star
6125	T-25 Star
6127	T-27 Star
6130	T-30 Star
6140	T-40 Star
8104	M4 Triple Square
8105	M5 Triple Square
8106	M6 Triple Square

### Item No. Size

#### Accessory:

280121X	OMNIDRIVE® 4in1 Handgrip
280002B	1/4" Dr. 1/4" Hex Drive Socket Holder Adapter
282150	1/4" F x 1/4" M Flexible Extension
282165	1/4" F x 1/4" M Flexible Bit Holder
0230	Magnetic Bit Holder, 150mmL
286008M	Magnetic Bit Holder Adapter
280060	Magnetic Bit Holder with Handle, 60mmL
220004	1/4" Dr. Extension Bar, 100mmL
220002B	1/4" Dr. Wobble Extension Bar, 50mmL
220006B	1/4" Dr. Wobble Extension Bar, 150mmL

Blow Case

1150 g

15 sets / 18.3 Kgs / 1.25 CUFT



6 pt.



## TH-41015 15 Piece 1/2" Dr. 10mm Hex Shank Hex Bit Set

### Item No. Size

#### 10mm Hex Shank Screwdriver Bit:

Item No.	Size	Item No.	Size
2H3004	4mm, 30mmL	2H7504	4mm, 75mmL
2H3005	5mm, 30mmL	2H7505	5mm, 75mmL
2H3006	6mm, 30mmL	2H7506	6mm, 75mmL
2H3007	7mm, 30mmL	2H7507	7mm, 75mmL
2H3008	8mm, 30mmL	2H7508	8mm, 75mmL
2H3010	10mm, 30mmL	2H7510	10mm, 75mmL
2H3012	12mm, 30mmL	2H7512	12mm, 75mmL

#### Accessory:

424110	1/2" Dr. 10mm Hex Shank Bit Holder Metal Box
--------	--

850 g

20 sets / 19 Kgs / 0.95 CUFT





# Screwdriver Bit Sets

## SB-276MS 76 Piece Metric & SAE Complete Bit With OMNIDRIVE® Set

Item No.	Size	Item No.	Size
<b>Screwdriver Bit, 30mmL:</b>			
1130	0.5 x 3.0mm	2122	2mm Hex
1140	0.6 x 4.0mm	2125	2.5mm Hex
1150	0.8 x 5.0mm	2133	3mm Hex
1155	0.8 x 5.5mm	2134	4mm Hex
1160	1.0 x 6.0mm	2135	5mm Hex
1170	1.2 x 7.0mm	2136	6mm Hex
1100	#0 Philips	263070	7mm Hex
1101	#1 Philips	263080	8mm Hex
1102	#2 Philips	3104	1/16" Hex
1103	#3 Philips	3105	5/64" Hex
6106	T-6 Star	3106	3/32" Hex
6107	T-7 Star	3107	7/64" Hex
6108	T-8 Star	3108	1/8" Hex
6109	T-9 Star	3110	5/32" Hex
6110	T-10 Star	3112	3/16" Hex
6115	T-15 Star	3114	7/32" Hex
6120	T-20 Star	3116	1/4" Hex
6125	T-25 Star	273009	9/32" Hex
6127	T-27 Star	273010	5/16" Hex
6130	T-30 Star	9100	#0 Square
6140	T-40 Star	9101	#1 Square
8104	M4 Triple Square	9102	#2 Square
8105	M5 Triple Square	9103	#3 Square
8106	M6 Triple Square	9104	#4 Square
<b>1/4" Dr. 6pt Hand Socket:</b>			
222503	3mm	222510	10mm
222504	4mm	282504	1/8"
2225045	4.5mm	282506	3/16"
222505	5mm	282507	7/32"
2225055	5.5mm	282508	1/4"
222506	6mm	282509	9/32"
222507	7mm	282510	5/16"
222508	8mm	282511	11/32"
222509	9mm	282512	3/8"

1500 g 10 sets / 16 Kgs / 1.16 CUFT

Item No.	Size
<b>Accessory:</b>	
280121X	OMNIDRIVE® 4in1 Handgrip
280002B	1/4" Dr. 1/4" Hex Drive Socket Holder Adapter
282150	1/4" F x 1/4" M Flexible Extension
282165	1/4" F x 1/4" M Flexible Bit Holder
0230	Magnetic Bit Holder, 150mmL
286008M	Magnetic Bit Holder Adapter
280060	Magnetic Bit Holder with Handle, 60mmL
220004	1/4" Dr. Extension Bar, 100mmL
220002B	1/4" Dr. Wobble Extension Bar, 50mmL
220006B	1/4" Dr. Wobble Extension Bar, 150mmL
	Blow Case



6 pt.



## TX-41015 15 Piece 1/2" Dr. 10mm Hex Shank Star Bit Set

Item No.	Size	Item No.	Size
<b>10mm Hex Shank Screwdriver Bit:</b>			
2T3020	T-20, 30mmL	2T7520	T-20, 75mmL
2T3025	T-25, 30mmL	2T7525	T-25, 75mmL
2T3030	T-30, 30mmL	2T7530	T-30, 75mmL
2T3040	T-40, 30mmL	2T7540	T-40, 75mmL
2T3045	T-45, 30mmL	2T7545	T-45, 75mmL
2T3050	T-50, 30mmL	2T7550	T-50, 75mmL
2T3055	T-55, 30mmL	2T7555	T-55, 75mmL

**Accessory:**  
424110 1/2" Dr. 10mm Hex Shank Bit Holder  
Metal Box

820 g 20 sets / 18.5 Kgs / 0.95 CUFT



# Screwdriver Bit Sets

## TX-23475M 75 Piece Metric Complete Screwdriver Bit Set

### Screwdriver Bit, 30mmL:

Item No.	Size
2122	2mm Hex
2125	2.5mm Hex
2133	3mm Hex
2134	4mm Hex
2135	5mm Hex
2136	6mm Hex
2147	7mm Hex
2148	8mm Hex
2149	9mm Hex
2150	10mm Hex
2151	11mm Hex
2152	12mm Hex
6106	T-6 Star
6107	T-7 Star
6108	T-8 Star
6109	T-9 Star
6110	T-10 Star

### Screwdriver Bit, 80mmL:

2522	2mm Hex
2525	2.5mm Hex
2533	3mm Hex
2534	4mm Hex
2535	5mm Hex
2536	6mm Hex
2547	7mm Hex
2548	8mm Hex
2549	9mm Hex
2550	10mm Hex
2551	11mm Hex
2552	12mm Hex
2553	13mm Hex
2554	14mm Hex
7507	T-7 Tamperproof Star
7508	T-8 Tamperproof Star
7509	T-9 Tamperproof Star
7510	T-10 Tamperproof Star

### Item No. Size

6115	T-15 Star
6120	T-20 Star
6125	T-25 Star
6127	T-27 Star
6130	T-30 Star
6140	T-40 Star
6245	T-45 Star
6250	T-50 Star
6255	T-55 Star
8104	M4 Triple Square
8105	M5 Triple Square
8106	M6 Triple Square
8108	M8 Triple Square
8110	M10 Triple Square
8112	M12 Triple Square
8114	M14 Triple Square

7515	T-15 Tamperproof Star
7520	T-20 Tamperproof Star
7525	T-25 Tamperproof Star
7527	T-27 Tamperproof Star
7530	T-30 Tamperproof Star
7540	T-40 Tamperproof Star
7545	T-45 Tamperproof Star
7550	T-50 Tamperproof Star
7555	T-55 Tamperproof Star
7560	T-60 Tamperproof Star
7570	T-70 Tamperproof Star
8504	M4 Triple Square
8505	M5 Triple Square
8506	M6 Triple Square
8508	M8 Triple Square
8510	M10 Triple Square
8512	M12 Triple Square
8514	M14 Triple Square

### Item No. Size

### Accessory:

283508	1/4" Dr. 1/4" Hex Shank Bit Holder
383910	3/8" Dr. 5/16" Hex Shank Bit Holder
484110	1/2" Dr. 5/16" Hex Shank Bit Holder
424110	1/2" Dr. 10mm Hex Shank Bit Holder
424312	1/2" Dr. 12mm Hex Shank Bit Holder
424514	1/2" Dr. 14mm Hex Shank Bit Holder

Blow Case



3000 g

5 sets / 16 Kgs / 1.21 CUFT

# Screwdriver Bit Sets

## TX-23478S 78 Piece SAE Complete Screwdriver Bit Set

Item No.	Size	Item No.	Size
<b>Screwdriver Bit, 30mmL:</b>			
3106	3/32" Hex	6115	T-15 Star
3107	7/64" Hex	6120	T-20 Star
3108	1/8" Hex	6125	T-25 Star
3110	5/32" Hex	6127	T-27 Star
3112	3/16" Hex	6130	T-30 Star
3114	7/32" Hex	6140	T-40 Star
3116	1/4" Hex	6245	T-45 Star
3128	9/32" Hex	6250	T-50 Star
3130	5/16" Hex	6255	T-55 Star
3134	3/8" Hex	8104	M4 Triple Square
3138	7/16" Hex	8105	M5 Triple Square
3142	1/2" Hex	8106	M6 Triple Square
6106	T-6 Star	8108	M8 Triple Square
6107	T-7 Star	8110	M10 Triple Square
6108	T-8 Star	8112	M12 Triple Square
6109	T-9 Star	8114	M14 Triple Square
6110	T-10 Star		
<b>Screwdriver Bit, 80mmL:</b>			
3504	1/16" Hex	7515	T-15 Tamperproof Star
3505	5/64" Hex	7520	T-20 Tamperproof Star
3506	3/32" Hex	7525	T-25 Tamperproof Star
3507	7/64" Hex	7527	T-27 Tamperproof Star
3508	1/8" Hex	7530	T-30 Tamperproof Star
3510	5/32" Hex	7540	T-40 Tamperproof Star
3512	3/16" Hex	7545	T-45 Tamperproof Star
3514	7/32" Hex	7550	T-50 Tamperproof Star
3516	1/4" Hex	7555	T-55 Tamperproof Star
3518	9/32" Hex	7560	T-60 Tamperproof Star
3520	5/16" Hex	7570	T-70 Tamperproof Star
3524	3/8" Hex	8504	M4 Triple Square
3528	7/16" Hex	8505	M5 Triple Square
3532	1/2" Hex	8506	M6 Triple Square
7507	13mm Hex	8508	M8 Triple Square
7508	14mm Hex	8510	M10 Triple Square
7509	T-9 Tamperproof Star	8512	M12 Triple Square
7510	T-10 Tamperproof Star	8514	M14 Triple Square

3300 g

5 sets / 17.5 Kgs / 1.21 CUFT

**Accessory:**  
 283508 1/4" Dr. 1/4" Hex Shank Bit Holder  
 383910 3/8" Dr. 5/16" Hex Shank Bit Holder  
 484110 1/2" Dr. 5/16" Hex Shank Bit Holder  
 424110 1/2" Dr. 10mm Hex Shank Bit Holder  
 424312 1/2" Dr. 12mm Hex Shank Bit Holder  
 424514 1/2" Dr. 14mm Hex Shank Bit Holder  
 Blow Case





Made of High Speed Tool Steel



# Impact Drivers

## Impact Drivers

Item No.	Drive	Length mm	Weight g	PCS 	G.W. KGS	CUFT 
700007	3/8"	135	580	12	9.0	0.30
700008	1/2"	135	700	12	9.5	0.30





### TG-406B 6 Piece 1/2" Dr. Impact Driver Set

Item No.	Size	Item No.	Size
<b>Screwdriver Bit, 36mmL:</b>			
700288	1.2 x 8.0mm	700292	#2 Philips
700290	1.6 x 10.0mm	700293	#3 Philips

#### Accessory:

700008	1/2" Dr. Impact Driver
464110	1/2" Dr. 5/16" Hex Shank Bit Holder
Metal Box	

 1070 g       20 sets / 22.5 Kgs / 0.64 CUFT





### ID-314 14 Piece 3/8" Dr. Impact Driver Set

Item No.	Size	Item No.	Size
<b>Screwdriver Bit:</b>			
1265	1.0 x 6.5mm, 30mmL	1122	#2 Philips, 30mmL
1280	1.2 x 8.0mm, 30mmL	1123	#3 Philips, 30mmL
1290	1.6 x 9.0mm, 30mmL	1124	#4 Philips, 30mmL
1470	1.2 x 7.0mm, 56mmL	1402	#2 Philips, 56mmL
1480	1.2 x 8.0mm, 56mmL	1403	#3 Philips, 56mmL
1490	1.6 x 9.0mm, 56mmL	1404	#4 Philips, 56mmL

#### Accessory:

700007	3/8" Dr. Impact Driver
363910	3/8" Dr. 5/16" Hex Shank Bit Holder
Blow Case	

 1250 g       15 sets / 20 Kgs / 0.95 CUFT





### ID-414 14 Piece 1/2" Dr. Impact Driver Set

Item No.	Size	Item No.	Size
<b>Screwdriver Bit:</b>			
1265	1.0 x 6.5mm, 30mmL	1122	#2 Philips, 30mmL
1280	1.2 x 8.0mm, 30mmL	1123	#3 Philips, 30mmL
1290	1.6 x 9.0mm, 30mmL	1124	#4 Philips, 30mmL
1470	1.2 x 7.0mm, 56mmL	1402	#2 Philips, 56mmL
1480	1.2 x 8.0mm, 56mmL	1403	#3 Philips, 56mmL
1490	1.6 x 9.0mm, 56mmL	1404	#4 Philips, 56mmL

#### Accessory:



700008	1/2" Dr. Impact Driver
464110	1/2" Dr. 5/16" Hex Handk Bit Holder
Blow Case	

 1250 g       15 sets / 20 Kgs / 0.95 CUFT



# Torque Screwdriver Sets

## 1/4" Dr. Torque Screwdrivers

ITEM NO.	Capacity	Length mm	Weight g	PCS 	G.W. KGS	CUFT 
280005N	1 ~ 5 Nm	150	360	12	5.5	0.30
280045L	9 ~ 50 in. lbs.	150	360	12	5.5	0.30



## TO-227N 27 Piece Nm Torque Screwdriver Set

Item No.	Size	Item No.	Size
<b>Screwdriver Bit, 30mmL:</b>			
1160	1.0 x 6.0mm Slotted	2133	3mm Hex
1165	1.0 x 6.5mm Slotted	2134	4mm Hex
1170	1.2 x 7.0mm Slotted	2135	5mm Hex
1101	#1 Philips	2136	6mm Hex
1102	#2 Philips	3108	1/8" Hex
1103	#3 Philips	3110	5/32" Hex
7110	T-10 Tamperproof Star	3112	3/16" Hex
7115	T-15 Tamperproof Star	3114	7/32" Hex
7120	T-20 Tamperproof Star	3116	1/4" Hex
7125	T-25 Tamperproof Star	8104	M4 Triple Square
7127	T-27 Tamperproof Star	8105	M5 Triple Square
7130	T-30 Tamperproof Star	8106	M6 Triple Square
7140	T-40 Tamperproof Star		

### Accessory:

280005N 1/4" Dr. Torque Screwdriver, 1~5 Nm

283508 1/4" Dr. 1/4" Hex Shank Bit Holder

Blow Case

 750 g

 15 sets / 12.5 Kgs / 0.95 CUFT



TO-227N (TO-227L)

## TO-227L 27 Piece Lbf inch Torque Screwdriver Set

Item No.	Size	Item No.	Size
<b>Screwdriver Bit, 30mmL:</b>			
1160	1.0 x 6.0mm Slotted	2133	3mm Hex
1165	1.0 x 6.5mm Slotted	2134	4mm Hex
1170	1.2 x 7.0mm Slotted	2135	5mm Hex
1101	#1 Philips	2136	6mm Hex
1102	#2 Philips	3108	1/8" Hex
1103	#3 Philips	3110	5/32" Hex
7110	T-10 Tamperproof Star	3112	3/16" Hex
7115	T-15 Tamperproof Star	3114	7/32" Hex
7120	T-20 Tamperproof Star	3116	1/4" Hex
7125	T-25 Tamperproof Star	8104	M4 Triple Square
7127	T-27 Tamperproof Star	8105	M5 Triple Square
7130	T-30 Tamperproof Star	8106	M6 Triple Square
7140	T-40 Tamperproof Star		

### Accessory:

280045L 1/4" Dr. Torque Screwdriver, 9~50 in. lbs.

283508 1/4" Dr. 1/4" Hex Shank Bit Holder

Blow Case

 750 g

 15 sets / 12.5 Kgs / 0.95 CUFT



# Screwdrivers

## Slotted Screwdrivers

Item No.	Size mm	L1 mm	L2 mm	Length mm	Shank Type	Weight g	PCS inner/ctn	G.W. KGS	CUFT
504+0430	0.5 x 3.0	75	80	155	D	40	30 / 240	10.0	1.60
504+0440	0.8 x 4.0	100	80	180	D	40	60 / 240	10.0	1.60
504+1240	0.8 x 4.0	100	80	180	H	40	60 / 240	11.0	1.60
504+0550	0.8 x 5.0	250	80	330	D	70	60 / 240	18.0	1.94
506+1455	1.0 x 5.5	100	100	200	H	80	50 / 200	16.5	1.96
506+0560	1.0 x 6.0	150	100	250	D	95	50 / 200	20.0	1.96
506+1965	1.2 x 6.5	100	100	200	H	95	50 / 200	20.0	1.96
506+1966	1.2 x 6.5	150	100	250	H	110	40 / 160	18.5	1.96
506+0680	1.2 x 8.0	200	100	300	D	150	40 / 160	25.0	1.96
506+1980	1.2 x 8.0	180	100	280	H	150	40 / 160	25.5	1.96
508+1990	1.6 x 10.0	200	120	320	H	260	25 / 100	27.0	1.96
508+0890	1.6 x 10.0	250	120	370	D	270	10 / 60	17.0	2.06
508+1992	2.0 x 12.0	200	120	320	H	340	10 / 60	21.5	2.06
508+1994	2.5 x 14.0	250	120	370	H	400	10 / 60	25.0	2.06
502+1465	1.2 x 6.5	38	60	98	H	50	50 / 200	10.5	1.39

"D" for round shank, "H" for hex shank



## Philips Screwdrivers

Item No.	Size	L1 mm	L2 mm	Length mm	Shank Type	Weight g	PCS inner/ctn	G.W. KGS	CUFT
504+0400	#0	75	80	155	D	40	30 / 240	10.0	1.60
504+1401	#1	90	80	170	H	50	60 / 240	13.0	1.60
504+1421	#1	120	80	200	H	55	60 / 240	14.0	1.60
504+0531	#1	250	80	330	D	70	60 / 240	18.0	1.94
506+0602	#2	75	100	175	D	80	50 / 200	17.0	1.94
506+1712	#2	100	100	200	H	95	50 / 200	20.0	1.96
506+1802	#2	125	100	225	H	100	50 / 200	21.5	1.96
506+0612	#2	150	100	250	D	100	40 / 160	16.5	1.96
506+1902	#2	200	100	300	H	120	40 / 160	21.0	1.96
506+0632	#2	300	100	400	D	130	40 / 160	22.0	2.48
508+1913	#3	125	120	245	H	160	25 / 100	17.0	1.96
508+1843	#3	150	120	270	H	170	25 / 100	18.0	1.96
508+1923	#3	200	120	320	H	190	25 / 100	20.0	1.96
508+0833	#3	270	120	390	D	210	25 / 100	22.0	2.48
508+1924	#4	200	120	320	H	260	10 / 60	16.5	2.06
502+1201	#1	38	60	98	H	45	50 / 200	10.0	1.39
502+1202	#2	38	60	98	H	50	50 / 200	11.0	1.39

"D" for round shank, "H" for hex shank



## Posidriv Screwdrivers

Item No.	Size	L1 mm	L2 mm	Length mm	Shank Type	Weight g	PCS inner/ctn	G.W. KGS	CUFT
504+0450	#0	75	80	155	D	35	30 / 240	9.5	1.60
504+1741	#1	75	80	155	H	45	30 / 240	12.0	1.60
504+1841	#1	100	80	180	H	40	60 / 240	10.5	1.60
504+1951	#1	125	80	205	H	55	60 / 240	14.0	1.60
504+0561	#1	150	80	230	D	55	60 / 240	14.5	1.60
504+1971	#1	250	80	330	H	75	60 / 240	19.0	1.94
506+1842	#2	100	100	200	H	95	50 / 200	20.0	1.96
506+1952	#2	150	100	250	H	110	40 / 160	18.5	1.96
506+0662	#2	200	100	300	D	110	40 / 160	18.5	1.96
506+1972	#2	300	100	400	H	150	40 / 160	25.0	2.48
508+1943	#3	175	120	295	H	180	25 / 100	19.0	1.96
508+1974	#4	220	120	340	H	280	10 / 60	17.5	2.06
502+0501	#1	38	60	98	D	45	50 / 200	10.0	1.39
502+0502	#2	38	60	98	D	45	50 / 200	10.0	1.39

"D" for round shank, "H" for hex shank



## Star Screwdrivers

Item No.	Size	L1 mm	L2 mm	Length mm	Weight g	PCS		G.W. KGS	CUFT 
						inner/ctn			
504+6606	T-6	70	80	150	55	40 / 320	18.5	1.60	
504+6607	T-7	70	80	150	55	40 / 320	18.5	1.60	
504+6608	T-8	70	80	150	55	40 / 320	18.5	1.60	
504+6609	T-9	70	80	150	55	40 / 320	18.5	1.60	
506+6710	T-10	85	100	185	90	40 / 160	15.0	1.60	
506+6715	T-15	85	100	185	90	40 / 160	15.5	1.60	
506+6720	T-20	85	100	185	90	40 / 160	15.5	1.60	
506+6725	T-25	85	100	185	90	40 / 160	15.5	1.60	
506+6827	T-27	125	100	225	100	40 / 160	17.5	1.96	
506+6830	T-30	125	100	225	100	40 / 160	17.5	1.96	
508+6840	T-40	115	120	235	130	30 / 120	16.5	1.96	
508+6845	T-45	115	120	235	150	30 / 120	19.5	1.96	
508+6850	T-50	115	120	235	160	30 / 120	20.0	1.96	



## Tamperproof Star Screwdrivers

Item No.	Size	L1 mm	L2 mm	Length mm	Weight g	PCS		G.W. KGS	CUFT 
						inner/ctn			
504+7606	T-6	70	80	150	40	40 / 320	13.0	1.60	
504+7607	T-7	70	80	150	40	40 / 320	13.0	1.60	
504+7608	T-8	70	80	150	40	40 / 320	13.0	1.60	
504+7609	T-9	70	80	150	40	40 / 320	13.0	1.60	
506+7710	T-10	80	100	180	75	40 / 160	13.0	1.60	
506+7715	T-15	80	100	180	75	40 / 160	13.0	1.60	
506+7920	T-20	100	100	200	100	40 / 160	16.5	1.60	
506+7925	T-25	100	100	200	100	40 / 160	16.5	1.60	
506+7827	T-27	125	100	225	100	40 / 160	17.5	1.96	
506+7830	T-30	125	100	225	100	40 / 160	17.5	1.96	
508+7940	T-40	135	120	255	130	30 / 120	17.0	1.97	
508+7945	T-45	135	120	255	170	30 / 120	21.0	1.97	
508+7850	T-50	115	120	235	160	30 / 120	20.0	1.96	



## Square Screwdrivers

Item No.	Size	L1 mm	L2 mm	Length mm	Weight g	PCS		G.W. KGS	CUFT 
						inner/ctn			
506+9800	#0	125	100	225	100	40 / 160	17.5	1.96	
506+9801	#1	125	100	225	100	40 / 160	17.5	1.96	
508+9802	#2	125	120	245	120	30 / 120	16.0	1.96	
508+9803	#3	125	120	245	120	30 / 120	16.0	1.96	
508+9804	#4	125	120	245	130	30 / 120	16.5	1.96	



# Screwdrivers

## Metric Hex Screwdrivers

Item No.	Size mm	L1 mm	L2 mm	Length mm	Weight g	PCS inner/ctn	G.W. KGS	CUFT
504+2622	2	70	80	150	50	40 / 320	18.0	1.60
504+2625	2.5	70	80	150	50	40 / 320	18.0	1.60
504+2633	3	70	80	150	50	40 / 320	18.0	1.60
506+2634	4	70	100	170	80	25 / 200	17.0	1.80
506+2735	5	85	100	185	90	25 / 200	19.5	1.80
506+2736	6	85	100	185	90	25 / 200	19.5	1.80
508+2847	7	115	120	235	150	30 / 120	19.5	1.96
508+2848	8	115	120	235	160	30 / 120	20.0	1.96
508+2849	9	115	120	235	180	30 / 120	23.0	1.96
508+2850	10	115	120	235	210	30 / 120	26.0	1.96

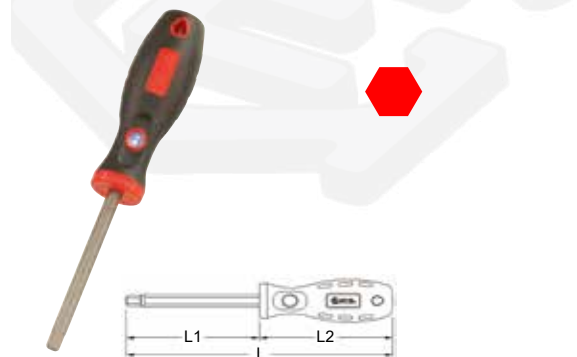

## SAE Hex Screwdrivers

Item No.	Size inch	L1 mm	L2 mm	Length mm	Weight g	PCS inner/ctn	G.W. KGS	CUFT
504+3604	1/16	70	80	150	50	40 / 320	18.0	1.60
504+3605	5/64	70	80	150	50	40 / 320	18.0	1.60
504+3606	3/32	70	80	150	50	40 / 320	18.0	1.60
504+3607	7/64	70	80	150	50	40 / 320	18.0	1.60
504+3608	1/8	70	80	150	55	40 / 320	18.5	1.60
506+3610	5/32	70	100	170	80	25 / 200	17.0	1.80
506+3712	3/16	85	100	185	90	25 / 200	19.5	1.80
506+3714	7/32	85	100	185	90	25 / 200	19.5	1.80
506+3816	1/4	125	100	225	100	40 / 160	17.5	1.60
508+3818	9/32	115	120	235	160	30 / 120	20.0	1.96
508+3820	5/16	115	120	235	160	30 / 120	20.0	1.96
508+3824	3/8	115	120	235	200	30 / 120	25.0	1.96



## Metric Wobble Hex Screwdrivers

Item No.	Size mm	L1 mm	L2 mm	Length mm	Weight g	PCS inner/ctn	G.W. KGS	CUFT
504+4633	3	70	80	150	50	40 / 320	18.0	1.60
506+4634	4	70	100	170	80	25 / 200	17.0	1.80
506+4735	5	85	100	185	90	25 / 200	19.0	1.80
506+4736	6	85	100	185	90	25 / 200	19.5	1.80
508+4847	7	115	120	235	170	30 / 120	21.0	1.96
508+4848	8	115	120	235	160	30 / 120	20.0	1.96
508+4849	9	115	120	235	180	30 / 120	23.0	1.96
508+4850	10	115	120	235	200	30 / 120	25.5	1.96

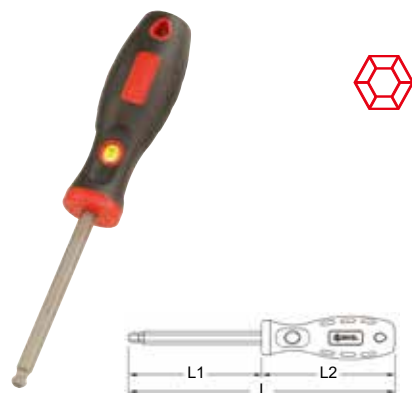

## SAE Wobble Hex Screwdrivers

Item No.	Size inch	L1 mm	L2 mm	Length mm	Weight g	PCS inner/ctn	G.W. KGS	CUFT
504+5608	1/8	70	80	150	50	40 / 320	18.5	1.60
506+5610	5/32	70	100	170	80	25 / 200	17.0	1.80
506+5712	3/16	85	100	185	90	25 / 200	19.0	1.80
506+5714	7/32	85	100	185	90	25 / 200	19.5	1.80
506+5816	1/4	125	100	225	100	40 / 160	17.5	1.60
508+5818	9/32	115	120	235	150	30 / 120	19.0	1.96
508+5820	5/16	115	120	235	160	30 / 120	20.0	1.96
508+5824	3/8	115	120	235	200	30 / 120	25.0	1.96

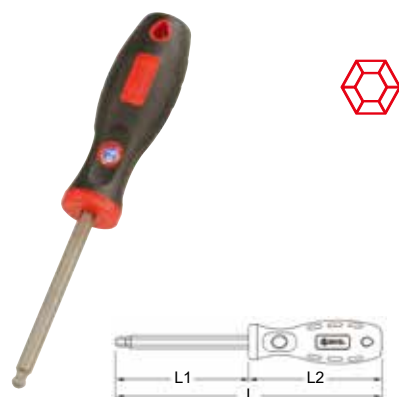

Screwdrivers



# Tang-Thru Screwdrivers

## Slotted Tang-Thru Screwdrivers

Item No.	Size mm	L1 mm	L2 mm	Length mm	Weight g	PCS inner/ctn	G.W. KGS	CUFT 
509+1966	1.2 x 6.5	125	120	245	160	25 / 100	17.0	1.96
509+1990	1.6 x 10.0	185	120	305	280	10 / 60	18.0	2.06
509+1992	2.0 x 12.0	195	120	315	370	10 / 60	23.5	2.06
509+1994	2.5 x 14.0	245	120	365	410	10 / 60	23.5	2.06

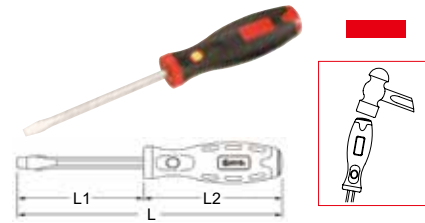

## Philips Tang-Thru Screwdrivers

Item No.	Size	L1 mm	L2 mm	Length mm	Weight g	PCS inner/ctn	G.W. KGS	CUFT 
509+1801	#1	100	120	220	160	25 / 100	17.0	1.96
509+1812	#2	125	120	245	170	25 / 100	18.0	1.96
509+1843	#3	135	120	255	200	25 / 100	21.0	1.96
509+1924	#4	185	120	305	290	10 / 60	18.5	2.06

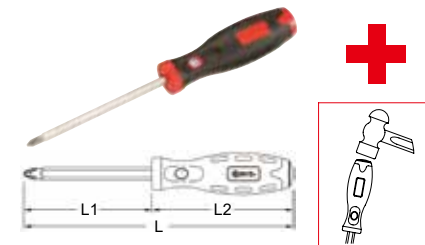

## Posidriv Tang-Thru Screwdrivers

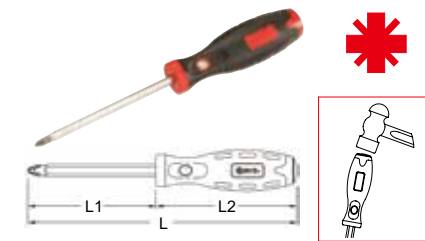

Item No.	Size	L1 mm	L2 mm	Length mm	Weight g	PCS inner/ctn	G.W. KGS	CUFT 
509+1951	#1	100	120	220	140	25 / 100	15.0	1.96
509+1952	#2	125	120	245	170	25 / 100	18.0	1.96
509+1943	#3	160	120	280	210	25 / 100	22.0	1.96
509+1974	#4	210	120	330	300	10 / 60	19.0	2.06



## TT-508SP 8 Piece Slotted & Philips Tang-Thru Screwdriver Set

Item No.	Size	Item No.	Size
509+1966	1.2 x 6.5mm, 245mmL	509+1801	#1 Philips, 220mmL
509+1990	1.6 x 10.0mm, 305mmL	509+1812	#2 Philips, 245mmL
509+1992	2.0 x 12.0mm, 315mmL	509+1843	#3 Philips, 255mmL
509+1994	2.5 x 14.0mm, 365mmL	509+1924	#4 Philips, 305mmL

Blow Case

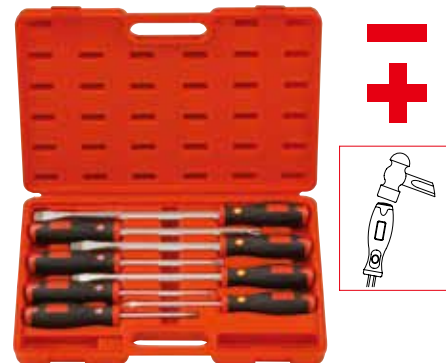

 2850 g       4 sets / 12.5 Kgs / 1.07 CUFT



## TT-512PZ 12 Piece Combination Tang-Thru Screwdriver Set

Item No.	Size	Item No.	Size
509+1966	1.2 x 6.5mm, 245mmL	509+1843	#3 Philips, 255mmL
509+1990	1.6 x 10.0mm, 305mmL	509+1924	#4 Philips, 305mmL
509+1992	2.0 x 12.0mm, 315mmL	509+1951	#1 Posidriv, 220mmL
509+1994	2.5 x 14.0mm, 365mmL	509+1952	#2 Posidriv, 245mmL
509+1801	#1 Philips, 220mmL	509+1943	#3 Posidriv, 270mmL
509+1812	#2 Philips, 245mmL	509+1974	#4 Posidriv, 320mmL

Blow Case

 3750 g       4 sets / 16 Kgs / 1.65 CUFT



# Screwdriver Sets

## TR-513ST 13 Piece Star Screwdriver Set

Item No.	Size	Item No.	Size
<b>Star Screwdriver w/Rubber Handle:</b>			
504+6606	T-6, 150mmL	506+6725	T-25, 185mmL
504+6607	T-7, 150mmL	506+6827	T-27, 225mmL
504+6608	T-8, 150mmL	506+6830	T-30, 225mmL
504+6609	T-9, 150mmL	508+6840	T-40, 235mmL
506+6710	T-10, 185mmL	508+6845	T-45, 235mmL
506+6715	T-15, 185mmL	508+6850	T-50, 235mmL
506+6720	T-20, 185mmL		Blow Case
🏺 2250 g	📦 4 sets / 10 Kgs / 1.65 CUFT		



## TR-520PZ 20 Piece Combination Screwdriver Set

Item No.	Size	Item No.	Size
<b>Screwdriver w/Rubber Handle:</b>			
504+0430	0.5 x 3.0mm, 155mmL	506+0602	#2 Philips, 175mmL
504+1240	0.8 x 4.0mm, 180mmL	506+0612	#2 Philips, 250mmL
506+0560	1.0 x 6.0mm, 250mmL	508+1843	#3 Philips, 270mmL
502+1465	1.2 x 6.5mm, 98mmL	504+0450	#0 Posidriv, 155mmL
506+1966	1.2 x 6.5mm, 250mmL	502+0501	#1 Posidriv, 98mmL
508+1990	1.6 x 10.0mm, 320mmL	504+1841	#1 Posidriv, 180mmL
504+0400	#0 Philips, 155mmL	504+0561	#1 Posidriv, 230mmL
502+1201	#1 Philips, 98mmL	506+1842	#2 Posidriv, 200mmL
504+1421	#1 Philips, 200mmL	506+0662	#2 Posidriv, 300mmL
504+0531	#1 Philips, 330mmL	508+1943	#3 Posidriv, 295mmL
Blow Case			
🏺 2600 g	📦 4 sets / 11.5 Kgs / 1.65 CUFT		



## TR-507S 7 Piece Slotted & Philips Screwdriver Set

Item No.	Size	Item No.	Size
<b>Screwdriver w/Rubber Handle:</b>			
504+0430	0.5 x 3.0mm, 155mmL	504+0400	#0 Philips, 155mmL
504+1240	0.8 x 4.0mm, 180mmL	504+1421	#1 Philips, 200mmL
506+0560	1.0 x 6.0mm, 250mmL	506+1802	#2 Philips, 225mmL
506+1966	1.2 x 6.5mm, 250mmL		Plastic Tray
🏺 1000 g	📦 5 sets / 6 Kgs / 0.93 CUFT		



(192W x 406D)

## TR-507S1 7 Piece Slotted & Philips Screwdriver Set

Item No.	Size	Item No.	Size
<b>Screwdriver w/Rubber Handle:</b>			
504+1240	0.8 x 4.0mm, 180mmL	504+0400	#0 Philips, 155mmL
506+1455	1.0 x 5.5mm, 200mmL	504+1401	#1 Philips, 170mmL
506+1966	1.2 x 6.5mm, 250mmL	506+1802	#2 Philips, 225mmL
506+1980	1.2 x 8.0mm, 280mmL		Plastic Tray
🏺 1000 g	📦 5 sets / 6 Kgs / 0.93 CUFT		



(192W x 406D)

## TR-508Z 8 Piece Combination Screwdriver Set

Item No.	Size	Item No.	Size
<b>Screwdriver w/Rubber Handle:</b>			
506+1455	1.0 x 5.5mm, 200mmL	504+1421	#1 Philips, 200mmL
506+1966	1.2 x 6.5mm, 250mmL	506+1802	#2 Philips, 225mmL
506+1980	1.2 x 8.0mm, 280mmL	504+1841	#1 Posidriv, 180mmL
508+1990	1.6 x 10.0mm, 320mmL	506+1952	#2 Posidriv, 250mmL
Plastic Tray			
🏺 1350 g	📦 10 sets / 14.5 Kgs / 1.58 CUFT		



(192W x 406D)

# Screwdriver Sets

## HR-5608M 8 Piece Metric Hex Screwdriver Set

Item No.	Size	Item No.	Size
<b>Hex Screwdriver w/Rubber Handle:</b>			
504+2622	2mm, 150mmL	506+2735	5mm, 185mmL
504+2625	2.5mm, 150mmL	506+2736	6mm, 185mmL
504+2633	3mm, 150mmL	508+2847	7mm, 235mmL
506+2634	4mm, 150mmL	508+2848	8mm, 235mmL

Plastic Tray

1300 g

10 sets / 14 Kgs / 1.58 CUFT

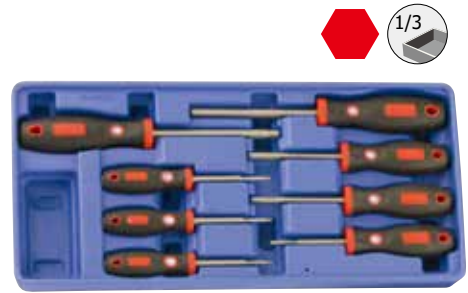

(192W x 406D)



## HR-5611S 11 Piece SAE Hex Screwdriver Set

Item No.	Size	Item No.	Size
<b>Hex Screwdriver w/Rubber Handle:</b>			
504+3604	1/16", 150mmL	506+3712	3/16", 185mmL
504+3605	5/64", 150mmL	506+3714	7/32", 185mmL
504+3606	3/32", 150mmL	506+3816	1/4", 225mmL
504+3607	7/64", 150mmL	508+3818	9/32", 235mmL
504+3608	1/8", 150mmL	508+3820	5/16", 235mmL
506+3610	5/32", 170mmL		Plastic Tray

1500 g

10 sets / 16 Kgs / 1.58 CUFT

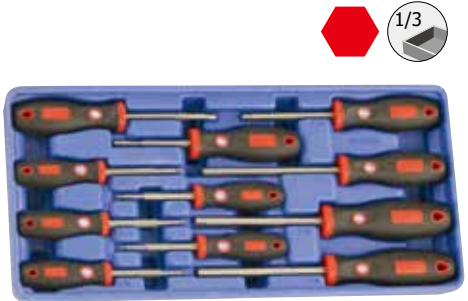

(192W x 406D)



## HR-578MW 8 Piece Metric Wobble Hex Screwdriver Set

Item No.	Size	Item No.	Size
<b>Wobble Hex Screwdriver w/Rubber Handle:</b>			
504+4633	3mm, 150mmL	508+4847	7mm, 235mmL
506+4634	4mm, 170mmL	508+4848	8mm, 235mmL
506+4735	5mm, 185mmL	508+4849	9mm, 235mmL
506+4736	6mm, 185mmL	508+4850	10mm, 235mmL

Plastic Tray

1550 g

10 sets / 16.5 Kgs / 1.58 CUFT

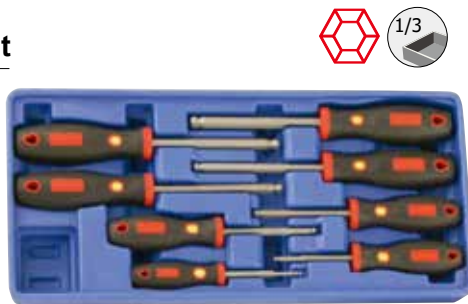

(192W x 406D)



## HR-578SW 8 Piece SAE Wobble Hex Screwdriver Set

Item No.	Size	Item No.	Size
<b>Wobble Hex Screwdriver w/Rubber Handle:</b>			
504+5608	1/8", 150mmL	506+5816	1/4", 225mmL
506+5610	5/32", 170mmL	508+5818	9/32", 235mmL
506+5712	3/16", 185mmL	508+5820	5/16", 235mmL
506+5714	7/32", 185mmL	508+5824	3/8", 235mmL

Plastic Tray

1450 g

10 sets / 15.5 Kgs / 1.58 CUFT

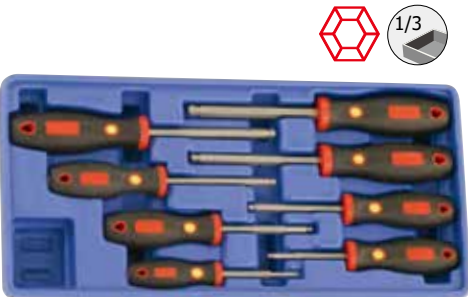

(192W x 406D)



## TR-510TA 10 Piece Tamperproof Star Screwdriver Set

Item No.	Size	Item No.	Size
<b>Tamperproof Star Screwdriver w/Rubber Handle:</b>			
504+7608	T-8, 150mmL	506+7827	T-27, 225mmL
506+7710	T-10, 180mmL	506+7830	T-30, 225mmL
506+7715	T-15, 180mmL	508+7940	T-40, 255mmL
506+7920	T-20, 200mmL	508+7945	T-45, 255mmL
506+7925	T-25, 200mmL	508+7850	T-50, 235mmL

Plastic Tray

1500 g

10 sets / 16 Kgs / 1.58 CUFT

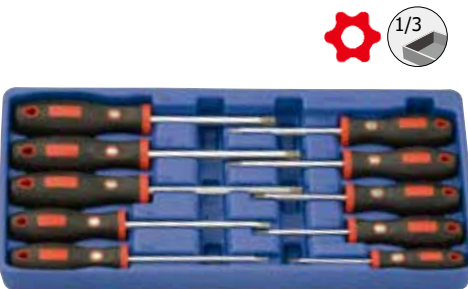

(192W x 406D)



# Screwdriver Sets

## MS-013 13 Piece Tang-Thru Screwdriver, Pry Bar & Carbon Scraper Set

Item No.	Size	Item No.	Size
<b>Tang-Thru Screwdriver w/Rubber Handle:</b>			
509+1966	1.2 x 6.5mm, 245mmL	509+1951	#1 Posidriv, 220mmL
509+1994	2.5 x 14.0mm, 365mmL	509+1952	#2 Posidriv, 245mmL
509+1801	#1 Philips, 220mmL	509+1943	#3 Posidriv, 270mmL
509+1924	#4 Philips, 305mmL	509+1974	#4 Posidriv, 320mmL
<b>Rigid Carbon Scraper w/Plastic Handle:</b>			
595212	12mm, 250mmL	595232	26mm, 300mmL
595226	26mm, 200mmL		
<b>Pry Bar w/Plastic Handle:</b>			
560008	200mmL(8"L)	560012	300mmL(12"L)
Plastic Tray			

2950 g

3 sets / 10 Kgs / 1.35 CUFT

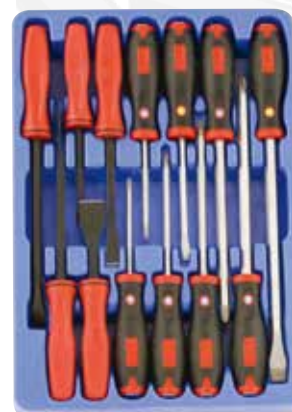

(285W x 410D x 50H)



## MS-013SP 13 Piece Slotted & Philips Screwdriver Set

Item No.	Size	Item No.	Size
<b>Screwdriver w/Rubber Handle:</b>			
504+0430	0.5 x 3.0mm, 155mmL	506+0680	1.2 x 8.0mm, 300mmL
504+1240	0.8 x 4.0mm, 180mmL	504+0400	#0 Philips, 155mmL
504+0550	0.8 x 5.0mm, 330mmL	504+1401	#1 Philips, 170mmL
506+0560	1.0 x 6.0mm, 250mmL	502+1202	#2 Philips, 98mmL
502+1465	1.2 x 6.5mm, 98mmL	506+1712	#2 Philips, 200mmL
506+1966	1.2 x 6.5mm, 200mmL	508+1843	#3 Philips, 270mmL
<b>Pry Bar w/Plastic Handle:</b>			
560012	300mmL(12"L)		Plastic Tray

1500 g

3 sets / 6.3 Kgs / 1.35 CUFT



(285W x 410D x 50H)



## MS-025R 25 Piece Hex Screwdriver & Ratcheting Screwdriver Set

Item No.	Size	Item No.	Size
<b>Hex Screwdriver w/Rubber Handle:</b>			
504+2622	2mm, 150mmL	506+2735	5mm, 185mmL
504+2625	2.5mm, 150mmL	506+2736	6mm, 185mmL
504+2633	3mm, 150mmL	508+2847	7mm, 235mmL
506+2634	4mm, 170mmL	508+2848	8mm, 235mmL
<b>1/4" Hex Shank Hex Nut Driver. 140mmL:</b>			
0444	4mm	0459	9mm
0445	5mm	0460	10mm
0455	5.5mm	0461	11mm
0456	6mm	0462	12mm
0457	7mm	0463	13mm
0458	8mm		

### Accessory:

285708M	1/4" Hex Dr. 1/4" Hex Shank Magnetic Bit Holder Adapter w/Quick Release
0260	1/4" Hex Dr. 1/4" Hex Shank Flexible Bit Holder
280002B	1/4" Hex Dr. 1/4" Hex Shank Socket Holder Adapter
272065	1/4" Hex Dr. 1/4" Hex Shank Spinner Handle
524+2983	1/4" Hex Shank Standard Ratcheting Screwdriver
520+2983	1/4" Hex Shank T-Handle Ratcheting Screwdriver
Plastic Tray	

2000 g

3 sets / 7.8 Kgs / 1.35 CUFT



(285W x 410D x 50H)



# Insulated Screwdrivers & Screwdriver Sets

## Insulated Slotted Screwdrivers

Item No.	Size mm	L1 mm	L2 mm	Length mm	Weight g	PCS	G.W.	CUFT
						inner/ctn	KGS	
586225	0.4 x 2.5	75	90	165	38	12 / 144	7.0	1.1
586230	0.5 x 3.0	80	90	170	40	12 / 144	7.5	1.1
586240	0.8 x 4.0	100	110	210	67	12 / 144	11.5	1.7
586255	1.0 x 5.5	125	120	245	107	12 / 144	17.0	2.2
586265	1.2 x 6.5	150	120	270	130	12 / 72	11.0	1.3
586280	1.6 x 8.0	175	130	305	192	12 / 72	15.5	1.7

**NEW**

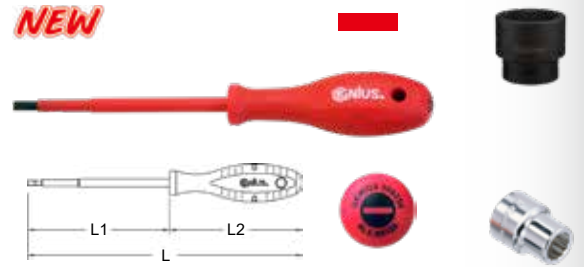

## Insulated Philips Screwdrivers

Item No.	Size	L1 mm	L2 mm	Length mm	Weight g	PCS	G.W.	CUFT
						inner/ctn	KGS	
584200	#0	60	90	150	40	12 / 144	7.5	1.1
584201	#1	80	110	190	70	12 / 144	11.5	1.6
584202	#2	100	120	220	110	12 / 144	17.5	2.2
584203	#3	150	130	280	185	12 / 72	15.0	1.6

**NEW**





## Insulated Posidriv Screwdrivers

Item No.	Size	L1 mm	L2 mm	Length mm	Weight g	PCS	G.W.	CUFT
						inner/ctn	KGS	
585200	#0	60	90	150	40	12 / 144	7.5	1.1
585201	#1	80	110	190	70	12 / 144	11.5	1.6
585202	#2	100	120	220	110	12 / 144	17.5	2.2
585203	#3	150	130	280	185	12 / 72	15.0	1.6

**NEW**



## MS-013T 13 Piece Star Screwdriver Set

Item No.	Size	Item No.	Size
<b>Star Screwdriver w/Rubber Handle:</b>			
504+6606	T-6, 150mmL	506+6725	T-25, 185mmL
504+6607	T-7, 150mmL	506+6827	T-27, 225mmL
504+6608	T-8, 150mmL	506+6830	T-30, 225mmL
504+6609	T-9, 150mmL	508+6840	T-40, 235mmL
506+6710	T-10, 185mmL	508+6845	T-45, 235mmL
506+6715	T-15, 185mmL	508+6850	T-50, 235mmL
506+6720	T-20, 185mmL		Plastic Tray
 1500 g		 3 sets / 6.3 Kgs / 1.35 CUFT	



(285W x 410D x 50H)

## MS-014 14 Piece Slotted, Philips & Posidriv Screwdriver Set

Item No.	Size	Item No.	Size
<b>Screwdriver w/Rubber Handle:</b>			
502+1465	1.2 x 6.5mm, 98mmL	508+1992	2.0 x 12.0mm, 320mmL
508+0890	1.6 x 10.0mm, 370mmL	508+1994	2.5 x 14.0mm, 370mmL
502+1201	#1 Philips, 98mmL	508+1913	#3 Philips, 245mmL
502+1202	#2 Philips, 98mmL	508+0833	#3 Philips, 390mmL
506+1902	#2 Philips, 300mmL	508+1924	#4 Philips, 320mmL
502+0501	#1 Posidriv, 98mmL	508+1943	#3 Posidriv, 295mmL
502+0502	#2 Posidriv, 98mmL	508+1974	#4 Posidriv, 340mmL
Plastic Tray			
 2700 g		 3 sets / 9.5 Kgs / 1.35 CUFT	



(285W x 410D x 50H)

# Reversible Blades

## 1/4" Hex Shank Reversible Blades

Item No.	Size	Pattern		Length mm	Weight g	PCS inner/ctn	G.W. KGS	CUFT
		A	B					
502046	0.8 x 4.0 ~ 1.2 x 6.5mm	⊖	⊖	180	45	50 / 500	23.5	0.34
502057	1.0 x 5.5 ~ 1.5 x 7.0mm	⊖	⊖	180	45	50 / 500	24.0	0.34
502114	PH.1 ~ 0.6 x 4.0mm	⊕	⊖	180	45	50 / 500	23.0	0.34
502126	PH.2 ~ 1.0 x 6.0mm	⊕	⊖	180	45	50 / 500	23.5	0.34
502137	PH.3 ~ 1.2 x 7.0mm	⊕	⊖	180	45	50 / 500	23.0	0.34
502201	PH.0 ~ PH.1	⊕	⊕	180	45	50 / 500	23.0	0.34
502212	PH.1 ~ PH.2	⊕	⊕	180	45	50 / 500	23.5	0.34
502223	PH.2 ~ PH.3	⊕	⊕	180	45	50 / 500	24.0	0.34
502311	PH.1 ~ PZ.1	⊕	⊕	180	45	50 / 500	23.0	0.34
502322	PH.2 ~ PZ.2	⊕	⊕	180	45	50 / 500	23.5	0.34
502401	PZ.0 ~ PZ.1	⊕	⊕	180	45	50 / 500	23.0	0.34
502412	PZ.1 ~ PZ.2	⊕	⊕	180	45	50 / 500	23.5	0.34
502423	PZ.2 ~ PZ.3	⊕	⊕	180	45	50 / 500	24.0	0.34
502515	T-10 ~ T-15	⊕	⊕	180	45	50 / 500	22.5	0.34
502525	T-20 ~ T-25	⊕	⊕	180	45	50 / 500	23.0	0.34
502540	T-30 ~ T-40	⊕	⊕	180	50	50 / 500	25.5	0.34
502625	2.5mm ~ 2.5mm	○	⊗	180	45	50 / 500	22.5	0.34
502630	3.0mm ~ 3.0mm	○	⊗	180	45	50 / 500	22.5	0.34
502640	4.0mm ~ 4.0mm	○	⊗	180	45	50 / 500	23.5	0.34
502650	5.0mm ~ 5.0mm	○	⊗	180	45	50 / 500	24.0	0.34
502660	6.0mm ~ 6.0mm	○	⊗	180	50	50 / 500	25.5	0.34



### RB-207W 7 Piece Combination Reversible Blade Set

Item No.	Size	Item No.	Size
506+0608	1/4" Hex Shank Grip Handle, 110mmL		
<b>Reversible Blade, 180mmL:</b>			
502114	PH.1 ~ 0.6 x 4.0mm	502515	T-10 ~ T-15
502126	PH.2 ~ 1.0 x 6.0mm	502525	T-20 ~ T-25
502412	PZ.1 ~ PZ.2	502540	T-30 ~ T-40
<b>Blow Case</b>			
⚖️ 570 g	📦 20 sets / 12.5 Kgs / 1.5 CUFT		



### RB-211W 11 Piece Combination Reversible Blade Set

Item No.	Size	Item No.	Size
506+0608	1/4" Hex Shank Grip Handle, 110mmL		
<b>Reversible Blade, 180mmL:</b>			
502046	0.8x4.0 ~ 1.2x6.5mm	502650	5.0mm ~ 5.0mm
502057	1.0x5.5 ~ 1.5x7.0mm	502660	6.0mm ~ 6.0mm
502212	PH.1 ~ PH.2	502515	T-10 ~ T-15
502412	PZ.1 ~ PZ.2	502525	T-20 ~ T-25
502640	4.0mm ~ 4.0mm	502540	T-30 ~ T-40
<b>Blow Case</b>			
⚖️ 830 g	📦 12 sets / 11 Kgs / 1.16 CUFT		



## Slotted Screwdrivers

Item No.	H x W mm	L1 mm	L2 mm	Length mm	Weight g	PCS inner/ctn	G.W. KGS	CUFT
592+1230	0.5 x 3.0	75	75	150	30	40 / 320	11.0	1.60
* 593+1230	0.5 x 3.0	75	95	170	45	25 / 200	10.0	1.60
592+1240	0.8 x 4.0	100	75	175	35	50 / 200	8.0	1.60
* 593+1240	0.8 x 4.0	100	95	195	50	40 / 160	9.0	1.60
593+1250	0.8 x 5.0	250	95	345	90	50 / 200	19.0	2.58
* 594+1250	0.8 x 5.0	250	110	360	100	50 / 200	22.0	2.58
593+1455	1.0 x 5.5	100	95	195	65	50 / 200	14.0	1.60
* 594+1455	1.0 x 5.5	100	110	210	75	40 / 160	13.0	1.60
593+1457	1.0 x 5.5	150	95	245	75	50 / 200	16.0	1.97
* 594+1457	1.0 x 5.5	150	110	260	85	40 / 160	15.0	1.97
593+1965	1.2 x 6.5	100	95	195	85	50 / 200	18.0	1.96
* 594+1965	1.2 x 6.5	100	110	210	95	40 / 160	16.5	1.96
593+1966	1.2 x 6.5	150	95	245	100	50 / 200	21.0	1.97
* 594+1966	1.2 x 6.5	150	110	260	110	50 / 200	23.0	2.64
593+1967	1.2 x 6.5	200	95	295	110	50 / 200	23.0	2.64
* 594+1967	1.2 x 6.5	200	110	310	120	40 / 160	20.0	2.64
594+1980	1.2 x 8.0	175	110	285	150	10 / 60	10.5	2.06
* 595+1980	1.2 x 8.0	175	120	295	170	10 / 60	11.5	2.06
594+1990	1.6 x 10.0	200	110	310	230	10 / 60	15.0	2.06
* 595+1990	1.6 x 10.0	200	120	320	240	10 / 60	16.0	2.06
594+1991	1.6 x 10.0	250	110	360	260	10 / 60	17.0	2.06
* 595+1991	1.6 x 10.0	250	120	370	280	10 / 60	18.0	2.06
595+1992	2.0 x 12.0	200	120	320	330	10 / 60	21.0	2.06
* 596+1992	2.0 x 12.0	200	140	340	350	10 / 60	22.0	2.06
595+1994	2.5 x 14.0	250	120	370	380	20 / 40	16.5	1.13
* 596+1994	2.5 x 14.0	250	140	390	400	20 / 40	17.0	1.13
591+1465	1.2 x 6.5	38	48	86	40	50 / 200	9.0	1.39

\* With large handle.

## Philips Screwdrivers

Item No.	Size	L1 mm	L2 mm	Length mm	Weight g	PCS inner/ctn	G.W. KGS	CUFT
592+1400	#0	75	75	150	30	40 / 320	12.5	1.60
* 593+1400	#0	75	95	170	45	50 / 200	10.0	1.60
593+1401	#1	75	95	170	65	50 / 200	14.0	1.60
* 594+1401	#1	75	110	185	75	35 / 140	12.0	1.60
593+1421	#1	100	95	195	70	50 / 200	15.0	1.60
* 594+1421	#1	100	110	210	80	40 / 160	14.0	1.60
593+1431	#1	250	95	345	90	50 / 200	19.0	2.85
* 594+1431	#1	250	110	360	100	40 / 160	17.0	2.85
593+1602	#2	45	95	140	70	25 / 200	15.0	1.60
* 594+1602	#2	45	110	155	80	20 / 160	14.0	1.60
* 594+1712	#2	100	110	210	95	40 / 160	16.5	1.97
593+1802	#2	125	95	220	90	40 / 160	15.5	1.97
* 594+1802	#2	125	110	235	100	35 / 140	15.5	1.97
* 594+1812	#2	150	110	260	100	50 / 200	22.0	2.64
593+1902	#2	200	95	295	110	50 / 200	23.0	2.64
* 594+1902	#2	200	110	310	120	40 / 160	20.0	2.64
593+1932	#2	300	95	395	140	25 / 50	8.0	1.13
* 594+1932	#2	300	110	410	150	20 / 40	7.0	1.13
594+1913	#3	125	110	235	140	40 / 160	23.5	1.97
* 595+1913	#3	125	120	245	150	30 / 120	19.5	1.97
* 595+1843	#3	150	120	270	160	10 / 60	11.0	2.06
594+1923	#3	200	110	310	160	10 / 60	11.0	2.06
* 595+1923	#3	200	120	320	180	10 / 60	12.0	2.06
594+1933	#3	270	110	380	200	25 / 50	11.0	1.13
* 595+1933	#3	270	120	390	210	20 / 40	9.5	1.13
594+1924	#4	200	110	310	230	10 / 60	15.0	2.06
* 595+1924	#4	200	120	320	240	10 / 60	16.0	2.06
591+1201	#1	38	48	86	40	50 / 200	9.0	1.39
591+1202	#2	38	48	86	40	50 / 200	9.0	1.39

\* With large handle.

Hex bolster on every screwdrivers lets you generate extra turning power with a wrench

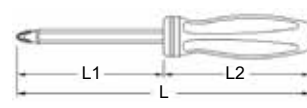
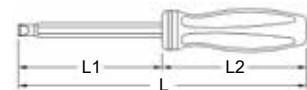

# Screwdrivers

## Hex Screwdrivers

Item No.	Size	L1 mm	L2 mm	Length mm	Weight g	PCS inner/ctn	G.W. KGS	CUFT 
592+2622	2mm	70	75	145	50	40 / 320	17.0	1.60
592+2625	2.5mm	70	75	145	50	40 / 320	17.0	1.60
592+2633	3mm	70	75	145	50	40 / 320	17.0	1.60
592+2634	4mm	70	75	145	50	40 / 320	17.0	1.60
593+2735	5mm	85	95	180	80	50 / 200	17.0	1.60
593+2736	6mm	85	95	180	80	50 / 200	17.0	1.60
594+2847	7mm	115	110	225	120	40 / 160	21.0	1.97
594+2848	8mm	115	110	225	120	40 / 160	21.0	1.97
595+2849	9mm	105	120	225	170	30 / 120	21.5	1.97
595+2850	10mm	105	120	225	190	30 / 120	24.0	1.97
592+3604	1/16"	70	75	145	50	40 / 320	17.0	1.60
592+3605	5/64"	70	75	145	50	40 / 320	17.0	1.60
592+3606	3/32"	70	75	145	50	40 / 320	17.0	1.60
592+3607	7/64"	70	75	145	50	40 / 320	17.0	1.60
592+3608	1/8"	70	75	145	50	40 / 320	17.0	1.60
592+3610	5/32"	70	75	145	50	40 / 320	17.0	1.60
593+3712	3/16"	85	95	180	80	50 / 200	17.0	1.60
593+3714	7/32"	85	95	180	80	50 / 200	17.0	1.60
594+3816	1/4"	115	110	225	100	40 / 160	17.0	1.97
594+3818	9/32"	115	110	225	120	40 / 160	21.0	1.97
594+3820	5/16"	115	110	225	120	40 / 160	21.0	1.97
595+3824	3/8"	105	120	225	190	30 / 120	24.0	1.97

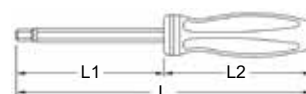

## Wobble Hex Screwdrivers

Item No.	Size	L1 mm	L2 mm	Length mm	Weight g	PCS inner/ctn	G.W. KGS	CUFT 
592+4633	3mm	70	75	145	50	40 / 320	17.0	1.60
592+4634	4mm	70	75	145	50	40 / 320	17.0	1.60
593+4735	5mm	85	95	180	80	50 / 200	17.0	1.60
593+4736	6mm	85	95	180	80	50 / 200	17.0	1.60
594+4847	7mm	115	110	225	120	40 / 160	21.0	1.97
594+4848	8mm	115	110	225	120	40 / 160	21.0	1.97
595+4849	9mm	105	120	225	170	30 / 120	21.5	1.97
595+4850	10mm	105	120	225	190	30 / 120	24.0	1.97
592+5608	1/8"	70	75	145	50	40 / 320	17.0	1.60
592+5610	5/32"	70	75	145	50	40 / 320	17.0	1.60
593+5712	3/16"	85	95	180	80	50 / 200	17.0	1.60
593+5714	7/32"	85	95	180	80	50 / 200	17.0	1.60
594+5816	1/4"	115	110	225	100	40 / 160	17.0	1.97
594+5818	9/32"	115	110	225	120	40 / 160	21.0	1.97
594+5820	5/16"	115	110	225	120	40 / 160	21.0	1.97
595+5824	3/8"	105	120	225	180	30 / 120	23.0	1.97

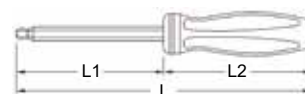

## 508003 4 in 1 Screwdriver

Item No. Size

Double Ended Tip Bit:

267512 #1 & #2 Philips Screwdriver Bit

267560 0.8 x 5.0 & 1.0 x 6.0mm Slotted Screwdriver Bit

Sliding Card

 170 g

 20x4 80 sets / 14.5 Kgs / 1.94 CUFT

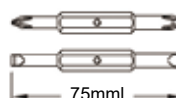



# Screwdrivers

## Star Screwdrivers

Item No.	Size	L1 mm	L2 mm	Length mm	Weight g	PCS	G.W. KGS	CUFT
						inner/ctn		
592+6606	T-6	70	75	145	50	40 / 320	17.0	1.60
592+6607	T-7	70	75	145	50	40 / 320	17.0	1.60
592+6608	T-8	70	75	145	50	40 / 320	17.0	1.60
592+6609	T-9	70	75	145	50	40 / 320	17.0	1.60
593+6710	T-10	80	95	175	80	50 / 200	17.0	1.60
593+6715	T-15	80	95	175	80	50 / 200	17.0	1.60
593+6720	T-20	80	95	175	80	50 / 200	17.0	1.60
593+6725	T-25	80	95	175	80	50 / 200	17.0	1.60
594+6827	T-27	105	110	215	100	40 / 160	17.0	1.97
594+6830	T-30	105	110	215	100	40 / 160	17.0	1.97
595+6840	T-40	105	120	225	110	30 / 120	15.0	1.97
595+6845	T-45	105	120	225	130	30 / 120	17.0	1.97
595+6850	T-50	105	120	225	180	30 / 120	23.0	1.97

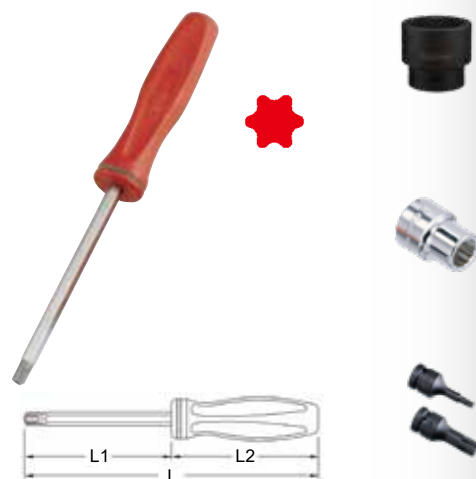

## Tamperproof Star Screwdrivers

Item No.	Size	L1 mm	L2 mm	Length mm	Weight g	PCS	G.W. KGS	CUFT
						inner/ctn		
592+7606	T-6	70	75	145	50	40 / 320	17.0	1.60
592+7607	T-7	70	75	145	50	40 / 320	17.0	1.60
592+7608	T-8	70	75	145	50	40 / 320	17.0	1.60
592+7609	T-9	70	75	145	50	40 / 320	17.0	1.60
593+7710	T-10	80	95	175	80	50 / 200	17.0	1.60
593+7715	T-15	80	95	175	80	50 / 200	17.0	1.60
593+7920	T-20	100	95	195	85	50 / 200	18.0	1.60
593+7925	T-25	100	95	195	85	50 / 200	18.0	1.60
594+7827	T-27	105	110	215	100	40 / 160	17.0	1.97
594+7830	T-30	105	110	215	100	40 / 160	17.0	1.97
595+7940	T-40	130	120	250	120	30 / 120	15.5	1.97
595+7945	T-45	130	120	250	150	30 / 120	19.0	1.97
595+7850	T-50	105	120	225	140	30 / 120	18.0	1.97

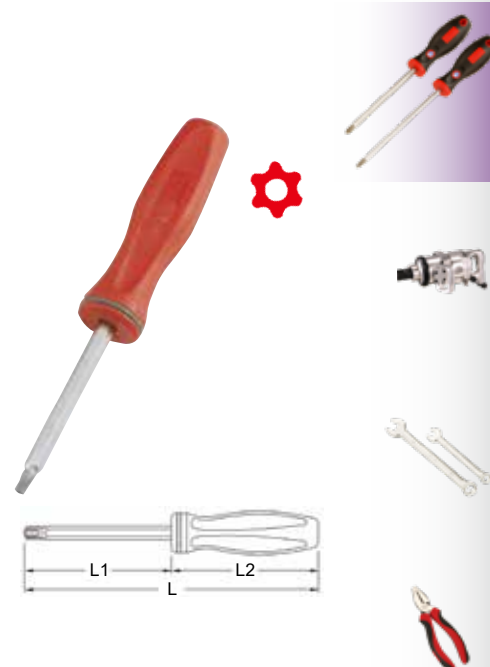

## Square Screwdrivers

Item No.	Size	L1 mm	L2 mm	Length mm	Weight g	PCS	G.W. KGS	CUFT
						inner/ctn		
500050	#0	100	95	195	70	30 / 120	9.5	1.96
500051	#1	100	95	195	70	30 / 120	9.5	1.96
500052	#2	100	110	210	100	30 / 120	13.0	1.96
500053	#3	100	110	210	100	30 / 120	13.0	1.96
500054	#4	100	110	210	120	30 / 120	15.5	1.96



# Screwdriver Sets

## TL-508 8 Piece Slotted & Philips Screwdriver Set

Item No.	Size	Item No.	Size
<b>Screwdriver w/Plastic Handle:</b>			
591+1465	1.2 x 6.5mm, 86mmL	591+1201	#1 Philips, 86mmL
593+1965	1.2 x 6.5mm, 195mmL	593+1401	#1 Philips, 170mmL
594+1980	1.2 x 8.0mm, 285mmL	593+1802	#2 Philips, 220mmL
594+1990	1.6 x 10.0mm, 310mmL	593+1902	#2 Philips, 295mmL

1300 g

10 sets / 14 Kgs / 1.58 CUFT

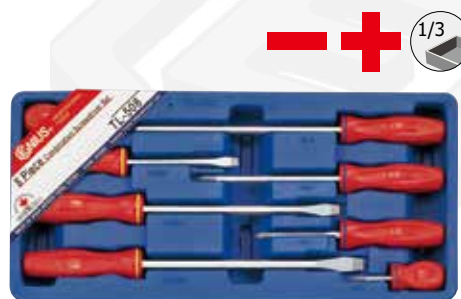

(192W x 406D)

## TL-508X 8 Piece Slotted & Philips Screwdriver Set

Item No.	Size	Item No.	Size
<b>Screwdriver w/Plastic Handle:</b>			
591+1465	1.2 x 6.5mm, 86mmL	591+1201	#1 Philips, 86mmL
594+1965	1.2 x 6.5mm, 210mmL	594+1401	#1 Philips, 185mmL
595+1980	1.2 x 8.0mm, 295mmL	594+1802	#2 Philips, 235mmL
595+1990	1.6 x 10.0mm, 320mmL	594+1902	#2 Philips, 310mmL

1350 g

10 sets / 14.5 Kgs / 1.58 CUFT

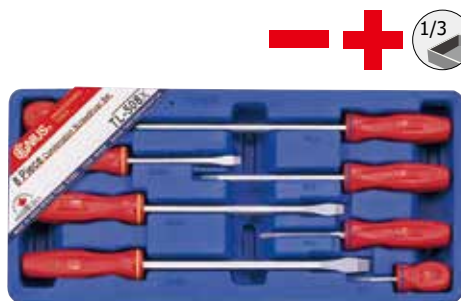

(192W x 406D)

## TL-518 18 Piece Slotted & Philips Screwdriver Set

Item No.	Size	Item No.	Size
<b>Screwdriver w/Plastic Handle:</b>			
593+1250	0.8 x 5.0mm, 345mmL	593+1401	#1 Philips, 170mmL
591+1465	1.2 x 6.5mm, 86mmL	593+1431	#1 Philips, 345mmL
593+1965	1.2 x 6.5mm, 195mmL	593+1602	#2 Philips, 140mmL
594+1990	1.6 x 1.0mm, 310mmL	593+1902	#2 Philips, 295mmL
594+1991	1.2 x 6.5mm, 360mmL	593+1932	#2 Philips, 395mmL
591+1201	#1 Philips, 86mmL	594+1923	#3 Philips, 310mmL
<b>Micro-Tech Screwdriver:</b>			
5602070	0.4 x 2.0mm, 122mmL	570071	#000, 122mmL
5602570	0.4 x 2.5mm, 122mmL	570072	#00, 122mmL
5603070	0.5 x 3.0mm, 122mmL	570073	#0, 122mmL

Plastic Tray

2400 g

5 sets / 13 Kgs / 1.58 CUFT

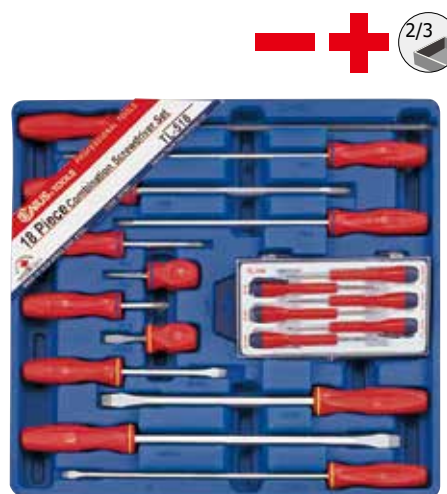

(384W x 406D)

## TX-512A 12 Piece Tamperproof Star Screwdriver Set

Item No.	Size	Item No.	Size
<b>Tamperproof Star Screwdriver w/Rubber Handle:</b>			
592+7606	T-6, 145mmL	593+7920	T-20, 195mmL
592+7607	T-7, 145mmL	593+7925	T-25, 195mmL
592+7608	T-8, 145mmL	594+7827	T-27, 215mmL
592+7609	T-9, 145mmL	594+7830	T-30, 215mmL
593+7710	T-10, 175mmL	595+7940	T-40, 250mmL
593+7715	T-15, 175mmL	595+7945	T-45, 250mmL

1400 g

10 sets / 15 Kgs / 1.58 CUFT

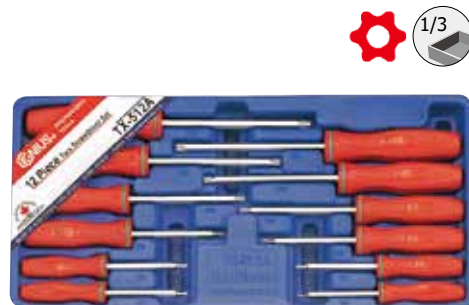

(192W x 406D)

## HS-5610M 10 Piece Metric Hex Screwdriver Set

Item No.	Size	Item No.	Size
<b>Hex Screwdriver w/Plastic Handle:</b>			
592+2622	2mm, 145mmL	593+2736	6mm, 180mmL
592+2625	2.5mm, 145mmL	594+2847	7mm, 225mmL
592+2633	3mm, 145mmL	594+2848	8mm, 225mmL
592+2634	4mm, 145mmL	595+2849	9mm, 225mmL
593+2735	5mm, 180mmL	595+2850	10mm, 225mmL

1500 g 5 sets / 8.5 Kgs / 0.93 CUFT

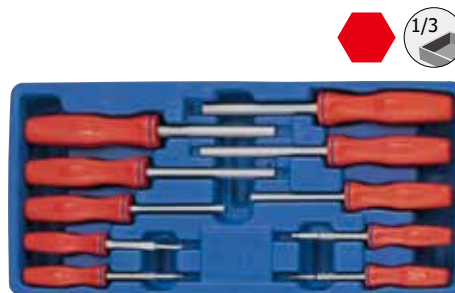

(192W x 406D)

## HS-5612S 12 Piece SAE Hex Screwdriver Set

Item No.	Size	Item No.	Size
<b>Hex Screwdriver w/Plastic Handle:</b>			
592+3604	1/16", 145mmL	593+3712	3/16", 180mmL
592+3605	5/64", 145mmL	593+3714	7/32", 180mmL
592+3606	3/32", 145mmL	594+3816	1/4", 225mmL
592+3607	7/64", 145mmL	594+3818	9/32", 225mmL
592+3608	1/8", 145mmL	594+3820	5/16", 225mmL
592+3610	5/32", 145mmL	595+3824	3/8", 225mmL

1500 g 5 sets / 8.5 Kgs / 0.93 CUFT

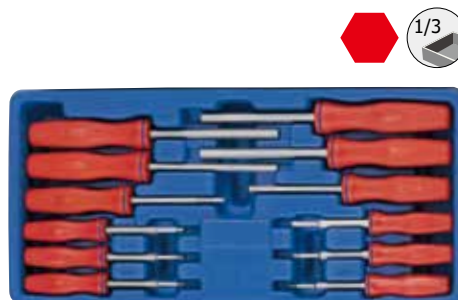

(192W x 406D)

## HS-5708MW 8 Piece Metric Wobble Hex Screwdriver Set

Item No.	Size	Item No.	Size
<b>Wobble Hex Screwdriver w/Plastic Handle:</b>			
592+4633	3mm, 145mmL	594+4847	7mm, 225mmL
592+4634	4mm, 145mmL	594+4848	8mm, 225mmL
593+4735	5mm, 180mmL	595+4849	9mm, 225mmL
593+4736	6mm, 180mmL	595+4850	10mm, 225mmL

1300 g 5 sets / 7.5 Kgs / 0.93 CUFT

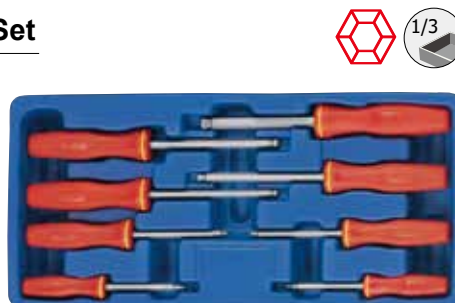

(192W x 406D)

## HS-5708SW 8 Piece SAE Wobble Hex Screwdriver Set

Item No.	Size	Item No.	Size
<b>Wobble Hex Screwdriver w/Plastic Handle:</b>			
592+5608	1/8", 145mmL	594+5816	1/4", 225mmL
592+5610	5/32", 145mmL	594+5818	9/32", 225mmL
593+5712	3/16", 180mmL	594+5820	5/16", 225mmL
593+5714	7/32", 180mmL	595+5824	3/8", 225mmL

1300 g 5 sets / 7.5 Kgs / 0.93 CUFT

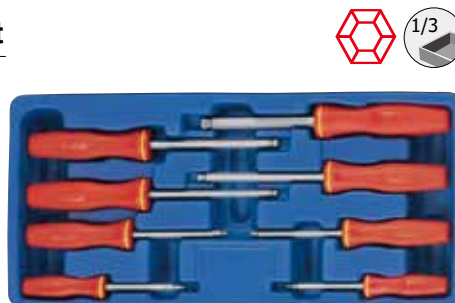

(192W x 406D)

# Screwdriver Sets

## TX-513T 13 Piece Star Screwdriver Set

Item No.	Size	Item No.	Size
<b>Star Screwdriver w/Plastic Handle:</b>			
592+6606	T-6, 145mmL	593+6725	T-20, 175mmL
592+6607	T-7, 145mmL	594+6827	T-27, 215mmL
592+6608	T-8, 145mmL	594+6830	T-30, 215mmL
592+6609	T-9, 145mmL	595+6840	T-40, 225mmL
593+6710	T-10, 175mmL	595+6845	T-45, 225mmL
593+6715	T-15, 175mmL	595+6850	T-50, 225mmL
593+6720	T-20, 175mmL		Blow Case
1750 g		4 sets / 8 Kgs / 1.65 CUFT	



## TL-515X 15 Piece Combination Screwdriver & Pry Bar Set

Item No.	Size	Item No.	Size
560012	Bent Tip Pry Bar, 300mmL(12")		
<b>Screwdriver w/Plastic Handle:</b>			
593+1230	0.5 x 3.0mm, 170mmL	591+1201	#1 Philips, 86mmL
594+1250	0.8 x 5.0mm, 360mmL	594+1401	#1 Philips, 185mmL
591+1465	1.2 x 6.5mm, 86mmL	594+1431	#1 Philips, 360mmL
594+1965	1.2 x 6.5mm, 210mmL	594+1602	#2 Philips, 155mmL
595+1980	1.2 x 8.0mm, 295mmL	594+1802	#2 Philips, 235mmL
595+1990	1.6 x 10.0mm, 320mmL	594+1902	#2 Philips, 310mmL
593+1400	#0 Philips, 170mmL	595+1923	#3 Philips, 320mmL
	Blow Case		
2400 g		4 sets / 10.5 Kgs / 1.07 CUFT	



## TL-517X 17 Piece Combination ScrewdriverSet

Item No.	Size	Item No.	Size
<b>Screwdriver w/Plastic Handle:</b>			
593+1230	0.5 x 3.0mm, 170mmL	594+1431	#1 Philips, 360mmL
594+1250	0.8 x 5.0mm, 360mmL	594+1602	#2 Philips, 155mmL
591+1465	1.2 x 6.5mm, 86mmL	594+1712	#2 Philips, 210mmL
594+1965	1.2 x 6.5mm, 210mmL	594+1802	#2 Philips, 235mmL
595+1980	1.2 x 8.0mm, 295mmL	594+1812	#2 Philips, 260mmL
595+1990	1.6 x 10.0mm, 320mmL	594+1902	#2 Philips, 310mmL
593+1400	#0 Philips, 170mmL	595+1843	#3 Philips, 270mmL
591+1201	#1 Philips, 86mmL	595+1923	#3 Philips, 320mmL
594+1401	#1 Philips, 185mmL		Blow Case
2500 g		4 sets / 12 Kgs / 1.65 CUFT	



## Micro-Tech Slotted Screwdrivers

Item No.	Size mm	L1 mm	L2 mm	Length mm	Weight g	PCS inner/ctn	G.W. KGS	CUFT
5601270	0.3 x 1.2	40	82	122	25	40 / 320	9.0	1.60
5601670	0.3 x 1.6	40	82	122	25	40 / 320	9.0	1.60
5602070	0.4 x 2.0	40	82	122	25	40 / 320	9.0	1.60
5602570	0.4 x 2.5	40	82	122	25	40 / 320	9.0	1.60
5603070	0.5 x 3.0	40	82	122	25	40 / 320	9.0	1.60
561512	0.3 x 1.2	73	82	155	25	40 / 320	9.0	1.60
561516	0.3 x 1.6	73	82	155	25	40 / 320	9.0	1.60
561520	0.4 x 2.0	73	82	155	25	40 / 320	9.0	1.60
561525	0.4 x 2.5	73	82	155	25	40 / 320	9.0	1.60
561530	0.5 x 3.0	73	82	155	25	40 / 320	9.0	1.60

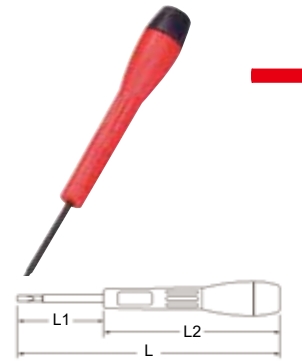

## Micro-Tech Philips Screwdrivers

Item No.	Size	L1 mm	L2 mm	Length mm	Weight g	PCS inner/ctn	G.W. KGS	CUFT
570071	#000	40	82	122	25	40 / 320	9.0	1.60
570072	#00	40	82	122	25	40 / 320	9.0	1.60
570073	#0	40	82	122	25	40 / 320	9.0	1.60
571571	#000	73	82	155	25	40 / 320	9.0	1.60
571572	#00	73	82	155	25	40 / 320	9.0	1.60
571573	#0	73	82	155	25	40 / 320	9.0	1.60

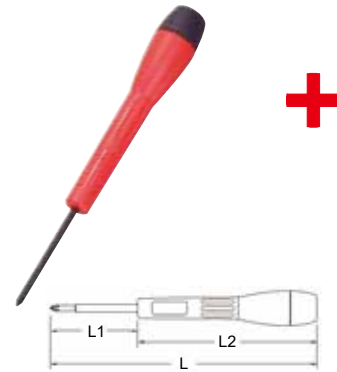

## Micro-Tech Hex Screwdrivers

Item No.	Size	L1 mm	L2 mm	Length mm	Weight g	PCS inner/ctn	G.W. KGS	CUFT
523209	0.9mm	40	82	122	25	40 / 320	9.0	1.60
523213	1.3mm	40	82	122	25	40 / 320	9.0	1.60
523215	1.5mm	40	82	122	25	40 / 320	9.0	1.60
523520	2.0mm	73	82	155	25	40 / 320	9.0	1.60
523525	2.5mm	73	82	155	25	40 / 320	9.0	1.60
523530	3.0mm	73	82	155	25	40 / 320	9.0	1.60
524403	1/20"	40	82	122	25	40 / 320	9.0	1.60
524404	1/16"	40	82	122	25	40 / 320	9.0	1.60
524505	5/64"	73	82	155	25	40 / 320	9.0	1.60
524506	3/32"	73	82	155	25	40 / 320	9.0	1.60
524507	7/64"	73	82	155	25	40 / 320	9.0	1.60

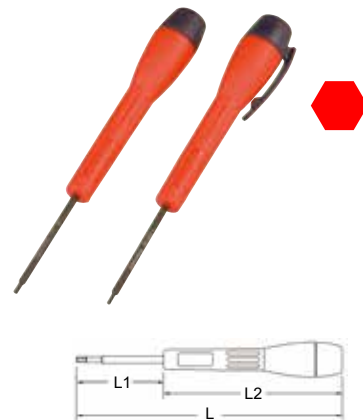

## Micro-Tech Star Screwdrivers

Item No.	Size	L1 mm	L2 mm	Length mm	Weight g	PCS inner/ctn	G.W. KGS	CUFT
521205	T-5	40	82	122	25	40 / 320	9.0	1.60
521206	T-6	40	82	122	25	40 / 320	9.0	1.60
521207	T-7	40	82	122	25	40 / 320	9.0	1.60
521208	T-8	40	82	122	25	40 / 320	9.0	1.60
521505	T-5	73	82	155	25	40 / 320	9.0	1.60
521506	T-6	73	82	155	25	40 / 320	9.0	1.60
521507	T-7	73	82	155	25	40 / 320	9.0	1.60
521508	T-8	73	82	155	25	40 / 320	9.0	1.60
521509	T-9	73	82	155	25	40 / 320	9.0	1.60
521510	T-10	73	82	155	25	40 / 320	9.0	1.60
521515	T-15	73	82	155	25	40 / 320	9.0	1.60
521520	T-20	73	82	155	25	40 / 320	9.0	1.60



# Micro-Tech Screwdriver Sets

## TL-506 6 Piece Micro-Tech Screwdriver Set

Item No.	Size	Item No.	Size
<b>Micro-Tech Screwdriver:</b>			
5602070	0.4 x 2.0mm, 122mmL	570071	#000 Philips, 122mmL
5602570	0.4 x 2.5mm, 122mmL	570072	#00 Philips, 122mmL
5603070	0.5 x 3.0mm, 122mmL	570073	#0 Philips, 122mmL
Plastic Case			

160 g

40 sets / 7.5 Kgs / 0.73 CUFT



## TL-506A 6 Piece Micro-Tech Screwdriver Set

Item No.	Size	Item No.	Size
<b>Micro-Tech Screwdriver:</b>			
5601270	0.3 x 1.2mm, 122mmL	570071	#000 Philips, 122mmL
5601670	0.3 x 1.6mm, 122mmL	570072	#00 Philips, 122mmL
5602070	0.4 x 2.0mm, 122mmL	570073	#0 Philips, 122mmL
Plastic Case			

160 g

40 sets / 7.5 Kgs / 0.73 CUFT



## MT-508 8 Piece Micro-Tech Screwdriver Set

Item No.	Size	Item No.	Size
<b>Micro-Tech Screwdriver:</b>			
5601270	0.3 x 1.2mm, 122mmL	5603070	0.5 x 3.0mm, 122mmL
5601670	0.3 x 1.6mm, 122mmL	570071	#000 Philips, 122mmL
5602070	0.4 x 2.0mm, 122mmL	570072	#00 Philips, 122mmL
5602570	0.4 x 2.5mm, 122mmL	570073	#0 Philips, 122mmL
Plastic Case			

185 g

40 sets / 8.5 Kgs / 0.73 CUFT



## MT-508L 8 Piece Micro-Tech Screwdriver Set

Item No.	Size	Item No.	Size
<b>Micro-Tech Screwdriver:</b>			
561512	0.3 x 1.2mm, 155mmL	561530	0.5 x 3.0mm, 155mmL
561516	0.3 x 1.6mm, 155mmL	571571	#000 Philips, 155mmL
561520	0.4 x 2.0mm, 155mmL	571572	#00 Philips, 155mmL
561525	0.4 x 2.5mm, 155mmL	571573	#0 Philips, 155mmL
Plastic Case			

200 g

40 sets / 9 Kgs / 0.73 CUFT





# Micro-Tech Screwdriver Sets

## MT-5306 6 Piece Micro-Tech Metric Hex Screwdriver Set

Item No.	Size	Item No.	Size
<b>Micro-Tech Screwdriver:</b>			
523209	0.9mm Hex, 122mmL	523520	2.0mm Hex, 155mmL
523213	1.3mm Hex, 122mmL	523525	2.5mm Hex, 155mmL
523215	1.5mm Hex, 122mmL	523530	3.0mm Hex, 155mmL

Plastic Case

 160 g

 40 sets / 7.5 Kgs / 0.73 CUFT



## MT-5405 5 Piece Micro-Tech SAE Hex Screwdriver Set

Item No.	Size	Item No.	Size
<b>Micro-Tech Screwdriver:</b>			
524403	1/20" Hex, 122mmL	524506	3/32" Hex, 155mmL
524404	1/16" Hex, 122mmL	524507	7/64" Hex, 155mmL
524505	5/64" Hex, 155mmL	Plastic Case	

Plastic Case

 150 g

 40 sets / 7 Kgs / 0.73 CUFT



## MT-5208 8 Piece Micro-Tech Star Screwdriver Set

Item No.	Size	Item No.	Size
<b>Micro-Tech Screwdriver:</b>			
521505	T-5 Star, 155mmL	521509	T-9 Star, 155mmL
521506	T-6 Star, 155mmL	521510	T-10 Star, 155mmL
521507	T-7 Star, 155mmL	521515	T-15 Star, 155mmL
521508	T-8 Star, 155mmL	521520	T-20 Star, 155mmL

Plastic Case

 200 g

 40 sets / 9 Kgs / 0.73 CUFT



## MT-5206 6 Piece Micro-Tech Screwdriver Set

Item No.	Size	Item No.	Size
<b>Micro-Tech Screwdriver:</b>			
5602570	0.4 x 2.5mm, 122mmL	570072	#00 Philips, 122mmL
5603070	0.5 x 3.0mm, 122mmL	521206	T-6 Star, 122mmL
570071	#000 Philips, 122mmL	521207	T-7 Star, 122mmL

Plastic Case

 160 g

 40 sets / 7.5 Kgs / 0.73 CUFT



# Nut Drivers

## Metric Hex Nut Drivers

Item No.	Size mm	L1 mm	L2 mm	Length mm	Weight g	PCS	G.W. KGS	CUFT
						inner/ctn		
593744	4	70	4	165	75	10 / 100	8.5	1.54
593745	5	70	7	165	75	10 / 100	8.5	1.54
593755	5.5	70	7	165	75	10 / 100	8.5	1.54
593756	6	70	8	165	75	10 / 100	8.5	1.54
594757	7	70	9	180	90	10 / 80	8.5	1.97
594758	8	70	9	180	90	10 / 80	8.5	1.97
594759	9	70	10	180	90	10 / 80	8.5	1.97
594760	10	70	11	180	90	10 / 80	8.5	1.97
594761	11	70	11	180	90	10 / 80	8.5	1.97
594762	12	70	12	180	90	10 / 80	8.5	1.97
595763	13	70	13	190	130	10 / 60	9.0	1.41
595764	14	70	14	190	130	10 / 60	9.0	1.41

## SAE Hex Nut Drivers

Item No.	Size inch	L1 mm	L2 mm	Length mm	Weight g	PCS	G.W. KGS	CUFT
						inner/ctn		
593712	3/16	70	5	165	75	10 / 100	8.5	1.54
593716	1/4	70	6	165	75	10 / 100	8.5	1.54
594720	5/16	70	8	180	90	10 / 80	8.5	1.97
594722	11/32	70	9	180	90	10 / 80	8.5	1.97
594724	3/8	70	10	180	90	10 / 80	8.5	1.97
594728	7/16	70	12	180	90	10 / 80	8.5	1.97
595732	1/2	70	14	190	130	10 / 60	9.0	1.41

## Metric Long Hex Nut Drivers

Item No.	Size mm	L1 mm	L2 mm	Length mm	Weight g	PCS	G.W. KGS	CUFT
						inner/ctn		
593844	4	150	4	245	95	10 / 100	10.5	1.97
593845	5	150	7	245	95	10 / 100	10.5	1.97
593855	5.5	150	7	245	95	10 / 100	10.5	1.97
593856	6	150	8	245	95	10 / 100	10.5	1.97
594857	7	150	9	260	120	10 / 80	11.0	1.96
594858	8	150	9	260	120	10 / 80	11.0	1.96
594859	9	150	10	260	120	10 / 80	11.0	1.96
594860	10	150	11	260	120	10 / 80	11.0	1.96
594861	11	150	11	260	120	10 / 80	11.0	1.96
594862	12	150	12	260	120	10 / 80	11.0	1.96
595863	13	150	13	270	160	10 / 60	11.0	1.21
595864	14	150	14	270	160	10 / 60	11.0	1.21

## SAE Long Hex Nut Drivers

Item No.	Size inch	L1 mm	L2 mm	Length mm	Weight g	PCS	G.W. KGS	CUFT
						inner/ctn		
593812	3/16	150	5	245	95	10 / 100	10.5	1.97
593816	1/4	150	6	245	95	10 / 100	10.5	1.97
594820	5/16	150	8	260	120	10 / 80	11.0	1.96
594822	11/32	150	10	260	120	10 / 80	11.0	1.96
594824	3/8	150	10	260	120	10 / 80	11.0	1.96
594828	7/16	150	12	260	120	10 / 80	11.0	1.96
595832	1/2	150	14	270	160	10 / 60	11.0	1.21

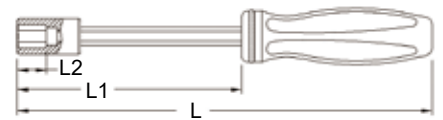
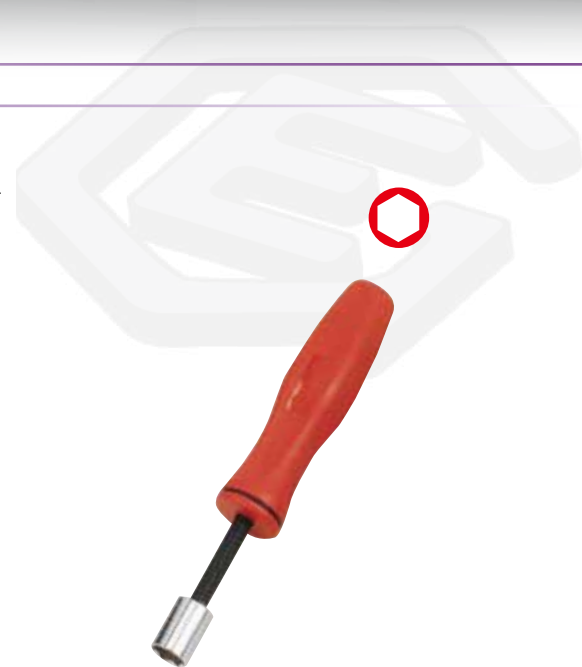





## ND-012M 12 Piece Metric Hex Nut Driver Set

Item No.	Size	Item No.	Size
<b>Hex Nut Driver:</b>			
593744	4mm	594759	9mm
593745	5mm	594760	10mm
593755	5.5mm	594761	11mm
593756	6mm	594762	12mm
594757	7mm	595763	13mm
594758	8mm	595764	14mm

Pouch Bag

 1400 g

 6 sets / 9.5 Kgs / 1.41 CUFT



## ND-007S 7 Piece SAE Hex Nut Driver Set

Item No.	Size	Item No.	Size
<b>Hex Nut Driver:</b>			
593712	3/16"	594724	3/8"
593716	1/4"	594728	7/16"
594720	5/16"	595732	1/2"
594722	11/32"	Pouch Bag	

 1000 g

 6 sets / 7 Kgs / 1.41 CUFT



## ND-012MD 12 Piece Metric Long Hex Nut Driver Set

Item No.	Size	Item No.	Size
<b>Long Hex Nut Driver:</b>			
593844	4mm	594859	9mm
593845	5mm	594860	10mm
593855	5.5mm	594861	11mm
593856	6mm	594862	12mm
594857	7mm	595863	13mm
594858	8mm	595864	14mm

Pouch Bag

 1700 g

 6 sets / 11 Kgs / 1.41 CUFT

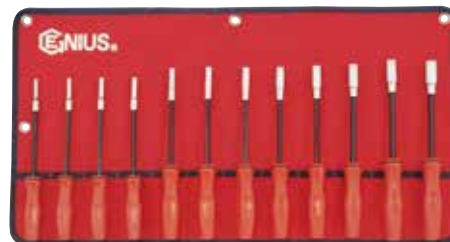

## ND-007SD 7 Piece SAE Hex Nut Driver Set

Item No.	Size	Item No.	Size
<b>Long Hex Nut Driver:</b>			
593812	3/16"	594824	3/8"
593816	1/4"	594828	7/16"
594820	5/16"	595832	1/2"
594822	11/32"	Pouch Bag	

 1150 g

 6 sets / 8 Kgs / 1.41 CUFT



# Nut Drivers

## Metric Hex Nut Drivers (with magnet)

Item No.	Size mm	L1 mm	L2 mm	Length mm	Weight g	PCS	G.W. KGS	CUFT
						inner/ctn		
593556	6	70	8	165	75	10 / 100	8.5	1.54
594557	7	70	9	180	90	10 / 80	8.5	1.97
594558	8	70	9	180	90	10 / 80	8.5	1.97
594559	9	70	10	180	90	10 / 80	8.5	1.97
594560	10	70	11	180	90	10 / 80	8.5	1.97
594561	11	70	11	180	90	10 / 80	8.5	1.97
594562	12	70	12	180	90	10 / 80	8.5	1.97
595563	13	70	13	190	130	10 / 60	9.0	1.41
595564	14	70	14	190	130	10 / 60	9.0	1.41

## SAE Hex Nut Drivers (with magnet)

Item No.	Size inch	L1 mm	L2 mm	Length mm	Weight g	PCS	G.W. KGS	CUFT
						inner/ctn		
593516	1/4	70	6	165	75	10 / 100	8.5	1.54
594520	5/16	70	8	180	90	10 / 80	8.5	1.97
594522	11/32	70	9	180	90	10 / 80	8.5	1.97
594524	3/8	70	10	180	90	10 / 80	8.5	1.97
594528	7/16	70	12	180	90	10 / 80	8.5	1.97
595532	1/2	70	14	190	130	10 / 60	9.0	1.41

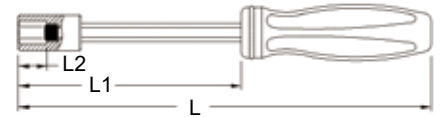
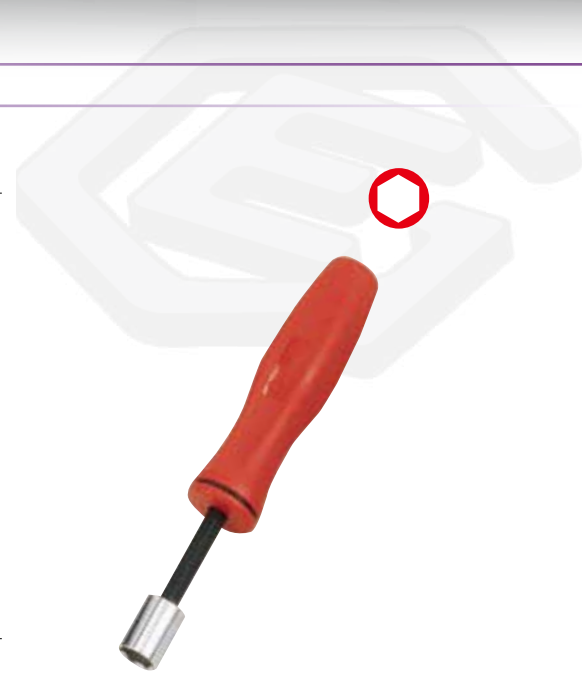

## Metric Long Hex Nut Drivers (with magnet)

Item No.	Size mm	L1 mm	L2 mm	Length mm	Weight g	PCS	G.W. KGS	CUFT
						inner/ctn		
593656	6	150	8	245	95	10 / 100	10.5	1.97
594657	7	150	9	260	120	10 / 80	11.0	1.96
594658	8	150	9	260	120	10 / 80	11.0	1.96
594659	9	150	10	260	120	10 / 80	11.0	1.96
594660	10	150	11	260	120	10 / 80	11.0	1.96
594661	11	150	11	260	120	10 / 80	11.0	1.96
594662	12	150	12	260	120	10 / 80	11.0	1.96
595663	13	150	13	270	160	10 / 60	11.0	1.21
595664	14	150	14	270	160	10 / 60	11.0	1.21



## SAE Long Hex Nut Drivers (with magnet)

Item No.	Size inch	L1 mm	L2 mm	Length mm	Weight g	PCS	G.W. KGS	CUFT
						inner/ctn		
593616	1/4	150	6	245	95	10 / 100	10.5	1.97
594620	5/16	150	8	260	120	10 / 80	11.0	1.96
594622	11/32	150	10	260	120	10 / 80	11.0	1.96
594624	3/8	150	10	260	120	10 / 80	11.0	1.96
594628	7/16	150	12	260	120	10 / 80	11.0	1.96
595632	1/2	150	14	270	160	10 / 60	11.0	1.21

## NM-009M 9 Piece Metric Hex Nut Driver Set (with Magnet)

Item No.	Size	Item No.	Size
<b>Hex Nut Driver with Magnet:</b>			
593556	6mm	594561	11mm
594557	7mm	594562	12mm
594558	8mm	595563	13mm
594559	9mm	595564	14mm
594560	10mm	Pouch Bag	
1150 g		6 sets / 8 Kgs / 1.41 CUFT	



## NM-006S 6 Piece SAE Hex Nut Driver Set (with Magnet)

Item No.	Size	Item No.	Size
<b>Hex Nut Driver with Magnet:</b>			
593516	1/4"	594524	3/8"
594520	5/16"	594528	7/16"
594522	11/32"	595532	1/2"
Pouch Bag			
800 g		6 sets / 6 Kgs / 1.41 CUFT	



## NM-009MD 9 Piece Metric Long Hex Nut Driver Set (with Magnet)

Item No.	Size	Item No.	Size
<b>Long Hex Nut Driver with Magnet:</b>			
593656	6mm	594661	11mm
594657	7mm	594662	12mm
594658	8mm	595663	13mm
594659	9mm	595664	14mm
594660	10mm	Pouch Bag	
1500 g		6 sets / 10 Kgs / 1.41 CUFT	



## NM-006SD 6 Piece SAE Long Hex Nut Driver Set (with Magnet)

Item No.	Size	Item No.	Size
<b>Hex Nut Driver with Magnet:</b>			
593616	1/4"	594624	3/8"
594620	5/16"	594628	7/16"
594622	11/32"	595632	1/2"
Pouch Bag			
1000 g		6 sets / 7 Kgs / 1.41 CUFT	



# Hex Nut Drivers

## Metric & SAE Hex Nut Drivers

Item No.	Size mm	Hex Shank	Length mm	Weight g	PCS	G.W. KGS	CUFT 
					inner/ctn		
0444	4	1/4"	140	45	20 / 240	12.0	0.30
0445	5	1/4"	140	50	20 / 240	12.5	0.30
0455	5.5	1/4"	140	50	20 / 240	12.5	0.30
0456	6	1/4"	140	50	20 / 240	12.5	0.30
0457	7	1/4"	140	50	20 / 240	13.0	0.30
0458	8	1/4"	140	50	20 / 240	13.0	0.30
0459	9	1/4"	140	50	20 / 240	13.0	0.30
0460	10	1/4"	140	55	10 / 120	7.5	0.30
0461	11	1/4"	140	60	10 / 120	8.5	0.30
0462	12	1/4"	140	70	10 / 120	9.0	0.30
0463	13	1/4"	140	70	10 / 120	9.0	0.30
0464	14	1/4"	140	75	10 / 120	10.0	0.30

Item No.	Size inch	Hex Shank	Length mm	Weight g	PCS	G.W. KGS	CUFT 
					inner/ctn		
0512	3/16	1/4"	140	50	20 / 240	12.5	0.30
0516	1/4	1/4"	140	50	20 / 240	13.0	0.30
0520	5/16	1/4"	140	50	20 / 240	13.0	0.30
0522	11/32	1/4"	140	50	20 / 240	13.0	0.30
0524	3/8	1/4"	140	55	10 / 120	7.5	0.30
0528	7/16	1/4"	140	60	10 / 120	8.5	0.30
0532	1/2	1/4"	140	70	10 / 120	9.0	0.30



6 pt.





6 pt.

## NB-021M 21 Piece Metric Hex Nut Driver & Bit Set

Item No.	Size	Item No.	Size
<b>Screwdriver Bit, 125mmL:</b>			
2625	2.5mm Hex	2636	6mm Hex
2633	3mm Hex	2647	7mm Hex
2634	4mm Hex	2648	8mm Hex
2635	5mm Hex		
<b>Metric Hex Nut Driver, 140mmL:</b>			
0444	4mm	0459	9mm
0445	5mm	0460	10mm
0455	5.5mm	0461	11mm
0456	6mm	0462	12mm
0457	7mm	0463	13mm
0458	8mm	0464	14mm

### Accessory:

- 280120 OMNIDRIVE® 3in1 Handgrip
- 524+2983 Ratcheting Screwdriver, 162mmL
- Blow Case

 1800 g       6 sets / 11.8 Kgs / 1.12 CUFT



6 pt.

## ND-020MS 20 Piece Metric & SAE Hex Nut Driver Set

Item No.	Size	Item No.	Size
<b>Hex Nut Driver, 140mmL:</b>			
0444	4mm	0463	13mm
0445	5mm	0464	14mm
0455	5.5mm	0512	3/16"
0456	6mm	0516	1/4"
0457	7mm	0520	5/16"
0458	8mm	0522	11/32"
0459	9mm	0524	3/8"
0460	10mm	0528	7/16"
0461	11mm	0532	1/2"
0462	12mm		

### Accessory:

- 524+2983 Ratcheting Screwdriver, 162mmL
- Blow Case

 1800 g       6 sets / 11.8 Kgs / 1.12 CUFT



6 pt.

**GENIUS**®

*Air Tools*



**GENIUS TOOLS**  
[www.geniustools.net](http://www.geniustools.net)

1/4

3/8

1/2

## 205051X 1/4" Dr. Stubby Standard Duty Air Ratchet

### Specifications:

Air Pressure	90 psig / 620 kpa
Max. Torque	20 ft. lbs. / 27 Nm
Free Speed	240 rpm
Overall Length	8 in. / 200 mm
Avg. Air Consumption	2.5 cfm
Air Inlet	1/4 in.
Minimum Hose Size	3/8 in. / 10 mm

600 g

20 pcs / 12.7 Kgs / 0.5 CUFT



1/4

## 305052X 3/8" Dr. Heavy Duty Air Ratchet

### Specifications:

Air Pressure	90 psig / 620 kpa
Max. Torque	50 ft. lbs. / 68 Nm
Free Speed	160 rpm
Overall Length	10.2 in. / 260 mm
Avg. Air Consumption	4.0 cfm
Air Inlet	1/4 in.
Minimum Hose Size	3/8 in. / 10 mm

1200 g

20 pcs / 25 Kgs / 0.78 CUFT



3/8

## 405053X 1/2" Dr. Heavy Duty Air Ratchet

### Specifications:

Air Pressure	90 psig / 620 kpa
Max. Torque	50 ft. lbs. / 68 Nm
Free Speed	160 rpm
Overall Length	10.2 in. / 260 mm
Avg. Air Consumption	4.0 cfm
Air Inlet	1/4 in.
Minimum Hose Size	3/8 in. / 10 mm

1200 g

20 pcs / 25 Kgs / 0.78 CUFT



1/2

## 405054X 1/2" Dr. Super Duty Air Ratchet

### Specifications:

Air Pressure	90 psig / 620 kpa
Max. Torque	90 ft. lbs. / 122 Nm
Free Speed	150 rpm
Overall Length	14.2 in. / 360 mm
Avg. Air Consumption	4.0 cfm
Air Inlet	1/4 in.
Minimum Hose Size	3/8 in. / 10 mm

2000 g

10 pcs / 21.5 Kgs / 0.57 CUFT



1/2



# Air Impact Wrenches

## 300450 3/8" Dr. Super Duty Lightweight Mini Air Impact Wrench

### Specifications:

Air Pressure	90 psig / 620 kpa
Max. Torque	450 ft. lbs. / 610 Nm
Free Speed	11,000 rpm
Overall Length	3.9 in. / 99 mm
Avg. Air Consumption	3.2 cfm
Air Inlet	1/4 in.
Minimum Hose Size	3/8 in. / 10 mm
Machine Design	Jumbo Hammer

1340 g      10 pcs / 16 Kgs / 0.9 CUFT

**450**  
FT.-LBS.

**1.3**  
KGS  
Lightweight



## 300300G 3/8" Dr. Air Impact Wrench

### Specifications:

Air Pressure	90 psig / 620 kpa
Max. Torque	115 ft. lbs. / 160 Nm
Free Speed	9,500 rpm
Overall Length	5.9 in. / 150 mm
Avg. Air Consumption	3.0 cfm
Air Inlet	1/4 in.
Minimum Hose Size	3/8 in. / 10 mm
Machine Design	Rocking Dog

1350 g      10 pcs / 16 Kgs / 0.65 CUFT

**115**  
FT.-LBS.



## TF-316M1 16 Piece 3/8" Dr. Metric Air Impact Wrench Set

Item No.	Size	Item No.	Size
<b>300300G</b>	<b>3/8" Dr. Air Impact Wrench, 115 ft. lbs. / 160 Nm</b>		
<b>3/8" Dr. 6pt Impact Socket (CR-V):</b>			
313008	8mm	313014	14mm
313010	10mm	313016	16mm
313011	11mm	313017	17mm
313012	12mm	313019	19mm
313013	13mm	313021	21mm

### Accessory:

700180	1/4" Mini Oiler	310003	3/8" Dr. Extension Bar, 75mmL
700182	Oil Pot	570740	4mm Hex Key Wrench
700183	1/4" Air Nipple		Blow Case

3000 g      6 sets / 18.5 Kgs / 1.5 CUFT



## TF-316S1 16 Piece 3/8" Dr. SAE Air Impact Wrench Set

Item No.	Size	Item No.	Size
<b>300300G</b>	<b>3/8" Dr. Air Impact Wrench, 115 ft. lbs. / 160 Nm</b>		
<b>3/8" Dr. 6pt Impact Socket (CR-V):</b>			
393010	5/16"	393020	5/8"
393012	3/8"	393022	11/16"
393014	7/16"	393024	3/4"
393016	1/2"	393026	13/16"
393018	9/16"	393028	7/8"

### Accessory:

700180	1/4" Mini Oiler	310003	3/8" Dr. Extension Bar, 3"L
700182	Oil Pot	570740	4mm Hex Key Wrench
700183	1/4" Air Nipple		Blow Case

3000 g      6 sets / 18.5 Kgs / 1.5 CUFT



# Air Impact Wrenches

3/8 1/2

## 300200 3/8" Dr. Super Duty Air Impact Wrench

### Specifications:

Air Pressure	90 psig / 620 kpa
Max. Torque	200 ft. lbs. / 271 Nm
Free Speed	10,000 rpm
Overall Length	5.5 in. / 140 mm
Avg. Air Consumption	2.5 cfm
Air Inlet	1/4 in.
Minimum Hose Size	3/8 in. / 10 mm
Machine Design	Jumbo Hammer

1350 g 12 pcs / 19.5 Kgs / 1.24 CUFT

200  
FT.-LBS.



3/8

## 300350 3/8" Dr. Super Duty Air Impact Wrench

### Specifications:

Air Pressure	90 psig / 620 kpa
Max. Torque	300 ft. lbs. / 407 Nm
Free Speed	11,000 rpm
Overall Length	5.6 in. / 142 mm
Avg. Air Consumption	3.2 cfm
Air Inlet	1/4 in.
Minimum Hose Size	3/8 in. / 10 mm
Machine Design	Twin Hammer

1600 g 10 pcs / 17 Kgs / 0.7 CUFT

300  
FT.-LBS.



3/8

## 400230 1/2" Dr. Air Impact Wrench

### Specifications:

Air Pressure	90 psig / 620 kpa
Max. Torque	230 ft. lbs. / 312 Nm
Free Speed	7,000 rpm
Overall Length	7.3 in. / 185 mm
Avg. Air Consumption	4.5 cfm
Air Inlet	1/4 in.
Minimum Hose Size	3/8 in. / 10 mm
Machine Design	Rocking Dog Hammer

2200 g 10 pcs / 24.6 Kgs / 1.5 CUFT

230  
FT.-LBS.



1/2

## TF-416K1 16 Piece 1/2" Dr. Metric Air Impact Wrench Set

Item No.	Size	Item No.	Size
400230	1/2" Dr. Air Impact Wrench, 230 ft. lbs. / 312 Nm		

### 1/2" Dr. 6pt Impact Socket (CR-V):

413809	9mm	413817	17mm
413810	10mm	413819	19mm
413811	11mm	413822	22mm
413813	13mm	413824	24mm
413814	14mm	413827	27mm

### Accessory:

700180	1/4" Mini Oiler	410005	1/2" Dr. Extension Bar, 125mmL
700182	Oil Pot	570740	4mm Hex Key Wrench
700183	1/4" Air Nipple		Blow Case

4300 g 4 sets / 18 Kgs / 1.4 CUFT



1/2





# Air Impact Wrench Sets

## TF-416S1 16 Piece 1/2" Dr. SAE Air Impact Wrench Set

Item No.	Size	Item No.	Size
<b>400230</b>	<b>1/2" Dr. Air Impact Wrench, 230 ft. lbs. / 312 Nm</b>		
<b>1/2" Dr. 6pt Impact Socket (CR-V):</b>			
493814	7/16"	493824	3/4"
493816	1/2"	493826	13/16"
493818	9/16"	493828	7/8"
493820	5/8"	493830	15/16"
493822	11/16"	493832	1"

### Accessory:

700180	1/4" Mini Oiler	410005	1/2" Dr. Extension Bar, 5"L
700182	Oil Pot	570740	4mm Hex Key Wrench
700183	1/4" Air Nipple		Blow Case

4300 g

4 sets / 18 Kgs / 1.4 CUFT



## GS-425K 27 Piece 1/2" Dr. Metric Air Impact Wrench Set

Item No.	Size	Item No.	Size
<b>400230</b>	<b>1/2" Dr. Air Impact Wrench, 230 ft. lbs. / 312 Nm</b>		
<b>1/2" Dr. 6pt Impact Socket (CR-Mo):</b>			
444008	8mm	444017	17mm
444009	9mm	444018	18mm
444010	10mm	444019	19mm
444011	11mm	444021	21mm
444012	12mm	444022	22mm
444013	13mm	444024	24mm
444014	14mm	444027	27mm
444015	15mm	444030	30mm
444016	16mm		

### Accessory:

340040B	Adapter, 3/8"F x 1/2"M	480075MB	1/2" Dr. Extension Bar, 75mmL
480033MB	Adapter, 1/2"F x 3/8"M	570740	4mm Hex Key Wrench
480066MB	Adapter, 1/2"F x 3/4"M	700180	1/4" Mini Oiler
640604B	Adapter, 3/4"F x 1/2"M	700183	1/4" Air Nipple
480040	1/2" Dr. Sliding T-Handle		Blow Case

7000 g

2 sets / 15.5Kgs / 1.42 CUFT



## GS-425KS 27 Piece 1/2" Dr. SAE Air Impact Wrench Set

Item No.	Size	Item No.	Size
<b>400230</b>	<b>1/2" Dr. Air Impact Wrench, 230 ft. lbs. / 312 Nm</b>		
<b>1/2" Dr. 6pt Impact Socket (CR-Mo):</b>			
464010	5/16"	464026	13/16"
464012	3/8"	464028	7/8"
464014	7/16"	464030	15/16"
464016	1/2"	464032	1"
464018	9/16"	464034	1-1/16"
464019	19/32"	464036	1-1/8"
464020	5/8"	464038	1-3/16"
464022	11/16"	464040	1-1/4"
464024	3/4"		

### Accessory:

340040B	Adapter, 3/8"F x 1/2"M	480075MB	1/2" Dr. Extension Bar, 3"L
480033MB	Adapter, 1/2"F x 3/8"M	570740	4mm Hex Key Wrench
480066MB	Adapter, 1/2"F x 3/4"M	700180	1/4" Mini Oiler
640604B	Adapter, 3/4"F x 1/2"M	700183	1/4" Air Nipple
480040	1/2" Dr. Sliding T-Handle		Blow Case

7000 g

2 sets / 15.5Kgs / 1.42 CUFT



## 400400G 1/2" Dr. Heavy Duty Air Impact Wrench

### Specifications:

Air Pressure	90 psig / 620 kpa
Max. Torque	380 ft. lbs. / 516 Nm
Free Speed	7,000 rpm
Overall Length	7.5 in. / 190 mm
Avg. Air Consumption	4.0 cfm
Air Inlet	1/4 in.
Minimum Hose Size	3/8 in. / 10 mm
Machine Design	Pin Clutch

 2700 g

 8 pcs / 24.1 Kgs / 1.32 CUFT

**380**  
FT.-LBS.



## 400401 1/2" Dr. Super Duty Lightweight Mini Air Impact Wrench

### Specifications:

Air Pressure	90 psig / 620 kpa
Max. Torque	400 ft. lbs. / 542 Nm
Free Speed	11,000 rpm
Overall Length	5.6 in / 142 mm
Avg. Air Consumption	3.2 cfm
Air Inlet	1/4 in.
Minimum Hose Size	3/8 in. / 10 mm
Machine Design	Twin Hammer

 1600 g

 10 pcs / 17 Kgs / 0.7 CUFT

**400**  
FT.-LBS.

**1.6**  
KGS  
Lightweight



## 400402 1/2" Dr. Super Duty Lightweight Mini Long Anvil Air Impact Wrench

### Specifications:

Air Pressure	90 psig / 620 kpa
Max. Torque	400 ft. lbs. / 542 Nm
Free Speed	11,000 rpm
Overall Length	7.6 in / 192 mm
Avg. Air Consumption	3.2 cfm
Air Inlet	1/4 in.
Minimum Hose Size	3/8 in. / 10 mm
Machine Design	Twin Hammer

 1700 g

 10 pcs / 19 Kgs / 0.75 CUFT

**400**  
FT.-LBS.

**1.7**  
KGS  
Lightweight



### Caution

- Proper use will extend the usage period 2 to 3 times.
- After oiling, remember to first pull the trigger for no longer than 2 seconds. Otherwise, it will seriously affect performance as well as shorten the life of the tool itself.
- Please add 2-3cc #R32 oil to grease the motor everyday before use.
- Please add 20-30cc #R40 oil to grease the impact set every 3 to 6 months.
- Do not drive or remove screws that would require the use of the unit for more than 5 seconds at one time. If the screws are rusty or too tight, please use other method to remove them.
- Please locate dust cover after using to extend the usage period.

1/2

# Air Impact Wrenches

## 400420 1/2" Dr. Super Duty Air Impact Wrench

### Specifications:

Air Pressure	90 psig / 620 kpa
Max. Torque	420 ft. lbs. / 570 Nm
Free Speed	7,000 rpm
Overall Length	7.3 in. / 185 mm
Avg. Air Consumption	4.2 cfm
Air Inlet	1/4 in.
Minimum Hose Size	3/8 in. / 10 mm
Machine Design	Twin Hammer

2700 g

2 pcs / 6.5 Kgs / 0.4 CUFT

**420**  
FT.-LBS.



## 400422 1/2" Dr. Super Duty Long Anvil Air Impact Wrench

### Specifications:

Air Pressure	90 psig / 620 kpa
Max. Torque	420 ft. lbs. / 570 Nm
Free Speed	7,000 rpm
Overall Length	9.3 in. / 235 mm
Avg. Air Consumption	4.2 cfm
Air Inlet	1/4 in.
Minimum Hose Size	3/8 in. / 10 mm
Machine Design	Twin Hammer

2800 g

2 pcs / 6.7 Kgs / 0.4 CUFT

**420**  
FT.-LBS.



## 400450 1/2" Dr. Super Duty Air Impact Wrench

### Specifications:

Air Pressure	90 psig / 620 kpa
Max. Torque	450 ft. lbs. / 610 Nm
Free Speed	8,000 rpm
Overall Length	7.3 in. / 185 mm
Avg. Air Consumption	4.5 cfm
Air Inlet	1/4 in.
Minimum Hose Size	3/8 in. / 10 mm
Machine Design	Twin Hammer

2700 g

6 pcs / 17.8 Kgs / 0.7 CUFT

**450**  
FT.-LBS.



## 400452 1/2" Dr. Super Duty Long Anvil Air Impact Wrench

### Specifications:

Air Pressure	90 psig / 620 kpa
Max. Torque	450 ft. lbs. / 610 Nm
Free Speed	8,000 rpm
Overall Length	9.3 in. / 235 mm
Avg. Air Consumption	4.5 cfm
Air Inlet	1/4 in.
Minimum Hose Size	3/8 in. / 10 mm
Machine Design	Twin Hammer

2800 g

6 pcs / 19 Kgs / 0.8 CUFT

**450**  
FT.-LBS.



## 400511 1/2" Dr. Super Duty Lightweight Mini Air Impact Wrench

### Specifications:

Air Pressure	90 psig / 620 kpa
Max. Torque	500 ft. lbs. / 678 Nm
Free Speed	11,000 rpm
Overall Length	3.9 in. / 99 mm
Avg. Air Consumption	3.2 cfm
Air Inlet	1/4 in.
Minimum Hose Size	3/8 in. / 10 mm
Machine Design	Jumbo Hammer

1340 g

10 pcs / 16 Kgs / 0.9 CUFT

500  
FT.-LBS.

1.3  
KGS  
Lightweight



## 400500 1/2" Dr. Super Duty Air Impact Wrench

### Specifications:

Air Pressure	90 psig / 620 kpa
Max. Torque	500 ft. lbs. / 678 Nm
Free Speed	7,000 rpm
Overall Length	7.6 in. / 190 mm
Avg. Air Consumption	5.4 cfm
Air Inlet	1/4 in.
Minimum Hose Size	3/8 in. / 10 mm
Machine Design	Twin Hammer

2900 g

6 pcs / 19.8 Kgs / 0.98 CUFT

500  
FT.-LBS.



## 400502 1/2" Dr. Super Duty Long Anvil Air Impact Wrench

### Specifications:

Air Pressure	90 psig / 620 kpa
Max. Torque	500 ft. lbs. / 678 Nm
Free Speed	7,000 rpm
Overall Length	9.6 in. / 245 mm
Avg. Air Consumption	5.4 cfm
Air Inlet	1/4 in.
Minimum Hose Size	3/8 in. / 10 mm
Machine Design	Twin Hammer

3000 g

2 pcs / 7 Kgs / 0.4 CUFT

500  
FT.-LBS.



### ⚠ Caution

- Proper use will extend the usage period 2 to 3 times.
- After oiling, remember to first pull the trigger for no longer than 2 seconds. Otherwise, it will seriously affect performance as well as shorten the life of the tool itself.
- Please add 2-3cc #R32 oil to grease the motor everyday before use.
- Please add 20-30cc #R40 oil to grease the impact set every 3 to 6 months.
- Do not drive or remove screws that would require the use of the unit for more than 5 seconds at one time. If the screws are rusty or too tight, please use other method to remove them.
- Please locate dust cover after using to extend the usage period.

**1/2**

# Air Impact Wrenches

## 4K0950 1/2" Dr. Ultra Duty Air Impact Wrench

### Specifications:

Air Pressure	90 psig / 620 kpa
Max. Torque	700 ft. lbs. / 950 Nm
Free Speed	8,000 rpm
Overall Length	7.6 in / 193 mm
Avg. Air Consumption	4.4 cfm
Air Inlet	1/4 in.
Minimum Hose Size	3/8 in. / 10 mm
Machine Design	Twin Hammer

 2100 g

 8 pcs / 19.5 Kgs / 1.3 CUFT
**700  
FT.-LBS.**

## 4K0952 1/2" Dr. Ultra Duty Long Anvil Air Impact Wrench

### Specifications:

Air Pressure	90 psig / 620 kpa
Max. Torque	700 ft. lbs. / 950 Nm
Free Speed	8,000 rpm
Overall Length	9.6 in / 243 mm
Avg. Air Consumption	4.4 cfm
Air Inlet	1/4 in.
Minimum Hose Size	3/8 in. / 10 mm
Machine Design	Twin Hammer

 2200 g

 8 pcs / 21 Kgs / 1.8 CUFT
**700  
FT.-LBS.**

## 400800 1/2" Dr. Ultra Duty Air Impact Wrench

### Specifications:

Air Pressure	90 psig / 620 kpa
Max. Torque	800 ft. lbs. / 1,085 Nm
Free Speed	7,500 rpm
Overall Length	6.5 in. / 165 mm
Avg. Air Consumption	4.5 cfm
Air Inlet	1/4 in.
Minimum Hose Size	3/8 in. / 10 mm
Machine Design	Twin Hammer

 2700 g

 6 pcs / 17 Kgs / 0.7 CUFT
**800  
FT.-LBS.**

## 400802 1/2" Dr. Ultra Duty Long Anvil Air Impact Wrench

### Specifications:

Air Pressure	90 psig / 620 kpa
Max. Torque	800 ft. lbs. / 1,085 Nm
Free Speed	7,500 rpm
Overall Length	8.5 in. / 215 mm
Avg. Air Consumption	4.5 cfm
Air Inlet	1/4 in.
Minimum Hose Size	3/8 in. / 10 mm
Machine Design	Twin Hammer

 2850 g

 6 pcs / 18 Kgs / 0.8 CUFT
**800  
FT.-LBS.**

## 600750 3/4" Dr. Heavy Duty Air Impact Wrench

### Specifications:

Air Pressure	90 psig / 620 kpa
Max. Torque	750 ft. lbs. / 1,016 Nm
Free Speed	6,500 rpm
Overall Length	9 in. / 230 mm
Avg. Air Consumption	7.0 cfm
Air Inlet	1/4 in.
Minimum Hose Size	3/8 in. / 10 mm
Machine Design	Twin Hammer

4550 g

4 pcs / 21 Kgs / 0.97 CUFT

750  
FT.-LBS.



## 600756 3/4" Dr. Heavy Duty Long Anvil Air Impact Wrench

### Specifications:

Air Pressure	90 psig / 620 kpa
Max. Torque	750 ft. lbs. / 1,016 Nm
Free Speed	6,500 rpm
Overall Length	14 in. / 355 mm
Avg. Air Consumption	7.0 cfm
Air Inlet	1/4 in.
Minimum Hose Size	3/8 in. / 10 mm
Machine Design	Twin Hammer

5200 g

2 pcs / 11.5 Kgs / 0.7 CUFT

750  
FT.-LBS.



## 600850 3/4" Dr. Super Duty Lightweight Air Impact Wrench

### Specifications:

Air Pressure	90 psig / 620 kpa
Max. Torque	850 ft. lbs. / 1,152 Nm
Free Speed	7,500 rpm
Overall Length	6.7 in. / 170 mm
Avg. Air Consumption	4.5 cfm
Air Inlet	1/4 in.
Minimum Hose Size	3/8 in. / 10 mm
Machine Design	Twin Hammer

2500 g

6 pcs / 17 Kgs / 0.7 CUFT

850  
FT.-LBS.

2.5  
KGS  
Lightweight



## 600856 3/4" Dr. Super Duty Lightweight Long Anvil Air Impact Wrench

### Specifications:

Air Pressure	90 psig / 620 kpa
Max. Torque	850 ft. lbs. / 1,152 Nm
Free Speed	7,500 rpm
Overall Length	12.8 in. / 325 mm
Avg. Air Consumption	4.5 cfm
Air Inlet	1/4 in.
Minimum Hose Size	3/8 in. / 10 mm
Machine Design	Twin Hammer

3100 g

6 pcs / 20 Kgs / 1.4 CUFT

850  
FT.-LBS.

3.1  
KGS  
Lightweight



**3/4**

# Air Impact Wrenches

## 600900G 3/4" Dr. Super Duty Air Impact Wrench

**Specifications:**

Air Pressure	90 psig / 620 kpa
Max. Torque	900 ft. lbs. / 1,220 Nm
Free Speed	4,600 rpm
Overall Length	9.6 in. / 245 mm
Avg. Air Consumption	7.5 cfm
Air Inlet	1/4 in.
Minimum Hose Size	3/8 in. / 10 mm
Machine Design	Pin Clutch

 4800 g

 4 pcs / 21 Kgs / 1.2 CUFT
**900**  
**FT.-LBS.**

## 601100 3/4" Dr. Super Duty Air Impact Wrench

**Specifications:**

Air Pressure	90 psig / 620 kpa
Max. Torque	1,100 ft. lbs. / 1,491 Nm
Free Speed	6,000 rpm
Overall Length	8.2 in. / 208 mm
Avg. Air Consumption	6.0 cfm
Air Inlet	1/4 in.
Minimum Hose Size	3/8 in. / 10 mm
Machine Design	Twin Hammer

 4100 g

 4 pcs / 18.6 Kgs / 0.85 CUFT
**1100**  
**FT.-LBS.**

## 601106 3/4" Dr. Super Duty Long Anvil Air Impact Wrench

**Specifications:**

Air Pressure	90 psig / 620 kpa
Max. Torque	1,100 ft. lbs. / 1,491 Nm
Free Speed	6,000 rpm
Overall Length	14.2 in. / 360 mm
Avg. Air Consumption	6.0 cfm
Air Inlet	1/4 in.
Minimum Hose Size	3/8 in. / 10 mm
Machine Design	Twin Hammer

 4700 g

 4 pcs / 21.5 Kgs / 1.3 CUFT
**1100**  
**FT.-LBS.**

## 6K1490 3/4" Dr. Ultra Duty Air Impact Wrench

**Specifications:**

Air Pressure	90 psig / 620 kpa
Max. Torque	1,100 ft. lbs. / 1,491 Nm
Free Speed	5,500 rpm
Overall Length	8.6 in. / 220 mm
Avg. Air Consumption	9.5 cfm
Air Inlet	3/8 in.
Minimum Hose Size	1/2 in. / 12.7 mm
Machine Design	Twim Hammer

 5600 g

 4 pcs / 24.5 Kgs / 1.24 CUFT
**1100**  
**FT.-LBS.**

## 601200G 3/4" Dr. Super Duty Air Impact Wrench

### Specifications:

Air Pressure	90 psig / 620 kpa
Max. Torque	1,200 ft. lbs. / 1,627 Nm
Free Speed	4,000 rpm
Overall Length	10 in. / 255 mm
Avg. Air Consumption	7.6 cfm
Air Inlet	3/8 in.
Minimum Hose Size	3/8 in. / 10 mm
Machine Design	Pin Clutch

5200 g

4 pcs / 23.5 Kgs / 1.23 CUFT

**1200**  
FT.-LBS.



## 601400 3/4" Dr. Ultra Duty Air Impact Wrench

### Specifications:

Air Pressure	90 psig / 620 kpa
Max. Torque	1,400 ft. lbs. / 1,898 Nm
Free Speed	4,500 rpm
Overall Length	8.5 in. / 215 mm
Avg. Air Consumption	9.0 cfm
Air Inlet	3/8 in.
Minimum Hose Size	3/8 in. / 10 mm
Machine Design	Twin Hammer

5000 g

4 pcs / 22 Kgs / 0.85 CUFT

**1400**  
FT.-LBS.



## 601406 3/4" Dr. Ultra Duty Long Anvil Air Impact Wrench

### Specifications:

Air Pressure	90 psig / 620 kpa
Max. Torque	1,400 ft. lbs. / 1,898 Nm
Free Speed	4,500 rpm
Overall Length	14.8 in. / 375 mm
Avg. Air Consumption	9.0 cfm
Air Inlet	3/8 in.
Minimum Hose Size	3/8 in. / 10 mm
Machine Design	Twin Hammer

6000 g

4 pcs / 26.5 Kgs / 1.3 CUFT

**1400**  
FT.-LBS.



### **Caution**

- Proper use will extend the usage period 2 to 3 times.
- After oiling, remember to first pull the trigger for no longer than 2 seconds. Otherwise, it will seriously affect performance as well as shorten the life of the tool itself.
- Please add 2-3cc #R32 oil to grease the motor everyday before use.
- Please add 20-30cc #R40 oil to grease the impact set every 3 to 6 months.
- Do not drive or remove screws that would require the use of the unit for more than 5 seconds at one time. If the screws are rusty or too tight, please use other method to remove them.
- Please locate dust cover after using to extend the usage period.



**801200 1" Dr. Heavy Duty Lightweight Air Impact Wrench****Specifications:**

Air Pressure	90 psig / 620 kpa
Max. Torque	1,200 ft. lbs. / 1,627 Nm
Free Speed	6,000 rpm
Overall Length	8.5 in. / 216 mm
Avg. Air Consumption	6.0 cfm
Air Inlet	1/4 in.
Minimum Hose Size	3/8 in. / 10 mm
Machine Design	Twin Hammer

 4200 g

 4 pcs / 19 Kgs / 0.85 CUFT

**1200**  
FT.-LBS.

**4.2**  
KGS  
Lightweight
**801206 1" Dr. Heavy Duty Lightweight Long Anvil Air Impact Wrench****Specifications:**

Air Pressure	90 psig / 620 kpa
Max. Torque	1,200 ft. lbs. / 1,627 Nm
Free Speed	6,000 rpm
Overall Length	14.5 in. / 368 mm
Avg. Air Consumption	6.0 cfm
Air Inlet	1/4 in.
Minimum Hose Size	3/8 in. / 10 mm
Machine Design	Twin Hammer

 5100 g

 4 pcs / 23 Kgs / 1.3 CUFT

**1200**  
FT.-LBS.

**5.1**  
KGS  
Lightweight
**8K1630 1" Dr. Ultra Duty Air Impact Wrench****Specifications:**

Air Pressure	90 psig / 620 kpa
Max. Torque	1,200 ft. lbs. / 1,627 Nm
Free Speed	5,500 rpm
Overall Length	8.9 in. / 225 mm
Avg. Air Consumption	9.5 cfm
Air Inlet	3/8 in.
Minimum Hose Size	1/2 in. / 12.7 mm
Machine Design	Twin Hammer

 6100 g

 4 pcs / 26.5 Kgs / 1.24 CUFT

**1200**  
FT.-LBS.
**8K1636 1" Dr. Ultra Duty Long Anvil Air Impact Wrench****Specifications:**

Air Pressure	90 psig / 620 kpa
Max. Torque	1,200 ft. lbs. / 1,627 Nm
Free Speed	5,500 rpm
Overall Length	14 in. / 356 mm
Avg. Air Consumption	9.5 cfm
Air Inlet	3/8 in.
Minimum Hose Size	1/2 in. / 12.7 mm
Machine Design	Twin Hammer

 6800 g

 4 pcs / 30 Kgs / 1.5 CUFT

**1200**  
FT.-LBS.

# Air Impact Wrenches

1"

## 801512 1" Dr. Super Duty Lightweight Air Impact Wrench

### Specifications:

Air Pressure	90 psig / 620 kpa
Max. Torque	1,500 ft. lbs. / 2,033 Nm
Free Speed	4,500 rpm
Overall Length	8.8 in. / 222 mm
Avg. Air Consumption	9.0 cfm
Air Inlet	3/8 in.
Minimum Hose Size	3/8 in. / 10 mm
Machine Design	Twin Hammer

5100 g

4 pcs / 22.5 Kgs / 0.85 CUFT

1500  
FT.-LBS.

5.1  
KGS  
Lightweight



## 801518 1" Dr. Super Duty Lightweight Long Anvil Air Impact Wrench

### Specifications:

Air Pressure	90 psig / 620 kpa
Max. Torque	1,500 ft. lbs. / 2,033 Nm
Free Speed	4,500 rpm
Overall Length	14.8 in. / 375 mm
Avg. Air Consumption	9.0 cfm
Air Inlet	3/8 in.
Minimum Hose Size	3/8 in. / 10 mm
Machine Design	Twin Hammer

6100 g

4 pcs / 27 Kgs / 1.3 CUFT

1500  
FT.-LBS.

6.1  
KGS  
Lightweight



## 801500 1" Dr. Air Impact Wrench

### Specifications:

Air Pressure	90 psig / 620 kpa
Max. Torque	1,500 ft. lbs. / 2,033 Nm
Free Speed	4,000 rpm
Overall Length	15.1 in. / 385 mm
Avg. Air Consumption	13.2 cfm
Air Inlet	1/2 in.
Minimum Hose Size	3/4 in. / 19 mm
Machine Design	Twin Hammer

9600 g

1 pc / 11.6 Kgs / 0.97 CUFT

1500  
FT.-LBS.



## 801506 1" Dr. Long Anvil Air Impact Wrench

### Specifications:

Air Pressure	90 psig / 620 kpa
Max. Torque	1,500 ft. lbs. / 2,033 Nm
Free Speed	4,000 rpm
Overall Length	20.6 in. / 525 mm
Avg. Air Consumption	13.2 cfm
Air Inlet	1/2 in.
Minimum Hose Size	3/4 in. / 19 mm
Machine Design	Twin Hammer

11 kg

1 pc / 13 Kgs / 0.97 CUFT

1500  
FT.-LBS.



## 801800 1" Dr. Super Duty Air Impact Wrench

**Specifications:**

Air Pressure	90 psig / 620 kpa
Max. Torque	1,800 ft. lbs. / 2,439 Nm
Free Speed	4,000 rpm
Overall Length	14.5 in. / 370 mm
Avg. Air Consumption	13.2 cfm
Air Inlet	1/2 in.
Minimum Hose Size	3/4 in. / 19 mm
Machine Design	Twin Hammer

11.5 10.5 kg

2 pcs / 25 Kgs / 1.8 CUFT

1800  
FT.-LBS.



## 801806 1" Dr. Super Duty Long Anvil Air Impact Wrench

**Specifications:**

Air Pressure	90 psig / 620 kpa
Max. Torque	1,800 ft. lbs. / 2,439 Nm
Free Speed	4,000 rpm
Overall Length	21.6 in. / 550 mm
Avg. Air Consumption	13.2 cfm
Air Inlet	1/2 in.
Minimum Hose Size	3/4 in. / 19 mm
Machine Design	Twin Hammer

12 Kg

1 pc / 14 Kgs / 0.97 CUFT

1800  
FT.-LBS.



## 802000 1" Dr. Super Duty Lightweight Air Impact Wrench

**Specifications:**

Air Pressure	90 psig / 620 kpa
Max. Torque	2,000 ft. lbs. / 2,712 Nm
Free Speed	5,000 rpm
Overall Length	13.6 in. / 345 mm
Avg. Air Consumption	9.0 cfm
Air Inlet	1/2 in.
Minimum Hose Size	3/4 in. / 19 mm
Machine Design	Twin Hammer

7300 g

2 pcs / 17.5 Kgs / 1.3 CUFT

2000  
FT.-LBS.

7.3  
KGS  
Lightweight



## 802006 1" Dr. Super Duty Lightweight Long Anvi Air Impact Wrench

**Specifications:**

Air Pressure	90 psig / 620 kpa
Max. Torque	2,000 ft. lbs. / 2,712 Nm
Free Speed	5,000 rpm
Overall Length	19.1 in. / 485 mm
Avg. Air Consumption	9.0 cfm
Air Inlet	1/2 in.
Minimum Hose Size	3/4 in. / 19 mm
Machine Design	Twin Hammer

8300 g

2 pcs / 19.5 Kgs / 1.3 CUFT

2000  
FT.-LBS.

8.3  
KGS  
Lightweight



## 8K3390 1" Dr. Ultra Duty Air Impact Wrench

### Specifications:

Air Pressure	90 psig / 620 kpa
Max. Torque	2,500 ft. lbs. / 3,390 Nm
Free Speed	3,000 rpm
Overall Length	17 in. / 432 mm
Avg. Air Consumption	14.5 cfm
Air Inlet	1/2 in.
Minimum Hose Size	3/4 in. / 19 mm
Machine Design	Twin Hammer

 15.5 kg

 1 pc / 18 Kgs / 1.5 CUFT

**2500**  
~~FT.-LBS.~~



## 8K3398 1" Dr. Ultra Duty Long Anvil Air Impact Wrench

### Specifications:

Air Pressure	90 psig / 620 kpa
Max. Torque	2,500 ft. lbs. / 3,390 Nm
Free Speed	3,000 rpm
Overall Length	24.8 in. / 630 mm
Avg. Air Consumption	14.5 cfm
Air Inlet	1/2 in.
Minimum Hose Size	3/4 in. / 19 mm
Machine Design	Twin Hammer

 17 Kg

 1 pc / 19.5 Kgs / 1.5 CUFT

**2500**  
~~FT.-LBS.~~



### **Caution**

- Proper use will extend the usage period 2 to 3 times.
- After oiling, remember to first pull the trigger for no longer than 2 seconds. Otherwise, it will seriously affect performance as well as shorten the life of the tool itself.
- Please add 2-3cc #R32 oil to grease the motor everyday before use.
- Please add 20-30cc #R40 oil to grease the impact set every 3 to 6 months.
- Do not drive or remove screws that would require the use of the unit for more than 5 seconds at one time. If the screws are rusty or too tight, please use other method to remove them.
- Please locate dust cover after using to extend the usage period.

**1 1/2"**

# Air Impact Wrenches

## 9K3390 1-1/2" Dr. Ultra Duty Air Impact Wrench

**Specifications:**

Air Pressure	90 psig / 620 kpa
Max. Torque	2,500 ft. lbs. / 3,390 Nm
Free Speed	3,000 rpm
Overall Length	18 in. / 455 mm
Avg. Air Consumption	14.5 cfm
Air Inlet	1/2 in.
Minimum Hose Size	3/4 in. / 19 mm
Machine Design	Twin Hammer

 16.3 kg

 1 pc / 18.8 Kgs / 1.5 CUFT
**2500**  
FT.-LBS.

## 9K3398 1-1/2" Dr. Ultra Duty Long Anvil Air Impact Wrench

**Specifications:**

Air Pressure	90 psig / 620 kpa
Max. Torque	2,500 ft. lbs. / 3,390 Nm
Free Speed	3,000 rpm
Overall Length	23.8 in. / 605 mm
Avg. Air Consumption	14.5 cfm
Air Inlet	1/2 in.
Minimum Hose Size	3/4 in. / 19 mm
Machine Design	Twin Hammer

 18.7 kg

 1 pc / 21.2 Kgs / 1.5 CUFT
**2500**  
FT.-LBS.

## 9K4070 1-1/2" Dr. Ultra Duty Air Impact Wrench

**Specifications:**

Air Pressure	90 psig / 620 kpa
Max. Torque	3,000 ft. lbs. / 4,070 Nm
Free Speed	3,000 rpm
Overall Length	18.5 in. / 470 mm
Avg. Air Consumption	16 cfm
Air Inlet	1/2 in.
Minimum Hose Size	3/4 in. / 19 mm
Machine Design	Twin Hammer

 17 kg

 1 pc / 19.5 Kgs / 1.5 CUFT
**3000**  
FT.-LBS.

## 9K4078 1-1/2" Dr. Ultra Duty Long Anvil Air Impact Wrench

**Specifications:**

Air Pressure	90 psig / 620 kpa
Max. Torque	3,000 ft. lbs. / 4,070 Nm
Free Speed	3,000 rpm
Overall Length	25.6 in. / 650 mm
Avg. Air Consumption	16 cfm
Air Inlet	1/2 in.
Minimum Hose Size	3/4 in. / 19 mm
Machine Design	Twin Hammer

 20 kg

 1 pc / 22.5 Kgs / 1.5 CUFT
**3000**  
FT.-LBS.

# Air Impact Wrenches

1 1/2

#5

## 943000 1-1/2" Dr. Super Duty Air Impact Wrench

### Specifications:

Air Pressure	90 psig / 620 kpa
Max. Torque	3,000 ft. lbs. / 4,068 Nm
Free Speed	3,700 rpm
Overall Length	19.3 in. / 490 mm
Avg. Air Consumption	14.7 cfm
Air Inlet	1/2 in.
Minimum Hose Size	3/4 in. / 19 mm
Machine Design	Twin Hammer

14.9 Kg 1 pc / 17.7 Kgs / 1.32 CUFT

3000  
FT.-LBS.



1 1/2

## 943008 1-1/2" Dr. Super Duty Long Anvil Air Impact Wrench

### Specifications:

Air Pressure	90 psig / 620 kpa
Max. Torque	3,000 ft. lbs. / 4,068 Nm
Free Speed	3,700 rpm
Overall Length	27.2 in. / 690 mm
Avg. Air Consumption	14.7 cfm
Air Inlet	1/2 in.
Minimum Hose Size	3/4 in. / 19 mm
Machine Design	Twin Hammer

17.2 Kg 1 pc / 20 Kgs / 1.32 CUFT

3000  
FT.-LBS.



1 1/2

## 501800 #5 Spline Dr. Super Duty Air Impact Wrench

### Specifications:

Air Pressure	90 psig / 620 kpa
Max. Torque	1,800 ft. lbs. / 2,439 Nm
Free Speed	4,000 rpm
Overall Length	14.5 in. / 370 mm
Avg. Air Consumption	13.2 cfm
Air Inlet	1/2 in.
Minimum Hose Size	3/4 in. / 19 mm
Machine Design	Twin Hammer

10.5 Kg 1 pc / 12.5 Kgs / 0.97 CUFT

1800  
FT.-LBS.



#5

## 501806 #5 Spline Dr. Super Duty Long Anvil Air Impact Wrench

### Specifications:

Air Pressure	90 psig / 620 kpa
Max. Torque	1,800 ft. lbs. / 2,439 Nm
Free Speed	4,000 rpm
Overall Length	21.6 in. / 550 mm
Avg. Air Consumption	13.2 cfm
Air Inlet	1/2 in.
Minimum Hose Size	3/4 in. / 19 mm
Machine Design	Twin Hammer

12.5 Kg 1 pc / 14.5 Kgs / 0.97 CUFT

1800  
FT.-LBS.



#5

# Air Screwdrivers & Air Grinders

## 213000 Air Screwdriver (5H)

### Specifications:

Chuck Size	1/4"
Free Speed	13,000 rpm
Max. Torque	73 ft. lbs. / 100 Nm
Capacity	5H (4~6 mm)
Overall Length	7.3 in. / 185 mm
Avg. Air Consumption	2.4 cfm
Air Inlet	1/4 in.
Minimum Hose Size	3/8 in. / 10 mm

730 g

20 pcs / 17 Kgs / 0.96 CUFT



## 211000 Air Screwdriver (8H)

### Specifications:

Chuck Size	1/4"
Free Speed	11,000 rpm
Max. Torque	103 ft. lbs. / 140 Nm
Capacity	8H (6~10 mm)
Overall Length	8.3 in. / 210 mm
Avg. Air Consumption	3.4 cfm
Air Inlet	1/4 in.
Minimum Hose Size	3/8 in. / 10 mm

1050 g

12 pcs / 14.5 Kgs / 0.6 CUFT



## 505506 5" Air Angle Grinder

### Specifications:

Spindle Thread	M14 x 2.0P
Free Speed	12,000 rpm
Horse Power	1.0 HP
Overall Length	9 in. / 228 mm
Avg. Air Consumption	6 cfm
Air Inlet	1/4 in.
Minimum Hose Size	3/8 in. / 10 mm

1800 g

12 pcs / 26 Kgs / 1.8 CUFT



## 505105 5" Heavy Duty Air Angle Grinder

### Specifications:

Spindle Thread	M14 x 2.0P
Free Speed	11,000 rpm
Horse Power	1.4 HP
Overall Length	10 in. / 250 mm
Avg. Air Consumption	6 cfm
Air Inlet	1/4 in.
Minimum Hose Size	3/8 in. / 10 mm

2100 g

10 pcs / 26 Kgs / 2.37 CUFT



# Air Grinders

## 125032 (125036) Mini Air Die Grinders

### Specifications:

Collect Size	1/4" (125032) 6mm (125036)
Free Speed	25,000 rpm
Horse Power	0.3 HP
Overall Length	6.1 in. / 155 mm
Avg. Air Consumption	2.6 cfm
Air Inlet	1/4 in.
Minimum Hose Size	3/8 in. / 10 mm

⚖️ 440 g

📦 12 pcs / 8 Kgs / 0.8 CUFT



## 122052 (122056) Air Die Grinders

### Specifications:

Collect Size	1/4" (122052) 6mm (122056)
Free Speed	22,000 rpm
Horse Power	0.5 HP
Overall Length	7 in. / 178 mm
Avg. Air Consumption	3.5 cfm
Air Inlet	1/4 in.
Minimum Hose Size	3/8 in. / 10 mm

⚖️ 600 g

📦 12 pcs / 9.5 Kgs / 0.8 CUFT



## 122552 (122556) 5" Extension Air Die Grinders

### Specifications:

Collect Size	1/4" (122552) 6mm (122556)
Free Speed	22,000 rpm
Horse Power	0.5 HP
Overall Length	11 in. / 280 mm
Avg. Air Consumption	3.5 cfm
Air Inlet	1/4 in.
Minimum Hose Size	3/8 in. / 10 mm

⚖️ 770 g

📦 12 pcs / 12.5 Kgs / 1.1 CUFT



## 103652 (103656) Low Speed Air Die Grinders

### Specifications:

Collect Size	1/4" (103652) 6mm (103656)
Free Speed	3,600 rpm
Horse Power	0.5 HP
Overall Length	8.3 in. / 210 mm
Avg. Air Consumption	3.5 cfm
Air Inlet	1/4 in.
Minimum Hose Size	3/8 in. / 10 mm

⚖️ 700 g

📦 12 pcs / 11.5 Kgs / 1.1 CUFT







## 120032 (120036) Mini Air Angle Die Grinders (90°)

### Specifications:

Collect Size	1/4" (120032) 6mm (120036)
Free Speed	20,000 rpm
Horse Power	0.3 HP
Overall Length	6.1 in. / 155 mm
Avg. Air Consumption	2.6 cfm
Air Inlet	1/4 in.
Minimum Hose Size	3/8 in. / 10 mm

 530 g

 12 pcs / 9 Kgs / 0.8 CUFT



## 118952 (118956) Air Angle Die Grinders (90°)

### Specifications:

Collect Size	1/4" (118952) 6mm (118956)
Free Speed	18,000 rpm
Horse Power	0.5 HP
Overall Length	7 in. / 178 mm
Avg. Air Consumption	3.5 cfm
Air Inlet	1/4 in.
Minimum Hose Size	3/8 in. / 10 mm

 730 g

 12 pcs / 11.5 Kgs / 0.8 CUFT



## 118152 (118156) Air Angle Die Grinders (115°)

### Specifications:

Collect Size	1/4" (118152) 6mm (118156)
Free Speed	18,000 rpm
Horse Power	0.5 HP
Overall Length	8 in. / 200 mm
Avg. Air Consumption	3.5 cfm
Air Inlet	1/4 in.
Minimum Hose Size	3/8 in. / 10 mm

 730 g

 12 pcs / 11.5 Kgs / 0.8 CUFT



## 11505A 2" Air Angle Grinder (90°)

### Specifications:

Grinding Wheel	2" (50mm)
Free Speed	15,000 rpm
Horse Power	0.5 HP
Overall Length	7.1 in. / 180 mm
Avg. Air Consumption	3.5 cfm
Air Inlet	1/4 in.
Minimum Hose Size	3/8 in. / 10 mm

 760 g

 12 pcs / 12.5 Kgs / 1.5 CUFT



# Air Grinders & Air Riveters

## 560210 Air Micro Die Grinder

### Specifications:

Air Pressure	90 psig / 620 kpa
Collect Size	3mm
Free Speed	60,000 rpm
Exhaust Type	Rear
Tool Length	5.1 in. / 130 mm
Hose Length	59 in. / 1,500 mm
Avg. Air Consumption	2.5 cfm
Air Inlet	1/4 in.
Minimum Hose Size	3/8 in. / 10 mm

300 g

20 pcs / 8.5 Kgs / 1.2 CUFT



## 156000 Air Micro Die Grinder

### Specifications:

Air Pressure	90 psig / 620 kpa
Collect Size	3mm
Free Speed	56,000 rpm
Exhaust Type	Rear
Tool Length	5.3 in. / 135 mm
Hose Length	59 in. / 1,500 mm
Avg. Air Consumption	2.5 cfm
Air Inlet	1/4 in.
Minimum Hose Size	3/8 in. / 10 mm

360 g

12 pcs / 5 Kgs / 0.52 CUFT



## DG-1516 16 Piece Air Micro Die Grinder Set

### Contents:

- Air Micro Die Grinder (**156000**)
- 1/4" Air Oil Lubricator
- 1/4" Coupler Fitting Plug
- Mounted Point x 10 pcs
- Oil Pot
- Wrench x 2 pcs

800 g

8 sets / 7.4 Kgs / 1.16 CUFT



## 501300 Super Duty Air Riveter

### Specifications:

Air Pressure	90 psig / 620 kpa
Traction Power	1,300 lbs. / 5,782 n
Stroke	19mm (3/4")
4 Nosepiece	3/32"(2.4mm), 1/8"(3.2mm) 5/32"(4.0mm), 3/16"(4.8mm)
Avg. Air Consumption	3.8 cfm
Air Inlet	1/4 in.
Minimum Hose Size	3/8 in. / 10 mm

1270 g



10 pcs / 15.5 Kgs / 1.5 CUFT



## 501600 Super Duty Air Riveter

### Specifications:

Air Pressure	90 psig / 620 kpa
Traction Power	1,600 lbs. / 7,116 n
Stroke	19mm (3/4")
4 Nosepiece	3/32"(2.4mm), 1/8"(3.2mm), 5/32"(4.0mm), 3/16"(4.8mm)
Avg. Air Consumption	3.8 cfm
Air Inlet	1/4 in.
Minimum Hose Size	3/8 in. / 10 mm



 1530 g       10 pcs / 18.5 Kgs / 1.84 CUFT



## 501940 Super Duty Air Riveter

### Specifications:

Air Pressure	90 psig / 620 kpa
Traction Power	1,940 lbs. / 8,629 n
Stroke	14mm (9/16")
4 Nosepiece	3/32"(2.4mm), 1/8"(3.2mm), 5/32"(4.0mm), 3/16"(4.8mm)
Avg. Air Consumption	4 cfm
Air Inlet	1/4 in.
Minimum Hose Size	3/8 in. / 10 mm



 1600 g       10 pcs / 18.5 Kgs / 1.6 CUFT



## 501990 Heavy Duty Air Riveter

### Specifications:

Air Pressure	90 psig / 620 kpa
Traction Power	1,983 lbs. / 8,820 n
Stroke	16mm (5/8")
3 Nosepiece	1/8"(3.2mm), 5/32"(4.0mm), 3/16"(4.8mm)
Avg. Air Consumption	4 cfm
Air Inlet	1/4 in.
Minimum Hose Size	3/8 in. / 10 mm



 1700 g       10 pcs / 22 Kgs / 2.5 CUFT



## 503100 Ultra Duty Air Riveter

### Specifications:

Air Pressure	90 psig / 620 kpa
Traction Power	3,099 lbs. / 13,784 n
Stroke	19mm (3/4")
3 Nosepiece	3/32"(2.4mm), 1/8"(3.2mm), 5/32"(4.0mm), 3/16"(4.8mm), 7/32"(5.6mm), 1/4"(6.4mm)
Avg. Air Consumption	4 cfm
Air Inlet	1/4 in.
Minimum Hose Size	3/8 in. / 10 mm

 2250 g       10 pcs / 28.5 Kgs / 3.3 CUFT



## 351800 Air Reversible Drill (Keyless)

### Specifications:

Chuck Size	3/8" (10 mm)
Free Speed	1,800 rpm
Horse Power	0.5 HP
Overall Length	7.6 in. / 195 mm
Avg. Air Consumption	4 cfm
Air Inlet	1/4 in.
Minimum Hose Size	3/8 in. / 10 mm

940 g 10 pcs / 11.5 Kgs / 0.78 CUFT



## 351801 Air Reversible Drill

### Specifications:

Chuck Size	3/8" (10 mm)
Free Speed	1,800 rpm
Horse Power	0.5 HP
Overall Length	7.6 in. / 195 mm
Avg. Air Consumption	4 cfm
Air Inlet	1/4 in.
Minimum Hose Size	3/8 in. / 10 mm

940 g 10 pcs / 11.5 Kgs / 0.78 CUFT



## 102638 Air Drill

### Specifications:

Chuck Size	3/8" (10 mm)
Free Speed	2,600 rpm
Horse Power	0.5 HP
Overall Length	8.8 in. / 225 mm
Avg. Air Consumption	3.5 cfm
Air Inlet	1/4 in.
Minimum Hose Size	3/8 in. / 10 mm

800 g 12 pcs / 12 Kgs / 1.1 CUFT



## 102653 Air Drill (keyless)

### Specifications:

Chuck Size	3/8" (10 mm)
Free Speed	2,600 rpm
Horse Power	0.5 HP
Overall Length	8.8 in. / 225 mm
Avg. Air Consumption	3.5 cfm
Air Inlet	1/4 in.
Minimum Hose Size	3/8 in. / 10 mm

800 g 12 pcs / 12 Kgs / 1.1 CUFT



## 101853 Air Angle Drill (90°)

### Specifications:

Chuck Size	3/8" (10 mm)
Free Speed	1,800 rpm
Horse Power	0.5 HP
Overall Length	8 in. / 200 mm
Avg. Air Consumption	3.5 cfm
Air Inlet	1/4 in.
Minimum Hose Size	3/8 in. / 10 mm

1070 g 12 pcs / 15.5 Kgs / 0.8 CUFT



## AF-3406 6 Piece Air File Set

### Item No. Description

#### Air File Wrench

#### Air Files:

500861	Flat Type Air File
500862	Round Type Air File
500863	Half round Type Air File
500864	Square Type Air File
500865	Triangle Type Air File

#### Color Box

920 g

10 sets / 11.2 Kgs / 1.2 CUFT

#### Specifications:

Free speed	3,400 rpm
Air inlet	1/4 in.
Air pressure	90 psig
File shank dia.	5 mm
Stroke length	10 mm



## 12105C 3" Air Cutter

#### Specifications:

Cutting Wheel	3" (75mm)
Free Speed	21,000 rpm
Horse Power	0.5 HP
Overall Length	7.7 in. / 195 mm
Avg. Air Consumption	3.5 cfm
Air Inlet	1/4 in.
Minimum Hose Size	3/8 in. / 10 mm

760 g

12 pcs / 12.5 Kgs / 1.5 CUFT



## 10265E Air Eraser

#### Specifications:

Rubber Eraser	88 x 15 mm
Free Speed	2,600 rpm
Horse Power	0.5 HP
Overall Length	8.8 in. / 225 mm
Avg. Air Consumption	3.5 cfm
Air Inlet	1/4 in.
Minimum Hose Size	3/8 in. / 10 mm

830 g

12 pcs / 12.5 Kgs / 1.1 CUFT



## 502653 Air Tire Buffer

#### Specifications:

Free Speed	2,600 rpm
Horse Power	0.5 HP
Overall Length	9.5 in. / 240 mm
Avg. Air Consumption	3.5 cfm
Air Inlet	1/4 in.
Minimum Hose Size	3/8 in. / 10 mm

930 g

12 pcs / 13.5 Kgs / 1.1 CUFT



# Air Sanders

## Air Sanders (11,000 rpm)

ITEM NO.	Pad Dia. inch	Random Orbital	Vacuum Type	Weight g	PCS 	G.W. Kgs	CUFT 
13303N	3"	2.5mm	Non	560	10	9.0	1.7
13303C	3"	2.5mm	Central	600	10	9.5	1.7
13303S	3"	2.5mm	Self-Generated	830	6	8.0	2.0
15303N	5"	2.5mm	Non	740	10	11.0	1.7
15303C	5"	2.5mm	Central	800	10	11.5	1.7
15303S	5"	2.5mm	Self-Generated	1020	6	9.5	2.0
16303N	6"	2.5mm	Non	760	10	11.5	1.7
16303C	6"	2.5mm	Central	820	10	12.0	1.7
16303S	6"	2.5mm	Self-Generated	1040	6	9.5	2.0
15103N	5"	5mm	Non	770	10	11.5	1.7
15103C	5"	5mm	Central	830	10	12.0	1.7
15103S	5"	5mm	Self-Generated	1050	6	9.5	2.0
16103N	6"	5mm	Non	790	10	11.5	1.7
16103C	6"	5mm	Central	850	10	12.0	1.7
16103S	6"	5mm	Self-Generated	1070	6	9.5	2.0



(Non Vacuum Type)



(Central Vacuum Type)



(Self-Generated Vacuum Type)

## Air Gear-Driven Sanders (900 rpm)

ITEM NO.	Pad Dia. inch	Random Orbital	Vacuum Type	Weight g	PCS 	G.W. Kgs	CUFT 
15HGN5	5"	5mm	Non	1500	6	12.0	2.0
15HGC5	5"	5mm	Central	1500	6	12.0	2.0
15HGS5	5"	5mm	Self-Generated	1750	6	13.5	2.0
16HGN6	6"	5mm	Non	1600	6	12.5	2.0
16HGC6	6"	5mm	Central	1600	6	12.5	2.0
16HGS6	6"	5mm	Self-Generated	1850	6	14.0	2.0
18HGN8	8"	5mm	Non	1700	6	14.0	2.3
18HGC8	8"	5mm	Central	1700	6	14.0	2.3
18HGS8	8"	5mm	Self-Generated	1950	6	15.5	2.3



(Non Vacuum Type)





(Central Vacuum Type)



(Self-Generated Vacuum Type)

## Air Polisher Sanders

Item No.	Pad Dia. inch	Random Orbital	Free Speed rpm	Weight g	PCS 	G.W. Kgs	CUFT 
131013	3"	5mm	11,000	770	10	12.0	1.7
151015	5"	5mm	11,000	820	10	13.0	1.7
152HPS	5"	10mm	10,000	1300	6	10.5	2.0



(131013)





(151015)



(152HPS)

# Rust & Paint Removal Tools

## Rust & Paint Removal Tools (4,000 rpm)

Item No.	Vacuum Type	Weight g	PCS 	G.W. Kgs	CUFT 
14280A	Non	1200	10	15.0	1.74
14280C	Central	1360	4	9.0	2.10
14280S	Self-Generated	1600	4	10.0	2.10



(Non Vacuum Type)



(Central Vacuum Type)



(Self-Generated Vacuum Type)



### RP-280N 10 Piece Rust & Paint Removal Tool Set (Non-Vacuum Type)

#### Contents:

- Rust & Paint Removal Tool ([14280A](#))
- Rubber Eraser Wheel
- Stripping Wheel
- Wire Wheel x 3 pcs
- Eraser Adapter
- Nipple
- Hex Key
- Screw

 3200 g

 4 sets / 14.5 Kgs / 3 CUFT



### RP-280C 10 Piece Rust & Paint Removal Tool Set (Central-Vacuum Type)

#### Contents:

- Rust & Paint Removal Tool ([14280C](#))
- Rubber Eraser Wheel
- Stripping Wheel
- Wire Wheel x 3 pcs
- Eraser Adapter
- Nipple
- Hex Key
- Screw



 3350 g

 4 sets / 15 Kgs / 3 CUFT





# Air Spray Guns

## Mini Spray Guns (Gravity Type)

Item No.	Nozzle Size	Capacity Cup (C.C)	Weight g	PCS 	G.W. Kgs	CUFT 
155A05	Ø0.5mm	145	380	20	11	1.5
155A08	Ø0.8mm	145	380	20	11	1.5
155A10	Ø1.0mm	145	380	20	11	1.5



- Stainless steel nozzle and needle
- Used for spot repairing to medium painting job
- Pattern adjustable

## Mini Spray Gun (Gravity Type)

Item No.	Nozzle Size	Capacity Cup (C.C)	Weight g	PCS 	G.W. Kgs	CUFT 
155B05	Ø0.5mm	145	380	20	11	1.5



- Stainless steel nozzle and needle
- Used for spot repairing to medium painting job
- Fixed round pattern

## Mini Spray Guns (Gravity - HVLP Type)

Item No.	Nozzle Size	Capacity Cup (C.C)	Weight g	PCS 	G.W. Kgs	CUFT 
15HV05	Ø0.5mm	125	380	20	13	1.5
15HV08	Ø0.8mm	125	380	20	13	1.5
15HV10	Ø1.0mm	125	380	20	13	1.5



- Stainless steel nozzle and needle
- Used for spot repairing to medium painting job
- Less pollution to environment

## Spray Guns (Gravity Type)

Item No.	Nozzle Size	Capacity Cup (C.C)	Weight g	PCS 	G.W. Kgs	CUFT 
14GT12	Ø1.2mm	600	630	10	10.5	1.7
14GT14	Ø1.4mm	600	630	10	10.5	1.7
14GT16	Ø1.6mm	600	630	10	10.5	1.7
14GT18	Ø1.8mm	600	630	10	10.5	1.7

- Stainless steel nozzle and needle
- High transfer efficiency
- Lightweight

## Spray Guns (Suction Type)

Item No.	Nozzle Size	Capacity Cup (C.C)	Weight g	PCS 	G.W. Kgs	CUFT 
12ST10	Ø1.0mm	1000	980	10	14.5	2.2
12ST16	Ø1.6mm	1000	980	10	14.5	2.2
12ST18	Ø1.8mm	1000	980	10	14.5	2.2
12ST20	Ø2.0mm	1000	980	10	14.5	2.2

- Medium to large painting job





# Air Spray Guns & Air Blow Guns

## Spray Guns (Gravity - HVLP Type)

Item No.	Nozzle Size	Capacity Cup (C.C)	Weight g	PCS	G.W. Kgs	CUFT
10HV13	Ø1.3mm	600	650	10	10.5	1.7
10HV14	Ø1.4mm	600	650	10	10.5	1.7
10HV16	Ø1.6mm	600	650	10	10.5	1.7
10HV18	Ø1.8mm	600	650	10	10.5	1.7
10HV20	Ø2.0mm	600	650	10	10.5	1.7

- HVLP Type supplies high transfer efficiency: reduce overspray and save painting cost
- Forged Gun body and anodizing surface



## Spray Guns (Gravity - MP Type)

Item No.	Nozzle Size	Capacity Cup (C.C)	Weight g	PCS	G.W. Kgs	CUFT
10MP13	Ø1.3mm	600	650	10	10.5	1.7
10MP14	Ø1.4mm	600	650	10	10.5	1.7
10MP16	Ø1.6mm	600	650	10	10.5	1.7
10MP18	Ø1.8mm	600	650	10	10.5	1.7
10MP20	Ø2.0mm	600	650	10	10.5	1.7

- MP Type combines the advantages of HVLP and conventional spray gun: lower inlet pressure but high working rate
- Forged Gun body and anodizing surface



## Spray Gun (Gravity - BP Type)

Item No.	Nozzle Size	Capacity Cup (C.C)	Weight g	PCS	G.W. Kgs	CUFT
10BP25	Ø2.5mm	600	650	10	10.5	1.7

- BP Type is suitable for polyester, filler or other high viscosity material and can spray from small spots repairing to large surfaces
- Forged Gun body and anodizing surface



## Air Blow Guns

Item No.	Nozzle Type	Length mm	Weight g	PCS	G.W. KGS	CUFT
AJ-106S	Short	95	150	48	9.5	1.2
AJ-106L	Long	190	160	48	10.0	1.2
AJ-1062	S & L	95 & 190	170	48	10.5	1.2



AJ-106S



AJ-106L



AJ-1062



**GENIUS<sup>®</sup>**

*Wrenches &  
Torque Wrenches*



**GENIUS TOOLS**  
[www.geniustools.net](http://www.geniustools.net)

# Combination Wrenches

## Metric Combination Wrenches - Matt Finish

ITEM NO.	Size mm	Length mm	Weight g	PCS inner/ctn	G.W. KGS	CUFT 
726006	6	102	20	20 / 240	6.0	0.30
726007	7	107	25	20 / 240	6.5	0.30
726008	8	112	30	20 / 240	8.0	0.30
726009	9	123	35	20 / 240	9.0	0.39
726010	10	140	45	20 / 300	15.0	0.52
726011	11	150	65	20 / 300	20.5	0.52
726012	12	158	70	20 / 300	22.5	0.82
726013	13	171	80	10 / 150	13.0	0.52
726014	14	186	110	10 / 150	17.0	0.52
726015	15	198	130	10 / 150	21.0	0.52
726016	16	206	140	10 / 100	15.0	0.62
726017	17	224	180	10 / 100	19.0	0.62
726018	18	224	180	10 / 100	19.0	0.62
726019	19	248	230	5 / 60	15.0	0.52
726020	20	277	280	5 / 60	18.0	0.52
726021	21	277	280	5 / 60	18.0	0.52
726022	22	295	320	5 / 60	20.0	0.52
726023	23	295	320	5 / 60	20.0	0.52
726024	24	320	400	5 / 30	13.0	0.45
726025	25	330	410	5 / 30	13.0	0.45
726026	26	330	410	5 / 30	13.0	0.45
726027	27	355	515	5 / 30	16.5	0.45
726028	28	355	520	5 / 30	16.5	0.45
726029	29	375	650	1 / 20	14.0	0.43
726030	30	380	650	1 / 20	14.0	0.43
726032	32	412	780	1 / 20	16.5	0.43
726033	33	461	970	1 / 20	20.4	0.84
726034	34	461	970	5 / 20	20.4	0.84
726035	35	461	970	5 / 20	20.4	0.84
726036	36	486	1280	5 / 20	26.6	1.35
726038	38	486	1280	5 / 20	26.6	1.35
726040	40	540	1800	2 / 10	19.0	0.94
726041	41	540	1800	2 / 10	19.0	0.94
726042	42	540	1800	2 / 10	19.0	0.94
726045	45	611	1900	2 / 10	20.0	1.22
726046	46	611	1900	2 / 10	20.0	1.22
726050	50	611	2350	2 / 10	24.5	1.22
726055	55	666	4600	1 / 4	19.4	1.01
726060	60	760	6170	1 / 4	25.7	1.18
726065	65	760	6170	1 / 4	25.7	1.18

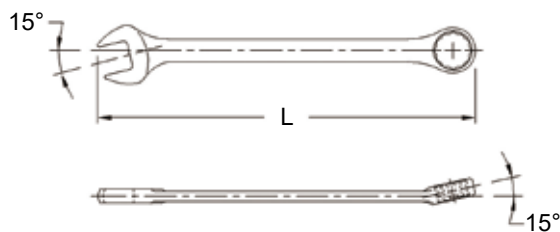

## HS-016M 16 Piece Metric Combination Wrench Set

Item No.	Size	Item No.	Size
<b>Combination Wrench (Matt Finish):</b>			
726006	6mm	726014	14mm
726007	7mm	726017	17mm
726008	8mm	726019	19mm
726009	9mm	726022	22mm
726010	10mm	726024	24mm
726011	11mm	726027	27mm
726012	12mm	726030	30mm
726013	13mm	726032	32mm

Pouch Bag

 4500 g

 4 sets / 19 Kgs / 0.82 CUFT



# Combination Wrenches

## SAE Combination Wrenches - Matt Finish

ITEM NO.	Size inch	Length mm	Weight g	PCS inner/ctn	G.W. KGS	CUFT
737008	1/4	102	20	20 / 240	6.0	0.30
737010	5/16	112	30	20 / 240	8.5	0.30
737012	3/8	140	45	20 / 240	12.0	0.38
737014	7/16	150	65	20 / 300	20.0	0.52
737016	1/2	171	95	10 / 150	15.0	0.52
737018	9/16	186	110	10 / 150	17.0	0.52
737020	5/8	206	150	10 / 100	16.5	0.62
737022	11/16	224	180	10 / 100	19.5	0.62
737024	3/4	248	230	5 / 60	15.0	0.52
737026	13/16	277	280	5 / 60	18.0	0.52
737028	7/8	295	320	5 / 60	20.0	0.52
737030	15/16	320	400	5 / 30	13.0	0.45
737032	1	330	410	5 / 30	13.3	0.45
737034	1-1/16	355	510	5 / 30	16.3	0.45
737036	1-1/8	378	675	1 / 20	14.5	0.43
737038	1-3/16	380	690	1 / 20	14.8	0.43
737040	1-1/4	413	790	1 / 20	16.8	0.43
737042	1-5/16	461	970	5 / 20	20.4	0.84
737044	1-3/8	461	970	5 / 20	20.4	0.84
737046	1-7/16	486	1280	5 / 20	26.6	1.35
737048	1-1/2	486	1280	5 / 20	26.6	1.35
737052	1-5/8	540	1800	5 / 10	19.0	0.94
737054	1-11/16	540	1800	5 / 10	19.0	0.94
737056	1-3/4	611	1900	5 / 10	20.0	1.22
737058	1-13/16	611	1900	2 / 10	20.0	1.22
737060	1-7/8	611	2350	2 / 10	24.5	1.22
737064	2	611	2350	2 / 10	24.5	1.22
737068	2-1/8	665	4600	1 / 4	19.4	1.01
737072	2-1/4	665	4600	1 / 4	19.4	1.01
737076	2-3/8	760	6170	1 / 4	25.7	1.21
737080	2-1/2	760	6170	1 / 4	25.7	1.21

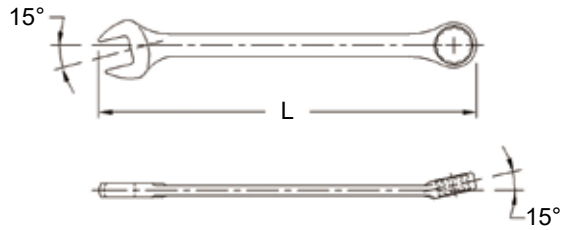

## HS-009S 9 Piece SAE Combination Wrench Set

Item No.	Size	Item No.	Size
737010	5/16"	737020	5/8"
737012	3/8"	737024	3/4"
737014	7/16"	737028	7/8"
737016	1/2"	737032	1"
737018	9/16"	Pouch Bag	

1750 g 8 sets / 15 Kgs / 0.71 CUFT



## HS-016S 16 Piece SAE Combination Wrench Set

Item No.	Size	Item No.	Size
737008	1/4"	737024	3/4"
737010	5/16"	737026	13/16"
737012	3/8"	737028	7/8"
737014	7/16"	737030	15/16"
737016	1/2"	737032	1"
737018	9/16"	737034	1-1/16"
737020	5/8"	737036	1-1/8"
737022	11/16"	737040	1-1/4"

Pouch Bag

4500 g 4 sets / 21 Kgs / 0.89 CUFT

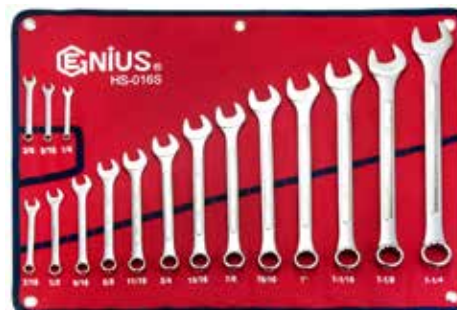

Made of Chrome Vanadium Steel

**ENIUS**  
PROFESSIONAL TOOLS

# Combination Wrench Sets

## HS-011M2 11 Piece Metric Combination Wrench Set

Item No.	Size	Item No.	Size
<b>Combination Wrench (Matt Finish):</b>			
726007	7mm	726013	13mm
726008	8mm	726014	14mm
726009	9mm	726015	15mm
726010	10mm	726017	17mm
726011	11mm	726019	19mm
726012	12mm		Plastic Hook

1150 g 12 sets / 14.8 Kgs / 0.69 CUFT

## HS-011S2 11 Piece SAE Combination Wrench Set

Item No.	Size	Item No.	Size
<b>Combination Wrench (Matt Finish):</b>			
737008	1/4"	737020	5/8"
737010	5/16"	737022	11/16"
737012	3/8"	737024	3/4"
737014	7/16"	737026	13/16"
737016	1/2"	737028	7/8"
737018	9/16"		Plastic Hook

1620 g 8 sets / 14 Kgs / 0.59 CUFT

## HS-013M 13 Piece Metric Combination Wrench Set

Item No.	Size	Item No.	Size
<b>Combination Wrench (Matt Finish):</b>			
726006	6mm	726013	13mm
726007	7mm	726014	14mm
726008	8mm	726017	17mm
726009	9mm	726019	19mm
726010	10mm	726022	22mm
726011	11mm	726024	24mm
726012	12mm		Pouch Bag

1900 g 6 sets / 12.5 Kgs / 0.65 CUFT

## HS-024M 24 Piece Metric Combination Wrench Set

Item No.	Size	Item No.	Size
<b>Combination Wrench (Matt Finish):</b>			
726006	6mm	726018	18mm
726007	7mm	726019	19mm
726008	8mm	726020	20mm
726009	9mm	726021	21mm
726010	10mm	726022	22mm
726011	11mm	726023	23mm
726012	12mm	726024	24mm
726013	13mm	726025	25mm
726014	14mm	726026	26mm
726015	15mm	726027	27mm
726016	16mm	726030	30mm
726017	17mm	726032	32mm
Pouch Bag			

6000 g 4 sets / 27.5 Kgs / 1.19 CUFT



# Combination Wrenches

## Metric & SAE Combination Wrenches - Mirror Finish

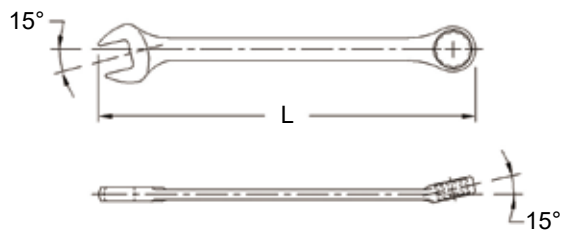

ITEM NO.	Size mm	Length mm	Weight g	PCS inner/ctn	G.W. KGS	CUFT 
748206	6	130	20	20 / 240	6.5	0.30
748207	7	135	25	20 / 240	7.0	0.30
748208	8	142	35	20 / 240	9.0	0.30
748209	9	154	45	10 / 200	10.0	0.59
748210	10	162	60	10 / 200	12.5	0.59
748211	11	170	65	10 / 200	14.5	0.59
748212	12	175	80	10 / 200	17.0	0.59
748213	13	180	90	10 / 150	14.0	0.52
748214	14	195	150	10 / 150	16.5	0.52
748215	15	205	140	10 / 100	15.0	0.62
748216	16	205	140	10 / 100	15.0	0.62
748217	17	228	170	10 / 100	18.5	0.62
748218	18	228	160	10 / 100	17.5	0.62
748219	19	250	200	5 / 60	13.5	0.52
748220	20	250	200	5 / 60	13.0	0.52
748221	21	270	280	5 / 60	18.0	0.52
748222	22	295	350	5 / 60	22.5	0.52
748223	23	295	360	5 / 60	22.5	0.52
748224	24	315	370	5 / 30	12.0	0.45
748225	25	338	480	5 / 30	15.5	0.45
748226	26	338	470	5 / 30	15.0	0.45
748227	27	360	600	5 / 30	19.0	0.45
748228	28	360	600	1 / 20	13.0	0.39
748229	29	395	650	1 / 20	14.0	0.39
748230	30	395	650	1 / 20	14.5	0.39
748232	32	430	850	1 / 20	17.5	0.43

ITEM NO.	Size inch	Length mm	Weight g	PCS inner/ctn	G.W. KGS	CUFT 
759208	1/4	130	25	20 / 240	7.0	0.30
759210	5/16	142	35	20 / 240	9.5	0.30
759212	3/8	154	45	10 / 200	10.0	0.59
759214	7/16	170	60	10 / 200	13.0	0.59
759216	1/2	180	85	10 / 200	18.0	0.59
759218	9/16	195	110	10 / 150	17.0	0.52
759220	5/8	205	140	10 / 100	15.0	0.62
759222	11/16	228	160	10 / 100	17.5	0.62
759224	3/4	250	220	5 / 60	14.0	0.52
759226	13/16	270	310	5 / 60	19.5	0.52
759228	7/8	295	360	5 / 60	22.5	0.52
759230	15/16	315	400	5 / 30	13.0	0.45
759232	1	338	480	5 / 30	15.5	0.45
759234	1-1/16	360	580	5 / 30	18.5	0.45
759236	1-1/8	395	700	1 / 20	15.0	0.41
759240	1-1/4	430	850	1 / 20	18.0	0.43



### PR-009S 9 Piece SAE Combination Wrench Set

Item No.	Size	Item No.	Size
759210	5/16"	759220	5/8"
759212	3/8"	759224	3/4"
759214	7/16"	759228	7/8"
759216	1/2"	759232	1"
759218	9/16"		Pouch Bag

 1750 g  12 sets / 22 Kgs / 0.93 CUFT



Made of Chrome Vanadium Steel

**ENIUS**  
PROFESSIONAL TOOLS

F-5



# Combination Wrench Sets

## PR-011S 11 Piece SAE Combination Wrench Set

Item No.	Size	Item No.	Size
<b>Combination Wrench (Mirror Finish):</b>			
759210	5/16"	759222	11/16"
759212	3/8"	759224	3/4"
759214	7/16"	759228	7/8"
759216	1/2"	759230	15/16"
759218	9/16"	759232	1"
759220	5/8"	Pouch Bag	

2300 g 6 sets / 15.5 Kgs / 0.65 CUFT



## PR-016S 16 Piece SAE Combination Wrench Set

Item No.	Size	Item No.	Size
<b>Combination Wrench (Mirror Finish):</b>			
759208	1/4"	759224	3/4"
759210	5/16"	759226	13/16"
759212	3/8"	759228	7/8"
759214	7/16"	759230	15/16"
759216	1/2"	759232	1"
759218	9/16"	759234	1-1/16"
759220	5/8"	759236	1-1/8"
759222	11/16"	759240	1-1/4"

Pouch Bag

5000 g 4 sets / 21 Kgs / 0.74 CUFT



## PR-017M 17 Piece Metric Combination Wrench Set

Item No.	Size	Item No.	Size
<b>Combination Wrench (Mirror Finish):</b>			
748206	6mm	748215	15mm
748207	7mm	748216	16mm
748208	8mm	748217	17mm
748209	9mm	748218	18mm
748210	10mm	748219	19mm
748211	11mm	748220	20mm
748212	12mm	748221	21mm
748213	13mm	748222	22mm
748214	14mm	Pouch Bag	

2500 g 8 sets / 22 Kgs / 0.82 CUFT



## PR-026M 26 Piece Metric Combination Wrench Set

Item No.	Size	Item No.	Size
<b>Combination Wrench (Mirror Finish):</b>			
748206	6mm	748219	19mm
748207	7mm	748220	20mm
748208	8mm	748221	21mm
748209	9mm	748222	22mm
748210	10mm	748223	23mm
748211	11mm	748224	24mm
748212	12mm	748225	25mm
748213	13mm	748226	26mm
748214	14mm	748227	27mm
748215	15mm	748228	28mm
748216	16mm	748229	29mm
748217	17mm	748230	30mm
748218	18mm	748232	32mm

Pouch Bag

8000 g 2 sets / 17 Kgs / 0.6 CUFT



Made of Chrome Vanadium Steel

# Double Ended Offset Ring Wrenches

## Metric & SAE Double Ended Offset Ring Wrenches - Mirror Finish

ITEM NO.	Size mm	Length mm	Weight g	PCS		G.W. KGS	CUFT
				inner/ctn			
740607	6 x 7	167	40	20 / 300	13.0	0.52	
740809	8 x 9	182	65	10 / 150	11.0	0.52	
741011	10 x 11	197	85	15 / 150	14.0	0.62	
741213	12 x 13	218	120	10 / 100	13.0	0.62	
741415	14 x 15	238	160	5 / 50	9.0	0.62	
741617	16 x 17	258	200	5 / 30	7.0	0.34	
741819	18 x 19	290	260	5 / 30	9.0	0.45	
742022	20 x 22	316	370	5 / 30	12.0	0.45	
742123	21 x 23	316	360	5 / 30	12.0	0.45	
742426	24 x 26	328	450	5 / 30	14.5	0.45	
742528	25 x 28	345	500	1 / 20	11.0	0.67	
742729	27 x 29	353	570	1 / 20	12.5	0.90	
743032	30 x 32	360	650	1 / 20	14.0	0.90	

ITEM NO.	Size inch	Length mm	Weight g	PCS		G.W. KGS	CUFT
				inner/ctn			
750810	1/4 x 5/16	167	50	10 / 150	8.5	0.52	
751214	3/8 x 7/16	200	90	15 / 150	14.5	0.62	
751618	1/2 x 9/16	238	160	5 / 50	9.0	0.62	
752022	5/8 x 11/16	258	200	5 / 30	7.0	0.34	
752426	3/4 x 13/16	296	290	5 / 30	10.0	0.45	
752830	7/8 x 15/16	315	420	5 / 30	13.5	0.45	
753234	1" x 1-1/16	345	500	1 / 20	11.0	0.31	
753640	1-1/8 x 1-1/4	360	650	1 / 20	14.0	0.90	

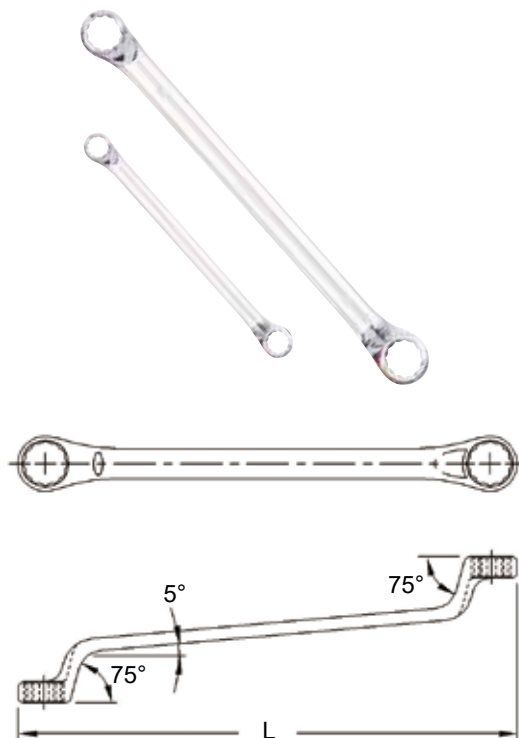

## Metric & SAE Double Ended Offset Ring Wrenches - Matt Finish

ITEM NO.	Size mm	Length mm	Weight g	PCS		G.W. KGS	CUFT
				inner/ctn			
720607	6 x 7	165	45	20 / 300	15.0	0.52	
720809	8 x 9	180	60	10 / 150	11.0	0.52	
721011	10 x 11	200	90	15 / 150	15.0	0.62	
721213	12 x 13	220	130	10 / 100	15.0	0.62	
721415	14 x 15	240	150	5 / 50	9.0	0.62	
721617	16 x 17	260	200	5 / 30	7.5	0.34	
721819	18 x 19	290	250	5 / 30	9.0	0.45	
722022	20 x 22	315	320	5 / 30	11.0	0.45	
722123	21 x 23	330	370	5 / 30	13.0	0.45	
722426	24 x 26	345	510	5 / 30	17.0	0.45	
722528	25 x 28	355	520	1 / 20	13.0	0.25	
722729	27 x 29	355	520	1 / 20	13.0	0.25	
723032	30 x 32	370	680	1 / 20	15.0	0.34	

ITEM NO.	Size inch	Length mm	Weight g	PCS		G.W. KGS	CUFT
				inner/ctn			
710810	1/4 x 5/16	165	45	10 / 150	8.5	0.52	
711214	3/8 x 7/16	200	90	15 / 150	15.0	0.62	
711618	1/2 x 9/16	220	130	5 / 50	8.0	0.62	
712022	5/8 x 11/16	260	200	5 / 30	7.5	0.34	
712426	3/4 x 13/16	315	320	5 / 30	11.0	0.45	
712830	7/8 x 15/16	330	370	5 / 30	13.0	0.45	
713234	1" x 1-1/16	355	520	1 / 20	13.0	0.25	
713640	1-1/8 x 1-1/4	370	680	1 / 20	15.0	0.34	

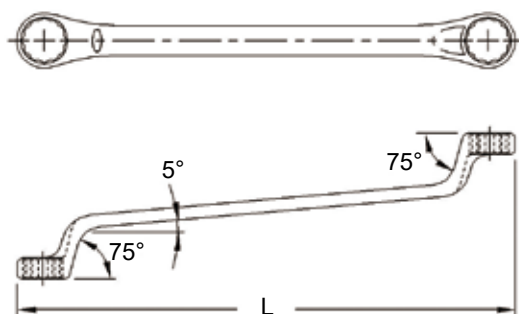

Made of Chrome Vanadium Steel



# Double Ended Offset Ring Wrench Sets

## DE-708M 8 Piece Metric Double Ended Offset Ring Wrench Set

Item No.	Size	Item No.	Size
<b>Double Ended Offset Ring Wrench (Mirror Finish):</b>			
740607	6 x 7mm	741415	14 x 15mm
740809	8 x 9mm	741617	16 x 17mm
741011	10 x 11mm	741819	18 x 19mm
741213	12 x 13mm	742022	20 x 22mm

Pouch Bag

1650 g

9 sets / 16 Kgs / 1.65 CUFT

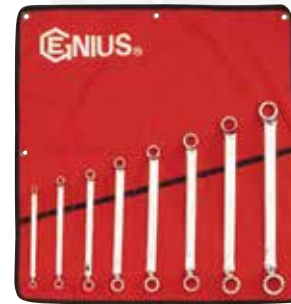

## DE-713M 13 Piece Metric Double Ended Offset Ring Wrench Set

Item No.	Size	Item No.	Size
<b>Double Ended Offset Ring Wrench (Mirror Finish):</b>			
740607	6 x 7mm	742022	20 x 22mm
740809	8 x 9mm	742123	21 x 23mm
741011	10 x 11mm	742426	24 x 26mm
741213	12 x 13mm	742528	25 x 28mm
741415	14 x 15mm	742729	27 x 29mm
741617	16 x 17mm	743032	30 x 32mm
741819	18 x 19mm		

4550 g

6 sets / 28.5 Kgs / 1.65 CUFT

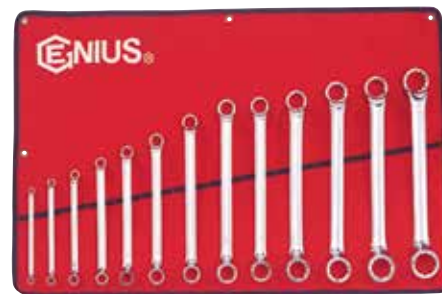

## DE-706S 6 Piece SAE Double Ended Offset Ring Wrench Set

Item No.	Size	Item No.	Size
<b>Double Ended Offset Ring Wrench (Mirror Finish):</b>			
750810	1/4 x 5/16"	752022	5/8 x 11/16"
751214	3/8 x 7/16"	752426	3/4 x 13/16"
751618	1/2 x 9/16"	752830	7/8 x 15/16"

Pouch Bag

1450 g

9 sets / 14 Kgs / 1.16 CUFT



## DE-708S 8 Piece SAE Double Ended Offset Ring Wrench Set

Item No.	Size	Item No.	Size
<b>Double Ended Offset Ring Wrench (Mirror Finish):</b>			
750810	1/4 x 5/16"	752426	3/4 x 13/16"
751214	3/8 x 7/16"	752830	7/8 x 15/16"
751618	1/2 x 9/16"	753234	1" x 1-1/16"
752022	5/8 x 11/16"	753640	1-1/8 x 1-1/4"

Pouch Bag

2650 g

9 sets / 25 Kgs / 1.65 CUFT



# Double Ended Offset Ring Wrench Sets

## DE-7208M 8 Piece Metric Double Ended Offset Ring Wrench Set

Item No.	Size	Item No.	Size
<b>Double Ended Offset Ring Wrench (Matt Finish):</b>			
720607	6 x 7mm	721415	14 x 15mm
720809	8 x 9mm	721617	16 x 17mm
721011	10 x 11mm	721819	18 x 19mm
721213	12 x 13mm	722022	20 x 22mm

Pouch Bag

1650 g

9 sets / 16 Kgs / 1.65 CUFT



## DE-7213M 13 Piece Metric Double Ended Offset Ring Wrench Set

Item No.	Size	Item No.	Size
<b>Double Ended Offset Ring Wrench (Matt Finish):</b>			
720607	6 x 7mm	722022	20 x 22mm
720809	8 x 9mm	722123	21 x 23mm
721011	10 x 11mm	722426	24 x 26mm
721213	12 x 13mm	722528	25 x 28mm
721415	14 x 15mm	722729	27 x 29mm
721617	16 x 17mm	723032	30 x 32mm
721819	18 x 19mm		Pouch Bag

4400 g

6 sets / 27 Kgs / 1.65 CUFT

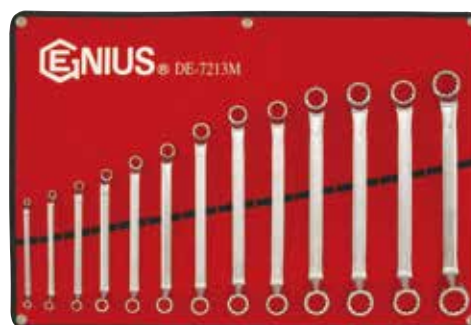

## DE-7106S 6 Piece SAE Double Ended Offset Ring Wrench Set

Item No.	Size	Item No.	Size
<b>Double Ended Offset Ring Wrench (Matt Finish):</b>			
710810	1/4 x 5/16"	712022	5/8 x 11/16"
711214	3/8 x 7/16"	712426	3/4 x 13/16"
711618	1/2 x 9/16"	712830	7/8 x 15/16"

Pouch Bag

1450 g

9 sets / 14.5 Kgs / 1.16 CUFT

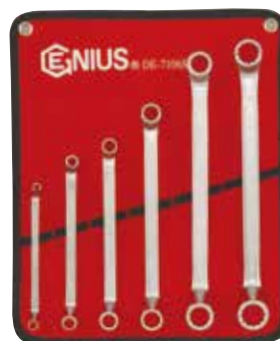

## DE-7108S 8 Piece SAE Double Ended Offset Ring Wrench Set

Item No.	Size	Item No.	Size
<b>Double Ended Offset Ring Wrench (Matt Finish):</b>			
710810	1/4 x 5/16"	712426	3/4 x 13/16"
711214	3/8 x 7/16"	712830	7/8 x 15/16"
711618	1/2 x 9/16"	713234	1" x 1-1/16"
712022	5/8 x 11/16"	713640	1-1/8 x 1-1/4"

Pouch Bag

2900 g

9 sets / 27.5 Kgs / 1.65 CUFT

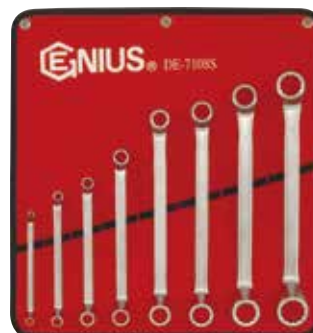

# Flare Nut Wrenches

## Metric & SAE Flare Nut Wrenches - Mirror Finish

ITEM NO.	Size mm	Length mm	Weight g	PCS inner/ctn	G.W. KGS	CUFT
740911	9 x 11	155	70	10 / 150	11.5	0.52
741012	10 x 12	155	65	10 / 150	11.0	0.52
741314	13 x 14	175	85	10 / 150	14.0	0.52
741517	15 x 17	200	130	10 / 100	14.5	0.62
741618	16 x 18	200	140	10 / 100	14.5	0.62
741921	19 x 21	225	200	10 / 100	21.0	0.62

ITEM NO.	Size inch	Length mm	Weight g	PCS inner/ctn	G.W. KGS	CUFT
760810	1/4 x 5/16	135	40	10 / 150	7.0	0.52
761214	3/8 x 7/16	155	70	10 / 150	11.5	0.52
761618	1/2 x 9/16	175	90	10 / 150	14.5	0.52
762022	5/8 x 11/16	200	130	10 / 100	14.5	0.62
762428	3/4 x 7/8	225	200	10 / 100	21.0	0.62

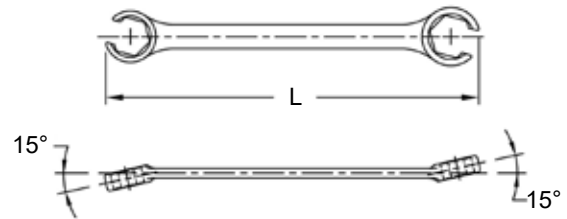

### FN-006M 6 Piece Metric Flare Nut Wrench Set

Item No.	Size	Item No.	Size
740911	9 x 11mm	741517	15 x 17mm
741012	10 x 12mm	741618	16 x 18mm
741314	13 x 14mm	741921	19 x 21mm

Pouch Bag

850 g 20 sets / 18 Kgs / 1.07 CUFT



### FN-005S 5 Piece SAE Flare Nut Wrench Set

Item No.	Size	Item No.	Size
760810	1/4 x 5/16"	762022	5/8 x 11/16"
761214	3/8 x 7/16"	762428	3/4 x 7/8"
761618	1/2 x 9/16"		Pouch Bag

650 g 20 sets / 14.5 Kgs / 1.07 CUFT



Wrenches & Torque Wrenches

# Combination Ratcheting Wrenches

## Metric & SAE Combination Ratcheting Wrenches - Mirror Finish

ITEM NO.	Size mm	Length mm	Weight g	PCS	Weight	G.W.	CUFT
				inner/ctn	w/packing	KGS	
768508	8	136	35	1 / 60	50	4.0	0.37
768510	10	160	55	1 / 40	75	4.0	0.37
768511	11	168	70	1 / 40	90	4.5	0.37
768512	12	174	80	1 / 40	100	5.0	0.37
768513	13	180	95	1 / 40	120	5.8	0.37
768514	14	193	120	1 / 40	145	6.8	0.37
768515	15	200	135	1 / 30	165	6.0	0.37
768516	16	216	155	1 / 30	185	6.5	0.37
768517	17	233	190	1 / 20	225	5.5	0.37
768518	18	239	200	1 / 20	235	5.7	0.37
768519	19	250	240	1 / 20	275	6.5	0.37
768521	21	285	350	1 / 20	405	9.0	0.39
768522	22	285	340	1 / 20	395	9.0	0.39
768523	23	285	330	1 / 20	385	8.7	0.39
768524	24	325	470	1 / 20	535	11.7	0.45
768525	25	325	460	1 / 20	525	11.5	0.45
768526	26	325	455	1 / 20	520	11.5	0.45
768527	27	355	580	1 / 20	650	14.0	0.62
768528	28	355	570	1 / 20	640	13.8	0.62
768530	30	425	940	1 / 15	1030	16.5	0.73
768532	32	425	900	1 / 15	990	16.0	0.73

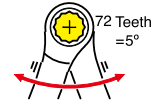

ITEM NO.	Size inch	Length mm	Weight g	PCS	Weight	G.W.	CUFT
				inner/ctn	w/packing	KGS	
778510	5/16	136	35	1 / 60	50	4.0	0.37
778512	3/8	160	55	1 / 40	75	4.0	0.37
778514	7/16	168	70	1 / 40	90	4.5	0.37
778516	1/2	180	90	1 / 40	115	5.5	0.37
778518	9/16	193	120	1 / 40	145	6.8	0.37
778520	5/8	216	155	1 / 30	185	6.5	0.37
778522	11/16	233	185	1 / 20	220	5.5	0.37
778524	3/4	250	220	1 / 20	255	6.0	0.37
778526	13/16	285	350	1 / 20	405	9.0	0.39
778528	7/8	285	345	1 / 20	400	9.0	0.39
778530	15/16	325	485	1 / 20	550	12.0	0.45
778532	1	325	470	1 / 20	535	11.7	0.45
778534	1-1/16	355	610	1 / 20	680	14.5	0.62
778536	1-1/8	425	985	1 / 15	1075	17.0	0.73
778540	1-1/4	425	950	1 / 15	1040	16.5	0.73

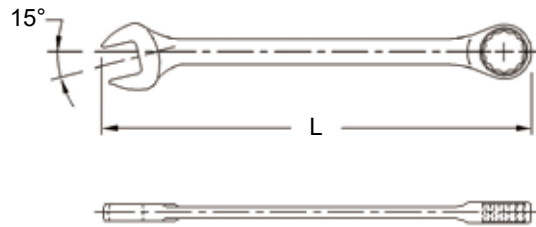

## GW-7607M 7 Piece Metric Combination Ratcheting Wrench Set

Item No.	Size	Item No.	Size
<b>Combination Ratcheting Wrench (Mirror Finish):</b>			
768508	8mm	768514	14mm
768510	10mm	768517	17mm
768512	12mm	768519	19mm
768513	13mm	Plastic Tray	

1250 g      10 sets / 13.5 Kgs / 1.58 CUFT



1/3

(192W x 406D)

Made of Chrome Vanadium Steel

**ENIUS**  
PROFESSIONAL TOOLS

F-11

# Combination Ratcheting Wrench Set

## GW-7608M 8 Piece Metric Combination Ratcheting Wrench Set

**Item No. Size Item No. Size**  
**Combination Ratcheting Wrench (Mirror Finish):**

768508	8mm	768513	13mm
768510	10mm	768514	14mm
768511	11mm	768517	17mm
768512	12mm	768519	19mm

Pouch Bag

1200 g 8 sets / 10.5 Kgs / 0.7 CUFT



## GW-7708S 8 Piece SAE Combination Ratcheting Wrench Set

**Item No. Size Item No. Size**  
**Combination Ratcheting Wrench (Mirror Finish):**

778510	5/16"	778518	9/16"
778512	3/8"	778520	5/8"
778514	7/16"	778522	11/16"
778516	1/2"	778524	3/4"

Pouch Bag

1200 g 8 sets / 10.5 Kgs / 0.7 CUFT



## GW-7611M 11 Piece Metric Combination Ratcheting Wrench Set

**Item No. Size Item No. Size**  
**Combination Ratcheting Wrench (Mirror Finish):**

768508	8mm	768515	15mm
768510	10mm	768516	16mm
768511	11mm	768517	17mm
768512	12mm	768518	18mm
768513	13mm	768519	19mm
768514	14mm		Pouch Bag

1700 g 8 sets / 14.5 Kgs / 0.7 CUFT



## GW-7617M 17 Piece Metric Combination Ratcheting Wrench Set

**Item No. Size Item No. Size**  
**Combination Ratcheting Wrench (Mirror Finish):**

768508	8mm	768518	18mm
768510	10mm	768519	19mm
768511	11mm	768521	21mm
768512	12mm	768522	22mm
768513	13mm	768524	24mm
768514	14mm	768527	27mm
768515	15mm	768530	30mm
768516	16mm	768532	32mm
768517	17mm		Blow Case

6250 g 3 sets / 19.8 Kgs / 1.68 CUFT

## GW-7715S 15 Piece SAE Combination Ratcheting Wrench Set

**Item No. Size Item No. Size**  
**Combination Ratcheting Wrench (Mirror Finish):**

778510	5/16"	778526	13/16"
778512	3/8"	778528	7/8"
778514	7/16"	778530	15/16"
778516	1/2"	778532	1"
778518	9/16"	778534	1-1/16"
778520	5/8"	778536	1-1/8"
778522	11/16"	778540	1-1/4"
778524	3/4"		Blow Case

6450 g 3 sets / 20.3 Kgs / 1.68 CUFT



Made of Chrome Vanadium Steel

# Stubby Combination Ratcheting Wrenches

## Metric & SAE Stubby Combination Ratcheting Wrenches - Mirror Finish

ITEM NO.	Size mm	Length mm	Weight g	PCS		G.W. KGS	CUFT
				inner/ctn			
760210	10	96	50	25 / 150	8.0	0.92	
760211	11	100	60	25 / 150	9.5	0.92	
760212	12	104	60	25 / 150	10.0	0.92	
760213	13	108	70	20 / 120	9.0	0.92	
760214	14	114	80	20 / 120	11.0	0.92	
760215	15	118	100	15 / 90	10.0	0.92	
760216	16	122	110	15 / 90	11.0	0.92	
760217	17	128	120	10 / 60	8.5	0.92	
760218	18	132	140	10 / 60	9.5	0.92	
760219	19	138	160	10 / 60	11.0	0.92	



ITEM NO.	Size inch	Length mm	Weight g	PCS		G.W. KGS	CUFT
				inner/ctn			
770212	3/8	96	50	25 / 150	8.0	0.92	
770214	7/16	100	60	25 / 150	9.5	0.92	
770216	1/2	108	70	20 / 120	9.5	0.92	
770218	9/16	114	90	20 / 120	12.0	0.92	
770220	5/8	122	110	15 / 90	11.0	0.92	
770222	11/16	128	120	10 / 60	8.5	0.92	
770224	3/4	135	170	10 / 60	11.5	0.92	

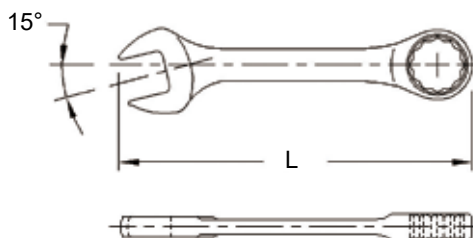

### GW-7610M 10 Piece Metric Stubby Combination Ratcheting Wrench Set

Item No. Size Item No. Size  
Stubby Combination Ratcheting Wrench (Mirror Finish):

760210	10mm	760215	15mm
760211	11mm	760216	16mm
760212	12mm	760217	17mm
760213	13mm	760218	18mm
760214	14mm	760219	19mm

Pouch Bag

1150 g

8 sets / 10 Kgs / 0.7 CUFT



### GW-7707S 7 Piece SAE Stubby Combination Ratcheting Wrench Set

Item No. Size Item No. Size  
Combination Ratcheting Wrench (Mirror Finish):

770212	3/8"	770220	5/8"
770214	7/16"	770222	11/16"
770216	1/2"	770224	3/4"
770218	9/16"		Pouch Bag

850 g

8 sets / 7.5 Kgs / 0.7 CUFT



# Extra Long Box End Wrenches

## Metric & SAE Extra Long Box End Wrenches - Mirror Finish

ITEM NO.	Size mm	Length mm	Weight g	PCS inner/ctn	G.W. KGS	CUFT
780810L	8 x 10	235	70	10 / 100	8.0	0.62
781012L	10 x 12	292	120	5 / 60	8.5	0.52
781214L	12 x 14	330	170	10 / 60	11.0	0.45
781315L	13 x 15	330	170	10 / 60	11.0	0.45
781417L	14 x 17	369	250	5 / 30	8.5	0.45
781618L	16 x 18	407	370	15 / 30	12.0	0.43
781719L	17 x 19	407	350	15 / 30	11.5	0.43
782224L	22 x 24	435	570	15 / 30	18.0	0.43



ITEM NO.	Size inch	Length mm	Weight g	PCS inner/ctn	G.W. KGS	CUFT
791012L	5/16 x 3/8	235	75	10 / 100	8.5	0.62
791416L	7/16 x 1/2	292	170	10 / 60	11.0	0.45
791820L	9/16 x 5/8	369	250	5 / 30	8.5	0.45
792224L	11/16 x 3/4	407	330	15 / 30	11.0	0.43

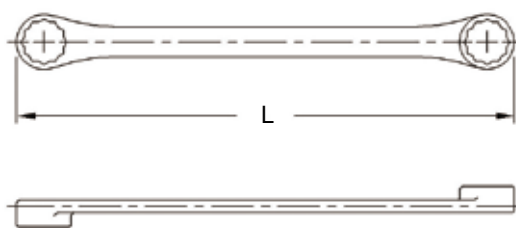

### DE-706M 6 Piece Metric Extra Long Box End Wrench Set

Item No.	Size	Item No.	Size
<b>Extra Long Box End Wrench (Mirror Finish):</b>			
781012L	10 x 12mm	781417L	14 x 17mm
781214L	12 x 14mm	781618L	16 x 18mm
781315L	13 x 15mm	781719L	17 x 19mm

Plastic Hook

1450 g 12 sets / 18.5 Kgs / 0.69 CUFT



### DE-704S 4 Piece SAE Extra Long Box End Wrench Set

Item No.	Size	Item No.	Size
<b>Extra Long Box End Wrench (Mirror Finish):</b>			
791012L	5/16 x 3/8"	791820L	9/16 x 5/8"
791416L	7/16 x 1/2"	792224L	11/16 x 3/4"

Plastic Hook

900 g 12 sets / 11.5 Kgs / 0.69 CUFT



Wrenches & Torque Wrenches

# Double Flexible Socket Wrenches

## Metric & SAE Double Flexible Socket Wrenches - Mirror Finish

ITEM NO.	Size mm	Length mm	Weight g	PCS		G.W. KGS	CUFT
				inner/ctn			
500607	6 x 7	185	80	50 / 200		17.0	0.59
500809	8 x 9	185	85	50 / 200		18.0	0.59
500810	8 x 10	185	85	50 / 200		18.0	0.59
501011	10 x 11	200	110	50 / 200		23.0	0.93
501012	10 x 12	200	115	50 / 200		24.0	0.93
501213	12 x 13	220	150	40 / 160		25.5	0.93
501214	12 x 14	220	165	40 / 160		27.5	0.93
501415	14 x 15	240	230	25 / 100		24.0	0.67
501617	16 x 17	255	310	40 / 80		26.0	0.67
501819	18 x 19	270	370	30 / 60		23.5	0.67
502022	20 x 22	305	570	20 / 40		24.0	0.67
502123	21 x 23	305	620	20 / 40		26.0	0.67
502427	24 x 27	335	760	10 / 20		16.0	0.67
503032	30 x 32	345	990	10 / 20		21.0	0.67

ITEM NO.	Size inch	Length mm	Weight g	PCS		G.W. KGS	CUFT
				inner/ctn			
511214	3/8 x 7/16	200	100	50 / 200		22.0	0.93
511618	1/2 x 9/16	225	190	30 / 120		24.0	0.93
512022	5/8 x 11/16	260	320	40 / 80		27.0	0.67
512428	3/4 x 7/8	300	530	20 / 40		22.0	0.67

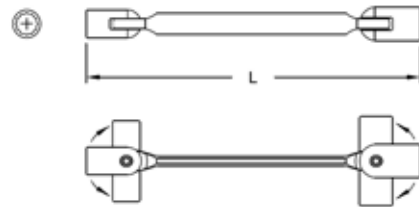

### DF-506M 6 Piece Metric Double Flexible Socket Wrench Set

Item No.	Size	Item No.	Size
<b>Double Flexible Socket Wrench (Mirror Finish):</b>			
500809	8 x 9mm	501415	14 x 15mm
501011	10 x 11mm	501617	16 x 17mm
501213	12 x 13mm	501819	18 x 19mm

Pouch Bag

1400 g 10 sets / 15 Kgs / 0.71 CUFT



### DF-504S 4 Piece Double Flexible Socket Wrench Set

Item No.	Size	Item No.	Size
<b>Extra Long Box End Wrench (Mirror Finish):</b>			
511214	3/8 x 7/16"	512022	5/8 x 11/16"
511618	1/2 x 9/16"	512428	3/4 x 7/8"

Pouch Bag

1250 g 10 sets / 13.5 Kgs / 0.71 CUFT





# E-Star Wrenches

## E-Star Wrenches - Mirror Finish

ITEM NO.	Size	Length mm	Weight g	PCS	G.W. KGS	CUFT
				inner/ctn		
790608	E-6 x E-8	112	20	10 / 120	3.0	0.37
791012	E-10 x E-12	141	40	10 / 120	6.0	0.37
791418	E-14 x E-18	181	80	10 / 120	11.0	0.37
792024	E-20 x E-24	225	160	10 / 60	11.0	0.37

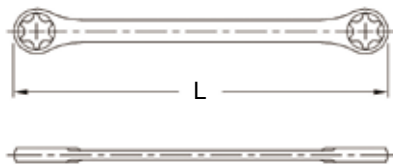

## TX-E04 4 Piece E-Star Wrench Set

Item No.	Size	Item No.	Size
<b>E-Star Wrench (Mirror Finish):</b>			
790608	E-6 x E-8	791418	E-14 x E-18
791012	E-10 x E-12	792024	E-20 x E-24

Pouch Bag

400 g

20 sets / 9 Kgs / 0.6 CUFT



## TX-2324 24 Piece Star Wrench Set

Item No.	Size	Item No.	Size
<b>3/8" Dr. E-Star Hand Socket:</b>			
353510	E-10	353516	E-16
353511	E-11	353518	E-18
353512	E-12	353520	E-20
353514	E-14		
<b>E-Star Wrench:</b>			
790608	E-6 x E-8	791418	E-14 x E-18
791012	E-10 x E-12	792024	E-20 x E-24
<b>Tamperproof Star Bit, 30mmL:</b>			
7108	1/4" Hex Shank T-8	7127	1/4" Hex Shank T-27
7110	1/4" Hex Shank T-10	7130	1/4" Hex Shank T-30
7115	1/4" Hex Shank T-15	7140	1/4" Hex Shank T-40
7120	1/4" Hex Shank T-20	7145	5/16" Hex Shank T-45
7125	1/4" Hex Shank T-25	7150	5/16" Hex Shank T-50

### Accessory:

262808	1/4" Dr. x 1/4" Hex Shank Impact Bit Holder
363008	3/8" Dr. x 1/4" Hex Shank Impact Bit Holder
363010	3/8" Dr. x 5/16" Hex Shank Impact Bit Holder
Plastic Tray	

1000 g

10 sets / 11 Kgs / 0.93 CUFT



(192W x 203D)



# Open End Wrenches

## Metric & SAE Open End Wrenches - Matt Finish

ITEM NO.	Size mm	Length mm	Weight g	PCS	G.W.	CUFT
				inner/ctn	KGS	
790607	6 x 7	122	20	20 / 400	10.0	0.59
790809	8 x 9	140	30	20 / 400	14.0	0.59
791011	10 x 11	156	50	20 / 300	16.0	0.52
791213	12 x 13	172	60	10 / 150	10.0	0.52
791415	14 x 15	188	110	10 / 150	17.5	0.52
791617	16 x 17	204	140	10 / 150	22.0	0.52
791819	18 x 19	220	160	10 / 100	17.5	0.62
792022	20 x 22	234	220	10 / 100	12.0	0.62
792123	21 x 23	247	250	5 / 50	13.5	0.62
792426	24 x 26	266	350	5 / 30	11.5	0.34
792528	25 x 28	285	380	5 / 30	12.5	0.34
792730	27 x 30	302	460	15 / 30	15.0	0.41
793032	30 x 32	302	460	15 / 30	15.0	0.41



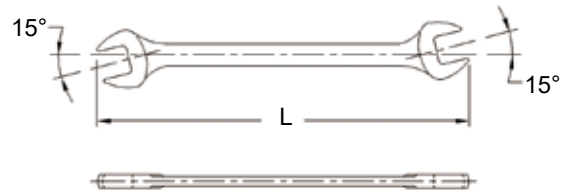

ITEM NO.	Size inch	Length mm	Weight g	PCS	G.W.	CUFT
				inner/ctn	KGS	
770810	1/4 x 5/16	122	25	20 / 400	11.0	0.59
771214	3/8 x 7/16	156	50	20 / 300	16.0	0.52
771618	1/2 x 9/16	180	80	10 / 150	13.0	0.52
772022	5/8 x 11/16	204	120	10 / 100	13.0	0.62
772428	3/4 x 7/8	234	220	10 / 100	12.0	0.62
772628	13/16 x 7/8	247	250	5 / 50	13.5	0.62
773032	15/16 x 1	266	330	5 / 30	11.0	0.34
773236	1 x 1-1/8	285	380	5 / 30	12.5	0.34
773440	1-1/16 x 1-1/4	302	460	15 / 30	15.0	0.41



### OW-707M 7 Piece Metric Open End Wrench Set

Item No.	Size	Item No.	Size
<b>Open End Wrench (Matt Finish):</b>			
790607	6 x 7mm	791415	14 x 15mm
790809	8 x 9mm	791617	16 x 17mm
791011	10 x 11mm	791819	18 x 19mm
791213	12 x 13mm		
Plastic Tray			



 850 g  10 sets / 9.5 Kgs / 0.93 CUFT



(192W x 203D)

### OW-705S 5 Piece SAE Open End Wrench Set

Item No.	Size	Item No.	Size
<b>Open End Wrench (Matt Finish):</b>			
770810	1/4 x 5/16"	772022	5/8 x 11/16"
771214	3/8 x 7/16"	772428	3/4 x 7/8"
771618	1/2 x 9/16"		
Plastic Tray			

 750 g  10 sets / 8.5 Kgs / 0.93 CUFT



(192W x 203D)

# Open End Wrenches

## OW-708M 8 Piece Metric Open End Wrench Set

Item No.	Size	Item No.	Size
<b>Open End Wrench (Matt Finish):</b>			
790607	6 x 7mm	791415	14 x 15mm
790809	8 x 9mm	791617	16 x 17mm
791011	10 x 11mm	791819	18 x 19mm
791213	12 x 13mm	792022	20 x 22mm

Pouch Bag

950 g 10 sets / 10.5 Kgs / 0.62 CUFT



## OW-713M 13 Piece Metric Open End Wrench Set

Item No.	Size	Item No.	Size
<b>Open End Wrench (Matt Finish):</b>			
790607	6 x 7mm	792022	20 x 22mm
790809	8 x 9mm	792123	21 x 23mm
791011	10 x 11mm	792426	24 x 26mm
791213	12 x 13mm	792528	25 x 28mm
791415	14 x 15mm	792730	27 x 30mm
791617	16 x 17mm	793032	30 x 32mm
791819	18 x 19mm	Pouch Bag	

3100 g 4 sets / 13.5 Kgs / 0.82 CUFT



## OW-706S 6 Piece SAE Open End Wrench Set

Item No.	Size	Item No.	Size
<b>Open End Wrench (Matt Finish):</b>			
770810	1/4 x 5/16"	772022	5/8 x 11/16"
771214	3/8 x 7/16"	772428	3/4 x 7/8"
771618	1/2 x 9/16"	773032	15/16 x 1"

Pouch Bag

950 g 12 sets / 12.5 Kgs / 0.59 CUFT



## OW-709S 9 Piece SAE Open End Wrench Set

Item No.	Size	Item No.	Size
<b>Open End Wrench (Matt Finish):</b>			
770810	1/4 x 5/16"	772628	13/16 x 7/8"
771214	3/8 x 7/16"	773032	15/16 x 1"
771618	1/2 x 9/16"	773236	1 x 1-1/8"
772022	5/8 x 11/16"	773440	1-1/16 x 1-1/4"
772428	3/4 x 7/8"	Pouch Bag	

2150 g 6 sets / 14 Kgs / 0.71 CUFT



## CW-007M 7 Piece Metric Combination Wrench Set - Mirror Finish

Item No.	Size	Item No.	Size
<b>Combination Wrench (Mirror Finish):</b>			
748210	10mm	748219	19mm
748212	12mm	748222	22mm
748214	14mm	748224	24mm
748217	17mm		Plastic Tray

1850 g 10 sets / 19.5 Kgs / 1.58 CUFT



(192W x 406D)



## HS-007M 7 Piece Metric Combination Wrench Set - Matt Finish

Item No.	Size	Item No.	Size
<b>Combination Wrench (Matt Finish):</b>			
726010	10mm	726019	19mm
726012	12mm	726022	22mm
726014	14mm	726024	24mm
726017	17mm		Plastic Tray

1650 g 10 sets / 17.5 Kgs / 1.58 CUFT



(192W x 406D)



## PR-015M 15 Piece Metric Combination Wrench Set - Mirror Finish

Item No.	Size	Item No.	Size
<b>Combination Wrench (Mirror Finish):</b>			
748207	7mm	748215	15mm
748208	8mm	748216	16mm
748209	9mm	748217	17mm
748210	10mm	748218	18mm
748211	11mm	748219	19mm
748212	12mm	748222	22mm
748213	13mm	748224	24mm
748214	14mm		Plastic Tray

2500 g 10 sets / 26.5 Kgs / 1.58 CUFT



(192W x 406D)



## GW-7607M 7 Piece Metric Combination Ratcheting Wrench Set

Item No.	Size	Item No.	Size
<b>Combination Ratcheting Wrench (Mirror Finish):</b>			
768508	8mm	768514	14mm
768510	10mm	768517	17mm
768512	12mm	768519	19mm
768513	13mm		Plastic Tray

1250 g 10 sets / 13.5 Kgs / 1.58 CUFT



(192W x 406D)



## DE-707M 7 Piece Metric Offset Box End Wrench Set

Item No.	Size	Item No.	Size
<b>Offset Box End Wrench (Mirror Finish):</b>			
740607	6 x 7mm	741415	14 x 15mm
740809	8 x 9mm	741617	16 x 17mm
741011	10 x 11mm	741819	18 x 19mm
741213	12 x 13mm		Plastic Tray

1350 g 10 sets / 14.5 Kgs / 1.58 CUFT



(192W x 406D)



# Ratcheting Wrench Sets

## GW-7211M 11 Piece Metric Combination Ratcheting Wrench Set (Stainless)

Item No.	Size	Item No.	Size
<b>Combination Ratcheting Wrench (Mirror Finish):</b>			
721408	8mm	722015	15mm
721610	10mm	722216	16mm
721711	11mm	722317	17mm
721712	12mm	722418	18mm
721813	13mm	722519	19mm
721914	14mm	Pouch Bag	

1700 g

8 sets / 14.5 Kgs / 0.7 CUFT



## GW-7108S 8 Piece SAE Combination Ratcheting Wrench Set (Stainless)

Item No.	Size	Item No.	Size
<b>Combination Ratcheting Wrench (Mirror Finish):</b>			
711410	5/16"	711918	9/16"
711612	3/8"	712220	5/8"
711714	7/16"	712322	11/16"
711816	1/2"	712524	3/4"

Pouch Bag

1200 g

8 sets / 10.5 Kgs / 0.7 CUFT



## GW-7411M 11 Piece Metric Combination Flexible Ratcheting Wrench Set (Stainless)

Item No.	Size	Item No.	Size
<b>Com. Flexible Ratcheting Wrench (Mirror Finish):</b>			
741408	8mm	742015	15mm
741610	10mm	742116	16mm
741611	11mm	742217	17mm
741712	12mm	742418	18mm
741813	13mm	742419	19mm
741914	14mm	Pouch Bag	

1850 g

8 sets / 16 Kgs / 0.7 CUFT



## GW-7308S 8 Piece SAE Combination Flexible Ratcheting Wrench Set (Stainless)

Item No.	Size	Item No.	Size
<b>Com. Flexible Ratcheting Wrench (Mirror Finish):</b>			
731410	5/16"	731918	9/16"
731612	3/8"	732120	5/8"
731614	7/16"	732222	11/16"
731816	1/2"	732424	3/4"

Pouch Bag

1350 g

8 sets / 12 Kgs / 0.7 CUFT



# Ratcheting Wrench Sets

## GW-7006M 6 Piece Metric Double Ratcheting Ended Wrench Set (Stainless)

Item No.	Size	Item No.	Size
<b>Double Ratcheting Ended Wrench (Mirror Finish):</b>			
700809	8 x 9mm	701415	14 x 15mm
701011	10 x 11mm	701618	16 x 18mm
701213	12 x 13mm	701719	17 x 19mm

Pouch Bag

1000 g

8 sets / 9 Kgs / 0.7 CUFT



## GW-7504S 4 Piece SAE Double Ratcheting Ended Wrench Set (Stainless)

Item No.	Size	Item No.	Size
<b>Double Ratcheting Ended Wrench (Mirror Finish):</b>			
751012	5/16 x 3/8"		
751416	7/16 x 1/2"		
751820	9/16 x 5/8"		
752224	11/16 x 3/4"		

Pouch Bag

700 g

8 sets / 6.5 Kgs / 0.7 CUFT



## GW-7806M 6 Piece Metric Double Flexible Ratcheting Ended Wrench Set (Stainless)

Item No.	Size	Item No.	Size
<b>Double Flexible Ratcheting Ended Wrench (Mirror Finish):</b>			
780809	8 x 9mm	781415	14 x 15mm
781011	10 x 11mm	781618	16 x 18mm
781213	12 x 13mm	781719	17 x 19mm

Pouch Bag

1500 g

8 sets / 13 Kgs / 0.7 CUFT



## GW-7704S 4 Piece SAE Double Flexible Ratcheting Ended Wrench Set (Stainless)

Item No.	Size	Item No.	Size
<b>Double Flexible Ratcheting Ended Wrench (Mirror Finish):</b>			
771012	5/16 x 3/8"		
771416	7/16 x 1/2"		
771820	9/16 x 5/8"		
772224	11/16 x 3/4"		

Pouch Bag

1050 g

8 sets / 9.5 Kgs / 0.7 CUFT



# Key Wrench Sets

## HK-09MS 9 Piece Metric Hex Key Wrench Set - S2 Material

Item No.	Size	Item No.	Size
<b>Hex Key Wrench (S2 Material):</b>			
570515S	1.5mm	570850S	5mm
570520S	2mm	570960S	6mm
570625S	2.5mm	571080S	8mm
570630S	3mm	571210S	10mm
570740S	4mm		Plastic Holder

310 g 12x6 72 sets / 24 Kgs / 1.88 CUFT



## HK-09SS 9 Piece SAE Hex Key Wrench Set - S2 Material

Item No.	Size	Item No.	Size
<b>Hex Key Wrench (S2 Material):</b>			
590504S	1/16"	590812S	3/16"
590605S	5/64"	590916S	1/4"
590606S	3/32"	591020S	5/16"
590608S	1/8"	591124S	3/8"
590710S	5/32"		Plastic Holder

300 g 12x6 72 sets / 24 Kgs / 1.88 CUFT



## HK-10MS 10 Piece Metric Hex Key Wrench Set - S2 Material

Item No.	Size	Item No.	Size
<b>Hex Key Wrench (S2 Material):</b>			
570515S	1.5mm	570850S	5mm
570520S	2mm	570855S	5.5mm
570625S	2.5mm	570960S	6mm
570630S	3mm	571080S	8mm
570740S	4mm	571210S	10mm
			Plastic Holder

310 g 12x6 72 sets / 23.5 Kgs / 1.44 CUFT



## HK-10SS 10 Piece SAE Hex Key Wrench Set - S2 Material

Item No.	Size	Item No.	Size
<b>Hex Key Wrench (S2 Material):</b>			
590504S	1/16"	590812S	3/16"
590605S	5/64"	590814S	7/32"
590606S	3/32"	590916S	1/4"
590608S	1/8"	591020S	5/16"
590710S	5/32"	591124S	3/8"
			Plastic Holder

300 g 12x6 72 sets / 22.5 Kgs / 1.44 CUFT



## HK-09MLS 9 Piece Metric Extra Long Hex Key Wrench Set - S2 Material

Item No.	Size	Item No.	Size
<b>Long Hex Key Wrench (S2 Material):</b>			
570915LS	1.5mm	571650LS	5mm
571020LS	2mm	571760LS	6mm
571125LS	2.5mm	572080LS	8mm
571230LS	3mm	572210LS	10mm
571440LS	4mm		Plastic Holder

500 g 12x3 36 sets / 19 Kgs / 1.7 CUFT

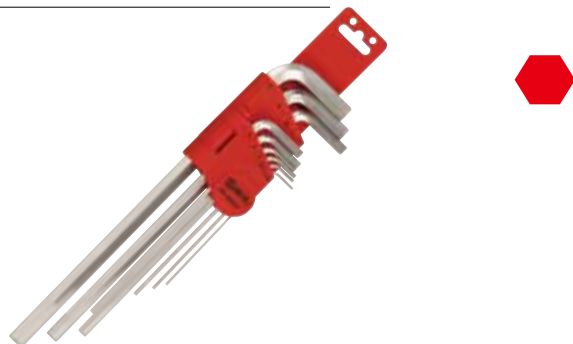

Wrenches & Torque Wrenches

## HK-009ASM 9 Piece Metric Extra Long Anti-Slip Hex Key Wrench Set - S2 Material

Item No.	Size	Item No.	Size
<b>Anti-Slip Hex Key Wrench (S2 Material):</b>			
700915L	1.5mm	701650L	5mm
701020L	2mm	701860L	6mm
701125L	2.5mm	702080L	8mm
701230L	3mm	702210L	10mm
701440L	4mm		Plastic Holder
480 g	12x3	36 sets / 18.5 Kgs / 1.46 CUFT	



## HK-009ASS 9 Piece SAE Extra Long Anti-Slip Hex Key Wrench Set - S2 Material

Item No.	Size	Item No.	Size
<b>Anti-Slip Hex Key Wrench (S2 Material):</b>			
710904L	1/16"	711612L	3/16"
711005L	5/64"	711816L	1/4"
711106L	3/32"	712020L	5/16"
711208L	1/8"	712224L	3/8"
711410L	5/32"		Plastic Holder
470 g	12x3	36 sets / 18 Kgs / 1.46 CUFT	



## HK-09MBS 9 Piece Metric Extra Long Wobble Hex Key Wrench Set - S2 Material

Item No.	Size	Item No.	Size
<b>Wobble Hex Key Wrench (S2 Material):</b>			
570915BS	1.5mm	571650BS	5mm
571020BS	2mm	571760BS	6mm
571125BS	2.5mm	572080BS	8mm
571230BS	3mm	572210BS	10mm
571440BS	4mm		Plastic Holder
480 g	12x3	36 sets / 19 Kgs / 1.7 CUFT	



## HK-09SBS 9 Piece SAE Extra Long Wobble Hex Key Wrench Set - S2 Material

Item No.	Size	Item No.	Size
<b>Wobble Hex Key Wrench (S2 Material):</b>			
590904BS	1/16"	591512BS	3/16"
591005BS	5/64"	591816BS	1/4"
591106BS	3/32"	592020BS	5/16"
591208BS	1/8"	592324BS	3/8"
591310BS	5/32"		Plastic Holder
480 g	12x3	36 sets / 19 Kgs / 1.7 CUFT	

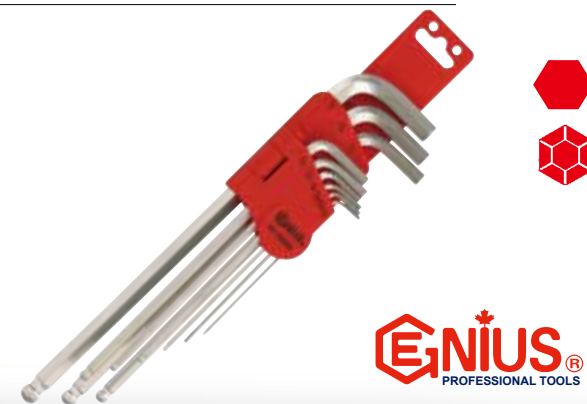



# Key Wrench Sets

## SK-010SS 10 Piece Star Key Wrench Set - S2 Material

Item No. Size Item No. Size

### Star Key Wrench (S2 Material):

580509S	T-9	580627S	T-27
580510S	T-10	580730S	T-30
580615S	T-15	580840S	T-40
580620S	T-20	580845S	T-45
580625S	T-25	580950S	T-50

Plastic Holder

280 g 12x6 72 sets / 22 Kgs / 1.5 CUFT



## SK-010TS 10 Piece Extra Long Tamperproof Star Key Wrench Set - S2 Material

Item No. Size Item No. Size

### Extra Long Tamperproof Star Key Wrench (S2 Material):

580809TS	T-9	581427TS	T-27
581010TS	T-10	581630TS	T-30
581015TS	T-15	581840TS	T-40
581120TS	T-20	582045TS	T-45
581225TS	T-25	582250TS	T-50

Plastic Holder

480 g 12x3 36 sets / 19.3 Kgs / 1.8 CUFT



## HK-07TSS 7 Piece Triple Square Key Wrench Set - S2 Material

Item No. Size Item No. Size

### Triple Square Key Wrench (S2 Material):

582705MS	M5	583112MS	M12
582806MS	M6	583214MS	M14
582908MS	M8	583416MS	M16
583010MS	M10	Pouch Bag	

920 g 20 sets / 19.5 Kgs / 1.07 CUFT



## BT-015MF 15 in 1 Multi-Function Bike Tool Folding Set

### Description

2, 2.5, 3, 4, 5 & 6mm Hex,  
#2 Phillips, 0.8 x 5mm Slotted,  
Chain Rivet Extractor, Tire Lever,  
Spoke Wrench, Bottle Opener,  
8, 9, 10mm Spanner

Sliding Card

200 g 12x6 72 sets / 17 Kgs / 1.16 CUFT



## CK-007BW 7 Piece Folding Hex & Screwdriver Key Wrench Set

### Description

2.5, 3, 4, 5 & 6mm Hex, #2 Phillips, 0.8 x 5mm Slotted  
Sliding Card

120 g 12x8 96 sets / 14 Kgs / 1.2 CUFT



# Key Wrench Sets



## **HK-007BM** 7 Piece Metric Folding Hex Key Wrench Set

### Description

#### Hex Key Wrench:

1.5, 2, 2.5, 3, 4, 5 & 6mm

#### Sliding Card

 100 g  12x8 96 sets / 12 Kgs / 1.2 CUFT

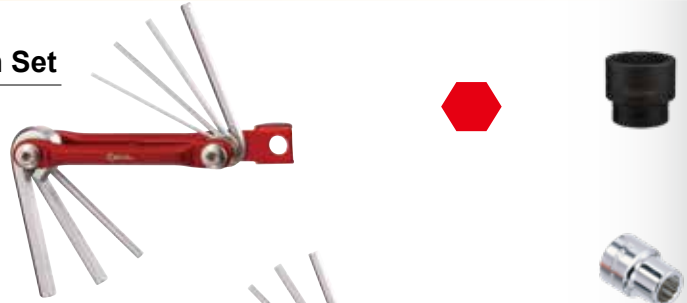



## **HK-008BS** 8 Piece SAE Folding Hex Key Wrench Set

### Description

#### Hex Key Wrench:

1/16, 5/64, 3/32, 1/8, 5/32, 3/16, 7/32 & 1/4"

#### Sliding Card

 120 g  12x8 96 sets / 14 Kgs / 1.2 CUFT

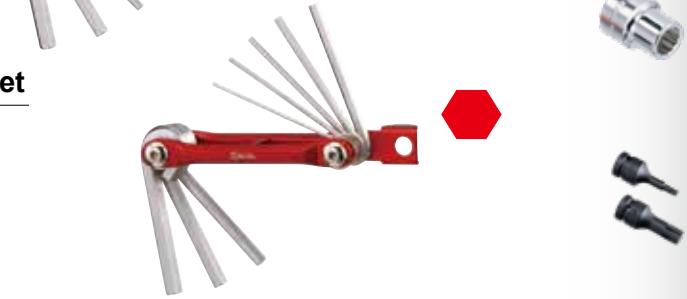



## **HK-007BMW** 7 Piece Metric Folding Wobble Hex Key Wrench Set

### Description

#### Wobble Hex Key Wrench:

1.5, 2, 2.5, 3, 4, 5 & 6mm

#### Sliding Card

 100 g  12x8 96 sets / 12 Kgs / 1.2 CUFT

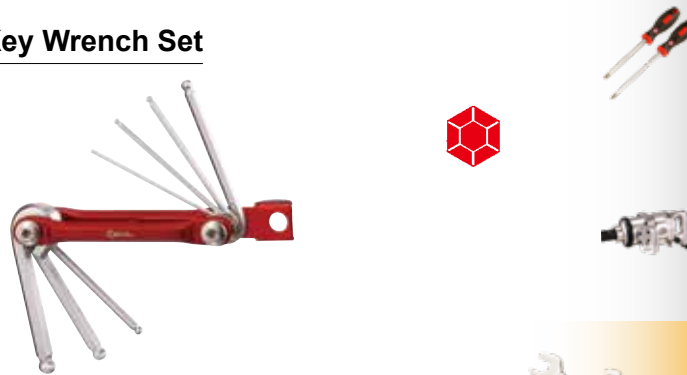



## **HK-008BSW** 8 Piece SAE Wobble Folding Hex Key Wrench Set

### Description

#### Wobble Hex Key Wrench:

1/16, 5/64, 3/32, 1/8, 5/32, 3/16, 7/32 & 1/4"

#### Sliding Card

 120 g  12x8 96 sets / 14 Kgs / 1.2 CUFT





## **SK-007BW** 7 Piece Folding Star Key Wrench Set

### Description

#### Star Key Wrench:

T-6, 7, 8, 9, 10, 15, 20

#### Sliding Card

 85 g  12x8 96 sets / 10.5 Kgs / 1.2 CUFT

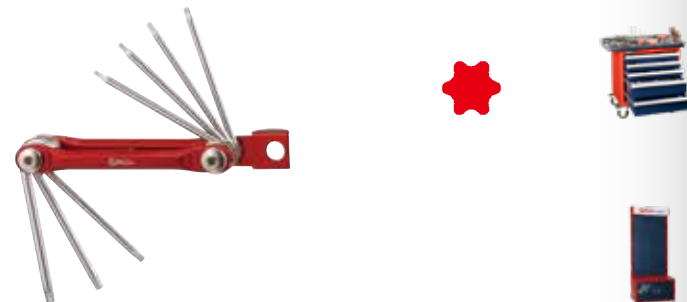



## **SK-007BTW** 7 Piece Folding Tamperproof Star Key Wrench Set

### Description

#### Tamperproof Star Key Wrench:

T-6, 7, 8, 9, 10, 15, 20

#### Sliding Card

 85 g  12x8 96 sets / 10.5 Kgs / 1.2 CUFT



# Key Wrench Sets



## **HK-007GMF** 7 Piece Metric Folding Hex Key Wrench Set

### Description

#### Hex Key Wrench:

1.5, 2, 2.5, 3, 4, 5 & 6mm

#### Sliding Card

 170 g  10x6 60 sets / 13 Kgs / 1.61 CUFT





## **HK-009GMF** 9 Piece Metric Folding Hex Key Wrench Set

### Description

#### Hex Key Wrench:

1.5, 2, 2.5, 3, 4, 5, 6, 8 & 10mm

#### Sliding Card

 300 g  10x6 60 sets / 20.5 Kgs / 1.61 CUFT





## **HK-008GSF** 8 Piece SAE Folding Hex Key Wrench Set

### Description

#### Hex Key Wrench:

1/16, 5/64, 3/32, 1/8, 5/32, 3/16, 7/32 & 1/4"

#### Sliding Card

 190 g  10x6 60 sets / 14 Kgs / 1.61 CUFT





## **HK-007GMB** 7 Piece Metric Folding Wobble Hex Key Wrench Set

### Description

#### Wobble Hex Key Wrench:

1.5, 2, 2.5, 3, 4, 5 & 6mm

#### Sliding Card

 170 g  10x6 60 sets / 13 Kgs / 1.61 CUFT





## **HK-009GMB** 9 Piece Metric Folding Wobble Hex Key Wrench Set

### Description

#### Wobble Hex Key Wrench:

1.5, 2, 2.5, 3, 4, 5, 6, 8 & 10mm

#### Sliding Card

 300 g  10x6 60 sets / 20.5 Kgs / 1.61 CUFT





## **HK-008GSB** 8 Piece SAE Folding Wobble Hex Key Wrench Set

### Description

#### Wobble Hex Key Wrench:

1/16, 5/64, 3/32, 1/8, 5/32, 3/16, 7/32 & 1/4"

#### Sliding Card

 190 g  10x6 60 sets / 14 Kgs / 1.61 CUFT



# Key Wrench Sets & Offset Screwdrivers

## SK-009G 9 Piece Folding Star Key Wrench Set

### Description

#### Star Key Wrench:

T-8, 9, 10, 15, 20, 25, 27, 30, 40

Sliding Card

230 g 10x6 60 sets / 16 Kgs / 1.61 CUFT



## SK-009GT 9 Piece Folding Tamperproof Star Key Wrench Set

### Description

#### Tamperproof Star Key Wrench:

T-8, 9, 10, 15, 20, 25, 27, 30, 40

Sliding Card

230 g 10x6 60 sets / 16 Kgs / 1.61 CUFT

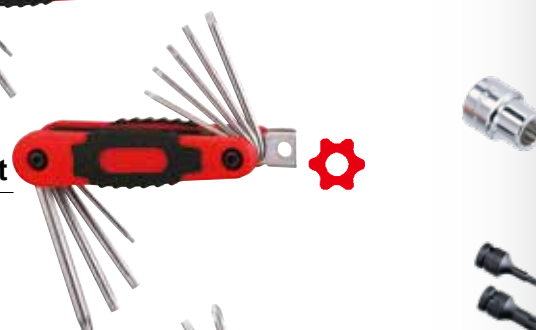

## CK-008G 8 Piece Folding Hex & Screwdriver Key Wrench Set

### Description

2, 2.5, 3, 4, 5 & 6mm Hex, #2 Philips, 0.8 x 5mm Slotted

Sliding Card

200 g 10x6 60 sets / 14 Kgs / 1.61 CUFT

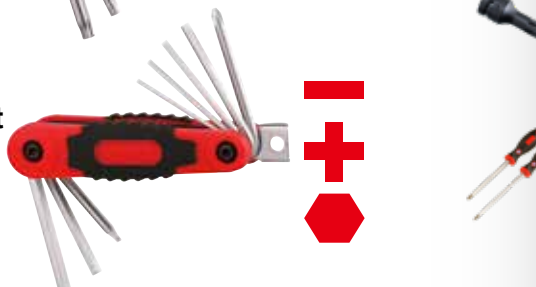

## HK-007HE 7 Piece Metric Hex Key Wrench Folding Set

### Description

#### Metric Hex Key Wrench:

2, 2.5, 3, 4, 5, 6 & 8mm

Sliding Card

210 g 12x6 72 sets / 16.4 Kgs / 1.1 CUFT



## HK-009HE 9 Piece Metric Hex Key Wrench Folding Set

### Description

#### Metric Hex Key Wrench:

1.5, 2, 2.5, 3, 4, 5, 6, 8 & 10mm

Sliding Card

345 g 12x6 72 sets / 25.7 Kgs / 1.0 CUFT



## Offset Screwdrivers

ITEM NO.	Size	L1 mm	Length mm	Weight g	PCS inner/ctn	G.W. KGS	CUFT
560610	1.0 x 6.0mm	20	125	40	45 / 180	8.5	1.60
560812	1.2 x 8.0mm	24	150	75	45 / 180	14.5	1.60
560916	1.6 x 9.0mm	28	175	90	45 / 180	17.5	1.60
570012	#1 - #2	22	125	40	45 / 180	8.5	1.60
570034	#3 - #4	30	175	90	45 / 180	17.0	1.60

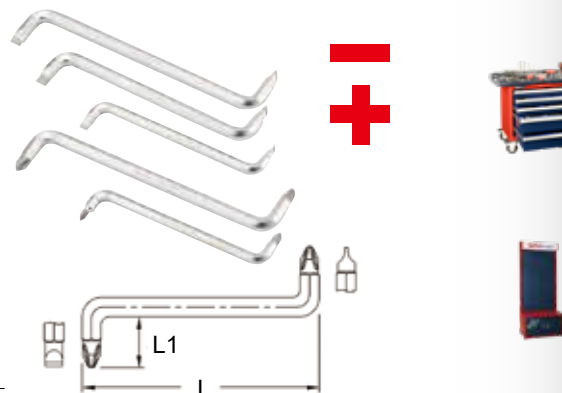

## OS-505SP 5 Piece Slotted & Philips Offset Screwdriver Set

### Item No. Size

#### Offset Screwdriver:

560610 1.0 x 6.0mm Slotted  
 560812 1.2 x 8.0mm Slotted  
 560916 1.6 x 9.0mm Slotted  
 570012 #1 - 2 Philips  
 570034 #3 - 4 Philips

Sliding Card

370 g 10x4 40 sets / 16 Kgs / 0.71 CUFT



# Hex Key Wrenches

## Metric Hex Key Wrenches

ITEM NO.	Size mm	L1 mm	Length mm	Weight g	PCS	G.W.	CUFT
					inner/ctn	KGS	
570515	1.5	14	45	1	50 / 600	2.0	0.30
570520	2	16	50	2	50 / 600	2.0	0.30
570625	2.5	18	56	3	50 / 600	3.0	0.30
570630	3	20	63	5	30 / 360	3.0	0.30
570735	3.5	22	65	10	30 / 360	4.5	0.30
570740	4	25	70	10	30 / 360	4.5	0.30
570845	4.5	26	75	15	10 / 200	4.0	0.59
570850	5	28	80	20	10 / 200	5.0	0.59
570855	5.5	30	85	25	10 / 200	6.0	0.59
570960	6	32	90	30	10 / 200	7.0	0.59
570970	7	34	95	40	10 / 200	9.0	0.59
571080	8	36	100	60	5 / 100	7.0	0.59
571190	9	38	106	80	5 / 100	9.0	0.59
571210	10	40	112	100	5 / 100	11.5	0.59
571211	11	42	118	130	5 / 100	14.0	0.59
571312	12	45	125	170	5 / 100	18.0	0.59
571313	13	50	132	230	5 / 100	24.0	0.59
571414	14	56	140	260	5 / 100	27.5	0.77
571516	16	57	153	380	5 / 50	20.0	0.62
571617	17	63	160	440	5 / 50	23.0	0.62
571719	19	70	180	620	2 / 30	19.5	0.69

## SAE Hex Key Wrenches

ITEM NO.	Size inch	L1 mm	Length mm	Weight g	PCS	G.W.	CUFT
					inner/ctn	KGS	
590503	1/20	12	40	1	50 / 600	2.0	0.30
590504	1/16	14	45	1	50 / 600	2.0	0.30
590605	5/64	16	50	2	50 / 600	2.0	0.30
590606	3/32	18	56	3	50 / 600	3.0	0.30
590607	7/64	19	59	5	30 / 360	3.0	0.30
590608	1/8	20	63	6	30 / 360	3.0	0.30
590709	9/64	22	65	8	30 / 360	4.0	0.30
590710	5/32	25	70	10	30 / 360	4.5	0.30
590812	3/16	28	80	15	10 / 200	4.0	0.59
590814	7/32	30	85	20	10 / 200	5.0	0.59
590916	1/4	32	90	30	10 / 200	7.0	0.59
591020	5/16	36	100	60	5 / 100	7.0	0.59
591124	3/8	40	112	90	5 / 100	10.0	0.59
591328	7/16	42	118	140	5 / 100	15.0	0.59
591432	1/2	45	125	210	5 / 100	22.5	0.59
591536	9/16	56	140	280	5 / 50	15.0	0.62
591540	5/8	63	160	380	5 / 50	20.0	0.62
591848	3/4	70	180	620	2 / 30	19.5	0.69

## HK-025MS 25 Piece Metric & SAE Hex Key Wrench Set

Item No.	Size	Item No.	Size
<b>Hex Key Wrench:</b>			
570515	1.5mm	590504	1/16"
570520	2mm	590605	5/64"
570625	2.5mm	590606	3/32"
570630	3mm	590607	7/64"
570740	4mm	590608	1/8"
570845	4.5mm	590709	9/64"
570850	5mm	590710	5/32"
570855	5.5mm	590812	3/16"
570960	6mm	590814	7/32"
570970	7mm	590916	1/4"
571080	8mm	591020	5/16"
571190	9mm	591124	3/8"
571210	10mm	Pouch Bag	

 840 g

 6x4 24 sets / 21 Kgs / 0.92 CUFT

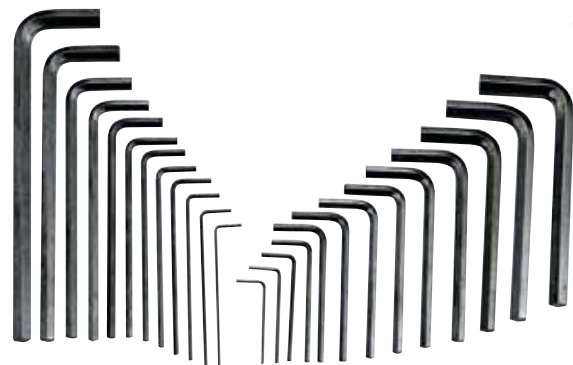
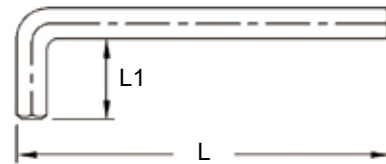

Wrenches & Torque Wrenches

# Extra Long Hex Key Wrenches

## Metric Extra Long Hex Key Wrenches

ITEM NO.	Size mm	L1 mm	Length mm	Weight g	PCS	G.W.	CUFT
					inner/ctn	KGS	
570915L	1.5	14	90	2	30 / 360	2.0	0.30
571020L	2	15	100	3	30 / 360	2.0	0.30
571125L	2.5	18	112	5	20 / 240	2.5	0.30
571230L	3	20	126	8	20 / 240	3.0	0.30
571335L	3.5	22	134	12	10 / 200	3.5	0.59
571440L	4	25	142	20	10 / 200	5.0	0.59
571545L	4.5	26	150	25	10 / 200	6.0	0.59
571650L	5	28	160	30	10 / 200	7.0	0.59
571760L	6	32	180	50	10 / 150	8.5	0.52
571870L	7	34	190	75	10 / 150	12.5	0.52
572080L	8	36	200	100	10 / 100	11.0	0.41
572190L	9	38	210	140	10 / 100	15.0	0.62
572210L	10	40	224	180	10 / 100	19.0	0.62
572411L	11	42	236	230	10 / 100	24.0	0.62
572512L	12	45	250	270	5 / 60	17.5	0.52
572613L	13	50	260	390	5 / 60	24.5	0.52
572814L	14	55	280	450	5 / 30	14.5	0.45
572916L	16	60	300	700	5 / 30	22.0	0.45
573117L	17	63	320	730	5 / 30	23.0	0.45
573219L	19	70	360	980	1 / 20	20.5	0.45



## SAE Extra Long Hex Key Wrenches

ITEM NO.	Size inch	L1 mm	Length mm	Weight g	PCS	G.W.	CUFT
					inner/ctn	KGS	
590803L	1/20	12	72	2	30 / 360	2.0	0.30
590904L	1/16	14	90	2	30 / 360	2.0	0.30
591005L	5/64	15	100	3	30 / 360	2.0	0.30
591106L	3/32	18	112	5	20 / 240	2.5	0.30
591208L	1/8	20	126	8	20 / 240	3.0	0.30
591310L	5/32	25	142	12	10 / 200	3.5	0.59
591512L	3/16	28	160	25	10 / 200	6.0	0.59
591614L	7/32	30	170	30	10 / 200	7.0	0.59
591816L	1/4	32	180	50	10 / 150	8.5	0.52
592020L	5/16	36	200	100	10 / 100	11.0	0.41
592324L	3/8	40	224	170	10 / 100	18.5	0.62
592428L	7/16	42	236	230	10 / 100	24.0	0.62
592632L	1/2	45	250	380	5 / 60	24.0	0.52
592836L	9/16	55	280	460	5 / 30	15.0	0.45
593040L	5/8	63	320	680	5 / 30	21.5	0.45
593248L	3/4	70	360	980	1 / 20	20.5	0.45

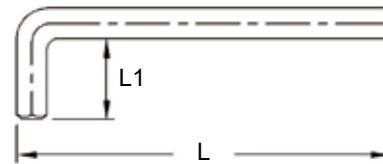

## HK-009ML 9 Piece Metric Extra Long Hex Key Wrench Set

Item No.	Size	Item No.	Size
<b>Long Hex Key Wrench:</b>			
570915L	1.5mm	571650L	5mm
571020L	2mm	571760L	6mm
571125L	2.5mm	572080L	8mm
571230L	3mm	572210L	10mm
571440L	4mm	Plastic Holder	

500 g      12x3 36 sets / 19 Kgs / 1.7 CUFT



# Hex Key Wrench Sets

## HK-009M 9 Piece Metric Hex Key Wrench Set

Item No.	Size	Item No.	Size
<b>Hex Key Wrench:</b>			
570515	1.5mm	570850	5mm
570520	2mm	570960	6mm
570625	2.5mm	571080	8mm
570630	3mm	571210	10mm
570740	4mm	Plastic Holder	

310 g 12x6 72 sets / 24 Kgs / 1.88 CUFT

## HK-009S 9 Piece SAE Hex Key Wrench Set

Item No.	Size	Item No.	Size
<b>Hex Key Wrench:</b>			
590504	1/16"	590812	3/16"
590605	5/64"	590916	1/4"
590606	3/32"	591020	5/16"
590608	1/8"	591124	3/8"
590710	5/32"	Plastic Holder	

300 g 12x6 72 sets / 24 Kgs / 1.88 CUFT

## HK-010M 10 Piece Metric Hex Key Wrench Set

Item No.	Size	Item No.	Size
<b>Hex Key Wrench:</b>			
570515	1.5mm	570850	5mm
570520	2mm	570855	5.5mm
570625	2.5mm	570960	6mm
570630	3mm	571080	8mm
570740	4mm	571210	10mm

Plastic Holder

310 g 12x6 72 sets / 23.5 Kgs / 1.44 CUFT

## HK-010S 10 Piece SAE Hex Key Wrench Set

Item No.	Size	Item No.	Size
<b>Hex Key Wrench:</b>			
590504	1/16"	590812	3/16"
590605	5/64"	590814	7/32"
590606	3/32"	590916	1/4"
590608	1/8"	591020	5/16"
590710	5/32"	591124	3/8"

Plastic Holder

300 g 12x6 72 sets / 22.5 Kgs / 1.44 CUFT

## HK-007MF 7 Piece Metric Hex Key Wrench Folding Set

**Description**  
**Hex Key Wrench:**  
 1.27, 1.5, 2, 2.5, 3, 4 & 5mm  
**Sliding Card**

130 g 12x12 144 sets / 20 Kgs / 2 CUFT

## HK-009SF 9 Piece SAE Hex Key Wrench Folding Set

**Description**  
**Hex Key Wrench:**  
 1/20, 1/16, 5/64, 3/32, 7/64, 1/8, 9/64, 5/32 & 3/16"  
**Sliding Card**

130 g 12x12 144 sets / 21 Kgs / 2 CUFT



Wrenches & Torque Wrenches

# Extra Long Wobble Hex Key Wrenches

## Metric Extra Long Wobble Hex Key Wrenches

ITEM NO.	Size mm	L1 mm	Length mm	Weight g	PCS	G.W.	CUFT
					inner/ctn	KGS	
570915B	1.5	14	90	2	30 / 360	2.0	0.30
571020B	2	15	100	3	30 / 360	2.0	0.30
571125B	2.5	18	112	5	20 / 240	2.5	0.30
571230B	3	20	126	8	20 / 240	3.0	0.30
571335B	3.5	22	134	12	10 / 200	3.5	0.59
571440B	4	25	142	18	10 / 200	4.5	0.59
571545B	4.5	26	150	25	10 / 200	6.0	0.59
571650B	5	28	160	30	10 / 200	7.5	0.59
571760B	6	32	180	50	10 / 150	8.5	0.52
571870B	7	34	190	75	10 / 150	12.0	0.52
572080B	8	36	200	100	10 / 100	11.0	0.41
572190B	9	38	210	140	10 / 100	15.0	0.62
572210B	10	40	224	180	10 / 100	19.0	0.62



## SAE Extra Long Wobble Hex Key Wrenches

ITEM NO.	Size inch	L1 mm	Length mm	Weight g	PCS	G.W.	CUFT
					inner/ctn	KGS	
590904B	1/16	14	90	2	30 / 360	2.0	0.30
591005B	5/64	15	100	3	30 / 360	2.0	0.30
591106B	3/32	18	112	5	20 / 240	2.5	0.30
591208B	1/8	20	126	8	20 / 240	3.0	0.30
591310B	5/32	25	142	12	10 / 200	3.5	0.59
591512B	3/16	28	160	25	10 / 200	6.0	0.59
591614B	7/32	30	170	30	10 / 200	7.5	0.59
591816B	1/4	32	180	50	10 / 150	8.5	0.52
592020B	5/16	36	200	100	10 / 100	11.0	0.41
592324B	3/8	40	224	170	10 / 100	18.5	0.62

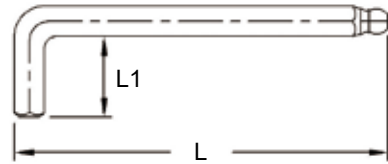

## HK-009MB 9 Piece Metric Extra Long Wobble Hex Key Wrench Set

Item No.	Size	Item No.	Size
<b>Wobble Hex Key Wrench:</b>			
570915B	1.5mm	571650B	5mm
571020B	2mm	571760B	6mm
571125B	2.5mm	572080B	8mm
571230B	3mm	572210B	10mm
571440B	4mm	Plastic Holder	

480 g      12x3 36 sets / 19 Kgs / 1.7 CUFT



## HK-009SB 9 Piece SAE Extra Long Wobble Hex Key Wrench Set

Item No.	Size	Item No.	Size
<b>Wobble Hex Key Wrench:</b>			
590904B	1/16"	591512B	3/16"
591005B	5/64"	591816B	1/4"
591106B	3/32"	592020B	5/16"
591208B	1/8"	592324B	3/8"
591310B	5/32"	Plastic Holder	

480 g      12x3 36 sets / 18.5 Kgs / 1.7 CUFT





# Star Key Wrenches

## Star Key Wrenches

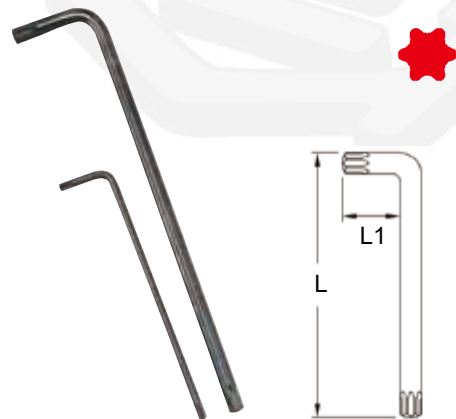

ITEM NO.	Size mm	L1 mm	Length mm	Weight g	PCS inner/ctn	G.W. KGS	CUFT 
580506	T-6	14	44	2	50 / 600	2.0	0.30
580507	T-7	14	47	3	50 / 600	3.0	0.30
580508	T-8	15	50	3	50 / 600	3.0	0.30
580509	T-9	18	55	4	50 / 600	3.5	0.30
580510	T-10	20	60	4	50 / 600	3.5	0.30
580615	T-15	22	64	5	50 / 600	4.0	0.30
580620	T-20	23	68	7	50 / 600	5.0	0.30
580625	T-25	24	72	10	30 / 360	4.5	0.30
580627	T-27	25	78	16	30 / 360	6.5	0.30
580730	T-30	26	83	20	30 / 360	8.0	0.30
580840	T-40	28	89	30	10 / 200	7.0	0.59
580845	T-45	31	96	40	10 / 200	9.5	0.59
580950	T-50	35	105	60	10 / 200	13.0	0.59
581055	T-55	40	116	120	5 / 100	13.0	0.59
581260	T-60	45	125	180	5 / 100	19.5	0.59
581470	T-70	50	140	250	5 / 100	26.0	0.59



### SK-010S 10 Piece Star Key Wrench Set

Item No.	Size	Item No.	Size
<b>Star Key Wrench:</b>			
580509	T-9	580627	T-27
580510	T-10	580730	T-30
580615	T-15	580840	T-40
580620	T-20	580845	T-45
580625	T-25	580950	T-50

Plastic Holder



 280 g       12x6 72 sets / 22 Kgs / 1.5 CUFT



### SK-008L 8 Piece Extra Long Star Key Wrench Set

Item No.	Size	Item No.	Size
<b>Extra Long Star Key Wrench:</b>			
581010L	T-10	581630L	T-30
581015L	T-15	581840L	T-40
581120L	T-20	582250L	T-50
581225L	T-25	582255L	T-55

Plastic Holder



 550 g       12x3 36 sets / 22.5 Kgs / 1.46 CUFT



### SK-010L 10 Piece Extra Long Star Key Wrench Set

Item No.	Size	Item No.	Size
<b>Extra Long Star Key Wrench:</b>			
580809L	T-9	581427L	T-27
581010L	T-10	581630L	T-30
581015L	T-15	581840L	T-40
581120L	T-20	582045L	T-45
581225L	T-25	582250L	T-50

Plastic Holder

 480 g       12x3 36 sets / 19.3 Kgs / 1.8 CUFT





### TX-008F 8 Piece Star Key Wrench Folding Set

**Description**

**Star Key Wrench:**

T9, T10, T15, T20, T25, T27, T30 & T40

Sliding Card

 215 g       12x6 72 sets / 16.8 Kgs / 1.2 CUFT

Made of Chrome Vanadium Steel

# Tamperproof Star & Triple Square Key Wrenches

## Long Tamperproof Star Key Wrenches

ITEM NO.	Size mm	L1 mm	Length mm	Weight g	PCS	G.W.	CUFT
					inner/ctn	KGS	
580807T	T-7	16	71	4	30 / 360	2.5	0.30
580808T	T-8	16	76	5	30 / 360	3.0	0.30
580809T	T-9	16	80	6	30 / 360	3.0	0.30
580910T	T-10	17	86	6	30 / 360	3.0	0.30
580915T	T-15	18	90	8	30 / 360	4.0	0.30
581020T	T-20	19	95	10	20 / 240	3.5	0.30
581025T	T-25	20	100	15	20 / 240	4.5	0.30
581127T	T-27	21	105	25	10 / 200	6.0	0.59
581230T	T-30	24	114	30	10 / 200	7.0	0.59
581240T	T-40	26	124	45	10 / 150	7.5	0.52
581345T	T-45	29	137	60	10 / 100	7.0	0.41
581550T	T-50	32	152	90	10 / 100	10.0	0.62
581755T	T-55	35	171	170	10 / 100	18.0	0.62
581960T	T-60	38	190	260	5 / 60	17.0	0.52
582270T	T-70	45	220	360	5 / 60	22.5	0.52

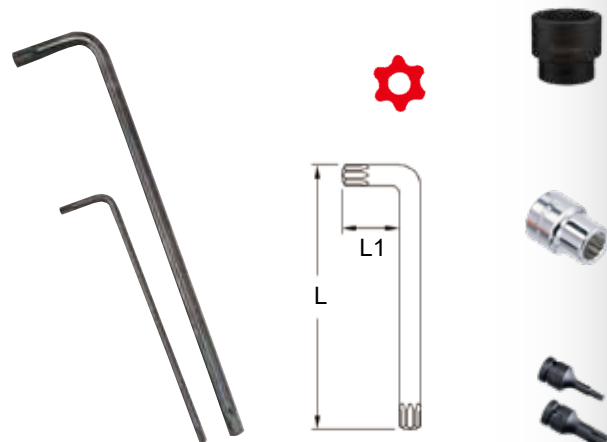

## SK-008TL 8 Piece Extra Long Tamperproof Star Key Wrench Set

Item No.	Size	Item No.	Size
<b>Extra Long Tamperproof Star Key Wrench:</b>			
581010T	T-10	581630T	T-30
581015T	T-15	581840T	T-40
581120T	T-20	582250T	T-50
581225T	T-25	582255T	T-55

Plastic Holder

550 g 12x3 36 sets / 22.5 Kgs / 1.46 CUFT



## SK-010T 10 Piece Extra Long Tamperproof Star Key Wrench Set

Item No.	Size	Item No.	Size
<b>Extra Long Tamperproof Star Key Wrench:</b>			
580809T	T-9	581427T	T-27
581010T	T-10	581630T	T-30
581015T	T-15	581840T	T-40
581120T	T-20	582045T	T-45
581225T	T-25	582250T	T-50

Plastic Holder

480 g 12x3 36 sets / 19.3 Kgs / 1.8 CUFT



## Triple Square Key Wrenches

ITEM NO.	Size mm	L1 mm	Length mm	Weight g	PCS	G.W.	CUFT
					inner/ctn	KGS	
582705M	M5	25	72	15	20 / 240	4.5	0.30
582806M	M6	28	80	30	20 / 240	8.0	0.30
582908M	M8	32	90	50	10 / 150	8.5	0.52
583010M	M10	36	100	85	10 / 150	14.0	0.52
583112M	M12	40	112	130	10 / 150	20.5	0.52
583214M	M14	45	125	200	10 / 60	13.0	0.34
583416M	M16	56	140	300	10 / 60	19.0	0.34



## HK-007TS 7 Piece Triple Square Key Wrench Set

Item No.	Size	Item No.	Size
<b>Triple Square Key Wrench:</b>			
582705M	M5	583112M	M12
582806M	M6	583214M	M14
582908M	M8	583416M	M16
583010M	M10	Pouch Bag	

920 g 20 sets / 19.5 Kgs / 1.07 CUFT



Made of Chrome Vanadium Steel

**NIUS**  
PROFESSIONAL TOOLS

# Adjustable Wrenches & Pipe Wrenches

## Adjustable Wrenches

ITEM NO.	Jaw Capacity mm	Length mm	Weight g	PCS	G.W. KGS	CUFT
				inner/ctn		
780128	13	100	60	12 / 288	19.5	2.80
780192	20	150	130	6 / 144	21.5	2.28
780256	28	200	260	6 / 72	20.5	1.70
780320	30	250	400	6 / 54	26.5	1.64
780384	38	300	660	6 / 36	24.0	1.82
780480	46	380	1230	2 / 10	15.0	0.69
780576	58	450	2020	2 / 10	19.5	0.82
780692	70	600	3300	1 / 6	21.0	0.89

Made of Chrome Vanadium Steel



## Heavy Duty Pipe Wrenches

ITEM NO.	Length Inch	Weight g	PCS	G.W. KGS	CUFT
			inner/ctn		
782200	8	470	6 / 36	18.0	0.40
782250	10	840	6 / 24	21.0	0.50
782300	12	1100	6 / 24	27.0	0.70
782350	14	1420	6 / 12	18.0	0.50
782460	18	2440	2 / 8	20.5	0.60
782610	24	4330	2 / 6	27.0	0.80
782910	36	8000	1 / 2	17.0	0.80
783220	48	15000	1 / 2	29.0	1.30

Chrome Molybdenum Steel Hook Jaw



## Aluminum Pipe Wrenches

ITEM NO.	Length Inch	Weight g	PCS	G.W. KGS	CUFT
			inner/ctn		
784350	14	880	6 / 24	22.0	0.70
784460	18	1460	2 / 12	18.5	0.70
784610	24	2440	2 / 8	20.5	0.80
784910	36	4500	1 / 2	11.0	1.70
785220	48	8000	1 / 2	17.0	1.20

Chrome Molybdenum Steel Hook Jaw



## Heavy Duty Pipe Wrenches

ITEM NO.	Length Inch	Weight g	PCS	G.W. KGS	CUFT
			inner/ctn		
V782S08	8	360	6 / 36	14.0	0.34
V782S10	10	770	6 / 24	19.5	0.60
V782S12	12	1100	6 / 24	27.0	0.66
V782S14	14	1600	6 / 12	20.0	0.52
V782S18	18	2550	2 / 8	21.0	0.50
V782S24	24	3700	2 / 6	23.0	0.70
V782S36	36	8400	1 / 2	18.0	0.75
V782S48	48	13500	1 / 2	29.0	1.20

Chrome Vanadium Steel Hook Jaw



**VMARK**

## Aluminum Pipe Wrenches

ITEM NO.	Length Inch	Weight g	PCS	G.W. KGS	CUFT
			inner/ctn		
V794A14	14	1000	6 / 24	25.0	0.95
V794A18	18	1630	2 / 12	20.5	0.80
V794A24	24	2440	2 / 8	20.5	0.90
V794A36	36	5000	1 / 2	11.0	0.75
V794A48	48	8000	1 / 2	18.0	1.20

Chrome Vanadium Steel Hook Jaw



**VMARK**

# Digital Torque Wrenches & Torque Screwdrivers

## Digital Torque Wrenches



ITEM NO.	Drive	Torque Range	Length mm	Weight g	PCS	G.W. KGS	CUFT
V38200	3/8"	20 ~ 200 Nm	575	1200	6	13.0	1.52
V48340	1/2"	34 ~ 340 Nm	790	1680	4	11.0	1.37



- Accuracy: CW  $\pm 1\%$ , CCW  $\pm 1.5\%$
- Unit selection: Nm, ft.lb., in.lb., kg-m
- Battery: AAA x 2
- Power: Auto shutdown after 90 seconds idle
- Operating temperature:  $5^{\circ}\text{C} \sim 42^{\circ}\text{C}$
- Storage temperature:  $-20^{\circ}\text{C} \sim 50^{\circ}\text{C}$
- Humidity:  $0 \sim 90\%$
- Non-slip Metal Handle
- ISO-6789 Standards Compliant



## 3 Piece Digital Interchangeable Torque Wrench Set

ITEM NO.	Torque Handle Range	mm	Weight g	PCS	G.W. KGS	CUFT
1434N10	10 ~ 100 Nm	14 x 18	2000	6	13.0	0.92
1434N20	20 ~ 200 Nm	14 x 18	2250	6	14.5	0.92

### Item No. Description

1434N10H 10 ~ 100 Nm Interchangeable Torque Handle, ■ 14 x 18mm  
 (1434N20H) (20 ~ 200 Nm Interchangeable Torque Handle, ■ 14 x 18mm)

### Quick Release Ratchet Head, ■ 14 x 18mm:

14DT38 3/8" Dr.

14DT48 1/2" Dr.

Blow Case



- Accuracy:  $\pm 1\%$
- Memory: 10 readings
- Unit selection: Nm, ft.lb., in.lb., kg-m
- Battery: 1.5V AA Battery x 3  
(Do not use low self-discharge battery)
- Operating temperature:  $-15^{\circ}\text{C} \sim 55^{\circ}\text{C}$
- Storage temperature:  $-40^{\circ}\text{C} \sim 85^{\circ}\text{C}$
- Humidity:  $0 \sim 90\%$

## 1/4" Dr. Torque Screwdrivers

ITEM NO.	Capacity	Length mm	Weight g	PCS	G.W. KGS	CUFT
280005N	1 ~ 5 Nm	150	360	12	5.5	0.30
280045L	9 ~ 50 in. lbs.	150	360	12	5.5	0.30



## TO-227N 27 Piece Nm Torque Screwdriver Set

Item No.	Size	Item No.	Size
<b>Screwdriver Bit, 30mmL:</b>			
1160	1.0 x 6.0mm Slotted	2133	3mm Hex
1165	1.0 x 6.5mm Slotted	2134	4mm Hex
1170	1.2 x 7.0mm Slotted	2135	5mm Hex
1101	#1 Philips	2136	6mm Hex
1102	#2 Philips	3108	1/8" Hex
1103	#3 Philips	3110	5/32" Hex
7110	T-10 Tamperproof Star	3112	3/16" Hex
7115	T-15 Tamperproof Star	3114	7/32" Hex
7120	T-20 Tamperproof Star	3116	1/4" Hex
7125	T-25 Tamperproof Star	8104	M4 Triple Square
7127	T-27 Tamperproof Star	8105	M5 Triple Square
7130	T-30 Tamperproof Star	8106	M6 Triple Square
7140	T-40 Tamperproof Star		

Lbf inch: TO-227L also available



### Accessory:

280005N 1/4" Dr. Torque Screwdriver, 1~5 Nm

283508 1/4" Dr. 1/4" Hex Shank Bit Holder

Blow Case

750 g

15 sets / 12.5 Kgs / 0.95 CUFT





TO-227N (TO-227L)





F-35

# Torque Wrenches

## NEW Adjustable Bi-Direction Torque Wrenches

ITEM NO.	Drive	Capacity	Length mm	Weight g	PCS 	G.W. KGS 	CUFT 
290015N	1/4"	3 ~ 15 Nm	193	340	30	11.86	0.77
290030N		6 ~ 30 Nm	300	590	20	10.44	0.95
290150L		30 ~ 150 in. lbs.	193	340	30	11.86	0.77
290250L		50 ~ 250 in. lbs.	300	590	20	10.44	0.95
390030N	3/8"	6 ~ 30 Nm	300	590	20	10.44	0.95
390060N		10 ~ 60 Nm	427	1150	10	14.61	1.15
390100N		20 ~ 100 Nm	462	1500	10	15.21	1.15
390250L		50 ~ 250 in. lbs.	300	590	20	10.44	0.95
390045F		10 ~ 45 ft. lbs.	427	1150	10	14.61	1.15
390075F	15 ~ 75 ft. lbs.	462	1500	10	15.21	1.15	
490100N	1/2"	20 ~ 100 Nm	462	1500	10	15.21	1.15
490200N		40 ~ 200 Nm	517	2200	10	18.40	1.13
490320N		60 ~ 320 Nm	586	2300	6	13.62	0.97
490075F		15 ~ 75 ft. lbs.	462	1500	10	15.21	1.15
490150F		30 ~ 150 ft. lbs.	517	2200	10	18.40	1.13
490230F		50 ~ 230 ft. lbs.	586	2300	6	13.62	0.97
690500N	3/4"	100 ~ 500 Nm	820	3650	4	17.80	1.18
690800N		100 ~ 800 Nm	1111	5480	2	13.60	0.72
691000N		200 ~ 1000 Nm	1335	6160	1	9.90	1.33
691500N		300 ~ 1500 Nm	1702	11870	1	13.12	0.85
690300F		60 ~ 300 ft. lbs.	820	3650	4	17.80	1.18
690600F		100 ~ 600 ft. lbs.	1111	5480	2	13.60	0.72
690700F		150 ~ 700 ft. lbs.	1335	6160	1	9.90	1.33
691000F	200 ~ 1000 ft. lbs.	1702	11870	1	13.12	0.85	
891000N	1"	200 ~ 1000 Nm	1335	6160	1	10.60	1.33
891500N		300 ~ 1500 Nm	1702	11870	1	14.43	0.85
892000N		400 ~ 2000 Nm	2150	13000	1	17.64	1.33
890700F		150 ~ 700 ft. lbs.	1335	6160	1	10.60	1.33
891000F		200 ~ 1000 ft. lbs.	1702	11870	1	14.43	0.85
891500F		300 ~ 1500 ft. lbs.	2150	13000	1	17.64	1.33
993000N	1-1/2"	600 ~ 3000 Nm	2780	15000	1	26.53	1.33
992000F		400 ~ 2000 ft. lbs.	2780	15000	1	26.53	1.33

## Adjustable Torque Wrenches

ITEM NO.	Drive	Capacity	Length mm	Weight g	PCS 	G.W. KGS 	CUFT 
280030N	1/4"	6 ~ 30 Nm	350	740	20	20.0	1.12
280250L		40 ~ 250 in. lbs.	350	740	20	20.0	1.12
380030N	3/8"	6 ~ 30 Nm	350	740	20	20.0	1.12
380110N		19 ~ 110 Nm	385	960	12	16.0	1.18
380250L		40 ~ 250 in. lbs.	350	740	20	20.0	1.12
380080F		15 ~ 80 ft. lbs.	385	960	12	16.0	1.18
480210N	1/2"	40 ~ 210 Nm	535	1700	10	21.0	1.31
480350N		70 ~ 350 Nm	645	2540	6	19.0	0.92
480150F		30 ~ 150 ft. lbs.	535	1700	10	21.0	1.31
480250F		50 ~ 250 ft. lbs.	645	2540	6	19.0	0.92
680500N	3/4"	100 ~ 500 Nm	865	3660	4	20.0	1.07
680700N		140 ~ 700 Nm	1092	5940	4	31.0	1.93
680980N		140 ~ 980 Nm	1230	6460	2	17.0	1.13
681500N		300 ~ 1500 Nm	1700	13000	1	13.5	0.76
680300F		50 ~ 300 ft. lbs.	865	3660	4	20.0	1.07
680600F		100 ~ 600 ft. lbs.	1092	5940	4	31.0	1.93
680700F		100 ~ 700 ft. lbs.	1230	6460	2	17.0	1.13
681000F		200 ~ 1000 ft. lbs.	1700	13000	1	13.5	0.76
880980N	1"	140 ~ 980 Nm	1230	6460	2	17.0	1.13
881500N		300 ~ 1500 Nm	1700	15400	1	16.0	0.76
NEW 882000N		400 ~ 2000 Nm	2175	17300	1	17.8	1.33
880700F		100 ~ 700 ft. lbs.	1230	6460	2	17.0	1.13
881000F		200 ~ 1000 ft. lbs.	1700	15400	1	16.0	0.76
NEW 881500F		300 ~ 1500 ft. lbs.	2175	17300	1	17.8	1.33



# Torque Multipliers

## Torque Multipliers



**Caution** • Do not use with impact wrench

ITEM NO.	Drive Inch	Capacity	Length mm	Weight g	PCS	G.W. KGS	CUFT
401000	Input: 1/2" Output: 3/4"	Max: 500 Nm/365 ft.lbs. Max: 1500 Nm/1100 ft. lbs. Output/Input = 3/1	420	2330	6	21.5	2.30
602000	Input: 3/4" Output: 1"	Max: 1000 Nm/730 ft. lbs. Max: 3000 Nm/2200 ft. lbs. Output/Input = 3/1	500	4750	4	20.0	1.36



ITEM NO.	Drive Inch	Capacity	Length mm	Weight g	PCS	G.W. KGS	CUFT
401500	Input: 1/2" Output: 3/4"	Max: 150 Nm/110 ft.lbs. Max: 1500 Nm/1100 ft. lbs. Output/Input = 10/1	200	3700	4	16.0	0.96

**NEW**



ITEM NO.	Drive Inch	Capacity	Length mm	Weight Kg	PCS	G.W. KGS	CUFT
494000	Input: 1/2" Output: 1-1/2"	Max: 400 Nm/300 ft.lbs. Max: 4000 Nm/2950 ft. lbs. Output/Input = 10/1	260	16.0	1	16.7	0.64
494008B	Input: 1/2" Output: 1" (Adapter)	Max: 400 Nm/300 ft.lbs. Max: 4000 Nm/2950 ft. lbs. Output/Input = 10/1	260	18.5	1	19.2	0.64

• 494008B includes (494000) & (938008B 1-1/2" F x 1" M Impact Adapter with Steel Ball)

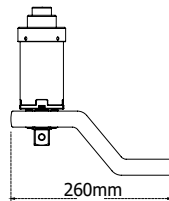

**NEW**



494008B

## Industrial Torque Multipliers

ITEM NO.	Gear Ratio	Torque Ratio	Drive Inch	Capacity	Weight Kg	PCS	G.W. KGS	CUFT
460750	1 : 4	1 : 3.5	Input: 1/2" Output: 3/4"	Max: 286 Nm/211 ft.lbs. Max: 1000 Nm/750 ft. lbs.	4.1	2	8.7	1.04
461100	1 : 4.3	1 : 3.8	Input: 1/2" Output: 3/4"	Max: 395 Nm/291 ft.lbs. Max: 1500 Nm/1100 ft. lbs.	5.2	2	10.9	1.04
482000	1 : 16	1 : 12	Input: 1/2" Output: 1"	Max: 215 Nm/160 ft.lbs. Max: 2700 Nm/2000 ft. lbs.	9.8	2	20.5	1.48
493320	1 : 22	1 : 16.8	Input: 1/2" Output: 1-1/2"	Max: 275 Nm/200 ft.lbs. Max: 4500 Nm/3320 ft. lbs.	15.0	1	15.5	0.86
494420	1 : 22	1 : 16.8	Input: 1/2" Output: 1-1/2"	Max: 357 Nm/265 ft.lbs. Max: 6000 Nm/4420 ft. lbs.	20.0	1	31.0	1.46
495900	1 : 30	1 : 23	Input: 1/2" Output: 1-1/2"	Max: 347 Nm/256 ft.lbs. Max: 8000 Nm/5900 ft. lbs.	31.0	1	42.0	1.46
682000	1 : 4	1 : 3.8	Input: 3/4" Output: 1"	Max: 710 Nm/525 ft.lbs. Max: 2700 Nm/2000 ft. lbs.	9.5	2	20.0	1.48
693320	1 : 5.5	1 : 4.8	Input: 3/4" Output: 1-1/2"	Max: 938 Nm/691 ft.lbs. Max: 4500 Nm/3320 ft. lbs.	14.2	1	14.7	0.86
697370	1 : 30	1 : 23	Input: 3/4" Output: 1-1/2"	Max: 433 Nm/320 ft.lbs. Max: 10000 Nm/7370 ft. lbs.	35.5	1	46.5	1.46



**NEW**



**Caution** • Do not use with impact wrench

**IS**<sup>®</sup>  
AL TOOLS

# Torque Handle Sets

## 10 Piece Torque Handle Set

ITEM NO.	Torque Handle Range	mm	Weight g	PCS	G.W. KGS	CUFT
TO-210N30	6 ~ 30 Nm	9 x 12	1650	10	17.0	1.39
TO-210F25	50 ~ 250 in. lbs.	9 x 12	1650	10	17.0	1.39

- Item No. Description**  
 092N30 6 ~ 30 Nm Interchangeable Torque Handle, 9 x 12mm  
 (092F25) (50 ~ 250 in. lbs. Interchangeable Torque Handle, 9 x 12mm)

**Ratchet Head Torque Handle Fitting, 9 x 12mm:**

- 09RH20 1/4" Dr.

**Open Ended Head Torque Handle Fitting, 9 x 12mm:**

- |        |      |        |      |
|--------|------|--------|------|
| 091207 | 7mm  | 091211 | 11mm |
| 091208 | 8mm  | 091212 | 12mm |
| 091209 | 9mm  | 091213 | 13mm |
| 091210 | 10mm | 091214 | 14mm |

Blow Case



## 12 Piece Torque Handle Set

ITEM NO.	Torque Handle Range	mm	Weight g	PCS	G.W. KGS	CUFT
TO-312N11	19 ~ 110 Nm	9 x 12	2240	6	13.9	1.13
TO-312F80	15 ~ 80 ft. lbs.	9 x 12	2240	6	13.9	1.13

- Item No. Description**  
 092N11 19 ~ 110 Nm Interchangeable Torque Handle, 9 x 12mm  
 (092F80) (15 ~ 80 ft. lbs. Interchangeable Torque Handle, 9 x 12mm)

**Ratchet Head Torque Handle Fitting, 9 x 12mm:**

- 09RH30 3/8" Dr.

**Open Ended Head Torque Handle Fitting, 9 x 12mm:**

- |        |      |        |      |
|--------|------|--------|------|
| 091210 | 10mm | 091215 | 15mm |
| 091211 | 11mm | 091216 | 16mm |
| 091212 | 12mm | 091217 | 17mm |
| 091213 | 13mm | 091218 | 18mm |
| 091214 | 14mm | 091219 | 19mm |

Blow Case



## 8 Piece Torque Handle Set

ITEM NO.	Torque Handle Range	mm	Weight g	PCS	G.W. KGS	CUFT
TO-408N80	15 ~ 80 Nm	14 x 18	3350	6	20.6	1.30
TO-408F60	10 ~ 60 ft. lbs.	14 x 18	3350	6	20.6	1.30

- Item No. Description**  
 148N80 15 ~ 80 Nm Interchangeable Torque Handle, 14 x 18mm  
 (148F60) (10 ~ 60 ft. lbs. Interchangeable Torque Handle, 14 x 18mm)

**Ratchet Head Torque Handle Fitting, 14 x 18mm:**

- 14RH44 1/2" Dr.

**Open Ended Head Torque Handle Fitting, 14 x 18mm:**

- |        |      |        |      |
|--------|------|--------|------|
| 141817 | 17mm | 141826 | 26mm |
| 141822 | 22mm | 141827 | 27mm |
| 141824 | 24mm | 141829 | 29mm |

Blow Case



## 11 Piece Torque Handle Set

ITEM NO.	Torque Handle Range	mm	Weight g	PCS	G.W. KGS	CUFT
TO-411N21	40 ~ 210 Nm	14 x 18	4380	4	18.1	0.86
TO-411F15	30 ~ 150 ft. lbs.	14 x 18	4380	4	18.1	0.86

### Item No. Description

148N21 40 ~ 210 Nm Interchangeable Torque Handle, 14 x 18mm  
 (148F15) (30 ~ 150 ft. lbs. Interchangeable Torque Handle, 14 x 18mm)

### Ratchet Head Torque Handle Fitting, 14 x 18mm:

14RH40 1/2" Dr.

### Open Ended Head Torque Handle Fitting, 14 x 18mm:

141813	13mm	141822	22mm
141814	14mm	141824	24mm
141815	15mm	141827	27mm
141817	17mm	141830	30mm
141819	19mm	Blow Case	



## Open Ended Head - Torque Handle Fittings, 9x12mm

ITEM NO.	Size mm	mm	Length mm	Weight g	PCS	G.W. KGS	CUFT
091207	7	9 x 12	37	35	180	8.0	0.30
091208	8	9 x 12	37	35	180	8.0	0.30
091209	9	9 x 12	37	35	180	8.0	0.30
091210	10	9 x 12	38	40	120	6.0	0.30
091211	11	9 x 12	38	40	120	6.0	0.30
091212	12	9 x 12	39	45	120	6.5	0.30
091213	13	9 x 12	42	50	120	7.0	0.30
091214	14	9 x 12	43	55	120	8.0	0.30
091215	15	9 x 12	43	55	120	8.0	0.30
091216	16	9 x 12	44	65	96	7.5	0.30
091217	17	9 x 12	44	65	96	7.5	0.30
091218	18	9 x 12	44	75	96	8.0	0.30
091219	19	9 x 12	46	75	96	8.0	0.30



## Open Ended Head - Torque Handle Fittings, 14x18mm



ITEM NO.	Size mm	mm	Length mm	Weight g	PCS	G.W. KGS	CUFT
141813	13	14 x 18	62	140	84	13.5	0.44
141814	14	14 x 18	63	150	84	14.0	0.44
141815	15	14 x 18	64	150	84	14.0	0.44
141816	16	14 x 18	64	170	84	15.5	0.44
141817	17	14 x 18	64	170	84	15.5	0.44
141818	18	14 x 18	65	190	70	14.5	0.44
141819	19	14 x 18	65	190	70	14.5	0.44
141821	21	14 x 18	66	210	70	16.0	0.44
141822	22	14 x 18	66	220	70	16.5	0.44
141824	24	14 x 18	67	220	70	17.0	0.44
141826	26	14 x 18	70	270	60	17.5	0.52
141827	27	14 x 18	70	280	60	18.0	0.52
141829	29	14 x 18	74	310	30	10.5	0.45
141830	30	14 x 18	74	310	30	10.5	0.45
141832	32	14 x 18	76	320	30	11.0	0.45







# Torque Handle Sets

## Quick Release Ratchet Head - Torque Handle Fittings

ITEM NO.	■ inch	■ mm	Length mm	Weight g	PCS 	G.W. KGS	CUFT 
14DT38	3/8"	14 x 18	78	210	60	13.5	0.34
14DT48	1/2"	14 x 18	94	410	30	13.5	0.34





## Ratchet Head - Torque Handle Fittings

ITEM NO.	■ inch	■ mm	Length mm	Weight g	PCS 	G.W. KGS	CUFT 
09RH20	1/4"	9 x 12	56	85	120	11.0	0.30
09RH33	3/8"	9 x 12	56	90	120	11.5	0.30
09RH30	3/8"	9 x 12	69	170	60	11.5	0.34
14RH30	3/8"	14 x 18	78	210	60	13.5	0.34
09RH44	1/2"	9 x 12	69	180	60	12.0	0.34
14RH44	1/2"	14 x 18	78	220	60	14.0	0.34
14RH40	1/2"	14 x 18	94	410	30	13.5	0.34





## Hook Head - Torque Handle Fittings

ITEM NO.	■ mm	Clamping Range mm	Weight g	PCS 	G.W. KGS	CUFT 
14H012	14 x 18	32 ± 5	210	36	8.5	0.41
14H016	14 x 18	43 ± 5	260	36	10.5	0.34
14H025	14 x 18	60 ± 5	260	36	10.5	0.34
14H032	14 x 18	72 ± 5	290	36	11.5	0.34
14H075	14 x 18	50 ± 5	250	36	10.0	0.34
14H100	14 x 18	63 ± 5	260	36	10.5	0.34
14H150	14 x 18	82 ± 5	290	36	11.5	0.34





## Collet Head - Torque Handle Fittings

ITEM NO.	■ mm	Clamping Range mm	Weight g	PCS 	G.W. KGS	CUFT 
14CH16	14 x 18	32 ± 5	210	60	14.0	0.41
14CH20	14 x 18	35 ± 5	230	60	15.5	0.62
14CH25	14 x 18	42 ± 5	240	48	13.0	0.44
14CH32	14 x 18	50 ± 5	260	48	14.0	0.44
14CH40	14 x 18	63 ± 5	310	36	12.0	0.41



## 8 Piece Torque Handle Hook Head Set

ITEM NO.	Torque Handle Range	■ mm	Weight g	PCS 	G.W. KGS	CUFT 
TO-148N21	40 ~ 210 Nm	14 x 18	4000	4	16.6	0.86
TO-148F15	30 ~ 150 ft. lbs.	14 x 18	4000	4	16.6	0.86

- Item No. Description**  
 148N21 40 ~ 210 Nm Interchangeable Torque Handle, ■ 14 x 18mm  
 (148F15) (30 ~ 150 ft. lbs. Interchangeable Torque Handle, ■ 14 x 18mm)

### Hook Head Torque Handle Fitting, ■ 14 x 18mm:

14H012	32mm	14H075	50mm
14H016	43mm	14H100	63mm
14H025	60mm	14H150	82mm
14H032	72mm	Blow Case	



**GENIUS**

*Pliers &  
Aviation Snips*



**GENIUS TOOLS**  
[www.geniustools.net](http://www.geniustools.net)

# Pliers w/ Double Color Soft Handle

## A Bent Nose Pliers

ITEM NO.	Length mm (inch)	Weight g	PCS inner/ctn	G.W. KGS	CUFT
550614S	150 (6")	160	6 / 96	21.0	2.33
550814S	200 (8")	270	6 / 60	19.5	1.76

## B Long Nose Pliers with Cutter

ITEM NO.	Length mm (inch)	Weight g	PCS inner/ctn	G.W. KGS	CUFT
550604S	150 (6")	160	6 / 96	21.0	2.33
550804S	200 (8")	270	6 / 60	19.5	1.76

## C Side Cutter Pliers

ITEM NO.	Length mm (inch)	Weight g	PCS inner/ctn	G.W. KGS	CUFT
550612S	150 (6")	250	6 / 60	18.5	1.74
550712S	175 (7")	350	6 / 60	24.0	2.08
550812S	215 (8-1/2")	470	6 / 48	25.0	1.90

## D Diagonal Cutting Pliers

ITEM NO.	Length mm (inch)	Weight g	PCS inner/ctn	G.W. KGS	CUFT
550607S	150 (6")	250	6 / 96	23.0	2.75

## E Heavy Duty Diagonal Cutting Pliers

ITEM NO.	Length mm (inch)	Weight g	PCS inner/ctn	G.W. KGS	CUFT
550708S	175 (7")	320	6 / 60	21.0	2.08
550808S	200 (8")	350	6 / 60	22.0	2.08

## Forged Retaining Ring Pliers

ITEM NO.	Type	Diameter Tip	Angle Tip	Length mm (inch)	Weight g	PCS inner/ctn	G.W. KGS	CUFT
550550	External	1.3mm	Straight	125 (5")	100	10 / 120	13.6	1.28
550551	Internal	1.3mm	Straight	125 (5")	100	10 / 120	13.6	1.28
550552	External	1.3mm	90°	125 (5")	100	10 / 120	13.6	1.28
550553	Internal	1.3mm	90°	125 (5")	100	10 / 120	13.6	1.28
550750	External	1.8mm	Straight	175 (7")	150	10 / 120	19.0	2.00
550751	Internal	1.8mm	Straight	175 (7")	130	10 / 120	19.0	2.00
550752	External	1.8mm	90°	175 (7")	150	10 / 120	19.0	2.00
550753	Internal	1.8mm	90°	175 (7")	130	10 / 120	19.0	2.00
550950	External	2.3mm	Straight	225 (9")	340	10 / 80	28.6	1.80
550951	Internal	2.3mm	Straight	225 (9")	340	10 / 80	28.6	1.80
550952	External	2.3mm	90°	225 (9")	340	10 / 80	28.6	1.80
550953	Internal	2.3mm	90°	225 (9")	340	10 / 80	28.6	1.80
551250	External	3.2mm	Straight	300 (12")	490	6 / 36	17.4	1.62
551251	Internal	3.2mm	Straight	300 (12")	460	6 / 36	18.7	1.62
551252	External	3.2mm	90°	300 (12")	490	6 / 36	17.4	1.62
551253	Internal	3.2mm	90°	300 (12")	460	6 / 36	18.7	1.62

## RP-5504 4 Piece Retaining Ring Pliers Set

Item No.	Description
550750	Straight Nose, External (7")
550751	Straight Nose, Internal (7")
550752	90° Bent Nose, External (7")
550753	90° Bent Nose, Internal (7")
Plastic Tray	
850 g	10 sets / 9.5 Kgs / 0.93 CUFT

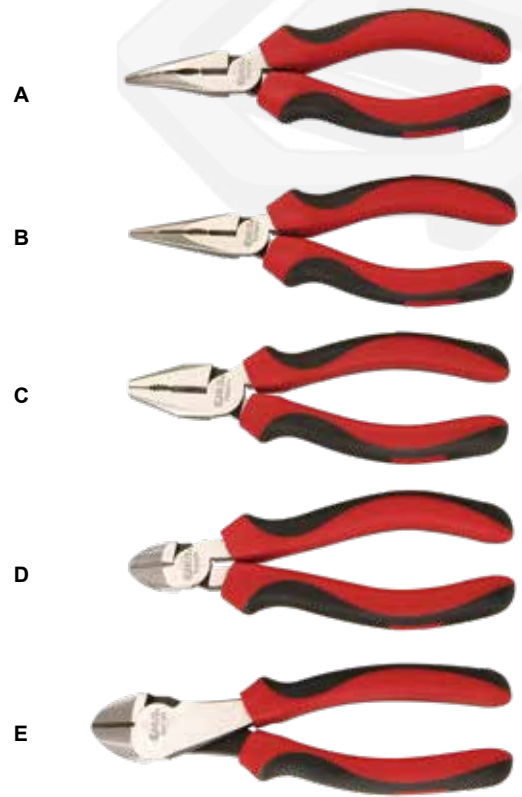

External-Straight



Internal-Straight

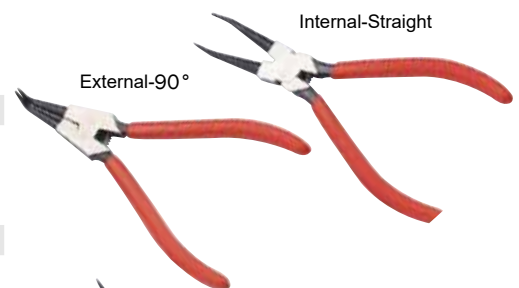

External-90°



Internal-90°

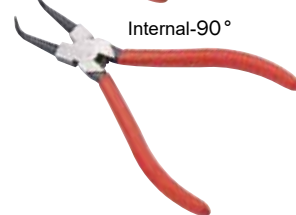

(192W x 203D)

## A Diagonal Cutting Pliers

ITEM NO.	Length	Weight	PCS	G.W.	CUFT
	mm (inch)				
550507	125 (5")	140	10 / 100	15.0	1.58
550607	150 (6")	210	10 / 100	22.0	1.64
550707	175 (7")	240	10 / 50	13.0	1.22

## B Long Nose Pliers with Cutter

ITEM NO.	Length	Weight	PCS	G.W.	CUFT
	mm (inch)				
550504	125 (5")	120	10 / 100	13.0	1.58
550604	150 (6")	190	10 / 100	20.0	1.58
550804	200 (8")	280	10 / 50	15.0	1.22

## C Heavy Duty Diagonal Cutting Pliers

ITEM NO.	Length	Weight	PCS	G.W.	CUFT
	mm (inch)				
550708	175 (7")	300	10 / 50	16.0	1.22
550808	200 (8")	320	10 / 50	17.0	1.22

## D Needle Nose Pliers

ITEM NO.	Length	Weight	PCS	G.W.	CUFT
	mm (inch)				
550606	150 (6")	120	10 / 100	13.0	1.50

## E Duckbill Pliers

ITEM NO.	Length	Weight	PCS	G.W.	CUFT
	mm (inch)				
550805	200 (8")	230	10 / 100	24.0	2.30

## F Combination (Slip Joint) Pliers

ITEM NO.	Length	Weight	PCS	G.W.	CUFT
	mm (inch)				
550609	150 (6")	200	10 / 100	21.0	1.94
550809	200 (8")	310	10 / 50	16.5	1.17
551009	250 (10")	360	10 / 50	19.0	1.29

## G Tongue and Groove Pliers

ITEM NO.	Length	Weight	PCS	G.W.	CUFT
	mm (inch)				
550611	150 (6")	200	10 / 100	21.0	1.94
550811	200 (8")	270	10 / 50	14.5	1.00
551011	250 (10")	400	10 / 50	21.0	1.78
551211	300 (12")	820	5 / 20	17.5	1.00
551611	400 (16")	1220	5 / 20	25.5	1.23

## H Side Cutter Pliers

ITEM NO.	Length	Weight	PCS	G.W.	CUFT
	mm (inch)				
550712	175 (7")	340	10 / 50	18.0	1.22
550812	200 (8")	460	10 / 50	24.0	1.22

## I Hose Clamp Pliers

ITEM NO.	Length	Weight	PCS	G.W.	CUFT
	mm (inch)				
550810	200 (8")	310	10 / 50	16.5	1.17

## J End Cutter Pliers

ITEM NO.	Length	Weight	PCS	G.W.	CUFT
	mm (inch)				
550613	150 (6")	280	10 / 50	15.0	1.47



## A Insulated Long Nose Pliers with Cutter

ITEM NO.	Length	Weight	PCS	G.W.	CUFT
	mm (inch)	g	inner/ctn	KGS	
550804V	200 (8")	300	6 / 48	15.2	2.00

**NEW**

A



## B Insulated Side Cutter Pliers

ITEM NO.	Length	Weight	PCS	G.W.	CUFT
	mm (inch)	g	inner/ctn	KGS	
550612V	150 (6")	270	6 / 48	14.0	2.00
550712V	175 (7")	335	6 / 48	17.1	2.00
550812V	200 (8")	440	6 / 48	22.0	2.00

**NEW**

B



## C Insulated Diagonal Cutting Pliers

ITEM NO.	Length	Weight	PCS	G.W.	CUFT
	mm (inch)	g	inner/ctn	KGS	
550607V	150 (6")	260	6 / 48	13.4	2.00

**NEW**

C



## D Water Pump Pliers with Push Button

ITEM NO.	Length	Weight	PCS	G.W.	CUFT
	mm (inch)	g	inner/ctn	KGS	
550711B	175 (7")	180	6 / 60	11.8	1.01
551011B	250 (10")	335	6 / 60	21.1	1.53
551211B	300 (12")	535	5 / 40	22.5	1.73

**NEW**

D



## E Bent Nose Pliers

ITEM NO.	Length	Weight	PCS	G.W.	CUFT
	mm (inch)	g	inner/ctn	KGS	
550614D	150 (6")	160	6 / 96	21.0	2.33
550814D	200 (8")	270	6 / 60	19.5	1.76

E



## F Long Nose Pliers with Cutter

ITEM NO.	Length	Weight	PCS	G.W.	CUFT
	mm (inch)	g	inner/ctn	KGS	
550604D	150 (6")	160	6 / 96	21.0	2.33
550804D	200 (8")	270	6 / 60	19.5	1.76

F



## G Side Cutter Pliers

ITEM NO.	Length	Weight	PCS	G.W.	CUFT
	mm (inch)	g	inner/ctn	KGS	
550612D	150 (6")	250	6 / 60	18.5	1.74
550712D	175 (7")	350	6 / 60	24.0	2.08
550812D	215 (8-1/2")	470	6 / 48	25.0	1.90

G



## H Diagonal Cutting Pliers

ITEM NO.	Length	Weight	PCS	G.W.	CUFT
	mm (inch)	g	inner/ctn	KGS	
550607D	150 (6")	250	6 / 96	23.0	2.75

H



## I Heavy Duty Diagonal Cutting Pliers

ITEM NO.	Length	Weight	PCS	G.W.	CUFT
	mm (inch)	g	inner/ctn	KGS	
550708D	175 (7")	320	6 / 60	21.0	2.08
550808D	200 (8")	350	6 / 60	22.0	2.08

I



## J Water Pump Pliers

ITEM NO.	Length	Weight	PCS	G.W.	CUFT
	mm (inch)	g	inner/ctn	KGS	
551011D	250 (10")	380	6 / 48	21.0	1.90

J



# Locking Pliers

## A Straight Jaw Locking Pliers

ITEM NO.	Length	Capacity	Weight	PCS	G.W.	CUFT
	mm (inch)	mm (inch)		g		
530307RA	175 (7")	35 (1-3/8")	370	6 / 36	14.5	0.83
530310RA	250 (10")	40 (1-4/7")	580	6 / 36	22.5	1.00

CRMO JAW & BODY



## B Curved Jaw Locking Pliers with Cutter

ITEM NO.	Length	Capacity	Weight	PCS	G.W.	CUFT
	mm (inch)	mm (inch)		g		
<b>NEW</b> 530304A	100 (4")	25 (1")	100	5 / 50	8.5	1.00
530305A	125 (5")	25 (1")	210	12 / 72	16.3	1.00
530307A	175 (7")	38 (1-1/2")	360	12 / 72	27.5	1.20
530310A	250 (10")	48 (1-8/9")	550	6 / 36	21.5	1.00

CRMO JAW & BODY



## C Long Nose Locking Pliers with Cutter

ITEM NO.	Length	Capacity	Weight	PCS	G.W.	CUFT
	mm (inch)	mm (inch)		g		
<b>NEW</b> 531304LN	100 (4")	36 (1-3/7")	105	5 / 50	8.5	0.70
531306LN	150 (6")	42 (1-2/3")	220	12 / 72	17.5	1.00
531309LN	225 (9")	43 (1-2/3")	400	6 / 36	26.0	0.80

CRMO JAW & BODY



## D Sheet Metal Pliers

ITEM NO.	Length	Capacity	Weight	PCS	G.W.	CUFT
	mm (inch)	mm (inch)		g		
532308SM	200 (8")	25 (1")	470	1 / 24	13.0	0.89

CRMO JAW & BODY



## E Locking Welding Clamp

ITEM NO.	Length	Capacity	Weight	PCS	G.W.	CUFT
	mm (inch)	mm (inch)		g		
533309LW	225 (9")	45 (1-7/9")	580	1 / 24	15.5	1.36

CRMO JAW & BODY



## F Locking "C" Clamps

ITEM NO.	Length	Capacity	Weight	PCS	G.W.	CUFT
	mm (inch)	mm (inch)		g		
539606	150 (6")	37 (1-1/2")	280	6 / 36	11.0	1.20
<b>NEW</b> 539609	225 (9")	99 (3-8/9")	380	6 / 24	10.5	1.30
539611	280 (11")	80 (3-1/7")	800	6 / 24	20.0	1.90
539618	460 (18")	162 (6-3/8")	1260	5 / 10	13.6	0.70
539624	610 (24")	305 (12")	1500	5 / 10	16.5	0.80

CRV JAW & CRMO BODY



## G Locking "C" Clamps w/ Swivel Pads

ITEM NO.	Length	Capacity	Weight	PCS	G.W.	CUFT
	mm (inch)	mm (inch)		g		
<b>NEW</b> 530304AR	100 (4")	26 (1")	140	5 / 50	10.0	1.00
530306AR	150 (6")	37 (1-1/2")	320	6 / 36	12.2	1.20
<b>NEW</b> 530309AR	225 (9")	99 (3-8/9")	420	6 / 24	11.5	1.30
530311AR	280 (11")	80 (3-1/7")	870	4 / 24	22.0	2.00
530318AR	460 (18")	160 (6-2/7")	1260	5 / 10	13.6	0.70
530324AR	610 (24")	340 (13-2/5")	1500	5 / 10	16.5	0.80

CRV JAW & CRMO BODY



## H Large Jaw Locking Pliers

ITEM NO.	Length	Capacity	Weight	PCS	G.W.	CUFT
	mm (inch)	mm (inch)		g		
534310LJ	250 (10")	51 (2")	610	6 / 36	23.5	1.00
<b>NEW</b> 535312LJ	300 (12")	96 (3-7/9")	685	6 / 36	26.0	1.67

CRMO JAW & BODY



## I Pinch-Off Locking Pliers

ITEM NO.	Length	Capacity	Weight	PCS	G.W.	CUFT
	mm (inch)	mm (inch)		g		
537807	180 (7")	28 (1-1/9")	360	6 / 36	14.5	0.80
537811	280 (11")	96 (3-7/9")	440	6 / 36	17.0	1.40

CRMO JAW & BODY



# Locking Pliers & Riveters

## J Locking Chain Pliers

ITEM NO.	Length mm (Inch)	Chain Length	Weight g	PCS inner/ctn	G.W. KGS	CUFT
538418	460 (18")	460mm	730	6 / 24	18.5	1.40

CRMO JAW & BODY

## K Claw-Grip Pliers

ITEM NO.	Length mm (Inch)	Weight g	PCS inner/ctn	G.W. KGS	CUFT
536062	150 (6")	260	12 / 72	20.0	1.60

CRMO JAW & BODY

## L Claw-Grip Pliers

ITEM NO.	Length mm (Inch)	Weight g	PCS inner/ctn	G.W. KGS	CUFT
536064	150 (6")	270	12 / 72	21.5	1.60

CRMO JAW & BODY

## M Hose Clamp Pliers

ITEM NO.	Length mm (Inch)	Capacity mm (inch)	Weight g	PCS inner/ctn	G.W. KGS	CUFT
535307	180 (7")	43 (1-2/3")	240	6 / 72	19.5	1.12
535309	230 (9")	50 (2")	420	6 / 36	16.5	1.07

CRMO JAW & BODY

## N 10" Oil Filter Locking Pliers

ITEM NO.	Length mm (Inch)	Weight g	PCS	G.W. KGS	CUFT
AT-OF10A	250 (10")	420	12 / 48	24.0	1.50

• Jaws Opening Range: 2-1/8" ~ 4-5/8" (53~118mm)  
CRV JAW & BODY

## O Round Jaw Locking Pliers

ITEM NO.	Length mm (inch)	Capacity mm	Weight g	PCS inner/ctn	G.W. KGS	CUFT
NEW 536307	175 (7")	6~21	350	6 / 36	13.5	0.70
NEW 536310	250 (10")	14~25	620	6 / 36	23.4	1.00

CRMO JAW & BODY

## P Curve Jaw Locking Pliers - Easy Release Type

ITEM NO.	Length mm (inch)	Capacity mm (inch)	Weight g	PCS inner/ctn	G.W. KGS	CUFT
NEW 530310Q	250 (10")	48 (1-8")	550	6 / 36	21.0	1.11

CRMO JAW & BODY

## SC-715 Heavy Duty Hand Riveter

### Contents:

4 pcs Nose Pieces:

- 2.4mm(3/32"), 3.2mm(1/8")
- 4.0mm(5/32"), 4.8mm(3/16")

40 pcs Blind Rivets:

- 2.4mm(\*5), 3.2mm(\*15), 4.0mm(\*15), 4.8mm(\*5)

Sliding Card

580 g 24 pcs / 15 Kgs / 1.1 CUFT

- Suitable for stainless steel riveter
- Chrome Molybdenum jaws, aluminum body and drop-forged handle

## SC-GS701 Heavy Duty Hand Riveter

### Contents:

4 pcs Nose Pieces:

- 2.4mm(3/32"), 3.2mm(1/8")
- 4.0mm(5/32"), 4.8mm(3/16")

40 pcs Blind Rivets:

- 2.4mm(\*5), 3.2mm(\*15), 4.0mm(\*15), 4.8mm(\*5)

Sliding Card

580 g 24 pcs / 15 Kgs / 1.1 CUFT

- Suitable for stainless steel riveter
- Chrome Molybdenum jaws, aluminum body and drop-forged handle

J



K



L



M



N



O



P



## SC-736 Free Section Hand Riveter

### Contents:

4 pcs Nose Pieces:

2.4mm(3/32"), 3.2mm(1/8")

4.0mm(5/32"), 4.8mm(3/16")

40 pcs Blind Rivets:

2.4mm(\*5), 3.2mm(\*15), 4.0mm(\*15), 4.8mm(\*5)

Sliding Card

 750 g

 24 pcs / 19 Kgs / 1.42 CUFT

- Suitable for construction and industrial applications
- Head rotates 360° for any angle riveting



## SC-758A Heavy Duty Hand Nut Riveter

### Contents:

4 pcs Nose Pieces:

M3, M4, M5, M6

40 pcs Nut Rivets:

M3(\*10), M4(\*10), M5(\*10), M6(\*10)

Sliding Card

 800 g

 24 pcs / 20.5 Kgs / 1.45 CUFT

- Aluminum body and drop-forged handle



## SC-710 Scissor Action Industrial Riveter

### Contents:

4 pcs Nose Pieces:

2.4mm(3/32"), 3.2mm(1/8")

4.0mm(5/32"), 4.8mm(3/16")

40 pcs Blind Rivets:

2.4mm(\*5), 3.2mm(\*15), 4.0mm(\*15), 4.8mm(\*5)

Color Box

 2000 g

 10 pcs / 21 Kgs / 1.2 CUFT

- Suitable for construction and industrial applications
- Stretching design is suitable for use in difficult accessing area and gives large riveting force
- Made of durable high carbon steel

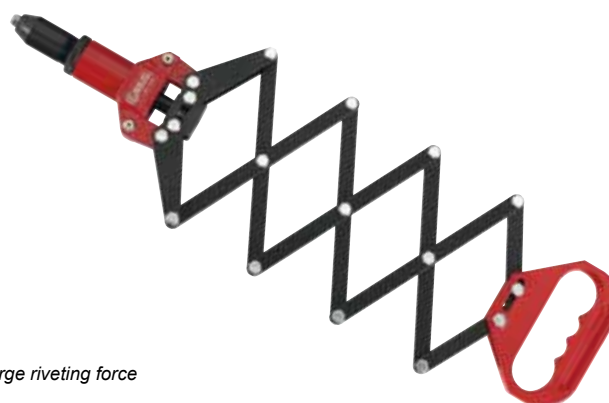

## SC-714 Industrial Lever Riveter

### Contents:

4 pcs Nose Pieces:

3.2mm(1/8"), 4.0mm(5/32")

4.8mm(3/16"), 6.4mm(1/4")

40 pcs Blind Rivets:

3.2mm(\*10), 4.0mm(\*10), 4.8mm(\*10), 6.4mm(\*10)

Color Box

 1730 g

 10 pcs / 18.3 Kgs / 1.3 CUFT

- Suitable for construction and industrial applications
- Gives large riveting force
- Aluminum body, steel tube with rubber handle





## **SC-785E** Effortless Industrial Hand Lever Riveter Set

### Contents:

Riveter

4 pcs Nose Pieces:

2.4mm(3/32"), 3.2mm(1/8")  
4.0mm(5/32"), 4.8mm(3/16")

80 pcs Blind Rivets:

2.4mm(\*20), 3.2mm(\*20), 4.0mm(\*20), 4.8mm(\*20)

Blow Case

1550 g

8 pcs / 13.5 Kgs / 1.97 CUFT



## **SC-785H** Effortless Industrial Hand Lever Riveter Set

### Contents:

Riveter

4 pcs Nose Pieces:

3.2mm(1/8"), 4.0mm(5/32")  
4.8mm(3/16"), 6.4mm(1/4")

80 pcs Blind Rivets:

3.2mm(\*20), 4.0mm(\*20), 4.8mm(\*20), 6.4mm(\*20)

Blow Case

2030 g

8 pcs / 17 Kgs / 1.97 CUFT



## **SC-785M** Effortless Industrial Hand Nut Riveter Set

### Contents:

Nut Riveter

4 pcs Nose Pieces:

M5, M6, M8, M10

80 pcs Nut Rivets:

M5(\*20), M6(\*20), M8(\*20), M10(\*20)

Blow Case

2180 g

8 pcs / 18.5 Kgs / 1.97 CUFT



## **SC-785S** Effortless Industrial Hand Nut Riveter Set

### Contents:

Nut Riveter

4 pcs Nose Pieces:

#10, 1/4", 5/16", 3/8"

80 pcs Nut Rivets:

#10(\*20), 1/4"(\*20), 5/16"(\*20), 3/8"(\*20)

Blow Case

2180 g



8 pcs / 18.5 Kgs / 1.97 CUFT



## 501600 Super Duty Air Riveter

### Specifications:

Air Pressure	90 psig / 620 kpa
Traction Power	1,600 lbs. / 7,116 n
Stroke	19mm (3/4")
4 Nosepiece	3/32"(2.4mm), 1/8"(3.2mm), 5/32"(4.0mm), 3/16"(4.8mm)
Avg. Air Consumption	3.8 cfm
Air Inlet	1/4 in.
Minimum Hose Size	3/8 in. / 10 mm



 1530 g       10 pcs / 18.5 Kgs / 1.84 CUFT



## 501940 Super Duty Air Riveter

### Specifications:

Air Pressure	90 psig / 620 kpa
Traction Power	1,940 lbs. / 8,629 n
Stroke	14mm (9/16")
4 Nosepiece	3/32"(2.4mm), 1/8"(3.2mm), 5/32"(4.0mm), 3/16"(4.8mm)
Avg. Air Consumption	4 cfm
Air Inlet	1/4 in.
Minimum Hose Size	3/8 in. / 10 mm



 1600 g       10 pcs / 18.5 Kgs / 1.6 CUFT



## 501990 Heavy Duty Air Riveter

### Specifications:

Air Pressure	90 psig / 620 kpa
Traction Power	1,983 lbs. / 8,820 n
Stroke	16mm (5/8")
3 Nosepiece	1/8"(3.2mm), 5/32"(4.0mm), 3/16"(4.8mm)
Avg. Air Consumption	4 cfm
Air Inlet	1/4 in.
Minimum Hose Size	3/8 in. / 10 mm



 1700 g       10 pcs / 22 Kgs / 2.5 CUFT



## 503100 Ultra Duty Air Riveter

### Specifications:

Air Pressure	90 psig / 620 kpa
Traction Power	3,099 lbs. / 13,784 n
Stroke	19mm (3/4")
3 Nosepiece	3/32"(2.4mm), 1/8"(3.2mm), 5/32"(4.0mm), 3/16"(4.8mm), 7/32"(5.6mm), 1/4"(6.4mm)
Avg. Air Consumption	4 cfm
Air Inlet	1/4 in.
Minimum Hose Size	3/8 in. / 10 mm

 2250 g       10 pcs / 28.5 Kgs / 3.3 CUFT



# Aviation Snips

## Straight Tip Aviation Snips

ITEM NO.	Description	Length	Weight	PCS	G.W.	CUFT
		mm (inch)	g	inner/ctn	KGS	
511001L	Left Cut Aviation Snip. Cuts Straight and Tight curves to the left.	250 (10")	390	6 / 48	23.0	1.70
511002R	Right Cut Aviation Snip. Cuts straight and tight curves to the right.	250 (10")	390	6 / 48	23.0	1.70
511003S	Straight Cut Aviation Snip. Cuts straight and wide curves to the left and right.	250 (10")	390	6 / 48	23.0	1.70

## Offset Tip Aviation Snips

ITEM NO.	Description	Length	Weight	PCS	G.W.	CUFT
		mm (inch)	g	inner/ctn	KGS	
511004L	Offset-Left Cut Aviation Snip. Cuts straight and tight left curves.	250 (10")	390	6 / 48	23.0	1.70
511005R	Offset-Right Cut Aviation Snip. Cuts straight and tight right curves.	250 (10")	390	6 / 48	23.0	1.70

- Cuts forged Chrome Molybdenum Steel blades with serrated edges.
- Hardened HRC 58 ~ 60. Induction Hardened cutting edges HRC 60 ~ 62.
- Cuts up to 1.2mm cold rolled steel or 0.7mm stainless steel.

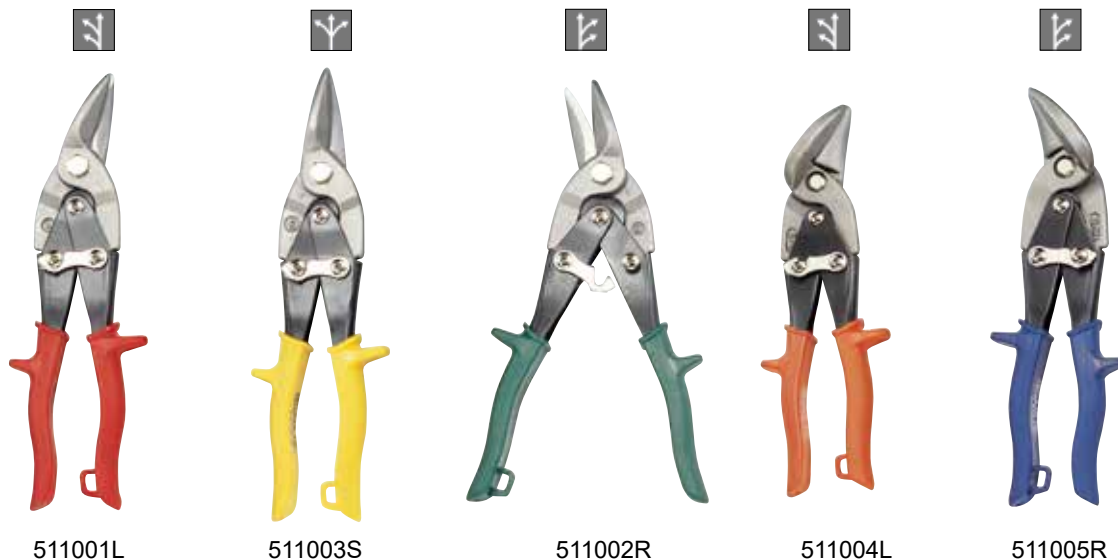

## MS-015 15 Piece Pliers Set

Item No.	Description
530310A	Curved Jaw Locking Pliers, 250mmL (10"L)
531309LN	Long Nose Locking Pliers, 230mmL (9"L)
530306AR	C-Clamp Locking Pliers, 150mmL (6"L)
550712D	Side Cutter Pliers, 180mmL (7"L)
550604D	Chain Nose Pliers, 150mmL (6"L)
550607D	Diagonal Cutting Pliers, 150mmL (6"L)
551011D	Water Pump Pliers, 250mmL (10"L)
550809	Combination Slip Joint Pliers, 200mmL (8"L)
550750	Straight Nose, External Retaining Ring Pliers (7")
550751	Straight Nose, Internal Retaining Ring Pliers (7")
550752	90° Bent Nose, External Retaining Ring Pliers (7")
550753	90° Bent Nose, Internal Retaining Ring Pliers (7")
780256	Adjustable Wrench, 200mmL (8"L)
782300	Heavy Duty Pipe Wrench, 300mmL (12"L)
511003S	Straight Tip Aviation Snip, 250mmL (10"L)
Plastic Tray	



(570W x 410D x 50H)

5500 g 2 sets / 13 Kgs / 1.76 CUFT

## Two-Jaw Gear Pullers

ITEM NO.	Size Inch	A1 mm	A2 mm	B1 mm	B2 mm	D max.	H mm	Ton max.	Weight g	PCS	G.W. KGS	CUFT
KJ-2076	3"	40 ~ 75	40 ~ 75	3.5	6.5	45	14	2	440	50	25.0	1.20
KJ-2102	4"	50 ~ 100	50 ~ 100	4.0	7.5	55	17	4	760	30	25.0	1.13
KJ-2127	5"	55 ~ 125	55 ~ 125	4.0	8.5	75	17	5	1160	20	25.5	1.30
KJ-2152	6"	60 ~ 150	60 ~ 150	5.5	10.5	95	19	6	1840	12	24.0	1.35
KJ-2203	8"	80 ~ 200	80 ~ 200	6.5	13.0	135	23	10	3920	6	26.0	1.30
KJ-2254	10"	100 ~ 250	100 ~ 250	8.0	15.0	150	26	12	5740	4	25.0	1.40
KJ-2305	12"	120 ~ 300	120 ~ 300	8.0	15.5	170	32	15	8240	3	27.0	1.60

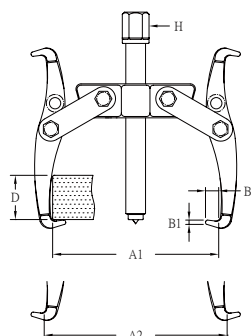

## Three-Jaw Gear Pullers

ITEM NO.	Size Inch	A1 mm	A2 mm	B1 mm	B2 mm	D max.	H mm	Ton max.	Weight g	PCS	G.W. KGS	CUFT
KJ-3076	3"	40 ~ 75	40 ~ 75	3.5	6.5	45	14	3	560	40	24.0	1.17
KJ-3102	4"	50 ~ 100	50 ~ 100	4.0	7.5	55	17	6	1040	24	27.0	1.14
KJ-3127	5"	55 ~ 125	55 ~ 125	4.0	8.5	75	17	7.5	1620	15	26.5	1.43
KJ-3152	6"	60 ~ 150	60 ~ 150	5.5	10.5	95	19	9	2560	10	27.0	1.23
KJ-3203	8"	80 ~ 200	80 ~ 200	6.5	13.0	135	23	15	5480	4	24.0	1.25
KJ-3254	10"	100 ~ 250	100 ~ 250	8.0	15.0	150	26	18	7880	2	17.0	1.20
KJ-3305	12"	120 ~ 300	120 ~ 300	8.0	15.5	170	32	22	10840	2	24.0	1.90

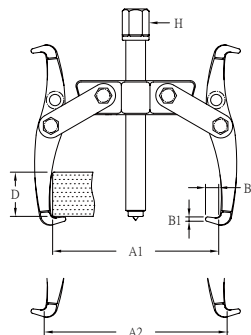

## Two-Arm Gear Pullers

ITEM NO.	Size mm	A1 mm	A2 mm	B1 mm	B2 mm	D mm	H mm	Ton max.	Weight g	PCS	G.W. KGS	CUFT
KA-2080	80	30 ~ 80	65 ~ 115	4.5	11.5	100	17	4	1080	24	29.0	1.20
KA-2120	120	30 ~ 120	65 ~ 155	4.5	11.5	100	17	4	1160	24	31.0	1.20
KA-2160	160	40 ~ 160	80 ~ 200	6.0	11.5	160	23	6	2680	10	29.0	1.20
KA-2200	200	40 ~ 200	80 ~ 240	6.0	11.5	160	23	6	2880	10	31.0	1.30

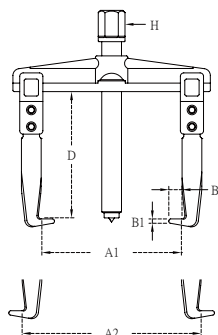

Made of Chrome Vanadium Steel



## Air Files ø5mm

ITEM NO.		Length mm	Weight g	PCS inner/ctn	G.W. KGS	CUFT
500861	▬	140	20	50 / 600	13.0	0.30
500862	●	140	17	50 / 600	11.0	0.30
500863	◐	140	17	50 / 600	11.0	0.30
500864	■	140	17	50 / 600	11.0	0.30
500865	▲	140	17	50 / 600	11.0	0.30

## Diamond Files ø4mm

ITEM NO.		Length mm	Weight g	PCS inner/ctn	G.W. KGS	CUFT
500781	▬	200	20	50 / 500	12.0	0.34
500782	●	200	20	50 / 500	11.0	0.34
500783	◐	200	20	50 / 500	11.0	0.34
500784	■	200	20	50 / 500	11.0	0.34
500785	▲	200	20	50 / 500	11.0	0.34

## Small Files

ITEM NO.		Length mm	Weight g	PCS inner/ctn	G.W. KGS	CUFT
500681	▬	200	45	20 / 200	10.0	0.34
500682	●	200	30	20 / 200	7.0	0.34
500683	◐	200	45	20 / 200	10.0	0.34
500684	■	200	30	20 / 200	7.0	0.34
500685	▲	200	40	20 / 200	9.0	0.34
500686	▤	200	45	20 / 200	10.0	0.34
500687	⊠	200	45	20 / 200	9.0	0.34

### FL-0865 5 Piece Air File Set (ø5mm)

Item No.	Description
500861	▬ Flat
500862	● Round
500863	◐ Half Round
500864	■ Square
500865	▲ Triangle

Plastic Bag

95 g 30x6 180 sets / 18 Kgs / 0.92 CUFT

### FL-0785 5 Piece Diamond File Set (ø4mm)

Item No.	Description
500781	▬ Flat
500782	● Round
500783	◐ Half Round
500784	■ Square
500785	▲ Triangle

Plastic Bag

100 g 30x8 240 sets / 27 Kgs / 1.6 CUFT

### FL-0687 7 Piece Small File Set

Item No.	Description
500681	▬ Flat
500682	● Round
500683	◐ Half Round
500684	■ Square
500685	▲ Triangle
500686	▤ Trapezoid
500687	⊠ Warding

Plastic Bag

280 g 10x8 80 sets / 24.5 Kgs / 1.6 CUFT



## AF-3406 6 Piece Air File Set

### Item No. Description

#### Air File Wrench

#### Air Files:

500861	Flat Type Air File
500862	Round Type Air File
500863	Half round Type Air File
500864	Square Type Air File
500865	Triangle Type Air File

#### Color Box

920 g

10 sets / 11.2 Kgs / 1.2 CUFT

#### Specifications:

Free speed	3,400 rpm
Air inlet	1/4 in.
Air pressure	90 psig
File shank dia.	5 mm
Stroke length	10 mm



## Machinists Files (2nd. Cut)

ITEM NO.	Type	Size inch	Length mm	Weight g	PCS		G.W. KGS	CUFT
					inner/ctn			
500106	Flat	6"	250	100	10 / 100	12.5	1.97	
500108		8"	300	190	15 / 90	19.0	1.58	
500110		10"	370	350	25 / 50	20.0	1.08	
500112		12"	420	490	25 / 50	27.0	1.08	

ITEM NO.	Type	Size inch	Length mm	Weight g	PCS		G.W. KGS	CUFT
					inner/ctn			
500206	Round	6"	250	75	10 / 100	9.5	1.97	
500208		8"	300	100	15 / 90	11.5	1.58	
500210		10"	370	200	25 / 50	12.5	1.08	
500212		12"	420	310	25 / 50	18.0	1.08	

ITEM NO.	Type	Size inch	Length mm	Weight g	PCS		G.W. KGS	CUFT
					inner/ctn			
500306	Half	6"	250	100	10 / 100	12.0	1.97	
500308		8"	300	170	15 / 90	17.3	1.58	
500310		10"	370	290	25 / 50	17.0	1.08	
500312		12"	420	450	25 / 50	25.0	1.08	

ITEM NO.	Type	Size inch	Length mm	Weight g	PCS		G.W. KGS	CUFT
					inner/ctn			
500406	Square	6"	250	80	10 / 100	10.0	1.97	
500408		8"	300	120	15 / 90	12.8	1.58	
500410		10"	370	240	25 / 50	14.5	1.08	
500412		12"	420	310	25 / 50	18.0	1.08	

ITEM NO.	Type	Size inch	Length mm	Weight g	PCS		G.W. KGS	CUFT
					inner/ctn			
500506	Triangle	6"	250	95	10 / 100	11.5	1.97	
500508		8"	300	140	15 / 90	15.0	1.58	
500510		10"	370	260	25 / 50	15.5	1.08	
500512		12"	420	390	25 / 50	22.0	1.08	



# Hammers & Punches

## A Claw Hammers

ITEM NO.	Head	Length mm	Weight g	PCS	G.W.	CUFT
	Weight			inner/ctn	KGS	
590116	1 lbs.	330	740	4 / 24	19.5	0.97
590120	1-1/4 lbs.	335	800	4 / 24	20.5	1.06

Made of Chrome Vanadium Steel

## B Ball Peen Hammers

ITEM NO.	Head	Length mm	Weight g	PCS	G.W.	CUFT
	Weight			inner/ctn	KGS	
590208	1/2 lbs.	280	440	6 / 48	22.5	1.08
590212	3/4 lbs.	300	520	6 / 36	20.0	0.87
590216	1 lbs.	330	740	6 / 24	19.0	0.76
590224	1-1/2 lbs.	350	1000	4 / 16	17.0	0.76
590232	2 lbs.	380	1160	4 / 16	20.0	0.93

Made of Chrome Vanadium Steel

## C Drilling Hammers

ITEM NO.	Head	Length mm	Weight g	PCS	G.W.	CUFT
	Weight			inner/ctn	KGS	
590348	2-1/2 lbs.	270	1180	4 / 16	19.5	0.60
590364	4 lbs.	270	1840	4 / 12	23.0	0.55

Made of Chrome Vanadium Steel

## D Rubber Mallet

ITEM NO.	Head	Length mm	Weight g	PCS	G.W.	CUFT
	Weight			inner/ctn	KGS	
590524	1-1/2 lbs.	330	840	6 / 24	22.5	2.20

## E Soft Face Hammer

ITEM NO.	Head	Length mm	Weight g	PCS	G.W.	CUFT
	Weight			inner/ctn	KGS	
590416	1 lbs.	320	700	1 / 10	7.5	0.45

## Oval Bearing Punches

ITEM NO.	Size	Length mm	PCS	G.W.	CUFT
	mm / inch				
565311	11 x 6 (7/16 x 16/64)	150	10 / 200	19.0	0.52
565313	13 x 7 (1/2 x 17/64)	250	10 / 100	21.0	0.62
565315	15 x 8 (9/16 x 1 6/64)	350	10 / 60	24.0	0.45
565317	17 x 9 (5/8 x 11/32)	500	10 / 30	21.0	0.30

Made of High Speed Tool Steel

## PC-BP4 4 Piece Oval Bearing Punch Set

Item No.	Description
565311	11 x 6mm, 150mmL
565313	13 x 7mm, 250mmL
565315	15 x 8mm, 350mmL
565317	17 x 9mm, 500mmL

Plastic Tray

1500 g 15 sets / 23.5 Kgs / 0.82 CUFT



A

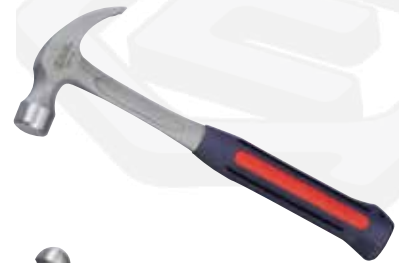

B



C



D



E

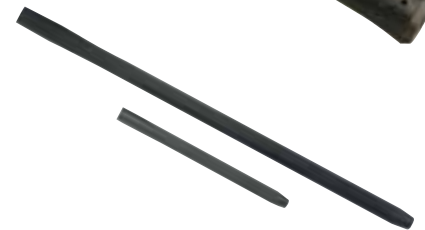

## Metric Pin Punches

ITEM NO.	Size	H	L	L1	Weight	PCS	G.W.	CUFT
	mm	inch	mm	mm		inner/ctn		
565102	2	1/4	100	30	20	60 / 720	15.5	0.30
565123	3	5/16	125	40	35	40 / 480	18.0	0.30
565144	4	3/8	140	50	55	20 / 240	14.5	0.30
565165	5	3/8	160	55	70	25 / 300	22.0	0.30
565205	5	3/8	200	100	70	30 / 300	22.0	0.34
565166	6	7/16	160	55	90	15 / 240	22.5	0.44
565206	6	7/16	200	100	100	20 / 200	21.0	0.34
565208	8	1/2	200	70	160	10 / 100	17.0	0.34

## SAE Pin Punches

ITEM NO.	Size	H	L	L1	Weight	PCS	G.W.	CUFT
	Inch	inch	mm	mm		inner/ctn		
566102	1/16	1/4	100	25	20	60 / 720	15.5	0.30
566103	3/32	1/4	100	30	20	60 / 720	15.5	0.30
566124	1/8	5/16	125	40	35	50 / 600	22.0	0.30
566145	5/32	3/8	140	50	55	30 / 360	21.0	0.30
566166	3/16	3/8	160	55	65	25 / 300	20.5	0.30
566206	3/16	3/8	200	100	70	30 / 300	22.0	0.34
566168	1/4	7/16	160	55	90	15 / 240	22.5	0.34
566208	1/4	7/16	200	100	100	20 / 200	21.0	0.34
566210	5/16	1/2	200	70	160	15 / 150	25.0	0.34

## Long Taper Line Up Punches

ITEM NO.	Size	H	L	L1	Weight	PCS	G.W.	CUFT
	mm	inch	mm	mm		inner/ctn		
564202	2	5/16	200	100	65	40 / 400	27.0	0.34
564203	3	5/16	200	100	70	40 / 400	29.0	0.34
564254	4	3/8	250	130	120	30 / 180	22.5	0.30
564255	5	3/8	250	130	120	30 / 180	23.5	0.30
564286	6	1/2	280	150	240	15 / 90	22.5	0.34

## Center Punches

ITEM NO.	Size	H	L	L1	Weight	PCS	G.W.	CUFT
	mm	Size	mm	mm		inner/ctn		
563100	3	5/16"	100	25	35	30 / 360	13.5	0.30
563110	4	3/8"	110	30	60	20 / 300	19.0	0.30
563125	5	12mm	125	50	95	15 / 180	18.0	0.30
563140	6	14mm	140	65	140	10 / 120	18.5	0.30
563160	8	5/8"	160	75	210	5 / 60	14.0	0.30

## Flat Chisels

ITEM NO.	Size	H	L	Weight	PCS	G.W.	CUFT
	mm	inch	mm		inner/ctn		
561206	6	1/4	125	30	50 / 600	19.0	0.30
561410	10	5/16	140	55	30 / 360	21.0	0.30
561612	12	3/8	150	85	20 / 240	21.5	0.30
561614	14	7/16	150	110	10 / 200	23.0	0.52
561616	16	1/2	160	150	10 / 160	26.0	0.44
562019	19	5/8	200	300	5 / 50	16.5	0.34
563019	19	5/8	300	470	5 / 60	29.5	0.52
562022	22	3/4	200	430	5 / 50	23.0	0.62
563022	22	3/4	300	670	5 / 30	22.5	0.45
562025	25	7/8	200	570	5 / 40	24.0	0.44





# Punch & Chisel Sets

## MS-019 19 Piece Punch, Chisel & Hammer Set

Item No.	Size	Item No.	Size
<b>Flat Chisel:</b>			
561206	6mm, 125mmL	562019	19mm, 200mmL
561410	10mm, 140mmL	562025	25mm, 200mmL
561614	14mm, 150mmL		
<b>Pin Punch:</b>			
565102	2mm, 100mmL	565165	5mm, 160mmL
565123	3mm, 125mmL	565206	6mm, 200mmL
565144	4mm, 140mmL	565208	8mm, 200mmL
<b>Taper Bit Extractor:</b>			
010603	3mm, 60mmL	010808	8mm, 80mmL
010705	5mm, 70mmL	010859	9mm, 85mmL
010756	6mm, 75mmL		
<b>Accessory:</b>			
563110	4mm Center Punch, 110mmL		
590216	Ball Peen Hammer, 1 lbs.		
590348	Drilling Hammer, 2-1/2 lbs.		
Plastic Tray			

3900 g      3 sets / 13.5 Kgs / 1.35 CUFT



(285W x 410D x 50H)

1/3

## PC-566MP 6 Piece Metric Pin Punch Set

Item No.	Size	Item No.	Size
<b>Pin Punch:</b>			
565102	2mm, 100mmL	565165	5mm, 160mmL
565123	3mm, 125mmL	565166	6mm, 160mmL
565144	4mm, 140mmL	565208	8mm, 200mmL
Pouch Bag			

500 g      10 sets / 6 Kgs / 0.62 CUFT



## PC-577SP 7 Piece SAE Pin Punch Set

Item No.	Size	Item No.	Size
<b>Pin Punch:</b>			
566102	1/16", 100mmL	566166	3/16", 160mmL
566103	3/32", 100mmL	566168	1/4", 160mmL
566124	1/8", 125mmL	566210	5/16", 200mmL
566145	5/32", 140mmL	Pouch Bag	

550 g      10 sets / 6.5 Kgs / 0.62 CUFT



## PC-565LU 5 Piece Long Taper Line Up Punch Set

Item No.	Size	Item No.	Size
<b>Long Taper Line Up Punch:</b>			
564202	2mm, 200mmL	564255	5mm, 250mmL
564203	3mm, 200mmL	564286	6mm, 280mmL
564254	4mm, 250mmL	Pouch Bag	

700 g      20 sets / 15 Kgs / 0.7 CUFT



Pliers & Striking Tools



# Punch & Chisel Sets

## PC-567F 7 Piece Flat Chisel Set

Item No.	Size	Item No.	Size
<b>Flat Chisel:</b>			
561206	6mm, 125mmL	561616	16mm, 160mmL
561410	10mm, 140mmL	562019	19mm, 200mmL
561612	12mm, 150mmL	562022	22mm, 200mmL
561614	14mm, 150mmL	Pouch Bag	

1250 g 10 sets / 13.5 Kgs / 0.62 CUFT



## PC-575C 5 Piece Center Punch Set

Item No.	Size	Item No.	Size
<b>Center Punch:</b>			
563100	3mm, 100mmL	563140	6mm, 140mmL
563110	4mm, 110mmL	563160	8mm, 160mmL
563125	5mm, 125mmL	Pouch Bag	

650 g 10 sets / 7.5 Kgs / 0.62 CUFT



## PC-514M 14 Piece Metric Punch & Chisel Set

Item No.	Size	Item No.	Size
<b>Flat Chisel:</b>			
561206	6mm, 125mmL	561614	14mm, 150mmL
561410	10mm, 140mmL	561616	16mm, 160mmL
561612	12mm, 150mmL		
<b>Long Taper Line Up Punch:</b>			
564203	3mm, 200mmL	564255	5mm, 250mmL
<b>Center Punch:</b>			
563100	3mm, 100mmL	563125	5mm, 125mmL
<b>Pin Punch:</b>			
565102	2mm, 100mmL	565165	5mm, 160mmL
565123	3mm, 125mmL	565166	6mm, 160mmL
565144	4mm, 140mmL	Pouch Bag	

1150 g 6 sets / 8 Kgs / 0.45 CUFT



## PC-514S 14 Piece SAE Punch & Chisel Set

Item No.	Size	Item No.	Size
<b>Flat Chisel:</b>			
561206	6mm, 125mmL	561614	14mm, 150mmL
561410	10mm, 140mmL	561616	16mm, 160mmL
561612	12mm, 150mmL		
<b>Long Taper Line Up Punch:</b>			
564203	3mm, 200mmL	564255	5mm, 250mmL
<b>Center Punch:</b>			
563100	3mm, 100mmL	563125	5mm, 125mmL
<b>Pin Punch:</b>			
566103	3/32", 100mmL	566166	3/16", 160mmL
566124	1/8", 125mmL	566168	1/4", 160mmL
566145	5/32", 140mmL	Pouch Bag	

1150 g 6 sets / 8 Kgs / 0.45 CUFT



# Pry Bars & Chisels

## Pry Bars

ITEM NO.	Length mm (Inch)	Weight g	PCS inner/ctn	G.W. KGS	CUFT
560008	200 (8")	100	5 / 50	6.0	0.62
560012	300 (12")	240	1 / 40	10.5	0.38
560018	450 (18")	550	1 / 30	17.5	0.45
560024	600 (24")	700	1 / 20	15.0	0.45
560036	900 (36")	2000	1 / 12	25.0	0.83



## PB-5094 4 Piece Pry Bar Set

Item No.	Description
560008	Pry Bar, 200mmL(8"L)
560012	Pry Bar, 300mmL(12"L)
560018	Pry Bar, 450mmL(18"L)
560024	Pry Bar, 600mmL(24"L)



1650 g 12 sets / 21 Kgs / 1.41 CUFT

## Rolling Head Pry Bars

ITEM NO.	Length mm (Inch)	Weight g	PCS inner/ctn	G.W. KGS	CUFT
561106	150 (6")	70	10 / 200	15.0	0.52
561112	305 (12")	250	5 / 60	16.0	0.52
561116	405 (16")	530	1 / 40	21.5	0.53
561120	505 (20")	945	1 / 20	20.0	0.45



## PB-RH4 4 Piece Rolling Head Pry Bar Set

Item No.	Description
561106	Rolling Head Pry Bar, 150mmL(6"L)
561112	Rolling Head Pry Bar, 305mmL(12"L)
561116	Rolling Head Pry Bar, 405mmL(16"L)
561120	Rolling Head Pry Bar, 505mmL(20"L)



1800 g 12 sets / 22.5 Kgs / 0.7 CUFT

## Close Quarters Bar

ITEM NO.	Length mm (Inch)	Weight g	PCS inner/ctn	G.W. KGS	CUFT
015618	450 (18")	720	1 / 20	15.5	0.30



## Pinch Bar

ITEM NO.	Length mm (Inch)	Weight g	PCS inner/ctn	G.W. KGS	CUFT
015638	950 (38")	2150	1 / 10	22.5	0.34



## Flat Chisels with Handle Guard

ITEM NO.	Size mm	Hex Shank	Length mm	Weight g	PCS inner/ctn	G.W. KGS	CUFT
563819P	19	5/8"	380	740	6 / 24	19.5	1.94
563822P	22	3/4"	380	990	6 / 24	25.5	1.94



# GENIUS®

*Master Sets*



**GENIUS TOOLS**  
[www.geniustools.net](http://www.geniustools.net)

# Master Sets

## MS-926TS 926 Piece 1/4", 3/8" & 1/2" Dr. Metric & SAE Master Tool Set

Item No.	Pcs	Description
MS-098M	98	A 98pcs 1/4" & 1/2" Dr. Metric Tool Set
MS-100S	100	B 100pcs 1/4" & 1/2" Dr. SAE Tool Set
MS-106M	106	C 106pcs 3/8" Dr. Metric Tool Set
MS-090S	90	D 90pcs 3/8" Dr. Metric Tool Set
MS-044M	44	E 44pcs Metric Complete Wrench Set
MS-035S	35	F 35pcs SAE Complete Wrench Set
MS-086	86	G 86pcs Screwdriver & Bit Set
MS-023	23	H 23pcs Punch, Chisel & Hammer Set
MS-015	15	I 15pcs Pliers Set
MS-057M	57	J 57pcs 1/4" & 1/2" Dr. Swivel Socket & Bit Socket Set
MS-027S	27	K 27pcs 1/2" Dr. SAE Impact Socket & Accessory Set
MS-042M	42	L 42pcs 3/8" Dr. Metric Impact Socket & Star Socket Set
MS-065S	65	M 65pcs 3/8" Dr. Head Driver & Impact Socket Set
MS-035M	35	N 35pcs Metric Flare Nut & L-Shaped Key Wrench Set
MS-028S	28	O 28pcs SAE Flare Nut, E-Star & Key Wrench Set
MS-014	14	P 14pcs Slotted, Philips & Posidriv Screwdriver Set
MS-013	13	Q 13pcs Tang-Thru Screwdriver, Pry Bar & Carbon Scraper Set
MS-048MS	48	R 48pcs Hex, Star, Triple Square & Square Bit Set
TS-246	1	6 Drawer Jumbo Top Chest
TS-468	1	7 Drawer Jumbo Roller Cabinet

263 Kg

1 set / 278 Kgs / 43 CUFT

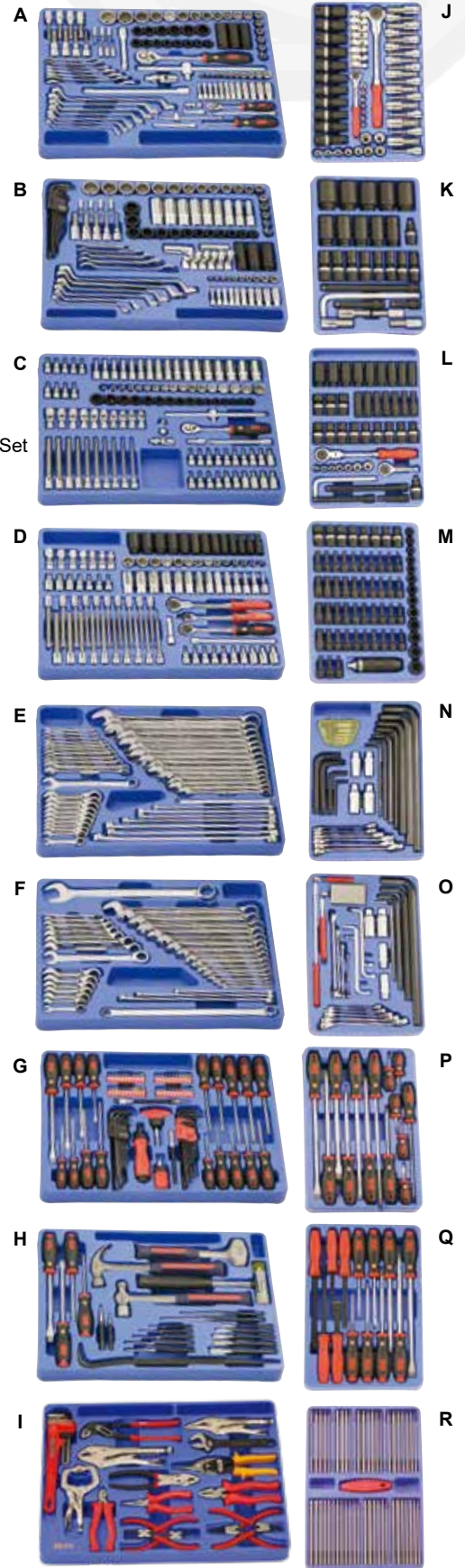

## MS-771 771 Piece 1/4", 3/8" & 1/2" Dr. Metric & SAE Master Tool Set (without tool cabinet & tool chest)

Item No.	Pcs	Description	Item No.	Pcs	Description
TF-255MS	55	1/4" Dr. 6pt. Std./Deep Metric & SAE Impact Socket Set	TL-517X	17	Combination Screwdriver Set
700107	1	3/8" Dr. Impact Universal Joint	HS-5610M	10	Metric Hex Screwdriver Set
TG-308S	8	3/8" Dr. 6pt. Std. SAE Swivel Impact Socket Set	HS-5612S	12	SAE Hex Screwdriver Set
TG-312M	12	3/8" Dr. 6pt. Std. Metric Swivel Impact Socket Set	TX-513T	13	Star Screwdriver Set
700108	1	1/2" Dr. Impact Universal Joint	TL-504A	4	Square Screwdriver Set
IE-2349	9	1/4", 3/8" & 1/2" Dr. Impact Extension Bar Set	ND-012M	12	Metric Hex Nut Driver Set
CM-326S	26	3/8" Dr. 6pt. Std./Deep SAE Impact Socket Set	ND-007S	7	SAE Hex Nut Driver Set
CM-332M	32	3/8" Dr. 6pt. Std./Deep Metric Impact Socket Set	780256	1	24mm Adjustable Wrench, 200 mmL
IS-422S	22	1/2" Dr. 6pt. Std. SAE Impact Socket Set	HS-024M	24	Metric Combination Wrench Set
DI-422S	22	1/2" Dr. 6pt. Deep SAE Impact Socket Set	HS-016S	16	SAE Combination Wrench Set
IS-425M	25	1/2" Dr. 6pt. Std. Metric Impact Socket Set	DE-713M	13	Metric Double Ended Offset Ring Wrench Set
DI-425M	25	1/2" Dr. 6pt. Deep Metric Impact Socket Set	DE-708S	8	SAE Double Ended Offset Ring Wrench Set
280226P	1	1/4" Dr. Hinge Handle	HK-009MB	9	Metric Wobble Hex Wrench Set
282262	1	1/4" Dr. 72 Teeth Flex Head Ratchet	HK-009SB	9	SAE Wobble Hex Wrench Set
GS-244MS	44	1/4" Dr. 6pt. Std./Deep Metric & SAE Hand Socket Set	SK-010T	10	L-Shaped Tamperproof Star Wrench Set
380336P	1	3/8" Dr. Hinge Handle	OS-505SP	5	Offset Slotted & Phillips Screwdriver
380400	1	3/8" Dr. Speed Handle	782300	1	Heavy Duty Pipe Wrench, 300mmL
383363	1	3/8" Dr. 72 Teeth Flex Head Ratchet	CP-5804	4	General Purpose Pliers Set
383338	1	3/8" Dr. 72 Teeth Flex Head Ratchet	RP-5504	4	Retaining Ring Pliers Set
380371	1	1/4" & 3/8" Dr. Double Size Ratchet	530310RA	1	Straight Jaw Pliers, 10"L
GS-347MS	47	3/8" Dr. 6pt. Std./Deep Metric & SAE Hand Socket Set	511003S	1	Straight Cut Aviation Snip, 250mmL
484464	1	1/2" Dr. 72 Teeth Flex Head Ratchet	590116	1	Claw hammer 1 lbs./ 454g
480420	1	1/2" Dr. Speed Handle 420 mmL	590208	1	Ball Peen Hammer 1/2 lbs./ 227g
480446P	1	1/2" Dr. Hinge Handle	590216	1	Ball Peen Hammer 1 lbs./ 454g
480448P	1	1/2" Dr. Hinge Handle	590348	1	Drilling Hammer 3 lbs./ 1362g
TW-446MS	46	1/2" Dr. 12pt. Std. Metric & SAE Hand Socket Set	590416	1	Soft Face Hammer 1 lbs./454g
DS-422S	22	1/2" Dr. 6pt. Deep SAE Hand Socket Set	590524	1	Rubber Mallet 1-1/2 lbs./ 681g
DS-425M	25	1/2" Dr. 6pt. Deep Metric Hand Socket Set	PC-514S	14	SAE Punch & Chisel Set
TX-23414	14	1/4", 3/8" & 1/2" Dr. Star Hand Socket Set	CW-404MS	4	Car Wheel Thin Wall Deep Impact Socket Set
TX-2353	53	1/4" & 3/8" Dr. Bit Socket Set	002034	1	Magnetic Parts Tray, Double
TX-246S	46	SAE Extra Long Screwdriver Bits With OMNIDRIVE® Set	AT-B16	1	Telescoping Magnetic Pick-Up Tool
ID-414	14	1/2" Dr. Impact Driver Set	PB-5094	4	Pry Bar Set

139 Kg

1 set / 147 Kgs / 8 CUFT

## MS-771TS 771 Piece 1/4", 3/8" & 1/2" Dr. Metric & SAE Master Tool Set

Item No.	Pcs	Description
MS-771	771	771 Piece 1/4", 3/8" & 1/2" Dr. Metric & SAE Master Tool Set
TS-710	1	6 Drawer Top Tool Chest
TS-748	1	8 Drawer Side Tool Cabinet
TS-796	1	8 Drawer Roller Cabinet

460 Kg

1 set / 477 Kgs / 39.4 CUFT



# Master Sets

## MS-548TS 548 Piece 1/4" & 1/2" Dr. Metric & SAE Master Tool Set

Item No.	Pcs	Description
MS-098M	98	A 98pcs 1/4" & 1/2" Dr. Metric Tool Set
MS-100S	100	B 100pcs 1/4" & 1/2" Dr. SAE Tool Set
MS-044M	44	C 44pcs Metric Complete Wrench Set
MS-035S	35	D 35pcs SAE Complete Wrench Set
MS-086	86	E 86pcs Screwdriver & Bit Set
MS-023	23	F 23pcs Punch, Chisel & Hammer Set
MS-015	15	G 15pcs Pliers Set
MS-057M	57	H 57pcs 1/4" & 1/2" Dr. Swivel Socket & Bit Socket Set
MS-035M	35	I 35pcs Metric Flare Nut & L-Shaped Key Wrench Set
MS-014	14	J 14pcs Slotted, Philips & Posidriv Screwdriver Set
MS-013	13	K 13pcs Tang-Thru Screwdriver, Pry Bar & Carbon Scraper
MS-028S	28	L 28pcs SAE Flare Nut, E-Star & L-Shaped Key Wrench
TS-790	1	10 Drawer Top Tool Chest
TS-797	1	7 Drawer Side Cabinet
TS-798	1	7 Drawer Roller Cabinet

 233 Kg

 1 set / 251 Kgs / 38 CUFT



Master Sets

## MS-541 541 Piece 1/4", 3/8" & 1/2" Dr. Metric Master Tool Set (without tool cabinet & tool chest)

Item No.	Pcs	Description	Item No.	Pcs	Description
TD-211M	11	1/4" Dr. 6pt. Deep Metric Impact Socket Set	TX-23414	14	1/4", 3/8" & 1/2" Dr. Star Hand Socket Set
TF-214M	14	1/4" Dr. 6pt. Std. Metric Impact Socket Set	TX-2353	53	1/4" & 3/8" Dr. Bit Socket Set
700107	1	3/8" Dr. Impact Universal Joint	TX-246M	46	Extra Long Screwdriver Bits with OMNIDRIVE® Set
TG-312M	12	3/8" Dr. 6pt. Std. Metric Swivel Impact Socket Set	ID-414	14	1/2" Dr. Impact Driver Set
700108	1	1/2" Dr. Impact Universal Joint	TL-517X	17	Combination Screwdriver Set
IE-2349	9	1/4", 3/8" & 1/2" Dr. Impact Extension Bar Set	HS-5610M	10	Metric Hex Screwdriver Set
TG-411M	11	1/2" Dr. 6pt. Std. Metric Swivel Impact Socket Set	TX-513T	13	Star Screwdriver Set
CM-332M	32	3/8" Dr. 6pt. Std./Deep Metric Impact Socket Set	ND-012M	12	Metric Hex Nut Driver Set
IS-425M	25	1/2" Dr. 6pt. Std. Metric Impact Socket Set	780256	1	24mm Adjustable Wrench 200mmL
DI-425M	25	1/2" Dr. 6pt. Deep Metric Impact Socket Set	HS-024M	24	Metric Combination Wrench Set
280226P	1	1/4" Dr. Hinge Handle	DE-713M	13	Metric Double Ended Offset Ring Wrench Set
282262	1	1/4" Dr. 72 Teeth Flex Head Ratchet	HK-009MB	9	Metric Wobble Hex Wrench Set
GS-221M	21	1/4" Dr. 6pt. Std. & Deep Metric Hand Socket Set	SK-010T	10	L-Shaped Tamperproof Star Wrench Set
380336P	1	3/8" Dr. Hinge Handle	OS-505SP	5	Offset Slotted & Phillips Screwdriver
380400	1	3/8" Dr. Speed Handle	782300	1	Heavy Duty Pipe Wrench, 300mmL
380331P	1	3/8" Dr. Quick Release Ratchet	CP-5804	4	General Purpose Pliers Set
383363	1	3/8" Dr. 72 Teeth Flex Head Ratchet	RP-5504	4	Retaining Ring Pliers Set
383338	1	3/8" Dr. 72 Teeth Flex Head Ratchet	530310RA	1	Straight Jaw Pliers, 10"L
380030	1	3/8" Dr. Sliding T-Handle	511003S	1	Straight Cut Aviation Snip, 250mmL
380070	1	3/8" Dr. Universal Joint	590116	1	Claw hammer 1 lbs./ 454g
380371	1	1/4" & 3/8" Dr. Double Size Ratchet	590208	1	Ball Peen Hammer 1/2 lbs./ 227g
GS-332M	32	3/8" Dr. 6pt. Std. & Deep Metric Hand Socket Set	590216	1	Ball Peen Hammer 1 lbs./ 454g
480070	1	1/2" Dr. Universal Joint	590348	1	Drilling Hammer 3 lbs./ 1362g
480431P	1	1/2" Dr. Quick Release Ratchet	590416	1	Soft Face Hammer 1 lbs./454g
484464	1	1/2" Dr. 72 Teeth Flex Head Ratchet	590524	1	Rubber Mallet 1-1/2 lbs./ 681g
480420	1	1/2" Dr. Speed Handle 420 mmL	PC-514M	14	Metric Punch & Chisel Set
480446P	1	1/2" Dr. Hinge Handle	CW-403M	3	Metric Car Wheel Deep Impact Socket Set
480448P	1	1/2" Dr. Hinge Handle	002034	1	Magnetic Parts Tray, Double
DS-425M	25	1/2" Dr. 6pt. Deep Metric Hand Socket Set	AT-B16	1	Telescoping Magnetic Pick-Up Tool
SS-425M	25	1/2" Dr. 6pt. Std. Metric Hand Socket Set	PB-5094	4	Pry Bar Set

82 Kg

1 set / 88 Kgs / 7 CUFT

## MS-541TS 541 Piece 1/4", 3/8" & 1/2" Dr. Metric & SAE Master Tool Set

Item No.	Pcs	Description
MS-541	541	541 Piece 1/4", 3/8" & 1/2" Dr. Metric Master Set
TS-790	1	10 Drawer Top Chest
TS-797	1	7 Drawer Side Cabinet
TS-798	1	7 Drawer Roller Cabinet

264 Kg

1 set / 282 Kgs / 39 CUFT







# Master Sets

## MS-480TS 480 Piece 1/4", 3/8" & 1/2" Dr. Metric Mechanic Tool Set

Item No.	Pcs	Description
MS-013SP	13	A 13pcs Slotted & Philips Screwdriver Set
MS-013T	13	B 13pcs Star Screwdriver Set
MS-121M	121	C 121pcs 1/4" Dr. Metric Hand Socket & Bit Set
MS-071M	71	D 71pcs 3/8" Dr. Metric Hand Socket & Bit Socket Set
MS-437M	37	E 37pcs 1/2" Dr. Metric Hand Socket Set
MS-442B	42	F 42pcs 1/2" Dr. Bit Socket Set
MS-020M	20	G 20pcs Metric Combination Wrench
MS-020B	20	H 20pcs Metric Box End, Open End & E-Star Wrench Set
MS-019	19	I 19pcs Punch, Chisel & Hammer Set
MS-007P	7	J 7pcs Pliers Set
MS-008R	8	K 8pcs Retaining Ring Pliers & Oil Filter Wrench Set
MS-014A	14	L 14pcs Combination Auto Repair Tool Kit
MS-435M	35	M 35pcs 1/2" Dr. Metric Deep Hand Socket Set
MS-435I	35	N 35pcs 1/2" Dr. Metric Deep Impact Socket Set
MS-025R	25	O 25pcs Hex Screwdriver & Ratcheting Screwdriver Set
TS-244	1	4 Drawer Top Chest
TS-467P	1	7 Drawer Roller Cabinet w/ Inter Lock

 150 Kg

 1 set / 162.5 Kgs / 25.2 CUFT

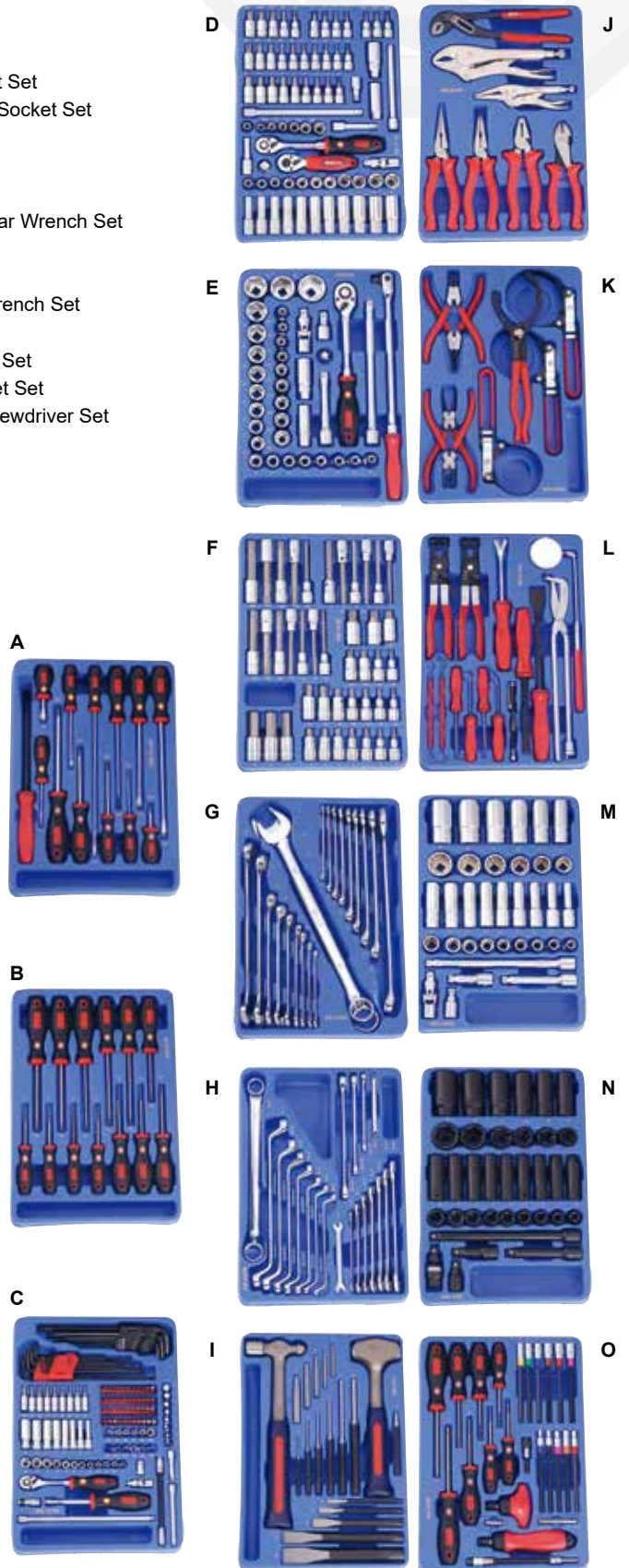

Master Sets

## MS-433TS 433 Piece 1/4" & 1/2" Dr. Metric Master Tool Set

Item No.	Pcs	Description
MS-098M	98	A 98pcs 1/4" & 1/2" Dr. Metric Socket & Wrench Set
MS-044M	44	B 44pcs Metric Complete & Wrench Set
MS-086	86	C 86pcs Screwdriver and Bit Set
MS-023	23	D 23pcs Punch, Chisel & Hammer Set
MS-015	15	E 15pcs Combination Pliers Set
MS-057M	57	F 57pcs 1/4" & 1/2" Dr. Swivel Socket & Bit Socket Set
MS-035M	35	G 35pcs Flare Nut & L-Shaped Wrench Set
MS-014	14	H 14pcs Screwdriver Set
MS-013	13	I 13pcs Pry, carbon Scraper & Tang-Thru Screwdriver Set
MS-048MS	48	J 48pcs Hex, Star, Triple Square & Square Bit Set
TS-468	1	7 Drawer Roller Cabinet

145 Kg

1 set / 155 Kgs / 24 CUFT

A



B



C



D



E



F



G



H



I

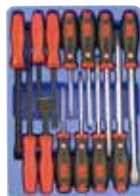

J

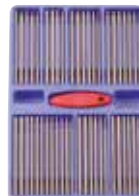

## MS-401TS 401 Piece 1/4" & 1/2" Dr. Metric & SAE Master Tool Set

Item No.	Pcs	Description
MS-098M	98	A 98pcs 1/4" & 1/2" Dr. Metric Socket & Wrench Set
MS-100S	100	B 100pcs 1/4" & 1/2" Dr. SAE Socket & Wrench Set
MS-044M	44	C 44pcs Metric Complete Wrench Set
MS-035S	35	D 35pcs SAE Complete Wrench Set
MS-086	86	E 86pcs Screwdriver and Bit Set
MS-023	23	F 23pcs Punch, Chisel & Hammer Set
MS-015	15	G 15pcs Combination Pliers Set
TS-244	1	4 Drawer Top Chest
TS-467P	1	7 Drawer Roller Cabinet

156 Kg

1 set / 166 Kgs / 27 CUFT

A



B

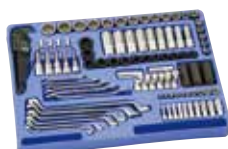

C



D



E



F



G



# Master Sets

## MS-399TS 399 Piece 3/8" Dr. Metric & SAE Master Tool Set

Item No.	Pcs	Description
MS-106M	106	A 106pcs 3/8" Dr. Metric Complete Socket & Wrench Set
MS-090S	90	B 90pcs 3/8" Dr. SAE Complete Socket & Wrench Set
MS-044M	44	C 44pcs Metric Complete Wrench Set
MS-035S	35	D 35pcs SAE Complete Wrench Set
MS-086	86	E 86pcs Screwdriver and Bit Set
MS-023	23	F 23pcs Punch, Chisel & Hammer Set
MS-015	15	G 15pcs Combination Plier Set
TS-244	1	4 Drawer Top Chest
TS-465	1	5 Drawer Roller Cabinet

104 Kg

1 set / 112 Kgs / 22 CUFT

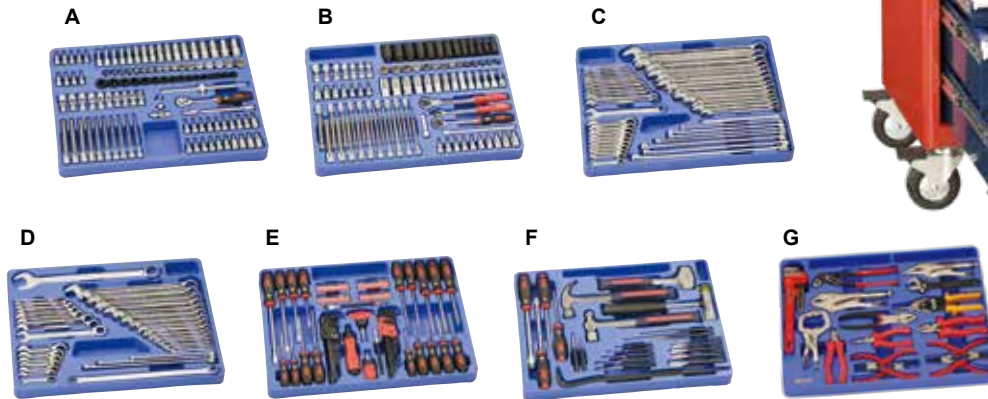

## MS-385TS 385 Piece 1/4" & 1/2" Dr. Metric Master Tool Set

Item No.	Pcs	Description
MS-098M	98	A 98pcs 1/4" & 1/2" Dr. Metric Socket & Wrench Set
MS-044M	44	B 44pcs Metric Complete & Wrench Set
MS-086	86	C 86pcs Screwdriver and Bit Set
MS-023	23	D 23pcs Punch, Chisel & Hammer Set
MS-015	15	E 15pcs Combination Plier Set
MS-057M	57	F 57pcs 1/4" & 1/2" Dr. Swivel Socket & Bit Socket Set
MS-035M	35	G 35pcs Flare Nut & L-Shaped Wrench Set
MS-014	14	H 14pcs Screwdriver Set
MS-013	13	I 13pcs Pry, Scraper & Tang-Thru Screwdriver Set
TS-797	7	7 Drawer Side Cabinet
TS-798	7	7 Drawer Roller Cabinet

158 Kg

1 set / 171 Kgs / 27 CUFT

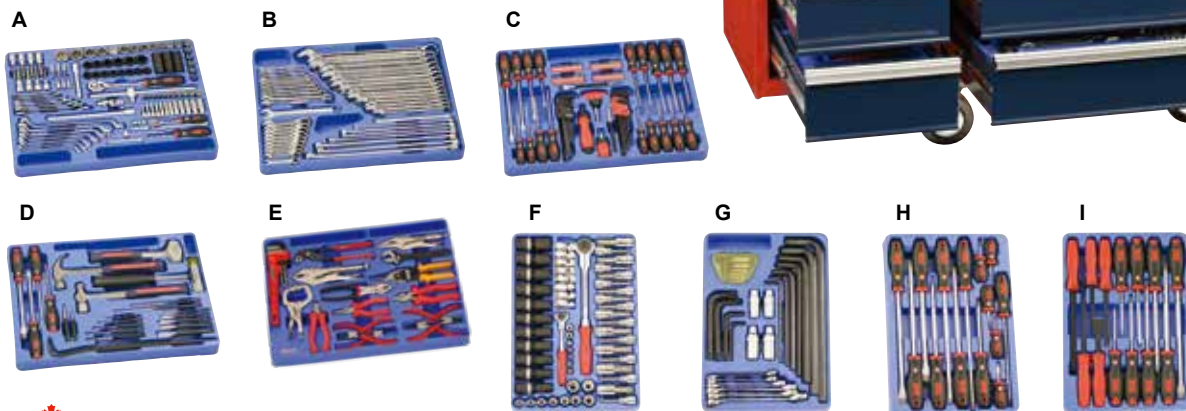

## MS-363TS 363 Piece 1/4", 3/8" & 1/2" Dr. Metric Mechanic Tool Set

Item No.	Pcs	Description
MS-013SP	13	A 13pcs Slotted & Phillips Screwdriver Set
MS-013T	13	B 13pcs Star Screwdriver Set
MS-121M	121	C 121pcs 1/4" Dr. Metric Hand Socket & Bit Set
MS-071M	71	D 71pcs 3/8" Dr. Metric Hand Socket & Bit Socket Set
MS-437M	37	E 37pcs 1/2" Dr. Metric Hand Socket Set
MS-442B	42	F 42pcs 1/2" Dr. Bit Socket Set
MS-020M	20	G 20pcs Metric Combination Wrench
MS-020B	20	H 20pcs Metric Box End, Open End & E-Star Wrench Set
MS-019	19	I 19pcs Punch, Chisel & Hammer Set
MS-007P	7	J 7pcs Pliers Set
TS-467P	1	7 Drawer Roller Cabinet w/ Inter Lock

102 Kg

1 set / 111 Kgs / 17.9 CUFT

**MS-363TS8** 363 Piece with TS-798 **NEW**

**MS-363TS8P** 363 Piece with TS-798P **NEW**



# Master Sets

## MS-361TS 361 Piece 3/8" Dr. Metric & SAE Mechanic Tool Set

Item No.	Pcs	Description
MS-106M	106	A 106pcs 3/8" Dr. Metric Tool Set
MS-090S	90	B 90pcs 3/8" Dr. SAE Tool Set
MS-044M	44	C 44pcs Metric Complete Wrench set
MS-035S	35	D 35pcs SAE Complete Wrench Set
MS-086	86	E 86pcs Screwdriver & Bit Set
TS-798	1	7 Drawer Roller Cabinet

102 Kg 1 set / 112 Kgs / 18.5 CUFT

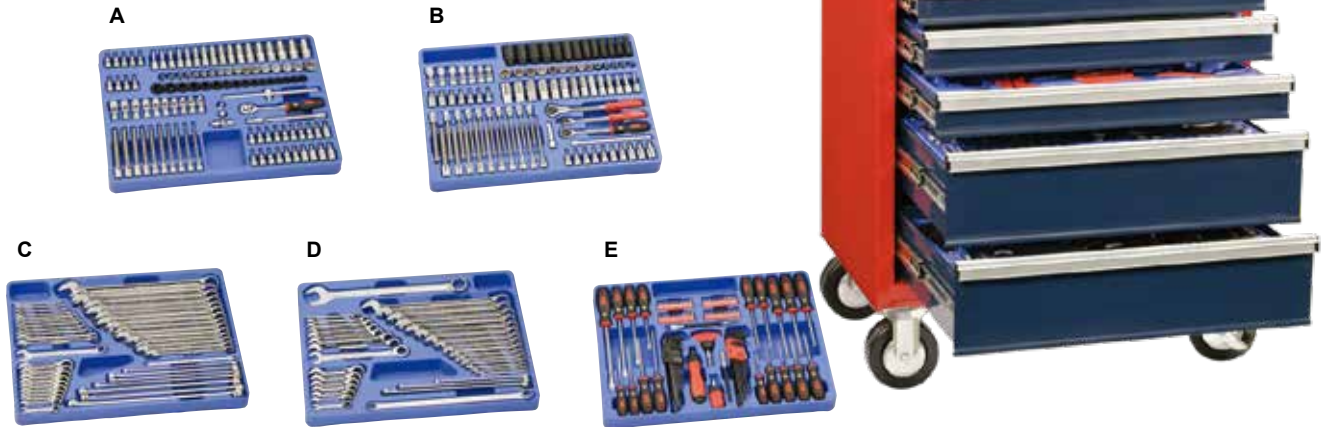

## MS-322TS 322 Piece 1/4" & 1/2" Dr. Metric & SAE Mechanic Tool Set

Item No.	Pcs	Description
MS-098M	98	A 98pcs 1/4" & 1/2" Dr. Metric Tool Set
MS-100S	100	B 100pcs 1/4" & 1/2" Dr. SAE Tool Set
MS-086	86	C 86pcs Screwdriver & Bit Set
MS-023	23	D 23pcs Punch, Chisel & Hammer Set
MS-015	15	E 15pcs Pliers Set
TS-467P	1	7 Drawer Roller Cabinet w/ Inter Lock System

107 Kg 1 set / 114 Kgs / 20 CUFT

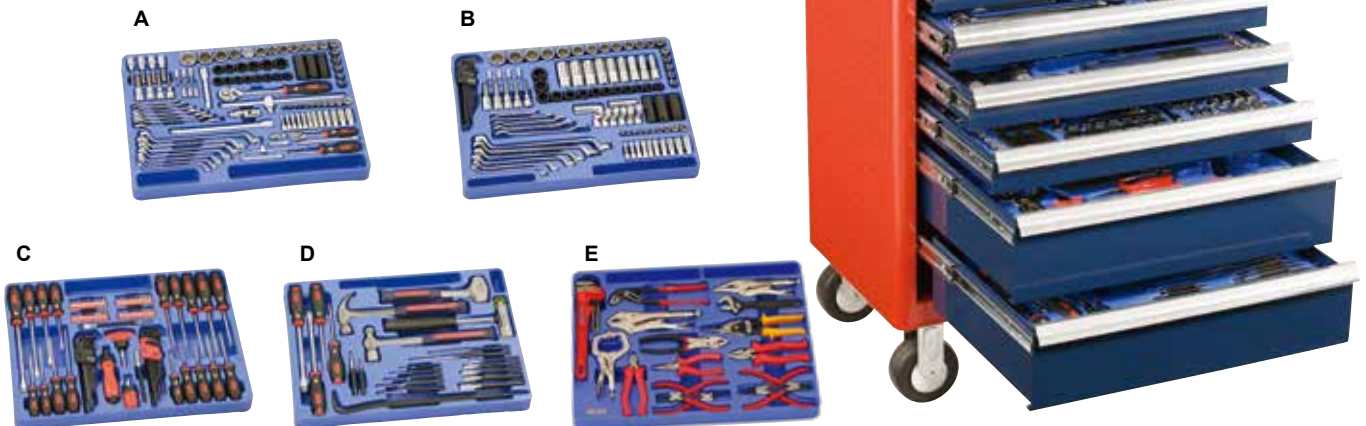

## MS-266TS 266 Piece 1/4" & 1/2" Dr. Metric Mechanic Tool Set

Item No.	Pcs	Description
MS-098M	98	A 98pcs 1/4" & 1/2" Dr. Metric Tool Set
MS-044M	44	B 44pcs Metric Complete Wrench Set
MS-086	86	C 86pcs Screwdriver & Bit Set
MS-023	23	D 23pcs Punch, Chisel & Hammer Set
MS-015	15	E 15pcs Pliers Set
TS-467P	1	7 Drawer Roller Cabinet w/ Inter Lock System

112 Kg

1 set / 119 Kgs / 20 CUFT

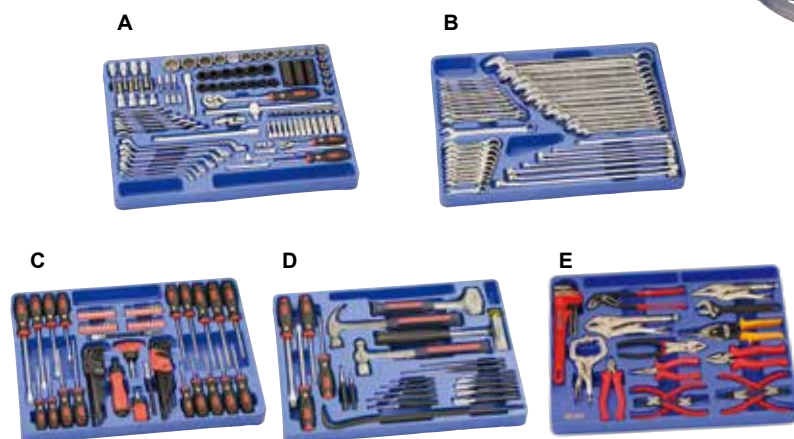

**NEW**  
**MS-266TS8** 266 Piece with TS-798  
**MS-266TS8P** 266 Piece with TS-798P



## MS-236TS 236 Piece 3/8" Dr. Metric Mechanic Tool Set

Item No.	Pcs	Description
MS-106M	106	A 106pcs 3/8" Dr. Metric Tool Set
MS-044M	44	B 44pcs Metric Complete Wrench Set
MS-086	86	C 86pcs Screwdriver & Bit Set
TS-465P	1	5 Drawer Roller Cabinet w/ Inter Lock System

81 Kg

1 set / 87 Kgs / 18 CUFT



# Master Sets

## MS-243TS 243 Piece 1/4" & 1/2" Dr. Metric Mechanic Tool Set

Item No.	Pcs	Description
MS-013SP	13	A 13pcs Slotted & Philips Screwdriver Set
MS-121M	121	B 121pcs 1/4" Dr. Metric Hand Socket & Bit Set
MS-437M	37	C 37pcs 1/2" Dr. Metric Hand Socket Set
MS-024M	24	D 24pcs Metric Combination & Box End Wrench Set
MS-019	19	E 19pcs Punch, Chisel & Hammer Set
MS-007P	7	F 7pcs Pliers Set
MS-008R	8	G 8pcs Retaining Ring Pliers & Oil Filter Wrench Set
MS-014A	14	H 14pcs Combination Auto Repair Tool Kit
TS-467P	1	7 Drawer Roller Cabinet w/ Inter Lock

91 Kg

1 set / 100 Kgs / 17.9 CUFT

**NEW**

**MS-243TS8** 243 Piece with TS-798

**MS-243TS8P** 243 Piece with TS-798P

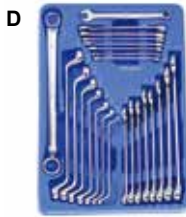
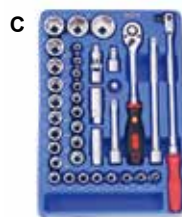
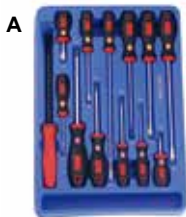

## MS-221TS 221 Piece 1/4" & 1/2" Dr. Metric Mechanic Tool Set

Item No.	Pcs	Description
MS-013SP	13	A 13pcs Slotted & Philips Screwdriver Set
MS-121M	121	B 121pcs 1/4" Dr. Metric Hand Socket & Bit Set
MS-437M	37	C 37pcs 1/2" Dr. Metric Hand Socket Set
MS-024M	24	D 24pcs Metric Combination & Box End Wrench Set
MS-019	19	E 19pcs Punch, Chisel & Hammer Set
MS-007P	7	F 7pcs Pliers Set
TS-244	1	4 Drawr Top Chest

49 Kg

1 set / 52 Kgs / 7.3 CUFT

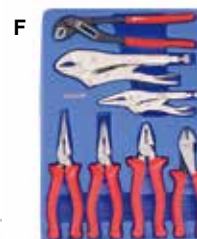
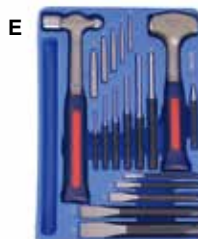
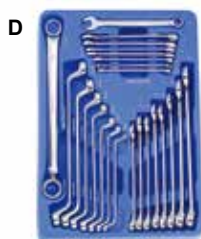
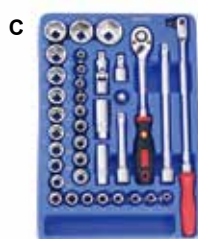
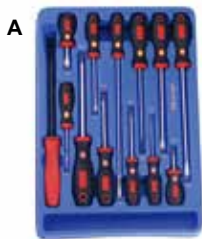

## MS-215TS 215 Piece 1/4", 3/8" & 1/2" Dr. Metric & SAE Tool Set

Item No.	Pcs	Description
MS-139MS	139	A 139pcs 1/4", 3/8" & 1/2" Dr. Metric & SAE Tool Set
MS-041MS	41	B 41pcs Metric & SAE Combination & Flare Nut Wrench Set
MS-035MS	35	C 35pcs Pliers & Screwdriver Set
TS-790	1	10 Drawer Top Chest

 73 Kg

 1 set / 82 Kgs / 11.2 CUFT



## MS-215TA 215 Piece 1/4", 3/8" & 1/2" Dr. Metric & SAE Tool Set

Item No.	Pcs	Description
MS-139MS	139	A 139pcs 1/4", 3/8" & 1/2" Dr. Metric & SAE Tool Set
MS-041MS	41	B 41pcs Metric & SAE Combination & Flare Nut Wrench Set
MS-035MS	35	C 35pcs Pliers & Screwdriver Set
TS-244	1	4 Drawer Top Chest

 53 Kg

 1 set / 59 Kgs / 8.6 CUFT





# Master Sets

## MS-110TS 110 Piece 1/4", 3/8" & 1/2" Dr. Metric Mechanic Tool Set

Item No.	Pcs	Description
TS-3244	44	A 44pcs 1/4" & 3/8" Dr. Metric Hand Socket Set
TS-4222	22	B 22pcs 1/2" Dr. Metric Hand Socket Set
TS-7418	18	C 18pcs Metric Combination Wrench Set
TS-5010	10	D 10pcs Combination Screwdriver Set
HK-009MB	9	9pcs Wobble Hex Key 1.5 ~ 10mm
780256	1	8" Adjustable Wrench
590212	1	12" Ball Peen Hammer
550604D	1	6" Chain Nose Pliers w/ Cutter
550607D	1	6" Diagonal Cutting Pliers
550712D	1	7" Side Cutter Pliers
551011D	1	10" Water Pump Pliers
530307A	1	7" Curved Jaw Locking Pliers w/ Cutter
TS-125	1	5 Tier Portable Tool Chest

17 Kg

1 set / 22 Kgs / 2 CUFT



## MS-142TS 142 Piece 1/4" & 1/2" Dr. Metric Mechanic Tool Set

Item No.	Pcs	Description
TS-2270	70	A 70pcs 1/4" Dr. Metric Hand Socket & Bit Set
TS-4223	23	B 23pcs Metric Hand Socket Set
TS-7418	18	C 18pcs Metric Combination Wrench Set
TS-5026	26	D 26pcs Combination Screwdriver Set
550607D	1	6" Diagonal Cutting Pliers
550712D	1	7" Side Cutter Pliers
550604D	1	6" Chain Nose Pliers w/ Cutter
530307A	1	7" Curved Jaw Locking Pliers w/ Cutter
551011D	1	10" Water Pump Pliers
590212	1	12" Ball Peen Hammer
TS-125	1	5 Tier Portable Tool Chest



17 Kg

1 set / 18 Kgs / 2 CUFT



## MS-190TS 190 Piece 1/4", 3/8" & 1/2" Dr. Metric & SAE Mechanic Tool Set

Item No.	Pcs	Description
TS-3244	44	A 44pcs 1/4" & 3/8" Dr. Metric Hand Socket Set
TS-4222	22	B 22pcs 1/2" Dr. Metric Hand Socket Set
TS-4763	63	C 63pcs 1/4", 3/8", 1/2" Dr. SAE Hand Socket Set
TS-7418	18	D 18pcs Metric Combination Wrench Set
TS-5010	10	E 10pcs Combination Screwdriver Set
TS-7517	17	F 17pcs SAE Combination Wrench Set
HK-009MB	9	9pcs Wobble Hex Key 1.5 ~ 10mm
780256	1	8" Adjustable Wrench
590212	1	12" Ball Peen Hammer
550604D	1	6" Chain Nose Pliers w/ Cutter
550607D	1	6" Diagonal Cutting Pliers
550712D	1	7" Side Cutter Pliers
551011D	1	10" Water Pump Pliers
530307A	1	7" Curved Jaw Locking Pliers w/ Cutter
TS-125	1	5 Tier Portable Tool Chest

 25.5 Kg  1 set / 26.5 Kgs / 2 CUFT

C



D



E

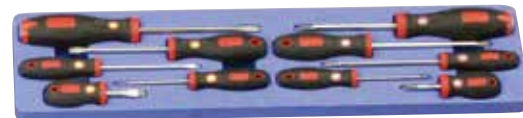

F



A



B



**Features:**

Long Size tool trays  
are suitable for TS-125  
5 Tier Portable Tool Chest

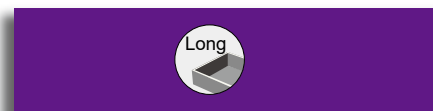

(530W x 125D)

## TS-4222 22 Piece 1/2" Dr. Metric Hand Socket Set

Item No.	Size	Item No.	Size
<b>1/2" Dr. 6pt Hand Socket:</b>			
423810	10mm	423819	19mm
423811	11mm	423821	21mm
423812	12mm	423822	22mm
423813	13mm	423823	23mm
423814	14mm	423824	24mm
423815	15mm	423827	27mm
423816	16mm	423830	30mm
423817	17mm	423832	32mm
423818	18mm		

6 pt.



(530W x 125D)

**1/2" Dr. Accessory:**

- 424125 Extension Bar, 125mmL
- 424250 Extension Bar, 250mmL
- 480070 Universal Joint
- 480446P Hinge Handle
- 480431S 36T Quick Release Ratchet
- Plastic Tray

4000 g

6 sets / 26 Kgs / 1.04 CUFT

## TS-4223 23 Piece 1/2" Dr. Metric Hand Socket Set

Item No.	Size	Item No.	Size
<b>1/2" Dr. 6pt Hand Socket:</b>			
423808	8mm	423816	16mm
423810	10mm	423817	17mm
423811	11mm	423818	18mm
423812	12mm	423819	19mm
423813	13mm	423821	21mm
423814	14mm	423822	22mm
423815	15mm	423824	24mm

6 pt.



(530W x 125D)

**Accessory:**

- 562019 19mm Flat Chisel
- 565123 3mm Pin Punch
- 565165 5mm Pin Punch
- 424075 1/2" Dr. Extension Bar, 75mmL
- 424250 1/2" Dr. Extension Bar, 250mmL
- 480070 1/2" Dr. Universal Joint
- 427016 1/2" Dr. 16.0mm Spark Plug Socket
- 427021 1/2" Dr. 20.6mm Spark Plug Socket
- 480472S 1/2" Dr. 72T Reversible Ratchet
- Plastic Tray

3000 g

6 sets / 20.5 Kgs / 1.04 CUFT

**TS-2270 70 Piece 1/4" Dr. Metric Hand Socket Set & Bit Set**

Item No.	Size	Item No.	Size	Item No.	Size
<b>1/4" Dr. 6pt Hand Socket:</b>					
222503	3mm	222508	8mm	220002	1/4" Dr. Extension Bar, 50mmL
222504	4mm	222509	9mm	220004	1/4" Dr. Extension Bar, 100mmL
2225045	4.5mm	222510	10mm	280070	1/4" Dr. Universal Joint
222505	5mm	222511	11mm	506+0175	1/4" Dr. Socket Driver
2225055	5.5mm	222512	12mm	594+0250	1/4" Dr. Flexible Spinner with Handle
222506	6mm	222513	13mm	283508	1/4" Hex Shank Bit Holder
222507	7mm	222514	14mm	280272S	1/4" Dr. 72T Reversible Ratchet
<b>1/4" Dr. 6pt Deep Hand Socket:</b>					
225206	6mm	225212	12mm	Plastic Tray	
225208	8mm	225213	13mm		
225210	10mm				

**Accessory:**

- SB-111SP 11pcs Slotted & Philips Bit Set
- SB-211MH 11pcs Metric Hex & Triple Square Bit Set
- SB-711TP 11pcs Star Bit Set
- SB-811TP 11pcs Tamperproof Star Bit Set

1250 g 6 sets / 9.5 Kgs / 1.04 CUFT



(530W x 125D)



**TS-3244 44 Piece 1/4" Dr. & 3/8" Dr. Metric Hand Socket Set**

Item No.	Size	Item No.	Size	Item No.	Size
<b>1/4" Dr. 6pt Hand Socket:</b>					
222504	4mm	222509	9mm	320075	3/8" Dr. Extension Bar, 75mmL
222505	5mm	222510	10mm	320150	3/8" Dr. Extension Bar, 150mmL
2225055	5.5mm	222511	11mm	380070	3/8" Dr. Universal Joint
222506	6mm	222512	12mm	380338P	3/8" Dr. Hinge Handle
222507	7mm	222513	13mm	326016	3/8" Dr. 16.0mm Spark Plug Socket
222508	8mm				
<b>1/4" Dr. Hex Head Hand Socket:</b>					
232803	3mm	232807	7mm	326021	3/8" Dr. 20.6mm Spark Plug Socket
232804	4mm	232808	8mm	380331S	3/8" Dr. 36T Quick Release Ratchet
232805	5mm	232809	9mm	Plastic Tray	
232806	6mm	232810	10mm		
<b>3/8" Dr. 6pt Metric Hand Socket:</b>					
323208	8mm	323214	14mm		
323209	9mm	323215	15mm		
323210	10mm	323216	16mm		
323211	11mm	323217	17mm		
323212	12mm	323218	18mm		
323213	13mm	323219	19mm		

**Accessory:**

- 220002 1/4" Dr. Extension Bar, 50mmL
- 220004 1/4" Dr. Extension Bar, 100mmL
- 280070 1/4" Dr. Universal Joint
- 506+0175 1/4" Dr. Socket Driver
- 280226P 1/4" Dr. Hinge Handle
- 280231S 1/4" Dr. 36T Quick Release Ratchet

2400 g 6 sets / 16.5 Kgs / 1.04 CUFT



(530W x 125D)



## TS-4763 63 Piece 1/4", 3/8" & 1/2" Dr. SAE Hand Socket Set

Item No.	Size	Item No.	Size	Item No.	Size
<b>1/4" Dr. 6pt Hand Socket:</b>			<b>1/2" Dr. 12pt Hand Socket:</b>		
282506	3/16"	282511	11/32"	473812	3/8"
282507	7/32"	282512	3/8"	473814	7/16"
282508	1/4"	282514	7/16"	473816	1/2"
282509	9/32"	282516	1/2"	473818	9/16"
282510	5/16"			473820	5/8"
<b>1/4" Dr. Hex Head Hand Socket:</b>				473822	11/16"
272804	1/8"	272808	1/4"	473824	3/4"
272805	5/32"	272809	9/32"	473826	13/16"
272806	3/16"	272810	5/16"	473828	7/8"
272807	7/32"	272812	3/8"	473830	15/16"
<b>1/4" Dr. 12pt Universal Hand Socket:</b>				473832	1"
263708	1/4"	263714	7/16"	473834	1-1/16"
263710	5/16"	263716	1/2"	473836	1-1/8"
263712	3/8"	263718	9/16"	473840	1-1/4"
<b>3/8" Dr. 12pt Hand Socket:</b>				<b>Key Wrench:</b>	
373210	5/16"	373218	9/16"	HK-009SB 9pcs SAE Wobble Hex Key Wrenches	
373211	11/32"	373219	19/32"	1/16, 5/64, 3/32, 1/8, 5/32,	
373212	3/8"	373220	5/8"	3/16, 1/4, 5/16, 3/8"	
373214	7/16"	373222	11/16"	Plastic Tray	
373216	1/2"	373224	3/4"		
<b>3/8" Dr. 12pt Universal Hand Socket:</b>					
365612	3/8"	365620	5/8"		
365614	7/16"	365622	11/16"		
365616	1/2"	365624	3/4"		
365618	9/16"				

6 pt.

12 pt.



3300 g

6 sets / 22 Kgs / 1.04 CUFT

(530W x 125D)

## TS-5026 26 Piece Combination Screwdriver Set

Item No.	Size	Item No.	Size
<b>Screwdriver w/Rubber Handle:</b>			
504+0430	0.5 x 3.0mm Slotted	504+1401	#1 Philips
504+1240	0.8 x 4.0mm Slotted	502+1202	#2 Philips, 98mmL
506+1966	1.2 x 6.5mm Slotted	506+1802	#2 Philips, 225mmL
502+1465	1.2 x 6.5mm Slotted		
<b>Tang-Thru Screwdriver w/Rubber Handle:</b>			
HK-009MB	9pcs Metric Wobble Hex Key Wrenches 1.5, 2, 2.5, 3, 4, 5, 6, 8, 10mm		
SK-010T	10pcs Tamperproof Star Key Wrenches T-9, 10, 15, 20, 25, 27, 30, 40, 45, 50		

Plastic Tray

1300 g

6 sets / 10 Kgs / 1.04 CUFT

(530W x 125D)



## TS-5010 10 Piece Combination Screwdriver Set

Item No.	Size	Item No.	Size
<b>Screwdriver w/Rubber Handle:</b>			
504+0430	0.5 x 3.0mm Slotted	504+0400	#0 Philips
504+1240	0.8 x 4.0mm Slotted	502+1201	#1 Philips, 98mmL
506+1455	1.0 x 5.5mm Slotted	504+1421	#1 Philips, 200mmL
502+1465	1.2 x 6.5mm Slotted	506+1802	#2 Philips
<b>Tang-Thru Screwdriver w/Rubber Handle:</b>			
509+1966	1.2 x 6.5mm Slotted	509+1801	#1 Philips

Plastic Tray

800 g

6 sets / 7 Kgs / 1.04 CUFT

(530W x 125D)



**TS-7418 18 Piece Metric Combination Wrench Set**

Item No.	Size	Item No.	Size
<b>Combination Wrench (Mirror Finish):</b>			
748206	6mm	748215	15mm
748207	7mm	748216	16mm
748208	8mm	748217	17mm
748209	9mm	748218	18mm
748210	10mm	748219	19mm
748211	11mm	748221	21mm
748212	12mm	748222	22mm
748213	13mm	748223	23mm
748214	14mm	748224	24mm

Plastic Tray

2800 g

6 sets / 19 Kgs / 1.04 CUFT



(530W x 125D)

**TS-7517 17 Piece SAE Combination Wrench Set**

Item No.	Size	Item No.	Size
<b>Combination Wrench (Mirror Finish):</b>			
759208	1/4"	759220	5/8"
759210	5/16"	759222	11/16"
759212	3/8"	759224	3/4"
759214	7/16"	759226	13/16"
759216	1/2"	759228	7/8"
759218	9/16"	759230	15/16"
<b>Flare Nut Wrench (Mirror Finish):</b>			
760810	1/4 x 5/16"	762022	5/8 x 11/16"
761214	3/8 x 7/16"	762428	3/4 x 7/8"
761618	1/2 x 9/16"		

Plastic Tray

2550 g

6 sets / 17.5 Kgs / 1.04 CUFT



(530W x 125D)



# Tool Trays

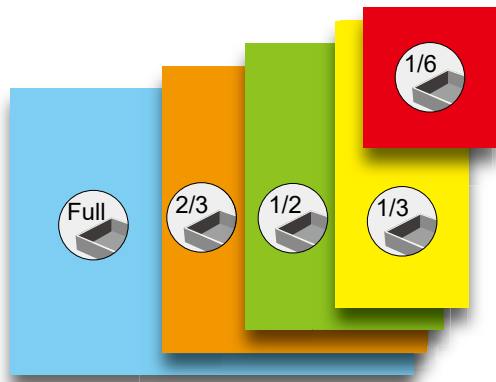

## Plastic Tray:

- High quality drawer insert to keep your tool chest organized and protected.
- We have designed five interchangeable insert sizes (1/6, 1/3, 1/2, 2/3 and full size) allowing you to mix and match your favorite tool selection within each drawer.
- For best fit, use with Genius brand tool chests.

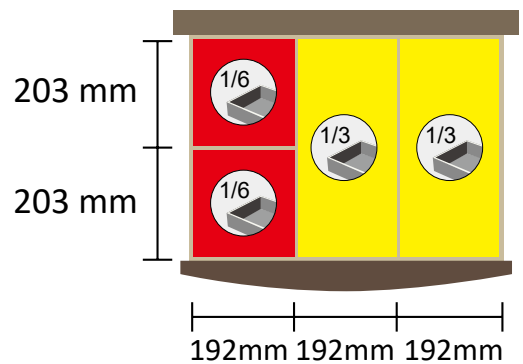
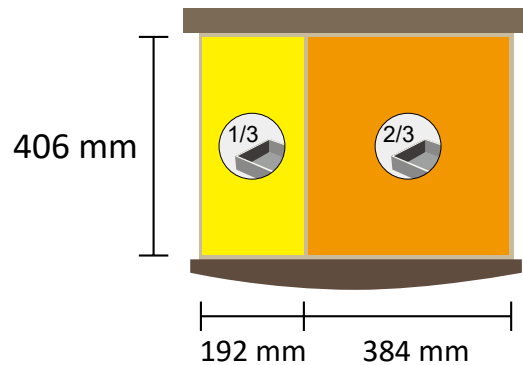
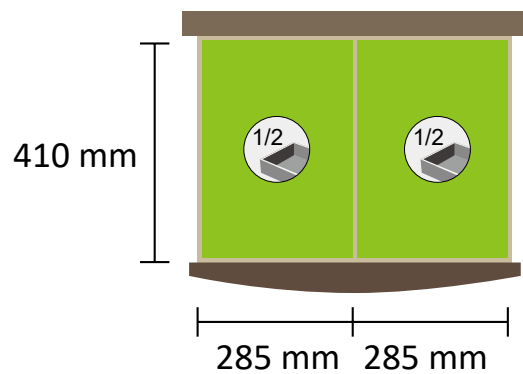
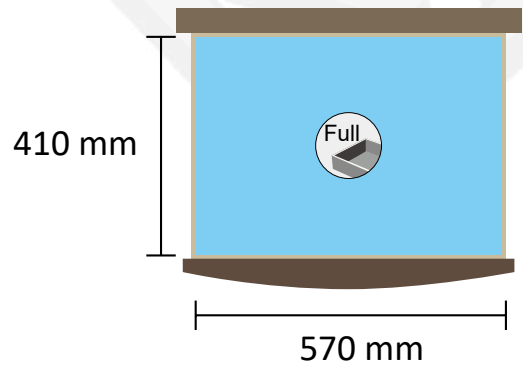

Master Sets

**IS-314M 14 Piece 3/8" Dr. Metric Impact Socket Set (CR-Mo)**

Item No.	Size	Item No.	Size
<b>3/8" Dr. 6pt Impact Socket (CR-Mo):</b>			
343208	8mm	343215	15mm
343209	9mm	343216	16mm
343210	10mm	343217	17mm
343211	11mm	343218	18mm
343212	12mm	343219	19mm
343213	13mm	343221	21mm
343214	14mm		

**3/8" Dr. Accessory:**

340075B Impact Extension Bar, 75mmL  
Plastic Tray

950 g 10 sets / 10.5 Kgs / 0.93 CUFT



(192W x 203D)



**IS-415M 15 Piece 1/2" Dr. Metric Impact Socket Set (CR-Mo)**

Item No.	Size	Item No.	Size
<b>1/2" Dr. 6pt Impact Socket (CR-Mo):</b>			
444010	10mm	444017	17mm
444011	11mm	444018	18mm
444012	12mm	444019	19mm
444013	13mm	444021	21mm
444014	14mm	444022	22mm
444015	15mm	444023	23mm
444016	16mm	444024	24mm

**1/2" Dr. Accessory:**

480125MB Impact Extension Bar, 125mmL  
Plastic Tray

1850 g 10 sets / 19.5 Kgs / 0.93 CUFT



(192W x 203D)



**DI-407M 7 Piece 1/2" Dr. Metric Deep Impact Socket Set (CR-Mo)**

Item No.	Size	Item No.	Size
<b>1/2" Dr. 6pt Deep Impact Socket (CR-Mo):</b>			
447830	30mm	447835	35mm
447832	32mm	447836	36mm
447833	33mm	447838	38mm
447834	34mm		Plastic Tray

3750 g 6 sets / 24 Kgs / 0.94 CUFT



(192W x 203D x 50H)



**DI-407S 7 Piece 1/2" Dr. SAE Deep Impact Socket Set (CR-Mo)**

Item No.	Size	Item No.	Size
<b>1/2" Dr. 6pt Deep Impact Socket (CR-Mo):</b>			
467836	1-1/8"	467844	1-3/8"
467838	1-3/16"	467846	1-7/16"
467840	1-1/4"	467848	1-1/2"
467842	1-5/16"		Plastic Tray

3750 g 6 sets / 24 Kgs / 0.94 CUFT



(192W x 203D x 50H)





## DI-415M 15 Piece 1/2" Dr. Metric Semi-Deep Thin Wall Impact Socket Set (CR-Mo)

Item No.	Size	Item No.	Size
<b>1/2" Dr. 6pt Semi-Deep Thin Wall Impact Socket (CR-Mo):</b>			
445210	10mm	445218	18mm
445211	11mm	445219	19mm
445212	12mm	445220	20mm
445213	13mm	445221	21mm
445214	14mm	445222	22mm
445215	15mm	445223	23mm
445216	16mm	445224	24mm
445217	17mm	Plastic Tray	

2100 g 10 sets / 22 Kgs / 0.93 CUFT



(192W x 203D)

6 pt.

## IE-2349 9 Piece 1/4", 3/8" & 1/2" Dr. Impact Extension Bar Set

Item No.	Size
<b>Impact Extension Bar:</b>	
210002	1/4" Dr. 50mmL (2"L)
210004	1/4" Dr. 100mmL (4"L)
210006	1/4" Dr. 150mmL (6"L)
310002	3/8" Dr. 50mmL (2"L)
310003	3/8" Dr. 75mmL (3"L)
310006	3/8" Dr. 150mmL (6"L)
410002	1/2" Dr. 50mmL (2"L)
410005	1/2" Dr. 125mmL (5"L)
410010	1/2" Dr. 250mmL (10"L)

Plastic Tray

1400 g 10 sets / 15 Kgs / 0.93 CUFT



(192W x 203D)

## TW-230M 30 Piece 1/4" Dr. Metric Deep Hand Socket Set (6 & 12-Point)

Item No.	Size	Item No.	Size
<b>1/4" Dr. 12pt Hand Socket:</b>			
232505	5mm	232510	10mm
2325055	5.5mm	232511	11mm
232506	6mm	232512	12mm
232507	7mm	232513	13mm
232508	8mm	232514	14mm
232509	9mm		
<b>1/4" Dr. 6pt Deep Hand Socket:</b>			
225204	4mm	225209	9mm
225205	5mm	225210	10mm
2252055	5.5mm	225211	11mm
225206	6mm	225212	12mm
225207	7mm	225213	13mm
225208	8mm	225214	14mm

### 1/4" Dr. Accessory:

220002	Extension Bar, 50mmL
220004	Extension Bar, 100mmL
220006	Extension Bar, 150mmL
280070	Universal Joint
280020	Sliding T-Handle
506+0175	Socket Driver
280231S	36T Quick Release Ratchet

Plastic Tray

1250 g 10 sets / 13.5 Kgs / 0.93 CUFT



(192W x 203D)

6 pt.

12 pt.

**TW-227MS 27 Piece 1/4" Dr. Metric & SAE Hand Socket Set (12-Point)**

Item No.	Size	Item No.	Size
<b>1/4" Dr. 12pt Hand Socket:</b>			
232505	5mm	272506	3/16"
2325055	5.5mm	272507	7/32"
232506	6mm	272508	1/4"
232507	7mm	272509	9/32"
232508	8mm	272510	5/16"
232509	9mm	272511	11/32"
232510	10mm	272512	3/8"
232511	11mm	272514	7/16"
232512	12mm	272516	1/2"
232513	13mm	272518	9/16"
232514	14mm		

**1/4" Dr. Accessory:**

220002	Extension Bar, 50mmL
220006	Extension Bar, 150mmL
280070	Universal Joint
280020	Sliding T-Handle
506+0175	Socket Driver
280231S	36T Quick Release Ratchet
Plastic Tray	

1000 g 10 sets / 11 Kgs / 0.93 CUFT



(192W x 203D)

12 pt.

**GS-222M 22 Piece 1/4" Dr. Metric Deep Hand Socket Set**

Item No.	Size	Item No.	Size
<b>1/4" Dr. 6pt Hand Socket:</b>			
222505	5mm	222509	9mm
2225055	5.5mm	222510	10mm
222506	6mm	222511	11mm
222507	7mm	222512	12mm
222508	8mm	222513	13mm
<b>1/4" Dr. 6pt Deep Hand Socket:</b>			
225206	6mm	225210	10mm
225207	7mm	225211	11mm
225208	8mm	225212	12mm
225209	9mm	225213	13mm

**1/4" Dr. Accessory:**

220002	Extension Bar, 50mmL
280070	Universal Joint
506+0175	Socket Driver
280231S	36T Quick Release Ratchet
Plastic Tray	

900 g 10 sets / 10 Kgs / 0.93 CUFT



(192W x 203D)

6 pt.

**RP-5504 4 Piece Retaining Ring Pliers Set**

Item No.	Size
550750	Straight Nose, External (7")
550751	Straight Nose, Internal (7")
550752	90° Bent Nose, External (7")
550753	90° Bent Nose, Internal (7")
Plastic Tray	

850 g 10 sets / 9.5 Kgs / 0.93 CUFT



(192W x 203D)



## EX-2349 9 Piece 1/4", 3/8" & 1/2" Dr. Hand Extension Bar Set

Item No.	Size
<b>Hand Extension Bar:</b>	
220002	1/4" Dr. 50mmL (2"L)
220004	1/4" Dr. 100mmL (4"L)
220006	1/4" Dr. 150mmL (6"L)
320050	3/8" Dr. 50mmL (2"L)
320075	3/8" Dr. 75mmL (3"L)
320150	3/8" Dr. 150mmL (6"L)
424050	1/2" Dr. 50mmL (2"L)
424125	1/2" Dr. 125mmL (5"L)
424250	1/2" Dr. 250mmL (10"L)

Plastic Tray

1200 g

10 sets / 13 Kgs / 0.93 CUFT



(192W x 203D)

## BE-2349 9 Piece 1/4", 3/8" & 1/2" Dr. Wobble Extension Bar Set

Item No.	Size
<b>Wobble Extension Bar:</b>	
220002B	1/4" Dr. 50mmL (2"L)
220004B	1/4" Dr. 100mmL (4"L)
220006B	1/4" Dr. 150mmL (6"L)
320002B	3/8" Dr. 50mmL (2"L)
320003B	3/8" Dr. 75mmL (3"L)
320006B	3/8" Dr. 150mmL (6"L)
420002B	1/2" Dr. 50mmL (2"L)
420005B	1/2" Dr. 125mmL (5"L)
420010B	1/2" Dr. 250mmL (10"L)

Plastic Tray

1200 g

10 sets / 13 Kgs / 0.93 CUFT



(192W x 203D)

## CW-404MS 4 Piece 1/2" Dr. Metric & SAE Thin Wall Impact Socket Set

Item No.	Size
<b>1/2" Dr. 6pt Thin Wall Impact Socket w/ plastic Sleeve:</b>	
448517W	17mm <span style="color: yellow;">■</span>
448519W	19mm <span style="color: red;">■</span>
448521W	21mm <span style="color: orange;">■</span>
468526W	13/16" <span style="color: blue;">■</span>

Plastic Tray

1200 g

10 sets / 13 Kgs / 0.93 CUFT



(192W x 203D)

6 pt.

## CW-406M 6 Piece 1/2" Dr. Metric Car Wheel COLOUR MATCH® Set

Item No.	Size
<b>1/2" Dr. 6pt Thin Wall Impact Socket w/ plastic Sleeve:</b>	
448517W	17mm <span style="color: yellow;">■</span>
448519W	19mm <span style="color: red;">■</span>
448521W	21mm <span style="color: orange;">■</span>

**1/2" Dr. Torque Extension Bar:**

487080	80 ft.lbs. (110 Nm)	<span style="color: yellow;">■</span>
487090	90 ft.lbs. (120 Nm)	<span style="color: red;">■</span>
487110	110 ft.lbs. (150 Nm)	<span style="color: orange;">■</span>

Plastic Tray

1500 g

10 sets / 16 Kgs / 0.93 CUFT



(192W x 203D)

6 pt.

**TX-412 12 Piece 1/2" Dr. Bit Socket Set**

Item No.	Size	Item No.	Size
<b>1/2" Dr. Bit Socket:</b>			
408+2735	5mm Hex, 190mmL	410+6550	T-50 Star, 110mmL
408+2536	6mm Hex, 110mmL	444+6670	T-70 Star, 150mmL
410+2547	7mm Hex, 110mmL	408+8506	M6 Triple Square, 110mmL
410+2548	8mm Hex, 110mmL	410+8508	M8 Triple Square, 110mmL
408+6540	T-40 Star, 110mmL	440+8510	M10 Triple Square, 110mmL
410+6545	T-45 Star, 110mmL	442+8512	M12 Triple Square, 110mmL

Plastic Tray  
 1600 g 10 sets / 17 Kgs / 0.93 CUFT



(192W x 203D)

**OW-707M 7 Piece Metric Open End Wrench Set**

Item No.	Size	Item No.	Size
<b>Open End Wrench (Matt Finish):</b>			
790607	6 x 7mm	791415	14 x 15mm
790809	8 x 9mm	791617	16 x 17mm
791011	10 x 11mm	791819	18 x 19mm
791213	12 x 13mm		

Plastic Tray  
 850 g 10 sets / 9.5 Kgs / 0.93 CUFT



(192W x 203D)

**OW-705S 5 Piece SAE Open End Wrench Set**

Item No.	Size	Item No.	Size
<b>Open End Wrench (Matt Finish):</b>			
770810	1/4 x 5/16"	772022	5/8 x 11/16"
771214	3/8 x 7/16"	77 2428	3/4 x 7/8"
771618	1/2 x 9/16"		

Plastic Tray  
 750 g 10 sets / 8.5 Kgs / 0.93 CUFT



(192W x 203D)

**TX-2324 24 Piece Star Wrench Set**

Item No.	Size	Item No.	Size
<b>3/8" Dr. E-Star Hand Socket:</b>			
353510	E-10	353516	E-16
353511	E-11	353518	E-18
353512	E-12	353520	E-20
353514	E-14		
<b>E-Star Wrench:</b>			
790608	E-6 x E-8	791418	E-14 x E-18
791012	E-10 x E-12	792024	E-20 x E-24
<b>Tamperproof Star Bit, 30mmL:</b>			
7108	1/4" Hex Shank T-8	7127	1/4" Hex Shank T-27
7110	1/4" Hex Shank T-10	7130	1/4" Hex Shank T-30
7115	1/4" Hex Shank T-15	7140	1/4" Hex Shank T-40
7120	1/4" Hex Shank T-20	7145	5/16" Hex Shank T-45
7125	1/4" Hex Shank T-25	7150	5/16" Hex Shank T-50

**Accessory:**  
 262808 1/4" Dr. x 1/4" Hex Shank Impact Bit Holder  
 363008 3/8" Dr. x 1/4" Hex Shank Impact Bit Holder  
 363010 3/8" Dr. x 5/16" Hex Shank Impact Bit Holder  
 Plastic Tray

1000 g 10 sets / 11 Kgs / 0.93 CUFT

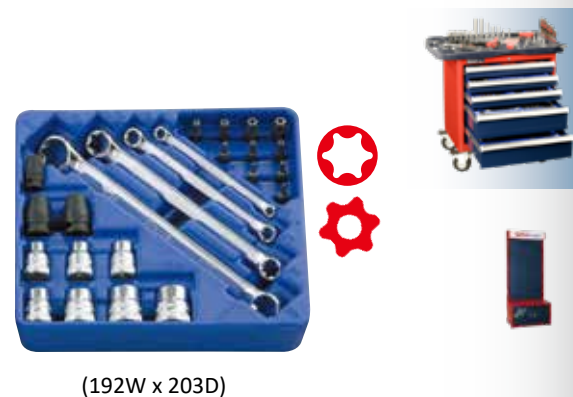

(192W x 203D)

## TF-332M 32 Piece 3/8" Dr. Metric Deep Impact Socket Set (CR-V)

Item No.	Size	Item No.	Size
<b>3/8" Dr. 6pt Impact Socket (CR-V):</b>			
313007	7mm	313015	15mm
313008	8mm	313016	16mm
313009	9mm	313017	17mm
313010	10mm	313018	18mm
313011	11mm	313019	19mm
313012	12mm	313020	20mm
313013	13mm	313021	21mm
313014	14mm	313022	22mm
<b>3/8" Dr. 6pt Deep Impact Socket (CR-V):</b>			
316307	7mm	316315	15mm
316308	8mm	316316	16mm
316309	9mm	316317	17mm
316310	10mm	316318	18mm
316311	11mm	316319	19mm
316312	12mm	316320	20mm
316313	13mm	316321	21mm
316314	14mm	316322	22mm

Plastic Tray

3650 g 5 sets / 19.5 Kgs / 0.93 CUFT



6 pt.

(192W x 406D)

## CM-332M 32 Piece 3/8" Dr. Metric Deep Impact Socket Set (CR-Mo)

Item No.	Size	Item No.	Size
<b>3/8" Dr. 6pt Impact Socket (CR-Mo):</b>			
343207	7mm	343215	15mm
343208	8mm	343216	16mm
343209	9mm	343217	17mm
343210	10mm	343218	18mm
343211	11mm	343219	19mm
343212	12mm	343220	20mm
343213	13mm	343221	21mm
343214	14mm	343222	22mm
<b>3/8" Dr. 6pt Deep Impact Socket (CR-Mo):</b>			
346307	7mm	346315	15mm
346308	8mm	346316	16mm
346309	9mm	346317	17mm
346310	10mm	346318	18mm
346311	11mm	346319	19mm
346312	12mm	346320	20mm
346313	13mm	346321	21mm
346314	14mm	346322	22mm

Plastic Tray

3450 g 5 sets / 18 Kgs / 0.93 CUFT



6 pt.

(192W x 406D)

## DI-417MD 17 Piece 1/2" Dr. Metric Deep Thin Wall Impact Socket Set (CR-Mo)

Item No.	Size	Item No.	Size
<b>1/2" Dr. 12pt Deep Thin Wall Impact Socket (CR-Mo):</b>			
448508	8mm	448517	17mm
448509	9mm	448518	18mm
448510	10mm	448519	19mm
448511	11mm	448520	20mm
448512	12mm	448521	21mm
448513	13mm	448522	22mm
448514	14mm	448523	23mm
448515	15mm	448524	24mm
448516	16mm	Plastic Tray	

3350 g

5 sets / 18 Kgs / 0.93 CUFT



12 pt.

(192W x 406D)

## TF-425M 25 Piece 1/2" Dr. Metric Impact Socket Set (CR-V)

Item No.	Size	Item No.	Size
<b>1/2" Dr. 6pt Impact Socket (CR-V):</b>			
413808	8mm	413821	21mm
413809	9mm	413822	22mm
413810	10mm	413823	23mm
413811	11mm	413824	24mm
413812	12mm	413825	25mm
413813	13mm	413826	26mm
413814	14mm	413827	27mm
413815	15mm	413828	28mm
413816	16mm	413829	29mm
413817	17mm	413830	30mm
413818	18mm	413831	31mm
413819	19mm	413832	32mm
413820	20mm		Plastic Tray

4000 g

3 sets / 13 Kgs / 0.82 CUFT



(192W x 406D)

6 pt.

## IS-425M 25 Piece 1/2" Dr. Metric Impact Socket Set (CR-Mo)

Item No.	Size	Item No.	Size
<b>1/2" Dr. 6pt Impact Socket (CR-Mo):</b>			
444008	8mm	444021	21mm
444009	9mm	444022	22mm
444010	10mm	444023	23mm
444011	11mm	444024	24mm
444012	12mm	444025	25mm
444013	13mm	444026	26mm
444014	14mm	444027	27mm
444015	15mm	444028	28mm
444016	16mm	444029	29mm
444017	17mm	444030	30mm
444018	18mm	444032	32mm
444019	19mm	444036	36mm
444020	20mm		Plastic Tray

4000 g

3 sets / 13 Kgs / 0.82 CUFT



(192W x 406D)

6 pt.

## IS-422S 22 Piece 1/2" Dr. SAE Impact Socket Set (CR-Mo)

Item No.	Size	Item No.	Size
<b>1/2" Dr. 6pt Impact Socket (CR-Mo):</b>			
464010	5/16"	464028	7/8"
464012	3/8"	464030	15/16"
464014	7/16"	464032	1"
464016	1/2"	464034	1-1/16"
464018	9/16"	464036	1-1/8"
464019	19/32"	464038	1-3/16"
464020	5/8"	464040	1-1/4"
464022	11/16"	464042	1-5/16"
464024	3/4"	464044	1-3/8"
464025	25/32"	464046	1-7/16"
464026	13/16"	464048	1-1/2"
			Plastic Tray

4350 g

3 sets / 14 Kgs / 0.82 CUFT



(192W x 406D)

6 pt.



## TD-424M 24 Piece 1/2" Dr. Metric Deep Impact Socket Set (CR-V) [Previous Item No.: TF-425MD](#)

Item No.	Size	Item No.	Size
<b>1/2" Dr. 6pt Deep Impact Socket (CR-V):</b>			
417808	8mm	417820	20mm
417809	9mm	417821	21mm
417810	10mm	417822	22mm
417811	11mm	417823	23mm
417812	12mm	417824	24mm
417813	13mm	417825	25mm
417814	14mm	417826	26mm
417815	15mm	417827	27mm
417816	16mm	417828	28mm
417817	17mm	417830	30mm
417818	18mm	417831	31mm
417819	19mm	417832	32mm

Blow-mold Tray

6200 g

3 sets / 20 Kgs / 0.82 CUFT



(192W x 406D)

6 pt.

## DI-424M 24 Piece 1/2" Dr. Metric Deep Impact Socket Set (CR-Mo) [Previous Item No.: DI-425M](#)

Item No.	Size	Item No.	Size
<b>1/2" Dr. 6pt Deep Impact Socket (CR-Mo):</b>			
447808	8mm	447820	20mm
447809	9mm	447821	21mm
447810	10mm	447822	22mm
447811	11mm	447823	23mm
447812	12mm	447824	24mm
447813	13mm	447825	25mm
447814	14mm	447826	26mm
447815	15mm	447827	27mm
447816	16mm	447828	28mm
447817	17mm	447830	30mm
447818	18mm	447832	32mm
447819	19mm	447836	36mm

Blow-mold Tray

7000 g

3 sets / 22 Kgs / 0.82 CUFT



(192W x 406D)

6 pt.

## DI-422S 22 Piece 1/2" Dr. SAE Deep Impact Socket Set (CR-Mo)

Item No.	Size	Item No.	Size
<b>1/2" Dr. 6pt Deep Impact Socket (CR-Mo):</b>			
467810	5/16"	467828	7/8"
467812	3/8"	467830	15/16"
467814	7/16"	467832	1"
467816	1/2"	467834	1-1/16"
467818	9/16"	467836	1-1/8"
467819	19/32"	467838	1-3/16"
467820	5/8"	467840	1-1/4"
467822	11/16"	467842	1-5/16"
467824	3/4"	467844	1-3/8"
467825	25/32"	467846	1-7/16"
467826	13/16"	467848	1-1/2"

Plastic Tray

6700 g

3 sets / 21 Kgs / 0.82 CUFT



(192W x 406D)

6 pt.

## CW-408MS 8 Piece 1/2" Dr. Metric & SAE Car Wheel COLOUR MATCH® Set

Item No.	Size	Item No.	Size
<b>1/2" Dr. 6pt Thin Wall Impact Socket w/ plastic Sleeve:</b>			
448517W	17mm	448521W	21mm
448519W	19mm	468526W	13/16"
<b>1/2" Dr. Torque Extension Bar:</b>			
487080	80 ft.lbs. (110 Nm)		
487090	90 ft.lbs. (120 Nm)		
487100	100 ft.lbs. (135 Nm)		
487110	110 ft.lbs. (150 Nm)		

Plastic Tray

2200 g 5 sets / 12 Kgs / 0.93 CUFT

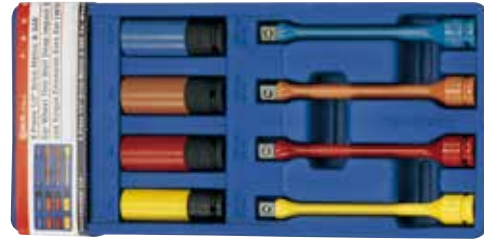

(192W x 406D)

## CP-5704 4 Piece Pliers Set

Item No.	Description
550812	8" Side Cutter Pliers
550707	7" Diagonal Cutting Pliers
550804	8" Chain Nose Pliers w/ Cutter
550809	8" Combination Slip Joint Pliers

Plastic Tray

1650 g 10 sets / 17.5 Kgs / 1.58 CUFT



(192W x 406D)

## CP-5804 4 Piece General Purpose Pliers Set

Item No.	Description
550604D	6" Chain Nose Pliers w/ Cutter
550607D	6" Diagonal Cutting Pliers
550712D	7" Side Cutter Pliers
551011D	10" Water Pump Pliers

Plastic Tray

1600 g 10 sets / 17 Kgs / 1.58 CUFT



(192W x 406D)

## GS-332M 32 Piece 3/8" Dr. Metric Deep Hand Socket Set

Item No.	Size	Item No.	Size
<b>3/8" Dr. 6pt Hand Socket:</b>			
323207	7mm	323215	15mm
323208	8mm	323216	16mm
323209	9mm	323217	17mm
323210	10mm	323218	18mm
323211	11mm	323219	19mm
323212	12mm	323220	20mm
323213	13mm	323221	21mm
323214	14mm	323222	22mm

**3/8" Dr. 6pt Deep Hand Socket:**

326307	7mm	326315	15mm
326308	8mm	326316	16mm
326309	9mm	326317	17mm
326310	10mm	326318	18mm
326311	11mm	326319	19mm
326312	12mm	326320	20mm
326313	13mm	326321	21mm
326314	14mm	326322	22mm

Plastic Tray

2700 g 5 sets / 14.5 Kgs / 0.93 CUFT



(192W x 406D)

6 pt.





## EU-335M 35 Piece 3/8" Dr. Metric Deep Hand Socket Set (6 & 12-Point)

Item No.	Size	Item No.	Size
<b>3/8" Dr. 12pt Hand Socket:</b>			
333207	7mm	333215	15mm
333208	8mm	333216	16mm
333209	9mm	333217	17mm
333210	10mm	333218	18mm
333211	11mm	333219	19mm
333212	12mm	333221	21mm
333213	13mm	333222	22mm
333214	14mm		

6-point: GS-335M also available

<b>3/8" Dr. 6pt Deep Hand Socket:</b>			
326307	7mm	326315	15mm
326308	8mm	326316	16mm
326309	9mm	326317	17mm
326310	10mm	326318	18mm
326311	11mm	326319	19mm
326312	12mm	326321	21mm
326313	13mm	326322	22mm
326314	14mm		

### 3/8" Dr. Accessory:

380070	Universal Joint	320150	Extension Bar, 150mmL
380030	Sliding T-Handle	320250	Extension Bar, 250mmL
380331S	36T Quick Release Ratchet		
Plastic Tray			

3450 g 5 sets / 18.5 Kgs / 0.93 CUFT



(192W x 406D)

6 pt.

12 pt.

## GS-330S 30 Piece 3/8" Dr. SAE Deep Hand Socket Set (6 & 12-Point)

Item No.	Size	Item No.	Size
<b>3/8" Dr. 12pt Hand Socket:</b>			
373208	1/4"	373219	19/32"
373210	5/16"	373220	5/8"
373211	11/32"	373222	11/16"
373212	3/8"	373224	3/4"
373214	7/16"	373226	13/16"
373216	1/2"	373228	7/8"
373218	9/16"		

<b>3/8" Dr. 6pt Deep Hand Socket:</b>			
386308	1/4"	386318	9/16"
386310	5/16"	386320	5/8"
386311	11/32"	386322	11/16"
386312	3/8"	386324	3/4"
386314	7/16"	386326	13/16"
386316	1/2"	386328	7/8"

### 3/8" Dr. Accessory:

380070	Universal Joint	320150	Extension Bar, 6"L
380030	Sliding T-Handle	320250	Extension Bar, 10"L
380331S	36T Quick Release Ratchet		
Plastic Tray			

3150 g 5 sets / 17 Kgs / 0.93 CUFT



(192W x 406D)

6 pt.

12 pt.

**SS-425M 25 Piece 1/2" Dr. Metric Hand Socket Set**

Item No.	Size	Item No.	Size
<b>1/2" Dr. 6pt Hand Impact Socket:</b>			
423808	8mm	423821	21mm
423809	9mm	423822	22mm
423810	10mm	423823	23mm
423811	11mm	423824	24mm
423812	12mm	423825	25mm
423813	13mm	423826	26mm
423814	14mm	423827	27mm
423815	15mm	423828	28mm
423816	16mm	423829	29mm
423817	17mm	423830	30mm
423818	18mm	423832	32mm
423819	19mm	423836	36mm
423820	20mm		Plastic Tray

 3650 g

 3 sets / 12 Kgs / 0.82 CUFT



(192W x 406D)

6 pt.

**SS-422S 22 Piece 1/2" Dr. SAE Hand Socket Set**

Item No.	Size	Item No.	Size
<b>1/2" Dr. 6pt Hand Impact Socket:</b>			
483810	5/16"	483828	7/8"
483812	3/8"	483830	15/16"
483814	7/16"	483832	1"
483816	1/2"	483834	1-1/16"
483818	9/16"	483836	1-1/8"
483819	19/32"	483838	1-3/16"
483820	5/8"	483840	1-1/4"
483822	11/16"	483842	1-5/16"
483824	3/4"	483844	1-3/8"
483825	25/32"	483846	1-7/16"
483826	13/16"	483848	1-1/2"
			Plastic Tray

 4000 g

 3 sets / 13 Kgs / 0.82 CUFT

(192W x 406D)

6 pt.

**DS-424M 24 Piece 1/2" Dr. Metric Deep Hand Socket Set**

Previous Item No.: DS-425M

Item No.	Size	Item No.	Size
<b>1/2" Dr. 6pt Deep Hand Impact Socket:</b>			
427808	8mm	427820	20mm
427809	9mm	427821	21mm
427810	10mm	427822	22mm
427811	11mm	427823	23mm
427812	12mm	427824	24mm
427813	13mm	427825	25mm
427814	14mm	427826	26mm
427815	15mm	427827	27mm
427816	16mm	427828	28mm
427817	17mm	427830	30mm
427818	18mm	427832	32mm
427819	19mm	427836	36mm
			Blow-mold Tray

 7000 g

 3 sets / 22 Kgs / 0.82 CUFT

(192W x 406D)

6 pt.



## DS-422S 22 Piece 1/2" Dr. SAE Deep Hand Socket Set

Item No.	Size	Item No.	Size
<b>1/2" Dr. 6pt Deep Hand Impact Socket:</b>			
487810	5/16"	487828	7/8"
487812	3/8"	487830	15/16"
487814	7/16"	487832	1"
487816	1/2"	487834	1-1/16"
487818	9/16"	487836	1-1/8"
487819	19/32"	487838	1-3/16"
487820	5/8"	487840	1-1/4"
487822	11/16"	487842	1-5/16"
487824	3/4"	487844	1-3/8"
487825	25/32"	487846	1-7/16"
487826	13/16"	487848	1-1/2"

Plastic Tray

6700 g

3 sets / 21 Kgs / 0.82 CUFT



(192W x 406D)

6 pt.

## TW-423M 23 Piece 1/2" Dr. Metric Hand Socket Set (12-Point)

Item No.	Size	Item No.	Size
<b>1/2" Dr. 12pt Hand Socket:</b>			
433808	8mm	433818	18mm
433810	10mm	433819	19mm
433811	11mm	433821	21mm
433812	12mm	433822	22mm
433813	13mm	433823	23mm
433814	14mm	433824	24mm
433815	15mm	433827	27mm
433816	16mm	433830	30mm
433817	17mm	433832	32mm

**1/2" Dr. Accessory:**

480070	Universal Joint	424125	Extension Bar, 125mmL
480040	Sliding T-Handle	424250	Extension Bar, 250mmL
480431S	36T Quick Release Ratchet		

Plastic Tray

4200 g

5 sets / 22 Kgs / 0.93 CUFT



(192W x 406D)

12 pt.

## TW-423S 23 Piece 1/2" Dr. SAE Hand Socket Set (12-Point)

Item No.	Size	Item No.	Size
<b>1/2" Dr. 12pt Hand Socket:</b>			
473810	5/16"	473825	25/32"
473812	3/8"	473826	13/16"
473814	7/16"	473828	7/8"
473816	1/2"	473830	15/16"
473818	9/16"	473832	1"
473819	19/32"	473834	1-1/16"
473820	5/8"	473836	1-1/8"
473822	11/16"	473838	1-3/16"
473824	3/4"	473840	1-1/4"

**1/2" Dr. Accessory:**

480070	Universal Joint	424125	Extension Bar, 5"L
480040	Sliding T-Handle	424250	Extension Bar, 10"L
480431S	36T Quick Release Ratchet		

Plastic Tray

4400 g

5 sets / 23 Kgs / 0.93 CUFT



(192W x 406D)

12 pt.

**TX-2353 53 Piece 1/4" & 3/8" Dr. Complete Bit Socket Set**

Item No.	Size	Item No.	Size
<b>1/4" Dr. Bit Socket, 45mmL:</b>			
208+1130	0.5 x 3.0mm Slotted	208+2122	2mm Hex
208+1140	0.6 x 4.0mm Slotted	208+2125	2.5mm Hex
208+1101	#1 Philips	208+2133	3mm Hex
208+1102	#2 Philips	208+2134	4mm Hex
208+3104	1/16" Hex	208+6106	T-6 Star
208+3105	5/64" Hex	208+6107	T-7 Star
208+3106	3/32" Hex	208+6108	T-8 Star
208+3107	7/64" Hex	208+6109	T-9 Star
208+3108	1/8" Hex	208+6110	T-10 Star
208+3110	5/32" Hex	208+6115	T-15 Star
<b>3/8" Dr. Bit Socket, 50mmL:</b>			
308+1150	0.8 x 5.0mm Slotted	308+3112	3/16" Hex
308+1160	1.0 x 6.0mm Slotted	308+3114	7/32" Hex
310+1280	1.2 x 8.0mm Slotted	308+3116	1/4" Hex
308+1103	#3 Philips	310+3128	9/32" Hex
310+1124	#4 Philips	310+3130	5/16" Hex
308+2135	5mm Hex	312+3134	3/8" Hex
308+2136	6mm Hex	314+3138	7/16" Hex
310+2147	7mm Hex	316+3142	1/2" Hex
310+2148	8mm Hex	308+6120	T-20 Star
340+2150	10mm Hex	308+6125	T-25 Star
342+2152	12mm Hex	308+6127	T-27 Star
308+8104	M4 Triple Square	308+6130	T-30 Star
308+8105	M5 Triple Square	308+6140	T-40 Star
308+8106	M6 Triple Square	310+6245	T-45 Star
310+8108	M8 Triple Square	310+6250	T-50 Star
340+8110	M10 Triple Square	340+6255	T-55 Star
342+8112	M12 Triple Square		Plastic Tray

2500 g 5 sets / 13.5 Kgs / 0.93 CUFT



(192W x 406D)



**BS-3424P 24 Piece 3/8" & 1/2" Dr. Slotted & Philips Bit Socket Set**

Item No.	Size	Item No.	Size
<b>3/8" Dr. Bit Socket, 50mmL:</b>			
308+1140	0.6 x 4.0mm Slotted	310+1290	1.6 x 9.0mm Slotted
308+1150	0.8 x 5.0mm Slotted	308+1101	#1 Philips
308+1160	1.0 x 6.0mm Slotted	308+1102	#2 Philips
310+1280	1.2 x 8.0mm Slotted		
<b>3/8" Dr. Bit Socket, 140mmL:</b>			
308+1640	0.6 x 4.0mm Slotted	310+1690	1.6 x 9.0mm Slotted
308+1650	0.8 x 5.0mm Slotted	308+1601	#1 Philips
308+1660	1.0 x 6.0mm Slotted	308+1602	#2 Philips
310+1680	1.2 x 8.0mm Slotted		
<b>1/2" Dr. Bit Socket, 80mmL:</b>			
440+1492	2.0 x 12.0mm Slotted	408+1303	#3 Philips
442+1494	2.5 x 14.0mm Slotted	410+1404	#4 Philips
444+1496	2.5 x 16.0mm Slotted		
<b>1/2" Dr. Bit Socket, 150mmL:</b>			
440+1692	2.0 x 12.0mm Slotted	408+1603	#3 Philips
442+1694	2.5 x 14.0mm Slotted	410+1604	#4 Philips
444+1696	2.5 x 16.0mm Slotted		
			Plastic Tray

2500 g 5 sets / 13.5 Kgs / 0.93 CUFT



(192W x 406D)



## BS-3424T 24 Piece 3/8" & 1/2" Dr. Star Bit Socket Set

Item No.	Size	Item No.	Size
<b>3/8" Dr. Star Bit Socket, 50mmL:</b>			
308+6110	T-10	308+6127	T-27
308+6115	T-15	308+6130	T-30
308+6120	T-20	308+6140	T-40
308+6125	T-25		
<b>3/8" Dr. Star Bit Socket, 140mmL:</b>			
308+6610	T-10	308+6627	T-27
308+6615	T-15	308+6630	T-30
308+6620	T-20	308+6640	T-40
308+6625	T-25		
<b>1/2" Dr. Star Bit Socket, 80mmL:</b>			
410+6345	T-45	442+6360	T-60
410+6350	T-50	444+6370	T-70
440+6355	T-55		
<b>1/2" Dr. Star Bit Socket, 150mmL:</b>			
410+6645	T-45	442+6660	T-60
410+6650	T-50	444+6670	T-70
440+6655	T-55		

Plastic Tray

2650 g 5 sets / 14.5 Kgs / 0.93 CUFT



(192W x 406D)



## BS-3424TA 24 Piece 3/8" & 1/2" Dr. Tamperproof Star Bit Socket Set

Item No.	Size	Item No.	Size
<b>3/8" Dr. Tamperproof Star Bit Socket, 50mmL:</b>			
308+7110	T-10	308+7127	T-27
308+7115	T-15	308+7130	T-30
308+7120	T-20	308+7140	T-40
308+7125	T-25		
<b>3/8" Dr. Tamperproof Star Bit Socket, 140mmL:</b>			
308+7610	T-10	308+7627	T-27
308+7615	T-15	308+7630	T-30
308+7620	T-20	308+7640	T-40
308+7625	T-25		
<b>1/2" Dr. Tamperproof Star Bit Socket, 80mmL:</b>			
410+7345	T-45	442+7360	T-60
410+7350	T-50	444+7370	T-70
440+7355	T-55		
<b>1/2" Dr. Tamperproof Star Bit Socket, 150mmL:</b>			
410+6645	T-45	442+6660	T-60
410+6650	T-50	444+6670	T-70
440+6655	T-55		

Plastic Tray

2650 g 5 sets / 14.5 Kgs / 0.93 CUFT



(192W x 406D)



**BS-3424H 24 Piece 3/8" & 1/2" Dr. SAE Hex Bit Socket Set**

Item No.	Size	Item No.	Size
<b>3/8" Dr. Hex Bit Socket:</b>			
308+3108	1/8", 50mmL	308+3608	1/8", 140mmL
308+3110	5/32", 50mmL	308+3610	5/32", 140mmL
308+3112	3/16", 50mmL	308+3612	3/16", 140mmL
308+3114	7/32", 50mmL	308+3614	7/32", 140mmL
308+3116	1/4", 50mmL	308+3616	1/4", 140mmL
310+3128	9/32", 50mmL	310+3618	9/32", 140mmL
310+3130	5/16", 50mmL	310+3620	5/16", 140mmL
<b>1/2" Dr. Hex Bit Socket:</b>			
412+3324	3/8", 80mmL	412+3624	3/8", 150mmL
414+3328	7/16", 80mmL	414+3628	7/16", 150mmL
416+3332	1/2", 80mmL	416+3632	1/2", 150mmL
418+3336	9/16", 80mmL	418+3636	9/16", 150mmL
420+3340	5/8", 80mmL	420+3640	5/8", 150mmL

Plastic Tray

3250 g 5 sets / 17.5 Kgs / 0.93 CUFT



(192W x 406D)

**SB-247M 47 Piece Screwdriver Bit Set**

Item No.	Size	Item No.	Size
<b>Screwdriver Bit, 30mmL:</b>			
7110	1/4" x T-10 Tamperproof Star	8106	1/4" x M6 Triple Square
7115	1/4" x T-15 Tamperproof Star	8108	5/16" x M8 Triple Square
7120	1/4" x T-20 Tamperproof Star	8110	10mm x M10 Triple Square
7125	1/4" x T-25 Tamperproof Star	1211	1/4" x #1 Posidriv
7127	1/4" x T-27 Tamperproof Star	1212	1/4" x #2 Posidriv
7130	1/4" x T-30 Tamperproof Star	2134	1/4" x 4mm Hex
7140	1/4" x T-40 Tamperproof Star	2135	1/4" x 5mm Hex
7145	5/16" x T-45 Tamperproof Star	2136	1/4" x 6mm Hex
7150	5/16" x T-50 Tamperproof Star	2147	5/16" x 7mm Hex
7155	10mm x T-55 Tamperproof Star	2148	5/16" x 8mm Hex
8105	1/4" x M5 Triple Square	2150	10mm x 10mm Hex
<b>Screwdriver Bit, 88mmL:</b>			
7510	1/4" x T-10 Tamperproof Star	8506	1/4" x M6 Triple Square
7515	1/4" x T-15 Tamperproof Star	8508	5/16" x M8 Triple Square
7520	1/4" x T-20 Tamperproof Star	8510	10mm x M10 Triple Square
7525	1/4" x T-25 Tamperproof Star	1511	1/4" x #1 Posidriv
7527	1/4" x T-27 Tamperproof Star	1512	1/4" x #2 Posidriv
7530	1/4" x T-30 Tamperproof Star	2534	1/4" x 4mm Hex
7540	1/4" x T-40 Tamperproof Star	2535	1/4" x 5mm Hex
7545	5/16" x T-45 Tamperproof Star	2536	1/4" x 6mm Hex
7550	5/16" x T-50 Tamperproof Star	2547	5/16" x 7mm Hex
7555	10mm x T-55 Tamperproof Star	2548	5/16" x 8mm Hex
8505	1/4" x M5 Triple Square	2550	10mm x 10mm Hex

**Accessory:**

- 383908 3/8" Dr. 1/4" Hex Shank Bit Holder
- 383910 3/8" Dr. 5/16" Hex Shank Bit Holder
- 323910 3/8" Dr. 10mm Hex Shank Bit Holder

Plastic Tray

1500 g 10 sets / 16 Kgs / 1.58 CUFT



(192W x 406D)



## TR-507S 7 Piece Slotted & Philips Screwdriver Set

Item No.	Size	Item No.	Size
<b>Screwdriver w/Rubber Handle:</b>			
504+0430	0.5 x 3.0mm, 155mmL	504+0400	#0 Philips, 155mmL
504+1240	0.8 x 4.0mm, 180mmL	504+1421	#1 Philips, 200mmL
506+0560	1.0 x 6.0mm, 250mmL	506+1802	#2 Philips, 225mmL
506+1966	1.2 x 6.5mm, 250mmL		Plastic Tray

1000 g 5 sets / 6 Kgs / 0.93 CUFT



(192W x 406D)

## TR-508Z 8 Piece Combination Screwdriver Set

Item No.	Size	Item No.	Size
<b>Screwdriver w/Rubber Handle:</b>			
506+1455	1.0 x 5.5mm, 200mmL	504+1421	#1 Philips, 200mmL
506+1966	1.2 x 6.5mm, 250mmL	506+1802	#2 Philips, 225mmL
506+1980	1.2 x 8.0mm, 280mmL	504+1841	#1 Posidriv, 180mmL
508+1990	1.6 x 10.0mm, 320mmL	506+1952	#2 Posidriv, 250mmL
			Plastic Tray

1350 g 10 sets / 14.5 Kgs / 1.58 CUFT



(192W x 406D)

## TR-510TA 10 Piece Tamperproof Star Screwdriver Set

Item No.	Size	Item No.	Size
<b>Tamperproof Star Screwdriver w/Rubber Handle:</b>			
504+7608	T-8, 150mmL	506+7827	T-27, 225mmL
506+7710	T-10, 180mmL	506+7830	T-30, 225mmL
506+7715	T-15, 180mmL	508+7940	T-40, 255mmL
506+7920	T-20, 200mmL	508+7945	T-45, 255mmL
506+7925	T-25, 200mmL	508+7850	T-50, 235mmL
			Plastic Tray

1500 g 10 sets / 16 Kgs / 1.58 CUFT



(192W x 406D)

## HR-5608M 8 Piece Metric Hex Screwdriver Set

Item No.	Size	Item No.	Size
<b>Hex Screwdriver w/Rubber Handle:</b>			
504+2622	2mm, 150mmL	506+2735	5mm, 185mmL
504+2625	2.5mm, 150mmL	506+2736	6mm, 185mmL
504+2633	3mm, 150mmL	508+2847	7mm, 235mmL
506+2634	4mm, 170mmL	508+2848	8mm, 235mmL
			Plastic Tray

1300 g 10 sets / 14 Kgs / 1.58 CUFT

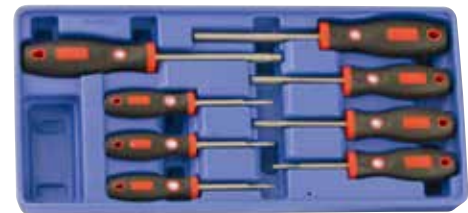

(192W x 406D)

## HR-5611S 11 Piece SAE Hex Screwdriver Set

Item No.	Size	Item No.	Size
<b>Hex Screwdriver w/Rubber Handle:</b>			
504+3604	1/16", 150mmL	506+3712	3/16", 185mmL
504+3605	5/64", 150mmL	506+3714	7/32", 185mmL
504+3606	3/32", 150mmL	506+3816	1/4", 225mmL
504+3607	7/64", 150mmL	508+3818	9/32", 235mmL
504+3608	1/8", 150mmL	508+3820	5/16", 235mmL
506+3610	5/32", 170mmL		Plastic Tray

1500 g 10 sets / 16 Kgs / 1.58 CUFT

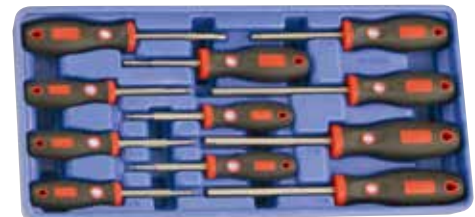

(192W x 406D)

**HR-578MW 8 Piece Metric Wobble Hex Screwdriver Set**

Item No.	Size	Item No.	Size
<b>Wobble Hex Screwdriver w/Rubber Handle:</b>			
504+4633	3mm, 150mmL	508+4847	7mm, 235mmL
506+4634	4mm, 170mmL	508+4848	8mm, 235mmL
506+4735	5mm, 185mmL	508+4849	9mm, 235mmL
506+4736	6mm, 185mmL	508+4850	10mm, 235mmL

1550 g 10 sets / 16.5 Kgs / 1.58 CUFT



(192W x 406D)

**HR-578SW 8 Piece SAE Wobble Hex Screwdriver Set**

Item No.	Size	Item No.	Size
<b>Wobble Hex Screwdriver w/Rubber Handle:</b>			
504+5608	1/8", 150mmL	506+5816	1/4", 225mmL
506+5610	5/32", 170mmL	508+5818	9/32", 235mmL
506+5712	3/16", 185mmL	508+5820	5/16", 235mmL
506+5714	7/32", 185mmL	508+5824	3/8", 235mmL

1450 g 10 sets / 15.5 Kgs / 1.58 CUFT



(192W x 406D)

**TL-508 8 Piece Slotted & Philips Screwdriver Set**

Item No.	Size	Item No.	Size
<b>Screwdriver w/Plastic Handle:</b>			
591+1465	1.2 x 6.5mm, 86mmL	591+1201	#1 Philips, 86mmL
593+1965	1.2 x 6.5mm, 195mmL	593+1401	#1 Philips, 170mmL
594+1980	1.2 x 8.0mm, 285mmL	593+1802	#2 Philips, 220mmL
594+1990	1.6 x 10.0mm, 310mmL	593+1902	#2 Philips, 295mmL

1300 g 10 sets / 14 Kgs / 1.58 CUFT



(192W x 406D)

**TL-508X 8 Piece Slotted & Philips Screwdriver Set**

Item No.	Size	Item No.	Size
<b>Screwdriver w/Plastic Handle:</b>			
591+1465	1.2 x 6.5mm, 86mmL	591+1201	#1 Philips, 86mmL
594+1965	1.2 x 6.5mm, 210mmL	594+1401	#1 Philips, 185mmL
595+1980	1.2 x 8.0mm, 295mmL	594+1802	#2 Philips, 235mmL
595+1990	1.6 x 10.0mm, 320mmL	594+1902	#2 Philips, 310mmL

1350 g 10 sets / 14.5 Kgs / 1.58 CUFT



(192W x 406D)

**TX-512A 12 Piece Tamperproof Star Screwdriver Set**

Item No.	Size	Item No.	Size
<b>Tamperproof Star Screwdriver w/Rubber Handle:</b>			
592+7606	T-6, 145mmL	593+7920	T-20, 195mmL
592+7607	T-7, 145mmL	593+7925	T-25, 195mmL
592+7608	T-8, 145mmL	594+7827	T-27, 215mmL
592+7609	T-9, 145mmL	594+7830	T-30, 215mmL
593+7710	T-10, 175mmL	595+7940	T-40, 250mmL
593+7715	T-15, 175mmL	595+7945	T-45, 250mmL

1400 g 10 sets / 15 Kgs / 1.58 CUFT

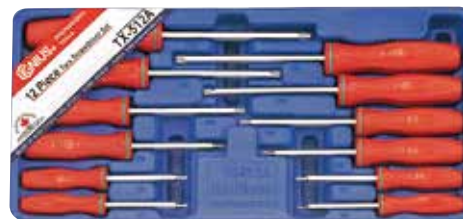

(192W x 406D)



## HS-5610M 10 Piece Metric Hex Screwdriver Set

Item No.	Size	Item No.	Size
<b>Hex Screwdriver w/Plastic Handle:</b>			
592+2622	2mm, 145mmL	593+2736	6mm, 180mmL
592+2625	2.5mm, 145mmL	594+2847	7mm, 225mmL
592+2633	3mm, 145mmL	594+2848	8mm, 225mmL
592+2634	4mm, 145mmL	595+2849	9mm, 225mmL
593+2735	5mm, 180mmL	595+2850	10mm, 225mmL

1500 g      5 sets / 8.5 Kgs / 0.93 CUFT

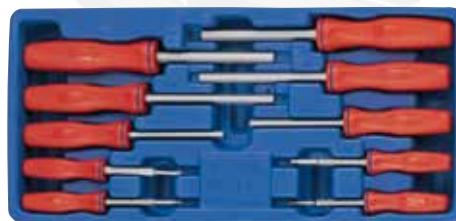

(192W x 406D)

## HS-5612S 12 Piece SAE Hex Screwdriver Set

Item No.	Size	Item No.	Size
<b>Hex Screwdriver w/Plastic Handle:</b>			
592+3604	1/16", 145mmL	593+3712	3/16", 180mmL
592+3605	5/64", 145mmL	593+3714	7/32", 180mmL
592+3606	3/32", 145mmL	594+3816	1/4", 225mmL
592+3607	7/64", 145mmL	594+3818	9/32", 225mmL
592+3608	1/8", 145mmL	594+3820	5/16", 225mmL
592+3610	5/32", 145mmL	595+3824	3/8", 225mmL

1500 g      5 sets / 8.5 Kgs / 0.93 CUFT

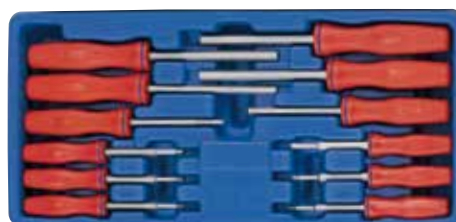

(192W x 406D)

## HS-5708MW 8 Piece Metric Wobble Hex Screwdriver Set

Item No.	Size	Item No.	Size
<b>Wobble Hex Screwdriver w/Plastic Handle:</b>			
592+4633	3mm, 145mmL	594+4847	7mm, 225mmL
592+4634	4mm, 145mmL	594+4848	8mm, 225mmL
593+4735	5mm, 180mmL	595+4849	9mm, 225mmL
593+4736	6mm, 180mmL	595+4850	10mm, 225mmL

1300 g      5 sets / 7.5 Kgs / 0.93 CUFT

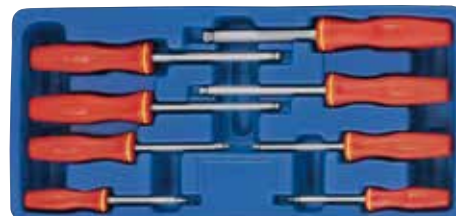

(192W x 406D)

## HS-5708SW 8 Piece SAE Wobble Hex Screwdriver Set

Item No.	Size	Item No.	Size
<b>Wobble Hex Screwdriver w/Plastic Handle:</b>			
592+5608	1/8", 145mmL	594+5816	1/4", 225mmL
592+5610	5/32", 145mmL	594+5818	9/32", 225mmL
593+5712	3/16", 180mmL	595+5820	5/16", 225mmL
593+5714	7/32", 180mmL	595+5824	3/8", 225mmL

1300 g      5 sets / 7.5 Kgs / 0.93 CUFT

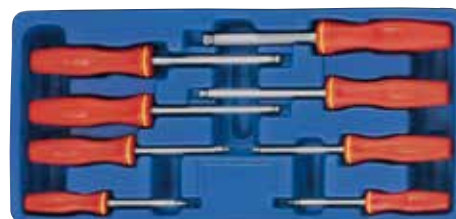

(192W x 406D)

**CW-007M 7 Piece Metric Combination Wrench Set - Mirror Finish**

Item No.	Size	Item No.	Size
<b>Combination Wrench (Mirror Finish):</b>			
748210	10mm	748219	19mm
748212	12mm	748222	22mm
748214	14mm	748224	24mm
748217	17mm	Plastic Tray	

1850 g 10 sets / 19.5 Kgs / 1.58 CUFT



(192W x 406D)

**HS-007M 7 Piece Metric Combination Wrench Set - Matt Finish**

Item No.	Size	Item No.	Size
<b>Combination Wrench (Matt Finish):</b>			
726010	10mm	726019	19mm
726012	12mm	726022	22mm
726014	14mm	726024	24mm
726017	17mm	Plastic Tray	

1650 g 10 sets / 17.5 Kgs / 1.58 CUFT



(192W x 406D)

**PR-015M 15 Piece Metric Combination Wrench Set - Mirror Finish**

Item No.	Size	Item No.	Size
<b>Combination Wrench (Mirror Finish):</b>			
748207	7mm	748215	15mm
748208	8mm	748216	16mm
748209	9mm	748217	17mm
748210	10mm	748218	18mm
748211	11mm	748219	19mm
748212	12mm	748222	22mm
748213	13mm	748224	24mm
748214	14mm	Plastic Tray	

2500 g 10 sets / 26.5 Kgs / 1.58 CUFT



(192W x 406D)

**GW-7607M 7 Piece Metric Combination Ratcheting Wrench Set**

Item No.	Size	Item No.	Size
<b>Combination Ratcheting Wrench:</b>			
768508	8mm	768514	14mm
768510	10mm	768517	17mm
768512	12mm	768519	19mm
768513	13mm	Plastic Tray	

1250 g 10 sets / 13.5 Kgs / 1.58 CUFT



(192W x 406D)

**DE-707M 7 Piece Metric Offset Box End Wrench Set - Mirror Finish**

Item No.	Size	Item No.	Size
<b>Offset Box End Wrench (Mirror Finish):</b>			
740607	6 x 7mm	741415	14 x 15mm
740809	8 x 9mm	741617	16 x 17mm
741011	10 x 11mm	741819	18 x 19mm
741213	12 x 13mm	Plastic Tray	

1350 g 10 sets / 14.5 Kgs / 1.58 CUFT



(192W x 406D)



## MS-042M 42 Piece 3/8" Dr. Metric Deep Impact & Star Hand Socket Set

Item No.	Size	Item No.	Size
<b>3/8" Dr. 6pt Deep Impact Socket (CR-Mo):</b>			
346307	7mm	346315	15mm
346308	8mm	346316	16mm
346309	9mm	346317	17mm
346310	10mm	346318	18mm
346311	11mm	346319	19mm
346312	12mm	346320	20mm
346313	13mm	346321	21mm
346314	14mm	346322	22mm
<b>3/8" Dr. 6pt Swivel Impact Socket (CR-V):</b>			
380008M	8mm	380014M	14mm
380009M	9mm	380015M	15mm
380010M	10mm	380016M	16mm
380011M	11mm	380017M	17mm
380012M	12mm	380018M	18mm
380013M	13mm	380019M	19mm
<b>3/8" Dr. E-Star Hand Socket:</b>			
353510	E-10	353516	E-16
353511	E-11	353518	E-18
353512	E-12	353520	E-20
353514	E-14		

Item No.	Size	Item No.	Size
<b>3/8" Dr. Accessory:</b>			
380075MB	Impact Extension Bar, 75mmL		
380125MB	Impact Extension Bar, 125mmL		
380200MB	Impact Extension Bar, 200mmL		
700107	Impact Universal Joint		
320160L	L-Handle		
380370	72T Stubby Ratchet		
383363P	72T Flex Head Ratchet		
	Plastic Tray		



5100 g 3 sets / 16.5 Kgs / 1.35 CUFT

(285W x 410D x 50H)

## MS-065S 65 Piece 3/8" Dr. Head Driver & Impact Socket Set

Item No.	Size	Item No.	Size
<b>3/8" Dr. 6pt Swivel Impact Socket (CR-V):</b>			
380J21	5/16"	380025	9/16"
380022	3/8"	380026	5/8"
380023	7/16"	380027	11/16"
380024	1/2"	380028	3/4"
<b>3/8" Dr. Head Driver, 52mmL:</b>			
3452P055	1.0 x 5.5mm	365210	5/16" Hex
3452P08	1.2 x 8.0mm	365212	3/8" Hex
3452P10	1.6 x 10.0mm	365214	7/16" Hex
3452R01	#1 Philips	365216	1/2" Hex
3452R02	#2 Philips	365218	9/16" Hex
3452R03	#3 Philips	365220	5/8" Hex
3452R04	#4 Philips	3452S10	T-10 Star
345204	4mm Hex	3452S15	T-15 Star
345205	5mm Hex	3452S20	T-20 Star
345206	6mm Hex	3452S25	T-25 Star
345207	7mm Hex	3452S27	T-27 Star
345208	8mm Hex	3452S30	T-30 Star
345209	9mm Hex	3452S40	T-40 Star
345210	10mm Hex	3452S45	T-45 Star
345212	12mm Hex	3452S50	T-50 Star
345214	14mm Hex	3452S55	T-55 Star
345216	16mm Hex	3452T05	M5 Triple Square
345217	17mm Hex	3452T06	M6 Triple Square
365205	5/32" Hex	3452T08	M8 Triple Square
365206	3/16" Hex	3452T10	M10 Triple Square
365207	7/32" Hex	3452T12	M12 Triple Square
365208	1/4" Hex		

Item No.	Size	Item No.	Size
<b>3/8" Dr. 6pt Impact Socket (CR-Mo):</b>			
363210	5/16"		
363211	11/32"		
363212	3/8"		
363214	7/16"		
363216	1/2"		
363218	9/16"		
363219	19/32"		
363220	5/8"		
363222	11/16"		
363224	3/4"		
363225	25/32"		
363226	13/16"		
363228	7/8"		
<b>3/8" Dr. Accessory:</b>			
700007	Impact Driver		
	Plastic Tray		

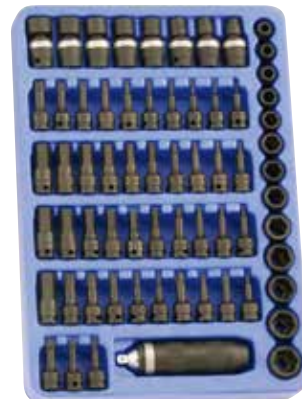

5000 g 3 sets / 16 Kgs / 1.35 CUFT

(285W x 410D x 50H)

**MS-435I 35 Piece 1/2" Dr. Metric Deep Impact Socket Set**

Item No.	Size	Item No.	Size
<b>1/2" Dr. 6pt Impact Socket (CR-V):</b>			
413810	10mm	413819	19mm
413812	12mm	413821	21mm
413813	13mm	413822	22mm
413814	14mm	413824	24mm
413815	15mm	413827	27mm
413816	16mm	413830	30mm
413817	17mm	413832	32mm
413818	18mm		
<b>1/2" Dr. 6pt Deep Impact Socket (CR-V):</b>			
417810	10mm	417819	19mm
417812	12mm	417821	21mm
417813	13mm	417822	22mm
417814	14mm	417824	24mm
417815	15mm	417827	27mm
417816	16mm	417830	30mm
417817	17mm	417832	32mm
417818	18mm		

7100 g 3 sets / 23 Kgs / 1.35 CUFT

Item No.	Size
<b>1/2" Dr. Accessory:</b>	
410002	Impact Extension Bar, 50mmL
410003	Impact Extension Bar, 75mmL
410006	Impact Extension Bar, 125mmL
410010	Impact Extension Bar, 250mmL
700108	Impact Universal Joint
	Plastic Tray



(285W x 410D x 50H)

6 pt.

**MS-027S 27 Piece 1/2" Dr. SAE Impact Socket & Accessory Set**

Item No.	Size	Item No.	Size
<b>1/2" Dr. 6pt Deep Impact Socket (CR-Mo):</b>			
467830	15/16"	467840	1-1/4"
467832	1"	467842	1-5/16"
467834	1-1/16"	467844	1-3/8"
467836	1-1/8"	467846	1-7/16"
467838	1-3/16"	467848	1-1/2"
<b>1/2" Dr. 6pt Swivel Impact Socket (CR-V):</b>			
488014	7/16"	488022	11/16"
488016	1/2"	488024	3/4"
488018	9/16"	488026	13/16"
488020	5/8"	488028	7/8"
<b>1/2" Dr. Hex Bit Socket:</b>			
418+3336	9/16"	422+3344	11/16"
420+3340	5/8"	424+3348	3/4"

8650 g 3 sets / 27 Kgs / 1.35 CUFT

Item No.	Size
<b>1/2" Dr. Accessory:</b>	
480075MB	Impact Extension Bar, 3"L
480125MB	Impact Extension Bar, 5"L
480250MB	Impact Extension Bar, 10"L
700108	Impact Universal Joint
420260L	L-Handle
	Plastic Tray



(285W x 410D x 50H)

6 pt.

## MS-437M 37 Piece 1/2" Dr. Metric Hand Socket Set

Item No.	Size	Item No.	Size	Item No.	Size
<b>1/2" Dr. 6pt Hand Socket:</b>			<b>1/2" Dr. Accessory:</b>		
423808	8mm	423818	18mm	424050	Extension Bar, 50mmL
423809	9mm	423819	19mm	424125	Extension Bar, 125mmL
423810	10mm	423821	21mm	424250	Extension Bar, 250mmL
423811	11mm	423822	22mm	420033	Adapter, 1/2"F x 3/8"M
423812	12mm	423824	24mm	480070	Universal Joint
423813	13mm	423827	27mm	427016	16.0mm Spark Plug Socket
423814	14mm	423830	30mm	427021	20.6mm Spark Plug Socket
423815	15mm	423832	32mm	480446P	Hinge Handle
423816	16mm	423836	36mm	480431S	36T Quick Release Ratchet
423817	17mm				Plastic Tray
<b>1/2" Dr. E-Star Hand Socket:</b>					
454510	E-10	454518	E-18		
454511	E-11	454520	E-20		
454512	E-12	454522	E-22		
454514	E-14	454524	E-24		
454516	E-16				

5700 g 3 sets / 19 Kgs / 1.35 CUFT



(285W x 410D x 50H)



## MS-435M 35 Piece 1/2" Dr. Metric Deep Hand Socket Set (6 & 12-Point)

Item No.	Size	Item No.	Size	Item No.	Size
<b>1/2" Dr. 12pt Hand Socket:</b>			<b>1/2" Dr. Accessory:</b>		
433810	10mm	433819	19mm	420002B	Wobble Extension Bar, 50mmL
433812	12mm	433821	21mm	420003B	Wobble Extension Bar, 75mmL
433813	13mm	433822	22mm	420005B	Wobble Extension Bar, 125mmL
433814	14mm	433824	24mm	420010B	Wobble Extension Bar, 250mmL
433815	15mm	433827	27mm	480070	Universal Joint
433816	16mm	433830	30mm		
433817	17mm	433832	32mm		
433818	18mm				
<b>1/2" Dr. 6pt Deep Hand Socket:</b>					
427810	10mm	427819	19mm		
427812	12mm	427821	21mm		
427813	13mm	427822	22mm		
427814	14mm	427824	24mm		
427815	15mm	427827	27mm		
427816	16mm	427830	30mm		
427817	17mm	427832	32mm		
427818	18mm				

5900 g 3 sets / 19.5 Kgs / 1.35 CUFT



(285W x 410D x 50H)



6-point: GS-435M2 also available

**MS-442B 42 Piece 1/2" Dr. Complete Bit Socket Set**

Item No.	Size	Item No.	Size
<b>1/2" Dr. Hex Bit Socket:</b>			
408+2135	5mm, 55mmL	447+2357	17mm, 80mmL
408+2136	6mm, 55mmL	449+2359	19mm, 80mmL
410+2147	7mm, 55mmL	408+2535	5mm, 110mmL
410+2148	8mm, 55mmL	408+2536	6mm, 110mmL
439+2149	9mm, 55mmL	410+2547	7mm, 110mmL
440+2150	10mm, 55mmL	410+2548	8mm, 110mmL
442+2152	12mm, 55mmL	440+2550	10mm, 110mmL
444+2354	14mm, 80mmL	442+2552	12mm, 110mmL
<b>1/2" Dr. Star Bit Socket:</b>			
408+6130	T-30, 55mmL	408+6530	T-30, 110mmL
408+6140	T-40, 55mmL	408+6540	T-40, 110mmL
410+6245	T-45, 55mmL	410+6545	T-45, 110mmL
410+6250	T-50, 55mmL	410+6550	T-50, 110mmL
440+6255	T-55, 55mmL	440+6555	T-55, 110mmL
442+6260	T-60, 60mmL	442+6560	T-60, 110mmL
444+6270	T-70, 60mmL	444+6570	T-70, 110mmL
<b>1/2" Dr. Triple Square Bit Socket:</b>			
408+8106	M6, 55mmL	449+8118	M18, 60mmL
410+8108	M8, 55mmL	410+8508	M8, 110mmL
440+8110	M10, 55mmL	440+8510	M10, 110mmL
442+8112	M12, 55mmL	442+8512	M12, 110mmL
444+8114	M14, 55mmL	444+8514	M14, 110mmL
446+8116	M16, 60mmL	446+8516	M16, 110mmL

Plastic Tray

5100 g

3 sets / 17 Kgs / 1.35 CUFT



(285W x 410D x 50H)

**MS-019 19 Piece Punch, Chisel & Hammer Set**

Item No.	Size	Item No.	Size
<b>Flat Chisel:</b>			
561206	6mm, 125mmL	562019	19mm, 200mmL
561410	10mm, 140mmL	562025	25mm, 200mmL
561614	14mm, 150mmL		
<b>Pin Punch:</b>			
565102	2mm, 100mmL	565165	5mm, 160mmL
565123	3mm, 125mmL	565206	6mm, 200mmL
565144	4mm, 140mmL	565208	8mm, 200mmL
<b>Taper Bit Extractor:</b>			
010603	3mm, 60mmL	010808	8mm, 80mmL
010705	5mm, 70mmL	010859	9mm, 85mmL
010756	6mm, 75mmL		

**Accessory:**

563110 4mm Center Punch, 110mmL

590216 Ball Peen Hammer, 1 lbs.

590348 Drilling Hammer, 2-1/2 lbs.

Plastic Tray

3900 g

3 sets / 13.5 Kgs / 1.35 CUFT



(285W x 410D x 50H)

## MS-121M 121 Piece 1/4" Dr. Metric Hand Socket & Bit Socket Set

Item No.	Size	Item No.	Size	Item No.	Size
<b>1/4" Dr. 6pt Hand Socket:</b>					
222504	4mm	222508	8mm	<b>Accessory:</b>	
2225045	4.5mm	222509	9mm	220002	Extension Bar, 50mmL
222505	5mm	222510	10mm	220004	Extension Bar, 100mmL
2225055	5.5mm	222511	11mm	220009B	Wobble Extension Bar, 225mmL
222506	6mm	222512	12mm	282150	Flexible Extension Bar, 150mmL
222507	7mm	222513	13mm	280070	Universal Joint
<b>1/4" Dr. 6pt Deep Hand Socket:</b>					
225205	5mm	225210	10mm	506+0175	Socket Driver
225206	6mm	225211	11mm	283508	1/4" Hex Shank Bit Holder
225207	7mm	225212	12mm	280030	Adapter, 1/4" F x 3/8" M
225208	8mm	225213	13mm	280231S	36T Quick Release Ratchet
<b>1/4" Dr. E-Star Hand Socket:</b>					
252504	E-4	252507	E-7	SB-111SP	11pcs Slotted & Philips Bit Set
252505	E-5	252508	E-8	SB-211MH	11pcs Metric Hex & Triple Square Bit Set
252506	E-6	252510	E-10	SB-711TP	11pcs Star Bit Set
<b>1/4" Dr. Star Bit Socket, 45mmL:</b>					
208+6108	T-8	208+6125	T-25	SB-811TP	11pcs Tamperproof Star Bit Set
208+6109	T-9	208+6127	T-27	HK-009MB	9pcs Metric Wobble Hex Key Wrenches 1.5, 2, 2.5, 3, 4, 5, 6, 8, 10mm
208+6110	T-10	208+6130	T-30	SK-010T	10pcs Tamperproof Star Key Wrenches T-9, 10, 15, 20, 25, 27, 30, 40, 45, 50
208+6115	T-15	208+6140	T-40	Plastic Tray	
208+6120	T-20				
<b>1/4" Dr. Head Hand Socket:</b>					
232803	3mm Hex	222640	0.8 x 4.0mm Slotted		
232804	4mm Hex	222655	1.0 x 5.5mm Slotted		
232805	5mm Hex	222665	1.2 x 6.5mm Slotted		
232806	6mm Hex	222601	#1 Philips		
232807	7mm Hex	222602	#2 Philips		
232808	8mm Hex	222603	#3 Philips		
232809	9mm Hex				
232810	10mm Hex				

2900 g      3 sets / 10.5 Kgs / 1.35 CUFT



(285W x 410D x 50H)



## MS-007P 7 Piece Pliers Set

Item No.	Description
551011D	Water Pump Pliers, 250mmL (10"L)
550814D	Bent Nose Pliers, 200mmL (8"L)
550804D	Chain Nose Pliers with Cutter, 200mmL (8"L)
550712D	Side Cutter Pliers, 180mmL (7"L)
550708D	Heavy Duty Diagonal Cutting Pliers, 180mmL (7"L)
530310A	Curved Jaw Locking Pliers with Cutter, 250mmL (10"L)
531306LN	Long Nose Locking Pliers with Cutter, 150mmL (6"L)

2500 g      3 sets / 9.3 Kgs / 1.35 CUFT



(285W x 410D x 50H)

**MS-057M 57 Piece 1/4" & 1/2" Dr. Swivel Socket & Bit Socket Set**

Item No.	Size	Item No.	Size	Item No.	Size
<b>1/4" Dr. 12pt Universal Hand Socket:</b>			<b>1/4" Dr. E-Star Hand Socket:</b>		
253506	6mm	253511	11mm	252504	E-4
253507	7mm	253512	12mm	252505	E-5
253508	8mm	253513	13mm	252506	E-6
253509	9mm	253514	14mm	252507	E-7
253510	10mm			252508	E-8
<b>1/2" Dr. E-Star Hand Socket:</b>				252510	E-10
454510	E-10	454518	E-18	252511	E-11
454511	E-11	454520	E-20	<b>Accessory:</b>	
454512	E-12	454522	E-22	281802P	1/4" Dr. 72T Rotor Ratchet
454514	E-14	454524	E-24	481804P	1/2" Dr. 72T Rotor Ratchet
454516	E-16				Plastic Tray
<b>1/2" Dr. 6pt Swivel Impact Socket (CR-V):</b>					
487911M	11mm	487917M	17mm		
487912M	12mm	487918M	18mm		
487913M	13mm	487919M	19mm		
487914M	14mm	487921M	21mm		
487915M	15mm	487922M	22mm		
487916M	16mm				
<b>1/2" Dr. Tamperproof Star Bit Socket, 80mmL:</b>					
408+7320	T-20	410+7345	T-45		
408+7325	T-25	410+7350	T-50		
408+7327	T-27	440+7355	T-55		
408+7330	T-30	442+7360	T-60		
408+7340	T-40	444+7370	T-70		
<b>1/2" Dr. Triple Square Bit Socket, 80mmL:</b>					
408+8304	M4	442+8312	M12		
408+8305	M5	444+8314	M14		
408+8306	M6	446+8316	M16		
410+8308	M8	449+8318	M18		
440+8310	M10				

6800 g 3 sets / 21.5 Kgs / 1.35 CUFT



(285W x 410D x 50H)



**MS-014A 14 Piece Combination Auto Repair Tool Set**

Item No.	Description
592801	Miniature Awl
592802	Miniature Hook
592803	Miniature Bent Tip 45°
592804	Miniature Bent Tip 90°
PK-OSP4	2pc O-Ring Oil Seal Picks(Double End), Hook & O-Ring 90° Tip, Bent Tip 90° & 45°
595212	12mm Carbon Scraper, 250mmL
595232	26mm Carbon Scraper, 300mmL
AT-TPR	Trim Pad Remover, 230mmL(9.1"L)
AT-BSP	Brake Spring Pliers, 330mmL(13"L)
AT-B16	Magnetic Pick-up Tool, 135 ~ 645mmL(5.3"~25.4"L)
AT-RM14	Hinged Mirror, 57mm Diameter
AT-HC10	Heater Hose Clamp Pliers
AT-HC12	Heater Hose Clamp Pliers

1800 g 3 sets / 7.2 Kgs / 1.35 CUFT



(285W x 410D x 50H)





## MS-071M 71 Piece 3/8" Dr. Metric Hand Socket & Bit Socket Set

Item No.	Size	Item No.	Size	Item No.	Size
<b>3/8" Dr. 6pt Hand Socket:</b>			<b>3/8" Dr. Accessory:</b>		
323208	8mm	323214	14mm	320075	Extension Bar, 75mmL
323209	9mm	323215	15mm	320150	Extension Bar, 150mmL
323210	10mm	323216	16mm	320200	Extension Bar, 200mmL
323211	11mm	323217	17mm	320002B	Wobble Extension Bar, 45mmL
323212	12mm	323218	18mm	320040	Adapter, 3/8" F x 1/2" M
323213	13mm	323219	19mm	380070	Universal Joint
<b>3/8" Dr. 12pt Deep Hand Socket:</b>					
336308	8mm	336314	14mm	326016	16.0mm Spark Plug Socket
336309	9mm	336315	15mm	326021	20.6mm Spark Plug Socket
336310	10mm	336316	16mm	380331S	36T Quick Release Ratchet
336311	11mm	336317	17mm	380371	1/4" & 3/8" Dr. Double Drive Ratchet
336312	12mm	336318	18mm		Plastic Tray
336313	13mm	336319	19mm		
<b>3/8" Dr. E-Star Hand Socket:</b>					
353510	E-10	353514	E-14		
353511	E-11	353516	E-16		
353512	E-12	353518	E-18		
<b>3/8" Dr. Bit Socket, 50mmL:</b>					
308+1140	0.6 x 4.0mm	308+8105	M5 Triple Square		
308+1150	0.8 x 5.0mm	308+8106	M6 Triple Square		
308+1160	1.0 x 6.0mm	308+8108	M8 Triple Square		
310+1280	1.2 x 8.0mm	308+8110	M10 Triple Square		
308+1101	#1 Philips	308+8112	M12 Triple Square		
308+1102	#2 Philips	308+6110	T-10 Star		
308+1103	#3 Philips	308+6115	T-15 Star		
308+2133	3mm Hex	308+6120	T-20 Star		
308+2134	4mm Hex	308+6125	T-25 Star		
308+2135	5mm Hex	308+6127	T-27 Star		
308+2136	6mm Hex	308+6130	T-30 Star		
310+2147	7mm Hex	308+6140	T-40 Star		
310+2148	8mm Hex	310+6245	T-45 Star		
339+2149	9mm Hex	310+6250	T-50 Star		
340+2150	10mm Hex	340+6255	T-55 Star		
342+2152	12mm Hex				



(285W x 410D x 50H)



4700 g 3 sets / 16 Kgs / 1.35 CUFT

## MS-008R 8 Piece Retaining Ring Plier & Oil Filter Wrench Set

Item No.	Description
550750	Straight Nose, External Retaining Ring Pliers (7")
550751	Straight Nose, Internal Retaining Ring Pliers (7")
550752	90° Bent Nose, External Retaining Ring Pliers (7")
550753	90° Bent Nose, Internal Retaining Ring Pliers (7")
AT-BOF2	Swivel Handle Oil Filter Wrench, 60~73mm(2-3/8~2-7/8")
AT-BOF3	Swivel Handle Oil Filter Wrench, 73~85mm(2-7/8 ~ 3-3/8")
AT-BOF4	Swivel Handle Oil Filter Wrench, 85~95mm(3-3/8 ~ 3-3/4")
AT-OF12	Oil Filter Pliers, 50 ~ 115mm(2" ~ 4-1/2")
Plastic Tray	

2100 g 3 sets / 8.1 Kgs / 1.35 CUFT



(285W x 410D x 50H)

## MS-048MS 48 Piece Hex, Star, Triple Square & Square Bit Set

Item No.	Size	Item No.	Size
<b>Screwdriver Bit, 160mmL:</b>			
2733	3mm Hex	5718	9/32" Wobble Hex
2734	4mm Hex	5720	5/16" Wobble Hex
2735	5mm Hex	7707	T-7 Tamperproof Star
2736	6mm Hex	7708	T-8 Tamperproof Star
2747	7mm Hex	7709	T-9 Tamperproof Star
2748	8mm Hex	7710	T-10 Tamperproof Star
3708	1/8" Hex	7715	T-15 Tamperproof Star
3710	5/32" Hex	7720	T-20 Tamperproof Star
3712	3/16" Hex	7725	T-25 Tamperproof Star
3714	7/32" Hex	7727	T-27 Tamperproof Star
3716	1/4" Hex	7730	T-30 Tamperproof Star
3718	9/32" Hex	7740	T-40 Tamperproof Star
3720	5/16" Hex	7745	T-45 Tamperproof Star
4733	3mm Wobble Hex	7750	T-50 Tamperproof Star
4734	4mm Wobble Hex	9700	S#0 Square
4735	5mm Wobble Hex	9701	S#1 Square
4736	6mm Wobble Hex	9702	S#2 Square
4747	7mm Wobble Hex	9703	S#3 Square
4748	8mm Wobble Hex	9704	S#4 Square
5708	1/8" Wobble Hex	8704	M4 Triple Square
5710	5/32" Wobble Hex	8705	M5 Triple Square
5712	3/16" Wobble Hex	8706	M6 Triple Square
5714	7/32" Wobble Hex	8708	M8 Triple Square
5716	1/4" Wobble Hex		

**Accessory:**

280120 1/4" & 5/16" Hex Shank OMNIDRIVE 3in1 Handgrip  
Plastic Tray

2650 g 3 sets / 9 Kgs / 1.35 CUFT

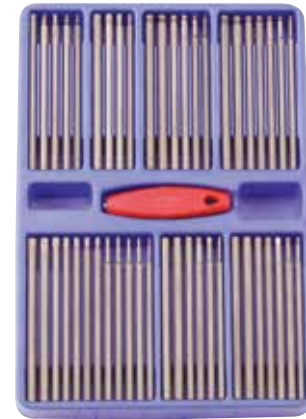

(285W x 410D x 50H)



## MS-013T 13 Piece Star Screwdriver Set

Item No.	Size	Item No.	Size
<b>Star Screwdriver w/Rubber Handle:</b>			
504+6606	T-6, 150mmL	506+6725	T-25, 185mmL
504+6607	T-7, 150mmL	506+6827	T-27, 225mmL
504+6608	T-8, 150mmL	506+6830	T-30, 225mmL
504+6609	T-9, 150mmL	508+6840	T-40, 235mmL
506+6710	T-10, 185mmL	508+6845	T-45, 235mmL
506+6715	T-15, 185mmL	508+6850	T-50, 235mmL
506+6720	T-20, 185mmL		Plastic Tray

1500 g 3 sets / 6.3 Kgs / 1.35 CUFT



(285W x 410D x 50H)



## MS-014 14 Piece Slotted, Philips & Posidriv Screwdriver Set

Item No.	Size	Item No.	Size
<b>Screwdriver w/Rubber Handle:</b>			
502+1465	1.2 x 6.5mm, 98mmL	508+1992	2.0 x 12.0mm, 320mmL
508+0890	1.6 x 10.0mm, 370mmL	508+1994	2.5 x 14.0mm, 370mmL
502+1201	#1 Philips, 98mmL	508+1913	#3 Philips, 245mmL
502+1202	#2 Philips, 98mmL	508+0833	#3 Philips, 390mmL
506+1902	#2 Philips, 300mmL	508+1924	#4 Philips, 320mmL
502+0501	#1 Posidriv, 98mmL	508+1943	#3 Posidriv, 295mmL
502+0502	#2 Posidriv, 98mmL	508+1974	#4 Posidriv, 340mmL
Plastic Tray			

2700 g 3 sets / 9.5 Kgs / 1.35 CUFT



(285W x 410D x 50H)



## MS-013 13 Piece Tang-Thru Screwdriver, Pry Bar & Carbon Scraper Set

Item No.	Size	Item No.	Size
<b>Tang-Thru Screwdriver w/Rubber Handle:</b>			
509+1966	1.2 x 6.5mm, 245mmL	509+1951	#1 Posidriv, 220mmL
509+1994	2.5 x 14.0mm, 365mmL	509+1952	#2 Posidriv, 245mmL
509+1801	#1 Philips, 220mmL	509+1943	#3 Posidriv, 270mmL
509+1924	#4 Philips, 305mmL	509+1974	#4 Posidriv, 320mmL
<b>Rigid Carbon Scraper w/Plastic Handle:</b>			
595212	12mm, 250mmL	595232	26mm, 300mmL
595226	26mm, 200mmL		
<b>Pry Bar w/Plastic Handle:</b>			
560008	200mmL(8"L)	560012	300mmL(12"L)
Plastic Tray			

2950 g 3 sets / 10 Kgs / 1.35 CUFT



(285W x 410D x 50H)



## MS-013SP 13 Piece Slotted & Philips Screwdriver Set

Item No.	Size	Item No.	Size
<b>Screwdriver w/Rubber Handle:</b>			
504+0430	0.5 x 3.0mm, 155mmL	506+0680	1.2 x 8.0mm, 300mmL
504+1240	0.8 x 4.0mm, 180mmL	504+0400	#0 Philips, 155mmL
504+0550	0.8 x 5.0mm, 330mmL	504+1401	#1 Philips, 170mmL
506+0560	1.0 x 6.0mm, 250mmL	502+1202	#2 Philips, 98mmL
502+1465	1.2 x 6.5mm, 98mmL	506+1712	#2 Philips, 200mmL
506+1966	1.2 x 6.5mm, 200mmL	508+1843	#3 Philips, 270mmL
<b>Pry Bar w/Plastic Handle:</b>			
560012	300mmL(12"L)		Plastic Tray

1500 g 3 sets / 6.3 Kgs / 1.35 CUFT



(285W x 410D x 50H)



## MS-025R 25 Piece Hex Screwdriver & Ratcheting Screwdriver Set

Item No.	Size	Item No.	Size
<b>Hex Screwdriver w/Rubber Handle:</b>			
504+2622	2mm, 150mmL	506+2735	5mm, 185mmL
504+2625	2.5mm, 150mmL	506+2736	6mm, 185mmL
504+2633	3mm, 150mmL	508+2847	7mm, 235mmL
506+2634	4mm, 170mmL	508+2848	8mm, 235mmL

### 1/4" Hex Shank Hex Nut Driver. 140mmL:

0444	4mm Hex	0459	9mm Hex
0445	5mm Hex	0460	10mm Hex
0455	5.5mm Hex	0461	11mm Hex
0456	6mm Hex	0462	12mm Hex
0457	7mm Hex	0463	13mm Hex
0458	8mm Hex		

### Accessory:

285708M	1/4" Hex Dr. 1/4" Hex Shank Magnetic Bit Holder Adapter w/Quick Release
0260	1/4" Hex Dr. 1/4" Hex Shank Flexible Bit Holder
280002B	1/4" Hex Dr. 1/4" Hex Shank Socket Holder Adapter
272065	1/4" Hex Dr. 1/4" Hex Shank Spinner Handle
524+2983	1/4" Hex Shank Standard Ratcheting Screwdriver
520+2983	1/4" Hex Shank T-Handle Ratcheting Screwdriver

Plastic Tray

2000 g 3 sets / 7.8 Kgs / 1.35 CUFT



(285W x 410D x 50H)



**MS-035M 35 Piece Metric Flare Nut & L-Shaped Key Wrench Set**

Item No.	Size	Item No.	Size
<b>1/2" Dr. Stud Remover Socket:</b>			
426306	6mm	427410	10mm
426308	8mm	427412	12mm
<b>Flare Nut Wrench (Mirror Finish):</b>			
740911	9 x 11mm	741517	15 x 17mm
741012	10 x 12mm	741618	16 x 18mm
741314	13 x 14mm	741921	19 x 21mm
<b>Long Hex Key Wrench:</b>			
571760L	6mm	572512L	12mm
571870L	7mm	572613L	13mm
572080L	8mm	572814L	14mm
572190L	9mm	572916L	16mm
572210L	10mm	573117L	17mm
572411L	11mm	573219L	19mm
<b>Triple Square Key Wrench:</b>			
582705M	M5	583112M	M12
582806M	M6	583214M	M14
582908M	M8	583416M	M16
583010M	M10		
<b>Screw Extractor:</b>			
AT-EX6	6pc Screw Extractors: #1, 2, 3, 4, 5, 6		
Plastic Tray			

7050 g      3 sets / 22.5 Kgs / 1.35 CUFT



(285W x 410D x 50H)



**MS-028S 28 Piece SAE Flare Nut, E-Star, & L-Shaped Key Wrench Set**

Item No.	Size	Item No.	Size
<b>1/2" Dr. Stud Remover Socket:</b>			
486308	1/4"	487412	3/8"
486310	5/16"	487414	7/16"
<b>Flare Nut Wrench (Mirror Finish):</b>			
760810	1/4 x 5/16"	762022	5/8 x 11/16"
761214	3/8 x 7/16"	762428	3/4 x 7/8"
761618	1/2 x 9/16"		
<b>Long Hex Key Wrench:</b>			
591816L	1/4"	592632L	1/2"
592020L	5/16"	592836L	9/16"
592324L	3/8"	593040L	5/8"
592428L	7/16"	593248L	3/4"
<b>E-Star Wrench (Mirror Finish):</b>			
790608	E-6 x E-8	791418	E-14 x E-18
791012	E-10 x E-12	792024	E-20 x E-24
<b>Offset Screwdrivers:</b>			
560610	1.0 x 6.0mm Slotted	570012	#1 x #2 Philips
560812	1.2 x 8.0mm Slotted	570034	#3 x #4 Philips
560916	1.6 x 9.0mm Slotted		

**Accessory:**  
 AT-PU33 Pick-up Tool, 330~685mmL(13~27"L)  
 AT-RM15 Hinged Mirror, 50x90mm  
 Plastic Tray

5650 g      3 sets / 18 Kgs / 1.35 CUFT

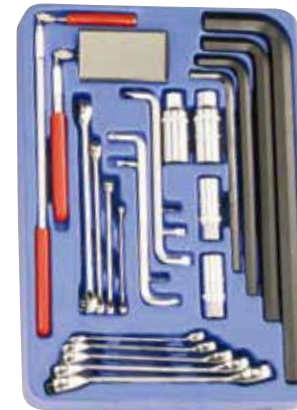

(285W x 410D x 50H)



## MS-020M 20 Piece Metric Combination Wrench Set - Mirror Finish

Item No.	Size	Item No.	Size
<b>Combination Wrench (Mirror Finish):</b>			
748206	6mm	748216	16mm
748207	7mm	748217	17mm
748208	8mm	748218	18mm
748209	9mm	748219	19mm
748210	10mm	748221	21mm
748211	11mm	748222	22mm
748212	12mm	748224	24mm
748213	13mm	748227	27mm
748214	14mm	748230	30mm
748215	15mm	748232	32mm

Plastic Tray

4800 g 3 sets / 16.5 Kgs / 1.35 CUFT



(285W x 410D x 50H)

## MS-024M 24 Piece Metric Combination & Offset Box End Wrench Set

Item No.	Size	Item No.	Size
<b>Combination Wrench (Mirror Finish):</b>			
748206	6mm	748214	14mm
748207	7mm	748215	15mm
748208	8mm	748216	16mm
748209	9mm	748217	17mm
748210	10mm	748218	18mm
748211	11mm	748219	19mm
748212	12mm	748221	21mm
748213	13mm	748222	22mm

**Offset Box End Wrench (Mirror Finish):**

740607	6 x 7mm	741415	14 x 15mm
740809	8 x 9mm	741617	16 x 17mm
741011	10 x 11mm	741819	18 x 19mm
741213	12 x 13mm	742022	20 x 22mm

Plastic Tray

3600 g 3 sets / 12.5 Kgs / 1.35 CUFT



(285W x 410D x 50H)

## MS-020B 20 Piece Metric Offset Box End, Open End & E-Star Wrench Set

Item No.	Size	Item No.	Size
<b>Offset Box End Wrench (Mirror Finish):</b>			
740607	6 x 7mm	741415	14 x 15mm
740809	8 x 9mm	741617	16 x 17mm
741011	10 x 11mm	741819	18 x 19mm
741213	12 x 13mm	742022	20 x 22mm
<b>Open End Wrench (Matt Finish):</b>			
790607	6 x 7mm	791415	14 x 15mm
790809	8 x 9mm	791617	16 x 17mm
791011	10 x 11mm	791819	18 x 19mm
791213	12 x 13mm	792022	20 x 22mm
<b>E-Star Wrench (Mirror Finish):</b>			
790608	E-6 x E-8	791418	E-14 x E-18
791012	E-10 x E-12	792024	E-20 x E-24

Plastic Tray

2700 g 3 sets / 9 Kgs / 1.35 CUFT



(285W x 410D x 50H)

## TL-518 18 Piece Slotted & Philips Screwdriver Set

Item No.	Size
<b>Screwdriver w/Plastic Handle:</b>	
593+1250	0.8 x 5.0mm Slotted, 345mmL
591+1465	1.2 x 6.5mm Slotted, 86mmL
593+1965	1.2 x 6.5mm Slotted, 195mmL
594+1990	1.6 x 10.0mm Slotted, 310mmL
594+1991	1.2 x 6.5mm Slotted, 360mmL
591+1201	#1 Philips, 86mmL
593+1401	#1 Philips, 170mmL
593+1431	#1 Philips, 345mmL
593+1602	#2 Philips, 140mmL
593+1902	#2 Philips, 295mmL
593+1932	#2 Philips, 395mmL
594+1923	#3 Philips, 310mmL
<b>Micro-Tech Screwdriver:</b>	
5602070	0.4 x 2.0mm Slotted, 122mmL
5602570	0.4 x 2.5mm Slotted, 122mmL
5603070	0.5 x 3.0mm Slotted, 122mmL
570071	#000 Philips, 122mmL
570072	#00 Philips, 122mmL
570073	#0 Philips, 122mmL
Plastic Tray	
2400 g	5 sets / 13 Kgs / 1.58 CUFT



(384W x 406D)

## CP-5312 12 Piece Locking Pliers Set

Item No.	Description
551011D	Water Pump Pliers, 250mmL(10"L)
550808D	Heavy Duty Diagonal Cutting Pliers, 200mmL(8"L)
550804D	Chain Nose Pliers with Cutter, 200mmL(8"L)
530305A	Curved Jaw Locking Pliers with Cutter, 125mmL(5"L)
530307A	Curved Jaw Locking Pliers with Cutter, 175mmL(7"L)
530310A	Curved Jaw Locking Pliers with Cutter, 250mmL(10"L)
531306LN	Long Nose Locking Pliers with Cutter, 150mmL(6"L)
531309LN	Long Nose Locking Pliers with Cutter, 225mmL(9"L)
530307RA	Straight Jaw Locking Pliers, 175mmL(7"L)
530310RA	Straight Jaw Locking Pliers, 250mmL(10"L)
530306AR	Locking "C" Clamp, 150mmL(6"L)
530311AR	Locking "C" Clamp, 275mmL(11"L)
Plastic Tray	
5400 g	5 sets / 28 Kgs / 1.58 CUFT



(384W x 406D)

## MS-106M 106 Piece 3/8" Dr. Metric Tool Set

Item No.	Size	Item No.	Size	Item No.	Size	Item No.	Size
<b>3/8" Dr. 12pt Hand Socket:</b>				<b>3/8" Dr. Bit Socket, 50mmL:</b>			
333206	6mm	333215	15mm	308+1140	0.6 x 4.0mm	308+1101	#1 Philips
333207	7mm	333216	16mm	308+1150	0.8 x 5.0mm	308+1102	#2 Philips
333208	8mm	333217	17mm	308+1160	1.0 x 6.0mm	308+1103	#3 Philips
333209	9mm	333218	18mm	310+1280	1.2 x 8.0mm	310+1124	#4 Philips
333210	10mm	333219	19mm	310+1290	1.6 x 9.0mm	308+6110	T-10 Star
333211	11mm	333220	20mm	308+2133	3mm Hex	308+6115	T-15 Star
333212	12mm	333221	21mm	308+2134	4mm Hex	308+6120	T-20 Star
333213	13mm	333222	22mm	308+2135	5mm Hex	308+6125	T-25 Star
333214	14mm			308+2136	6mm Hex	308+6127	T-27 Star
<b>3/8" Dr. 6pt Impact Socket (CR-Mo):</b>				<b>3/8" Dr. Bit Socket, 140mmL:</b>			
343207	7mm	343215	15mm	310+2147	7mm Hex	310+2648	8mm Hex
343208	8mm	343216	16mm	310+2148	8mm Hex	339+2649	9mm Hex
343209	9mm	343217	17mm	339+2149	9mm Hex	340+2650	10mm Hex
343210	10mm	343218	18mm	340+2150	10mm Hex	341+2651	11mm Hex
343211	11mm	343219	19mm	341+2151	11mm Hex	342+2652	12mm Hex
343212	12mm	343220	20mm	342+2152	12mm Hex		
343213	13mm	343221	21mm				
343214	14mm	343222	22mm				
<b>3/8" Dr. 6pt Deep Hand Socket:</b>				<b>Accessory:</b>			
326306	6mm	326315	15mm	320050	Extension Bar, 50mmL		
326307	7mm	326316	16mm	320150	Extension Bar, 150mmL		
326308	8mm	326317	17mm	320020	Adapter, 3/8" F x 1/4" M		
326309	9mm	326318	18mm	320040	Adapter, 3/8" F x 1/2" M		
326310	10mm	326319	19mm	380070	Universal Joint		
326311	11mm	326320	20mm	380030	Sliding T-Handle		
326312	12mm	326321	21mm	380331S	36T Quick Release Ratchet		
326313	13mm	326322	22mm		Plastic Tray		
326314	14mm						
<b>3/8" Dr. 12pt Universal Hand Socket:</b>							
355610	10mm	355615	15mm				
355611	11mm	355616	16mm				
355612	12mm	355617	17mm				
355613	13mm	355618	18mm				
355614	14mm	355619	19mm				

7600 g

2 sets / 17 Kgs / 1.76 CUFT

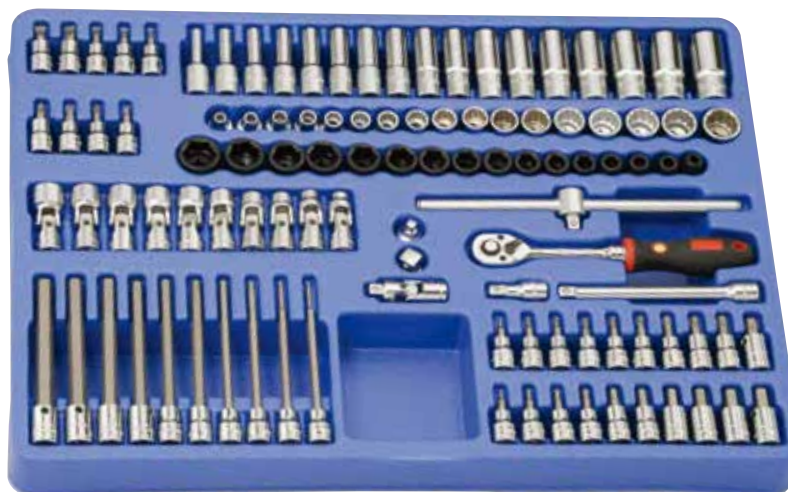

(570W x 410D x 50H)

**MS-090S 90 Piece 3/8" Dr. SAE Tool Set**

Item No.	Size	Item No.	Size	Item No.	Size	Item No.	Size
<b>3/8" Dr. 12pt Hand Socket:</b>				<b>3/8" Dr. Bit Socket, 50mmL:</b>			
373208	1/4"	373219	19/32"	308+3108	1/8" Hex	308+8104	M4 Triple Square
373210	5/16"	373220	5/8"	308+3110	5/32" Hex	308+8105	M5 Triple Square
373211	11/32"	373222	11/16"	308+3112	3/16" Hex	308+8106	M6 Triple Square
373212	3/8"	373224	3/4"	308+3114	7/32" Hex	310+8108	M8 Triple Square
373214	7/16"	373225	25/32"	308+3116	1/4" Hex	340+8110	M10 Triple Square
373216	1/2"	373226	13/16"	310+3128	9/32" Hex	342+8112	M12 Triple Square
373218	9/16"	373228	7/8"	310+3130	5/16" Hex	344+8114	M14 Triple Square
<b>3/8" Dr. 6pt Deep Hand Socket:</b>				<b>3/8" Dr. Bit Socket, 140mmL:</b>			
386308	1/4"	386319	19/32"	312+3134	3/8" Hex	308+7610	T-10 Tamperproof Sar
386310	5/16"	386320	5/8"	314+3138	7/16" Hex	308+7615	T-15 Tamperproof Sar
386311	11/32"	386322	11/16"	316+3142	1/2" Hex	308+7620	T-20 Tamperproof Sar
386312	3/8"	386324	3/4"	308+3608	1/8" Hex	308+7625	T-25 Tamperproof Sar
386314	7/16"	386325	25/32"	308+3610	5/32" Hex	308+7627	T-27 Tamperproof Sar
386316	1/2"	386326	13/16"	308+3612	3/16" Hex	308+7630	T-30 Tamperproof Sar
386318	9/16"	386328	7/8"	308+3614	7/32" Hex	308+7640	T-40 Tamperproof Sar
<b>3/8" Dr. 6pt Deep Impact Socket (CR-Mo):</b>				<b>Accessory:</b>			
366310	5/16"	366320	5/8"	308+3616	1/4" Hex	310+7645	T-45 Tamperproof Sar
366311	11/32"	366322	11/16"	310+3618	9/32" Hex	310+7650	T-50 Tamperproof Sar
366312	3/8"	366324	3/4"	310+3620	5/16" Hex	340+7655	T-55 Tamperproof Sar
366314	7/16"	366325	25/32"	312+3624	3/8" Hex		
366316	1/2"	366326	13/16"	314+3628	7/16" Hex		
366318	9/16"	366328	7/8"	316+3632	1/2" Hex		
366319	19/32"						
<b>3/8" Dr. 12pt Universal Hand Socket:</b>				320075	Extension Bar, 3"L		
365612	3/8"	365620	5/8"	320200	Extension Bar, 8 "L		
365614	7/16"	365622	11/16"	380336P	Hinge Handle		
365616	1/2"	365624	3/4"	381803P	72T Rotor Ratchet		
365618	9/16"			380372S	72T Reversible Ratchet		
					Plastic Tray		

8300 g

2 sets / 19 Kgs / 1.76 CUFT



(570W x 410D x 50H)





## MS-098M 98 Piece 1/4" & 1/2" Dr. Metric Tool Set

Item No.	Size	Item No.	Size	Item No.	Size	Item No.	Size
<b>1/4" Dr. 6pt Hand Socket:</b>				<b>1/2" Dr. 6pt Deep Impact Socket (CR-Mo):</b>			
222505	5mm	222510	10mm	447817	17mm	447821	21mm
2225055	5.5mm	222511	11mm	447819	19mm		
222506	6mm	222512	12mm	<b>1/2" Dr. Bit Socket, 80mmL:</b>			
222507	7mm	222513	13mm	408+2336	6mm Hex	408+6340	T-40 Star
222508	8mm	222514	14mm	410+2348	8mm Hex	410+6345	T-45 Star
222509	9mm			440+2350	10mm Hex	410+6350	T-50 Star
<b>1/4" Dr. 6pt Deep Hand Socket:</b>				442+2352	12mm Hex	440+6355	T-55 Star
225204	4mm	225209	9mm	<b>Offset Box End Wrench (Mirror Finish):</b>			
225205	5mm	225210	10mm	740607	6 x 7mm	741415	14 x 15mm
2252055	5.5mm	225211	11mm	740809	8 x 9mm	741617	16 x 17mm
225206	6mm	225212	12mm	741011	10 x 11mm	741819	18 x 19mm
225207	7mm	225213	13mm	741213	12 x 13mm		
225208	8mm	225214	14mm	<b>Open End Wrench (Matt Finish):</b>			
<b>1/4" Dr. Bit Socket, 45mmL:</b>				790607	6 x 7mm	791415	14 x 15mm
208+2133	3mm Hex	208+6120	T-20 Star	790809	8 x 9mm	791617	16 x 17mm
208+2134	4mm Hex	208+6125	T-25 Star	791011	10 x 11mm	791819	18 x 19mm
208+2135	5mm Hex	208+6130	T-30 Star	791213	12 x 13mm		
<b>1/2" Dr. 12pt Hand Socket:</b>				<b>Accessory:</b>			
433808	8mm	433818	18mm	220002	1/4" Dr. Extension Bar, 50mmL		
433810	10mm	433819	19mm	220004	1/4" Dr. Extension Bar, 100mmL		
433811	11mm	433821	21mm	220006	1/4" Dr. Extension Bar, 150mmL		
433812	12mm	433822	22mm	280070	1/4" Dr. Universal Joint		
433813	13mm	433823	23mm	280020	1/4" Dr. Sliding T-Handle		
433814	14mm	433824	24mm	280231S	1/4" Dr. 36T Quick Release Ratchet		
433815	15mm	433827	27mm	506+0175	1/4" Dr. Socket Driver		
433816	16mm	433830	30mm	424125	1/2" Dr. Extension Bar, 125mmL		
433817	17mm	433832	32mm	424250	1/2" Dr. Extension Bar, 250mmL		
<b>1/2" Dr. 6pt Impact Socket (CR-Mo):</b>				480070	1/2" Dr. Universal Joint		
444010	10mm	444017	17mm	480040	1/2" Dr. Sliding T-Handle		
444011	11mm	444018	18mm	480431S	1/2" Dr. 36T Quick Release Ratchet		
444012	12mm	444019	19mm	Plastic Tray			
444013	13mm	444021	21mm	9800 g	2 sets / 22 Kgs / 1.76 CUFT		
444014	14mm	444022	22mm				
444015	15mm	444023	23mm				
444016	16mm	444024	24mm				



(570W x 410D x 50H)

**MS-100S 100 Piece 1/4" & 1/2" Dr. SAE Tool Set**

Item No.	Size	Item No.	Size	Item No.	Size	Item No.	Size
<b>1/4" Dr. 6pt Hand Socket:</b>				<b>1/2" Dr. 12pt Deep Hand Socket:</b>			
282506	3/16"	282511	11/32"	487816	1/2"	487826	13/16"
282507	7/32"	282512	3/8"	487818	9/16"	487828	7/8"
282508	1/4"	282514	7/16"	487820	5/8"	487830	15/16"
282509	9/32"	282516	1/2"	487822	11/16"	487832	1"
282510	5/16"	282518	9/16"	487824	3/4"		
<b>1/4" Dr. 6pnt Deep Hand Socket:</b>				<b>1/2" Dr. 6pt Impact Socket (CR-Mo):</b>			
285206	3/16"	285211	11/32"	464012	3/8"	464024	3/4"
285207	7/32"	285212	3/8"	464014	7/16"	464025	25/32"
285208	1/4"	285214	7/16"	464016	1/2"	464026	13/16"
285209	9/32"	285216	1/2"	464018	9/16"	464028	7/8"
285210	5/16"	285218	9/16"	464019	19/32"	464030	15/16"
<b>1/4" Dr. Hex Bit Socket, 45mmL:</b>				<b>1/2" Dr. 6pt Deep Impact Socket (CR-Mo):</b>			
208+3108	1/8" Hex	208+3112	3/16" Hex	464022	11/16"		
208+3110	5/32" Hex	208+3114	7/32" Hex	467824	3/4"	467828	7/8"
<b>1/4" Dr. 12pt Universal Hand Socket:</b>				<b>Offset Box End Wrench (Mirror Finish):</b>			
263708	1/4"	263714	7/16"	750810	1/4 x 5/16"	752022	5/8 x 11/16"
263710	5/16"	263716	1/2"	751214	3/8 x 7/16"	752426	3/4 x 13/16"
263712	3/8"	263718	9/16"	751618	1/2 x 9/16"	752830	7/8 x 15/16"
<b>1/2" Dr. Bit Socket, 80mmL:</b>				<b>Open End Wrench (Matt Finish):</b>			
408+3316	1/4" Hex	414+3328	7/16" Hex	770810	1/4 x 5/16"	772022	5/8 x 11/16"
410+3320	5/16" Hex	416+3332	1/2" Hex	771214	3/8 x 7/16"	772428	3/4 x 7/8"
412+3324	3/8" Hex			771618	1/2 x 9/16"		
<b>1/2" Dr. 12pt Hand Socket:</b>				<b>Accessory:</b>			
473810	5/16"	473825	25/32"	427016	1/2" Dr. 5/8" Spark Plug Socket		
473812	3/8"	473826	13/16"	427021	1/2" Dr. 13/16" Spark Plug Socket		
473814	7/16"	473828	7/8"	HK-009SB	9pc SAE Wobble Hex Key Wrenches		
473816	1/2"	473830	15/16"		1/16, 5/64, 3/32, 1/8, 5/32,		
473818	9/16"	473832	1"		3/16, 1/4, 5/16, 3/8"		
473819	19/32"	473834	1-1/16"		Plastic Tray		
473820	5/8"	473836	1-1/8"		10.3 Kg		
473822	11/16"	473838	1-3/16"		2 sets / 23 Kgs / 1.76 CUFT		
473824	3/4"	473840	1-1/4"				



(570W x 410D x 50H)



## MS-023 23 Piece Punch, Chisel & Hammer Set

Item No.	Size	Item No.	Size
<b>Flat Chisel:</b>			
561206	6mm, 125mmL	561614	14mm, 150mmL
561410	10mm, 140mmL	561616	16mm, 160mmL
561612	12mm, 150mmL		
<b>Pin Punch:</b>			
565102	2mm, 100mmL	565165	5mm, 160mmL
565123	3mm, 125mmL	565166	6mm, 160mmL
565144	4mm, 140mmL		
<b>Center Punch:</b>			
563100	3mm, 100mmL	563125	5mm, 125mmL
<b>Long Taper Line Up Punch:</b>			
564203	3mm, 200mmL	564255	5mm, 250mmL
<b>Tang-Thru Screwdriver w/Rubber Handle:</b>			
509+1990	1.2 x 10.0mm, 305mmL		
509+1992	2.0 x 12.0mm, 315mmL		
509+1812	#2 Philips, 245mmL		
509+1843	#3 Philips, 255mmL		

Item No.	Size
<b>Hammer &amp; Close Quarter Bar:</b>	
590116	Claw Hammer, 1 lbs.
590216	Ball Peen Hammer, 1 lbs.
590348	Drilling Hammer, 2-1/2 lbs.
590416	Soft Face Hammer, 1 lbs.
015618	Close Quarter Bar, 460mmL
Plastic Tray	
⚖️ 6700 g	📦 2 sets / 15 Kgs / 1.76 CUFT



(570W x 410D x 50H)

## MS-044M 44 Piece Metric Complete Wrench Set

Item No.	Size	Item No.	Size
<b>Combination Wrench (Mirror Finish):</b>			
748206	6mm	748219	19mm
748207	7mm	748220	20mm
748208	8mm	748221	21mm
748209	9mm	748222	22mm
748210	10mm	748223	23mm
748211	11mm	748224	24mm
748212	12mm	748225	25mm
748213	13mm	748226	26mm
748214	14mm	748227	27mm
748215	15mm	748228	28mm
748216	16mm	748229	29mm
748217	17mm	748230	30mm
748218	18mm	748232	32mm
<b>Extra Long Box End Wrench (Mirror Finish):</b>			
780810L	8 x 10mm	781417L	14 x 17mm
781012L	10 x 12mm	781618L	16 x 18mm
781214L	12 x 14mm	781719L	17 x 19mm
781315L	13 x 15mm	782224L	22 x 24mm

Item No.	Size	Item No.	Size
<b>Stubby Ratcheting Wrench (Mirror Finish):</b>			
760210	10mm	760215	15mm
760211	11mm	760216	16mm
760212	12mm	760217	17mm
760213	13mm	760218	18mm
760214	14mm	760219	19mm
Plastic Tray			
⚖️ 10.7 Kg	📦 2 sets / 23 Kgs / 1.76 CUFT		



(570W x 410D x 50H)

**MS-041MS 41 Piece Metric & SAE Combination & Flare Nut Wrench Set**

Item No.	Size	Item No.	Size
<b>Combination Wrench (Mirror Finish):</b>			
748206	6mm	748222	22mm
748207	7mm	748223	23mm
748208	8mm	748224	24mm
748209	9mm	759208	1/4"
748210	10mm	759210	5/16"
748211	11mm	759212	3/8"
748212	12mm	759214	7/16"
748213	13mm	759216	1/2"
748214	14mm	759218	9/16"
748215	15mm	759220	5/8"
748216	16mm	759222	11/16"
748217	17mm	759224	3/4"
748218	18mm	759226	13/16"
748219	19mm	759228	7/8"
748221	21mm	759230	15/16"

Item No.	Size	Item No.	Size
<b>Flare Nut Wrench (Mirror Finish):</b>			
740911	9 x 11mm	760810	1/4 x 5/16"
741012	10 x 12mm	761214	3/8 x 7/16"
741314	13 x 14mm	761618	1/2 x 9/16"
741517	15 x 17mm	762022	5/8 x 11/16"
741618	16 x 18mm	762428	3/4 x 7/8"
741921	19 x 21mm		

Plastic Tray

6500 g

2 sets / 15 Kgs / 1.76 CUFT



(570W x 410D x 50H)

**MS-035S 35 Piece SAE Complete Wrench Set**

Item No.	Size	Item No.	Size
<b>Combination Wrench (Mirror Finish):</b>			
759208	1/4"	759224	3/4"
759210	5/16"	759226	13/16"
759212	3/8"	759228	7/8"
759214	7/16"	759230	15/16"
759216	1/2"	759232	1"
759218	9/16"	759234	1-1/16"
759220	5/8"	759236	1-1/8"
759222	11/16"	759240	1-1/4"

Item No.	Size	Item No.	Size
<b>Stubby Ratcheting Wrench (Mirror Finish):</b>			
770212	3/8"	770220	5/8"
770214	7/16"	770222	11/16"
770216	1/2"	770224	3/4"
770218	9/16"		

Plastic Tray

7400 g

2 sets / 17 Kgs / 1.76 CUFT



(570W x 410D x 50H)

**Extra Long Box End Wrench (Mirror Finish):**

791012L	5/16 x 3/8"	791820L	9/16 x 5/8"
791416L	7/16 x 1/2"	792224L	11/16 x 3/4"

**Combination Ratcheting Wrench (Mirror Finish):**

778510	5/16"	778518	9/16"
778512	3/8"	778520	5/8"
778514	7/16"	778522	11/16"
778516	1/2"	778524	3/4"

## MS-086 86 Piece Screwdriver & Bit Set

Item No.	Description
<b>Screwdriver w/Rubber Handle:</b>	
506+1455	1.0 x 5.5mm Slotted, 200mmL
506+1966	1.2 x 6.5mm Slotted, 250mmL
506+1980	1.2 x 8.0mm Slotted, 280mmL
508+1990	1.6 x 10.0mm Slotted, 320mmL
504+1421	#1 Philips, 200mmL
506+1802	#2 Philips, 225mmL
508+1841	#1 Posidriv, 180mmL
506+1952	#2 Posidriv, 250mmL
504+7608	T-8 Tamperproof Star, 150mmL
506+7710	T-10 Tamperproof Star, 180mmL
506+7715	T-15 Tamperproof Star, 180mmL
506+7920	T-20 Tamperproof Star, 200mmL
506+7925	T-25 Tamperproof Star, 200mmL
506+7827	T-27 Tamperproof Star, 225mmL
506+7830	T-30 Tamperproof Star, 225mmL
508+7940	T-40 Tamperproof Star, 255mmL
508+7945	T-45 Tamperproof Star, 255mmL
508+7850	T-50 Tamperproof Star, 235mmL

Item No.	Description
<b>Accessory:</b>	
0230	1/4" Hex Dr. x 1/4" Hex Shank Magnetic Bit Holder
0260	1/4" Hex Dr. x 1/4" Hex Shank Flexible Bit Holder
522+2982	1/4" Hex Shank Stubby Ratcheting Screwdriver
524+2983	1/4" Hex Shank Standard Ratching Screwdriver w/ Quick Release Chunk, 162mmL
520+2985	1/4" Hex Shank T-Handle Ratcheting Scedriver
SB-111SP	11pc Slotted & Philips Bit Set
SB-211MH	11pc Hex & Triple Square Bit Set
SB-311SH	11pc SAE Hex Bit Set
SB-711TP	11pc Star Bit Set
HK-009MB	9pc Metric Wobble Hex Key Wrench Set
SK-010T	10pc Tamperproof Star Key Wrench Set
Plastic Tray	

4200 g      2 sets / 10 Kgs / 1.76 CUFT



(570W x 410D x 50H)

## MS-035MS 35 Piece Pliers & Screwdriver Set

Item No.	Description
<b>Slotted Screwdriver w/Rubber Handle:</b>	
504+0430	0.5 x 3.0mm, 155mmL
504+1240	0.8 x 4.0mm, 180mmL
506+1455	1.0 x 5.5mm, 200mmL
502+1465	1.2 x 6.5mm, 98mmL
<b>Philips Screwdriver w/Rubber Handle:</b>	
504+0400	#0, 155mmL
504+1421	#1, 200mmL
502+1202	#2, 98mmL
506+1802	#2, 225mmL
<b>Tang-Thru Screwdriver w/Rubber Handle:</b>	
509+1966	1.2 x 6.5mm, 245mmL
509+1843	#3 Philips, 255mmL
<b>Accessory:</b>	
780256	Adjustable Wrench, 200mmL(8"L)
590212	Ball Peen Hammer 3/4 lbs.

Item No.	Description
530307A	Curved Jaw Locking Pliers, 180mmL (7"L)
550712D	Side Cutter Pliers, 180mmL(7"L)
550604D	Chain Nose Pliers, 150mmL(6"L)
550607D	Diagonal Cutting Pliers, 150mmL(6"L)
551011D	Water Pump Pliers, 250mmL(10"L)
HK-009MB	9pc Metric Wobble Hex Key Wrench Set
HK-009SB	9pc SAE Wobble Hex Key Wrench Set
Plastic Tray	

4500 g      2 sets / 11.5 Kgs / 1.76 CUFT



(570W x 410D x 50H)

**MS-015 15 Piece Pliers Set**

Item No.	Description
530310A	Curved Jaw Locking Pliers, 250mmL (10"L)
531309LN	Long Nose Locking Pliers, 230mmL (9"L)
530306AR	C-Clamp Locking Pliers, 150mmL (6"L)
550712D	Side Cutter Pliers, 180mmL (7"L)
550604D	Chain Nose Pliers, 150mmL (6"L)
550607D	Diagonal Cutting Pliers, 150mmL (6"L)
551011D	Water Pump Pliers, 250mmL (10"L)
550809	Combination Slip Joint Pliers, 200mmL (8"L)
550750	Straight Nose, External Retaining Ring Pliers (7")
550751	Straight Nose, Internal Retaining Ring Pliers (7")
550752	90° Bent Nose, External Retaining Ring Pliers (7")
550753	90° Bent Nose, Internal Retaining Ring Pliers (7")
780256	Adjustable Wrench, 200mmL (8"L)
782300	Heavy Duty Pipe Wrench, 300mmL (12"L)
511003S	Straight Tip Aviation Snip, 250mmL (10"L)



(570W x 410D x 50H)

5500 g 2 sets / 13 Kgs / 1.76 CUFT

**MS-139MS 139 Piece 1/4", 3/8" & 1/2" Dr. Metric & SAE Tool Set**

Item No.	Pcs	Description	Item No.	Pcs	Description
<b>1/4" Dr. 12pt Hand Socket:</b>					
232505~13	10	5, 5.5, 6, 7, 8, 9, 10, 11, 12, 13mm	280070	1	1/4" Dr. Hand Universal Joint
272506~16	9	3/16, 7/32, 1/4, 9/32, 5/16, 11/32, 3/8, 7/16, 1/2"	380070	1	3/8" Dr. Hand Universal Joint
<b>1/4" Dr. 12pt Universal Hand Socket:</b>					
253506~14	9	6, 7, 8, 9, 10, 11, 12, 13, 14mm	480070	1	1/2" Dr. Hand Universal Joint
263708~18	6	1/4, 5/16, 3/8, 7/16, 1/2, 9/16"	280226P	1	1/4" Dr. Hinge Handle
<b>1/4" Dr. Hex Head Hand Socket:</b>					
232803~10	8	3, 4, 5, 6, 7, 8, 9, 10mm	380338P	1	3/8" Dr. Hinge Handle
272804~12	8	1/8, 5/32, 3/16, 7/32, 1/4, 9/32, 5/16, 3/8"	480446P	1	1/2" Dr. Hinge Handle
<b>3/8" Dr. 12pt Hand Socket:</b>					
333208~19	12	8, 9, 10, 11, 12, 13, 14, 15, 16, 17, 18, 19mm	280231S	1	1/4" Dr. 36T Quick Release Ratchet
373210~24	10	5/16, 11/32, 3/8, 7/16, 1/2, 9/16, 19/32, 5/8, 11/16, 3/4"	380331S	1	3/8" Dr. 36T Quick Release Ratchet
<b>3/8" Dr. 12pt Universal Hand Socket:</b>					
355610~19	10	10, 11, 12, 13, 14, 15, 16, 17, 18, 19mm	480431S	1	1/2" Dr. 36T Quick Release Ratchet
365612~24	7	3/8, 7/16, 1/2, 9/16, 5/8, 11/16, 3/4"	326016	1	3/8" Dr. 16mm (5/8") Spark Plug Socket
<b>1/2" Dr. 12pt Hand Socket:</b>					
433810~32	17	10, 11, 12, 13, 14, 15, 16, 17, 18, 19, 21, 22, 23, 24, 27, 30, 32mm	326021	1	3/8" Dr. 20.6mm (13/16") Spark Plug Socket
473812~40	14	3/8, 7/16, 1/2, 9/16, 5/8, 11/16, 3/4, 13/16, 7/8, 15/16, 1", 1-1/16, 1-1/8, 1-1/4"	506+0175	1	1/4" Dr. Socket Driver
220002	1	1/4" Dr. Extension Bar, 50mmL	320020	1	3/8" Dr. Adapter, 3/8"F x 1/4"M
220004	1	1/4" Dr. Extension Bar, 100mmL	Plastic Tray		
320075	1	3/8" Dr. Extension Bar, 75mmL	10.5 Kg	3 sets / 35.5 Kgs / 2.7 CUFT	
320150	1	3/8" Dr. Extension Bar, 150mmL			
424125	1	1/2" Dr. Extension Bar, 125mmL			
424250	1	1/2" Dr. Extension Bar, 250mmL			

*\*MS-139MS specially designed for fitting in top chests TS-244 or TS-790*

# Display Cases

## TF-4131M 131 Piece 1/2" Dr. Metric Impact Socket Display (CR-V)

Item No.	Pcs	Size	Item No.	Pcs	Size
413810	10	10mm	413822	8	22mm
413811	10	11mm	413823	8	23mm
413812	10	12mm	413824	7	24mm
413813	10	13mm	413826	7	26mm
413814	10	14mm	413827	7	27mm
413817	9	17mm	413829	6	29mm
413819	9	19mm	413830	6	30mm
413821	8	21mm	413832	6	32mm

Display Case

27 Kg

1 set / 29.5 Kgs / 2.05 CUFT



6 pt.

## TF-4133S 133 Piece 1/2" Dr. SAE Impact Socket Display (CR-V)

Item No.	Pcs	Size	Item No.	Pcs	Size
493812	10	3/8"	493826	8	13/16"
493814	10	7/16"	493828	8	7/8"
493816	10	1/2"	493830	7	15/16"
493818	10	9/16"	493832	7	1"
493819	10	19/32"	493834	7	1-1/16"
493820	10	5/8"	493836	6	1-1/8"
493822	9	11/16"	493838	6	1-3/16"
493824	9	3/4"	493840	6	1-1/4"

Display Case

26.5 Kg

1 set / 29.5 Kgs / 2.05 CUFT



6 pt.

## CM-4131M 131 Piece 1/2" Dr. Metric Impact Socket Display (CR-Mo)

Item No.	Pcs	Size	Item No.	Pcs	Size
444010	10	10mm	444022	8	22mm
444011	10	11mm	444023	8	23mm
444012	10	12mm	444024	7	24mm
444013	10	13mm	444026	7	26mm
444014	10	14mm	444027	7	27mm
444017	9	17mm	444029	6	29mm
444019	9	19mm	444030	6	30mm
444021	8	21mm	444032	6	32mm

Display Case

26 Kg

1 set / 29 Kgs / 2.05 CUFT



6 pt.

## CM-4133S 133 Piece 1/2" Dr. SAE Impact Socket Display (CR-Mo)

Item No.	Pcs	Size	Item No.	Pcs	Size
464012	10	3/8"	464026	8	13/16"
464014	10	7/16"	464028	8	7/8"
464016	10	1/2"	464030	7	15/16"
464018	10	9/16"	464032	7	1"
464019	10	19/32"	464034	7	1-1/16"
464020	10	5/8"	464036	6	1-1/8"
464022	9	11/16"	464038	6	1-3/16"
464024	9	3/4"	464040	6	1-1/4"

Display Case

25.5 Kg

1 set / 28.5 Kgs / 2.05 CUFT



6 pt.

## TF-4131MD 131 Piece 1/2" Dr. Metric Deep Impact Socket Display (CR-V)

Item No.	Pcs	Size	Item No.	Pcs	Size
417810	10	10mm	417822	8	22mm
417811	10	11mm	417823	8	23mm
417812	10	12mm	417824	7	24mm
417813	10	13mm	417826	7	26mm
417814	10	14mm	417827	7	27mm
417817	9	17mm	417829	6	29mm
417819	9	19mm	417830	6	30mm
417821	8	21mm	417832	6	32mm

Display Case

46 Kg

1 set / 49.5 Kgs / 2.05 CUFT



6 pt.



## TF-4133SD 133 Piece 1/2" Dr. SAE Deep Impact Socket Display (CR-V)

Item No.	Pcs	Size	Item No.	Pcs	Size
497812	10	3/8"	497826	8	13/16"
497814	10	7/16"	497828	8	7/8"
497816	10	1/2"	497830	7	15/16"
497818	10	9/16"	497832	7	1"
497819	10	19/32"	497834	7	1-1/16"
497820	10	5/8"	497836	6	1-1/8"
497822	9	11/16"	497838	6	1-3/16"
497824	9	3/4"	497840	6	1-1/4"

Display Case

45.5 Kg

1 set / 49 Kgs / 2.05 CUFT



6 pt.



## CD-4131M 131 Piece 1/2" Dr. Metric Deep Impact Socket Display (CR-Mo)

Item No.	Pcs	Size	Item No.	Pcs	Size
447810	10	10mm	447822	8	22mm
447811	10	11mm	447823	8	23mm
447812	10	12mm	447824	7	24mm
447813	10	13mm	447826	7	26mm
447814	10	14mm	447827	7	27mm
447817	9	17mm	447829	6	29mm
447819	9	19mm	447830	6	30mm
447821	8	21mm	447832	6	32mm

Display Case

42 Kg

1 set / 45 Kgs / 2.05 CUFT



6 pt.



## CD-4133S 133 Piece 1/2" Dr. SAE Deep Impact Socket Display (CR-Mo)

Item No.	Pcs	Size	Item No.	Pcs	Size
467812	10	3/8"	467826	8	13/16"
467814	10	7/16"	467828	8	7/8"
467816	10	1/2"	467830	7	15/16"
467818	10	9/16"	467832	7	1"
467819	10	19/32"	467834	7	1-1/16"
467820	10	5/8"	467836	6	1-1/8"
467822	9	11/16"	467838	6	1-3/16"
467824	9	3/4"	467840	6	1-1/4"

Display Case

41 Kg

1 set / 44 Kgs / 2.05 CUFT



6 pt.





# Display Cases

## GS-4131M 131 Piece 1/2" Dr. Metric Hand Socket Display

Item No.	Pcs	Size	Item No.	Pcs	Size
423810	10	10mm	423822	8	22mm
423811	10	11mm	423823	8	23mm
423812	10	12mm	423824	7	24mm
423813	10	13mm	423826	7	26mm
423814	10	14mm	423827	7	27mm
423817	9	17mm	423829	6	29mm
423819	9	19mm	423830	6	30mm
423821	8	21mm	423832	6	32mm

Display Case

22 Kg

1 set / 23 Kgs / 2.41 CUFT



6 pt.

## GS-4133S 133 Piece 1/2" Dr. SAE Hand Socket Display

Item No.	Pcs	Size	Item No.	Pcs	Size
483812	10	3/8"	483826	8	13/16"
483814	10	7/16"	483828	8	7/8"
483816	10	1/2"	483830	7	15/16"
483818	10	9/16"	483832	7	1"
483819	10	19/32"	483834	7	1-1/16"
483820	10	5/8"	483836	6	1-1/8"
483822	9	11/16"	483838	6	1-3/16"
483824	9	3/4"	483840	6	1-1/4"

Display Case

23 Kg

1 set / 24 Kgs / 2.41 CUFT



6 pt.

## TW-4131M 131 Piece 1/2" Dr. Metric Hand Socket Display (12-Point)

Item No.	Pcs	Size	Item No.	Pcs	Size
433810	10	10mm	433822	8	22mm
433811	10	11mm	433823	8	23mm
433812	10	12mm	433824	7	24mm
433813	10	13mm	433826	7	26mm
433814	10	14mm	433827	7	27mm
433817	9	17mm	433829	6	29mm
433819	9	19mm	433830	6	30mm
433821	8	21mm	433832	6	32mm

Display Case

24.5 Kg

1 set / 27.5 Kgs / 2.41 CUFT



12 pt.

## TW-4133S 133 Piece 1/2" Dr. SAE Hand Socket Display (12-Point)

Item No.	Pcs	Size	Item No.	Pcs	Size
473812	10	3/8"	473826	8	13/16"
473814	10	7/16"	473828	8	7/8"
473816	10	1/2"	473830	7	15/16"
473818	10	9/16"	473832	7	1"
473819	10	19/32"	473834	7	1-1/16"
473820	10	5/8"	473836	6	1-1/8"
473822	9	11/16"	473838	6	1-3/16"
473824	9	3/4"	473840	6	1-1/4"

Display Case

24 Kg

1 set / 27 Kgs / 2.41 CUFT



12 pt.

## GD-4131M 131 Piece 1/2" Dr. Metric Deep Hand Socket Display

Item No.	Pcs	Size	Item No.	Pcs	Size
427810	10	10mm	427822	8	22mm
427811	10	11mm	427823	8	23mm
427812	10	12mm	427824	7	24mm
427813	10	13mm	427826	7	26mm
427814	10	14mm	427827	7	27mm
427817	9	17mm	427829	6	29mm
427819	9	19mm	427830	6	30mm
427821	8	21mm	427832	6	32mm

Display Case

35 Kg

1 set / 36 Kgs / 2.41 CUFT



6 pt.

## GD-4133S 133 Piece 1/2" Dr. SAE Deep Hand Socket Display

Item No.	Pcs	Size	Item No.	Pcs	Size
487812	10	3/8"	487826	8	13/16"
487814	10	7/16"	487828	8	7/8"
487816	10	1/2"	487830	7	15/16"
487818	10	9/16"	487832	7	1"
487819	10	19/32"	487834	7	1-1/16"
487820	10	5/8"	487836	6	1-1/8"
487822	9	11/16"	487838	6	1-3/16"
487824	9	3/4"	487840	6	1-1/4"

Display Case

36 Kg

1 set / 37 Kgs / 2.41 CUFT



6 pt.

## TW-4131MD 131 Piece 1/2" Dr. Metric Deep Hand Socket Display (12-Point)

Item No.	Pcs	Size	Item No.	Pcs	Size
437810	10	10mm	437822	8	22mm
437811	10	11mm	437823	8	23mm
437812	10	12mm	437824	7	24mm
437813	10	13mm	437826	7	26mm
437814	10	14mm	437827	7	27mm
437817	9	17mm	437829	6	29mm
437819	9	19mm	437830	6	30mm
437821	8	21mm	437832	6	32mm

Display Case

36.5 Kg

1 set / 39.5 Kgs / 2.41 CUFT



12 pt.

## TW-4133SD 133 Piece 1/2" Dr. SAE Deep Hand Socket Display (12-Point)

Item No.	Pcs	Size	Item No.	Pcs	Size
477812	10	3/8"	477826	8	13/16"
477814	10	7/16"	477828	8	7/8"
477816	10	1/2"	477830	7	15/16"
477818	10	9/16"	477832	7	1"
477819	10	19/32"	477834	7	1-1/16"
477820	10	5/8"	477836	6	1-1/8"
477822	9	11/16"	477838	6	1-3/16"
477824	9	3/4"	477840	6	1-1/4"

Display Case

36 Kg

1 set / 39 Kgs / 2.41 CUFT



12 pt.



# Display Boards

## GS-234105M 105 Piece 1/4", 3/8" & 1/2" Dr. Metric Hand Socket Display Board

6 pt.

Item No.	Size	Item No.	Size
<b>1/4" Dr. 6pt Hand Socket:</b>			
222503~14	3, 4, 4.5, 5, 5.5, 6, 7, 8, 9, 10, 11, 12, 13, 14mm	<b>1/2" Dr. 6pt Hand Socket:</b>	
		423808~32	8, 9, 10, 11, 12, 13, 14, 15, 16, 17, 18, 19, 20, 21, 22, 23, 24, 25, 26, 27, 28, 29, 30, 32mm
<b>1/4" Dr. 6pt Deep Hand Socket:</b>			
225204~14	4, 4.5, 5, 6, 7, 8, 9, 10, 11, 12, 13, 14mm	<b>1/2" Dr. 6pt Deep Hand Socket:</b>	
		427808~32	8, 9, 10, 11, 12, 13, 14, 15, 16, 17, 18, 19, 20, 21, 22, 23, 24, 25, 26, 27, 28, 29, 30, 32mm
<b>3/8" Dr. 6pt Hand Socket:</b>			
323206~21	6, 7, 8, 9, 10, 11, 12, 13, 14, 15, 16, 17, 18, 19, 21mm	Display Board	
<b>3/8" Dr. 6pt Deep Hand Socket:</b>			
326306~21	6, 7, 8, 9, 10, 11, 12, 13, 14, 15, 16, 17, 18, 19, 21mm		

13 Kg

1 set / 17 Kgs / 2.51 CUFT



## SW-234105M 105 Piece 1/4", 3/8" & 1/2" Dr. Metric Hand Socket Display Board

6 pt.

12 pt.

Item No.	Size	Item No.	Size
<b>1/4" Dr. 6pt Hand Socket:</b>			
222503~14	3, 4, 4.5, 5, 5.5, 6, 7, 8, 9, 10, 11, 12, 13, 14mm	<b>1/2" Dr. 12pt Hand Socket:</b>	
		433808~32	8, 9, 10, 11, 12, 13, 14, 15, 16, 17, 18, 19, 20, 21, 22, 23, 24, 25, 26, 27, 28, 29, 30, 32mm
<b>1/4" Dr. 6pt Deep Hand Socket:</b>			
225204~14	4, 4.5, 5, 6, 7, 8, 9, 10, 11, 12, 13, 14mm	<b>1/2" Dr. 12pt Deep Hand Socket:</b>	
		437808~32	8, 9, 10, 11, 12, 13, 14, 15, 16, 17, 18, 19, 20, 21, 22, 23, 24, 25, 26, 27, 28, 29, 30, 32mm
<b>3/8" Dr. 12pt Hand Socket:</b>			
333206~21	6, 7, 8, 9, 10, 11, 12, 13, 14, 15, 16, 17, 18, 19, 21mm	Display Board	
<b>3/8" Dr. 12pt Deep Hand Socket:</b>			
336306~21	6, 7, 8, 9, 10, 11, 12, 13, 14, 15, 16, 17, 18, 19, 21mm		

13 Kg

1 set / 17 Kgs / 2.51 CUFT



## AC-2331 31 Piece 1/4" & 3/8" Dr. Hand Accessory Display Board

Item No.	Description	Item No.	Description
<b>1/4" Dr. Hand Accessory:</b>			
220002	Extension Bar, 50mmL	320075	Extension Bar, 75mmL
220003	Extension Bar, 75mmL	320200	Extension Bar, 200mmL
220004	Extension Bar, 100mmL	320150	Extension Bar, 150mmL
220006	Extension Bar, 150mmL	380070	Universal Joint
220009	Extension Bar, 225mmL	326021	13/16" Spark Plug Socket
220012	Extension Bar, 300mmL	326016	5/8" Spark Plug Socket
280070	Universal Joint	380400	Speed Handle
280030	Adapter, 1/4"F x 3/8"M	380030	Sliding T-Handle
280020	Sliding T-Handle	384610	5/16" Shank Bit Holder
220160	Folding Socket Driver	384608	1/4" Shank Bit Holder
220150	1/4" Dr. Socket Driver	383910	5/16" Shank Bit Holder
280226A	Hinge Handle	383908	1/4" Shank Bit Holder
280272	72T Reversible Ratchet	320020	Adapter, 3/8"F x 1/4"M
280222R	24T Ratchet Handle	380375	24T Flexible Ratchet
		380331R	36T Reversible Ratchet
		380333R	24T Reversible Ratchet
		380336A	Hinge Handle
		Display Board	



6500 g

1 set / 10.5 Kgs / 2.4 CUFT



## GS-23485S 85 Piece 1/4", 3/8" & 1/2" Dr. SAE Hand Socket Display Board

Item No.	Size
<b>1/4" Dr. 6pt Hand Socket:</b>	
282504~18	1/8, 3/16, 7/32, 1/4, 9/32, 5/16, 11/32, 3/8, 7/16, 1/2, 9/16"
<b>1/4" Dr. 6pt Deep Hand Socket:</b>	
285206~18	3/16, 7/32, 1/4, 9/32, 5/16, 11/32, 3/8, 7/16, 1/2, 9/16"
<b>3/8" Dr. 6pt Hand Socket:</b>	
383208~28	1/4, 5/16, 11/32, 3/8, 7/16, 1/2, 9/16, 19/32, 5/8, 11/16, 3/4, 25/32, 13/16, 7/8"
<b>3/8" Dr. 6pt Deep Hand Socket:</b>	
386308~28	1/4, 5/16, 11/32, 3/8, 7/16, 1/2, 9/16, 19/32, 5/8, 11/16, 3/4, 25/32, 13/16, 7/8"

Item No.	Size
<b>1/2" Dr. 6pt Hand Socket:</b>	
483810~40	5/16, 3/8, 7/16, 1/2, 9/16, 19/32, 5/8, 11/16, 3/4, 25/32, 13/16, 7/8, 15/16, 1", 1-1/16, 1-1/8, 1-3/16, 1-1/4"
<b>1/2" Dr. 6pt Hand Socket:</b>	
487810~40	5/16, 3/8, 7/16, 1/2, 9/16, 19/32, 5/8, 11/16, 3/4, 25/32, 13/16, 7/8, 15/16, 1", 1-1/16, 1-1/8, 1-3/16, 1-1/4"

Display Board

11 Kg

1 set / 15 Kgs / 2.51 CUFT



6 pt.

## SW-23485S 85 Piece 1/4", 3/8" & 1/2" Dr. SAE Hand Socket Display Board

Item No.	Size
<b>1/4" Dr. 6pt Hand Socket:</b>	
282504~18	1/8, 3/16, 7/32, 1/4, 9/32, 5/16, 11/32, 3/8, 7/16, 1/2, 9/16"
<b>1/4" Dr. 6pt Deep Hand Socket:</b>	
285206~18	3/16, 7/32, 1/4, 9/32, 5/16, 11/32, 3/8, 7/16, 1/2, 9/16"
<b>3/8" Dr. 12pt Hand Socket:</b>	
383208~28	1/4, 5/16, 11/32, 3/8, 7/16, 1/2, 9/16, 19/32, 5/8, 11/16, 3/4, 25/32, 13/16, 7/8"
<b>3/8" Dr. 12pt Deep Hand Socket:</b>	
386308~28	1/4, 5/16, 11/32, 3/8, 7/16, 1/2, 9/16, 19/32, 5/8, 11/16, 3/4, 25/32, 13/16, 7/8"

Item No.	Size
<b>1/2" Dr. 12pt Hand Socket:</b>	
483810~40	5/16, 3/8, 7/16, 1/2, 9/16, 19/32, 5/8, 11/16, 3/4, 25/32, 13/16, 7/8, 15/16, 1", 1-1/16, 1-1/8, 1-3/16, 1-1/4"
<b>1/2" Dr. 12pt Deep Hand Socket:</b>	
487810~40	5/16, 3/8, 7/16, 1/2, 9/16, 19/32, 5/8, 11/16, 3/4, 25/32, 13/16, 7/8, 15/16, 1", 1-1/16, 1-1/8, 1-3/16, 1-1/4"

Display Board

11 Kg

1 set / 15 Kgs / 2.51 CUFT



6 pt.

12 pt.

## AC-417 17 Piece 1/2" Dr. Hand Accessory Display Board

Item No.	Description
<b>1/2" Dr. Hand Accessory:</b>	
424075	Extension Bar, 75mmL
424125	Extension Bar, 125mmL
424250	Extension Bar, 250mmL
480070	Universal Joint
480420	Speed Handle
480490	Speed Handle
420260L	L-Type Handle
480446A	Hinge Handle
480040	Sliding T-Handle

Item No.	Description
427016	16.0mm Spark Plug Socket
427021	20.6mm Spark Plug Socket
484108	1/4" Hex Shank Bit Holder
484110	5/16" Hex Shank Bit Holder
484808	1/4" Hex Shank Bit Holder
484810	5/16" Hex Shank Bit Holder
480444R	24T Reversible Ratchet
480431R	36T Reversible Ratchet

Display Board

8500 g

1 set / 12.5 Kgs / 2.4 CUFT



# Display Boards

## SW-646M 46 Piece 3/4" Dr. Metric Hand Socket Display Board

Item No.	Size
<b>3/4" Dr. 6pt Hand Socket:</b>	
625217~41	17, 18, 19, 20, 21, 22, 23, 24, 25, 26, 27, 28, 29, 30, 31, 32, 33, 34, 35, 36, 38, 40, 41mm

Item No.	Size
<b>3/4" Dr. 12pt Hand Socket:</b>	
635217~41	17, 18, 19, 20, 21, 22, 23, 24, 25, 26, 27, 28, 29, 30, 31, 32, 33, 34, 35, 36, 38, 40, 41mm

Display Board

18.5 Kg 1 set / 22.5 Kgs / 2.74 CUFT



6 pt.  
12 pt.

## AC-612 12 Piece 3/4" Dr. Hand Accessory Display Board

Item No.	Description
<b>3/4" Dr. Hand Accessory:</b>	
620100	Extension Bar, 100mmL
620150	Extension Bar, 150mmL
620200	Extension Bar, 200mmL
620250	Extension Bar, 250mmL
680606	Universal Joint
620608	Adapter, 3/4"F x 1"M
620604	Adapter, 3/4"F x 1/2"M
620330L	L-Type Handle
680446A	Hinge Handle
680060	Sliding T-Handle
680666R	24T Reversible Ratchet
680666RA	24T Reversible Ratchet

Display Board

14.5 Kg 1 set / 18.5 Kgs / 2.51 CUFT



## HS-48M 48 Piece Metric Combination Wrench Display Board

Item No.	Pcs	Size	Item No.	Pcs	Size
<b>Combination Wrench (Matt Finish):</b>					
726006	2	6mm	726018	2	18mm
726007	2	7mm	726019	2	19mm
726008	2	8mm	726020	2	20mm
726009	2	9mm	726021	2	21mm
726010	2	10mm	726022	2	22mm
726011	2	11mm	726023	2	23mm
726012	2	12mm	726024	2	24mm
726013	2	13mm	726025	2	25mm
726014	2	14mm	726026	2	26mm
726015	2	15mm	726027	2	27mm
726016	2	16mm	726030	2	30mm
726017	2	17mm	726032	2	32mm

Display Board

15 Kg 1 set / 19 Kgs / 2.74 CUFT



## SD-644S 44 Piece 3/4" Dr. SAE Deep Hand Socket Display Board

Item No.	Size
<b>3/4" Dr. 6pt Hand Socket:</b>	
685222~62	11/16, 3/4, 25/32, 13/16, 7/8, 15/16, 1", 1-1/16, 1-1/8, 1-3/16, 1-1/4, 1-5/16, 1-3/8, 1-7/16, 1-1/2, 1-9/16, 1-5/8, 1-11/16, 1-3/4, 1-13/16, 1-7/8, 1-15/16"

<b>3/4" Dr. 6pt Deep Hand Socket:</b>	
689522~62	11/16, 3/4, 25/32, 13/16, 7/8, 15/16, 1", 1-1/16, 1-1/8, 1-3/16, 1-1/4, 1-5/16, 1-3/8, 1-7/16, 1-1/2, 1-9/16, 1-5/8, 1-11/16, 1-3/4, 1-13/16, 1-7/8, 1-15/16"

Display Board

26.5 Kg 1 set / 30.5 Kgs / 2.85 CUFT



## CM-3490ACM 90 Piece 3/8" & 1/2" Dr. Metric Impact Socket & Accessory Display Board

Item No.	Size
<b>3/8" Dr. 6pt Impact Socket:</b>	
343207~22	7, 8, 9, 10, 11, 12, 13, 14, 15, 16, 17, 18, 19, 20, 21, 22mm

<b>3/8" Dr. 6pt Deep Impact Socket:</b>	
346307~22	7, 8, 9, 10, 11, 12, 13, 14, 15, 16, 17, 18, 19, 20, 21, 22mm

<b>1/2" Dr. 6pt Impact Socket:</b>	
444008~32	8, 9, 10, 11, 12, 13, 14, 15, 16, 17, 18, 19, 20, 21, 22, 23, 24, 25, 26, 27, 28, 29, 30, 32mm

<b>1/2" Dr. 6pt Deep Impact Socket:</b>	
447808~32	8, 9, 10, 11, 12, 13, 14, 15, 16, 17, 18, 19, 20, 21, 22, 23, 24, 25, 26, 27, 28, 29, 30, 32mm

Item No.	Size
<b>3/8" Dr. Impact Accessory:</b>	
340075B	Extension Bar, 75mmL
340125B	Extension Bar, 125mmL
340200B	Extension Bar, 200mmL
340020	Adapter, 3/8"F x 1/4"M
340040B	Adapter, 3/8"F x 1/2"M

<b>1/2" Dr. Impact Accessory:</b>	
480075MB	Extension Bar, 75mmL
480125MB	Extension Bar, 125mmL
480250MB	Extension Bar, 250mmL
480033MB	Adapter, 1/2"F x 3/8"M
480066MB	Adapter, 1/2"F x 3/4"M

Display Board

16.5 Kg 1 set / 20.5 Kgs / 2.74 CUFT



## CM-3472ACS 72 Piece 3/8" & 1/2" Dr. SAE Impact Socket & Accessory Display Board

Item No.	Size
<b>3/8" Dr. 6pt Impact Socket:</b>	
363210~28	5/16, 11/32, 3/8, 7/16, 1/2, 9/16, 19/32, 5/8, 11/16, 3/4, 25/32, 13/16, 7/8"

<b>3/8" Dr. 6pt Deep Impact Socket:</b>	
366310~28	5/16, 11/32, 3/8, 7/16, 1/2, 9/16, 19/32, 5/8, 11/16, 3/4, 25/32, 13/16, 7/8"

<b>1/2" Dr. 6pt Impact Socket:</b>	
464010~40	5/16, 3/8, 7/16, 1/2, 9/16, 19/32, 5/8, 11/16, 3/4, 25/32, 13/16, 7/8, 15/16, 1", 1-1/16, 1-1/8, 1-3/16, 1-1/4"

<b>1/2" Dr. 6pt Deep Impact Socket:</b>	
467810~40	5/16, 3/8, 7/16, 1/2, 9/16, 19/32, 5/8, 11/16, 3/4, 25/32, 13/16, 7/8, 15/16, 1", 1-1/16, 1-1/8, 1-3/16, 1-1/4"

Item No.	Size
<b>3/8" Dr. Impact Accessory:</b>	
340075B	Extension Bar, 3"L
340125B	Extension Bar, 5"L
340200B	Extension Bar, 8"L
340020	Adapter, 3/8"F x 1/4"M
340040B	Adapter, 3/8"F x 1/2"M

<b>1/2" Dr. Impact Accessory:</b>	
480075MB	Extension Bar, 3"L
480125MB	Extension Bar, 5"L
480250MB	Extension Bar, 10"L
480033MB	Adapter, 1/2"F x 3/8"M
480066MB	Adapter, 1/2"F x 3/4"M

Display Board

13.5 Kg 1 set / 17.5 Kgs / 2.74 CUFT



# Display Boards

## CM-630ACM 30 Piece 3/4" Dr. Metric Impact Socket & Accessory Display Board

Item No.	Size
<b>3/4" Dr. 6pt Impact Socket:</b>	
645217~41	17, 18, 19, 20, 21, 22, 23, 24, 25, 26, 27, 28, 29, 30, 31, 32, 33, 34, 35, 36, 38, 40, 41mm
<b>3/4" Dr. Impact Accessory:</b>	
640100	Extension Bar, 100mmL
640150	Extension Bar, 150mmL
640200	Extension Bar, 200mmL
640250	Extension Bar, 250mmL
640606	Uniersal Joint
640604B	Adapter, 3/4"F x 1/2"M
640608	Adapter, 3/4"F x 1"M
Display Board	

16 Kg 1 set / 20 Kgs / 2.74 CUFT



## CM-630ACS 30 Piece 3/4" Dr. SAE Impact Socket & Accessory Display Board

Item No.	Size
<b>3/4" Dr. 6pt Impact Socket:</b>	
665222~64	11/16, 3/4, 25/32, 13/16, 7/8, 15/16, 1", 1-1/16, 1-1/8, 1-3/16, 1-1/4, 1-5/16, 1-3/8, 1-7/16, 1-1/2, 1-9/16, 1-5/8, 1-11/16, 1-3/4, 1-13/16, 1-7/8, 1-15/16, 2"
<b>3/4" Dr. Impact Accessory:</b>	
640100	Extension Bar, 4"L
640150	Extension Bar, 6"L
640200	Extension Bar, 8"L
640250	Extension Bar, 10"L
640606	Uniersal Joint
640604B	Adapter, 3/4"F x 1/2"M
640608	Adapter, 3/4"F x 1"M
Display Board	

18 Kg 1 set / 22 Kgs / 2.74 CUFT

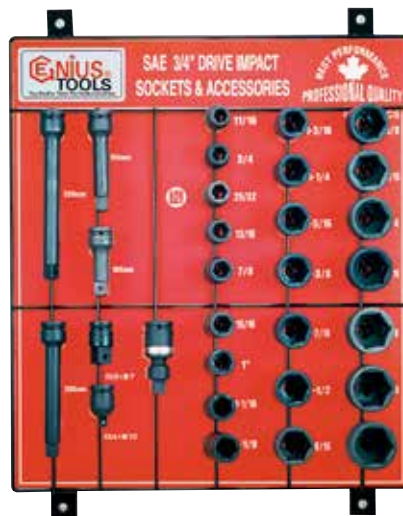

## HS-44AWS 44 Piece SAE Adjustable & Combination Wrench Display Board

Item No.	Pcs	Size	Item No.	Pcs	Size
<b>Combination Wrench (Matt Finish):</b>					
737008	2	1/4"	737032	2	1"
737010	2	5/16"	737034	2	1-1/16"
737012	2	3/8"	737036	2	1-1/8"
737014	2	7/16"	737040	2	1-1/8"
737016	2	1/2"	<b>Adjustable Wrench:</b>		
737018	2	9/16"	780128	2	4"L (100mmL)
737020	2	5/8"	780192	2	6"L (150mmL)
737022	2	11/16"	780256	2	8"L (200mmL)
737024	2	3/4"	780320	2	10"L (250mmL)
737026	2	13/16"	780384	2	12"L (300mmL)
737028	2	7/8"	780480	2	15"L (380mmL)
737030	2	15/16"	Display Board		

17 Kg 1 set / 21 Kgs / 2.74 CUFT



Master Sets

**GENIUS**®

*Tool Storage*



**GENIUS TOOLS**  
[www.geniustools.net](http://www.geniustools.net)



# Tool Storage

## DS-424 1/2" Drive Sockets Display Stand

	Width mm(Inch)	Depth mm(Inch)	Height mm(Inch)
Overall	425 (16-11/16")	340 (16-3/8")	315 (12-3/8")

15900 g

1 set / 6.3 Kgs / 0.54 CUFT

- Suitable for Shallow and Deep Sockets
- Stickers Included: 8 ~ 32mm & 5/16 ~ 1-1/4"



## TS-123 3 Drawer Tool Chest

	Width mm (Inch)	Depth mm (Inch)	Height mm (Inch)
Overall	575 (22-5/8")	230 (9")	311 (12-3/16")
2 Drawers	503 (19-3/4")	193 (7-9/16")	50 (1-15/16")
1 Drawer	503 (19-3/4")	193 (7-9/16")	74 (2-7/8")

10.5 Kg

1 set / 13.5 Kgs / 1.9 CUFT



## TS-244 4 Drawer Top Chest

	Width mm (Inch)	Depth mm (Inch)	Height mm (Inch)
Overall	665 (26-1/8")	450 (17-11/16")	390 (15-5/16")
3 Drawers	584 (22-1/2")	410 (16-1/8")	56 (2-3/16")
1 Drawer	584 (22-1/2")	410 (16-1/8")	76 (3")

31.5 Kg

1 set / 34 Kgs / 5.9 CUFT



Add-on for  
TS-465, TS-465P,  
TS-467, TS-467P

## TS-125 5 Tier Portable Tool Chest

	Width mm (Inch)	Depth mm (Inch)	Height mm (Inch)
Overall	536 (21-1/16")	258 (10-1/8")	220 (8-5/8")
4 Drawers	530 (20-13/16")	125 (4-7/8")	50 (1-15/16")
1 Drawer	530 (20-13/16")	253 (9-15/16")	88 (3-7/16")

6.5 Kg

1 set / 7.5 Kgs / 2 CUFT

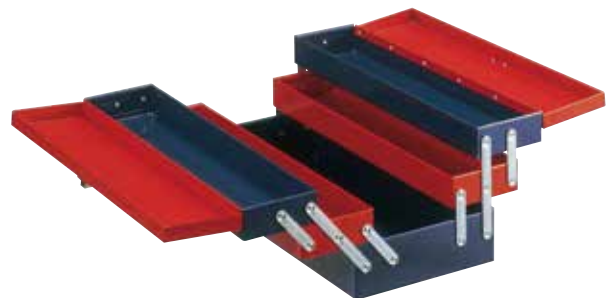

### Features:

Customize your portable tool chest with Genius long size tool trays and Genius tools.

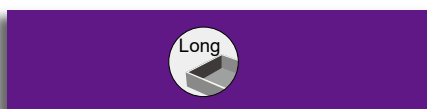

Tool Storage

## TS-465 5 Drawer Roller Cabinet

	Width mm (Inch)	Depth mm (Inch)	Height mm (Inch)
Overall	686 (27")	466 (18-5/16")	666 (26-3/16")
3 Drawers	581 (22-13/16")	410 (16-1/8")	75 (2-15/16")
2 Drawers	581 (22-13/16")	410 (16-1/8")	153 (6")

 53.5 Kg

 1 set / 57 Kgs / 9.8 CUFT



## TS-465P 5 Drawer Roller Cabinet (w/ Top Tray)

	Width mm (Inch)	Depth mm (Inch)	Height mm (Inch)
Overall	686 (27")	466 (18-5/16")	666 (26-3/16")
3 Drawers	581 (22-13/16")	410 (16-1/8")	75 (2-15/16")
2 Drawers	581 (22-13/16")	410 (16-1/8")	153 (6")
Top Tray	890 (35")	510 (20-1/16")	45 (1-3/4")

 62 Kg

 1 set / 64.5 Kgs / 14 CUFT



## TS-467 7 Drawer Roller Cabinet

	Width mm (Inch)	Depth mm (Inch)	Height mm (Inch)
Overall	686 (27")	466 (18-5/16")	820 (32-1/4")
5 Drawers	581 (22-13/16")	410 (16-1/8")	75 (2-15/16")
2 Drawers	581 (22-13/16")	410 (16-1/8")	153 (6")

 65 Kg

 1 set / 69 Kgs / 11.5 CUFT



## TS-467P 7 Drawer Roller Cabinet (w/ Top Tray)

	Width mm (Inch)	Depth mm (Inch)	Height mm (Inch)
Overall	686 (27")	466 (18-5/16")	820 (32-1/4")
5 Drawers	581 (22-13/16")	410 (16-1/8")	75 (2-15/16")
2 Drawers	581 (22-13/16")	410 (16-1/8")	153 (6")
Top Tray	890 (35")	510 (20-1/16")	45 (1-3/4")

 70 Kg

 1 set / 75 Kgs / 15 CUFT



# Tool Storage

## TS-246 6 Drawer Top Chest

	Width mm (Inch)	Depth mm (Inch)	Height mm (Inch)
Overall	968 (38-1/16")	450 (17-11/16")	575 (23")
4 Drawers	877 (34-1/2")	410 (16-1/8")	58 (2-1/4")
2 Drawers	877 (34-1/2")	410 (16-1/8")	95 (3-11/16")

 59.5 Kg

 1 set / 64.5 Kgs / 13.3 CUFT



Add-on  
for  
TS-468

## TS-468 7 Drawer Roller Cabinet

	Width mm (Inch)	Depth mm (Inch)	Height mm (Inch)
Overall	980 (38-9/16")	470 (18-1/2")	805 (31 -11/16")
5 Drawers	877 (34-1/2")	410 (16-1/8")	74 (2-7/8")
2 Drawers	877 (34-1/2")	410 (16-1/8")	152 (5-15/16")

 86 Kg

 1 set / 94 Kgs / 17 CUFT



Double Brakes

## TS-764 Roll Cart with 4 Drawers

	Width mm (Inch)	Depth mm (Inch)	Height mm (Inch)
Overall	778 (30-5/8")	517 (20-5/16")	888 (34-15/16")
2 Drawers	298 (11-11/16")	434 (17-1/16")	100 (3-7/8")
1 Drawer	625 (24-9/16")	434 (17-1/16")	98 (3-13/16")
1 Drawer	625 (24-9/16")	434 (17-1/16")	145 (5-11/16")

 65.5 Kg

 1 set / 71.5 Kgs / 10.9 CUFT



**NEW**

## TS-798P 7 Drawer Roller Cabinet (w/ Top Tray)

	Width mm (Inch)	Depth mm (Inch)	Height mm (Inch)
Overall	670 (26-3/8")	460 (18-1/16")	813 (32")
5 Drawers	576 (22-5/8")	410 (16-1/8")	76 (2-15/16")
2 Drawers	576 (22-5/8")	410 (16-1/8")	155 (6-1/16")
Top Tray	890 (35")	510 (20-1/16")	45 (1-3/4")

 68 Kg

 1 set / 77 Kgs / 13.5 CUFT



## TS-790 10 Drawer Top Chest

	Width mm (Inch)	Depth mm (Inch)	Height mm (Inch)
Overall	660 (25-15/16")	455 (17-7/8")	483 (19")
6 Drawers	169 (6-5/8")	410 (16-1/8")	51 (2")
2 Drawers	576 (22-5/8")	410 (16-1/8")	51 (2")
1 Drawer	169 (6-5/8")	410 (16-1/8")	155 (6-1/16")
1 Drawer	576 (22-5/8")	410 (16-1/8")	76 (2-15/16")

52 Kg

1 set / 57 Kgs / 8.5 CUFT



Add-on  
for  
TS-798



## TS-797 7 Drawer Side Cabinet

	Width mm (Inch)	Depth mm (Inch)	Height mm (Inch)
Overall	380 (14-15/16")	460 (18-1/16")	798 (31-3/8")
5 Drawers	291 (11-7/16")	410 (16-1/8")	76 (2-15/16")
2 Drawers	291 (11-7/16")	410 (16-1/8")	155 (6-1/16")

37 Kg

1 set / 40 Kgs / 7.5 CUFT



Add-on  
for  
TS-798



## TS-798 7 Drawer Roller Cabinet

	Width mm (Inch)	Depth mm (Inch)	Height mm (Inch)
Overall	670 (26-3/8")	460 (18-1/16")	813 (32")
5 Drawers	576 (22-5/8")	410 (16-1/8")	76 (2-15/16")
2 Drawers	576 (22-5/8")	410 (16-1/8")	155 (6-1/16")

64 kg

1 set / 72 Kgs / 12.5 CUFT



TS-797

TS-790

TS-798

# Tool Storage

## TS-710 6 Drawer Top Chest

	Width mm (Inch)	Depth mm (Inch)	Height mm (Inch)
Overall	836 (32-7/8")	485 (19-1/16")	540 (21-1/4")
5 Drawers	730 (28-11/16")	415 (16-5/16")	53 (2-1/16")
1 Drawer	730 (28-11/16")	415 (16-5/16")	106 (4-1/8")

73 Kg

1 set / 76.5 Kgs / 9.7 CUFT



Add-on  
for  
TS-796

## TS-748 8 Drawer Side Cabinet

	Width mm (Inch)	Depth mm (Inch)	Height mm (Inch)
Overall	510 (20-1/16")	500 (19-5/8")	945 (37-3/16")
3 Drawers	390 (15-5/16")	422 (16-9/16")	61 (2-3/8")
3 Drawers	390 (15-5/16")	422 (16-9/16")	102 (4")
2 Drawers	390 (15-5/16")	422 (16-9/16")	165 (6-7/16")

63 Kg

1 set / 68 Kgs / 11 CUFT



Add-on  
for  
TS-796

## TS-796 8 Drawer Roller Cabinet

	Width mm (Inch)	Depth mm (Inch)	Height mm (Inch)
Overall	850 (33-7/16")	500 (19-5/8")	955 (37-9/16")
3 Drawers	734 (28-7/8")	422 (16-9/16")	61 (2-3/8")
3 Drawers	734 (28-7/8")	422 (16-9/16")	102 (4")
2 Drawers	734 (28-7/8")	422 (16-9/16")	165 (6-7/16")

138 Kg

1 set / 152 Kgs / 18.7 CUFT



TS-748

TS-710

TS-796

Tool Storage

## WS-759 Multi-Function Workstation Set

	Width mm (Inch)	Depth mm (Inch)	Height mm (Inch)
Overall	1530 (60-3/16")	706 (27-3/4")	1590 (62-9/16")
2 Drawers	569 (22-3/8")	275 (10-13/16")	53 (2-1/16")
1 Drawer	569 (22-3/8")	275 (10-13/16")	77 (3")
2 Wall Cabinetss	400 (15-11/16")	200 (7-13/16")	500 (19-5/8")

### Accessory:

059280	Cutting Board W 1500mm x D 700mm x H 6mm
075904	4 Sets Adjust Device
038000	10 Piece U Shape Hooks
038011	10 Piece Single Hooks
038021	10 Piece Double Hooks

103 Kg

1 set / 109 Kgs / 15.1 CUFT

## Hooks

ITEM NO.	Hook Type	Length inch	Weight g	PCS	G.W. KGS	CUFT
038000	U Shape	2	45	200	9.5	0.52
038011	Single	1	35	200	8.0	0.52
038014	Single	4	45	100	5.5	0.52
038018	Single	8	70	160	12.0	1.25
038021	Double	1	45	280	13.5	1.25
038024	Double	4	70	160	12.0	1.25
038028	Double	8	120	100	13.0	1.25



- Two wall cabinets provide both security and inventory control
- Cutting board surface for oil resistance, acid resistance and anti-static
- Height adjusting device



# Tool Storage

## DS-038B Display Stand Set

	Width mm (Inch)	Depth mm (Inch)	Height mm (Inch)
Overall	945 (37")	500 (20")	2200 (87")

### Accessory:

Display Light Set, 110V or 220V

011102 50 Pieces Single Hook 2"

011104 20 Pieces Single Hook 4"

011106 10 Pieces Single Hook 6"

⚖️ 52.5 Kg

📦 1 set / 56 Kgs / 8.1 CUFT

## DS-111 Display Stand Set

	Width mm (Inch)	Depth mm (Inch)	Height mm (Inch)
Overall	945 (37")	400 (16")	2245 (88")

### Accessory:

Display Light Set, 110V or 220V

011102 50 Pieces Single Hook 2"

011104 20 Pieces Single Hook 4"

011106 10 Pieces Single Hook 6"

⚖️ 45 Kg

📦 1 set / 50 Kgs / 4.99 CUFT



Tool Storage





## AT-BC18 18 Piece Master Universal Caliper Wind Back Set

Item No.	Description
008ATS	Pusher Screw Handle (R)
018BCS	Pusher Screw Handle (L)
008AT0	63mm(2-1/2") Adapter (1 Pin $\varnothing$ = 5.5mm )
018BC1	Plate
008AT2	51mm(2") Adapter (1 Long & 2 Short Pins $\varnothing$ = 6mm )
008ATF	55mm(2-3/16") Adapter
008AT4	32mm(1-1/4") Adapter (2 Short Pins $\varnothing$ = 5mm )
008ATA	3/8" Square Dr. Adapter (2 Pins $\varnothing$ = 6mm )
008AT6	42mm(1-5/8") Adapter (2 Long Pins $\varnothing$ = 6mm )
008AT7	42mm(1-5/8") Adapter (2 Short Pins $\varnothing$ = 6mm )
008AT8	47mm(1-7/8") Adapter (1 Pin $\varnothing$ = 5.5mm )
008ATP	54mm(2-1/8") Adapter (1 Pin $\varnothing$ = 5.5mm )
018BCA	30mm(1-3/16") Adapter (2 Pins $\varnothing$ = 4mm )
018BCE	42mm(1-5/8") Adapter (4 Pins $\varnothing$ = 5mm )
018BCF	32mm(1-1/4") Adapter (2 Pins $\varnothing$ = 4mm )
018BCK	54mm(2-1/8") Adapter (2 Pins $\varnothing$ = 8mm )
018BCM	32mm(1-1/4") Adapter (2 Pins $\varnothing$ = 5.5mm )
018BCN	32mm(1-1/4") Adapter (12mm Male Hex )

Blow Case

2500 g 4 sets / 11 Kgs / 1.07 CUFT

- Designed for most: Alfa - Audi - BMW - Fiat - Ford - GM - Honda - Jaguar - Mercedes - Mazda - Nissan - Peugeot - Rover - Saab - Toyota - VW



## AT-BC08 11 Piece Brake Piston Wind Back Set

Item No.	Description
08BCAH	Pusher Screw Handle (R)
08BCA0	32mm(1-1/4") Adapter (2 Pins $\varnothing$ = 5mm )
08BCA1	Plate
08BCA2	36mm(1-7/16") Adapter (2 Pins $\varnothing$ = 4mm )
08BCA3	46mm(1-13/16") Adapter (1 Sq. Pin $\square$ = 8mm )
08BCA4	48mm(1-7/8") Adapter (2 Sq. Pins $\square$ = 11mm )
08BCA5	36mm(1-7/16") Adapter (1 Sq. Pin $\square$ = 8mm )
08BCA6	46mm(1-13/16") Adapter (2 Pins $\varnothing$ = 5mm )
08BCA7	36mm(1-7/16") Adapter (2 Pins $\varnothing$ = 6.35mm )
08BCA8	55mm(2-3/16") Adapter
08BCA9	42mm(1-5/8") Adapter (2 Pins $\varnothing$ = 6mm )

Blow Case

2000 g 4 sets / 9 Kgs / 0.85 CUFT

- Designed for most: Alfa - Audi - BMW - Fiat - Ford - GM - Honda - Jaguar - Mercedes - Mazda - Nissan - Peugeot - Rover - Saab - Toyota - VW



## AT-7207 7 Piece Ball Joint Removal & Installing Set

Item No.	Description
072701	Forcing Screw
072702	C-Frame Press
072703	Receiving Tube (3" O.D. x 2-3/4" I.D.)
072704	Receiving Tube (2-1/2" O.D. x 2-1/4" I.D.)
072705	Receiving Tube (2" O.D. x 1-3/4" I.D.)
072706	Removing Adapter
072707	Installing Adapter

Blow Case



7000 g 2 sets / 15 Kgs / 0.92 CUFT



## AT-08 10 Piece Disc Brake Caliper Tool Set

Item No.	Description
008ATS	Pusher Screw Handle (R)
008ATA	3/8" Square Dr. Adapter (2 Pins $\varnothing = 6\text{mm}$ )
008ATF	55mm(2-3/16") Adapter
008ATP	54mm(2-1/8") Adapter (1 Pin $\varnothing = 5.5\text{mm}$ )
008AT0	63mm(2-1/2") Adapter (1 Pin $\varnothing = 5.5\text{mm}$ )
008AT2	51mm(2") Adapter (1 Long & 2 Short Pins $\varnothing = 6\text{mm}$ )
008AT4	32mm(1-1/4") Adapter (2 Short Pins $\varnothing = 5\text{mm}$ )
008AT6	42mm(1-5/8") Adapter (2 Long Pins $\varnothing = 6\text{mm}$ )
008AT7	42mm(1-5/8") Adapter (2 Short Pins $\varnothing = 6\text{mm}$ )
008AT8	47mm(1-7/8") Adapter (1 Pin $\varnothing = 5.5\text{mm}$ )

Blow Case

 2100 g  10 sets / 22 Kgs / 2.2 CUFT

- Jack up the car and support on axle stands, Then remove the relevant road wheel.
- Remove the caliper from its carrier and take out the brake pads.
- Fit the main body of the wind back tool into the caliper, turn the main thrust bolt clockwise to compensate for the distance between the position and caliper body.
- Select the correct adapter and fit it to the end of the main thrust bolt, continue rotating into the mating recesses in the piston.
- Turn the thrust bolt to wind the caliper piston back into its housing
- Fit the new break pads and bolt the caliper back into the carrier



## AT-09 9 Piece Valve Spring Compressor Set

Item No.	Description
009009	250mm(10") "C" Clamp
009016	16mm Driving Adapter
009019	19mm Driving Adapter
009023	23mm Driving Adapter
009025	25mm Driving Adapter
009030	30mm Driving Adapter
009070	70mm Length Pressure Screw
009110	110mm Length Pressure Screw

Blow Case

 2000 g  4 sets / 9 Kgs / 1 CUFT

- These tools are designed to compress and release valve springs.
- After removal of collects, pantograph-type levers ensure a consistent coaxial contact with the valve.
- They work efficiently on all automobiles, trucks and tractor motors.



## AT-4808 8 Piece Inner Tie Rod Tool Set

Item No.	Description
048014	14mm Open Jaw Driver
048017	17mm Open Jaw Driver
048033	33.6mm Open Jaw Driver
048038	1-3/16" Open Jaw Driver
048040	1-1/4" Open Jaw Driver
048042	1-5/16" Open Jaw Driver
048046	1-7/16" Open Jaw Driver
048080	Long Socket

Blow Case

 2400 g  6 sets / 15.5 Kgs / 1.35 CUFT

- These tools are specially designed for the inner tie rods that are inaccessible to adjust.
- The inner tie rod can be easily removed and installed by slipping the long socket over the tie rod end and connecting it to the open-jaw driver.



## AT-BS12 12 Piece Combination Gear & Bearing Separator Set

Pcs	Description
1	Bearing Separator, Capacity: 30~50mm
1	Bearing Separator, Capacity: 50~70mm
4	Main Rod
4	Extension Rod
1	Center Bolt
1	Beam
Blow Case	
5000 g	5 sets / 26 Kgs / 1.2 CUFT

**NEW**



**NEW**

## AT-OS07 7 Piece Oxygen Sensor Wrench Set

Parts No.	Parts Name	Description
409029	Vacuum Switch Socket	1/2" Dr. x 29mm x 90mmL (6-Point)
407827	Injector Socket	1/2" Dr. x 27mm(1-1/16") x 78mmL (12-Point)
39743234	Oil Sender Unit Socket	3/8" Dr. x 1" & 27mm(1-1/16") x 74mmL (6-Point)
309022	Oxygen Sensor Socket	3/8" Dr. x 22mm(7/8") x 90mmL (6-Point)
308022A	Vacuum Switch Socket	3/8" Dr. x 22mm(7/8") x 80mmL (6-Point)
303022	Oxygen Sensor Wrench	3/8" Dr. x 22mm(7/8") x 30mmL (6-Point)
405022	Oxygen Sensor Socket	1/2" Dr. x 22mm(7/8") x 50mmL (6-Point)
Blow Case		
2000 g	12 sets / 25 Kgs / 1.13 CUFT	



## AT-0914 14 Piece Ball Joint Adapter Set

Item No.	Description	O.D. (inch)	I.D. (inch)	Length (inch)
097917	Plug	7/8		
098354	Receiving Tube	2-1/4	2	2
098355	Installing Tube	2	1-3/4	3
099976	Receiving Tube	2-1/2	2-1/4	1-1/2
094508	Receiving Cup	2-1/4	1-7/8	7/16
092304	Receiving Tube	2-1/2	2-1/4	3/4
092305	Receiving Tube	2-1/2	2-1/4	2-3/4
092306	Receiving Tube	3	2-3/4	2-1/4
092307	Receiving Tube	2-3/4	2-7/16	2-1/4
093444	Receiving Tube	2-7/8	2-5/8	2-7/8
093967	Receiving Tube	2-7/16	2-3/16	3-3/16
093968	Remover / Installer	1-7/16	3/4	1
093969	Installing Tube	2	1-3/4	2-5/16
093970	Receiving Cup	2-1/8	1-3/4	1/2
Blow Case				
5300 g	3 sets / 17 Kgs / 1.6 CUFT			



- A complete ball joint adapter set
- Includes all the receive tubes and removing/installing adapters needed to work on most GM, Ford and Dodge two and four-wheel drive pickups, vans and sport utility vehicles through 2002. Application chart included
- Works on press-fit upper and lower ball joints
- Set also includes a live center forcing screw plug



## AT-BW08 8 Piece Belt Tensioning Wrench Set

Pcs	Description
5	6-Point Sockets: 13, 14, 15, 16, 18mm
2	Adapters: 3/8" & 1/2" Drive
1	15mm Hex Ratcheting Wrench

Blow Case



 1050 g  20 sets / 22.4 Kgs / 2.1 CUFT



## AT-BW15 15 Piece Belt Tensioning Wrench Set

Pcs	Description
8	6-Point Sockets: 8, 12, 13, 14, 15, 16, 17, 18mm
1	12-Point Socket: 24mm
2	Adapters: 3/8" & 1/2" Drive
3	Bit Adapters: 1/4" x 5/16", 5/16" x 5/16", 10mm x 5/16" Hex Shank
1	15mm Hex Ratcheting Wrench



Blow Case

 1700 g  12 sets / 21.1 Kgs / 1.8 CUFT



## FG-020M 20 Blades Metric Feeler Gauge Set (0.05~1.00mm)



**Blades: 100mmL**  
 0.05 - 0.10 - 0.15 - 0.20 - 0.25 - 0.30 - 0.35 -  
 0.40 - 0.45 - 0.50 - 0.55 - 0.60 - 0.65 - 0.70 -  
 0.75 - 0.80 - 0.85 - 0.90 - 0.95 - 1.00mm  
 Sliding Card

 90 g  20x10 200 sets / 22 Kgs / 1.42 CUFT



## FG-025M 25 Blades Metric Feeler Gauge Set (0.04~1.00mm)



**Blades: 85mmL x 12.7mmW**  
 0.04 - 0.05 - 0.06 - 0.07 - 0.08 - 0.09 - 0.10 - 0.15 - 0.20 -  
 0.25 - 0.30 - 0.35 - 0.40 - 0.45 - 0.50 - 0.55 - 0.60 - 0.65 -  
 0.70 - 0.75 - 0.80 - 0.85 - 0.90 - 0.95 - 1.00mm  
 Sliding Card

 105 g  20x10 200 sets / 25 Kgs / 1.42 CUFT



## FG-026S 26 Blades SAE Feeler Gauge Set (0.0015"~0.025")

**Blades: 89mmL x 12.7mmW**  
 0.0015 - 0.002 - 0.0025 - 0.003 - 0.004 - 0.005 - 0.006 -  
 0.007 - 0.008 - 0.009 - 0.010 - 0.011 - 0.012 - 0.013 -  
 0.014 - 0.015 - 0.016 - 0.017 - 0.018 - 0.019 - 0.020 -  
 0.021 - 0.022 - 0.023 - 0.024 - 0.025"  
 Sliding Card

 90 g  20x10 200 sets / 22 Kgs / 1.42 CUFT





## AT-SC230 2 Piece Spring Compressor Set

**Description**

- Fits 3/8" Dr. Ratchet or Air Impact Wrench
- Length: 300 mmL

Color Box



 1670 g  12 sets / 21 Kgs / 1 CUFT

- Designed for work on regular or MacPherson Strut assemblies.
- Its rugged construction and patented drop forged hooks design make strut spring removal safer and easier.
- Suitable for use where space under wheel arch is limited.



## AT-AW13 13 Piece Alternator Tool Set

Pcs	Description
2	Combined Socket with 33T Alternator Wrenches: T50 x 113mmL, M10 x 113mmL
4	Alternator Parts: H15 x 33T, H22 x 33T, H22 x 30mmL, H17 x 4pins
6	10mm Hex Shank, 75mmL Bits: H8, H10, T40, T50, M8, M10
1	1/2" Dr. 10mm Hex Shank Bit Holder

Blow Case  
 1300 g       10 sets / 14 Kgs / 1.0 CUFT

**NEW**



## Piston Ring Compressors

Item No.	Capacity mm	Length inch(mm)	Weight g	PCS inner/ctn	G.W. KGS	CUFT 
PR-1253	53~125	3" (75)	230	60	17.5	2.0
PR-1254	53~125	3-1/2" (90)	240	60	18.5	2.0
PR-1753	90~175	3" (75)	260	60	19.5	2.0
PR-1754	90~175	3-1/2" (90)	300	60	21.5	2.0
PR-1755	90~175	4" (100)	300	60	22.0	2.6
PR-1756	90~175	6" (150)	520	40	25.0	3.0
PR-1757	90~175	6-1/2" (165)	560	40	27.0	3.3





## Piston Ring Pliers

Item No.	Capacity mm	Length mm	Weight g	PCS inner/ctn	G.W. KGS	CUFT 
PR-5100	50~100	210	250	48	17.0	2.1
PR-6120	80~120	225	280	48	19.0	2.4
PR-7160	110~160	255	350	48	24.0	3.2



## PR-804 4 Piece Piston Ring Groove Cleaner Set

Item No.	Description
<b>Piston Ring Groove Cleaning Handle:</b>	
PR-400	Fits: 2~5" (51~127mm)
<b>Piston Ring Groove Cleaning blades:</b>	
PR-401	Blade #1: 1/16, 5/64, 3/32, 1/8, 5/32 & 3/16"
PR-402	Blade #2: 2, 2.5, 3, 4, 4.5mm & 1/4"
PR-403	Blade #3: 1.2, 1.5, 1.8, 2.8, 5 & 5.5mm

Sliding Card  
 300 g       10x4 40 sets / 17 Kgs / 1.96 CUFT



## PR-9809 9 Piece Piston Ring Service Tool Set

Item No.	Description
<b>Piston Ring Compressors:</b>	
PR-1253	Capacity: 53~125mm, Length: 3"
PR-1754	Capacity: 90~175mm, Length: 3-1/2"
PR-1755	Capacity: 90~175mm, Length: 4"
<b>Piston Ring Pliers:</b>	
PR-5100	Capacity: 50~100mm
<b>Piston Ring Groove Cleaning Handle:</b>	
PR-400	Fits: 2~5" (51~127mm)
<b>Piston Ring Groove Cleaning blades:</b>	
PR-401	Blade #1: 1/16, 5/64, 3/32, 1/8, 5/32 & 3/16"
PR-402	Blade #2: 2, 2.5, 3, 4, 4.5mm & 1/4"
PR-403	Blade #3: 1.2, 1.5, 1.8, 2.8, 5 & 5.5mm

**Offset Screwdriver:**  
 6mm slotted x #2 philips  
 Blow Case

 2560 g       6 sets / 17 Kgs / 2.8 CUFT



**NEW**

## Oil Filter Wrenches for Toyota & Lexus

Item No.	Suitable For	Dimension	Weight	PCS	G.W.	CUFT
		mm	g	inner/ctn	KGS	
AT-OF21	4 cylinder	80	150	10 / 40	8.5	1.49
AT-OF22	6 & 8 cylinder	90	200	10 / 40	9.0	1.49



AT-OF21



AT-OF22

- Material: Aluminum, Forged
- Size: 14 flutes x 64.5mm
- Using with 3/8" Dr. ratchet & 27mm 6pt socket
- Using torques: 25 ± 5 Nm

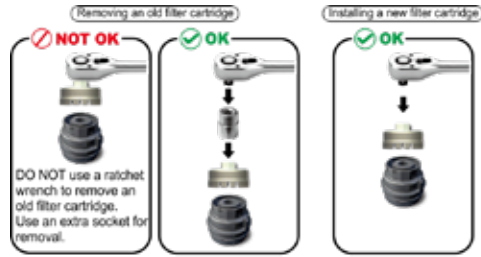



## AT-B01 Three-Legged Oil Filter Wrench

### Description

- Fits 3/8" & 1/2" Drive
- With 21mm Hex Adaptor: 1/2" F x 3/8" M
- Adjustable from 2-3/4 ~ 5" (70 ~ 125mm)

Color Box

 610 g       36 sets / 23 Kgs / 0.98 CUFT

- Design allows for broad range and tremendous gripping power.
- Gets into tight spots.
- Features heavy duty grooved legs for positive grip.
- Can be used directly with 3/8" Dr. ratchet.
- Can be used with 1/2" Dr. ratchet & 21mm wrench.



## Heavy Duty Oil Filter Pliers

Item No.	Capacity	Length	Weight	PCS	G.W.	CUFT
	mm (inch)	mm(inch)	g	inner/ctn	KGS	
AT-OF10	60~90 (2-3/8~3-1/2")	250 (10")	480	6 / 36	19.0	1.80
AT-OF12	50~115 (2"~4-1/2")	300 (12")	520	1 / 36	20.0	1.80

- 3 Position Adjustable



## Swivel Handle Oil Filter Wrenches

Item No.	Diameter Capacity	Weight	PCS	G.W.	CUFT
	mm (inch)	g	inner/ctn	KGS	
AT-BOF2	60~73 (2-3/8~2-7/8")	350	6 / 36	13.8	2.70
AT-BOF3	73~85 (2-7/8~3-3/8")	360	6 / 36	14.0	2.70
AT-BOF4	85~95 (3-3/8~3-3/4")	400	6 / 36	14.7	2.70
AT-BOF5	95~110 (3-3/4~4-3/8")	440	6 / 36	15.2	2.70



## Oil Filter Locking Pliers

Item No.	Capacity	Length	Weight	PCS	G.W.	CUFT
	mm (inch)	mm(inch)	g	inner/ctn	KGS	
AT-OF10A	53~118 (2-1/8~4-5/8")	250 (10")	420	12 / 48	24.0	1.50



## Hose Clamp Drivers

Item No.	Size	Length	Weight	PCS	G.W.	CUFT
	mm	mm	g	inner/ctn	KGS	
596+0146	6	280	150	10 / 60	10.0	1.58
596+0147	7	280	150	10 / 60	10.0	1.58
596+0148	8	280	150	10 / 60	10.0	1.58
596+0150	10	280	150	10 / 60	10.0	1.58



## Magnetic Fender Covers

Item No.	Size	Weight	PCS	G.W.	CUFT
	mm	g	inner/ctn	KGS	
FC-086	800 x 600	680	1 / 30	22.0	1.90
FC-116	1050 x 580	800	1 / 20	17.0	1.85



## Taper Bit Extractors

Item No.	Capacity		Length mm	Weight g	PCS inner/ctn	G.W. KGS	CUFT
	mm	(inch)					
010603	3	(1/8")	60	8	50 / 600	6.0	0.30
010705	5	(3/16")	70	10	50 / 600	7.0	0.30
010756	6	(15/64")	75	20	50 / 600	12.5	0.30
010808	8	(5/16")	80	30	50 / 600	20.0	0.30
010859	9	(3/8")	85	50	30 / 360	18.0	0.30
011012	12	(15/32")	105	70	20 / 240	17.5	0.30
011214	14	(9/16")	125	130	10 / 120	16.5	0.30
011316	16	(21/32")	130	210	5 / 60	13.5	0.30



### AT-EX5 5 Piece Taper Bit Extractor Set

#### Item No. Description

#### Taper Bit Extractor:

010603	3mm (1/8")	010808	8mm (5/16")
010705	5mm (3/16")	010859	9mm (3/8")
010756	6mm (15/64")	Sliding Card	

140 g 20x6 120 sets / 17.5 Kgs / 0.92 CUFT



### AT-EX6 6 Piece Screw Extractor Set

#### Description

#### Screw Extractor:

No.1	1/8" ~ 1/4" (3~6mm)	No.4	7/16" ~ 9/16" (11~14mm)
No.2	1/4" ~ 5/16" (6~8mm)	No.5	9/16" ~ 3/4" (14~19mm)
No.3	5/16" ~ 7/16" (8~11mm)	No.6	3/4" ~ 1" (19~25mm)

Plastic Case

250 g 10x4 40 sets / 11 Kgs / 0.71 CUFT



## T-Handle Spark Plug Sockets

Item No.	Size		Length mm	Weight g	PCS inner/ctn	G.W. KGS	CUFT
	mm	inch					
4238014T	14.0	-	380	400	15 / 30	13.0	1.13
4238016T	16.0	5/8"	380	420	15 / 30	14.0	1.13
4238021T	20.6	13/16"	380	490	15 / 30	16.0	1.13
4253014T	14.0	-	530	460	1 / 15	8.0	0.46
4253016T	16.0	5/8"	530	530	1 / 15	9.0	0.46
4253021T	20.6	13/16"	530	600	1 / 15	10.0	0.46



## 3/8" & 1/2" Dr. Spark Plug Sockets

Item No.	Drive size	Size		D mm	Hex mm	Length mm	Weight g	PCS inner/ctn	G.W. KGS	CUFT
		mm	inch							
326014	3/8"	14.0	-	19	16.0	63	70	10 / 200	16.0	0.60
326016	3/8"	16.0	5/8"	22	19.0	63	100	10 / 200	21.0	0.60
326021	3/8"	20.6	13/16"	28	19.0	63	140	10 / 120	18.0	0.52
427016	1/2"	16.0	5/8"	22	21.0	70	110	10 / 140	16.0	0.44
427021	1/2"	20.6	13/16"	28	21.0	70	160	10 / 120	20.5	0.52



### SP-304A 4 Piece 3/8" Dr. Spark Plug Socket Set

#### Item No. Description

#### 3/8" Dr. Spark Plug Socket:

326016	16.0mm(5/8")
326021	20.6mm(13/16")

#### 3/8" Dr. Accessory:

320150	Extension Bar, 150mmL
383363	Flexible Reversible Ratchet
	Sliding Card

800 g 5x4 20 sets / 17 Kgs / 1.65 CUFT



## Rigid Carbon Scrapers

Item No.	Blade Style	Blade Width	Overall Length	PCS	G.W.	CUFT	
				inner/ctn	KGS		
595212	A	Straight	12mm	250mm	10 / 40	7.5	0.71
595226	B	Straight	26mm	200mm	15 / 120	18.5	1.60
595232	C	Straight	26mm	300mm	15 / 90	18.0	1.58



## Miniature Awls, Hooks & Picks

Item No.	Type	Blade Length	Overall Length	PCS	G.W.	CUFT
				inner/ctn	KGS	
592801	Awl	75mm	150mm	20 / 160	7.5	1.60
592802	Hook	75mm	150mm	20 / 160	7.5	1.60
592803	45° Tip	75mm	150mm	20 / 160	7.5	1.60
592804	90° Tip	75mm	150mm	20 / 160	7.5	1.60

### PK-AHP4 4 Piece Miniature Pick Set

Item No.	Description
592801	Mini-Awl
592802	Mini-Hook
592803	Mini-Bent Tip 45°
592804	Mini-Bent Tip 90°



Sliding Card

 130 g     10x8 80 sets / 11.5 Kgs / 1.8 CUFT

### PK-OSP4 2 Piece O-Ring Oil Seal Pick Set

#### Description

Hook & O-Ring 90° Tip (Double End)  
Bent Tip 90° & Bent Tip 45° (Double End)  
Sliding Card

 35 g     50x6 300 sets / 12.5 Kgs / 2.7 CUFT

## Trim Pad Remover

Item No.	Length	PCS	G.W.	CUFT
	mm (inch)	inner/ctn	KGS	
AT-TPR	230 (9.1")	10 / 40	7.5	0.71

## Brake Spring Pliers

Item No.	Length	PCS	G.W.	CUFT
	mm (inch)	inner/ctn	KGS	
AT-BSP	330 (13")	1 / 48	21.8	1.60

**NEW**

## Air Chuck w/Rubber Handle

ITEM No.	Head Size	Length	Weight	PCS	G.W.	CUFT
	mm	mm	g	inner/ctn	KGS	
2806	8mm	230	180	5 / 50	10.0	1.00

**NEW**

## Tire Pressure Gauge

ITEM No.	Head Size	Pressure	Length	Weight	PCS	G.W.	CUFT
	mm	psi	mm	g	inner/ctn	KGS	
2907	8mm	160	270	190	5 / 50	10.5	0.93





## Heater Hose Clamp Pliers

Item No.	Length mm(inch)	Weight g	PCS		G.W. KGS	CUFT
			inner/ctn			
AT-HC10	220 (8.7")	250	6 / 72		20.0	2.60



Item No.	Length mm(inch)	Weight g	PCS		G.W. KGS	CUFT
			inner/ctn			
AT-HC12	220 (8.7")	250	6 / 72		20.0	2.60



Item No.	Length mm(inch)	Weight g	PCS		G.W. KGS	CUFT
			inner/ctn			
AT-HC14	220 (8.7")	270	6 / 72		20.5	2.60



Item No.	Length mm(inch)	Weight g	PCS		G.W. KGS	CUFT
			inner/ctn			
AT-HC16	230 (9.1")	270	6 / 72		20.5	5.20



## Wheel Balancing Weight Tool

Item No.	Size inch	Length mm	Weight g	PCS		G.W. KGS	CUFT
				inner/ctn			
560425	10"	250	370	10 / 60	23.0	1.83	

- Designed for fitting and removing wheel balancing weights
- Chrome Vanadium Steel
- Phosphatised finish



## 3/4" Dr. Extra Long Budd Wheel Impact Sockets

ITEM NO.	A Size	B mm	C mm	D mm	Length mm	Weight g	PCS	G.W. KGS	CUFT
649833	33mm Hex	48	74	42	230	1600	10	17.0	0.41
669834	1-1/16" Hex	42	74	42	230	1470	10	15.5	0.41
669836	1-1/8" Hex	43	74	42	230	1480	10	16.0	0.41
669840	1-1/4" Hex	47	74	42	230	1500	10	16.0	0.41
669848	1-1/2" Hex	54	74	42	230	1750	10	18.5	0.41
669826S	13/16" Square	43	74	42	230	1500	10	16.0	0.41

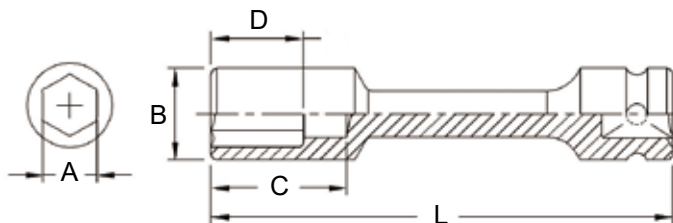

### Cr-Mo Extra Long Impact Sockets

- Designed specifically for the truck industry.
- Extra long sockets are perfect for truck wheels and other hard to reach applications.
- Eliminating the need for extension bars reduces torque loss, as well as saving your time and money.

## 1/2" Drive Torque Sockets

ITEM NO.	Color	Wrench Size	Torque Limit	Length mm	Weight g	PCS	G.W. KGS	CUFT
417M055		17mm Hex	55 ft.lbs. (75Nm)	206	260	50	13.5	0.80
417M080		17mm Hex	80 ft.lbs. (108Nm)	206	290	50	15.0	0.80
419M065		19mm Hex (3/4")	65 ft.lbs. (88Nm)	206	310	50	15.5	0.80
419M080		19mm Hex (3/4")	80 ft.lbs. (108Nm)	206	340	50	18.0	0.80
419M100		19mm Hex (3/4")	100 ft.lbs. (135Nm)	206	360	50	18.0	0.80
421M060		21mm Hex	60 ft.lbs. (81Nm)	206	310	50	16.0	0.80
421M080		21mm Hex	80 ft.lbs. (108Nm)	206	340	50	17.0	0.80
421M147D		21mm Hex	147 ft.lbs. (200Nm)	220	450	50	23.5	0.80
422M120D		22mm Hex	120 ft.lbs. (163Nm)	220	420	50	22.0	0.80
422M140D		22mm Hex	140 ft.lbs. (190Nm)	220	440	50	23.0	0.80
426S100		13/16" Hex	100 ft.lbs. (135Nm)	206	380	50	19.0	0.80
430S140D		15/16" Hex	140 ft.lbs. (190Nm)	220	470	50	26.0	0.80
434S140D		1-1/16" Hex	140 ft.lbs. (190Nm)	220	490	50	27.5	0.80

## 1" Drive Torque Sockets

ITEM NO.	Color	Wrench Size	Torque Limit	Length mm	Weight g	PCS	G.W. KGS	CUFT
824M350		24mm Hex (5/16")	350 ft.lbs. (475Nm)	305	1420	12	18.0	0.70
827M450		27mm Hex (1-1/16")	450 ft.lbs. (610Nm)	305	1580	12	20.0	0.70
830M550		30mm Hex (1-3/16")	550 ft.lbs. (745Nm)	305	1780	12	22.5	0.70
832M600		32mm Hex (1-1/4")	600 ft.lbs. (813Nm)	305	2040	12	25.5	0.70
832M650		32mm Hex (1-1/4")	650 ft.lbs. (881Nm)	305	2120	12	26.5	0.70
833M600		33mm Hex	600 ft.lbs. (813Nm)	305	2000	12	25.0	0.70
833M650		33mm Hex	650 ft.lbs. (881Nm)	305	2080	12	26.0	0.70
836M650		36mm Hex	650 ft.lbs. (881Nm)	305	2080	12	26.0	0.70
841M400		41mm Hex (1-5/8")	400 ft.lbs. (542Nm)	305	1700	12	21.5	0.70
841M650		41mm Hex (1-5/8")	650 ft.lbs. (881Nm)	305	2250	12	28.0	0.70
826S475		13/16" Square	475 ft. lbs. (644Nm)	305	1890	12	23.5	0.70
834S200		1-1/16" Hex (27mm)	200 ft. lbs. (271Nm)	305	1360	12	17.5	0.70
834S300		1-1/16" Hex (27mm)	300 ft. lbs. (407Nm)	305	1470	12	18.5	0.70
838S300		1-3/16" Hex (30mm)	300 ft. lbs. (407Nm)	305	1540	12	19.5	0.70
838S400		1-3/16" Hex (30mm)	400 ft. lbs. (542Nm)	305	1660	12	21.0	0.70
840S250		1-1/4" Hex (32mm)	250 ft. lbs. (339Nm)	305	1490	12	19.0	0.70
842S325		1-5/16" Hex	325 ft. lbs. (441Nm)	305	1530	12	19.5	0.70
842S475		1-5/16" Hex	475 ft. lbs. (644Nm)	305	1840	12	23.0	0.70
848S475		1-1/2" Hex (38mm)	475 ft. lbs. (644Nm)	305	1870	12	23.5	0.70
848S525		1-1/2" Hex (38mm)	525 ft. lbs. (712Nm)	305	1920	12	24.0	0.70

## TO-407M 7 Piece 1/2" Dr. Metric Car Wheel Torque Socket Set

Item No.	Color	Wrench Size	Description
<b>1/2" Dr. Wheel Torque Socket:</b>			
417M055		17mm Hex	55 ft. lbs. (75 Nm)
417M080		17mm Hex	80 ft. lbs. (108 Nm)
419M065		19mm Hex (3/4")	65 ft. lbs. (88 Nm)
419M080		19mm Hex (3/4")	80 ft. lbs. (108 Nm)
419M100		19mm Hex (3/4")	100 ft. lbs. (135 Nm)
421M060		21mm Hex	60 ft. lbs. (81 Nm)
421M080		21mm Hex	80 ft. lbs. (108 Nm)

Blow Case

3000 g



5 sets / 16 Kgs / 1.65 CUFT



# Wheel Torque Tools

## TO-408S 8 Piece 1/2" Dr. Metric & SAE Car Wheel Torque Socket Set



Item No.	Color	Wrench Size	Description
<b>1/2" Dr. Wheel Torque Socket:</b>			
417M055	Green	17mm Hex	55 ft. lbs. (75 Nm)
417M080	Red	17mm Hex	80 ft. lbs. (108 Nm)
419M065	Yellow	19mm Hex (3/4")	65 ft. lbs. (88 Nm)
419M080	Blue	19mm Hex (3/4")	80 ft. lbs. (108 Nm)
419M100	Grey	19mm Hex (3/4")	100 ft. lbs. (135 Nm)
421M060	Black	21mm Hex	60 ft. lbs. (81 Nm)
421M080	Orange	21mm Hex	80 ft. lbs. (108 Nm)
426S100	Brown	13/16" Hex	100 ft. lbs. (135 Nm)

Blow Case  
 3500 g       5 sets / 18.5 Kgs / 1.65 CUFT



## TO-410M 10 Piece 1/2" Dr. Metric Car Wheel Torque Socket Set

Item No.	Color	Wrench Size	Description
<b>1/2" Dr. 6-Point Metric Wall Deep Impact Socket:</b>			
448517W	Yellow	17mm - With Yellow Plastic Sleeve	
448519W	Red	19mm(3/4") - With Red Plastic Sleeve	
448521W	Orange	21mm - With Orange Plastic Sleeve	
<b>1/2" Dr. Wheel Torque Socket:</b>			
417M055	Green	17mm Hex	55 ft. lbs. (75 Nm)
421M060	Black	21mm Hex	60 ft. lbs. (81 Nm)
419M065	Yellow	19mm Hex (3/4")	65 ft. lbs. (88 Nm)
417M080	Red	17mm Hex	80 ft. lbs. (108 Nm)
419M080	Blue	19mm Hex (3/4")	80 ft. lbs. (108 Nm)
421M080	Orange	21mm Hex	80 ft. lbs. (108 Nm)
419M100	Grey	19mm Hex (3/4")	100 ft. lbs. (135 Nm)

Blow Case  
 3750 g       4 sets / 16 Kgs / 1.65 CUFT













## TO-412MS 12 Piece 1/2" Dr. Metric & SAE Car Wheel Torque Socket Set

Item No.	Color	Wrench Size	Description
<b>1/2" Dr. 6-Point Metric Wall Deep Impact Socket:</b>			
448517W	Yellow	17mm - With Yellow Plastic Sleeve	
448519W	Red	19mm(3/4") - With Red Plastic Sleeve	
448521W	Orange	21mm - With Orange Plastic Sleeve	
<b>1/2" Dr. 6-Point SAE Thin Wall Deep Impact Socket:</b>			
468526W	Blue	13/16" - With Blue Plastic Sleeve	
<b>1/2" Dr. Metric Wheel Torque Socket:</b>			
417M055	Green	17mm Hex	55 ft. lbs. (75 Nm)
421M060	Black	21mm Hex	60 ft. lbs. (81 Nm)
419M065	Yellow	19mm Hex (3/4")	65 ft. lbs. (88 Nm)
417M080	Red	17mm Hex	80 ft. lbs. (108 Nm)
419M080	Blue	19mm Hex (3/4")	80 ft. lbs. (108 Nm)
421M080	Orange	21mm Hex	80 ft. lbs. (108 Nm)
419M100	Grey	19mm Hex (3/4")	100 ft. lbs. (135 Nm)
<b>1/2" Dr. SAE Wheel Torque Socket:</b>			
426S100	Brown	13/16" Hex	100 ft. lbs. (135 Nm)









Blow Case  
 4350 g       4 sets / 18.5 Kgs / 1.65 CUFT



## Torque Extensions

ITEM NO.	Color	Square Dr. Inch	Torque Limit	Length mm	Weight g	PCS 	G.W. KGS	CUFT 
487065		1/2	65 ft.lbs. (90Nm)	180	170	50	9.5	0.80
487075		1/2	75 ft.lbs. (100Nm)	180	180	50	10.0	0.80
487080		1/2	80 ft.lbs. (110Nm)	180	190	50	10.5	0.80
487090		1/2	90 ft.lbs. (120Nm)	180	200	50	11.0	0.80
487100		1/2	100 ft.lbs. (135Nm)	180	210	50	11.5	0.80
487110		1/2	110 ft.lbs. (150Nm)	180	220	50	12.0	0.80
487120		1/2	120 ft.lbs. (160Nm)	180	230	50	12.5	0.80
487130		1/2	130 ft.lbs. (175Nm)	180	240	50	13.0	0.80
487140		1/2	140 ft.lbs. (190Nm)	180	250	50	13.5	0.80
487150		1/2	150 ft.lbs. (200Nm)	180	260	50	14.5	0.80
687175		3/4	175 ft.lbs. (240Nm)	180	480	20	10.5	0.59
687250		3/4	250 ft.lbs. (340Nm)	180	550	20	12.0	0.59
687350		3/4	350 ft.lbs. (475Nm)	180	680	20	14.5	0.59
687475		3/4	475 ft.lbs. (645Nm)	180	1080	20	22.5	0.59
887250		1	250 ft. lbs. (340Nm)	254	1050	10	11.5	0.62
887350		1	350 ft. lbs. (475Nm)	254	1140	10	12.5	0.62
887475		1	475 ft. lbs. (645Nm)	254	1280	10	14.0	0.62
887650		1	650 ft. lbs. (880Nm)	254	1470	10	15.5	0.62





### TO-410EXT 10 Piece 1/2" Dr. Torque Extension Bar Set



Item No.	Color	Description
487065		65 ft. lbs. (90 Nm)
487075		75 ft. lbs. (100 Nm)
487080		80 ft. lbs. (110 Nm)
487090		90 ft. lbs. (120 Nm)
487100		100 ft. lbs. (135 Nm)
487110		110 ft. lbs. (150 Nm)
487120		120 ft. lbs. (160 Nm)
487130		130 ft. lbs. (175 Nm)
487140		140 ft. lbs. (190 Nm)
487150		150 ft. lbs. (200 Nm)

Blow Case  
 3250 g       4 sets / 14 Kgs / 1.07 CUFT



### TO-405EXT 5 Piece 1/2" Dr. Torque Extension Bar Set

Item No.	Color	Description
487065		65 ft. lbs. (90 Nm)
487080		80 ft. lbs. (110 Nm)
487100		100 ft. lbs. (135 Nm)
487120		120 ft. lbs. (160 Nm)
487140		140 ft. lbs. (190 Nm)

Blow Case  
 1500 g       8 sets / 13 Kgs / 0.88 CUFT



#### Torque Extension Bars:

- Torque Extensions are designed for 1/2" Dr. impact wrench rated 380-420 ft.lb.; 3/4" Dr. impact wrench rated 750 ft.lb.; 1" Dr. impact wrench rated 1,500 ft.lb.
- The various drive sizes and torque limits allow use of any impact socket with a torque extension to match the different lug nut sizes found on vehicles.
- Helps prevent over-torquing of wheel nuts and can minimize wheel distortion.
- The unique design allows the length and diameter of the torque extension shaft to flex with each blow of the impact wrench once the specified torque is reached.
- Accurate to within 4%.

# Wheel Torque Tools

## 1/2" Dr. Thin Wall Deep Impact Sockets with Plastic Sleeves

ITEM NO.	Color	Description Size	Length mm	Weight g	PCS inner/ctn	G.W. KGS	CUFT
448517W		17mm - With Yellow Plastic Sleeve	86	190	10 / 120	24.0	0.52
448519W		19mm (3/4") - With Red Plastic Sleeve	86	200	10 / 120	25.0	0.52
448521W		21mm - With Orange Plastic Sleeve	86	250	10 / 60	16.5	0.45
468526W		13/16" - With Blue Plastic Sleeve	86	250	10 / 60	16.5	0.45

### Features:

- Thin Wall Deep Impact Sockets are designed to allow easy access to recessed wheel nuts where space is limited.
- Changeable plastic sleeves.
- With additional outside plastic sleeve to protect the rims when screwing the wheel nuts/screws.
- Special design for American, European and Japanese cars.

## CW-404MS 4 Piece 1/2" Dr. Metric & SAE Thin Wall Impact Socket Set

Item No.	Size	Item No.	Size
<b>1/2" Dr. 6pt Thin Wall Impact Socket w/ plastic Sleeve:</b>			
448517W	17mm	448521W	21mm
448519W	19mm	468526W	13/16"
Plastic Tray			
1200 g	10 sets / 13 Kgs / 0.93 CUFT		



(192W x 203D)



## CW-406M 6 Piece 1/2" Dr. Metric Car Wheel COLOUR MATCH® Set

Item No.	Size	Item No.	Size
<b>1/2" Dr. 6pt Thin Wall Impact Socket w/ plastic Sleeve:</b>			
448517W	17mm	448521W	21mm
448519W	19mm		
<b>1/2" Dr. Torque Extension Bar:</b>			
487080	80 ft.lbs. (110 Nm)		
487090	90 ft.lbs. (120 Nm)		
487110	110 ft.lbs. (150 Nm)		
Plastic Tray			
1500 g	10 sets / 16 Kgs / 0.93 CUFT		



(192W x 203D)



## CW-408MS 8 Piece 1/2" Dr. Metric & SAE Car Wheel COLOUR MATCH® Set

Item No.	Size	Item No.	Size
<b>1/2" Dr. 6pt Thin Wall Impact Socket w/ plastic Sleeve:</b>			
448517W	17mm	448521W	21mm
448519W	19mm	468526W	13/16"
<b>1/2" Dr. Torque Extension Bar:</b>			
487080	80 ft.lbs. (110 Nm)		
487090	90 ft.lbs. (120 Nm)		
487100	100 ft.lbs. (135 Nm)		
487110	110 ft.lbs. (150 Nm)		
Plastic Tray			
2200 g	5 sets / 12 Kgs / 0.93 CUFT		

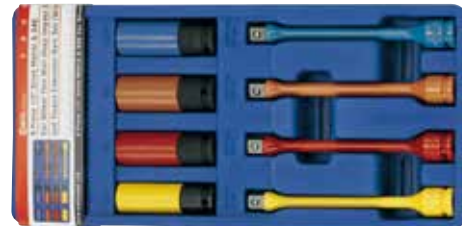

(192W x 406D)



## CW-403M 3 Piece Metric Car Wheel Thin Wall Deep Impact Socket Set

Item No.	Size	Item No.	Size
<b>1/2" Dr. 6pt Thin Wall Impact Socket w/ plastic Sleeve:</b>			
448517W	17mm	448521W	21mm
448519W	19mm		
Blow Case			
800 g	30 sets / 26 Kgs / 1.39 CUFT		



# Truck Wheel Sockets

## 3/4" Dr. Metric Budd Wheel Impact Sockets

ITEM NO.	A Square	D1 mm	D2 mm	Length mm	Weight g	PCS inner/ctn	G.W. KGS	CUFT
649517S	17mm	34	40	90	530	1 / 30	17.0	0.52
649519S	19mm	38	40	90	580	1 / 30	18.5	0.52
649520S	20mm	40	40	90	620	1 / 30	19.5	0.52
649521S	21mm	40	40	90	630	1 / 30	20.0	0.52



## 3/4" Dr. SAE Budd Wheel Impact Sockets

ITEM NO.	A Square	D1 mm	D2 mm	Length mm	Weight g	PCS inner/ctn	G.W. KGS	CUFT
669522S	11/16"	34	40	90	530	1 / 30	17.0	0.52
669524S	3/4"	38	40	90	580	1 / 30	18.5	0.52
669526S	13/16"	40	40	90	620	1 / 30	20.0	0.52

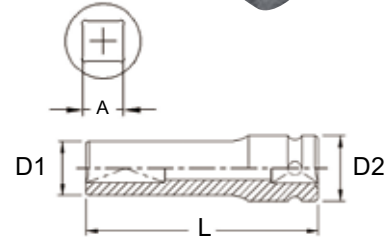

## CD-608M4 3/4" Dr. 8 Piece Metric Budd Wheel Impact Socket Set

Previous Item No.: CM-608M4

Item No.	Size	Item No.	Size
<b>3/4" Dr. 6p Deep Impact Socket:</b>			
649527	27mm	649535	35mm
649530	30mm	649538	38mm
649532	32mm	649541	41mm
<b>3/4" Dr. Budd Wheel Impact Socket:</b>			
649519S	19mm	649521S	21mm

Metal Box  
 6500 g 4 sets / 27 Kgs / 0.62 CUFT



## CD-608S4 3/4" Dr. 8 Piece SAE Budd Wheel Impact Socket Set

Previous Item No.: CM-608S4

Item No.	Size	Item No.	Size
<b>3/4" Dr. 6p Deep Impact Socket:</b>			
669534	1-1/16"	669540	1-1/4"
669536	1-1/8"	669544	1-3/8"
669538	1-3/16"	669548	1-1/2"
<b>3/4" Dr. Budd Wheel Impact Socket:</b>			
669524S	3/4"	669526S	13/16"

Metal Box  
 6500 g 4 sets / 27 Kgs / 0.62 CUFT



## TR-611MS 3/4" Dr. 11 Piece Metric & SAE Budd Wheel Impact Socket Set

Item No.	Size	Item No.	Size
<b>3/4" Dr. 6pt Deep Impact Socket:</b>			
649533	33mm	649538	38mm
649535	35mm	649541	41mm
<b>3/4" Dr. 6pt Deep Thin Wall Impact Socket:</b>			
669534T	1-1/16"	669540T	1-1/4"
669536T	1-1/8"		
<b>3/4" Dr. Budd Wheel Impact Socket:</b>			
649517S	17mm	669526S	13/16"
649521S	21mm		
<b>3/4" Dr. Deep Budd Wheel Impact Socket:</b>			
669548B	1-1/2"		

Blow Case  
 8550 g 2 sets / 18 Kgs / 0.95 CUFT



# Truck Wheel Sockets

## SAE Deep Budd Wheel Impact Sockets

Item No.	Drive	A	D1	D2	Length	Weight	PCS	G.W.	CUFT
		inch	mm	mm	mm	g	inner/ctn	KGS	
669548B	3/4"	1-1/2	56	44	105	1020	1 / 10	11.5	0.31
869548B	1"	1-1/2	58	52	105	1150	1 / 10	13.0	0.31

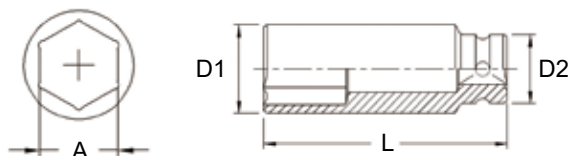

## 1" Dr. Metric Budd Wheel Impact Sockets

ITEM NO.	A	D1	D2	Length	Weight	PCS	G.W.	CUFT
	Square	mm	mm	mm	g	inner/ctn	KGS	
846017S	17mm	40	50	60	510	1 / 30	16.5	0.38
846019S	19mm	42	50	60	530	1 / 30	17.0	0.38
846020S	20mm	43	50	60	530	1 / 30	17.0	0.38
846021S	21mm	44	50	60	530	1 / 30	17.0	0.38
847617S	17mm	37	50	76	550	1 / 30	17.5	0.52
847619S	19mm	43	50	76	630	1 / 30	20.0	0.52
847621S	21mm	47	50	76	680	1 / 30	21.5	0.52
849517S	17mm	40	50	90	780	1 / 20	17.0	0.34
849519S	19mm	42	50	90	850	1 / 20	18.0	0.34
849520S	20mm	43	50	90	850	1 / 20	18.0	0.34
849521S	21mm	44	50	90	900	1 / 20	19.0	0.34
849522S	22mm	46	50	90	900	1 / 20	19.0	0.34



## 1" Dr. SAE Budd Wheel Sockets

ITEM NO.	A	D1	D2	Length	Weight	PCS	G.W.	CUFT
	Square	mm	mm	mm	g	inner/ctn	KGS	
866024S	3/4"	42	50	60	530	1 / 30	17.0	0.38
866026S	13/16"	44	50	60	530	1 / 30	17.0	0.38
866030S	15/16"	48	50	60	580	1 / 30	18.5	0.38
867624S	3/4"	43	50	76	630	1 / 30	17.5	0.52
867626S	13/16"	47	50	76	680	1 / 30	20.0	0.52
869522S	11/16"	40	50	90	780	1 / 20	17.0	0.34
869524S	3/4"	42	50	90	850	1 / 20	18.0	0.34
869526S	13/16"	44	50	90	900	1 / 20	19.0	0.34

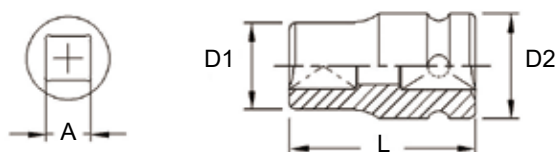

## 1" Dr. Dual Budd Wheel Sockets

ITEM NO.	A	B	D1	D2	Length	Weight	PCS	G.W.	CUFT
	Hex	Square	mm	mm	mm	g	inner/ctn	KGS	
849035B	35mm	17mm	52	52	90	940	1 / 10	10.5	0.31
849038B	38mm	20mm	55	52	90	970	1 / 10	11.0	0.31
849041B	41mm	21mm	58	52	90	1030	1 / 10	11.5	0.31
869048B	1-1/2"	13/16"	55	52	90	970	1 / 10	11.0	0.31

- Incorporating both Hex and Budd Sockets in one. Designed to be used on a trucks rear wheel.

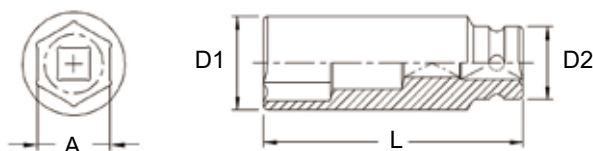

# Truck Wheel Socket Sets

## TR-811M 11 Piece 1" Dr. Metric Truck Wheel Impact Socket Set

Item No.	Size	Item No.	Size
<b>1" Dr. 6pt Impact Socket:</b>			
847027	27mm	847032	32mm
847030	30mm		
<b>1" Dr. 6pt Deep Impact Socket:</b>			
849533	33mm	849538	38mm
849535	35mm	849541	41mm
849536	36mm		
<b>1" Dr. Budd Wheel Impact Socket:</b>			
846017S	17mm	846021S	21mm
846020S	20mm		Blow Case
9350 g		2 sets / 20 Kgs / 0.95 CUFT	



## TR-811S 11 Piece 1" Dr. SAE Truck Wheel Impact Socket Set

Item No.	Size	Item No.	Size
<b>1" Dr. 6pt Impact Socket:</b>			
867028	7/8"	867032	1"
867030	15/16"	867038	1-3/16"
<b>1" Dr. 6pt Deep Impact Socket:</b>			
869556	1-3/4"		
<b>1" Dr. 6pt Deep Thin Wall Impact Socket:</b>			
869534T	1-1/16"	869540T	1-1/4"
869536T	1-1/8"		
<b>1" Dr. Budd Wheel Impact Socket:</b>			
866026S	13/16"	866030S	15/16"
<b>1" Dr. Deep Budd Wheel Impact Socket:</b>			
869548B	1-1/2"		Blow Case
8650 g		2 sets / 18.5 Kgs / 0.95 CUFT	



## TR-811MS 11 Piece 1" Dr. Metric & SAE Truck Wheel Impact Socket Set

Item No.	Size	Item No.	Size
<b>1" Dr. 6pt Deep Impact Socket:</b>			
849533	33mm	849538	38mm
849535	35mm	849541	41mm
<b>1" Dr. Deep Budd Wheel Impact Socket:</b>			
869548B	1-1/2"		
<b>1" Dr. 6pt Deep Thin Wall Impact Socket:</b>			
869534T	1-1/16"	869540T	1-1/4"
869536T	1-1/8"		
<b>1" Dr. Budd Wheel Impact Socket:</b>			
846017S	17mm	866026S	13/16"
846021S	21mm		Blow Case
9900 g		2 sets / 21 Kgs / 0.95 CUFT	



- These 1" & 3/4" Dr. impact socket sets designed for servicing truck wheels.
- The most popular SAE and Metric impact socket sizes for truck wheel fasteners.
- 4-Point impact sockets for inner Budd-style square fasteners on truck wheels.
- Special 1-1/2" Hex deep impact socket designed for outer cap nuts on Budd-style truck wheels.
- Deep Thin Wall impact sockets designed for truck wheel servicing when removing Dayton Style Lug Nuts that are deeply recessed and where space is very limited.
- Metric impact socket set for servicing tires and wheels on a complete range of European and Japanese trucks with metric wheel fasteners.

Made of Chrome Molybdenum Steel



# Truck Wheel Sockets

## #5 Spline Dr. Metric Budd Wheel Impact Sockets

ITEM NO.	A	D1	D2	Length	Weight	PCS	G.W.	CUFT
	Square	mm	mm	mm	g	inner/ctn	KGS	
546017S	17mm	40	60	70	750	1 / 24	19.0	0.44
546019S	19mm	42	60	70	750	1 / 24	19.0	0.44
546020S	20mm	43	60	70	760	1 / 24	19.0	0.44
546021S	21mm	44	60	70	760	1 / 24	19.0	0.44



## #5 Spline Dr. SAE Budd Wheel Impact Sockets

ITEM NO.	A	D1	D2	Length	Weight	PCS	G.W.	CUFT
	Square	mm	mm	mm	g	inner/ctn	KGS	
566024S	3/4"	42	60	70	750	1 / 24	19.0	0.44
566026S	13/16"	44	60	70	850	1 / 24	19.5	0.44
566030S	15/16"	48	60	75	890	1 / 24	20.0	0.44

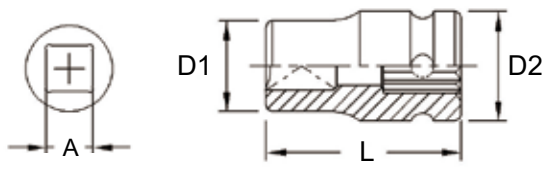

## TR-511S 11 Piece #5 Spline Dr. SAE Truck Wheel Impact Socket Set

Item No.	Size	Item No.	Size
<b>#5 Spline Dr. Budd Wheel Impact Socket:</b>			
566026S	13/16"	566030S	15/16"
<b>#5 Spline Dr. Deep Budd Wheel Impact Socket:</b>			
569548B	1-1/2"		
<b>#5 Spline Dr. 6pt Impact Socket:</b>			
567028	7/8"	567032	1"
567030	15/16"	567038	1-3/16"
<b>#5 Spline Dr. 6pt Deep Impact Socket:</b>			
569556	1-3/4"		
<b>#5 Spline Dr. 6pt Deep Thin Wall Impact Socket:</b>			
569534T	1-1/16"	569540T	1-1/4"
569536T	1-1/8"	Blow Case	

11 Kg      2 sets / 22.5 Kgs / 0.95 CUFT



## TR-511MS 11 Piece #5 Spline Dr. Metric & SAE Truck Wheel Impact Socket Set

Item No.	Size	Item No.	Size
<b>#5 Spline Dr. Budd Wheel Impact Socket:</b>			
546017S	17mm	566026S	13/16"
546021S	21mm		
<b>#5 Spline Dr. Deep Budd Wheel Impact Socket:</b>			
569548B	1-1/2"		
<b>#5 Spline Dr. 6pt Deep Impact Socket:</b>			
549533	33mm	549538	38mm
549535	35mm	549541	41mm
<b>#5 Spline Dr. 6pt Deep Thin Wall Impact Socket:</b>			
569534T	1-1/16"	569540T	1-1/4"
569536T	1-1/8"	Blow Case	

12 Kg      2 sets / 24.5 Kgs / 0.95 CUFT



Automotive Tools

# Wheel Impact Sockets & Stud Bolt Sockets

## 1/2" Dr. Flip Sockets

ITEM NO.	Drive Square	Hex A	Hex B	Length mm	Weight g	PCS inner/ctn	G.W. KGS	CUFT
41651921	1/2"	19mm	21mm	65	220	10 / 120	27.0	0.52
41601719	1/2"	17mm	19mm	60	180	10 / 120	22.5	0.52
49652426	1/2"	3/4"	13/16"	65	220	10 / 120	27.0	0.52
49602224	1/2"	11/16"	3/4"	60	180	10 / 120	22.5	0.52

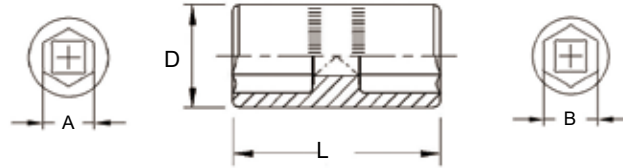

## FD-410M 9 Piece 1/2" Dr. Metric Wheel Impact Socket Set

Item No.	Size	Item No.	Size
<b>1/2" Dr. 6pt Impact Socket (CR-V):</b>			
413813	13mm	413819	19mm
413814	14mm	413821	21mm
413817	17mm	413824	24mm
<b>1/2" Dr. 6pt Deep Impact Socket (CR-V):</b>			
417817	17mm	417821	21mm
417819	19mm	Sliding Card	



1500 g 10 sets / 16 Kgs / 0.71 CUFT

## 3/8" Dr. Stud Bolt Sockets

ITEM NO.	Size mm	A mm	B mm	D1 mm	D2 mm	Length mm	Weight g	PCS inner/ctn	G.W. KGS	CUFT
306100	M6 x 1.00	6.4	5.2	12.0	19	40	65	10 / 200	14.0	0.60
308125	M8 x 1.25	8.4	6.9	14.5	19	40	65	10 / 200	14.0	0.60
310125	M10 x 1.25	10.4	8.9	17.0	19	46	75	10 / 200	16.0	0.60
310150	M10 x 1.50	10.4	8.6	17.0	19	46	75	10 / 200	16.0	0.60

## 1/2" Dr. Stud Bolt Sockets

ITEM NO.	Size mm	A mm	B mm	D1 mm	D2 mm	Length mm	Weight g	PCS inner/ctn	G.W. KGS	CUFT
406100	M6 x 1.00	6.4	5.2	12.0	24	52	120	10 / 140	18.0	0.44
408100	M8 x 1.00	8.4	7.0	14.5	24	52	130	10 / 140	19.5	0.44
408125	M8 x 1.25	8.4	6.9	14.5	24	52	130	10 / 140	19.5	0.44
410100	M10 x 1.00	10.4	9.0	17.0	24	52	140	10 / 140	20.5	0.44
410125	M10 x 1.25	10.4	8.9	17.0	24	52	140	10 / 140	20.5	0.44
410150	M10 x 1.50	10.4	8.6	17.0	24	52	140	10 / 140	20.5	0.44
412125	M12 x 1.25	12.4	10.9	24.0	24	52	140	10 / 140	20.5	0.44
412150	M12 x 1.50	12.4	10.6	24.0	24	52	140	10 / 140	20.5	0.44
412175	M12 x 1.75	12.4	10.4	24.0	24	52	140	10 / 140	20.5	0.44
414150	M14 x 1.50	14.5	12.5	26.0	26	60	190	10 / 120	24.0	0.52
414200	M14 x 2.00	14.5	12.5	26.0	26	60	220	10 / 120	27.5	0.52
416150	M16 x 1.50	16.5	12.0	26.0	26	75	190	10 / 120	24.0	0.52
416200	M16 x 2.00	16.5	14.5	26.0	26	75	220	10 / 120	27.5	0.52

### Features:

- Allows for "turn back" free fastening and unfastening of stud bolts.
- Applications include engine assembly lines and auto repair shops.

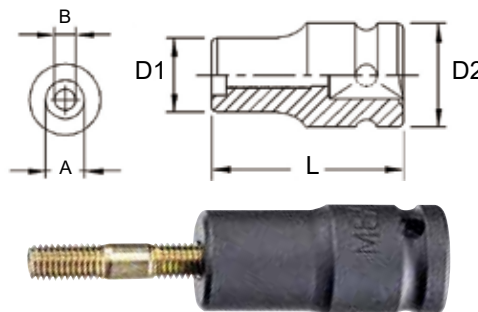
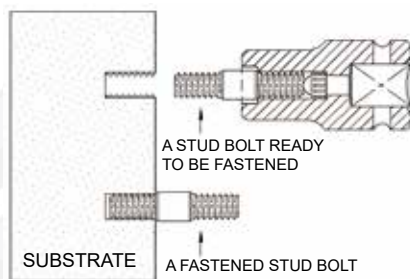

Made of Chrome Vanadium Steel

# Stud Remover Sockets

## 1/2" Dr. Metric Stud Remover Sockets

ITEM NO.	A	D1	D2	Length	Weight	PCS	G.W.	CUFT
	mm	mm	mm	mm	g	inner/ctn	KGS	
426306	6	24	21	63	150	10 / 150	24.0	0.69
426308	8	24	21	63	150	10 / 150	24.0	0.69
427410	10	28	21	74	220	10 / 120	26.0	0.52
427412	12	28	21	74	220	10 / 120	27.0	0.52
427413	13	28	21	74	220	10 / 60	14.0	0.45
427414	14	34	24	74	320	10 / 60	21.0	0.45
427416	16	34	24	74	320	10 / 60	21.0	0.45

## 1/2" Dr. SAE Stud Remover Sockets

ITEM NO.	A	D1	D2	Length	Weight	PCS	G.W.	CUFT
	inch	mm	mm	mm	g	inner/ctn	KGS	
486308	1/4	24	21	63	150	10 / 150	24.0	0.69
486310	5/16	24	21	63	150	10 / 150	24.0	0.69
487412	3/8	28	21	74	220	10 / 120	26.0	0.52
487414	7/16	28	21	74	220	10 / 120	27.0	0.52
487416	1/2	28	21	74	220	10 / 60	14.0	0.45
487418	9/16	34	24	74	320	10 / 60	21.0	0.45
487420	5/8	34	24	74	320	10 / 60	21.0	0.45



USAGE AS SHOWN BELOW

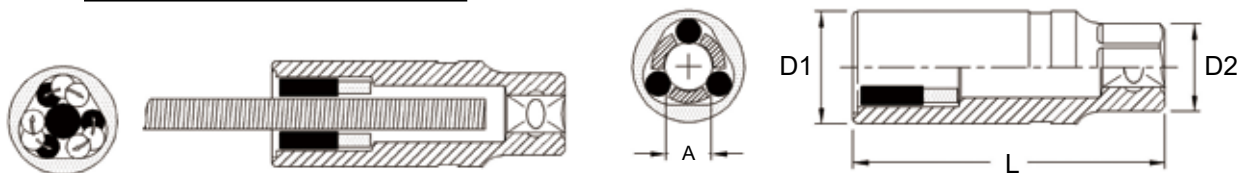

## FD-404M 4 Piece 1/2" Dr. Metric Stud Remover Socket Set

Item No. Size Item No. Size

1/2" Dr. Stud Remover Socket:

426306 6mm 427410 10mm

426308 8mm 427412 12mm

Metal Box

 1050 g

 20 sets / 22 Kgs / 0.67 CUFT



## FD-404 4 Piece 1/2" Dr. SAE Stud Remover Socket Set

Item No. Size Item No. Size

1/2" Dr. Stud Remover Socket:

486308 1/4" 487412 3/8"

486310 5/16" 487414 7/16"

Metal Box

 1050 g

 20 sets / 22 Kgs / 0.67 CUFT



# GENIUS®



*Miscellaneous &  
Repair Parts*



**GENIUS TOOLS**  
[www.geniustools.net](http://www.geniustools.net)

# Miscellaneous

## Magnetic Parts Trays



ITEM No.	Description	Weight g	PCS 	G.W. KGS	CUFT 
001036	Single - 150D x 40H	360	30	13.0	1.50
002034	Double - 237L x 137W x 40H	710	20	16.0	1.40
003047	Triple - 360L x 160W x 40H	1130	12	15.0	1.50
004048	Quad - 295L x 275W x 40H	1420	10	16.6	1.80

### Features:

- Permanent magnet with heavy duty rubber scratch guard.
- Fully magnetized tray holds small parts and tools.
- Can be attached to any metal surface - horizontally, vertically or even upside down.





## Socket Rails with Clips

ITEM No.	Drive Size	Length mm	Clips pcs	Pack pcs	Weight g	PCS 	G.W. KGS	CUFT 
010152	1/4"	410	15	2	230	30	8.0	0.40
010153	3/8"	480	15	2	270	20	6.5	0.46
010154	1/2"	560	15	2	350	10	4.5	0.32
010156	3/4"	560	10	2	400	5	3.0	0.32



## Magnetic Bar Tool Holders



ITEM No.	Length mm (inch)	Weight g	PCS 	G.W. KGS	CUFT 
005012	300 (12")	870	30	26.0	0.80
005016	400 (16")	1100	25	27.5	0.90
005024	600 (24")	1620	16	26.5	0.90

### Features:

- Magnet holds tools for easy access.
- Holds miscellaneous tools.





## Plastic Socket Holders

ITEM No.	Size	Weight g	PCS 	G.W. KGS	CUFT 
001002	1/4"	4	1000	4.5	0.40
001003	3/8"	4	1000	5.0	0.40
001004	1/2"	5	1000	6.0	0.60
001006	3/4"	10	500	6.2	0.77



## Master Socket Trays

ITEM No.	Drive Size	Dimension mm	Pin pcs	Size Range	Weight g	PCS 	G.W. KGS	CUFT 
010228M	1/4"	232x55x62	14x2	4~15mm	65	120	9.1	2.1
010226S	1/4"	232x55x62	13x2	1/8~5/8"	65	120	9.1	2.1
010330M	3/8"	337x76x77	15x2	6~20mm	145	60	9.7	2.6
010326S	3/8"	337x76x77	13x2	1/4~1"	145	60	9.7	2.6
010434M	1/2"	523x88x95	17x2	10~27mm	285	48	14.4	4.4
010428S	1/2"	458x102x95	14x2	3/8~1-1/4"	265	48	13.2	4.4

- Store and organize 1/4, 3/8 and 1/2" drive sockets.
- Each rack holds both standard and deep sockets.
- Quick to read size markers on pin tops.
- Durable plastic rack and sturdy, break resistant pin.
- Color coded with red for SAE labels and blue for Metric.

**NEW**



- 1/4" Dr. Metric : 4, 4.5, 5, 5.5, 6, 7, 8, 9, 10, 11, 12, 13, 14, 15mm
- 1/4" Dr. SAE : 1/8, 5/32, 3/16, 7/32, 1/4, 9/32, 5/16, 11/32, 3/8, 7/16, 1/2, 9/16, 5/8"
- 3/8" Dr. Metric : 6, 7, 8, 9, 10, 11, 12, 13, 14, 15, 16, 17, 18, 19, 20mm
- 3/8" Dr. SAE : 1/4, 5/16, 3/8, 7/16, 1/2, 9/16, 5/8, 11/16, 3/4, 13/16, 7/8, 15/16, 1"
- 1/2" Dr. Metric : 10, 11, 12, 13, 14, 15, 16, 17, 18, 19, 20, 21, 22, 23, 24, 25, 27mm
- 1/2" Dr. SAE : 3/8, 7/16, 1/2, 9/16, 5/8, 11/16, 3/4, 13/16, 7/8, 15/16, 1", 1-1/16, 1-1/8, 1-1/4"

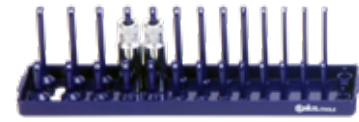

010228M



010330M



010434M



010226S



010326S



010428S

## Hinged Mirrors

ITEM No.	Description	Weight g	PCS inner/ctn	G.W. KGS	CUFT
AT-RM15	52mm x 90mm	180	24 / 96	18.0	2.00

ITEM No.	Description	Weight g	PCS inner/ctn	G.W. KGS	CUFT
AT-RM14	50mm Diameter	140	24 / 96	15.0	2.00

## Magnetic Pick-Up Tools

ITEM No.	Length mm (inch)	Weight g	PCS inner/ctn	G.W. KGS	CUFT
AT-PU22	215 (8.5")	60	50 / 200	12.5	1.50

ITEM No.	Length mm (inch)	Weight g	PCS inner/ctn	G.W. KGS	CUFT
AT-PU33	330~685 (13~27")	210	24 / 96	21.0	1.30

## Telescoping Magnetic Pick-Up Tool

ITEM No.	Length mm (inch)	Pick-Up lbs.	Weight g	PCS inner/ctn	G.W. KGS	CUFT
AT-B16	645 (25.5")	3.5	30	50 / 200	11.0	1.00

### Features:

- Lifts up to 3-1/2 lbs. (1600g)
- Telescopes from 5-1/4" (135mm) to 25-1/2" (645mm)
- Telescopic pocket magnetic bar

## Flexible Magnetic Pick-Up Tool

ITEM No.	Length mm (inch)	Pick-Up lbs.	Weight g	PCS inner/ctn	G.W. KGS	CUFT
AT-B24	600 (24")	3.5	180	25 / 100	20.0	1.90

### Features:

- Lifts up to 3-1/2 lbs. (1600g)

## Grease Gun

ITEM No.	Length mm (inch)	Capacity Cartridge	Capacity Bulk	Working Pressure	Burst Pressure	Screw Thread	Weight g	PCS	G.W. KGS	CUFT
AT-46012	355 (14")	14 o.z.	400 c.c.	4500 psi	10000 psi	1/8" x 27 NPT	1200	20	26.9	2.30

### Description

Metallic Bend Spout: 170mmL (6-3/4")  
 High Pressure Nylon Hose: 305mmL (12")  
 3 Ways Loading  
 Color Box

ITEM No.	Length mm (inch)	Capacity Cartridge	Capacity Bulk	Working Pressure	Burst Pressure	Screw Thread	Weight g	PCS	G.W. KGS	CUFT
AT-460S	355 (14")	14 o.z.	400 c.c.	4500 psi	10000 psi	1/8" x 27 NPT	1200	20	26.9	2.30

### Description

Metallic Bend Spout: 170mmL (6-3/4")  
 3 Ways Loading  
 Color Box

## AT-3500 Oil Suction Gun

### Description

Capacity: 500 c.c.  
 Flexible Plastic Hose: 280mmL (11")  
 Color Box

800 g

20 sets / 18.5 Kgs / 1.5 CUFT

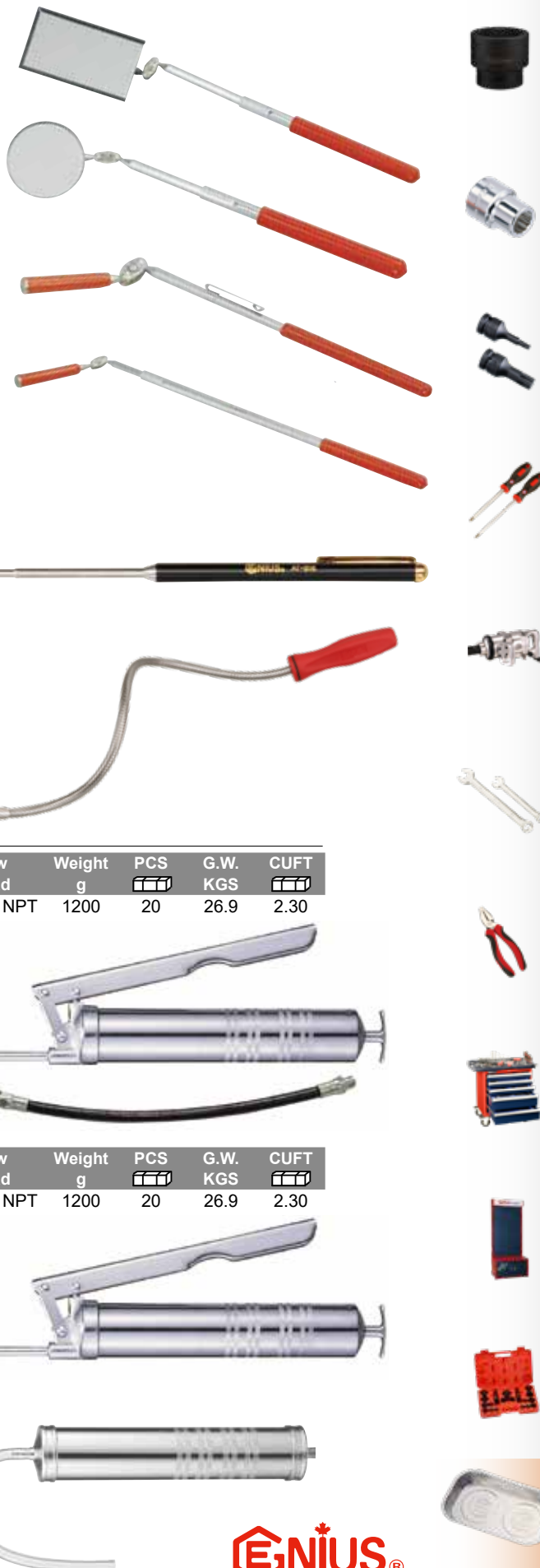

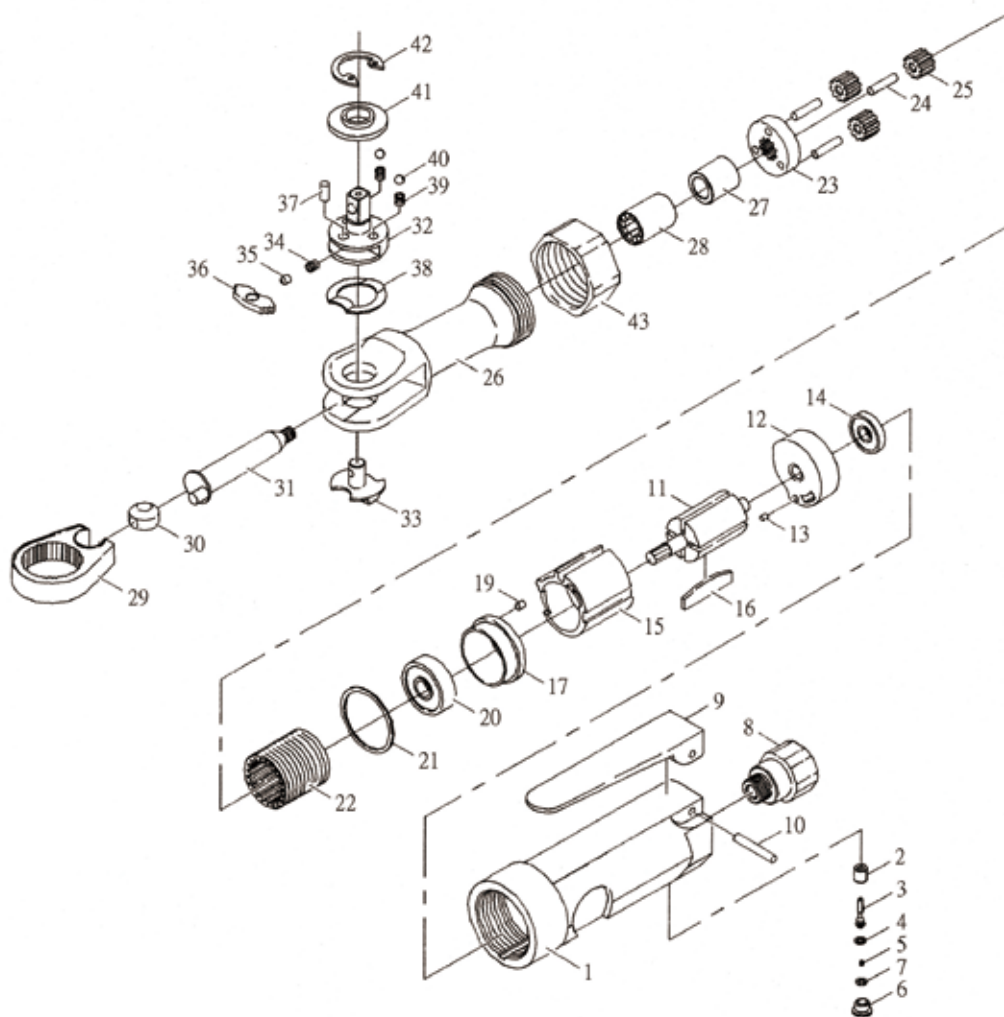

## 205051X 1/4" Dr. Stubby Standard Duty Air Ratchet

No.	Parts No.	Description	Q'TY	CODE	No.	Parts No.	Description	Q'TY	CODE
01	025101	Motor Housing	1	001730	23	025123	Idle Gear Plate	1	000430
02	025102	Throttle Valve	1	000120	24	025124	Needle Roller	3	000160
03	025103	Valve Stem	1	000170	25	025125	Idle Gear	3	001030
04	025104	O-Ring	1	000100	26	025126	Ratchet Housing	1	003580
05	025105	Throttle Spring	1	000100	27	025127	Bushing	1	000150
06	025106	Valve Plug	1	000120	28	025128	Needle Bearing	1	001130
07	025107	O-Ring	1	000100	29	025129	Yoke	1	001130
08	025108	Hose Fitting	1	000420	30	025130	Drive Bushing	1	000620
09	025109	Throttle Lever	1	000320	31	025131	Crank Shaft	1	001080
10	025110	Spring Pin	1	000100	32	025132	Ratchet Anvil	1	001330
11	025111	Rotor	1	002080	33	025133	Reverse Button	1	000500
12	025112	Rear End Plate	1	000420	34	025134	Ratchet Spring	1	000100
13	025113	Spring Pin	1	000100	35	025135	Spring Cap	1	000160
14	025114	Bearing	1	001030	36	025136	Pawl	1	000550
15	025115	Cylinder	1	000710	37	025137	Needle Roller	1	000190
16	025116	Rotor Blade	4	000620	38	025138	Washer	1	000110
17	025117	Front End Plate	1	000440	39	025139	Friction Spring	2	000120
19	025119	Spring Pin	1	000100	40	025140	Steel Ball	2	000100
20	025120	Bearing	1	001030	41	025141	Thrust Washer	1	000350
21	025121	Washer	1	000110	42	025142	Internal Stop Ring	1	000170
22	025122	Internal Gear	1	000820	43	025143	Clamp Nut	1	000730

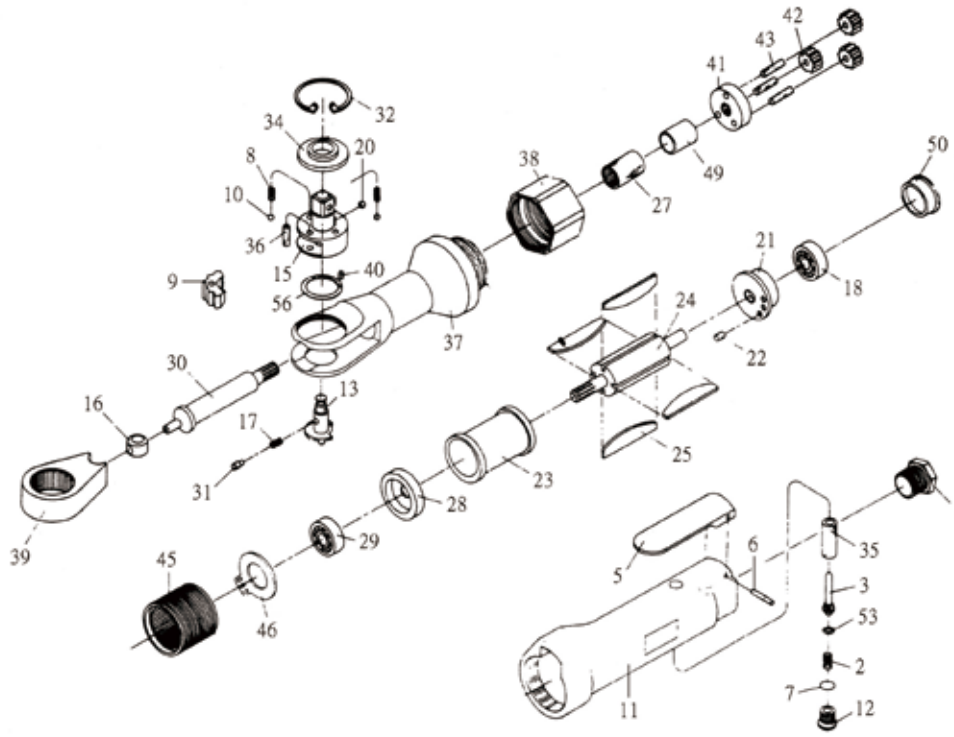

## 305052X 3/8" Dr., 405053X 1/2" Dr. Heavy Duty Air Ratchet

No.	Parts No.	Description	Q'TY	CODE	No.	Parts No.	Description	Q'TY	CODE
01	035001	Hose fitting	1	000420	34A	035034A	Thrust Washer (for 305052X)	1	000350
02	035002	Throttle Spring	1	000100	34B	035034B	Thrust Washer (for 405053X)	1	000350
03	035003	Valve Stem	1	000170	35	035035	Throttle Valve	1	000170
05	035005	Throttle Lever	1	000320	36	035036	Needle Roller	1	000100
06	035006	Spring Pin	1	000100	37	035037	Ratchet Housing	1	003580
07	035007	O-Ring	1	000100	38	035038	Clamp Nut	1	000730
08	035008	Friction Spring	2	000120	39	035039	Yoke	1	001130
09	035009	Pawl	1	000550	40	035040	Spring Pin	1	000100
10	035010	Steel Ball	2	000100	41	035041	Idler Gear Plate	1	000430
11	035011	Motor Housing	1	001730	42	035042	Idler Gear	3	001030
12	035012	Valve Plug	1	000120	43	035043	Needle Roller	3	000160
13A	035013A	Reverse Button (for 305052X)	1	000500	45	035045	Internal Gear	1	000820
13B	035013B	Reverse Button (for 405053X)	1	000500	46	035046	Exhaust Cover	1	000150
15A	035015A	3/8" Dr. Anvil (for 305052X)	1	001330	49	035049	Bushing	1	000150
15B	035015B	1/2" Dr. Anvil (for 405053X)	1	001330	50	035050	Bearing Cap	1	000100
16	035016	Drive Bushing	1	000620	53	035053	O-Ring	1	000100
17	035017	Ratchet Spring	1	000100	56	035056	Washer	1	000110
18	035018	Bearing	1	001030	K01	035K01	Throttle Handle Kit (1.5.6.11.35.)	1 set	002350
20A	035020A	Steel Ball (for 305052X)	1	000100	K02	035K02	Valve Kit (2.3.7.12.53.)	1 set	000370
20B	035020B	Steel Ball (for 405053X)	1	000100	K03	035K03	Idler Gear Kit (41.42.43.)	1 set	001450
21	035021	Rear End Plate	1	000420	K04	035K04	Ratchet Housing Kit (27.37.48.)	1 set	004460
22	035022	Spring Pin	1	000100	K05A	035K05A	Ratchet Head Kit (8.9.10.13.15.17.20.31. 32.34.36.40.56.) (for 305052X)	1 set	002990
23	035023	Cylinder	1	000710	K05B	035K05B	Ratchet Head Kit (8.9.10.13.15.17.20.31. 32.34.36.40.56.) (for 405053X)	1 set	002990
24	035024	Rotor	1	002080					
25	035025	Rotor Blade	4	000620					
27	035027	Needle Bearing	1	001130					
28	035028	Front End Plate	1	000440					
29	035029	Bearing	1	001410					
30	035030	Crank Shaft	1	001080					
31	035031	Spring Cap	1	000160					
32	035032	Internal Stop Ring	1	000170					

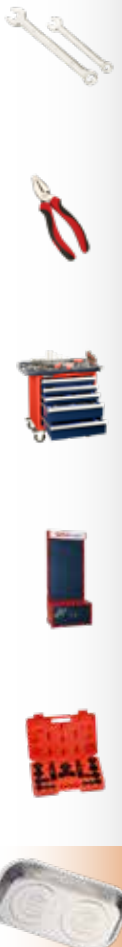



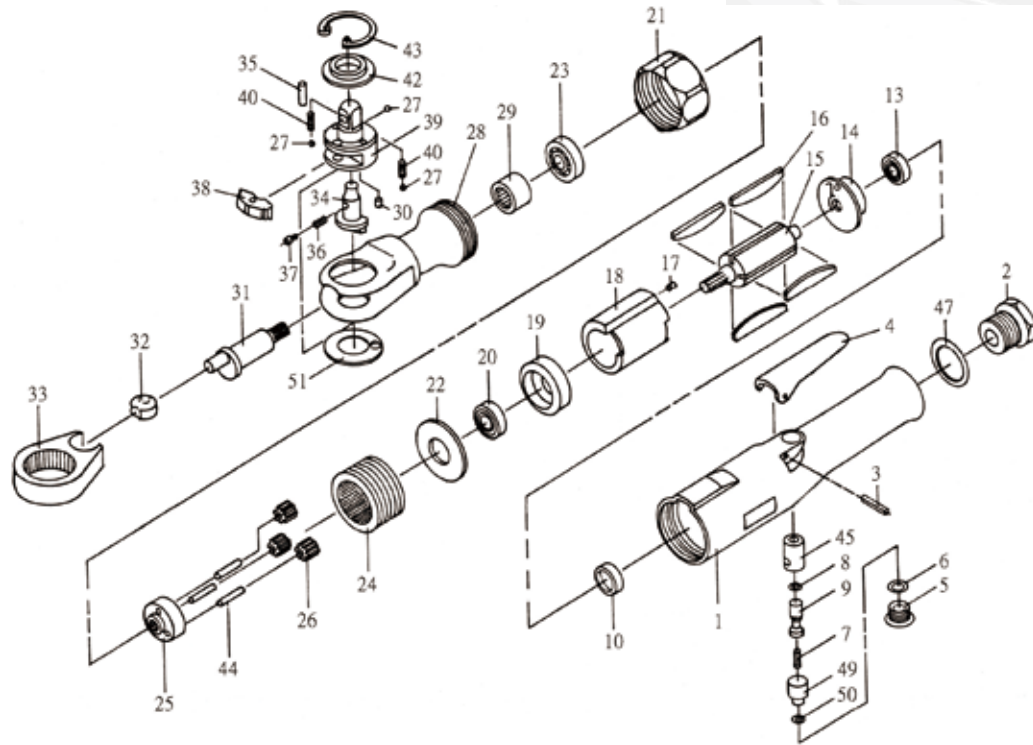

## 405054X 1/2" Dr. Super Duty Air Ratchet

No.	Parts No.	Description	Q'TY	CODE	No.	Parts No.	Description	Q'TY	CODE
01	045401	Motor Housing	1	002300	32	045432	Drive Bushing	1	000900
02	045402	Hose Fitting	1	000600	33	045433	Yoke	1	001800
03	045403	Spring Pin	1	000100	34	045434	Reverse Button	1	000800
04	045404	Throttle Lever	1	000400	35	045435	Needle Roller	1	000120
05	045405	Valve Plug	1	000200	36	045436	Reverse Spring	1	000140
06	045406	O-Ring	1	000100	37	045437	Lock Pin	1	000200
07	045407	Valve Spring	1	000100	38	045438	Pawl	1	000900
08	045408	O-Ring	1	000100	39	045439	Ratchet Anvil	1	001900
09	045409	Valve Stem	1	000250	40	045440	Friction Spring	2	000160
10	045410	Bearing Cap	1	000150	42	045442	Thrust Washer	1	000500
13	045413	Bearing	1	001500	43	045443	Internal Stop Ring	1	000230
14	045414	Rear End Plate	1	000650	44	045444	Needle Roller	3	000240
15	045415	Rotor	1	003000	45	045445	Throttle Valve	1	000400
16	045416	Rotor Blade	4	000800	47	045447	O-Ring	1	000100
17	045417	Spring Pin	1	000100	49	045449	Air Regulator	1	000150
18	045418	Cylinder	1	000990	50	045450	O-Ring	1	000100
19	045419	Front End Plate	1	000700	51	045451	Washer	1	000180
20	045420	Bearing	1	001800	K01	045K01	Throttle Handle Kit (1.2.3.4.45.47.)	1 set	003400
21	045421	Clamp Nut	1	001100	K02	045K02	Valve Kit (5.6.7.8.9. 49.50.)	1 set	000600
22	045422	Washer	1	000400	K03	045K03	Idler Gear Kit(25.26.44.)	1 set	001950
23	045423	Bearing	1	001800	K04	045K04	Ratchet Head Kit (27.30.34.35.36.37.38. 39.40.42.43.)	1 set	006450
24	045424	Internal Gear	1	001200	K05	045K05	Ratchet Housing Kit (23.28.29.)	1 set	003800
25	045425	Idler Gear Plate	1	000700					
26	045426	Idler Gear	3	001500					
27	045427	Steel Ball	3	000090					
28	045428	Ratchet Housing	1	004800					
29	045429	Needle Bearing	1	001500					
30	045430	Spring Pin	2	000120					
31	045431	Crank Shaft	1	001600					

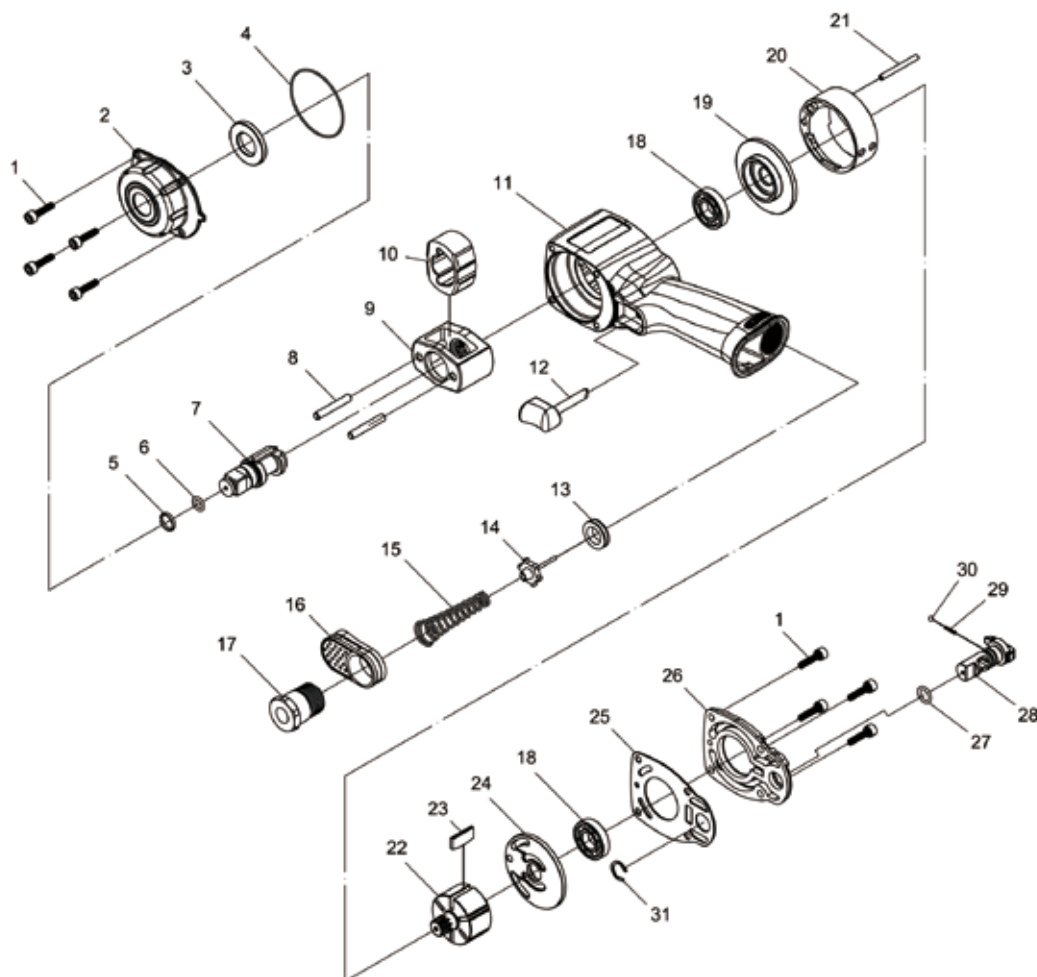

## 300450 3/8" Dr. Super Duty Lightweight Mini Air Impact Wrench

No.	Parts No.	Description	Q'TY	CODE	No.	Parts No.	Description	Q'TY	CODE
01	040501	Cap Screw	8	000860	17	040517	Hose Fitting	1	001140
02	040502	Hammer Case	1	003750	18	040518	Rotor Bearing	2	001550
03	040503	Anvil Bushing	1	001400	19	040519	Front End Plate	1	002180
04	040504	O-Ring	1	000300	20	040520	Cylinder	1	002580
05	030405	Socket Retainer	1	000250	21	040521	Cylinder Pin	1	000250
06	030406	O-Ring	1	000150	22	040522	Rotor	1	002970
07	030407	Standard Anvil	1	005910	23	040523	Rotor Blade	6	001300
08	040508	Hammer Pin	2	000500	24	040524	Rear End Plate	1	002180
09	040509	Hammer Frame	1	004920	25	040525	Rear Cap Gasket	1	000630
10	040510	Hammer	1	003080	26	040526	Rear Cap	1	001550
11	040511	Motor Housing	1	006480	27	040527	O-Ring	1	000250
12	040512	Trigger	1	000630	28	040528	Reverse Valve	1	001110
13	040513	Throttle Valve Bushing	1	000470	29	040529	Spring	1	000250
14	040514	Throttle Valve Stem	1	000470	30	040530	Steel Ball	1	000230
15	040515	Throttle Valve Spring	1	000500	31	040531	Reverse Valve Retainer	1	000230
16	040516	Exhaust Deflector	1	000470					

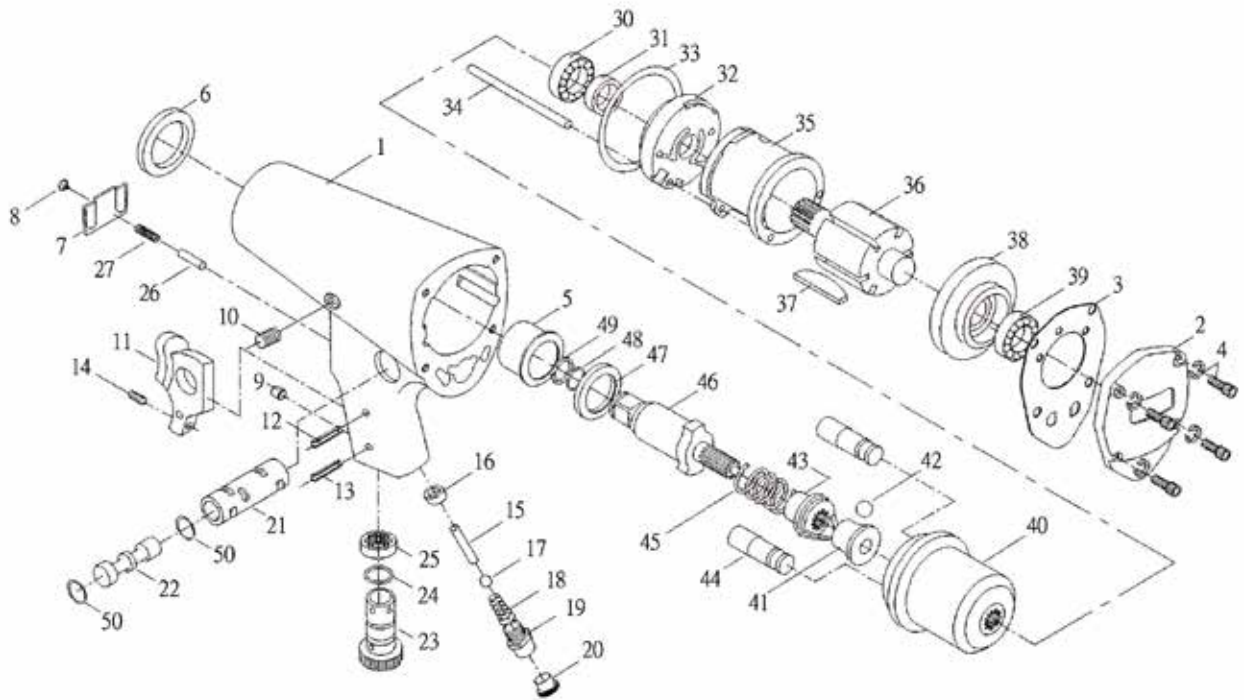

## 300300G 3/8" Dr. Air Impact Wrench

No.	Parts No.	Description	Q'TY	CODE
01	030301	Motor Housing	1	007060
02	030302	Rear Cap	1	001280
03	030303	Rear Cap Gasket	1	000300
04	030304	Cap Screw	4	000370
05	030305	Anvil Bushing	1	001600
06	030306	Oil Seal	1	000240
07	030307	Muffle Cover	1	000200
08	030308	Screw	1	000110
09	030309	Aluminum Plug	1	000200
10	030310	Oil Plug	1	000200
11	030311	Trigger	1	000690
12	030312	Trigger Pin	1	000110
13	030313	Spring Pin	1	000110
14	030314	Screw	1	000110
15	030315	Throttle Valve Stem	1	000200
16	030316	Throttle Valve Bushing	1	000110
17	030317	Steel Ball	1	000110
18	030318	Throttle Valve Spring	1	000370
19	030319	Hose Fitting (NPT-18T)	1	000690
19-1	030319-1	Hose Fitting (NPT-19T)	1	000690
20	030320	Dust Cover	1	000110
21	030321	Valve Sleeve	1	001920
22	030322	Reverse Valve	1	001600
23	030323	Air Regulator	1	001920
24	030324	O-Ring	1	000200

No.	Parts No.	Description	Q'TY	CODE
25	030325	Ring	1	000300
26	030326	Pin	1	000110
27	030327	Spring	1	000110
30	030330	Front Rotor Bearing	1	001030
31	030331	Oil Seal	1	000560
32	030332	Front End Plate	1	001600
33	030333	O-Ring	1	000200
34	030334	Cylinder Pin	1	000110
35	030335	Cylinder	1	001920
36	030336	Rotor	1	002400
37	030337	Rotor Blade	6	001030
38	030338	Rear End Plate	1	001600
39	030339	Rear Rotor Bearing	1	001130
40	030340	Hammer Cage	1	004240
41	030341	Drive Cam Foundation	1	001600
42	030342	Steel Ball	1	000110
43	030343	Drive Cam	1	002250
44	030344	Hammer Pin	2	001600
45	030345	Spring	1	000200
46	030346	Standard Anvil	1	004950
47	030347	Anvil Washer	1	000860
48	030348	O-Ring	1	000110
49	030349	Socket Retainer	1	000110
50	030350	O-Ring	2	000110

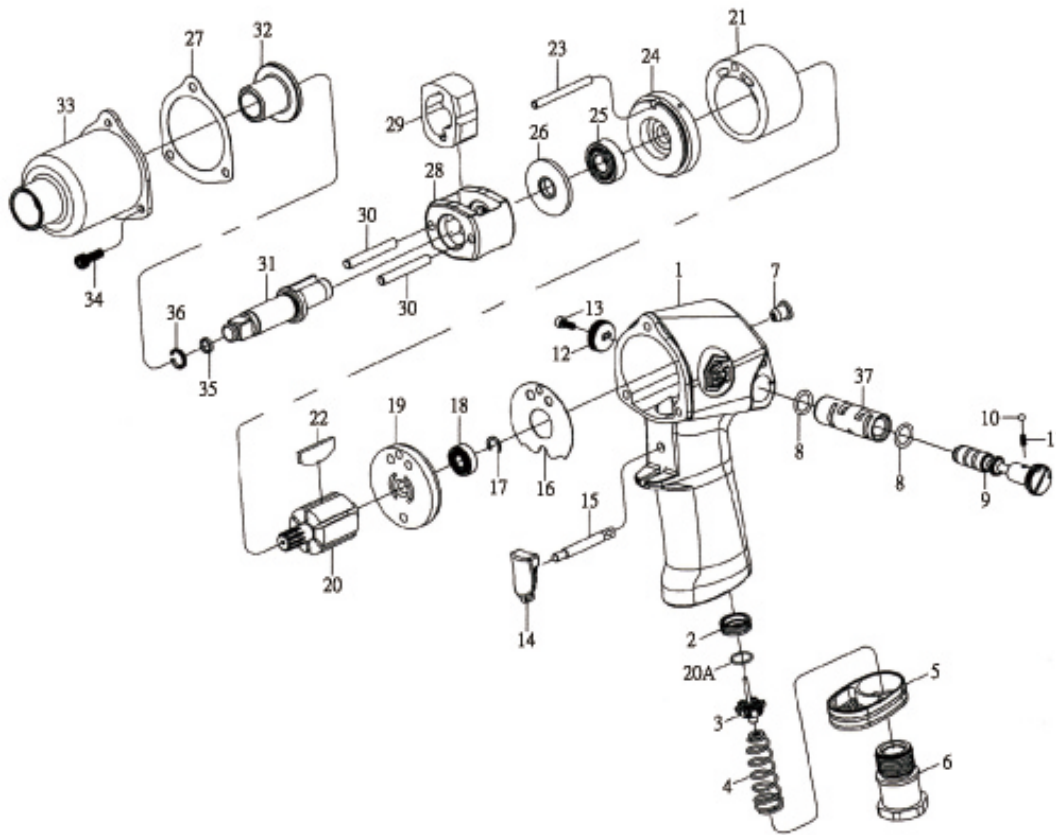

## 300200 3/8" Dr. Super Duty Air Impact Wrench

No.	Parts No.	Description	Q'TY	CODE	No.	Parts No.	Description	Q'TY	CODE
01A	032001	Motor Housing	1	004710	20A	032020A	O-Ring	1	000110
02	032002	Throttle Valve Seat	1	000460	21	032021	Cylinder	1	002500
03	032003	Throttle Valve Stem	1	000460	22	032022	Rotor Blade	6	000690
04	032004	Throttle Valve Spring	1	000460	23	032023	Cylinder Pin	1	000180
05	032005	Exhaust Deflector	1	000460	24	032024	Front End Plate	1	002130
06	032006	Hose Fitting	1	000860	25	032025	Front Rotor Bearing	1	001000
07	032007	Grease Fitting	1	000200	26	032026	Hammer Frame Rear Washer	1	000460
08	032008	Reverse Valve Bushing Seal	2	000200	27	032027	Hammer Case Gasket	1	000330
09	032009	Reverse Valve	1	001200	28	032028	Hammer Frame	1	003750
10	032010	Steel Ball	1	000100	29	032029	Hammer	1	002130
11	032011	Spring	1	000100	30	032030	Hammer Pin	2	000490
12	032012	Reverse Valve Knob	1	000310	31	032031	Standard Anvil	1	003750
13	032013	Reverse Valve Knob Screw	1	000100	32	032032	Anvil Bushing	1	000620
14	032014	Trigger	1	000330	33	032033	Hammer Case	1	003750
15	032015	Valve Pin	1	000330	34	032034	Cap Screw	3	000250
16	032016	End Plate Gasket	1	000270	35	032035	O-Ring	1	000100
17	032017	E-Ring	1	000100	36	032036	Socket Retainer	1	000110
18	032018	Rear Rotor Bearing	1	000860	37	032037	Valve Sleeve	1	001000
19	032019	Rear End Plate	1	002130	TK	0320TK	Tune-Up Kit (Includes Illustrated)10.12.16.20	1 set	001520
20	032020	Rotor	1	003000					

# Replacement Parts

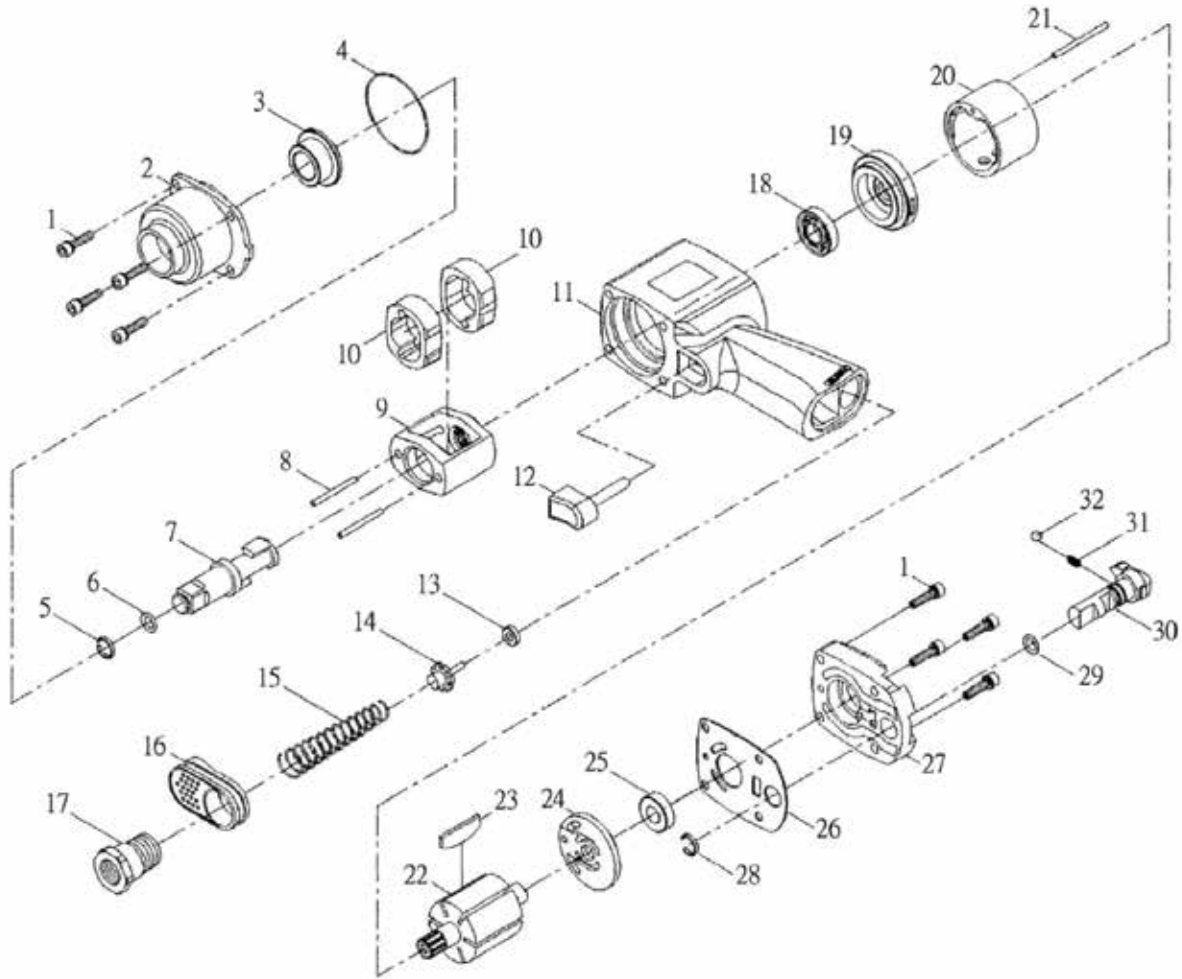

## 300350 3/8" Dr. Super Duty Air Impact Wrench

No.	Parts No.	Description	Q'TY	CODE	No.	Parts No.	Description	Q'TY	CODE
01	041401	Cap Screw	8	002000	17	041417	Hose Fitting	1	000850
02	041402	Hammer Case	1	005000	18	041418	Front Rotor Bearing	1	000750
03	041403	Anvil Bushing	1	000850	19	041419	Front End Plate	1	002500
04	041404	O-Ring	1	000400	20	041420	Cylinder	1	003500
05	033505	Socket Retainer	1	000250	21	041421	Cylinder Pin	1	000250
06	033506	O-Ring	1	000100	22	041422	Rotor	1	003500
07	033507A	Standard Anvil	1	007500	23	041423	Rotor Blade	6	003000
08	041408	Hammer Pin	2	001000	24	041424	Rear End Plate	1	002500
09	041409	Hammer Frame	1	006000	25	041425	Rear Rotor Bearing	1	000850
10	041410	Hammer	2	008000	26	041426	Rear Cap Gasket	1	000500
11	041411	Motor Housing	1	009100	27	041427	Rear Cap	1	001500
12	041412	Trigger	1	000700	28	041428	Reverse Valve Retainer	1	000200
13	041413	Throttle Valve Bushing	1	000500	29	041429	O-Ring	1	000250
14	041414	Throttle Valve Stem	1	000500	30	041030	Reverse Valve	1	001100
15	041415	Throttle Valve Spring	1	000500	31	041431	Spring	1	000200
16	041416	Exhaust Deflector	1	000500	32	041432	Steel Ball	1	000400

Miscellaneous

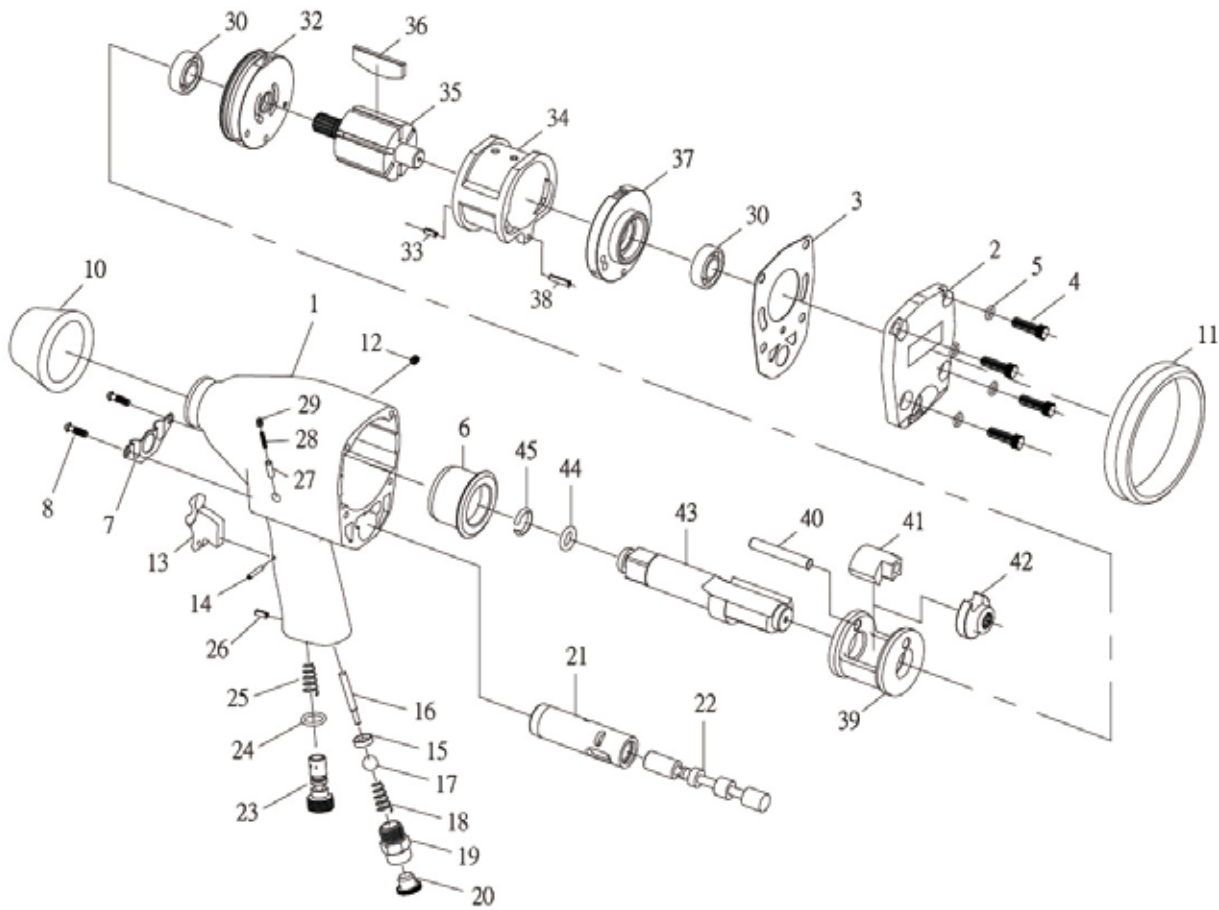

## 400230 1/2" Dr. Air Impact Wrench

No.	Parts No.	Description	Q'TY	CODE	No.	Parts No.	Description	Q'TY	CODE
01	042301	Motor Housing	1	003750	24	042324	O-Ring	1	000100
02	042302	Rear Cap	1	000470	25	042325	Spring	1	000110
03	042303	Rear Cap Gasket	1	000100	26	042326	Screw	1	000100
04	042304	Screw	4	000200	27	042327	Pin	1	000100
05	042305	Spring Washer	4	000100	28	042328	Spring	1	000100
06	042306	Anvil Bushing	1	000470	29	042329	Screw	1	000100
07	042307	Muffle Cover	1	000150	30	042330	Rotor Bearing	2	001230
08	042308	Screw	2	000150	31	042331	Oil Seal	1	000150
10	042310	Protecting Rubber	1	000190	32	042332	Front End Plate	1	000720
11	042311	Protecting Rubber	1	000110	33	042333	Spring Pin	1	000100
12	042312	Oil Plug	1	000100	34	042334	Cylinder	1	001200
13	042313	Trigger	1	000150	35	042335	Rotor	1	001600
14	042314	Trigger Pin	2	000110	36	042336	Rotor Blade	6	000690
15	042315	Throttle Valve Bushing	1	000110	37	042337	Rear End Plate	1	000720
16	042316	Throttle Valve Stem	1	000110	38	042338	Spring Pin	1	000100
17	042317	Steel Ball	1	000100	39	042339	Hammer Cage	1	001680
18	042318	Throttle Valve Spring	1	000100	40	042340	Hammer Pin	1	000270
19	042319	Hose Fitting (NPT-19T)	1	000300	41	042341	Hammer Dog	1	001090
20	042320	Dust Cover	1	000190	42	042342	Drive Cam	1	000860
21	042321	Valve Sleeve	1	000200	43	042343	Standard Anvil	1	001200
22	042322	Reverse Valve	1	000470	44	042344	O-Ring	1	000100
23	042323	Air Regulator	1	000470	45	042345	Socket Retainer	1	000100

# Replacement Parts

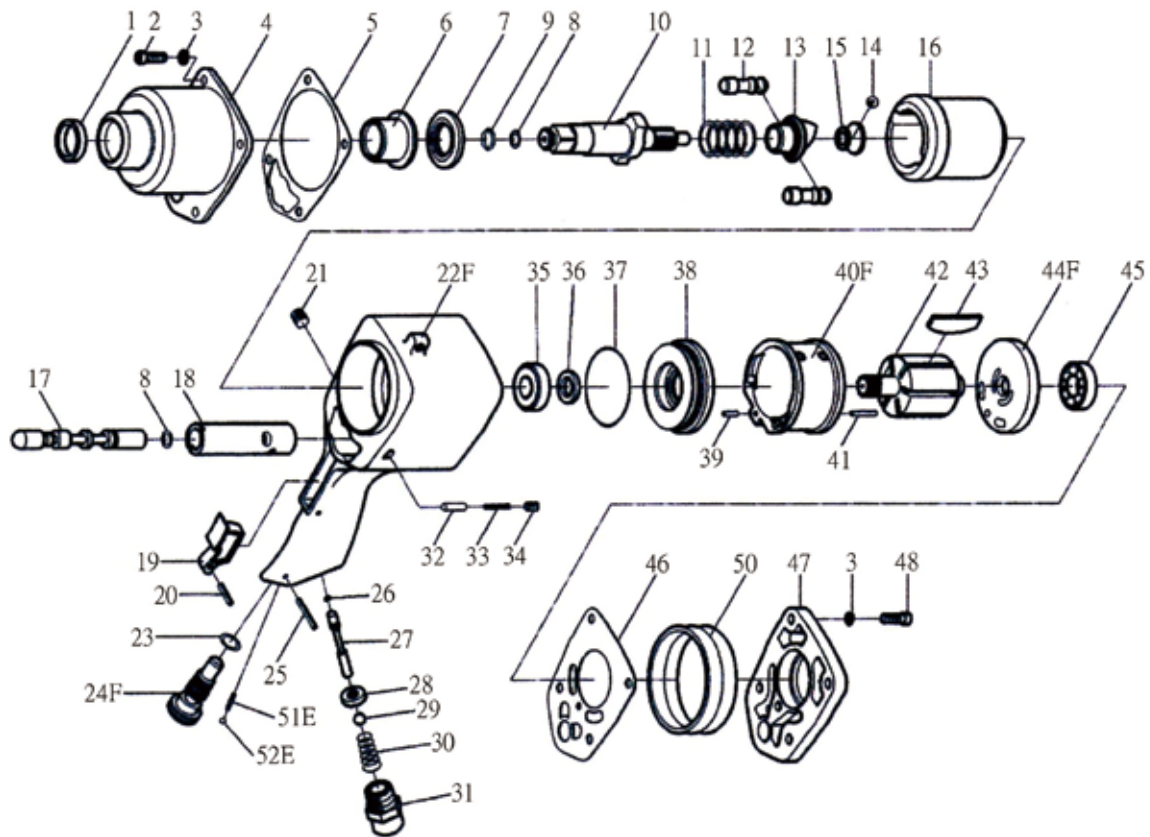

## 400400G 1/2" Dr. Super Duty Air Impact Wrench

No.	Parts No.	Description	Q'TY	CODE	No.	Parts No.	Description	Q'TY	CODE
01	043001	Oil Seal	1	000230	27	043027	Throttle Valve Stem	1	000130
02	043002	Cap Screw	4	000290	28	043028	Throttle Valve Bushing	1	000100
03	043003	Spring Washer	8	000370	29	043029	Steel Ball	1	000100
04	043004	Hammer Case	1	002500	30	043030	Throttle Valve Spring	1	000100
05	043005	Hammer Case Gasket	1	000150	31	043031	Hose Fitting	1	000320
06	043006	Anvil Bushing	1	000630	32	043032	Pin	1	000110
07	043007	Hammer Case Pilot	1	000230	33	043033	Spring	1	000100
08	043008	O-Ring	2	000110	34	043034	Screw	1	000130
09	043009	Socket Retainer	1	000100	35	043035	Front Rotor Bearing	1	000910
10	043010	Standard Anvil	1	003000	36	043036	Oil Seal	1	000200
11	043011	Spring	1	000230	37	043037	O-Ring	1	000150
12	043012	Hammer Pin	2	001120	38	043038	Front End Plate	1	001140
13	043013	Drive Cam	1	001710	39	043039	Spring Pin	1	000100
14	043014	Steel Ball	1	000200	40F	043040F	Cylinder	1	001600
15	043015	Drive Cam Foundation	1	000660	41	043041	Spring Pin	1	000100
16	043016	Hammer Cage	1	003500	42	043042	Rotor	1	002100
17	043017	Reverse Valve	1	000620	43	043043	Rotor Blade	6	000910
18	043018	Valve Sleeve	1	000630	44F	043044F	Rear End Plate	1	001060
19	043019	Trigger	1	000230	45	043045	Rear Rotor Bearing	1	000910
20	043020	Trigger Pin	1	000100	46	043046	Rear Cap Gasket	1	000150
21	043021	Set Screw	1	000130	47	043047	Rear Cap	1	001000
22F	043022F	Motor Housing	1	005880	48	043048	Screw	4	000170
23	043023	O-Ring	1	000100	50	043050	Protecting Rubber	1	000150
24F	043024F	Air Regulator	1	001000	51E	043051E	Spring	1	000100
25	043025	Spring Pin	1	000100	52E	043052E	Steel Ball	1	000100
26	043026	O-Ring	1	000100					

Miscellaneous

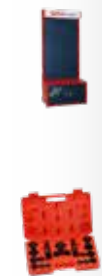
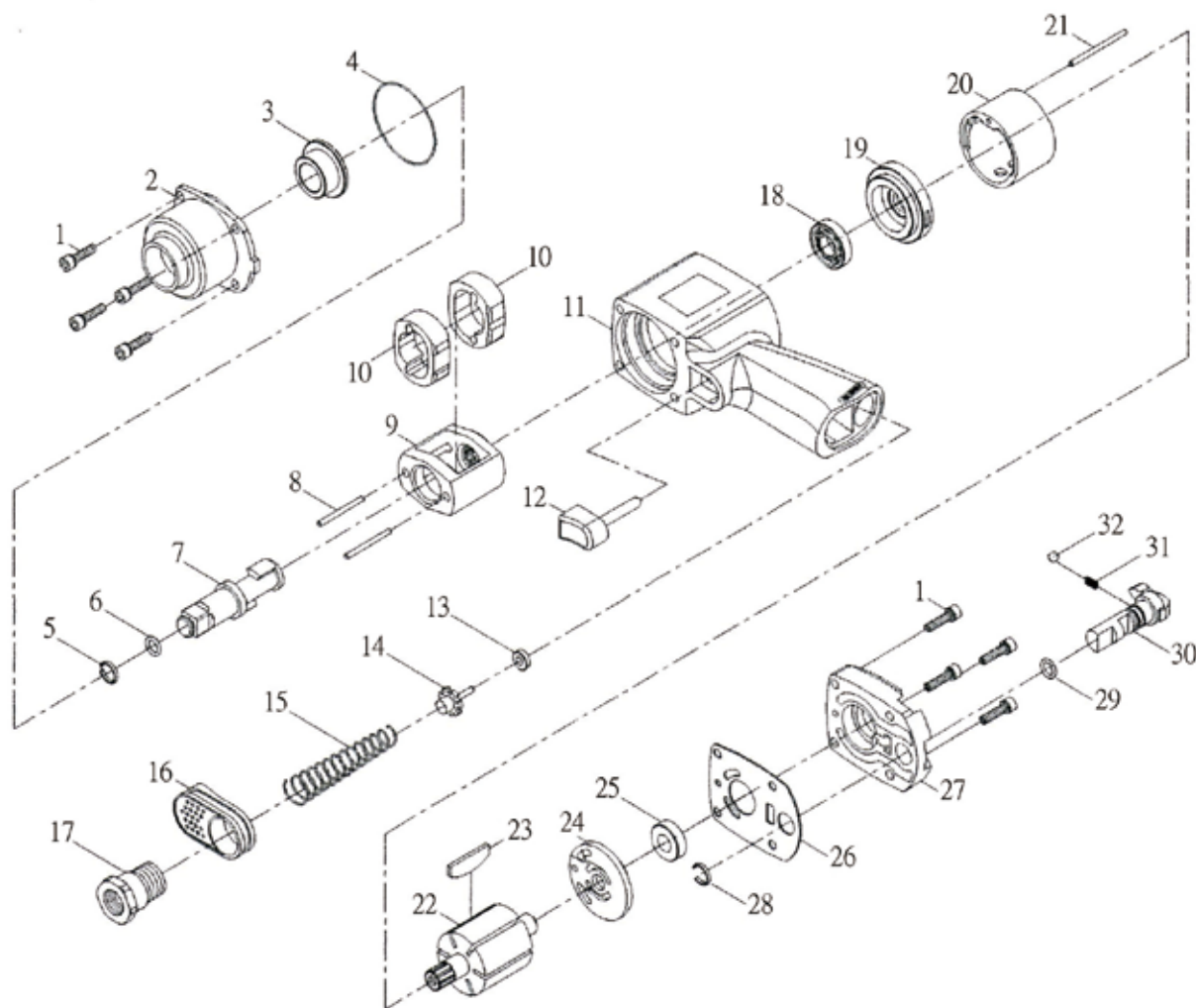

## 400401, 400402 1/2" Dr. Super Duty Lightweight Mini Air Impact Wrenches

No.	Parts No.	Description	Q'TY	CODE	No.	Parts No.	Description	Q'TY	CODE
01	041401	Cap Screw	8	002000	17	041417	Hose Fitting	1	000850
02	041402	Hammer case	1	005000	18	041418	Front Rotor Bearing	1	000750
03	041403	Anvil Bushing	1	000850	19	041419	Front End Plate	1	002500
04	041404	O-Ring	1	000400	20	041420	Cylinder	1	003500
05	041405	Socket Retainer	1	000250	21	041421	Cylinder Pin	1	000250
06	041406	O-Ring	1	000100	22	041422	Rotor	1	003500
07	041407A	Standard Anvil (for 400401)	1	007500	23	041423	Rotor Blade	6	003000
	041407B	2" Extended Anvil (for 400402)	1	008300	24	041424	Rear End Plate	1	002500
08	041408	Hammer Pin	2	001000	25	041425	Rear Rotor Bearing	1	000850
09	041409	Hammer Frame	1	006000	26	041426	Rear Cap Gasket	1	000500
10	041410	Hammer	2	008000	27	041427	Rear Cap	1	001500
11	041411	Motor Housing	1	009100	28	041428	Reverse Valve Retainer	1	000200
12	041412	Trigger	1	000700	29	041429	O-Ring	1	000250
13	041413	Throttle Valve Bushing	1	000500	30	041030	Reverse Valve	1	001100
14	041414	Throttle Valve Stem	1	000500	31	041431	Spring	1	000200
15	041415	Throttle Valve Spring	1	000500	32	041432	Steel Ball	1	000400
16	041416	Exhaust Deflector	1	000500					



# Replacement Parts

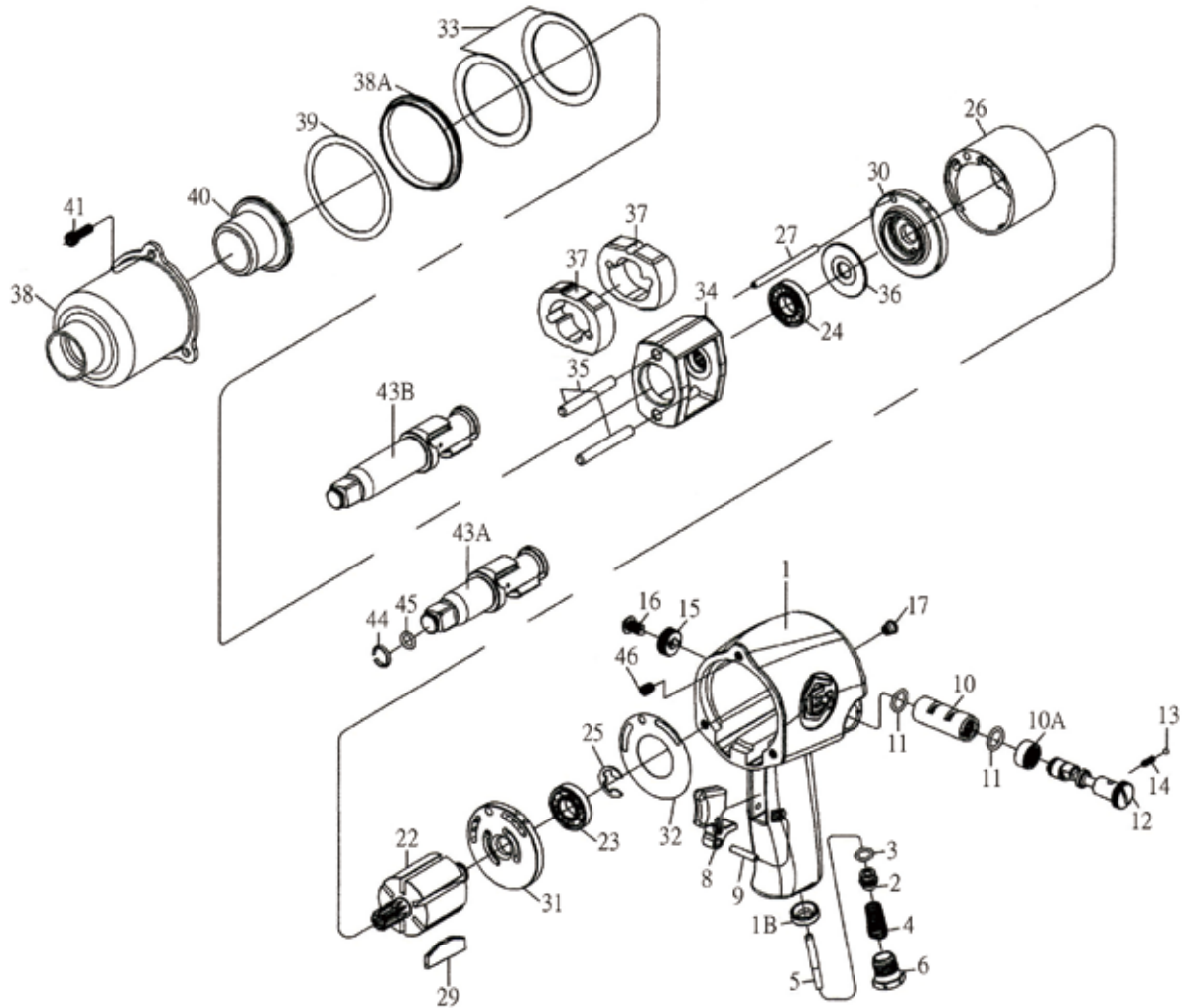

## 400420, 400422 1/2" Dr. Super Duty Air Impact Wrenches

No.	Parts No.	Description	Q'TY	CODE
01	044001	Motor Housing (incl. 01B)	1 set	005880
01B	044001B	Throttle Valve Seat	1	-
02	044002	Throttle Valve	1	000330
03	044003	Throttle Valve Face	1	000110
04	044004	Throttle Valve Spring	1	000110
05	044005	Throttle Valve Stem	1	000230
06	044006	Air Strainer Assembly	1	000710
08	044008	Trigger	1	000270
09	044009	Trigger Pin	1	000100
10	044010	Valve Sleeve (incl. 10A)	1 set	001000
10A	044010A	Reverse Valve Bushing Gear	1	-
11	044011	Reverse Valve Bushing Seal	2	000200
12	044012	Reverse Valve	1	001600
13	044013	Steel Ball	1	000100
14	044014	Reverse Valve Detent Spring	1	000100
15	044015	Reverse Valve Knob	1	000330
16	044016	Reverse Valve Knob Screw	1	000100
17	044017	Grease Fitting	1	000330
22	044022	Rotor	1	003000
23	044023	Rear Rotor Bearing	1	000860
24	044024	Front Rotor Bearing	1	001000
25	044025	E-Ring	1	000100

No.	Parts No.	Description	Q'TY	CODE
26	044026	Cylinder	1	002130
27	044027	Cylinder Pin	1	000180
29	044029	Rotor Blade	6	000690
30	044030	Front End Plate	1	002130
31	044031	Rear End Plate	1	002130
32	044032	End Plate Gasket	1	000270
33	044033	Motor Clamp Washer	2	000620
34	044034	Hammer Frame	1	003750
35	044035	Hammer Pin	2	000490
36	044036	Hammer Frame Rear Washer	1	000460
37	044037	Hammer	2	003760
38	044038	Hammer Case	1	003750
38A	044038A	Hammer Case Pilot	1	000460
39	044039	Hammer Case Gasket	1	000270
40	044040	Anvil Bushing	1	000620
41	044041	Cap Screw	3	000250
43A	044043A	Standard Anvil (for 400420)	1	004710
43B	044043B	2" Extended Anvil (for 400422)	1	007060
44	044044	Socket Retainer	1	000110
45	044045	O-Ring	1	000100
46	044046	Heli-Coil	3	000250
TK	0440TK	Tune-Up Kit (Includes Illustrated Parts 3.4.11(2). 25.29(6).32.39.44.45)	1 set	001690

Miscellaneous

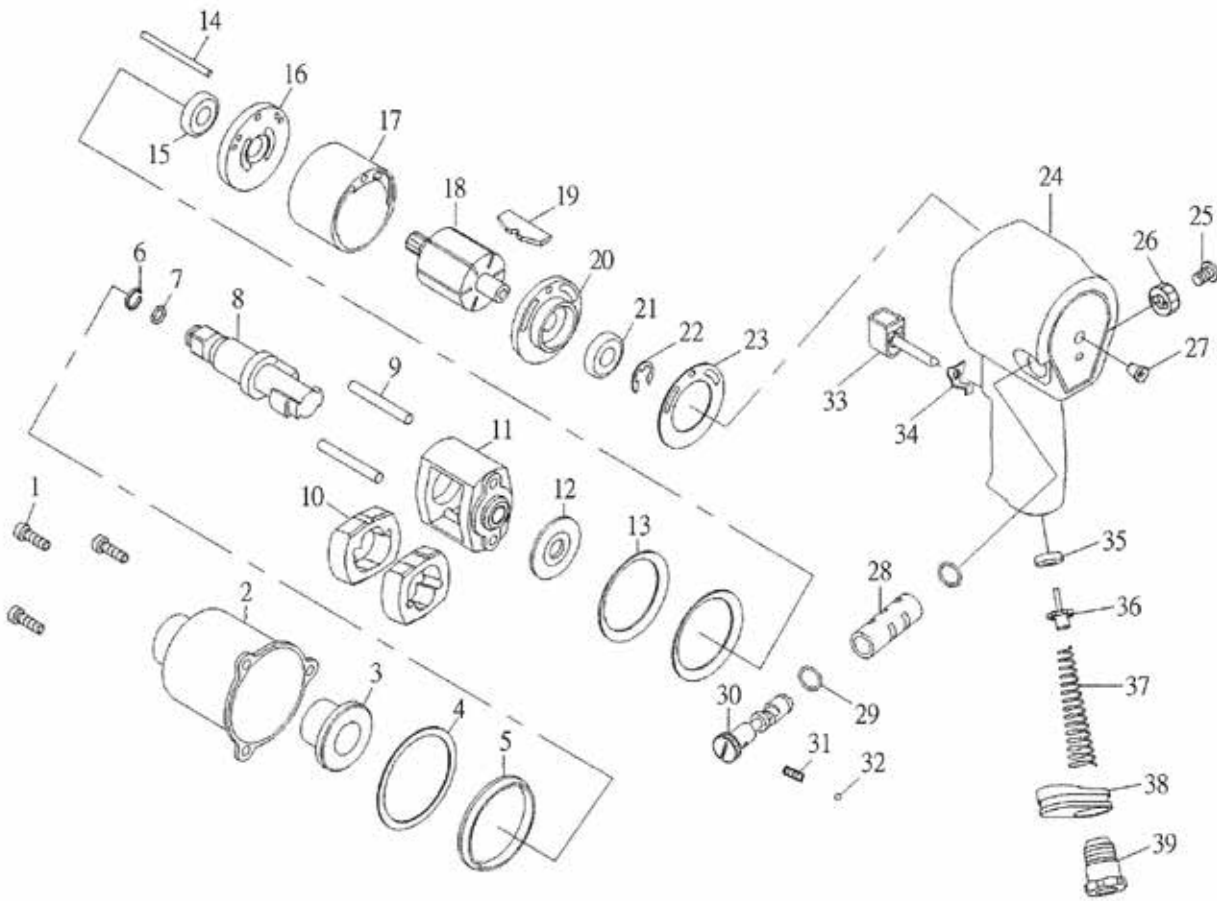

## 400450, 400452 1/2" Dr. Super Duty Air Impact Wrenches

No.	Parts No.	Description	Q'TY	CODE
01	046001	Cap Screw	3	000750
02	046002	Hammer Case	1	004710
03	046003	Anvil Bushing	1	001000
04	046004	Hammer Case Gasket	1	000250
05	046005	Hammer Case Pilot	1	000600
06	046006	Socket Retainer	1	000250
07	046007	O-Ring	1	000100
08	046008A	Standard Anvil (for 400450)	1	005880
08	046008B	2" Extended Anvil (for 400452)	1	010000
09	046009	Hammer Pin	2	000980
10	046010	Hammer	2	007520
11	046011	Hammer Frame	1	006900
12	046012	Hammer Frame Rear Washer	1	000360
13	046013	Spring Washer	2	000680
14	046014	Cylinder Pin	1	000280
15	046015	Front Rotor Bearing	1	001200
16	046016	Front End Plate	1	003200
17	046017	Cylinder	1	003700
18	046018	Rotor	1	004400
19	046019	Rotor Blade	6	002940

No.	Parts No.	Description	Q'TY	CODE
20	046020	Rear End Plate	1	003200
21	046021	Rear Rotor Bearing	1	001200
22	046022	E-Ring	1	000250
23	046023	End Plate Gasket	1	000250
24	046024	Motor Housing	1	007060
25	046025	Reverse Valve Knob Screw	1	000250
26	046026	Reverse Valve Knob	1	000340
27	046027	Grease Fitting	1	000360
28	046028	Valve Sleeve	1	001600
29	046029	O-Ring	2	000500
30	046030	Reverse Valve	1	001850
31	046031	Spring	1	000250
32	046032	Steel Ball	1	000250
33	046033	Trigger	1	000680
34	046034	Trigger Fixture	1	000280
35	046035	Throttle Valve Seat	1	000360
36	046036	Throttle Valve Stem	1	000600
37	046037	Throttle Valve Spring	1	000600
38	046038	Exhaust Deflector	1	000600
39	046039	Hose Fitting	1	001200

# Replacement Parts

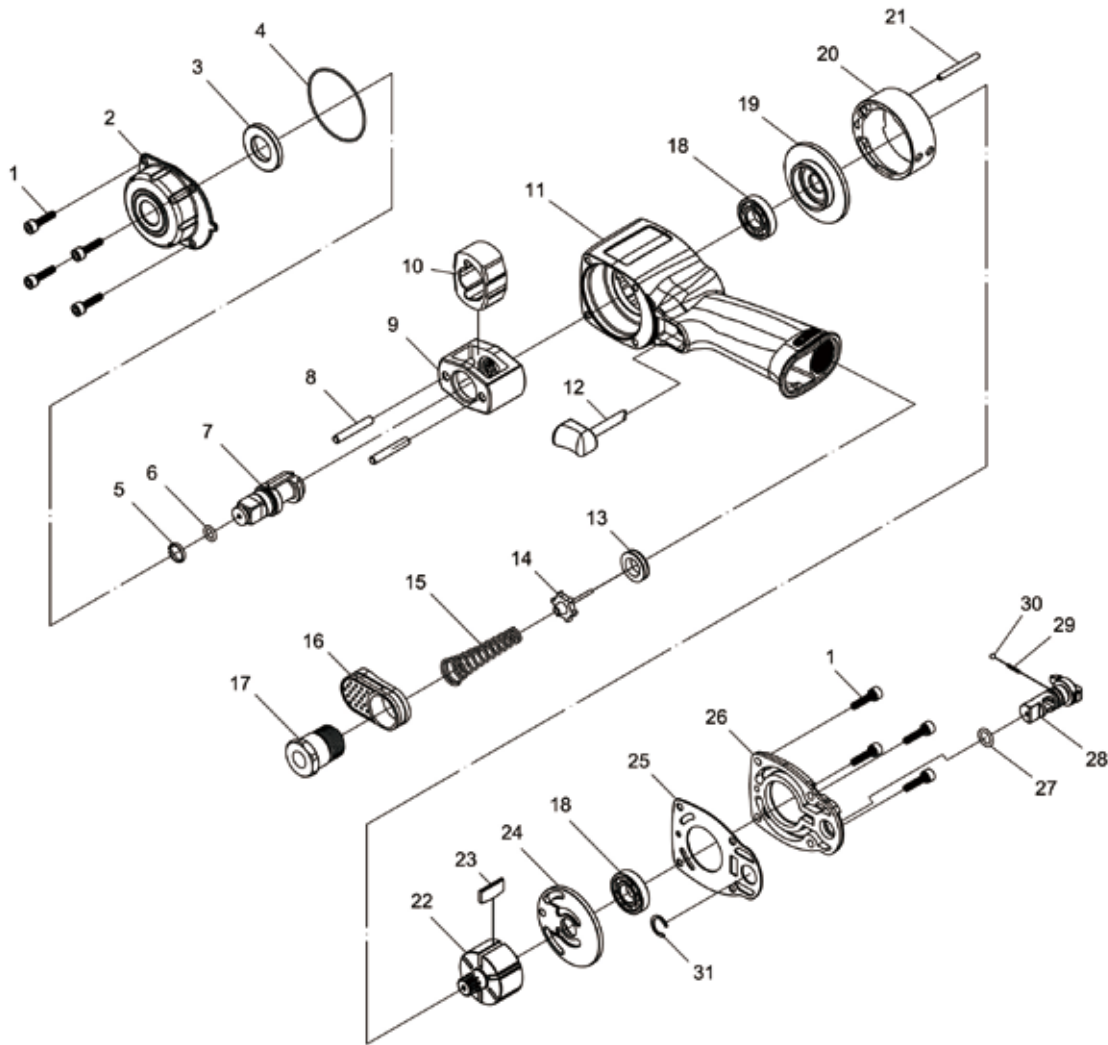

## 400511 1/2" Dr. Super Duty Lightweight Mini Air Impact Wrench

No.	Parts No.	Description	Q'TY	CODE	No.	Parts No.	Description	Q'TY	CODE
01	040501	Cap Screw	8	000860	17	040517	Hose Fitting	1	001140
02	040502	Hammer Case	1	003750	18	040518	Rotor Bearing	2	001550
03	040503	Anvil Bushing	1	001400	19	040519	Front End Plate	1	002180
04	040504	O-Ring	1	000300	20	040520	Cylinder	1	002580
05	040505	Socket Retainer	1	000250	21	040521	Cylinder Pin	1	000250
06	040506	O-Ring	1	000150	22	040522	Rotor	1	002970
07	040507	Standard Anvil	1	005910	23	040523	Rotor Blade	6	001300
08	040508	Hammer Pin	2	000500	24	040524	Rear End Plate	1	002180
09	040509	Hammer Frame	1	004920	25	040525	Rear Cap Gasket	1	000630
10	040510	Hammer	1	003080	26	040526	Rear Cap	1	001550
11	040511	Motor Housing	1	006480	27	040527	O-Ring	1	000250
12	040512	Trigger	1	000630	28	040528	Reverse Valve	1	001110
13	040513	Throttle Valve Bushing	1	000470	29	040529	Spring	1	000250
14	040514	Throttle Valve Stem	1	000470	30	040530	Steel Ball	1	000230
15	040515	Throttle Valve Spring	1	000500	31	040531	Reverse Valve Retainer	1	000230
16	040516	Exhaust Deflector	1	000470					

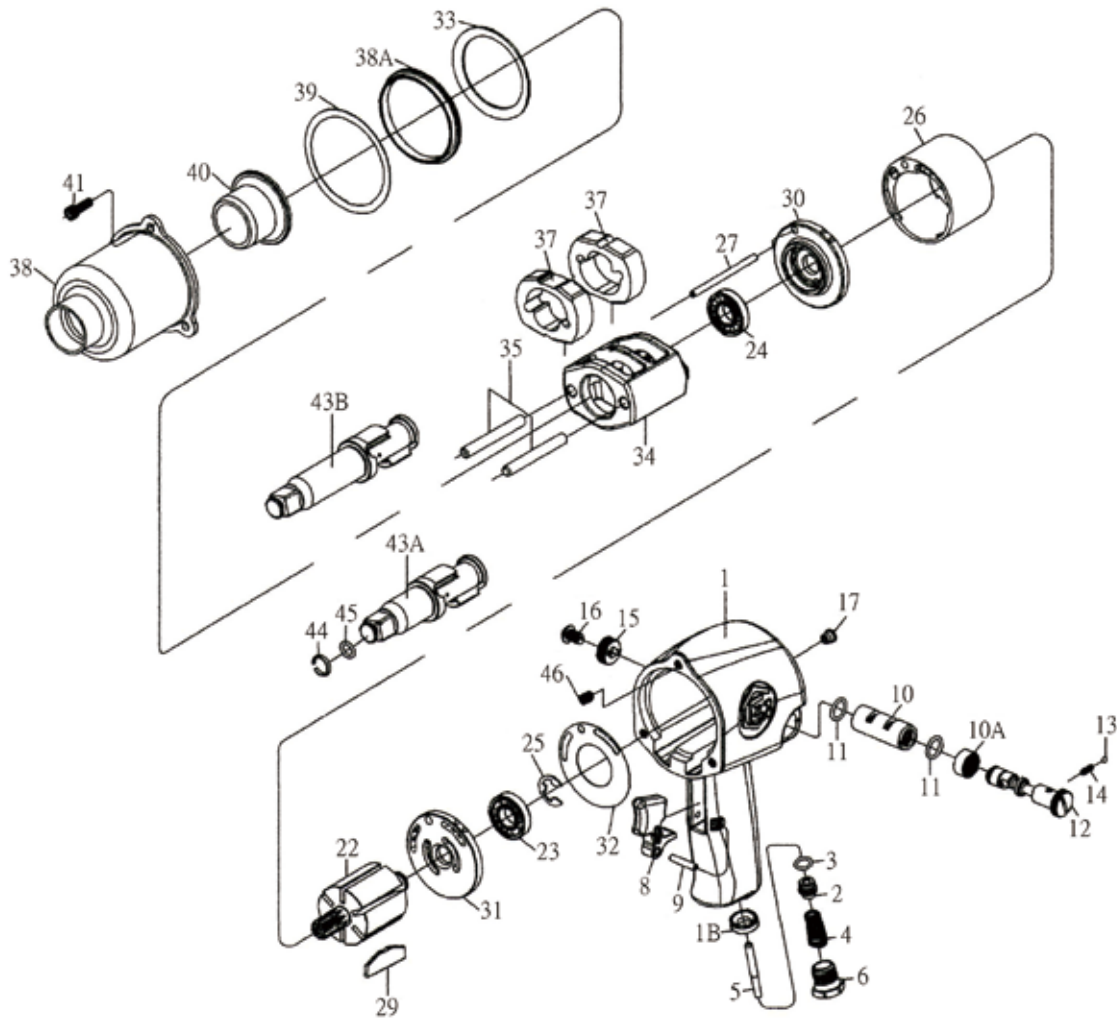

## 400500, 400502 1/2" Dr. Super Duty Air Impact Wrenches

No.	Parts No.	Description	Q'TY	CODE	No.	Parts No.	Description	Q'TY	CODE
01	045001	Motor Housing (incl. 01B)	1 set	007060	26	045026	Cylinder	1	003750
01B	045001B	Throttle Valve Seat	1	-	27	045027	Cylinder Pin	1	000180
02	045002	Throttle Valve	1	000330	29	045029	Rotor Blade	6	002250
03	045003	Throttle Valve Face	1	000110	30	045030	Front End Plate	1	002500
04	045004	Throttle Valve Spring	1	000110	31	045031	Rear End Plate	1	002130
05	045005	Throttle Valve Stem	1	000230	32	045032	End Plate Gasket	1	000270
06	045006	Hose Fitting	1	000710	33	045033	Motor Clamp Washer	2	000620
08	045008	Trigger	1	000270	34	045034	Hammer Frame	1	005880
09	045009	Trigger Pin	1	000100	35	045035	Hammer Pin	2	000490
10	045010	Valve Sleeve (incl. 10A)	1 set	001000	37	045037	Hammer	2	003760
10A	045010A	Reverse Valve Bushing Gear	1	-	38	045038	Hammer Case	1	004710
11	045011	Reverse Valve Bushing Seal	2	000200	38A	045038A	Hammer Case Pilot	1	000460
12	045012	Reverse Valve	1	001600	39	045039	Hammer Case Gasket	1	000270
13	045013	Steel Ball	1	000100	40	045040	Anvil Bushing	1	001330
14	045014	Spring	1	000100	41	045041	Cap Screw	3	000250
15	045015	Reverse Valve Knob	1	000330	43A	045043A	Standard Anvil (for 400500)	1	005880
16	045016	Reverse Valve Knob Screw	1	000100	43B	045043B	2" Extended Anvil (for 400502)	1	007780
17	045017	Grease Fitting	1	000330	44	045044	Socket Retainer	1	000110
22	045022	Rotor	1	004710	45	045045	O-Ring	1	000100
23	045023	Rear Rotor Bearing	1	000860	46	045046	Heli-Coil	3	000250
24	045024	Front Rotor Bearing	1	001000	TK	0450TK	Tune-Up Kit (Includes Illustrated Parts 3.4.11(2) 25.29(6).32.39.44.45	1 set	001690
25	045025	E-Ring	1	000100					

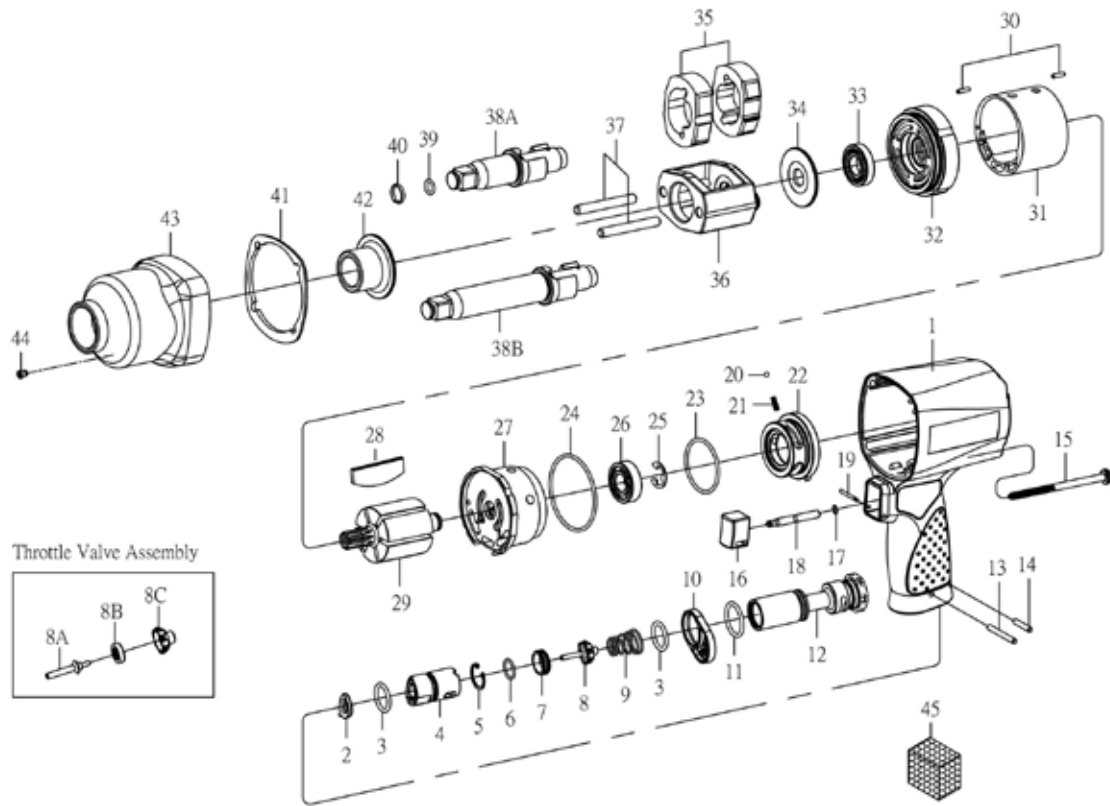

## 4K0950, 4K0952 1/2" Dr. Ultra Duty Air Impact Wrenches

No.	Parts No.	Description	Q'TY	CODE	No.	Parts No.	Description	Q'TY	CODE
01	04K501	Motor Housing	1	003330	23	04K523	O-Ring	1	000230
02	04K502	O-Ring	1	000310	24	04K524	O-Ring	1	000280
03	04K503	O-Ring	2	000130	25	04K525	E-Ring	1	000100
04	04K504	Guide Tube	1	000390	26	04K526	Rear Rotor Bearing	1	001120
05	04K505	Retainer	1	000130	27	04K527	Rear End Plate	1	008770
06	04K506	O-Ring	1	000100	28	04K528	Rotor Blade	6	000980
07	04K507	Throttle Valve Seat	1	000830	29	04K529	Rotor	1	006610
★ 08	04K508	Throttle Valve Assembly (incl. 8A, 8B, 8C)	1 Set	000670	30	04K530	Spring Pin	2	000130
● 08A	04K508A	Throttle Valve Pin	1	-	31	04K531	Cylinder	1	003330
● 08B	04K508B	Rubber Seal	1	-	32	04K532	Front End Plate	1	005640
● 08C	04K508C	Throttle Valve	1	-	33	04K533	Front Rotor Bearing	1	000880
09	04K509	Spring	1	000280	34	04K534	Washer	1	000390
10	04K510	Throttle Valve	1	000390	35	04K535	Hammer	2	005420
11	04K511	O-Ring	1	000100	36	04K536	Hammer Frame	1	006610
12	04K512	Hose Fitting	1	003610	37	04K537	Hammer Pin	2	000450
13	04K513	Spring Pin	1	000100	38A	04K538A	Standard Anvil (for 4K0950)	1	007800
14	04K514	Spring Pin	1	000100	38B	04K538B	2" Extended Anvil (for 4K0952)	1	010230
15	04K515	Screw	4	000670	39	04K539	O-Ring	1	000100
★ 16	04K516	Trigger Assembly (incl. 17, 18)	1 Set	000470	40	04K540	Socket Retainer	1	000180
● 17	04K517	O-Ring	1	-	41	04K541	Hammer Case Gasket	1	000550
● 18	04K518	Trigger Pin	1	-	● 42	04K542	Anvil Bushing	1	-
19	04K519	Spring Pin	1	000100	★ 43	04K543	Hammer Case Assembly (incl. 42, 44)	1 Set	009330
20	04K520	Steel Ball	1	000100	● 44	04K544	Grease Fitting	1	-
21	04K521	Spring	1	000130	45	04K545	Muffler Element	1	000180
22	04K522	Reverse Valve	1	001650	TK	04K5TK	Muffler Element Tune-Up Kit ( 3(2), 6, 9, 11, 17, 20, 21, 23, 24, 26, 28(6), 33, 39, 40, 41, 45 )	1 Set	003870

★ Must be purchased in assembly set

● Cannot be sold separately due to assembly difficulty

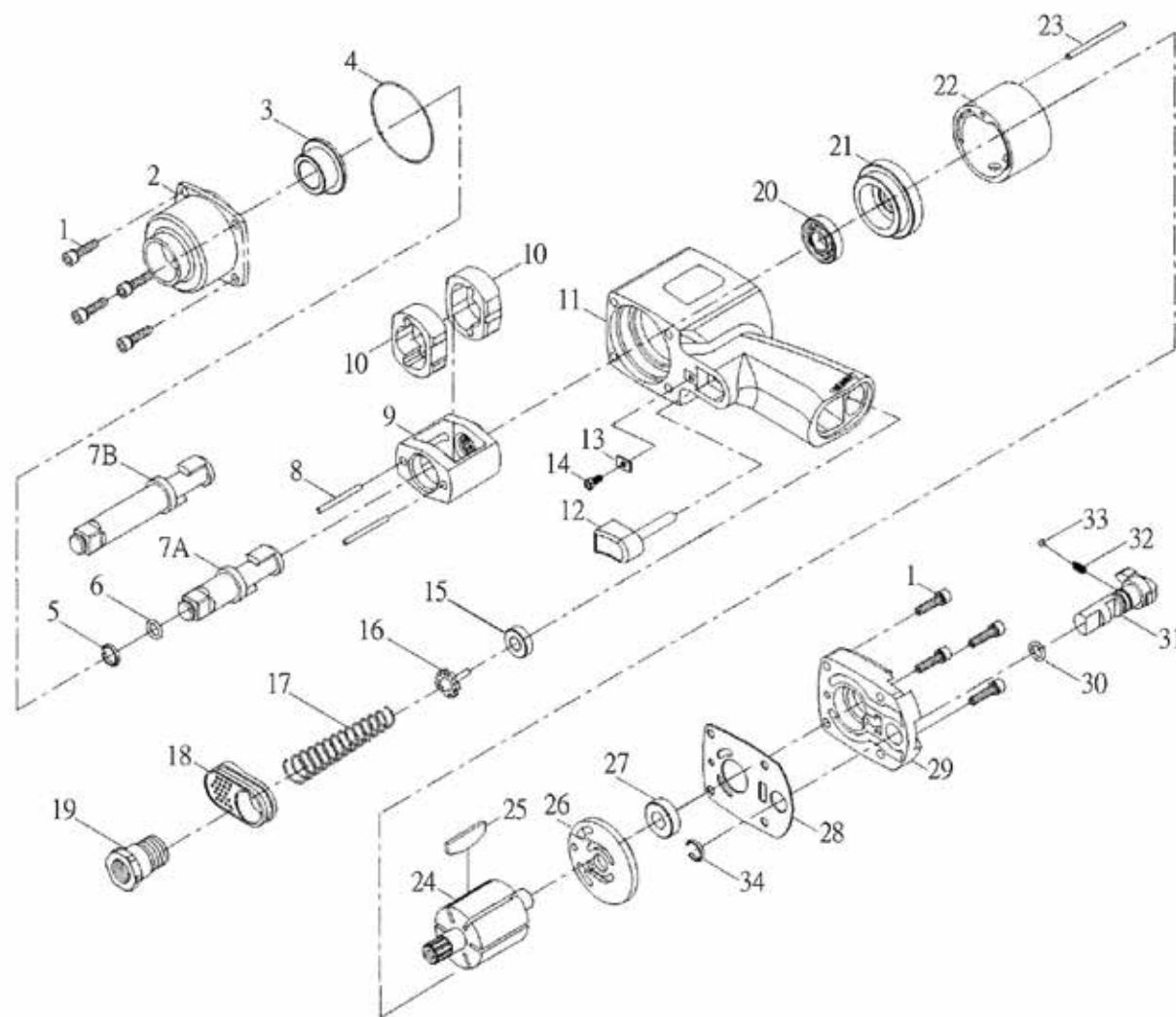

## 400800, 400802 1/2" Dr. Ultra Duty Air Impact Wrenches

No.	Parts No.	Description	Q'TY	CODE
01	048901	Cap Screw	8	002000
02	048902	Hammer Case	1	007500
03	048903	Anvil Bushing	1	003000
04	048904	O-ring	1	000400
05	048905	Socket Retainer	1	000300
06	048906	O-ring	1	000100
07A	048907A	Standard Anvil (for 400800)	1	009800
07B	048907B	2" Extended Anvil (for 400802)	1	012000
08	048908	Hammer Pin	2	001000
09	048909	Hammer Frame	1	008400
10	048910	Hammer	2	008000
11	048911	Motor Housing	1	011200
12	048912	Trigger	1	000700
13	048913	Trigger Retainer	1	000250
14	048914	Screw	1	000100
15	048915	Throttle Valve Bushing	1	000500
16	048916	Throttle Valve Stem	1	000500
17	048917	Throttle Valve Spring	1	000500

No.	Parts No.	Description	Q'TY	CODE
18	048918	Exhaust Deflector	1	000500
19	048919	Hose Fitting	1	000850
20	048920	Front Rotor Bearing	1	001200
21	048921	Front End Plate	1	003500
22	048922	Cylinder	1	005000
23	048923	Cylinder Pin	1	000400
24	048924	Rotor	1	005500
25	048925	Rotor Blade	6	003000
26	048926	Rear End Plate	1	003500
27	048927	Rear Rotor Bearing	1	000850
28	048928	Rear Cap Gasket	1	000700
29	048929	Rear Cap	1	003000
30	048930	O-ring	1	000200
31	048931	Reverse Valve	1	002500
32	048932	Spring	1	000250
33	048933	Steel Ball	1	000200
34	048934	Reverse Valve Retainer	1	000250



# Replacement Parts

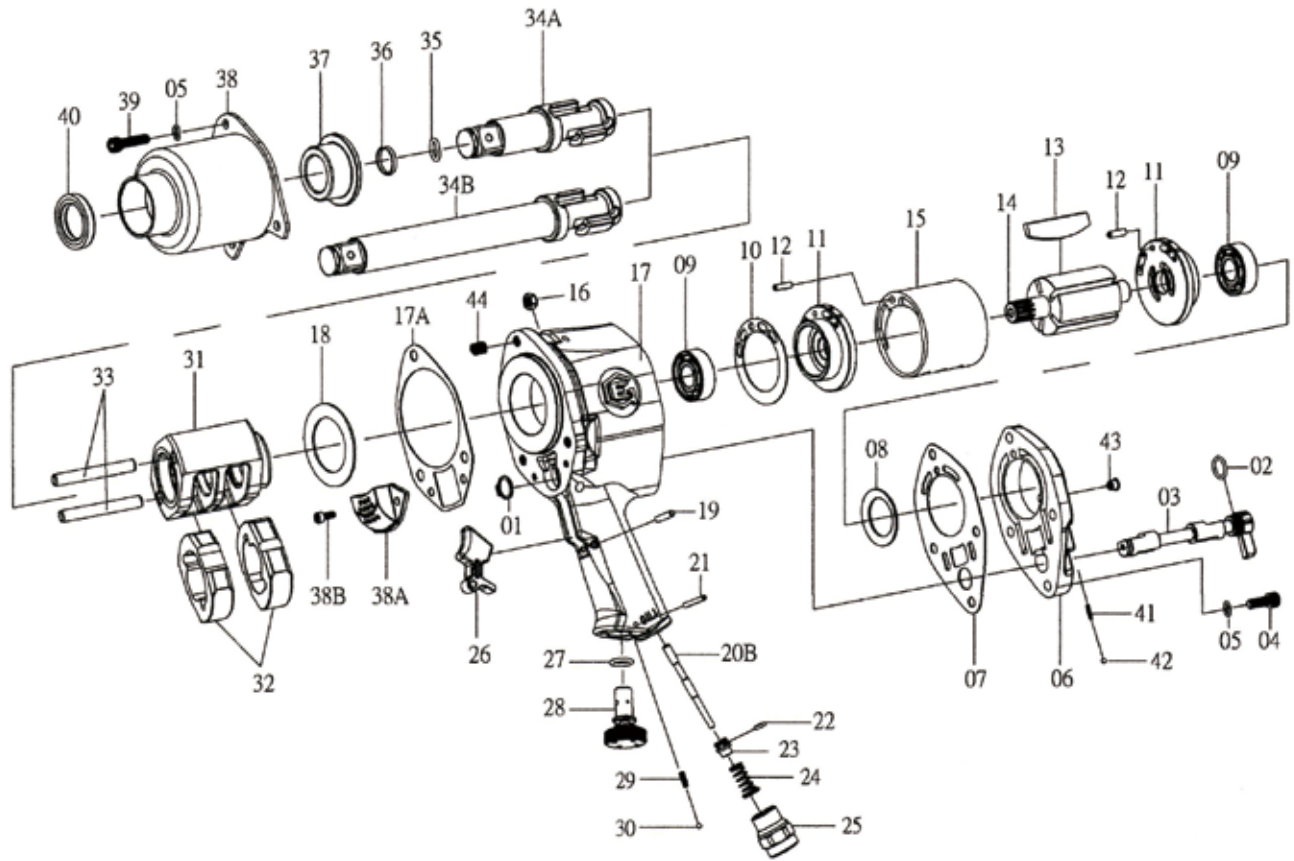

## 600750, 600756 3/4" Dr. Heavy Duty Air Impact Wrenches

No.	Parts No.	Description	Q'TY	CODE	No.	Parts No.	Description	Q'TY	CODE
01	067001	Reverse Valve Retainer	1	000100	25	067025	Hose Fitting	1	000710
02	067002	O-Ring	1	000110	26	067026	Trigger	1	000620
03	067003	Reverse Valve	1	003000	27	067027	O-Ring	1	000110
04	067004	Screw	4	000370	28	067028	Air Regulator	1	001330
05	067005	Spring Washer	10	000180	29	067029	Spring	1	000100
06	067006	Rear Cap	1	002500	30	067030	Steel Ball	1	000100
07	067007	Rear Cap Gasket	1	000860	31	067031	Hammer Frame	1	008890
08	067008	Motor Clamp Washer	1	000460	32	067032	Hammer	2	008890
09	067009	Rotor Bearing	2	002130	33	067033	Hammer Pin	2	001140
10	067010	End Plate Gasket	1	000330	34A	067034A	Standard Anvil (for 600750)	1	007780
11	067011	End Plate	2	007060	34B	067034B	6" Extended Anvil (for 600756)	1	013980
12	067012	Spring Pin	2	000150	35	067035	O-Ring	1	000110
13	067013	Rotor Blade	5	002500	36	067036	Socket Retainer	1	000200
14	067014	Rotor	1	005880	37	067037	Anvil Bushing	1	002130
15	067015	Cylinder	1	005880	38	067038	Hammer Case	1	011110
16	067016	Lock Nut	3	000460	38A	067038A	Exhaust Deflector	1	000860
17	067017	Motor Housing	1 set	015050	38B	067038B	Exhaust Deflector Screw	2	000200
17A	067017A	Hammer Case Gasket	1	000860	39	067039	Cap Screw	3	000300
18	067018	Hammer Frame Rear Washer	1	000860	40	067040	Oil Seal	1	000620
19	067019	Trigger Pin	1	000100	41	067041	Spring	1	000100
20B	067020B	Throttle Valve Stem	1	000620	42	067042	Steel Ball	1	000100
21	067021	Spring Pin	1	000100	43	067043	Grease Fitting	1	000200
22	067022	O-Ring	1	000110	44	067044	Heli-Coil	3	000300
23	067023	Throttle Valve	1	000330	TK	0670TK	Tune-Up Kit (Includes Illustrated Parts 1.2.7.10. 22.24.39(3))	1 set	001790
24	067024	Throttle Valve Spring	1	000180					

Miscellaneous

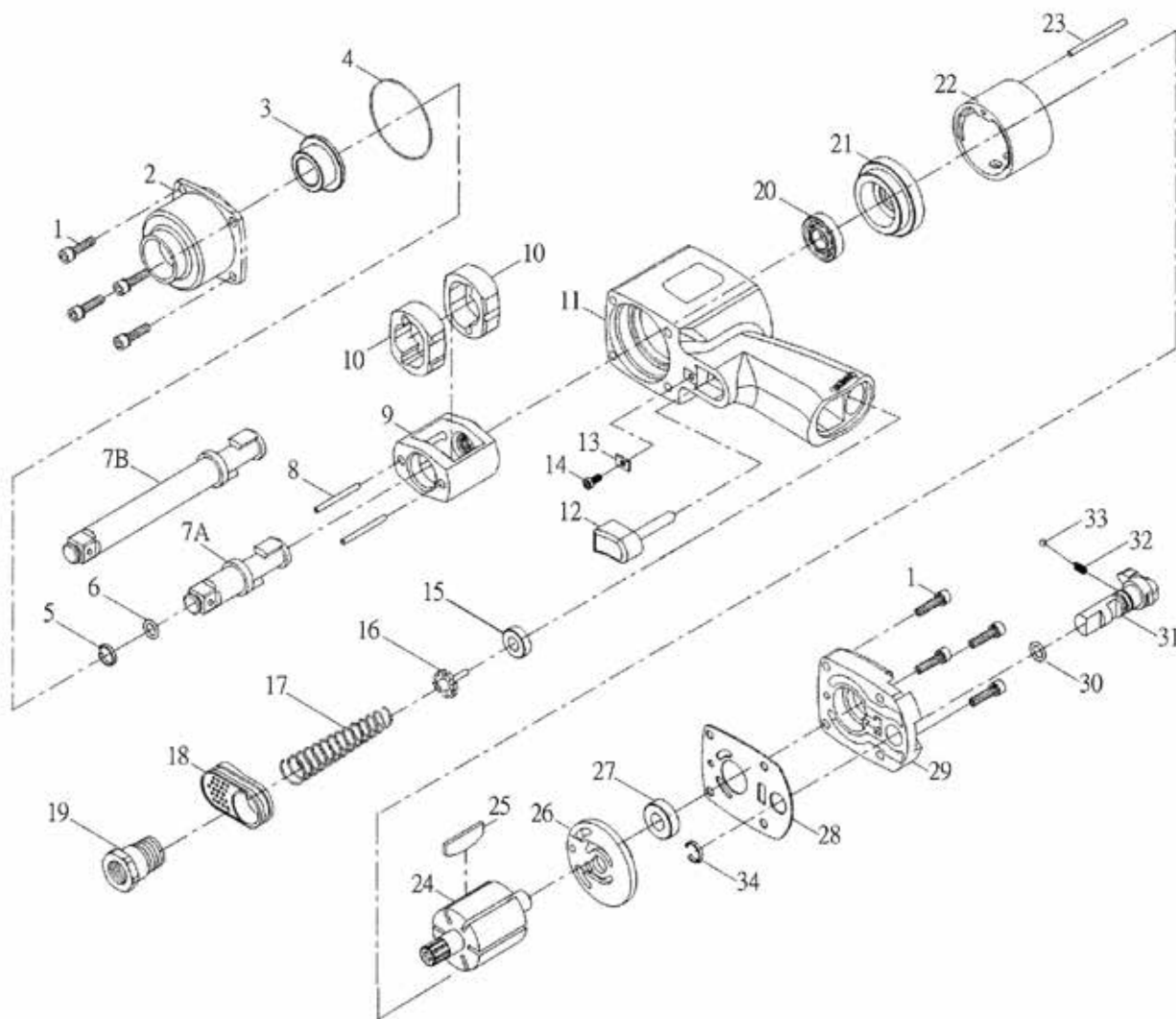

## 600850, 600856 3/4" Dr. Super Duty Lightweight Air Impact Wrenches

No.	Parts No.	Description	Q'TY	CODE
01	068901	Cap Screw	8	002000
02	068902	Hammer Case	1	007500
03	068903	Anvil Bushing	1	003000
04	068904	O-Ring	1	000400
05	068905	Socket Retainer	1	000500
06	068906	O-Ring	1	000250
07A	068907A	Standard Anvil (for 600850)	1	012500
07B	068907B	6" Extended Anvil (for 600856)	1	018000
08	068908	Hammer Pin	2	001000
09	068909	Hammer Frame	1	008400
10	068910	Hammer	2	008000
11	068911	Motor Housing	1	011200
12	068912	Trigger	1	000700
13	068913	Trigger Retainer	1	000250
14	068914	Screw	1	000100
15	068915	Throttle Valve Bushing	1	000500
16	068916	Throttle Valve Stem	1	000500
17	068917	Throttle Valve Spring	1	000500

No.	Parts No.	Description	Q'TY	CODE
18	068918	Exhaust Deflector	1	000500
19	068919	Hose Fitting	1	000850
20	068920	Front Rotor Bearing	1	001200
21	068921	Front End Plate	1	003500
22	068922	Cylinder	1	005000
23	068923	Cylinder Pin	1	000400
24	068924	Rotor	1	005500
25	068925	Rotor Blade	6	003000
26	068926	Rear End Plate	1	003500
27	068927	Rear Rotor Bearing	1	000850
28	068928	Rear Cap Gasket	1	000700
29	068929	Rear Cap	1	003000
30	068930	O-Ring	1	000200
31	068931	Reverse Valve	1	002500
32	068932	Spring	1	000250
33	068933	Steel Ball	1	000200
34	068934	Reverse Valve Retainer	1	000250





# Replacement Parts

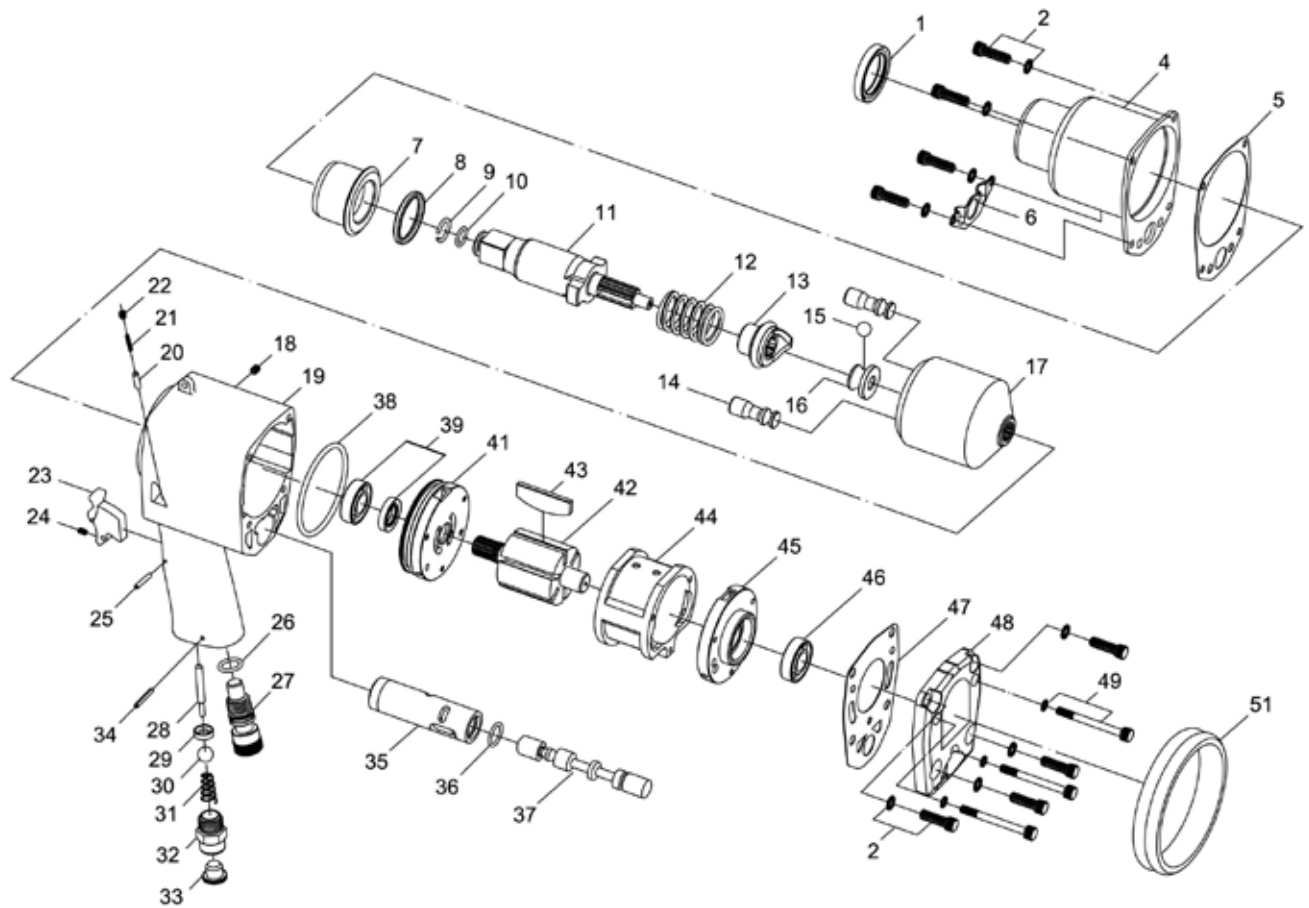

## 600900G 3/4" Dr. Super Duty Air Impact Wrench

No.	Parts No.	Description	Q'TY	CODE	No.	Parts No.	Description	Q'TY	CODE
01	060901	Oil Seal	1	000580	26	060926	O-Ring	1	000150
02	060902	Cap Screw & Washer	8 Set	000600	27	060927	Air Regulator	1	000980
04	060904	Hammer Case	1	004780	28	060928	Throttle Valve Stem	1	000210
05	060905	Hammer Case Gasket	1	000280	29	060929	Throttle Valve Bushing	1	000250
06	060906	Muffle Cover	1	000350	30	060930	Steel Ball	1	000150
07	060907	Anvil Bushing	1	001270	31	060931	Throttle Valve Spring	1	000150
08	060908	Hammer Case Pilot	1	000440	32	060932	Hose Fitting	1	000980
09	060909	Socket Retainer	1	000150	33	060933	Dust Cover	1	000250
10	060910	O-Ring	1	000150	34	060934	Spring Pin	1	000150
11	060911	Standard Anvil	1	010230	35	060935	Valve Sleeve	1	001270
12	060912	Spring	1	000470	36	060936	O-Ring	1	000150
13	060913	Drive Cam	1	001810	37	060937	Reverse Valve	1	000980
14	060914	Hammer Pin	2	001550	38	060938	O-Ring	1	000150
15	060915	Steel Ball	1	000280	39	060939	Front Rotor Bearing & Oil Seal	1 Set	001270
16	060916	Drive Cam Foundation	1	001050	41	060941	Front End Plate	1	001550
17	060917	Hammer Frame	1	007340	42	060942	Rotor	1	004130
18	060918	Set Screw	1	000150	43	060943	Rotor Blade	6	000880
19	060919	Motor Housing	1	009720	44	060944	Cylinder	1	003470
20	060920	Pin	1	000150	45	060945	Rear End Plate	1	001400
21	060921	Spring	1	000150	46	060946	Rear Rotor Bearing	1	000650
22	060922	Screw	1	000150	47	060947	Rear Cap Gasket	1	000370
23	060923	Trigger	1	000370	48	060948	Rear Cap	1	002010
24	060924	Screw	1	000150	49	060949	Screw & Washer	3 Set	000390
25	060925	Trigger Pin	1	000150	51	060951	Protecting Rubber	1	000680

Miscellaneous

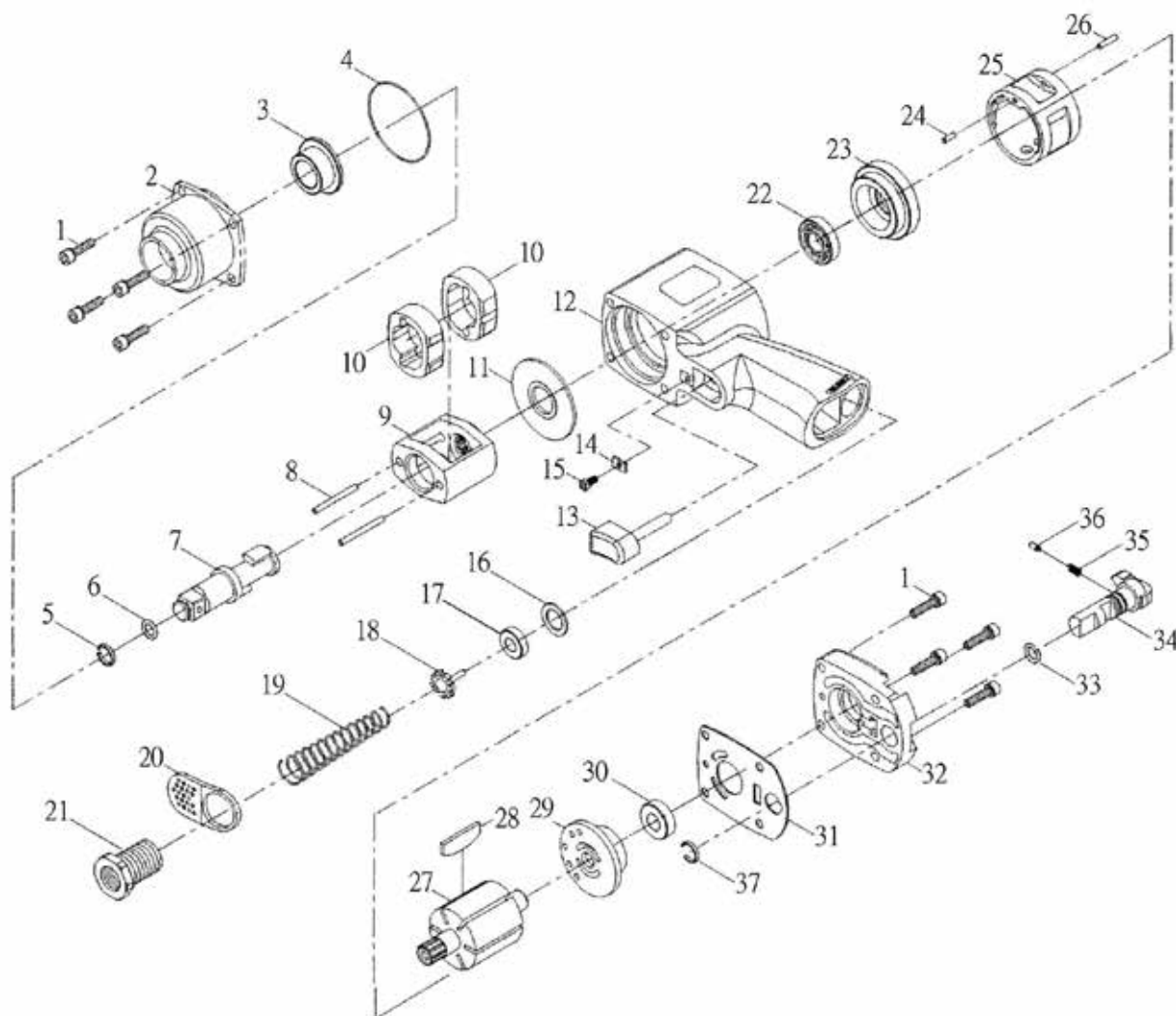

## 601100, 601106 3/4" Dr. Super Duty Air Impact Wrenches

No.	Parts No.	Description	Q'TY	CODE	No.	Parts No.	Description	Q'TY	CODE
01	061101	Cap Screw	8	006400	19	061119	Throttle Valve Spring	1	000500
02	061102	Hammer Case	1	012000	20	061120	Exhaust Deflector	1	000500
03	061103	Anvil Bushing	1	003000	21	061121	Hose Fitting	1	001000
04	061104	O-Ring	1	000150	22	061122	Front Rotor Bearing	1	001000
05	061105	Socket Retainer	1	000300	23	061123	Front End Plate	1	005000
06	061106	O-Ring	1	000150	24	061124	Cylinder Pin (4 x 10)	1	000100
07	061107A	Standard Anvil (for 601100)	1	008000	25	061125	Cylinder	1	006000
	061107B	6" Extended Anvil (for 601106)	1	015000	26	061126	Cylinder Pin (4 x 22)	1	000200
08	061108	Hammer Pin	2	003000	27	061127	Rotor	1	000850
09	061109	Hammer Frame	1	009000	28	061128	Rotor Blade	6	002500
10	061110	Hammer	2	018000	29	061129	Rear End Plate	1	005000
11	061111	Hammer Frame Rear Washer	1	001000	30	061130	Rear Rotor Bearing	1	001000
12	061112	Motor Housing	1	009000	31	061131	Rear Cap Gasket	1	000800
13	061113	Trigger	1	000500	32	061132	Rear Cap	1	003000
14	061114	Trigger Retainer	1	000100	33	061133	O-Ring	1	000120
15	061115	Screw	1	000100	34	061134	Reverse Valve	1	003000
16	061116	Washer	1	000150	35	061135	Spring	1	000120
17	061117	Throttle Valve Bushing	1	000600	36	061136	Steel Ball	1	000120
18	061118	Throttle Valve Stem	1	000700	37	061137	Reverse Valve Retainer	1	000120

# Replacement Parts

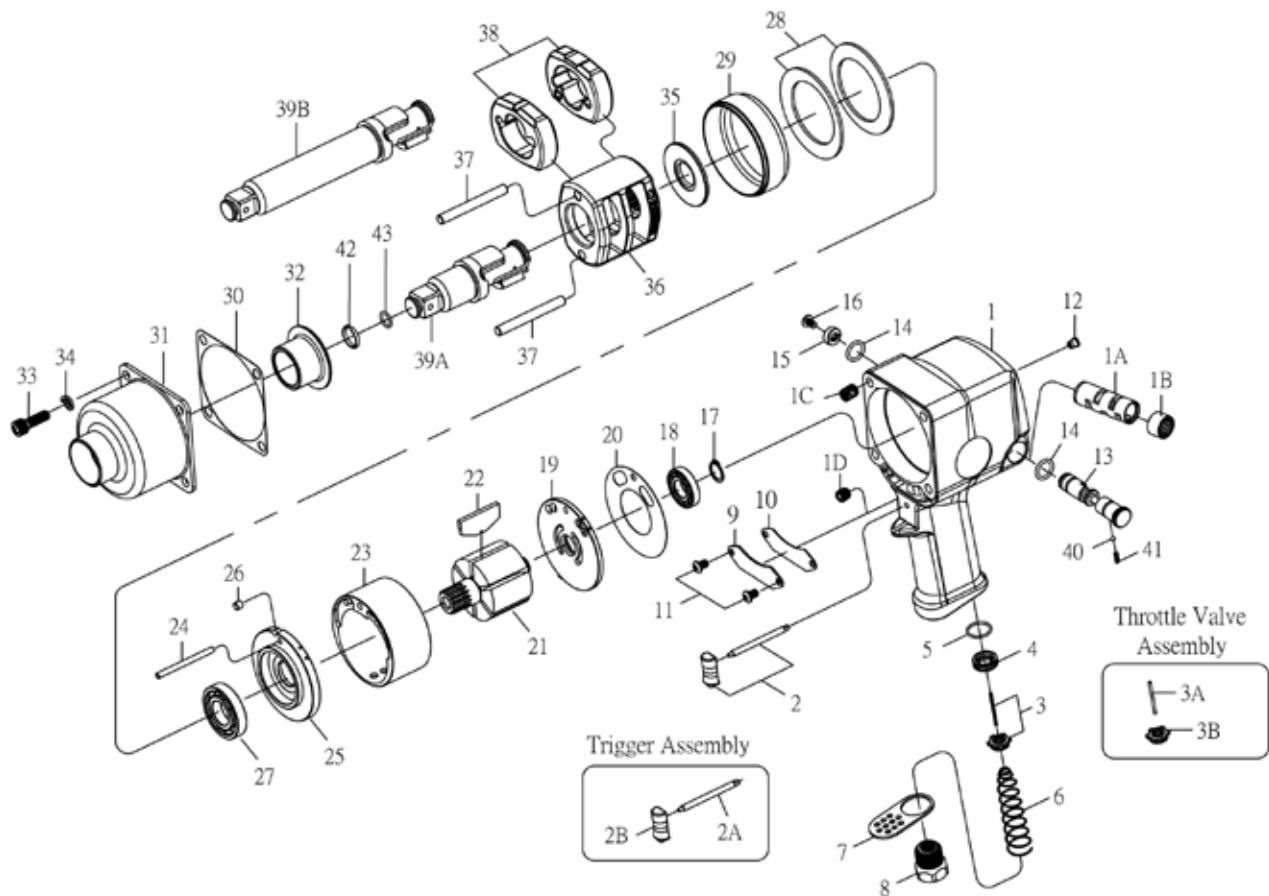

## 6K1490 3/4" Dr. Ultra Duty Air Impact Wrench

No.	Parts No.	Description	Q'TY	CODE	No.	Parts No.	Description	Q'TY	CODE
★ 01	08K601	Motor Housing Assembly (incl. 1A, 1B, 1C(4), 1D, 12)	1 Set	026600	★ 19	08K619	Rear End Plate Assembly (incl. 18)	1 Set	010050
● 01A	08K601A	Valve Sleeve	1	-	20	08K620	Gasket	1	000980
● 01B	08K601B	Reverse Valve Bushing Gear	1	-	21	08K621	Rotor	1	016060
● 01C	08K601C	Heli-Coil	4	-	22	08K622	Rotor Blade	6	004130
● 01D	08K601D	Set Screw	1	-	23	08K623	Cylinder	1	014950
★ 02	08K602	Trigger Assembly (incl. 2A, 2B)	1 Set	001520	24	08K624	Cylinder Pin	1	000390
● 02A	08K602A	Trigger Pin	1	-	★ 25	08K625	Front End Plate Assembly (incl. 27)	1 Set	011000
● 02B	08K602B	Trigger	1	-	26	08K626	Pin	1	000280
★ 03	08K603	Throttle Valve Assembly (incl. 3A, 3B)	1 Set	000860	● 27	08K627	Front Rotor Bearing	1	-
● 03A	08K603A	Throttle Valve Pin	1	-	28	08K628	Motor Clamp Washer	2	002820
● 03B	08K603B	Throttle Valve	1	-	29	08K629	Separator	1	003300
04	08K604	Throttle Valve Seat	1	000550	30	08K630	Hammer Case Gasket	1	001520
05	08K605	O-Ring	1	000180	31	08K631	Hammer Case	1	012570
06	08K606	Throttle Valve Spring	1	000280	32	08K632	Anvil Bushing	1	003300
07	08K607	Exhaust Deflector	1	001520	33	08K633	Cap Screw	4	000670
08	08K608	Hose Fitting	1	001520	34	08K634	Spring Washer	4	000230
09	08K609	Housing Plate	1	001520	35	08K635	Hammer Frame Rear Washer	1	002050
10	08K610	Gasket	1	000350	36	08K636	Hammer Frame	1	017290
11	08K611	Screw	2	000280	37	08K637	Hammer Pin	2	001520
● 12	08K612	Grease Fitting	1	-	38	08K638	Hammer	2	014950
13	08K613	Reverse Valve	1	004130	39A	06K439A	Standard Anvil (for 6K1490)	1	030060
14	08K614	O-Ring	2	000310	40	08K640	Steel Ball	1	000100
15	08K615	Reverse Valve Knob	1	000280	41	08K641	Spring	1	000130
16	08K616	Screw	1	000180	TK	08K6TK	Tune-Up Kit ( 5, 6, 14(2), 17, 18, 20, 22(6), 27, 30, 40, 41 )	1 Set	012110
17	08K617	Retainer	1	000180					
● 18	08K618	Rear Rotor Bearing	1	-					

★ Must be purchased in assembly set

● Cannot be sold separately due to assembly difficulty

Miscellaneous

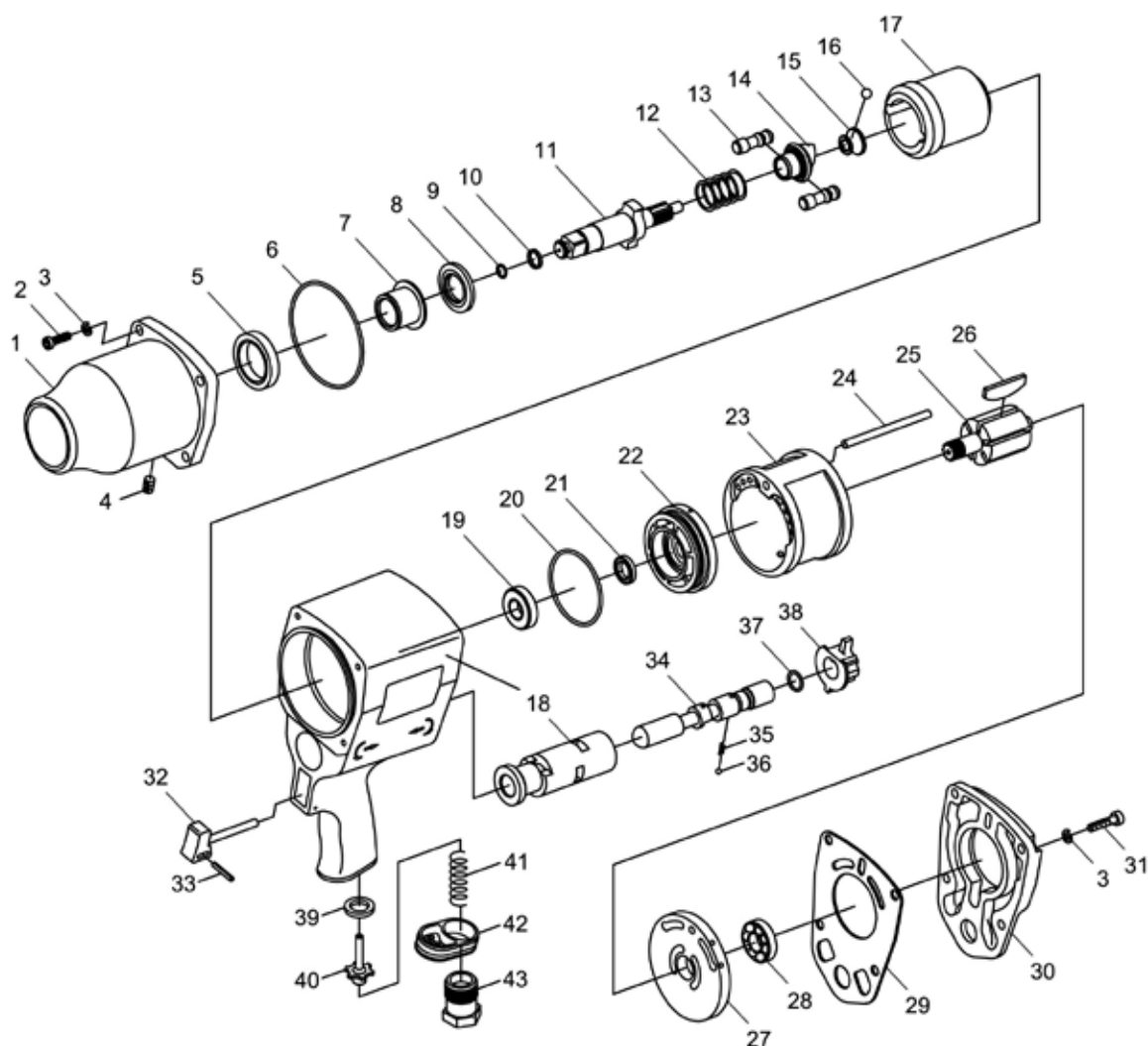

## 601200G 3/4" Dr. Super Duty Air Impact Wrench

No.	Parts No.	Description	Q'TY	CODE	No.	Parts No.	Description	Q'TY	CODE
01	061201	Hammer Case	1	005010	22	061222	Front End Plate	1	002820
02	061202	Cap Screw	4	000460	23	061223	Cylinder	1	006480
03	061203	Spring Washer	8	000800	24	061224	Cylinder Pin	1	000410
04	061204	Oil Plug	1	000300	25	061225	Rotor	1	007770
05	061205	Oil Seal	1	000570	26	061226	Rotor Blade	6	002700
06	061206	O-Ring	1	000410	27	061227	Rear End Plate	1	003210
07	061207	Anvil Bushing	1	003130	28	061228	Rear Rotor Bearing	1	001400
08	061208	Hammer Case Pilot	1	001690	29	061229	Rear Cap Gasket	1	000850
09	061209	O-Ring	1	000250	30	061230	Rear Cap	1	002320
10	061210	Socket Retainer	1	000250	31	061231	Screw	4	000460
11	061211	Standard Anvil	1	009080	32	061232	Trigger	1	000650
12	061212	Spring	1	000570	33	061233	Trigger Pin	1	000250
13	061213	Hammer Pin	2	002210	34	061234	Reverse Valve	1	002120
14	061214	Drive Cam	1	003860	35	061235	Spring	1	000250
15	061215	Drive Cam Foundation	1	001270	36	061236	Steel Ball	1	000250
16	061216	Steel Ball	1	000320	37	061237	O-Ring	1	000250
17	061217	Hammer Cage	1	009950	38	061238	Air Regulator	1	000570
18	061218	Motor Housing with Valve Sleeve	1	018530	39	061239	Throttle Valve Bushing	1	000570
19	061219	Front Rotor Bearing	1	002180	40	061240	Throttle Valve Stem	1	000570
20	061220	O-Ring	1	000320	41	061241	Throttle Valve Spring	1	000300
21	061221	Oil Seal	1	000410	42	061242	Exhaust Deflector	1	000410
					43	061243	Hose Fitting	1	001830

# Replacement Parts

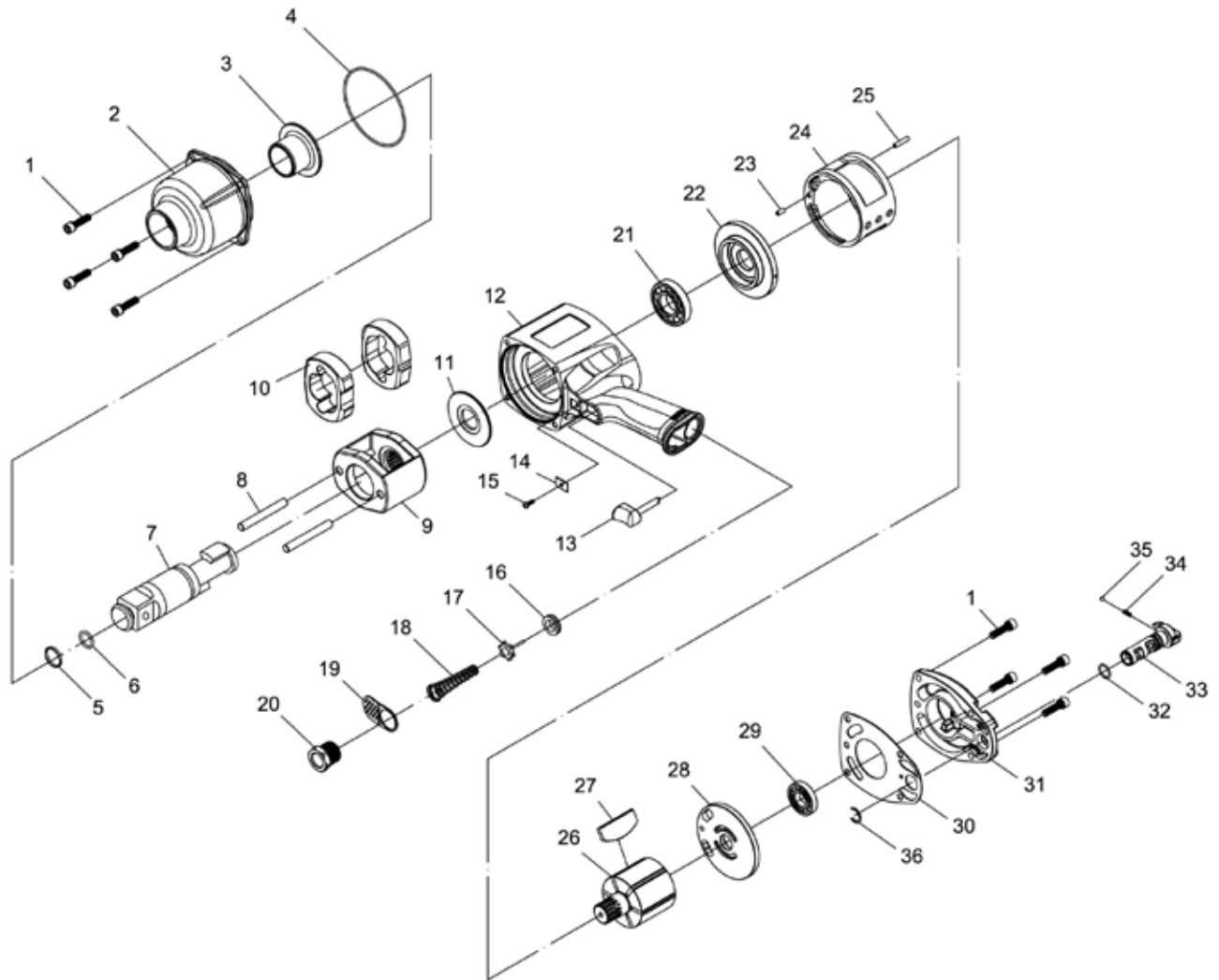

## 601400, 601406 3/4" Dr. Ultra Duty Air Impact Wrenches

No.	Parts No.	Description	Q'TY	CODE	No.	Parts No.	Description	Q'TY	CODE
01	081501	Cap Screw	8	000860	19	081519	Exhaust Deflector	1	000500
02	081502	Hammer Case	1	007670	20	081520	Hose Fitting	1	001200
03	081503	Anvil Bushing	1	002940	21	081521	Front Rotor Bearing	1	002270
04	081504	O-Ring	1	000370	22	081522	Front End Plate	1	008510
05	061405	Socket Retainer	1	000340	23	081523	Cylinder Pin (4 x 30)	1	000150
06	061406	O-Ring	1	000250	24	081524	Cylinder	1	010100
07A	061407A	Standard Anvil (for 601400)	1	017880	25	081525	Cylinder Pin (4 x 32)	1	000210
07B	061407B	6" Extended Anvil (for 601406)	1	033910	26	081526	Rotor	1	009980
08	081508	Hammer Pin	2	000980	27	081527	Rotor Blade	6	003660
09	081509	Hammer Frame	1	012320	28	081528	Rear End Plate	1	008250
10	081510	Hammer	2	011570	29	081529	Rear Rotor Bearing	1	001550
11	081511	Hammer Frame Rear Washer	1	000680	30	081530	Rear Cap Gasket	1	001550
12	081512	Motor Housing	1	013210	31	081531	Rear Cap	1	004130
13	081513	Trigger	1	000550	32	081532	O-Ring	1	000210
14	081514	Trigger Retainer	1	000250	33	081533	Reverse Valve	1	003750
15	081515	Screw	1	000150	34	081534	Spring	1	000250
16	081516	Throttle Valve Bushing	1	000730	35	081535	Steel Ball	1	000210
17	081517	Throttle Valve Stem	1	000830	36	081536	Reverse Valve Retainer	1	000250
18	081518	Throttle Valve Spring	1	000550					

Miscellaneous

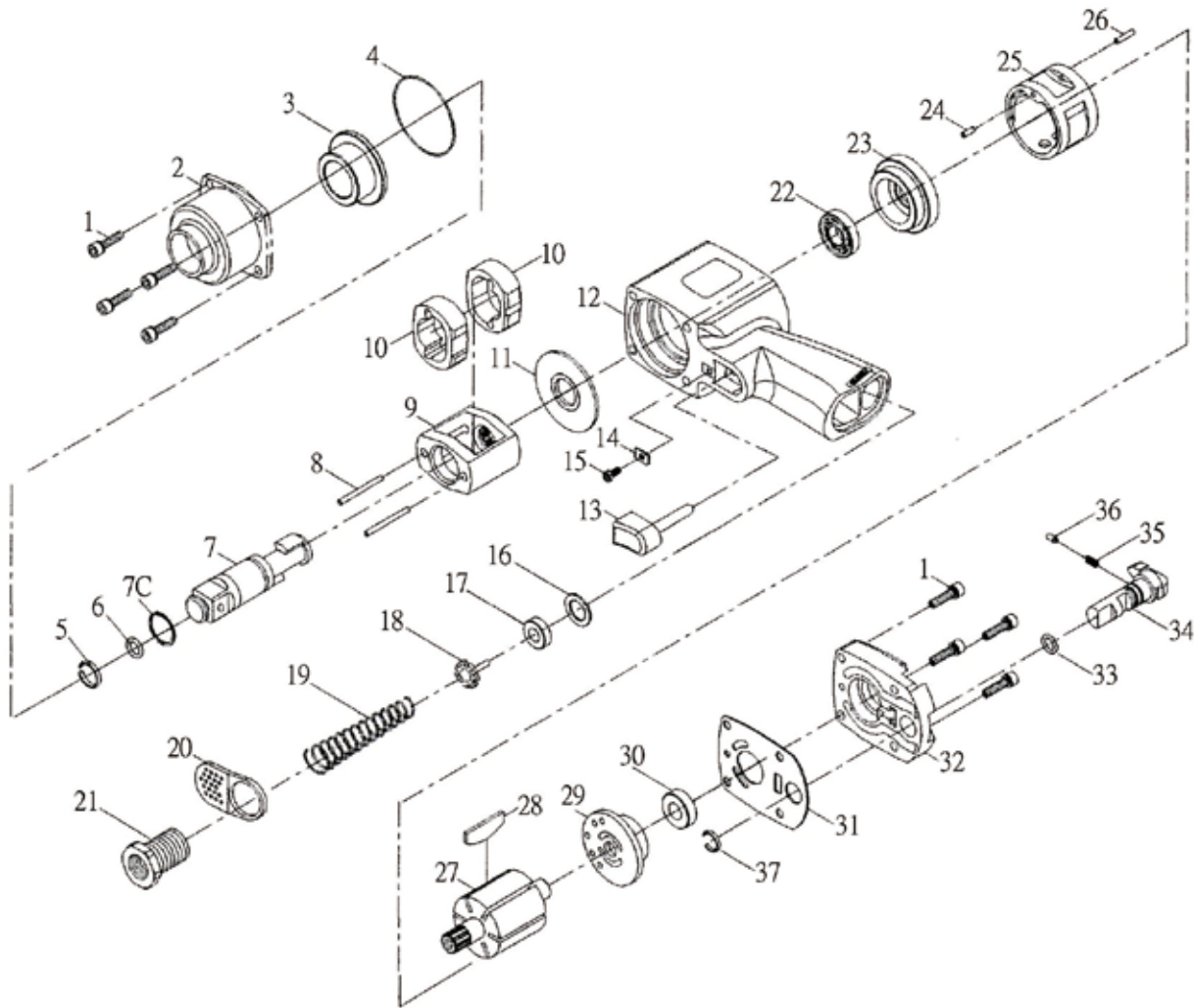

## 801200, 801206 1" Dr.Heavy Duty Lightweight Air Impact Wrenches

No.	Parts No.	Description	Q'TY	CODE
01	081201	Cap Screw	8	006400
02	081202	Hammer Case	1	012000
03	081203	Anvil Bushing	1	003000
04	081204	O-Ring	1	000150
05	081205	Socket Retainer	1	000350
06	081206	O-Ring	1	000150
	081207A	Standard Anvil (for 801200)	1	009000
07	081207B	6" Extended Anvil (for 801206)	1	015000
	081207C	Anvil Snap Ring	1	000500
08	081208	Hammer Pin	2	001200
09	081209	Hammer Frame	1	009000
10	081210	Hammer	2	018000
11	081211	Hammer Frame Rear Washer	1	001000
12	081212	Motor Housing	1	009000
13	081213	Trigger	1	000500
14	081214	Trigger Retainer	1	000100
15	081215	Screw	1	000100
16	081216	Washer	1	000150
17	081217	Throttle Valve Bushing	1	000600
18	081218	Throttle Valve Stem	1	000700

No.	Parts No.	Description	Q'TY	CODE
19	081219	Throttle Valve Spring	1	000500
20	081220	Muffle Cover	1	000500
21	081221	Hose Fitting	1	001000
22	081222	Front Rotor Bearing	1	001000
23	081223	Front End Plate	1	005000
24	081224	Cylinder Pin (4 x 10)	1	000100
25	081225	Cylinder	1	006000
26	081226	Cylinder Pin (4 x 22)	1	000200
27	081227	Rotor	1	008500
28	081228	Rotor Blade	6	002500
29	081229	Rear End Plate	1	005000
30	081230	Rear Rotor Bearing	1	001000
31	081231	End Plate Gasket	1	000800
32	081232	Rear Cap	1	003000
33	081233	O-ring	1	000120
34	081234	Reverse Valve	1	003000
35	081235	Spring	1	000120
36	081236	Steel Ball	1	000120
37	081237	Reverse Valve Retainer	1	000120

# Replacement Parts

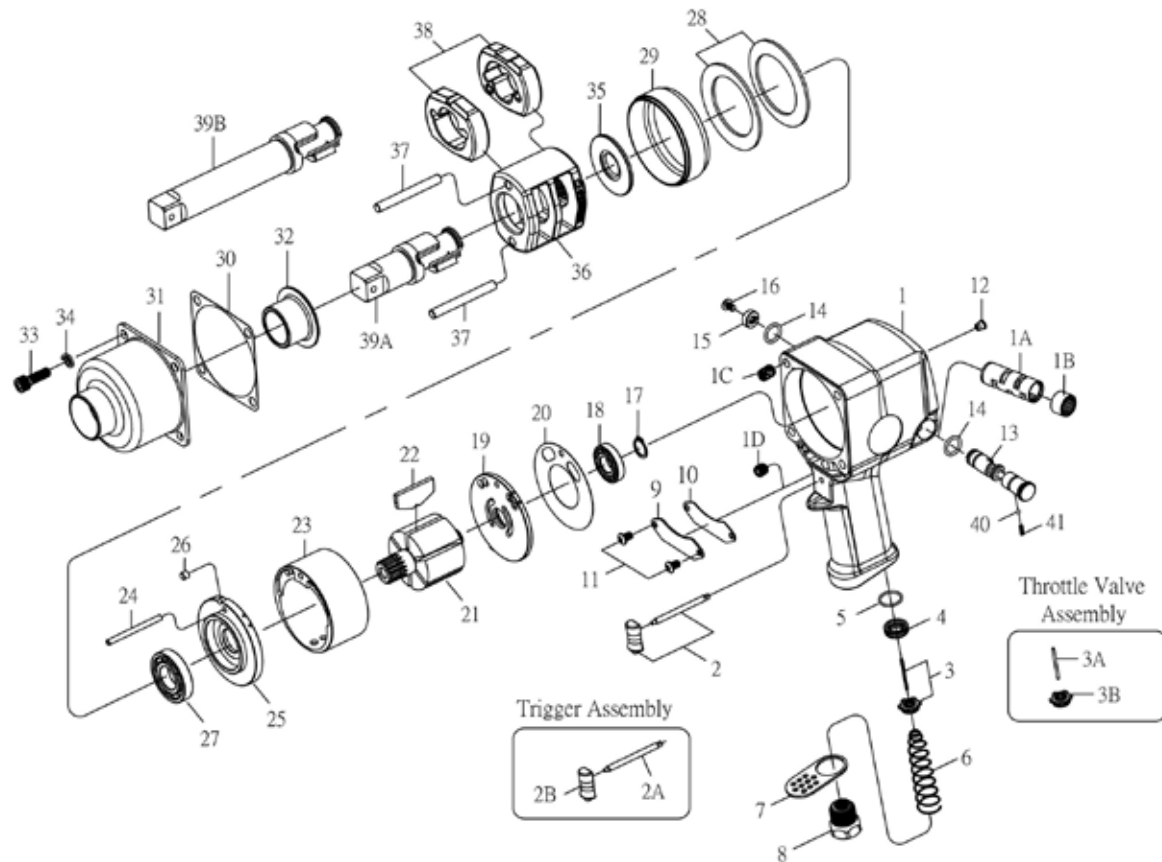

## 8K1630, 8K1636 1" Dr. Ultra Duty Air Impact Wrenches

No.	Parts No.	Description	Q'TY	CODE	No.	Parts No.	Description	Q'TY	CODE
★ 01	08K601	Motor Housing Assembly (incl. 1A, 1B, 1C(4), 1D, 12)	1 Set	026600	★ 19	08K619	Rear End Plate Assembly (incl. 18)	1 Set	010050
● 01A	08K601A	Valve Sleeve	1	-	20	08K620	Gasket	1	000980
● 01B	08K601B	Reverse Valve Bushing Gear	1	-	21	08K621	Rotor	1	016060
● 01C	08K601C	Heli-Coil	4	-	22	08K622	Rotor Blade	6	004130
● 01D	08K601D	Set Screw	1	-	23	08K623	Cylinder	1	014950
★ 02	08K602	Trigger Assembly (incl. 2A, 2B)	1 Set	001520	24	08K624	Cylinder Pin	1	000390
● 02A	08K602A	Trigger Pin	1	-	★ 25	08K625	Front End Plate Assembly (incl. 27)	1 Set	011000
● 02B	08K602B	Trigger	1	-	26	08K626	Pin	1	000280
★ 03	08K603	Throttle Valve Assembly (incl. 3A, 3B)	1 Set	000860	● 27	08K627	Front Rotor Bearing	1	-
● 03A	08K603A	Throttle Valve Pin	1	-	28	08K628	Motor Clamp Washer	2	002820
● 03B	08K603B	Throttle Valve	1	-	29	08K629	Separator	1	003300
04	08K604	Throttle Valve Seat	1	000550	30	08K630	Hammer Case Gasket	1	001520
05	08K605	O-Ring	1	000180	31	08K631	Hammer Case	1	012570
06	08K606	Throttle Valve Spring	1	000280	32	08K632	Anvil Bushing	1	003300
07	08K607	Exhaust Deflector	1	001520	33	08K633	Cap Screw	4	000670
08	08K608	Hose Fitting	1	001520	34	08K634	Spring Washer	4	000230
09	08K609	Housing Plate	1	001520	35	08K635	Hammer Frame Rear Washer	1	002050
10	08K610	Gasket	1	000350	36	08K636	Hammer Frame	1	017290
11	08K611	Screw	2	000280	37	08K637	Hammer Pin	2	001520
● 12	08K612	Grease Fitting	1	-	38	08K638	Hammer	2	014950
13	08K613	Reverse Valve	1	004130	39A	08K639A	Standard Anvil (for 8K1630)	1	030060
14	08K614	O-Ring	2	000310	39B	08K639B	6" Extended Anvil (for 8K1636)	1	042900
15	08K615	Reverse Valve Knob	1	000280	40	08K640	Steel Ball	1	000100
16	08K616	Screw	1	000180	41	08K641	Spring	1	000130
17	08K617	Retainer	1	000180	TK	08K6TK	Tune-Up Kit ( 5, 6, 14(2), 17, 18, 20, 22(6), 27, 30, 40, 41 )	1 Set	012110
● 18	08K618	Rear Rotor Bearing	1	-					

★ Must be purchased in assembly set

● Cannot be sold separately due to assembly difficulty

Miscellaneous

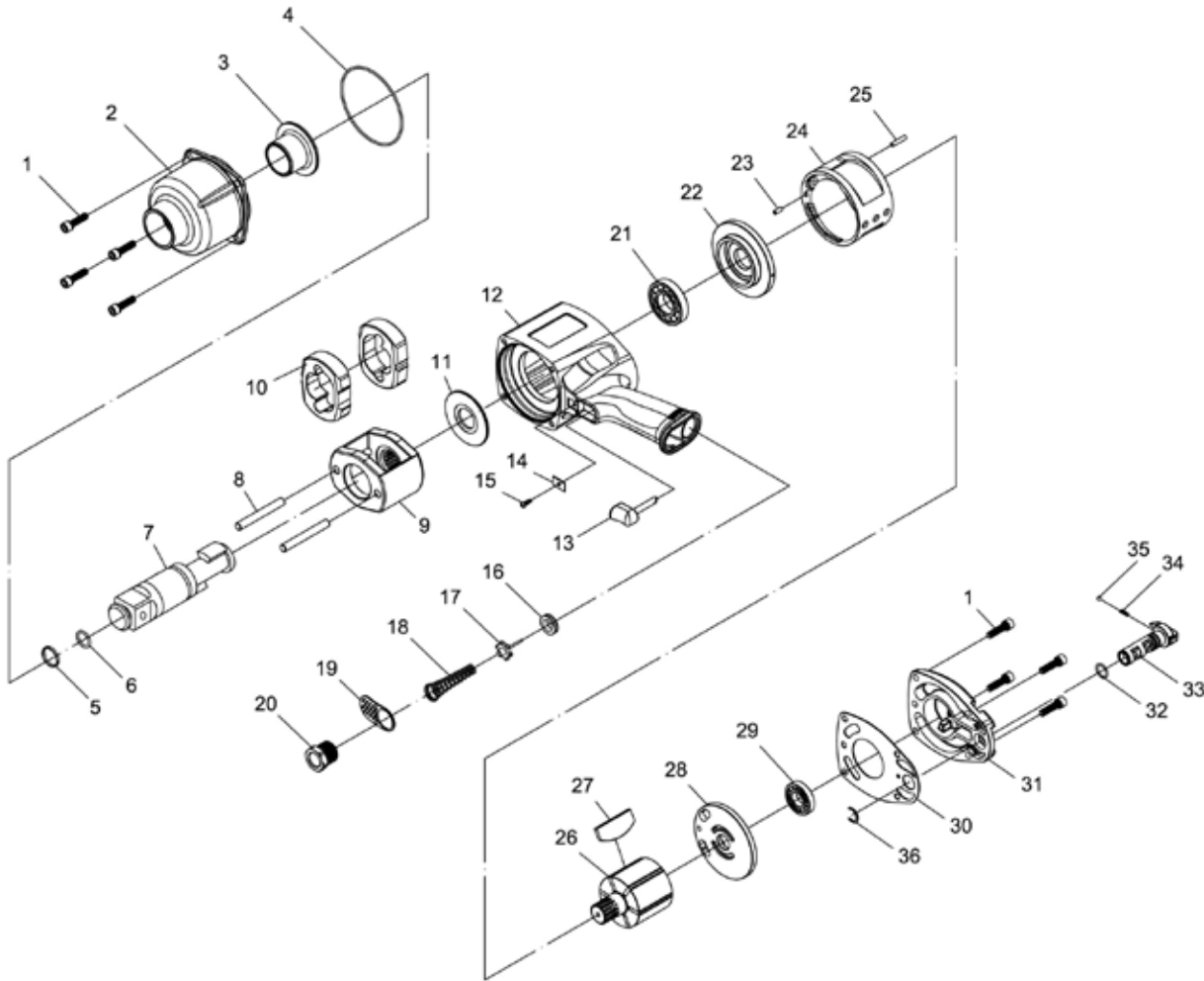

## 801512, 801518 1" Dr. Super Duty Lightweight Air Impact Wrenches

No.	Parts No.	Description	Q'TY	CODE	No.	Parts No.	Description	Q'TY	CODE
01	081501	Cap Screw	8	000860	19	081519	Exhaust Deflector	1	000500
02	081502	Hammer Case	1	007670	20	081520	Hose Fitting	1	001200
03	081503	Anvil Bushing	1	002940	21	081521	Front Rotor Bearing	1	002270
04	081504	O-Ring	1	000370	22	081522	Front End Plate	1	008510
05	081505	Socket Retainer	1	000340	23	081523	Cylinder Pin (4 x 30)	1	000150
06	081506	O-Ring	1	000250	24	081524	Cylinder	1	010100
07A	081507A	Standard Anvil (for 801512)	1	017880	25	081525	Cylinder Pin (4 x 32)	1	000210
07B	081507B	6" Extended Anvil (for 801518)	1	033910	26	081526	Rotor	1	009980
08	081508	Hammer Pin	2	000980	27	081527	Rotor Blade	6	003660
09	081509	Hammer Frame	1	012320	28	081528	Rear End Plate	1	008250
10	081510	Hammer	2	011570	29	081529	Rear Rotor Bearing	1	001550
11	081511	Hammer Frame Rear Washer	1	000680	30	081530	Rear Cap Gasket	1	001550
12	081512	Motor Housing	1	013210	31	081531	Rear Cap	1	004130
13	081513	Trigger	1	000550	32	081532	O-Ring	1	000210
14	081514	Trigger Retainer	1	000250	33	081533	Reverse Valve	1	003750
15	081515	Screw	1	000150	34	081534	Spring	1	000250
16	081516	Throttle Valve Bushing	1	000730	35	081535	Steel Ball	1	000210
17	081517	Throttle Valve Stem	1	000830	36	081536	Reverse Valve Retainer	1	000250
18	081518	Throttle Valve Spring	1	000550					



# Replacement Parts

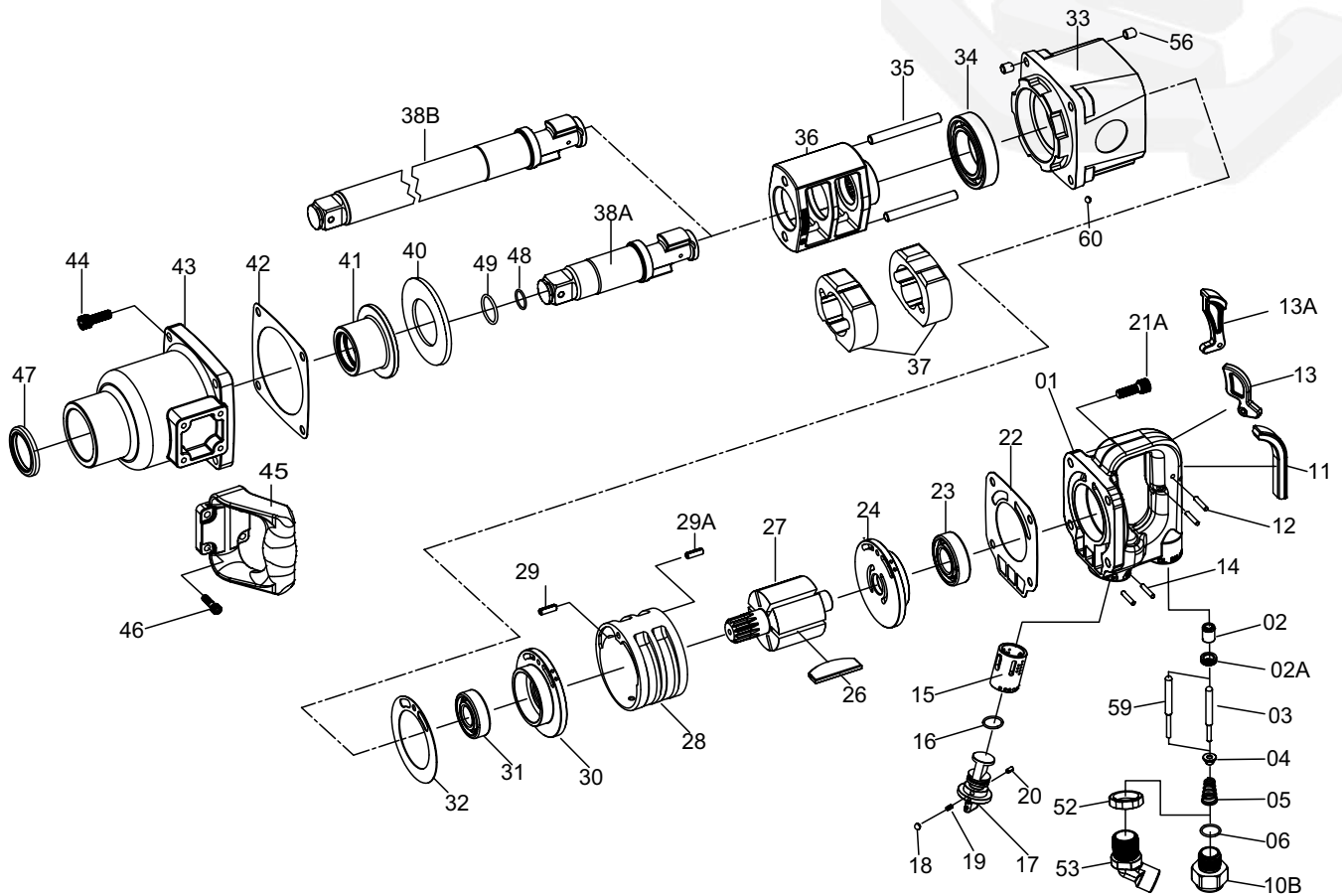

## 801500, 801506 1" Dr. Air Impact Wrenches

No.	Parts No.	Description	Q'TY	CODE	No.	Parts No.	Description	Q'TY	CODE
★01	081001	Trigger Handle (incl. 2, 15)	1	008890	29	081029	Spring Pin	1	000100
●02	081002	Throttle Valve Bushing	1	000330	29A	081029A	Spring Pin	1	000100
02A	081002A	Throttle Valve Seat	1	000460	★30	081030	Front End Plate (incl. 31)	1	004710
03	081003	Throttle Valve Stem	1	000460	●31	081031	Front Rotor Bearing	1	001330
04	081004	Throttle Valve	1	000370	32	081032	End Plate Gasket	1	000860
05	081005	Throttle Valve Spring	1	000180	★33	081033	Motor Housing (incl. 56, 60)	1	011110
06	081006	O-Ring	1	000110	34	081034	Bearing	1	003000
10B	081010B	Hose Fitting	1	001600	35	081035	Hammer Pin	2	002130
11	081011	Rubber Cap (For Inside Trigger)	1	000270	36	081036	Hammer Frame	1	017200
12	081012	Trigger Pin	2	000200	37	081037	Hammer	2	017200
13	081013	Trigger	1	000460	38A	081038A	Standard Anvil (for 801500)	1	025810
14	081014	Spring Pin	2	000100	38B	081038B	6" Extended Anvil (for 801506)	1	025810
●15	081015	Valve Sleeve	1	002250	40	081040	Thrust Washer	1	001140
16	081016	O-Ring	1	000110	●41	081041	Anvil Bushing	1	003250
17	081017	Reverse Valve	1	003750	42	081042	Hammer Case Gasket	1	000860
18	081018	Steel Ball	1	000100	★43	081043	Hammer Case (incl. 41)	1	008890
19	081019	Spring	1	000100	44	081044	Cap Screw	4	000370
20	081020	Spring Pin	1	000100	44A	081044A	Spring Washer	4	000150
21	081021	Spring Washer	4	000150	45	081045	Side Spade Handle	1	004710
21A	081021A	Cap Screw	4	000370	46	081046	Screw	4	000370
22	081022	Rear Cap Gasket	1	000860	46A	081046A	Spring Washer	4	000150
●23	081023	Rear Motor Bearing	1	001140	47	081047	Hammer Case Seal	1	000710
★24	081024	Rear End Plate (incl. 23)	1	004710	48	081048	O-Ring	1	000110
26	081026	Rotor Blade	6	007060	49	081049	Socket Retainer	1	000330
27	081027	Rotor	1	013980	●56	081056	Heil-Coil	8	002330
28	081028	Cylinder	1	011110	59	081059	Valve Stem (for outside trigger)	1	000680
					●60	081060	Steel Ball	4	000200
					TK	0810TK	Tune-Up Kit (incl. 2A.6.16)	1 set	000680

★ Must be purchased in assembly set  
 ● Cannot be sold separately due to assembly difficulty

Miscellaneous

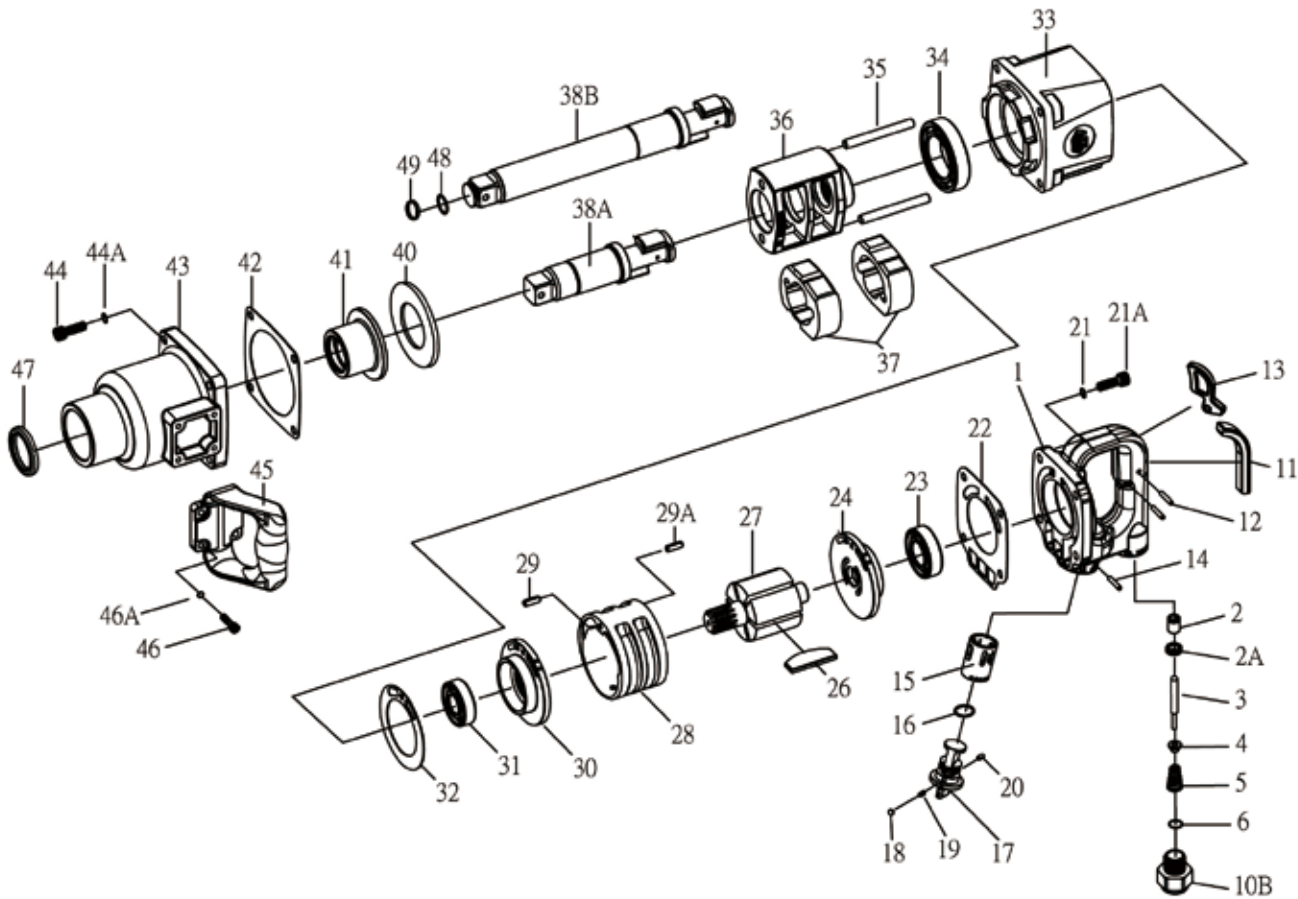

## 801800, 801806 1" Dr. Super Duty Air Impact Wrenches

No.	Parts No.	Description	Q'TY	CODE	No.	Parts No.	Description	Q'TY	CODE		
★	01	081801	Trigger Handle (incl. 2, 15)	1	011560	29A	081829A	Spring Pin	1	000100	
●	02	081802	Throttle Valve Bushing	1	000430	★	30	081830	Front End Plate (incl. 31)	1	006120
	02A	081802A	Throttle Valve Seat	1	000600	●	31	081831	Front Rotor Bearing	1	001330
	03	081803	Throttle Valve Plunger	1	000600	32	081832	End Plate Gasket	1	001120	
	04	081804	Throttle Valve	1	000480	33	081833	Motor Housing	1	014440	
	05	081805	Throttle Valve Spring	1	000230	34	081834	Bearing	1	003900	
	06	081806	O-Ring	1	000140	35	081835	Hammer Pin	2	002770	
	10B	081810B	Hose Fitting	1	002080	36	081836	Hammer Frame	1	022360	
	11	081811	Rubber Cap (For Inside Trigger)	1	000350	37	081837	Hammer	2	022360	
	12	081812	Trigger Pin	2	000260	38A	081838A	Standard Anvil (for 801800)	1	033550	
	13	081813	Trigger	1	000600	38B	081838B	6" Extended Anvil (for 801806)	1	038000	
	14	081814	Spring Pin	1	000100	39A	081839A	Standard Anvil (for 501800)	1	046530	
●	15	081815	Valve Sleeve	1	002930	39B	081839B	6" Extended Anvil (for 501806)	1	048870	
	16	081816	O-Ring	1	000140	40	081840	Thrust Washer	1	001480	
	17	081817	Reverse Valve	1	004880	41	081841	Anvil Bushing	1	004230	
	18	081818	Steel Ball	1	000100	42	081842	Hammer Case Gasket	1	001120	
	19	081819	Spring	1	000100	43	081843	Hammer Case	1	011560	
	20	081820	Spring Pin	1	000100	44	081844	Cap Screw	4	000480	
	21	081821	Spring Washer	4	000200	44A	081844A	Spring Washer	4	000200	
	21A	081821A	Cap Screw	4	000480	45	081845	Side Spade Handle	1	006120	
●	22	081822	Rear Cap Gasket (incl. 23)	1	001120	46	081846	Screw	4	000480	
★	23	081823	Rear Motor Bearing	1	001480	46A	081846A	Spring Washer	4	000200	
	24	081824	Rear End Plate	1	006120	47	081847	Hammer Case Seal	1	000920	
	26	081826	Rotor Blade	6	009180	48	081848	O-Ring	1	000140	
	27	081827	Rotor	1	018170	49	081849	Socket Retainer	1	000430	
	28	081828	Cylinder	1	014440	TK	0818TK	une-Up Kit (incl. 2A.6.9.16)	1 set	001080	
	29	081829	Spring Pin	1	000100						

★ Must be purchased in assembly set  
 ● Cannot be sold separately due to assembly difficulty

# Replacement Parts

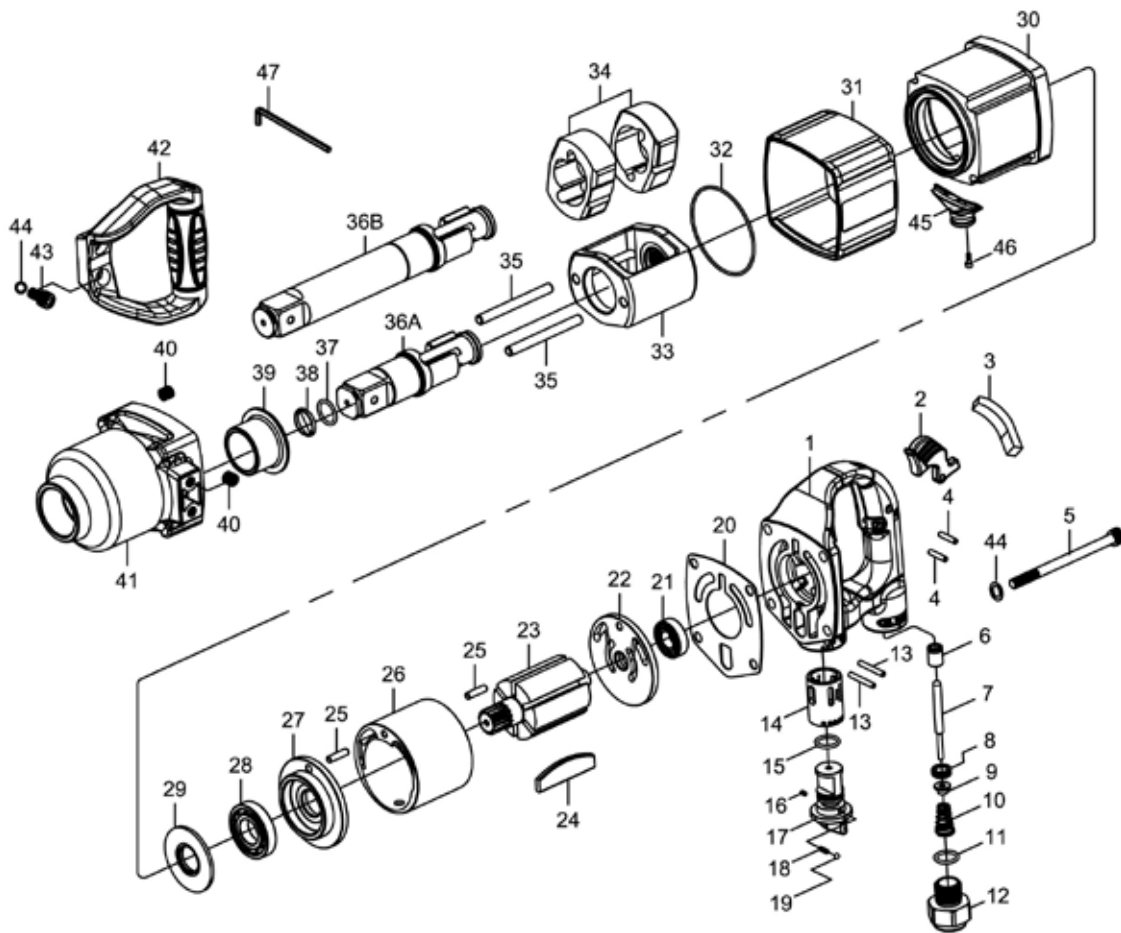

## 802000, 802006 1" Dr. Super Duty Lightweight Air Impact Wrenches

No.	Parts No.	Description	Q'TY	CODE	No.	Parts No.	Description	Q'TY	CODE
★ 01	082001	Trigger Handle Assembly (incl. 6, 14)	1 Set	020870	25	082025	Spring Pin	2	000320
02	082002	Trigger	1	000550	26	082026	Cylinder	1	015560
03	082003	Rubber Cap	1	000550	27	082027	Front End Plate	1	006870
04	082004	Pin	2	000280	28	082028	Bearing	1	003720
05	082005	Screw	4	001570	29	082029	Washer	1	002060
● 06	082006	Bushing	1	000460	30	082030	Motor Housing	1	009460
07	082007	Throttle Valve Plunger	1	000830	31	082031	Rubber Grip	1	001810
08	082008	Throttle Valve Seat	1	000680	32	082032	O-Ring	1	000350
09	082009	Throttle Valve	1	000490	33	082033	Hammer Frame	1	017040
10	082010	Spring	1	000300	34	082034	Hammer	2	017290
11	082011	O-Ring	1	000150	35	082035	Hammer Pin	2	002320
12	082012	Hose Fitting	1	002820	36A	082036A	Standard Anvil (for 802000)	1	021840
13	082013	Spring Pin	2	000280	36B	082036B	6" Extended Anvil (for 802006)	1	033670
● 14	082014	Reverse Valve Bushing	1	004640	37	082037	O-Ring	1	000250
15	082015	O-Ring	1	000150	38	082038	Socket Retainer	1	000410
16	082016	Pin	1	000150	● 39	082039	Bushing	1	002820
17	082017	Reverse Valve	1	004130	● 40	082040	Heli-Coil	6	001810
18	082018	Spring	1	000210	★ 41	082041	Hammer Case Assembly (incl. 8)	1 Set	013700
19	082019	Steel Ball	1	000150	42	082042	Side Spade Handle	1	007800
20	082020	Gasket	1	001110	43	082043	Screw	2	000320
● 21	082021	Bearing	1	001520	44	082044	Spring Washer	6	000320
★ 22	082022	Rear End Plate Assembly (incl. 21)	1 Set	006850	45	082045	Exhaust Deflector	1	000830
23	082023	Rotor	1	015310	46	082046	Screw	2	000320
24	082024	Rotor Blade	6	012060	47	082047	Hex Key	1	000300
★		Must be purchased in assembly set			TK	0820TK	Tune-Up Kit ( 10, 11, 15, 18, 19, 20, 24, 32, 37, 38 )	1 Set	013700
●		Cannot be sold separately due to assembly difficulty							

Miscellaneous

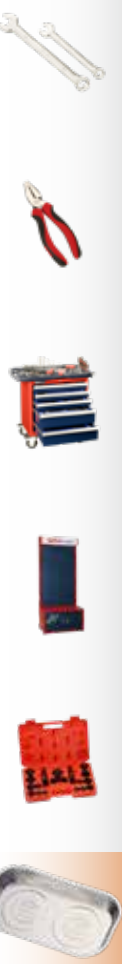
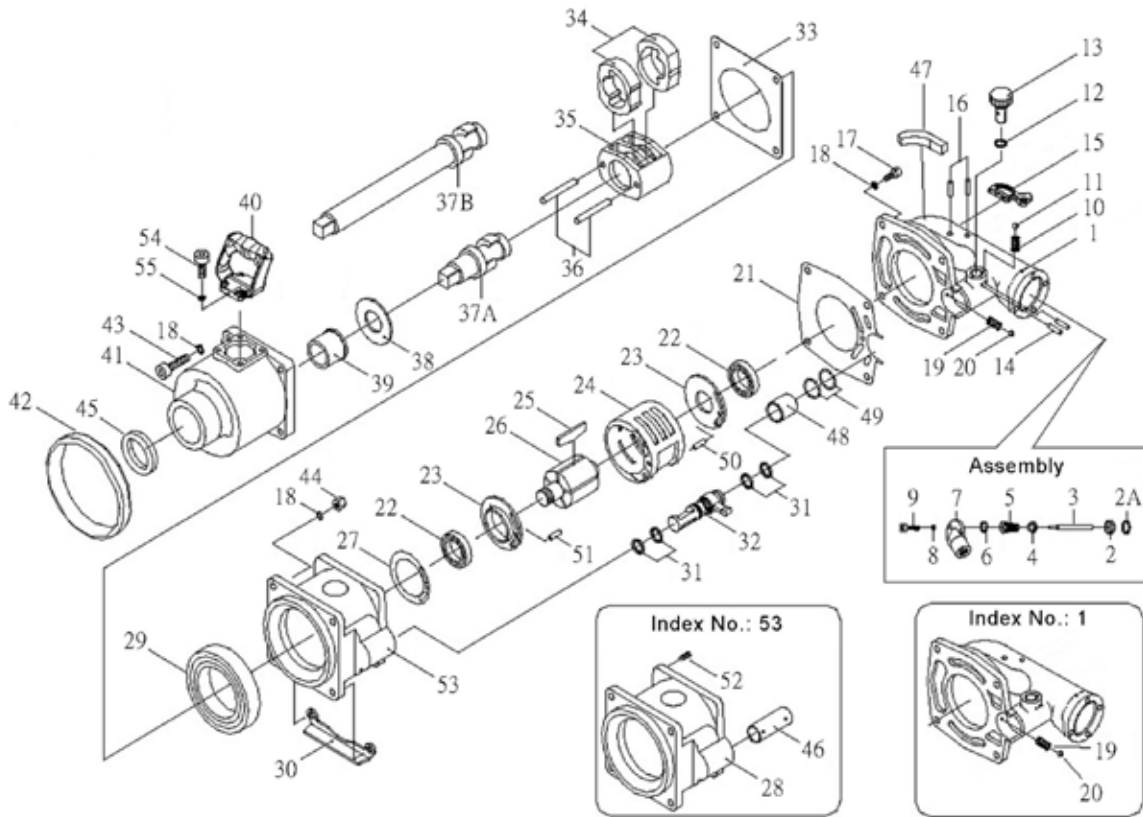

## 8K3390, 8K3398 1" Dr. Ultra Duty Air Impact Wrenches

No.	Parts No.	Description	Q'TY	CODE	No.	Parts No.	Description	Q'TY	CODE
★ 01	08K301	Trigger Handle Assembly (incl. 19, 20)	1 Set	025280	29	08K329	Ball Bearing	1	011400
02	08K302	Throttle Valve Seat	1	000730	30	08K330	Motor Housing Protector	1	001780
02A	08K302A	Throttle Valve Washer	1	000390	31	08K331	O-Ring	4	000460
03	08K303	Throttle Valve Plunger	1	000730	32	08K332	Reverse Valve	1	009020
04	08K304	Throttle Valve	1	000490	33	08K333	Gasket	1	001520
05	08K305	Spring	1	000280	34	08K334	Hammer	2	035420
06	08K306	O-Ring	1	000180	35	08K335	Hammer Frame	1	042900
07	08K307	Hose Fitting	1	005420	36	08K336	Hammer Pin	2	002300
● 08	08K308	Spring Washer	4	-	37A	08K337A	Standard Anvil (for 8K3390)	1	051950
★ 09	08K309	Screw Assembly (incl. 8)	4 Set	000310	37B	08K337B	8" Extended Anvil (for 8K3398)	1	074880
10	08K310	Spring	1	000130	38	08K338	Washer	1	002820
11	08K311	Steel Ball	1	000100	39	08K339	Bushing	1	004640
12	08K312	O-Ring	1	000100	40	08K340	Side Spade Handle	1	005420
13	08K313	Air Regulator	1	002550	41	08K341	Hammer Case	1	024260
14	08K314	Spring Pin	2	000230	42	08K342	Shield Housing Nose	1	001520
15	08K315	Inside Trigger	1	002820	★ 43	08K343	Screw Assembly (incl. 18(6))	4 Set	000870
16	08K316	Spring Pin	2	000310	44	08K344	Lock Nut	4	000920
★ 17	08K317	Screw Assembly (incl. 18(4))	4 Set	000800	45	08K345	Oil Seal	1	001260
● 18	08K318	Spring Washer	10	-	● 46	08K346	Reverse Valve Bushing	1	-
● 19	08K319	Spring	1	-	47	08K347	Rubber Cap	1	000550
● 20	08K320	Steel Ball	1	-	48	08K348	Bushing	1	001520
21	08K321	Gasket	1	001520	49	08K349	O-Ring	2	000310
● 22	08K322	Ball Bearing	2	-	50	08K350	Spring Pin	1	000180
★ 23	08K323	Rear and Front End Plate Assembly (incl. 22)	2 Set	029100	51	08K351	Spring Pin	1	000180
24	08K324	Cylinder	1	028860	● 52	08K352	Heli Coil	4	-
25	08K325	Rotor Blade	7	009020	★ 53	08K353	Housing Assembly (incl. 28, 46, 52)	1 Set	042660
26	08K326	Rotor	1	035420	★ 54	08K354	Screw Assembly (incl. 55)	4 Set	000310
27	08K327	Gasket	1	000980	● 55	08K355	Spring Washer	4	-
● 28	08K328	Motor Housing	1	-	TK	08K3TK	Tune-Up Kit ( 5, 6, 10, 11, 12, 19, 20, 21, 22, 25, 27, 29, 31, 33, 49 )	1 Set	028280

- ★ Must be purchased in assembly set
- Cannot be sold separately due to assembly difficulty

# Replacement Parts

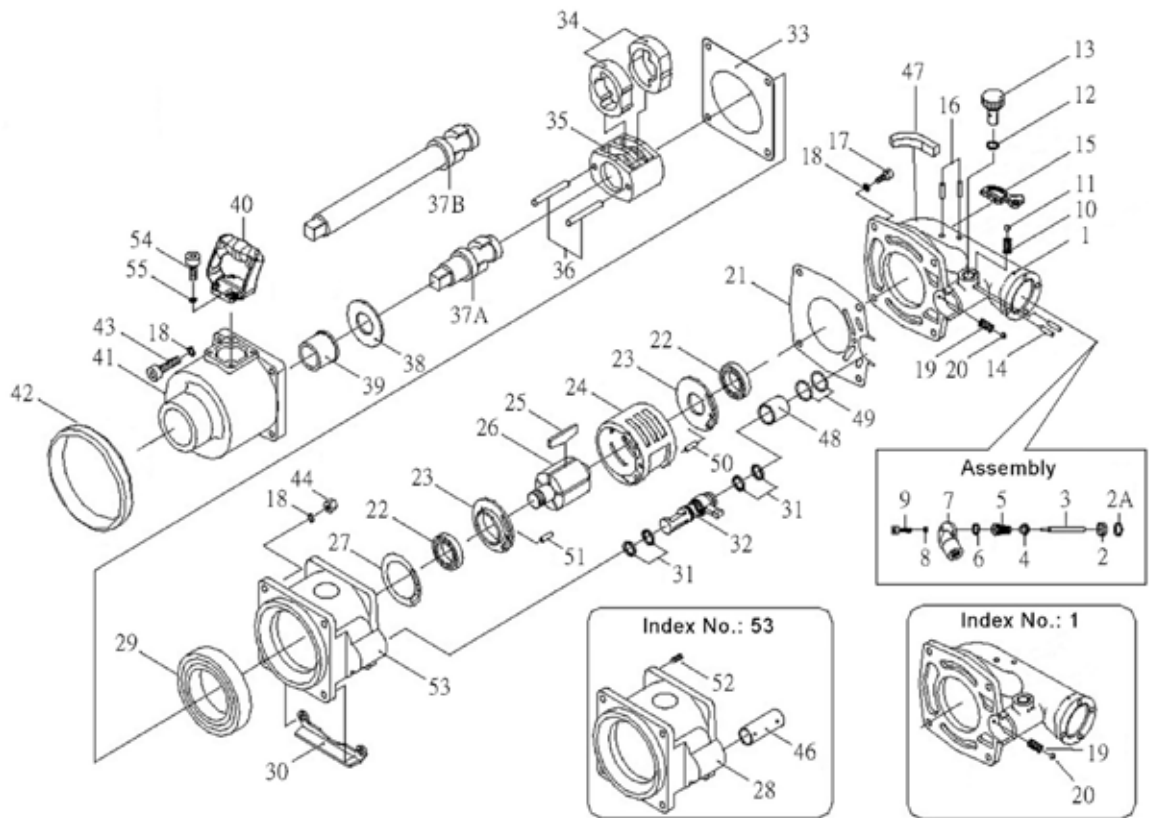

## 9K3390, 9K3398 1-1/2" Dr. Ultra Duty Air Impact Wrenches

No.	Parts No.	Description	Q'TY	CODE	No.	Parts No.	Description	Q'TY	CODE
★ 01	08K301	Trigger Handle Assembly (incl. 19, 20)	1 Set	025280	29	08K329	Ball Bearing	1	011400
02	08K302	Throttle Valve Seat	1	000730	30	08K330	Motor Housing Protector	1	001780
02A	08K302A	Throttle Valve Washer	1	000390	31	08K331	O-Ring	4	000460
03	08K303	Throttle Valve Plunger	1	000730	32	08K332	Reverse Valve	1	009020
04	08K304	Throttle Valve	1	000490	33	08K333	Gasket	1	001520
05	08K305	Spring	1	000280	34	08K334	Hammer	2	035420
06	08K306	O-Ring	1	000180	35	08K335	Hammer Frame	1	042900
07	08K307	Hose Fitting	1	005420	36	08K336	Hammer Pin	2	002300
● 08	08K308	Spring Washer	4	-	37A	09K337A	Standard Anvil (for 9K3390)	1	117000
★ 09	08K309	Screw Assembly (incl. 8)	4 Set	000310	37B	09K337B	8" Extended Anvil (for 9K3398)	1	183730
10	08K310	Spring	1	000130	38	09K338	Washer	1	004130
11	08K311	Steel Ball	1	000100	39	09K339	Bushing	1	007800
12	08K312	O-Ring	1	000100	40	08K340	Side Spade Handle	1	005420
13	08K313	Air Regulator	1	002550	41	09K341	Hammer Case	1	047660
14	08K314	Spring Pin	2	000230	42	08K342	Shield Housing Nose	1	001520
15	08K315	Inside Trigger	1	002820	★ 43	08K343	Screw Assembly (incl. 18(6))	4 Set	000870
16	08K316	Spring Pin	2	000310	44	08K344	Lock Nut	4	000920
★ 17	08K317	Screw Assembly (incl. 18(4))	4 Set	000800	● 46	08K346	Reverse Valve Bushing	1	-
● 18	08K318	Spring Washer	10	-	47	08K347	Rubber Cap	1	000550
● 19	08K319	Spring	1	-	48	08K348	Bushing	1	001520
● 20	08K320	Steel Ball	1	-	49	08K349	O-Ring	2	000310
21	08K321	Gasket	1	001520	50	08K350	Spring Pin	1	000180
● 22	08K322	Ball Bearing	2	-	51	08K351	Spring Pin	1	000180
★ 23	08K323	Rear and Front End Plate Assembly (incl. 22)	2 Set	029100	● 52	08K352	Heli Coil	4	-
24	08K324	Cylinder	1	028860	★ 53	08K353	Housing Assembly (incl. 28, 46, 52)	1 Set	042660
25	08K325	Rotor Blade	7	009020	★ 54	08K354	Screw Assembly (incl. 55)	4 Set	000310
26	08K326	Rotor	1	035420	● 55	08K355	Spring Washer	4	-
27	08K327	Gasket	1	000980			Tune-Up Kit ( 5, 6, 10, 11,		
● 28	08K328	Motor Housing	1	-	TK	08K3TK	12, 19, 20, 21, 22, 25, 27, 29, 31, 33, 49 )	1 Set	028280

★ Must be purchased in assembly set  
● Cannot be sold separately due to assembly difficulty

Miscellaneous

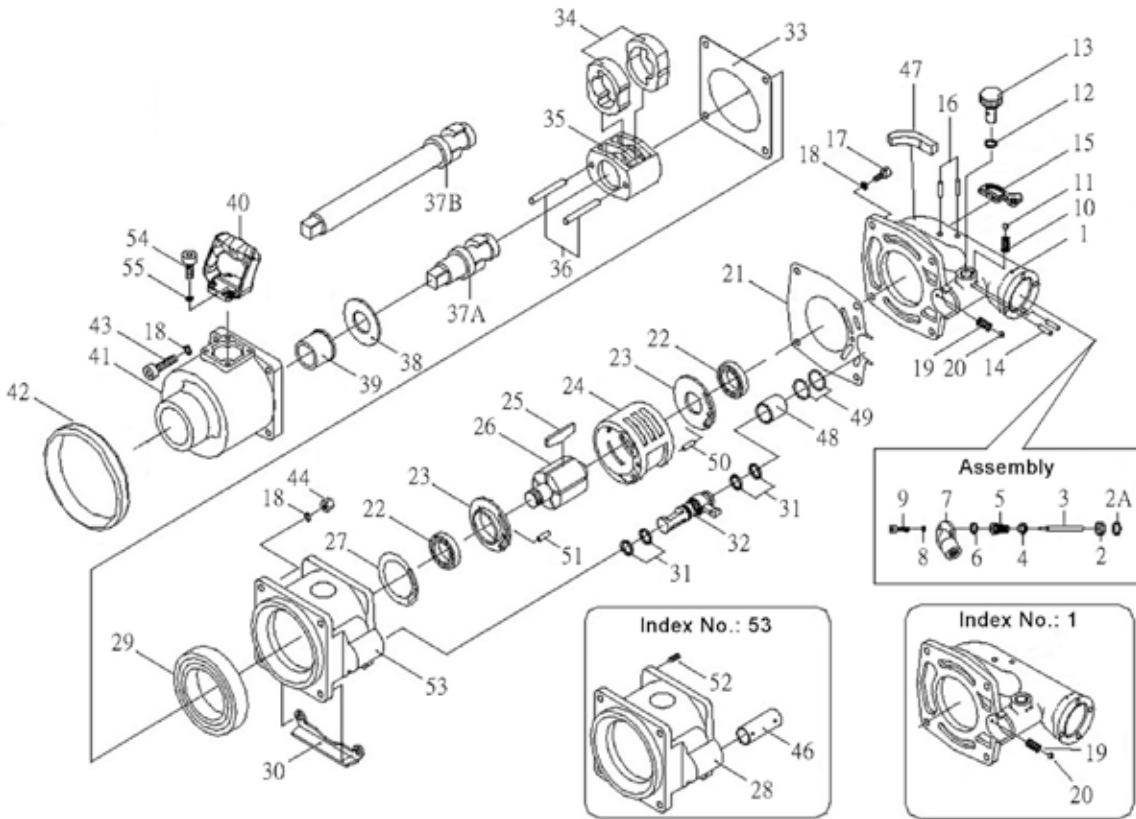

## 9K4070, 9K4078 1-1/2" Dr. Ultra Duty Air Impact Wrenches

No.	Parts No.	Description	Q'TY	CODE	No.	Parts No.	Description	Q'TY	CODE
★ 01	08K301	Trigger Handle Assembly (incl. 19, 20)	1 Set	025280	29	08K329	Ball Bearing	1	011400
02	08K302	Throttle Valve Seat	1	000730	30	08K330	Motor Housing Protector	1	001780
02A	08K302A	Throttle Valve Washer	1	000390	31	08K331	O-Ring	4	000460
03	08K303	Throttle Valve Plunger	1	000730	32	09K432	Reverse Valve	1	017290
04	08K304	Throttle Valve	1	000490	33	08K333	Gasket	1	001520
05	08K305	Spring	1	000280	34	08K334	Hammer	2	035420
06	08K306	O-Ring	1	000180	35	08K335	Hammer Frame	1	042900
07	08K307	Hose Fitting	1	005420	36	08K336	Hammer Pin	2	002300
● 08	08K308	Spring Washer	4	-	37A	09K337A	Standard Anvil (for 9K4070)	1	117000
★ 09	08K309	Screw Assembly (incl. 8)	4 Set	000310	37B	09K337B	8" Extended Anvil (for 9K4078)	1	183730
10	08K310	Spring	1	000130	38	09K338	Washer	1	004130
11	08K311	Steel Ball	1	000100	39	09K339	Bushing	1	007800
12	08K312	O-Ring	1	000100	40	08K340	Side Spade Handle	1	005420
13	08K313	Air Regulator	1	002550	41	09K341	Hammer Case	1	047660
14	08K314	Spring Pin	2	000230	42	08K342	Shield Housing Nose	1	001520
15	08K315	Inside Trigger	1	002820	★ 43	08K343	Screw Assembly (incl. 18(6))	4 Set	000870
16	08K316	Spring Pin	2	000310	44	08K344	Lock Nut	4	000920
★ 17	09K417	Screw Assembly (incl. 18(4))	4 Set	000800	● 46	08K346	Reverse Valve Bushing	1	-
● 18	09K418	Spring Washer	10	-	47	08K347	Rubber Cap	1	000550
● 19	08K319	Spring	1	-	48	08K348	Bushing	1	001520
● 20	08K320	Steel Ball	1	-	49	08K349	O-Ring	2	000310
21	08K321	Gasket	1	001520	50	08K350	Spring Pin	1	000180
● 22	08K322	Ball Bearing	2	-	51	08K351	Spring Pin	1	000180
★ 23	08K323	Rear and Front End Plate Assembly (incl. 22)	2 Set	029100	● 52	09K452	Heli Coil	4	-
24	09K424	Cylinder	1	081900	★ 53	09K453	Housing Assembly (incl. 28, 46, 52)	1 Set	076990
25	09K425	Rotor Blade	7	025250	★ 54	08K354	Screw Assembly (incl. 55)	4 Set	000310
26	09K426	Rotor	1	093600	● 55	08K355	Spring Washer	4	-
27	08K327	Gasket	1	000980	TK	09K4TK	Tune-Up Kit ( 5, 6, 10, 11, 12, 19, 20, 21, 22, 25, 27, 29, 31, 33, 49 )	1 Set	044710
● 28	08K328	Motor Housing	1	-					

★ Must be purchased in assembly set  
● Cannot be sold separately due to assembly difficulty

# Replacement Parts

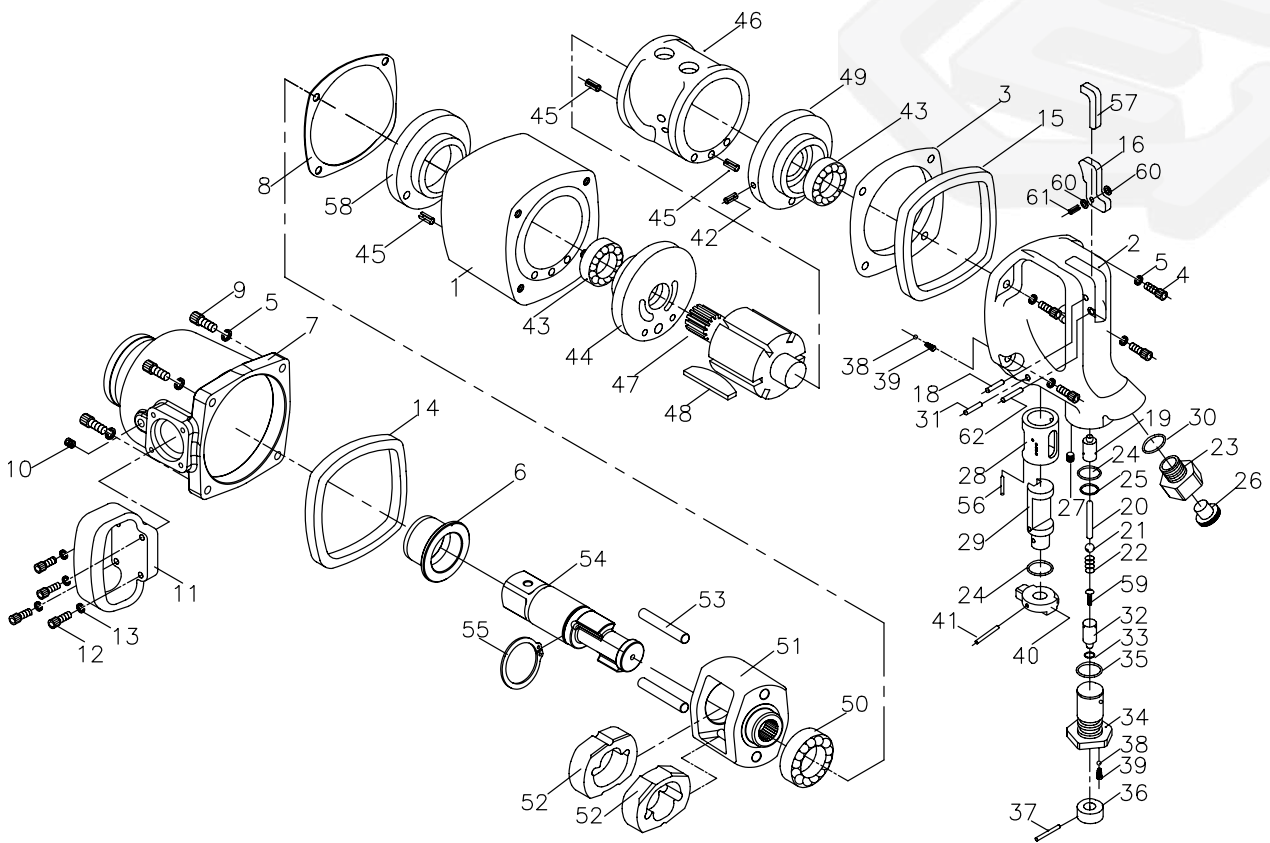

## 943000, 943008 1-1/2" Super Duty Air Impact Wrenches

No.	Parts No.	Description	Q'TY	CODE	No.	Parts No.	Description	Q'TY	CODE
01	094301	Motor Housing	1	047300	33	094333	O-Ring	1	000680
02	094302	Trigger Handle	1	038150	34	094334	Locating Ring	1	007350
03	094303	Rear Cap Gasket	1	002100	35	094335	O-Ring	1	000470
04	094304	Cap Screw	4	001300	36	094336	Reverse Valve	1	002800
05	094305	Spring Washer	8	001300	37	094337	Spring Pin (3*22L)	1	000300
06	094306	Anvil BUshing	1	010000	38	094338	Steel Ball	2	000400
07	094307	Hammer Case	1	040000	39	094339	Spring	2	000400
08	094308	Hammer Case Gasket	1	001550	40	094340	Lever Reverse	1	010400
09	094309	Cap Screw	4	001300	41	094341	Spring Pin (3*24L)	1	000300
10	094310	Clamp Screw	1	000400	42	094342	Spring Pin (3*6L)	1	000300
11	094311	Side Spade Handle	1	009000	43	094343	Rotor Bearing	2	009700
12	094312	Screw	4	001300	44	094344	Front End Plate	1	011400
13	094313	Spring Washer	4	000680	45	094345	Spring Pin (6*18L)	3	000550
14	094314	Protecting Rubber	1	002800	46	094346	Cylinder	1	025900
15	094315	Protecting Rubber	1	002800	47	094347	Rotor	1	036700
16	094316	Trigger	1	003900	48	094348	Rotor Blade	6	009200
18	094318	Spring Pin (4 * 28L)	1	000300	49	094349	Rear End Plate	1	013300
19	094319	Throttle Valve Bushing	1	005000	50	094350	Bearing	1	006600
20	094320	Throttle Valve Stem	1	001000	51	094351	Hammer Frame	1	057600
21	094321	Steel Ball	1	002300	52	094352	Hammer	2	043600
22	094322	Spring	1	000400	53	094353	Hammer Pin	2	009200
23	094323	Hose Fitting	1	003900	54A	094354A	Standard Anvil (for 943000)	1	090000
24	094324	O-Ring	2	000680	54B	094354B	8" Extended Anvil (for 943008)	1	142000
25	094325	O-Ring	1	000400	55	094355	C-Ring (C48)	1	000980
26	094326	Dust Cover	1	000680	56	094356	Pin	1	000400
27	094327	Screw	1	000680	57	094357	Rubber Cap (for Inside Trigger)	1	001300
28	094328	Valve Sleeve	1	007800	58	094358	Bearing Base	1	020350
29	094329	Reverse Valve	1	005400	59	094359	Screw	1	000300
30	094330	O-Ring	1	000300	60	094360	Washer	2	000400
31	094331	Spring Pin (4*36L)	1	000300	61	094361	Pin	1	000400
32	094332	Air Regulator	1	008800	62	094362	Pin	1	000400

Miscellaneous

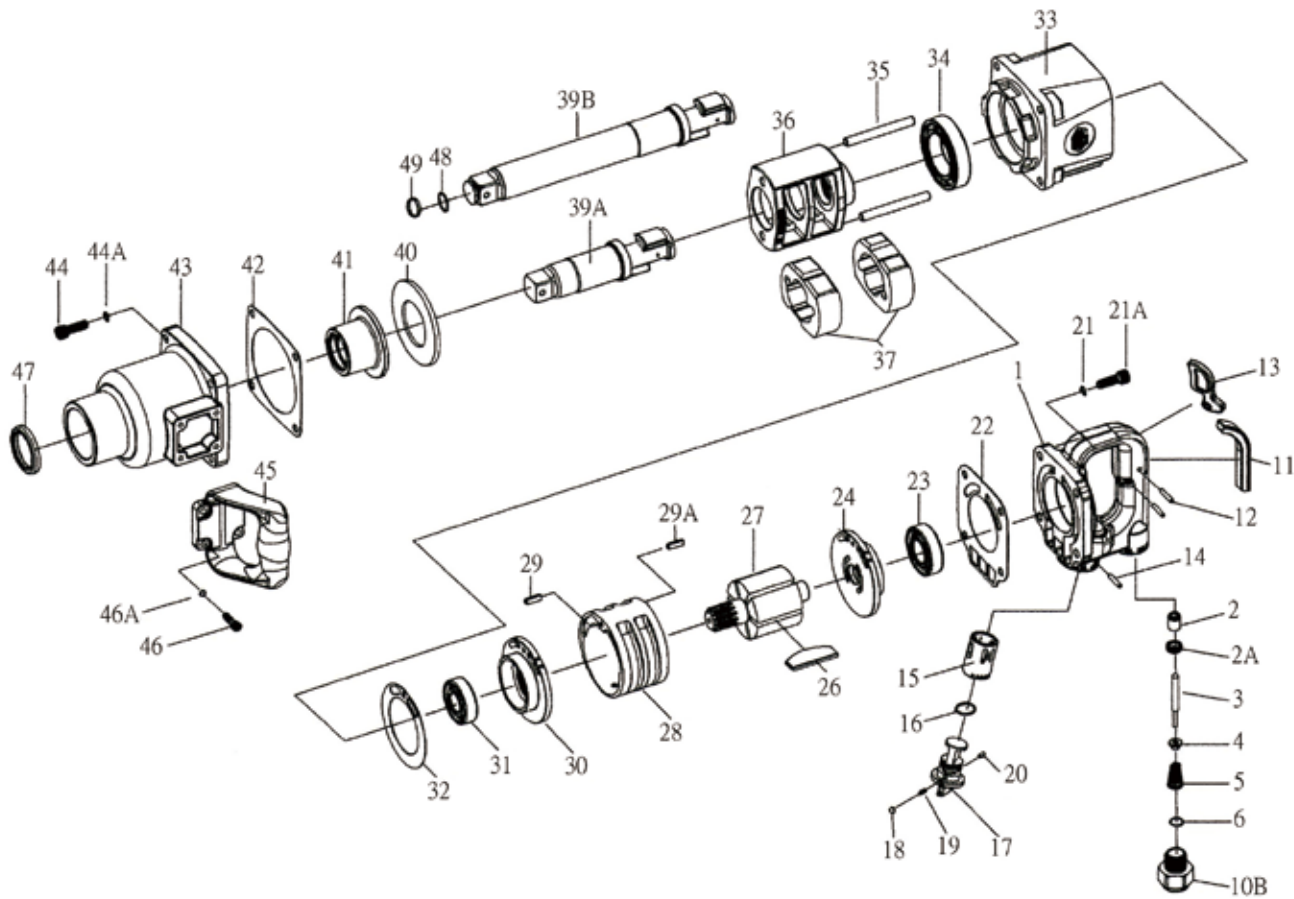

## 501800, 501806 #5 Spline Dr. Super Duty Air Impact Wrenches

No.	Parts No.	Description	Q'TY	CODE	No.	Parts No.	Description	Q'TY	CODE
01	081801	Trigger Handle	1	011560	29A	081829A	Spring Pin	1	000100
02	081802	Throttle Valve Bushing	1	000430	30	081830	Front End Plate	1	006120
02A	081802A	Throttle Valve Seat	1	000600	31	081831	Front Rotor Bearing	1	001330
03	081803	Throttle Valve Plunger	1	000600	32	081832	End Plate Gasket	1	001120
04	081804	Throttle Valve	1	000480	33	081833	Motor Housing	1	014440
05	081805	Throttle Valve Spring	1	000230	34	081834	Bearing	1	003900
06	081806	O-Ring	1	000140	35	081835	Hammer Pin	2	002770
10B	081810B	Hose Fitting	1	002080	36	081836	Hammer Frame	1	022360
11	081811	Rubber Cap (For Inside Trigger)	1	000350	37	081837	Hammer	2	022360
12	081812	Trigger Pin	2	000260	39A	081839A	Spline Dr. Anvil (for 501800)	1	046530
13	081813	Trigger	1	000600	39B	081839B	6" Spline Dr. Anvil (for 501806)	1	048870
14	081814	Spring Pin	1	000100	40	081840	Thrust Washer	1	001480
15	081815	Valve Sleeve	1	002930	41	081841	Anvil Bushing	1	004230
16	081816	O-Ring	1	000140	42	081842	Hammer Case Gasket	1	001120
17	081817	Reverse Valve	1	004880	43	081843	Hammer Case	1	011560
18	081818	Steel Ball	1	000100	44	081844	Cap Screw	4	000480
19	081819	Spring	1	000100	44A	081844A	Spring Washer	4	000200
20	081820	Spring Pin	1	000100	45	081845	Side Spade Handle	1	006120
21	081821	Spring Washer	4	000200	46	081846	Screw	4	000480
21A	081821A	Cap Screw	4	000480	46A	081846A	Spring Washer	4	000200
22	081822	Rear Cap Gasket	1	001120	47	081847	Hammer Case Seal	1	000920
23	081823	Rear Motor Bearing	1	001480	48	081848	O-Ring	1	000140
24	081824	Rear End Plate	1	006120	49	081849	Socket Retainer	1	000430
26	081826	Rotor Blade	6	009180	TK	0818TK	Tune-Up Kit (2A, 6, 9, 16)	1 set	001080
27	081827	Rotor	1	018170					
28	081828	Cylinder	1	014440					
29	081829	Spring Pin	1	000100					



# Replacement Parts

## 401000 1/2" x 3/4" Dr. Torque Multiplier

No.	Parts No.	Description	Q'TY	CODE
01	040101	Gear Driver	1	006500
02	040102	O-Ring	1	000200
03	040103	Gear Cover	1	013300
04	040104	Roller Pin	4	001600
05	040105	O-Ring	2	000330
06	040106	Washer	2	000370
07	040107	Idler Gear	4	010100
08	040108	Gear Housing	1	019900
09	040109	Square Driver(Output)	1	013300
10	040110	Screw	4	000520
11	040111	Sustain Handle	1	003380

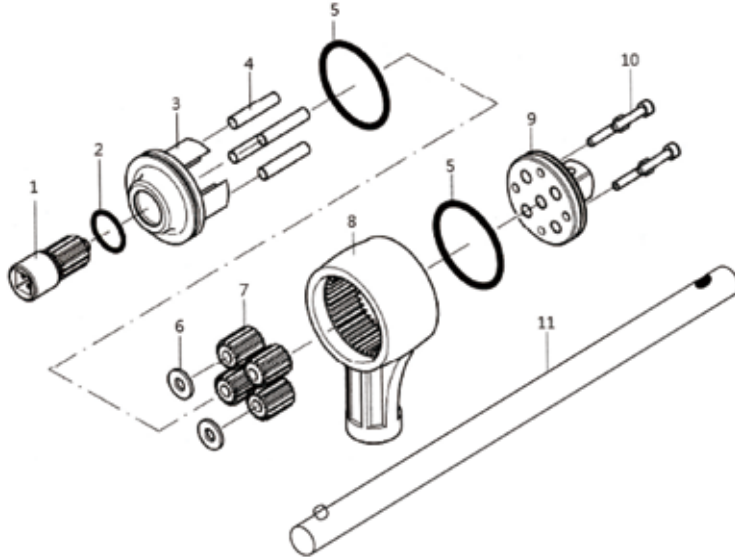

## 602000 3/4" x 1" Dr. Torque Multiplier

No.	Parts No.	Description	Q'TY	CODE
01	060201	Gear Driver	1	009660
02	060202	O-Ring	1	000260
03	060203	Gear Cover	1	013700
04	060204	Roller Pin	4	001780
05	060205	O-Ring	2	000390
06	060206	Washer	2	000370
07	060207	Idler Gear	4	012100
08	060208	Gear Housing	1	020300
09	060209	Square Driver(Output)	1	013900
10	060210	Screw	4	000630
11	060211	Sustain Handle	1	004640



## 401500 1/2" x 3/4" Dr. Torque Multiplier

No.	Parts No.	Description	Q'TY	CODE
01	041501	Rear Cap	1	004400
02	041502	Screw	4	000230
03	041503	Gear Driver	1	001520
04	041504	O-Ring	1	000130
05	041505	Gear Cover	1	004910
06	041506	O-Ring	2	000800
07	041507	Washer	4	000230
08	041508	Idler Gear	4	005420
09	041509	Gear Housing	1	015300
10	041510	Gear Plate	1	005860
11	041511	Roller pin	4	000800
12	041512	Idler Gear	4	006340
13	041513	Square Driver	1	020100
14	041514	Front Cap	1	010200
15	041515	Screw	4	000230
16	041516	Reaction Bar	1	010200

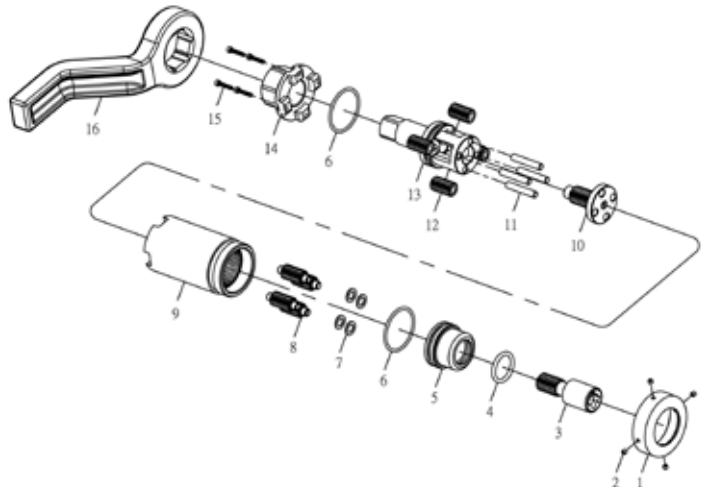

Miscellaneous

## Reversible Ratchets

ITEM No.	Parts A	CODE	Parts B	CODE	Parts C	CODE
280222R	028222A	000200	028222B	000500	028222C	000300
380333R	038333A	000230	038333B	000600	038333C	000400
480415	048444A	000250	048415B	000700	048415C	000600
480444R	048444A	000250	048444B	000700	048444C	000500
680666R	068666A	000450	068666B	001800	068666C	001000
680666RA	068666A	000450	068666B	001800	068666C	001000
680610S	068666A	000450	068666B	001800	068666C	001000
880888R	088888A	000600	088888B	002600	088888C	001300

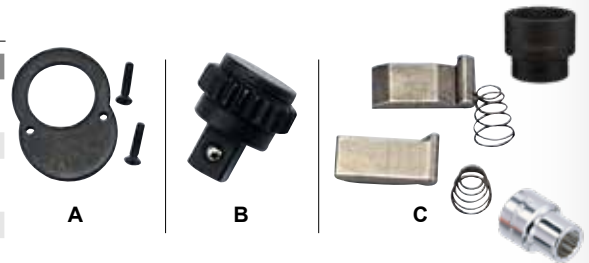

## Reversible Ratchets (Quick Release)

ITEM No.	Parts A	CODE	Parts B	CODE	Parts C	CODE
280231P	028231A	000300	028231B	000650	028231C	000300
280231R	028231A	000300	028231B	000650	028231C	000300
280231S	028231A	000300	028231B	000650	028231C	000300
380331P	038331A	000400	038331B	000840	038331C	000400
380331R	038331A	000400	038331B	000840	038331C	000400
380331S	038331A	000400	038331B	000840	038331C	000400
480431P	048431A	000470	048431B	001170	048431C	000500
480431R	048431A	000470	048431B	001170	048431C	000500
480431S	048431A	000470	048431B	001170	048431C	000500

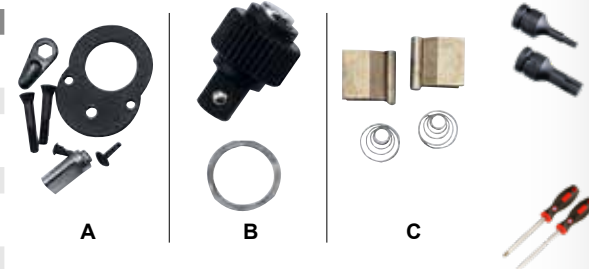

## Reversible Ratchets (72 Teeth)

ITEM No.	Parts A	CODE	Parts B	CODE	Parts C	CODE
280272	028272A	000300	028272B	000600	028272C	000300
280272P	028272A	000300	028272B	000600	028272C	000300
280272S	028272A	000300	028272B	000600	028272C	000300
380370	038372A	000360	038372B	000700	038372C	000400
380372	038372A	000360	038372B	000700	038372C	000400
380372P	038372A	000360	038372B	000700	038372C	000400
380372S	038372A	000360	038372B	000700	038372C	000400
480472	048472A	000420	048472B	000800	048472C	000500
480472P	048472A	000420	048472B	000800	048472C	000500
480472S	048472A	000420	048472B	000800	048472C	000500
680672	068672A	000800	068672B	002700	068672C	001000
880872	068672A	000800	088872B	002700	068672C	001000

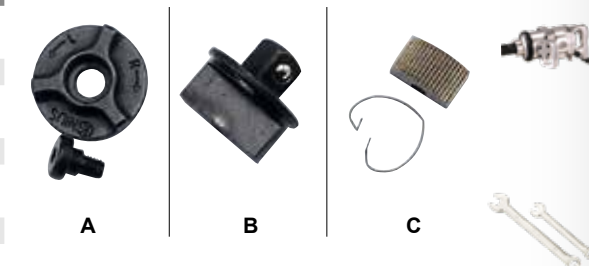

## Rotor Ratchets (270°)

ITEM No.	Parts A	CODE	Parts B	CODE	Parts C	CODE	Parts D	CODE
281802	028272A	000300	028272B	000600	028272C	000300	028802D	000200
281802P	028272A	000300	028272B	000600	028272C	000300	028802D	000200
281802S	028272A	000300	028272B	000600	028272C	000300	028802D	000200
381803	038372A	000360	038372B	000700	038372C	000400	038803D	000200
381803P	038372A	000360	038372B	000700	038372C	000400	038803D	000200
381803S	038372A	000360	038372B	000700	038372C	000400	038803D	000200
481804	048472A	000420	048472B	000800	048472C	000500	048804D	000200
481804P	048472A	000420	048472B	000800	048472C	000500	048804D	000200
481804S	048472A	000420	048472B	000800	048472C	000500	048804D	000200



## Flex Head Ratchets

ITEM No.	Parts A	CODE	Parts B	CODE	Parts C	CODE	Parts D	CODE
282262	028272A	000300	028272B	000600	028272C	000300	028226	000200
282262P	028272A	000300	028272B	000600	028272C	000300	028226	000200
282262S	028272A	000300	028272B	000600	028272C	000300	028226	000200
383363	038372A	000360	038372B	000700	038372C	000400	038336	000300
383363P	038372A	000360	038372B	000700	038372C	000400	038336	000300
383363S	038372A	000360	038372B	000700	038372C	000400	038336	000300
383338	038372A	000360	038372B	000700	038372C	000400	038336	000300
383338P	038372A	000360	038372B	000700	038372C	000400	038336	000300
383338S	038372A	000360	038372B	000700	038372C	000400	038336	000300
383383S	038372A	000360	038372B	000700	038372C	000400	038336	000300
484464	048472A	000420	048472B	000800	048472C	000500	048446	000400
484464P	048472A	000420	048472B	000800	048472C	000500	048446	000400
484464S	048472A	000420	048472B	000800	048472C	000500	048446	000400
484468S	048472A	000420	048472B	000800	048472C	000500	048446	000400



# Replacement Parts

## Hinge Handles

ITEM No.	Parts A	CODE	Parts B	CODE
280226	028226H	000200	028226	000200
280226A	028226H	000200	028226	000200
280226P	028226H	000200	028226	000200
280226S	028226H	000200	028226	000200
380336	038336H	000300	038336	000300
380336A	038336H	000300	038336	000300
380336P	038336H	000300	038336	000300
380336S	038336H	000300	038336	000300
380338	038336H	000300	038336	000300
380338P	038336H	000300	038336	000300
380338S	038336H	000300	038336	000300
480446	048446H	000400	048446	000400
480446A	048446H	000400	048446	000400
480446P	048446H	000400	048446	000400
480446S	048446H	000400	048446	000400
480448P	048446H	000400	048446	000400
480448S	048446H	000400	048446	000400
680446A	068646H	000900	068646	000600
680446E	068646H	000900	068646	000600
880846E	088848H	003100	088848	001000



## Torque Wrenches

ITEM No.	Parts A	CODE	Parts B	CODE	Parts C	CODE
280030N	028030A	000200	028030B	000500	028030C	000300
280250L	028030A	000200	028030B	000500	028030C	000300
380030N	028030A	000200	038030B	000600	028030C	000300
380110N	038110A	000230	038110B	000600	038110C	000400
380250L	028030A	000200	038030B	000600	028030C	000300
380080F	038110A	000230	038110B	000600	038110C	000400
480210N	048210A	000250	048210B	000700	048210C	000500
480350N	048350A	000250	048350B	000700	048350C	000500
480150F	048210A	000250	048210B	000700	048210C	000500
480250F	048350A	000250	048350B	000700	048350C	000500
680500N	068500A	000450	068500B	001800	068500C	001000
680700N	068500A	000450	068500B	001800	068500C	001000
680980N	068500A	000450	068500B	001800	068500C	001000
680300F	068500A	000450	068500B	001800	068500C	001000
680600F	068500A	000450	068500B	001800	068500C	001000
680700F	068500A	000450	068500B	001800	068500C	001000
880980N	068500A	000600	088980B	002600	068500C	001300
880700F	068500A	000600	088980B	002600	068500C	001300

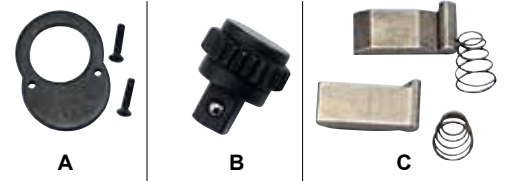

## Pipe Wrenches

ITEM No.	Parts A	CODE	Parts B	CODE	Parts C	CODE
782200	078220A	001540	078220B	000770	078220C	000550
782250	078225A	001960	078225B	000940	078225C	000710
782300	078230A	002370	078230B	001050	078230C	000850
782350	078235A	002960	078235B	001260	078235C	001050
782460	078246A	004240	078246B	001690	078246C	001290
782610	078261A	005670	078261B	002370	078261C	001960
782910	078291A	010320	078291B	003720	078291C	003360
783220	078322A	017780	078322B	005620	078322C	004810
784350	078235A	002960	078235B	001260	078235C	001050
784460	078246A	004240	078246B	001690	078246C	001290
784610	078261A	005670	078261B	002370	078261C	001960
784910	078291A	010320	078291B	003720	078291C	003360
785220	078322A	017780	078322B	005620	078322C	004810

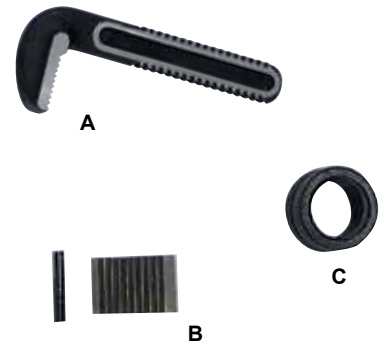

## Impact Drivers

ITEM No.	Parts A	CODE	Parts B	CODE	Parts C	CODE
700007	07007A	000250	07007B	001000	07007C	000250
700008	07007A	000250	07008B	001000	07007C	000250

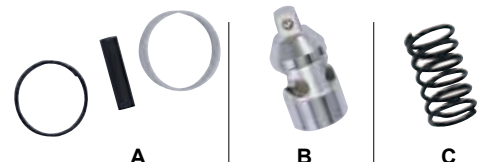

Miscellaneous

## Sliding T-Handles

ITEM No.	Parts No.	Icon	CODE
280020	028020	A	000200
380030	038030	B	000200
480040	048040	B	000200
680060	068060	C	000250
880063	088080	C	000300
880080	088080	C	000300

## Speed Handles

ITEM No.	Parts No.	CODE
380400	038400	000200
480420	038400	000200
480490	038400	000200

## Adjustable Wrenches

ITEM No.	Parts No.	CODE
780128	078128	000200
780192	078192	000200
780256	078256	000200
780320	078320	000250
780384	078384	000320
780480	078480	000660
780576	078576	001200

## Swivel Universal Joints

ITEM No.	Parts No.	CODE
640606	064606	000720
680606	064606	000720
700107	038001	000340
700108	048001	000360
840808	084808	000900
880808	084808	000900

## Adapters

ITEM No.	Parts No.	Icon	CODE
640604	064604	A	000350
640604B	064604B	B	000350
620604	064604B	B	000350
841006	084106	C	000760
841006B	084106B	D	000760
821006	084106B	D	000760
938008	093808	C	002500
938008B	093808B	D	002500

## Stud Remover Sockets

ITEM No.	Parts No.	CODE
426306	042306SR	000450
426308	042308SR	000450
427410	042410SR	000500
427412	042412SR	000500
427413	042413SR	000550
427414	042414SR	000550
427416	042416SR	000630
486308	048308SR	000450
486310	042308SR	000450
487412	048412SR	000500
487414	048414SR	000500
487416	048416SR	000550
487418	048418SR	000550
487420	048420SR	000630



# Replacement Parts

## Rubber Rings and Steel Pins

Parts No.	Ring Size A (mm)	Pin Size D x L (mm)	Description	CODE
03407RP	15	3 x 16	For 3432, 3463(6-13mm), 3632, 3663(1/4~1/2")	000100
03414RP	17	3 x 18	For 3432, 3463(14-22mm), 3632, 3663(9/16~7/8")	000100
04408RP	19	3 x 20	For 4438, 4440, 4478(8~17mm), 4638, 4640, 4678(5/16~11/16") For 4538, 4485(8~18mm), 4452(10~18mm), 4045, 4078(E8-22)	000100
04417RP	24	3 x 25	For 4438, 4440, 4478(18-32mm), 4638, 4640, 4678(3/4~1-1/4") For 4538, 4485(19~32mm), 4452(19~21mm), 4045, 4078(E24-32)	000100
04433RP	28	3 x 30	For 4438, 4440, 4478(33-41mm), 4638, 4640, 4678(1-5/16~1-1/2") For 4538, 4485(33~41mm), 4452(22~24mm)	000120
06417RP	35	4 x 35	For 6452, 6552, 6495(17-27mm), 6652, 6952, 6695(11-16~1-1/16")	000150
06428RP	40	4 x 40	For 6452, 6552, 6495(28-51mm), 6652, 6952, 6695(1-1/8~2") For 6050, 6090(E18-32)	000200
06452RP	50	4 x 50	For 6452, 6552, 6495(52-76mm), 6652, 6952, 6695(2-1/16~3")	000250
08421RP	45	5 x 45	For 1" Dr. Impact Sockets 17-36mm, 11/16~1-7/16"	000250
08433RP	48	5 x 50	For 1" Dr. Impact Sockets 37-59mm, 1-1/2~2-5/16"	000300
08460RP	55	5 x 55	For 1" Dr. Impact Sockets 60-79mm, 2-3/8~3-1/8"	000350
08480RP	75	5 x 75	For 1" Dr. Impact Sockets 80-115mm, 3-3/16~4-1/8"	000400
09341RP	80	6 x 80	For 1-1/2" Dr. Impact Sockets 41-90mm, 1-5/8~3-11/16"	000650
09395RP	120	6 x 120	For 1-1/2" Dr. Impact Sockets 95-165mm, 3-3/4~6-1/2"	000700
09260RP	120	8 x 120	For 2-1/2" Dr. Impact Sockets 60-120mm, 2-3/8~4-13/16"	001000
092520RP	165	8 x 165	For 2-1/2" Dr. Impact Sockets 125-235mm, 4-7/8~9-1/4"	001200
098105RP	165	10 x 165	For 3-1/2" Dr. Impact Sockets 105-140mm, 4-1/8~5-5/8"	001500
098145RP	190	10 x 190	For 3-1/2" Dr. Impact Sockets 145-235mm, 5-11/16~9-1/4"	001800



## Safety Springs

Parts No.	Size mm	Description	CODE
03607SP	17	For 3/8" Dr. Impact Sockets 7-13mm, 5/16~1/2"	000100
03614SP	19	For 3/8" Dr. Impact Sockets 14-22mm, 9/16~7/8"	000100
04608SP	21	For 1/2" Dr. Impact Sockets 8-16mm, 5/16~5/8"	000120
04617SP	25	For 1/2" Dr. Impact Sockets 17-32mm, 11/16~1-1/4"	000120
04633SP	30	For 1/2" Dr. Impact Sockets 33-41mm, 1-5/16~1-1/2"	000150



## Stud Bolt Socket Screws

Parts No.	Size	Description	CODE
030610	M6 x 1.0	For 306100, 406100	000200
040810	M8 x 1.0	For 408100, 412150	000200
0308125	M8 x 1.25	For 308125, 408125	000200
041010	M10 x 1.0	For 410100, 414150, 414200, 416150, 416200	000200
0310125	M10 x 1.25	For 310125, 410125	000200
0310150	M10 x 1.5	For 310150, 410150	000200
0412125	M12 x 1.25	For 412125	000200
0412175	M12 x 1.75	For 412175	000200



## Bit Socket Screws

Parts No.	Description	CODE
0324810	For 312+, 314+, 316+, 339+, 340+, 341+, 342+, 344+, 412+, 414+, 416+ 418+, 420+, 422+, 424+, 439+, 440+, 441+, 442+, 443+, 446+, 447+, 449+	000200
0308125	For 619+, 622+, 627+, 819+, 822+, 827+, 832+, 941+	000200



## Impact Swivel Sockets

Parts No.	Description	CODE
038001	For 380008M/MD ~ 380019M/MD, 380021/D ~ 380028/D	000340
048001	For 480011M/MD ~ 480016M/MD, 480J24/D ~ 480027/D For 487911M ~ 487916M, 488014 ~ 488020	000360
048002	For 480017M/MD ~ 480022M/MD, 480028/D ~ 480031/D For 487917M ~ 487922M, 488022 ~ 488028	000400



## Roller Cabinet Casters

ITEM No.	Parts No.	CODE
TS-796	OTS796	023000
TS-798	OTS798	009500



• Each set comes with 2 fixed casters and 2 swivel brake casters

Miscellaneous

# GENIUS<sup>®</sup> TOOLS

*Made for Life*



## TIAN FU INDUSTRIAL CO., LTD.

No.4, 15th Road Industrial Dist., Taichung, Taiwan 40755

Tel: 886-4-2359-2855(Rep.) Fax: 886-4-2359-1928

E-mail: [asia@geniustools.net](mailto:asia@geniustools.net)

Canada Office:

## Genius Tools International Ltd.

6725 Pacific Circle, Mississauga, Ontario,

Canada L5T 1S6

Tel: 1-905-670-4111 Fax: 1-905-670-4160

E-mail: [info@geniustools.net](mailto:info@geniustools.net)



# Numerical Index

Item No.	Description	Pg.	Code
<b>0</b>			
001002	1/4" Dr. Plastic Socket Holder	K-2	40
001003	3/8" Dr. Plastic Socket Holder	K-2	40
001004	1/2" Dr. Plastic Socket Holder	K-2	40
001006	3/4" Dr. Plastic Socket Holder	K-2	65
001036	Magnetic Parts Tray, Single	K-2	1200
002034	Magnetic Parts Tray, Double	K-2	2500
003047	Magnetic Parts Tray, Triple	K-2	4130
004048	Magnetic Parts Tray, Quad	K-2	5130
005012	Magnetic Bar Tool Holders, 12"/300mmL	K-2	2650
005016	Magnetic Bar Tool Holders, 16"/400mmL	K-2	2990
005024	Magnetic Bar Tool Holders, 24"/600mmL	K-2	4140
010152	1/4" Dr. Socket Rail with Clips	K-2	920
010153	3/8" Dr. Socket Rail with Clips	K-2	990
010154	1/2" Dr. Socket Rail with Clips	K-2	1210
010156	3/4" Dr. Socket Rail with Clips	K-2	1560
010603	3mm Taper Bit Extractor	J-8	250
010705	5mm Taper Bit Extractor	J-8	270
010756	6mm Taper Bit Extractor	J-8	300
010808	8mm Taper Bit Extractor	J-8	340
010859	9mm Taper Bit Extractor	J-8	370
011012	12mm Taper Bit Extractor	J-8	1200
011214	14mm Taper Bit Extractor	J-8	1700
011316	16mm Taper Bit Extractor	J-8	1900
015618	Close Quarters Bar, 450mmL	G-18	2500
015638	Pinch Bar, 950mmL	G-18	6500
0230	1/4" Hex Shank, 1/4" Hex Dr. Magnetic Bit Holder, 150mmL	D-25	570
0233	1/4" Hex Shank, 1/4" Hex Dr. Magnetic Bit Holder, 250mmL	D-25	900
0250	1/4" Dr., 1/4" Hex Dr. Flexible Extension, 170mmL	D-25	570
0260	1/4" Hex Shank, 1/4" Hex Dr. Flexible Bit Holder, 180mmL	D-25	480
0330	1/4" Hex Shank 1/4" Hex Dr. Flexible Bit Holder, 300mmL	D-25	730
0350	1/4" Dr. 1/4" Hex Dr. Flexible Extension, 300mmL	D-25	870
0444	1/4" Hex Shank, 4mm Hex Nut Driver, 140mmL	D-62	520
0445	1/4" Hex Shank, 5mm Hex Nut Driver, 140mmL	D-62	520
0455	1/4" Hex Shank, 5.5mm Hex Nut Driver, 140mmL	D-62	520
0456	1/4" Hex Shank, 6mm Hex Nut Driver, 140mmL	D-62	520
0457	1/4" Hex Shank, 7mm Hex Nut Driver, 140mmL	D-62	520
0458	1/4" Hex Shank, 8mm Hex Nut Driver, 140mmL	D-62	520
0459	1/4" Hex Shank, 9mm Hex Nut Driver, 140mmL	D-62	520
0460	1/4" Hex Shank, 10mm Hex Nut Driver, 140mmL	D-62	520
0461	1/4" Hex Shank, 11mm Hex Nut Driver, 140mmL	D-62	520
0462	1/4" Hex Shank, 12mm Hex Nut Driver, 140mmL	D-62	520
0463	1/4" Hex Shank, 13mm Hex Nut Driver, 140mmL	D-62	520
0464	1/4" Hex Shank, 14mm Hex Nut Driver, 140mmL	D-62	520
0512	1/4" Hex Shank, 3/16" Hex Nut Driver, 140mmL	D-62	520
0516	1/4" Hex Shank, 1/4" Hex Nut Driver, 140mmL	D-62	520
0520	1/4" Hex Shank, 5/16" Hex Nut Driver, 140mmL	D-62	520
0522	1/4" Hex Shank, 11/32" Hex Nut Driver, 140mmL	D-62	520
0524	1/4" Hex Shank, 3/8" Hex Nut Driver, 140mmL	D-62	520
0528	1/4" Hex Shank, 7/16" Hex Nut Driver, 140mmL	D-62	520
0532	1/4" Hex Shank, 1/2" Hex Nut Driver, 140mmL	D-62	520
091207	7mm Open Ended Head, 9 x 12mm	F-39	1590
091208	8mm Open Ended Head, 9 x 12mm	F-39	1590
091209	9mm Open Ended Head, 9 x 12mm	F-39	1590
091210	10mm Open Ended Head, 9 x 12mm	F-39	1590
091211	11mm Open Ended Head, 9 x 12mm	F-39	1590
091212	12mm Open Ended Head, 9 x 12mm	F-39	1590
091213	13mm Open Ended Head, 9 x 12mm	F-39	1590
091214	14mm Open Ended Head, 9 x 12mm	F-39	1590
091215	15mm Open Ended Head, 9 x 12mm	F-39	1590
091216	16mm Open Ended Head, 9 x 12mm	F-39	1690
091217	17mm Open Ended Head, 9 x 12mm	F-39	1690
091218	18mm Open Ended Head, 9 x 12mm	F-39	1690
091219	19mm Open Ended Head, 9 x 12mm	F-39	1690
09RH20	1/4" Dr. Ratchet Head, 56mmL, 9 x 12mm	F-40	1980
09RH30	3/8" Dr. Ratchet Head, 69mmL, 9 x 12mm	F-40	2180
09RH33	3/8" Dr. Ratchet Head, 56mmL, 9 x 12mm	F-40	2090
09RH44	1/2" Dr. Ratchet Head, 69mmL, 9 x 12mm	F-40	2270

Item No.	Description	Pg.	Code
<b>1</b>			
101853	Air Angle Drill	E-24	15260
102638	Air Drill	E-24	9970
102653	Air Drill (Quick Release)	E-24	10350
10265E	Air Eraser	E-25	10350
103652	Low Speed Air Die Grinder	E-20	9780
103656	Low Speed Air Die Grinder	E-20	9780
10BP25	2.5mm Gravity - BP Type Air Spray Gun	E-29	18100
10HV13	1.3mm Gravity - HVLP Type Air Spray Gun	E-29	18100
10HV14	1.4mm Gravity - HVLP Type Air Spray Gun	E-29	18100
10HV16	1.6mm Gravity - HVLP Type Air Spray Gun	E-29	18100
10HV18	1.8mm Gravity - HVLP Type Air Spray Gun	E-29	18100
10HV20	2.0mm Gravity - HVLP Type Air Spray Gun	E-29	18100
10MP13	1.3mm Gravity - MP Type Air Spray Gun	E-29	18100
10MP14	1.4mm Gravity - MP Type Air Spray Gun	E-29	18100
10MP16	1.6mm Gravity - MP Type Air Spray Gun	E-29	18100
10MP18	1.8mm Gravity - MP Type Air Spray Gun	E-29	18100
10MP20	2.0mm Gravity - MP Type Air Spray Gun	E-29	18100
1100	1/4" Hex Shank, PH.0 Philips Screwdriver Bit, 30mmL	D-3	55
1101	1/4" Hex Shank, PH.1 Philips Screwdriver Bit, 30mmL	D-3	55
1102	1/4" Hex Shank, PH.2 Philips Screwdriver Bit, 30mmL	D-3	55
1103	1/4" Hex Shank, PH.3 Philips Screwdriver Bit, 30mmL	D-3	55
1121	5/16" Hex Shank, PH.1 Philips Screwdriver Bit, 30mmL	D-3	92
1122	5/16" Hex Shank, PH.2 Philips Screwdriver Bit, 30mmL	D-3	92
1123	5/16" Hex Shank, PH.3 Philips Screwdriver Bit, 30mmL	D-3	92
1124	5/16" Hex Shank, PH.4 Philips Screwdriver Bit, 30mmL	D-3	92
1130	1/4" Hex Shank, 0.5 x 3.0mm Slotted Screwdriver Bit, 30mmL	D-2	55
1140	1/4" Hex Shank, 0.6 x 4.0mm Slotted Screwdriver Bit, 30mmL	D-2	55
1150	1/4" Hex Shank, 0.8 x 5.0mm Slotted Screwdriver Bit, 30mmL	D-2	55
11505A	2" Air Angle Grinder	E-21	13380
1155	1/4" Hex Shank, 0.8 x 5.5mm Slotted Screwdriver Bit, 30mmL	D-2	55
1160	1/4" Hex Shank, 1.0 x 6.0mm Slotted Screwdriver Bit, 30mmL	D-2	55
1165	1/4" Hex Shank, 1.0 x 6.5mm Slotted Screwdriver Bit, 30mmL	D-2	55
1170	1/4" Hex Shank, 1.2 x 7.0mm Slotted Screwdriver Bit, 30mmL	D-2	55
118152	Air Angle Die Grinder (115 degree)	E-21	15070
118156	Air Angle Die Grinder (115 degree)	E-21	15070
118952	Air Angle Die Grinder (90 degree)	E-21	12160
118956	Air Angle Die Grinder (90 degree)	E-21	12160
120032	Mini Air Angle Die Grinder (90 degree)	E-21	11590
120036	Mini Air Angle Die Grinder (90 degree)	E-21	11590
1210	1/4" Hex Shank, PZ.0 Posidriv Screwdriver Bit, 30mmL	D-16	60
12105C	3" Air Cutter	E-25	8100
1211	1/4" Hex Shank, PZ.1 Posidriv Screwdriver Bit, 30mmL	D-16	60
1212	1/4" Hex Shank, PZ.2 Posidriv Screwdriver Bit, 30mmL	D-16	60
1213	1/4" Hex Shank, PZ.3 Posidriv Screwdriver Bit, 30mmL	D-16	60
122052	Air Die Grinder	E-20	7800
122056	Air Die Grinder	E-20	7800
1221	5/16" Hex Shank, PZ.1 Posidriv Screwdriver Bit, 30mmL	D-16	90
1222	5/16" Hex Shank, PZ.2 Posidriv Screwdriver Bit, 30mmL	D-16	90
1223	5/16" Hex Shank, PZ.3 Posidriv Screwdriver Bit, 30mmL	D-16	90
1224	5/16" Hex Shank, PZ.4 Posidriv Screwdriver Bit, 30mmL	D-16	90
122552	5" Extension Air Die Grinder	E-20	11970
122556	5" Extension Air Die Grinder	E-20	11970
1250	5/16" Hex Shank, 0.8 x 5.0mm Slotted Screwdriver Bit, 30mmL	D-2	92
125032	Mini Air Die Grinder	E-20	7670
125036	Mini Air Die Grinder	E-20	7670
1255	5/16" Hex Shank, 0.8 x 5.5mm Slotted Screwdriver Bit, 30mmL	D-2	92
1260	5/16" Hex Shank, 1.0 x 6.0mm Slotted Screwdriver Bit, 30mmL	D-2	92
1265	5/16" Hex Shank, 1.0 x 6.5mm Slotted Screwdriver Bit, 30mmL	D-2	92
1280	5/16" Hex Shank, 1.2 x 8.0mm Slotted Screwdriver Bit, 30mmL	D-2	92
1290	5/16" Hex Shank, 1.6 x 9.0mm Slotted Screwdriver Bit, 30mmL	D-2	92
1292	10mm Hex Shank, 2.0 x 12.0mm Slotted Screwdriver Bit, 36mmL	D-2	140
1294	12mm Hex Shank, 2.5 x 14.0mm Slotted Screwdriver Bit, 36mmL	D-2	180
1296	14mm Hex Shank, 2.5 x 16.0mm Slotted Screwdriver Bit, 36mmL	D-2	220
12ST10	1.0mm Sunction Type Air Spray Gun	E-28	13940
12ST15	1.5mm Sunction Type Air Spray Gun	E-28	13940
12ST16	1.6mm Sunction Type Air Spray Gun	E-28	13940
12ST18	1.8mm Sunction Type Air Spray Gun	E-28	13940
12ST20	2.0mm Sunction Type Air Spray Gun	E-28	13940
1301	1/4" Hex Shank, PH.1 Philips Screwdriver Bit, 56mmL	D-3	120

Item No.	Description	Pg.	Code	Item No.	Description	Pg.	Code
1302	1/4" Hex Shank, PH.2 Philips Screwdriver Bit, 56mmL	D-3	120	1503	1/4" Hex Shank, PH.3 Philips Screwdriver Bit, 88mmL	D-3	260
1303	1/4" Hex Shank, PH.3 Philips Screwdriver Bit, 56mmL	D-3	120	1504	5/16" Hex Shank, PH.4 Philips Screwdriver Bit, 88mmL	D-3	300
131013	3" Air Polisher Sander	E-26	24980	151015	3" Air Polisher Sander	E-26	27750
1311	1/4" Hex Shank, PZ.1 Posidriv Screwdriver Bit, 56mmL	D-16	120	15103C	5" Central Vacuum Type Air Sander	E-26	24240
1312	1/4" Hex Shank, PZ.2 Posidriv Screwdriver Bit, 56mmL	D-16	120	15103N	5" Non Vacuum Type Air Sander	E-26	23310
1313	1/4" Hex Shank, PZ.3 Posidriv Screwdriver Bit, 56mmL	D-16	120	15103S	5" Self-Generated Vacuum Type Air Sander	E-26	27010
1321	5/16" Hex Shank, PZ.1 Posidriv Screwdriver Bit, 56mmL	D-16	160	1511	1/4" Hex Shank, PZ.1 Posidriv Screwdriver Bit, 88mmL	D-16	260
1322	5/16" Hex Shank, PZ.2 Posidriv Screwdriver Bit, 56mmL	D-16	160	1512	1/4" Hex Shank, PZ.2 Posidriv Screwdriver Bit, 88mmL	D-16	260
1323	5/16" Hex Shank, PZ.3 Posidriv Screwdriver Bit, 56mmL	D-16	160	1513	1/4" Hex Shank, PZ.3 Posidriv Screwdriver Bit, 88mmL	D-16	260
1324	5/16" Hex Shank, PZ.4 Posidriv Screwdriver Bit, 56mmL	D-16	160	1524	5/16" Hex Shank, PZ.4 Posidriv Screwdriver Bit, 88mmL	D-16	300
1330	1/4" Hex Shank, 0.5 x 3.0mm Slotted Screwdriver Bit, 56mmL	D-2	120	152HPS	5" Air Polisher Sander	E-26	40880
13303C	3" Central Vacuum Type Air Sander	E-26	22390	1530	1/4" Hex Shank, 0.5 x 3.0mm Slotted Screwdriver Bit, 88mmL	D-2	260
13303N	3" Non Vacuum Type Air Sander	E-26	21460	15303C	5" Central Vacuum Type Air Sander	E-26	24240
13303S	3" Self-Generated Vacuum Type Air Sander	E-26	25160	15303N	5" Non Vacuum Type Air Sander	E-26	23310
1340	1/4" Hex Shank, 0.6 x 4.0mm Slotted Screwdriver Bit, 56mmL	D-2	120	15303S	5" Self-Generated Vacuum Type Air Sander	E-26	27010
1350	1/4" Hex Shank, 0.8 x 5.0mm Slotted Screwdriver Bit, 56mmL	D-2	120	1540	1/4" Hex Shank, 0.6 x 4.0mm Slotted Screwdriver Bit, 88mmL	D-2	260
1360	1/4" Hex Shank, 1.0 x 6.0mm Slotted Screwdriver Bit, 56mmL	D-2	120	1550	1/4" Hex Shank, 0.8 x 5.0mm Slotted Screwdriver Bit, 88mmL	D-2	260
1402	5/16" Hex Shank, PH.2 Philips Screwdriver Bit, 56mmL	D-3	160	155A05	0.5mm Gravity Type Mini Air Spray Gun	E-28	15160
1403	5/16" Hex Shank, PH.3 Philips Screwdriver Bit, 56mmL	D-3	160	155A08	0.8mm Gravity Type Mini Air Spray Gun	E-28	15160
1404	5/16" Hex Shank, PH.4 Philips Screwdriver Bit, 56mmL	D-3	160	155A10	1.0mm Gravity Type Mini Air Spray Gun	E-28	15160
141813	13mm Open Ended Head, 14 x 18mm	F-39	1790	155B05	0.5mm Gravity Type Mini Air Spray Gun	E-28	15160
141814	14mm Open Ended Head, 14 x 18mm	F-39	1790	1560	1/4" Hex Shank, 1.0 x 6.0mm Slotted Screwdriver Bit, 88mmL	D-2	260
141815	15mm Open Ended Head, 14 x 18mm	F-39	1790	156000	Air Micro Die Grinder	E-22	8300
141816	16mm Open Ended Head, 14 x 18mm	F-39	1790	1580	5/16" Hex Shank, 1.2 x 8.0mm Slotted Screwdriver Bit, 88mmL	D-2	300
141817	17mm Open Ended Head, 14 x 18mm	F-39	1790	1590	5/16" Hex Shank, 1.6 x 9.0mm Slotted Screwdriver Bit, 88mmL	D-2	300
141818	18mm Open Ended Head, 14 x 18mm	F-39	1790	1592	10mm Hex Shank, 2.0 x 12.0mm Slotted Screwdriver Bit, 88mmL	D-2	400
141819	19mm Open Ended Head, 14 x 18mm	F-39	1790	1594	12mm Hex Shank, 2.5 x 14.0mm Slotted Screwdriver Bit, 88mmL	D-2	540
141821	21mm Open Ended Head, 14 x 18mm	F-39	1790	1596	14mm Hex Shank, 2.5 x 16.0mm Slotted Screwdriver Bit, 88mmL	D-2	680
141822	22mm Open Ended Head, 14 x 18mm	F-39	1790	15HGC5	5" Central Vacuum Type Air Sander (Gear Driven)	E-26	33190
141824	24mm Open Ended Head, 14 x 18mm	F-39	1900	15HGN5	5" Non Vacuum Type Air Sander (Gear Driven)	E-26	32270
141826	26mm Open Ended Head, 14 x 18mm	F-39	1900	15HGS5	5" Self-Generated Vacuum Type Air Sander (Gear Driven)	E-26	35940
141827	27mm Open Ended Head, 14 x 18mm	F-39	1900	15HV05	0.5mm Gravity - HVLP Type Mini Air Spray Gun	E-28	15620
141829	29mm Open Ended Head, 14 x 18mm	F-39	1900	15HV08	0.8mm Gravity - HVLP Type Mini Air Spray Gun	E-28	15620
141830	30mm Open Ended Head, 14 x 18mm	F-39	1900	15HV10	1.0mm Gravity - HVLP Type Mini Air Spray Gun	E-28	15620
141832	32mm Open Ended Head, 14 x 18mm	F-39	1900	1601	1/4" Hex Shank, PH.1 Philips Screwdriver Bit, 125mmL	D-3	300
14280A	3" Non Vacuum Type Rust & Paint Removal Tool	E-27	46500	1602	1/4" Hex Shank, PH.2 Philips Screwdriver Bit, 125mmL	D-3	300
14280C	5" Central Vacuum Type Rust & Paint Removal Tool	E-27	50140	1603	1/4" Hex Shank, PH.3 Philips Screwdriver Bit, 125mmL	D-3	300
14280S	5" Self-Generated Vacuum Type Rust & Paint Removal Tool	E-27	52870	1604	5/16" Hex Shank, PH.4 Philips Screwdriver Bit, 125mmL	D-3	400
1434N10	3pc Digital Torque Wrench Set, 10 ~ 100 Nm	F-37	47100	16103C	6" Central Vacuum Type Air Sander	E-26	25160
1434N20	3pc Digital Torque Wrench Set, 20 ~ 200 Nm	F-37	50700	16103N	6" Non Vacuum Type Air Sander	E-26	23310
1465	1/4" Hex Shank, 1.2 x 6.5mm Slotted Screwdriver Bit, 75mmL	D-2	230	16103S	6" Self-Generated Vacuum Type Air Sander	E-26	27690
1470	5/16" Hex Shank, 1.2 x 7.0mm Slotted Screwdriver Bit, 56mmL	D-2	160	1611	1/4" Hex Shank, PZ.1 Posidriv Screwdriver Bit, 125mmL	D-16	300
1480	5/16" Hex Shank, 1.2 x 8.0mm Slotted Screwdriver Bit, 56mmL	D-2	160	1612	1/4" Hex Shank, PZ.2 Posidriv Screwdriver Bit, 125mmL	D-16	300
1490	5/16" Hex Shank, 1.6 x 9.0mm Slotted Screwdriver Bit, 56mmL	D-2	160	1613	1/4" Hex Shank, PZ.3 Posidriv Screwdriver Bit, 125mmL	D-16	300
1492	10mm Hex Shank, 2.0 x 12.0mm Slotted Screwdriver Bit, 56mmL	D-2	220	1624	5/16" Hex Shank, PZ.4 Posidriv Screwdriver Bit, 125mmL	D-16	400
1494	12mm Hex Shank, 2.5 x 14.0mm Slotted Screwdriver Bit, 56mmL	D-2	280	1630	1/4" Hex Shank, 0.5 x 3.0mm Slotted Screwdriver Bit, 125mmL	D-2	300
1496	14mm Hex Shank, 2.5 x 16.0mm Slotted Screwdriver Bit, 56mmL	D-2	340	16303C	6" Central Vacuum Type Air Sander	E-26	25160
14CH16	27 ~ 37mm Collet Head, 14 x 18mm	F-40	4750	16303N	6" Non Vacuum Type Air Sander	E-26	23310
14CH20	30 ~ 40mm Collet Head, 14 x 18mm	F-40	4750	16303S	6" Self-Generated Vacuum Type Air Sander	E-26	27690
14CH25	37 ~ 47mm Collet Head, 14 x 18mm	F-40	4750	1640	1/4" Hex Shank, 0.6 x 4.0mm Slotted Screwdriver Bit, 125mmL	D-2	300
14CH32	45 ~ 55mm Collet Head, 14 x 18mm	F-40	4750	1650	1/4" Hex Shank, 0.8 x 5.0mm Slotted Screwdriver Bit, 125mmL	D-2	300
14CH40	58 ~ 68mm Collet Head, 14 x 18mm	F-40	4750	1660	1/4" Hex Shank, 1.0 x 6.0mm Slotted Screwdriver Bit, 125mmL	D-2	300
14DT38	3/8" Dr. Quick Release Ratchet Head, 14 x 18mm	F-40	3450	1680	5/16" Hex Shank, 1.2 x 8.0mm Slotted Screwdriver Bit, 125mmL	D-2	400
14DT48	1/2" Dr. Quick Release Ratchet Head, 14 x 18mm	F-40	3450	1690	5/16" Hex Shank, 1.6 x 9.0mm Slotted Screwdriver Bit, 125mmL	D-2	400
14GT12	1.2mm Gravity Type Air Spray Gun	E-28	17180	1692	10mm Hex Shank, 2.0 x 12.0mm Slotted Screwdriver Bit, 125mmL	D-2	600
14GT14	1.4mm Gravity Type Air Spray Gun	E-28	17180	1694	12mm Hex Shank, 2.5 x 14.0mm Slotted Screwdriver Bit, 125mmL	D-2	750
14GT16	1.6mm Gravity Type Air Spray Gun	E-28	17180	1696	14mm Hex Shank, 2.5 x 16.0mm Slotted Screwdriver Bit, 125mmL	D-2	900
14GT18	1.8mm Gravity Type Air Spray Gun	E-28	17180	16HGC6	6" Central Vacuum Type Air Sander (Gear Driven)	E-26	33190
14H012	27 ~ 37mm Hook Head, 14 x 18mm	F-40	4750	16HGN6	6" Non Vacuum Type Air Sander (Gear Driven)	E-26	32270
14H016	38 ~ 48mm Hook Head, 14 x 18mm	F-40	4750	16HGS6	6" Self-Generated Vacuum Type Air Sander (Gear Driven)	E-26	35940
14H025	55 ~ 65mm Hook Head, 14 x 18mm	F-40	4750	1701	1/4" Hex Shank, PH.1 Philips Screwdriver Bit, 160mmL	D-3	380
14H032	67 ~ 77mm Hook Head, 14 x 18mm	F-40	4750	1702	1/4" Hex Shank, PH.2 Philips Screwdriver Bit, 160mmL	D-3	380
14H075	45 ~ 55mm Hook Head, 14 x 18mm	F-40	4750	1703	1/4" Hex Shank, PH.3 Philips Screwdriver Bit, 160mmL	D-3	380
14H100	58 ~ 68mm Hook Head, 14 x 18mm	F-40	4750	1704	5/16" Hex Shank, PH.4 Philips Screwdriver Bit, 160mmL	D-3	500
14H150	77 ~ 87mm Hook Head, 14 x 18mm	F-40	4750	1740	1/4" Hex Shank, 0.6 x 4.0mm Slotted Screwdriver Bit, 160mmL	D-2	380
14RH30	3/8" Dr. Ratchet Head, 78mmL, 14 x 18mm	F-40	2270	1750	1/4" Hex Shank, 0.8 x 5.0mm Slotted Screwdriver Bit, 160mmL	D-2	380
14RH40	1/2" Dr. Ratchet Head, 94mmL, 14 x 18mm	F-40	2900	1760	1/4" Hex Shank, 1.0 x 6.0mm Slotted Screwdriver Bit, 160mmL	D-2	380
14RH44	1/2" Dr. Ratchet Head, 78mmL, 14 x 18mm	F-40	2380	1780	5/16" Hex Shank, 1.2 x 8.0mm Slotted Screwdriver Bit, 160mmL	D-2	500
1501	1/4" Hex Shank, PH.1 Philips Screwdriver Bit, 88mmL	D-3	260	1790	5/16" Hex Shank, 1.6 x 9.0mm Slotted Screwdriver Bit, 160mmL	D-2	500
1502	1/4" Hex Shank, PH.2 Philips Screwdriver Bit, 88mmL	D-3	260	1792	10mm Hex Shank, 2.0 x 12.0mm Slotted Screwdriver Bit, 160mmL	D-2	700



Item No.	Description	Pg.	Code
1794	12mm Hex Shank, 2.5 x 14.0mm Slotted Screwdriver Bit, 160mmL	D-2	880
1796	14mm Hex Shank, 2.5 x 16.0mm Slotted Screwdriver Bit, 160mmL	D-2	1050
1801	1/4" Hex Shank, PH.1 Philips Screwdriver Bit, 200mmL	D-3	450
1802	1/4" Hex Shank, PH.2 Philips Screwdriver Bit, 200mmL	D-3	450
1803	1/4" Hex Shank, PH.3 Philips Screwdriver Bit, 200mmL	D-3	450
1804	5/16" Hex Shank, PH.4 Philips Screwdriver Bit, 200mmL	D-3	600
1840	1/4" Hex Shank, 0.6 x 4.0mm Slotted Screwdriver Bit, 200mmL	D-2	450
1850	1/4" Hex Shank, 0.8x5.0mm Slotted Screwdriver Bit, 200mmL	D-2	450
1860	1/4" Hex Shank, 1.0x6.0mm Slotted Screwdriver Bit, 200mmL	D-2	450
1880	5/16" Hex Shank, 1.2x8.0mm Slotted Screwdriver Bit, 200mmL	D-2	600
1890	5/16" Hex Shank, 1.6x9.0mm Slotted Screwdriver Bit, 200mmL	D-2	600
1892	10mm Hex Shank, 2.0x12.0mm Slotted Screwdriver Bit, 200mmL	D-2	800
1894	12mm Hex Shank, 2.5x14.0mm Slotted Screwdriver Bit, 200mmL	D-2	1000
1896	14mm Hex Shank, 2.5x16.0mm Slotted Screwdriver Bit, 200mmL	D-2	1200
18HGC8	8" Central Vacuum Type Air Sander (Gear Driven)	E-26	35020
18HGN8	8" Non Vacuum Type Air Sander (Gear Driven)	E-26	34100
18HGS8	8" Self-Generated Vacuum Type Air Sander (Gear Driven)	E-26	37430
1902	1/4" Hex Shank, PH.2 Philips Screwdriver Bit, 275mmL	D-3	620
1903	5/16" Hex Shank, PH.3 Philips Screwdriver Bit, 285mmL	D-3	950
1965	1/4" Hex Shank, 1.2x6.5mm Slotted Screwdriver Bit, 175mmL	D-2	420
1980	5/16" Hex Shank, 1.2x8.0mm Slotted Screwdriver Bit, 260mmL	D-2	820
1990	10mm Hex Shank, 1.6x10.0mm Slotted Screwdriver Bit, 285mmL	D-2	1140
<b>2</b>			
205030	1/4" Hex Shank, 0.5x3.0mm Slotted Power Screwdriver Bit, 50mmL D-18	D-18	100
205040	1/4" Hex Shank, 0.6x4.0mm Slotted Power Screwdriver Bit, 50mmL D-18	D-18	100
205050	1/4" Hex Shank, 0.8x5.0mm Slotted Power Screwdriver Bit, 50mmL D-18	D-18	100
205051X	1/4" Dr. Stubby Air Ratchet Wrench, 20 ft. lbs. / 27 Nm	E-2	10000
205055	1/4" Hex Shank, 0.8x5.5mm Slotted Power Screwdriver Bit, 50mmL D-18	D-18	100
205060	1/4" Hex Shank, 1.0x6.0mm Slotted Power Screwdriver Bit, 50mmL D-18	D-18	100
205065	1/4" Hex Shank, 1.0x6.5mm Slotted Power Screwdriver Bit, 50mmL D-18	D-18	100
205070	1/4" Hex Shank, 1.2x7.0mm Slotted Power Screwdriver Bit, 50mmL D-18	D-18	100
208+	1/4" Dr. 1/4" Hex Shank Bit Holder, 25mmL	D-21	200
208+1100	1/4" Dr. PH.0 Philips Bit Socket, 45mmL	C-17	235
208+1101	1/4" Dr. PH.1 Philips Bit Socket, 45mmL	C-17	235
208+1102	1/4" Dr. PH.2 Philips Bit Socket, 45mmL	C-17	235
208+1103	1/4" Dr. PH.3 Philips Bit Socket, 45mmL	C-17	235
208+1130	1/4" Dr. 0.5 x 3.0mm Slotted Bit Socket, 45mmL	C-17	235
208+1140	1/4" Dr. 0.6 x 4.0mm Slotted Bit Socket, 45mmL	C-17	235
208+1150	1/4" Dr. 0.8 x 5.5mm Slotted Bit Socket, 45mmL	C-17	235
208+1155	1/4" Dr. 0.8 x 5.0mm Slotted Bit Socket, 45mmL	C-17	235
208+1160	1/4" Dr. 1.0 x 6.0mm Slotted Bit Socket, 45mmL	C-17	235
208+1170	1/4" Dr. 1.2 x 7.0mm Slotted Bit Socket, 45mmL	C-17	235
208+1301	1/4" Dr. PH.1 Philips Bit Socket, 70mmL	C-17	300
208+1302	1/4" Dr. PH.2 Philips Bit Socket, 70mmL	C-17	300
208+1303	1/4" Dr. PH.3 Philips Bit Socket, 70mmL	C-17	300
208+1330	1/4" Dr. 0.5 x 3.0mm Slotted Bit Socket, 70mmL	C-17	300
208+1340	1/4" Dr. 0.6 x 4.0mm Slotted Bit Socket, 70mmL	C-17	300
208+1350	1/4" Dr. 0.8 x 5.0mm Slotted Bit Socket, 70mmL	C-17	300
208+1360	1/4" Dr. 1.0 x 6.0mm Slotted Bit Socket, 70mmL	C-17	300
208+1501	1/4" Dr. PH.1 Philips Bit Socket, 100mmL	C-17	440
208+1502	1/4" Dr. PH.2 Philips Bit Socket, 100mmL	C-17	440
208+1503	1/4" Dr. PH.3 Philips Bit Socket, 100mmL	C-17	440
208+1530	1/4" Dr. 0.5 x 3.0mm Slotted Bit Socket, 100mmL	C-17	440
208+1540	1/4" Dr. 0.6 x 4.0mm Slotted Bit Socket, 100mmL	C-17	440
208+1550	1/4" Dr. 0.8 x 5.0mm Slotted Bit Socket, 100mmL	C-17	440
208+1560	1/4" Dr. 1.0 x 6.0mm Slotted Bit Socket, 100mmL	C-17	440
208+1601	1/4" Dr. PH.1 Philips Bit Socket, 140mmL	C-17	480
208+1602	1/4" Dr. PH.2 Philips Bit Socket, 140mmL	C-17	480
208+1603	1/4" Dr. PH.3 Philips Bit Socket, 140mmL	C-17	480
208+1630	1/4" Dr. 0.5 x 3.0mm Slotted Bit Socket, 140mmL	C-17	480
208+1640	1/4" Dr. 0.6 x 4.0mm Slotted Bit Socket, 140mmL	C-17	480
208+1650	1/4" Dr. 0.8 x 5.0mm Slotted Bit Socket, 140mmL	C-17	480

Item No.	Description	Pg.	Code
208+1660	1/4" Dr. 1.0 x 6.0mm Slotted Bit Socket, 140mmL	C-17	480
208+2122	1/4" Dr. 2mm Hex Bit Socket, 45mmL	C-18	235
208+2125	1/4" Dr. 2.5mm Hex Bit Socket, 45mmL	C-18	235
208+2133	1/4" Dr. 3mm Hex Bit Socket, 45mmL	C-18	235
208+2134	1/4" Dr. 4mm Hex Bit Socket, 45mmL	C-18	235
208+2135	1/4" Dr. 5mm Hex Bit Socket, 45mmL	C-18	235
208+2136	1/4" Dr. 6mm Hex Bit Socket, 45mmL	C-18	235
208+2137	1/4" Dr. 7mm Hex Bit Socket, 45mmL	C-18	270
208+2138	1/4" Dr. 8mm Hex Bit Socket, 45mmL	C-18	270
208+2322	1/4" Dr. 2mm Hex Bit Socket, 70mmL	C-18	300
208+2325	1/4" Dr. 2.5mm Hex Bit Socket, 70mmL	C-18	300
208+2333	1/4" Dr. 3mm Hex Bit Socket, 70mmL	C-18	300
208+2334	1/4" Dr. 4mm Hex Bit Socket, 70mmL	C-18	300
208+2335	1/4" Dr. 5mm Hex Bit Socket, 70mmL	C-18	300
208+2336	1/4" Dr. 6mm Hex Bit Socket, 70mmL	C-18	300
208+2522	1/4" Dr. 2mm Hex Bit Socket, 100mmL	C-18	440
208+2525	1/4" Dr. 2.5mm Hex Bit Socket, 100mmL	C-18	440
208+2533	1/4" Dr. 3mm Hex Bit Socket, 100mmL	C-18	440
208+2534	1/4" Dr. 4mm Hex Bit Socket, 100mmL	C-18	440
208+2535	1/4" Dr. 5mm Hex Bit Socket, 100mmL	C-18	440
208+2536	1/4" Dr. 6mm Hex Bit Socket, 100mmL	C-18	440
208+2622	1/4" Dr. 2mm Hex Bit Socket, 140mmL	C-18	480
208+2625	1/4" Dr. 2.5mm Hex Bit Socket, 140mmL	C-18	480
208+2633	1/4" Dr. 3mm Hex Bit Socket, 140mmL	C-18	480
208+2634	1/4" Dr. 4mm Hex Bit Socket, 140mmL	C-18	480
208+2635	1/4" Dr. 5mm Hex Bit Socket, 140mmL	C-18	480
208+2636	1/4" Dr. 6mm Hex Bit Socket, 140mmL	C-18	480
208+3104	1/4" Dr. 1/16" Hex Bit Socket, 45mmL	C-19	235
208+3105	1/4" Dr. 5/64" Hex Bit Socket, 45mmL	C-19	235
208+3106	1/4" Dr. 3/32" Hex Bit Socket, 45mmL	C-19	235
208+3107	1/4" Dr. 7/64" Hex Bit Socket, 45mmL	C-19	235
208+3108	1/4" Dr. 1/8" Hex Bit Socket, 45mmL	C-19	235
208+3110	1/4" Dr. 5/32" Hex Bit Socket, 45mmL	C-19	235
208+3112	1/4" Dr. 3/16" Hex Bit Socket, 45mmL	C-19	235
208+3114	1/4" Dr. 7/32" Hex Bit Socket, 45mmL	C-19	235
208+3116	1/4" Dr. 1/4" Hex Bit Socket, 45mmL	C-19	235
208+3304	1/4" Dr. 1/16" Hex Bit Socket, 70mmL	C-19	300
208+3305	1/4" Dr. 5/64" Hex Bit Socket, 70mmL	C-19	300
208+3306	1/4" Dr. 3/32" Hex Bit Socket, 70mmL	C-19	300
208+3307	1/4" Dr. 7/64" Hex Bit Socket, 70mmL	C-19	300
208+3308	1/4" Dr. 1/8" Hex Bit Socket, 70mmL	C-19	300
208+3310	1/4" Dr. 5/32" Hex Bit Socket, 70mmL	C-19	300
208+3312	1/4" Dr. 3/16" Hex Bit Socket, 70mmL	C-19	300
208+3314	1/4" Dr. 7/32" Hex Bit Socket, 70mmL	C-19	300
208+3316	1/4" Dr. 1/4" Hex Bit Socket, 70mmL	C-19	300
208+3504	1/4" Dr. 1/16" Hex Bit Socket, 100mmL	C-19	440
208+3505	1/4" Dr. 5/64" Hex Bit Socket, 100mmL	C-19	440
208+3506	1/4" Dr. 3/32" Hex Bit Socket, 100mmL	C-19	440
208+3507	1/4" Dr. 7/64" Hex Bit Socket, 100mmL	C-19	440
208+3508	1/4" Dr. 1/8" Hex Bit Socket, 100mmL	C-19	440
208+3510	1/4" Dr. 5/32" Hex Bit Socket, 100mmL	C-19	440
208+3512	1/4" Dr. 3/16" Hex Bit Socket, 100mmL	C-19	440
208+3514	1/4" Dr. 7/32" Hex Bit Socket, 100mmL	C-19	440
208+3516	1/4" Dr. 1/4" Hex Bit Socket, 100mmL	C-19	440
208+3604	1/4" Dr. 1/16" Hex Bit Socket, 140mmL	C-19	480
208+3605	1/4" Dr. 5/64" Hex Bit Socket, 140mmL	C-19	480
208+3606	1/4" Dr. 3/32" Hex Bit Socket, 140mmL	C-19	480
208+3607	1/4" Dr. 7/64" Hex Bit Socket, 140mmL	C-19	480
208+3608	1/4" Dr. 1/8" Hex Bit Socket, 140mmL	C-19	480
208+3610	1/4" Dr. 5/32" Hex Bit Socket, 140mmL	C-19	480
208+3612	1/4" Dr. 3/16" Hex Bit Socket, 140mmL	C-19	480
208+3614	1/4" Dr. 7/32" Hex Bit Socket, 140mmL	C-19	480
208+3616	1/4" Dr. 1/4" Hex Bit Socket, 140mmL	C-19	480
208+4133	1/4" Dr. 3mm Wobble Hex Bit Socket, 45mmL	C-18	265
208+4134	1/4" Dr. 4mm Wobble Hex Bit Socket, 45mmL	C-18	265
208+4135	1/4" Dr. 5mm Wobble Hex Bit Socket, 45mmL	C-18	265
208+4136	1/4" Dr. 6mm Wobble Hex Bit Socket, 45mmL	C-18	265
208+4333	1/4" Dr. 3mm Wobble Hex Bit Socket, 70mmL	C-18	330
208+4334	1/4" Dr. 4mm Wobble Hex Bit Socket, 70mmL	C-18	330
208+4335	1/4" Dr. 5mm Wobble Hex Bit Socket, 70mmL	C-18	330



Item No.	Description	Pg.	Code	Item No.	Description	Pg.	Code
208+8504	1/4" Dr. M4 Triple Square Bit Socket, 100mmL	C-21	440	215209	1/4" Dr. 9mm Deep Impact Socket	A-3	305
208+8505	1/4" Dr. M5 Triple Square Bit Socket, 100mmL	C-21	440	215210	1/4" Dr. 10mm Deep Impact Socket	A-3	305
208+8506	1/4" Dr. M6 Triple Square Bit Socket, 100mmL	C-21	440	215211	1/4" Dr. 11mm Deep Impact Socket	A-3	305
208+8604	1/4" Dr. M4 Triple Square Bit Socket, 140mmL	C-21	480	215212	1/4" Dr. 12mm Deep Impact Socket	A-3	305
208+8605	1/4" Dr. M5 Triple Square Bit Socket, 140mmL	C-21	480	215213	1/4" Dr. 13mm Deep Impact Socket	A-3	305
208+8606	1/4" Dr. M6 Triple Square Bit Socket, 140mmL	C-21	480	215214	1/4" Dr. 14mm Deep Impact Socket	A-3	305
208+9004	1/4" Dr. M4 Ribe Bit Socket, 45mmL	C-20	260	217250	5/16" Hex Shank, 0.8x5.0mm Slotted Power Screwdriver Bit, 72mmL	D-18	220
208+9005	1/4" Dr. M5 Ribe Bit Socket, 45mmL	C-20	260	217255	5/16" Hex Shank, 0.8x5.5mm Slotted Power Screwdriver Bit, 72mmL	D-18	220
208+9006	1/4" Dr. M6 Ribe Bit Socket, 45mmL	C-20	260	217260	5/16" Hex Shank, 1.0x6.0mm Slotted Power Screwdriver Bit, 72mmL	D-18	220
208+9054	1/4" Dr. SP4 Spanner Bit Socket, 45mmL	C-22	290	217265	5/16" Hex Shank, 1.0x6.5mm Slotted Power Screwdriver Bit, 72mmL	D-18	220
208+9056	1/4" Dr. SP6 Spanner Bit Socket, 45mmL	C-22	290	217270	5/16" Hex Shank, 1.2x8.0mm Slotted Power Screwdriver Bit, 72mmL	D-18	220
208+9058	1/4" Dr. SP8 Spanner Bit Socket, 45mmL	C-22	290	217280	5/16" Hex Shank, 1.6x9.0mm Slotted Power Screwdriver Bit, 72mmL	D-18	220
208+9060	1/4" Dr. SP10 Spanner Bit Socket, 45mmL	C-22	290	220002	1/4" Dr. Extension Bar, 50mmL	B-7	210
208+9062	1/4" Dr. SP12 Spanner Bit Socket, 45mmL	C-22	290	220002B	1/4" Dr. Wobble Extension Bar, 50mmL	B-7	330
208+9064	1/4" Dr. SP14 Spanner Bit Socket, 45mmL	C-22	290	220003	1/4" Dr. Extension Bar, 75mmL	B-7	230
208+9204	1/4" Dr. M4 Ribe Bit Socket, 70mmL	C-20	330	220004	1/4" Dr. Extension Bar, 100mmL	B-7	270
208+9205	1/4" Dr. M5 Ribe Bit Socket, 70mmL	C-20	330	220004B	1/4" Dr. Wobble Extension Bar, 100mmL	B-7	380
208+9206	1/4" Dr. M6 Ribe Bit Socket, 70mmL	C-20	330	220006	1/4" Dr. Extension Bar, 150mmL	B-7	320
208+9254	1/4" Dr. SP4 Spanner Bit Socket, 70mmL	C-22	360	220006B	1/4" Dr. Wobble Extension Bar, 150mmL	B-7	470
208+9256	1/4" Dr. SP6 Spanner Bit Socket, 70mmL	C-22	360	220009	1/4" Dr. Extension Bar, 225mmL	B-7	400
208+9258	1/4" Dr. SP8 Spanner Bit Socket, 70mmL	C-22	360	220009B	1/4" Dr. Wobble Extension Bar, 225mmL	B-7	670
208+9260	1/4" Dr. SP10 Spanner Bit Socket, 70mmL	C-22	360	220012	1/4" Dr. Extension Bar, 300mmL	B-7	500
208+9262	1/4" Dr. SP12 Spanner Bit Socket, 70mmL	C-22	360	220150	1/4" Dr. Socket Driver	B-7	400
208+9264	1/4" Dr. SP14 Spanner Bit Socket, 70mmL	C-22	360	220160	1/4" Dr. Folding Socket Driver	B-7	800
208+9404	1/4" Dr. M4 Ribe Bit Socket, 100mmL	C-20	500	222503	1/4" Dr. 3mm Hand Socket	B-2	140
208+9405	1/4" Dr. M5 Ribe Bit Socket, 100mmL	C-20	500	222504	1/4" Dr. 4mm Hand Socket	B-2	140
208+9406	1/4" Dr. M6 Ribe Bit Socket, 100mmL	C-20	500	2225045	1/4" Dr. 4.5mm Hand Socket	B-2	140
210002	1/4" Dr. Impact Extension Bar, 50mmL	A-3	180	222505	1/4" Dr. 5mm Hand Socket	B-2	140
210003	1/4" Dr. Impact Extension Bar, 75mmL	A-3	195	2225055	1/4" Dr. 5.5mm Hand Socket	B-2	140
210004	1/4" Dr. Impact Extension Bar, 100mmL	A-3	300	222506	1/4" Dr. 6mm Hand Socket	B-2	140
210006	1/4" Dr. Impact Extension Bar, 150mmL	A-3	350	222507	1/4" Dr. 7mm Hand Socket	B-2	140
211000	Air Screwdriver (8H)	E-19	16800	222508	1/4" Dr. 8mm Hand Socket	B-2	140
2122	1/4" Hex Shank, 2mm Hex Screwdriver Bit, 30mmL	D-4	55	222509	1/4" Dr. 9mm Hand Socket	B-2	140
2125	1/4" Hex Shank, 2.5mm Hex Screwdriver Bit, 30mmL	D-4	55	222510	1/4" Dr. 10mm Hand Socket	B-2	140
212503	1/4" Dr. 3mm Impact Socket	A-2	190	222511	1/4" Dr. 11mm Hand Socket	B-2	140
212504	1/4" Dr. 4mm Impact Socket	A-2	190	222512	1/4" Dr. 12mm Hand Socket	B-2	140
2125045	1/4" Dr. 4.5mm Impact Socket	A-2	190	222513	1/4" Dr. 13mm Hand Socket	B-2	140
212505	1/4" Dr. 5mm Impact Socket	A-2	190	222514	1/4" Dr. 14mm Hand Socket	B-2	140
2125055	1/4" Dr. 5.5mm Impact Socket	A-2	190	222601	1/4" Dr. #1 Philips Head Hand Socket	B-4	160
212506	1/4" Dr. 6mm Impact Socket	A-2	190	222602	1/4" Dr. #2 Philips Head Hand Socket	B-4	160
212507	1/4" Dr. 7mm Impact Socket	A-2	190	222603	1/4" Dr. #3 Philips Head Hand Socket	B-4	160
212508	1/4" Dr. 8mm Impact Socket	A-2	190	222604	1/4" Dr. #4 Philips Head Hand Socket	B-4	160
212509	1/4" Dr. 9mm Impact Socket	A-2	190	222640	1/4" Dr. 0.8 x 4.0mm Slotted Head Hand Socket	B-4	160
212510	1/4" Dr. 10mm Impact Socket	A-2	190	222655	1/4" Dr. 1.0 x 5.5mm Slotted Head Hand Socket	B-4	160
212511	1/4" Dr. 11mm Impact Socket	A-2	190	222665	1/4" Dr. 1.2 x 6.5mm Slotted Head Hand Socket	B-4	160
212512	1/4" Dr. 12mm Impact Socket	A-2	190	222680	1/4" Dr. 1.2 x 8.0mm Slotted Head Hand Socket	B-4	160
212513	1/4" Dr. 13mm Impact Socket	A-2	190	222685	1/4" Dr. 1.6 x 8.5mm Slotted Head Hand Socket	B-4	160
212514	1/4" Dr. 14mm Impact Socket	A-2	190	222695	1/4" Dr. 1.6 x 9.7mm Slotted Head Hand Socket	B-4	160
213000	Air Screwdriver (5H)	E-19	9670	225204	1/4" Dr. 4mm Deep Hand Socket	B-2	260
2133	1/4" Hex Shank, 3mm Hex Screwdriver Bit, 30mmL	D-4	55	2252045	1/4" Dr. 4.5mm Deep Hand Socket	B-2	260
2134	1/4" Hex Shank, 4mm Hex Screwdriver Bit, 30mmL	D-4	55	225205	1/4" Dr. 5mm Deep Hand Socket	B-2	260
2135	1/4" Hex Shank, 5mm Hex Screwdriver Bit, 30mmL	D-4	55	2252055	1/4" Dr. 5.5mm Deep Hand Socket	B-2	260
2136	1/4" Hex Shank, 6mm Hex Screwdriver Bit, 30mmL	D-4	55	225206	1/4" Dr. 6mm Deep Hand Socket	B-2	260
2143	5/16" Hex Shank, 3mm Hex Screwdriver Bit, 30mmL	D-4	92	225207	1/4" Dr. 7mm Deep Hand Socket	B-2	260
2144	5/16" Hex Shank, 4mm Hex Screwdriver Bit, 30mmL	D-4	92	225208	1/4" Dr. 8mm Deep Hand Socket	B-2	260
2145	5/16" Hex Shank, 5mm Hex Screwdriver Bit, 30mmL	D-4	92	225209	1/4" Dr. 9mm Deep Hand Socket	B-2	260
2146	5/16" Hex Shank, 6mm Hex Screwdriver Bit, 30mmL	D-4	92	225210	1/4" Dr. 10mm Deep Hand Socket	B-2	260
2147	5/16" Hex Shank, 7mm Hex Screwdriver Bit, 30mmL	D-4	92	225211	1/4" Dr. 11mm Deep Hand Socket	B-2	260
2148	5/16" Hex Shank, 8mm Hex Screwdriver Bit, 30mmL	D-4	92	225212	1/4" Dr. 12mm Deep Hand Socket	B-2	260
2149	9mm Hex Shank, 9mm Hex Screwdriver Bit, 30mmL	D-4	150	225213	1/4" Dr. 13mm Deep Hand Socket	B-2	260
2150	10mm Hex Shank, 10mm Hex Screwdriver Bit, 30mmL	D-4	150	225214	1/4" Dr. 14mm Deep Hand Socket	B-2	260
2151	11mm Hex Shank, 11mm Hex Screwdriver Bit, 30mmL	D-4	195	227210	5/16" Hex Shank, T-10 Star Power Screwdriver Bit, 72mmL	D-19	220
2152	12mm Hex Shank, 12mm Hex Screwdriver Bit, 30mmL	D-4	195	227215	5/16" Hex Shank, T-15 Star Power Screwdriver Bit, 72mmL	D-19	220
215204	1/4" Dr. 4mm Deep Impact Socket	A-3	305	227220	5/16" Hex Shank, T-20 Star Power Screwdriver Bit, 72mmL	D-19	220
2152045	1/4" Dr. 4.5mm Deep Impact Socket	A-3	305	227225	5/16" Hex Shank, T-25 Star Power Screwdriver Bit, 72mmL	D-19	220
215205	1/4" Dr. 5mm Deep Impact Socket	A-3	305	227227	5/16" Hex Shank, T-27 Star Power Screwdriver Bit, 72mmL	D-19	220
2152055	1/4" Dr. 5.5mm Deep Impact Socket	A-3	305	227230	5/16" Hex Shank, T-30 Star Power Screwdriver Bit, 72mmL	D-19	220
215206	1/4" Dr. 6mm Deep Impact Socket	A-3	305	227240	5/16" Hex Shank, T-40 Star Power Screwdriver Bit, 72mmL	D-19	220
215207	1/4" Dr. 7mm Deep Impact Socket	A-3	305	227245	5/16" Hex Shank, T-45 Star Power Screwdriver Bit, 72mmL	D-19	220
215208	1/4" Dr. 8mm Deep Impact Socket	A-3	305	227250	5/16" Hex Shank, T-50 Star Power Screwdriver Bit, 72mmL	D-19	220

Item No.	Description	Pg.	Code	Item No.	Description	Pg.	Code
2322	1/4" Hex Shank, 2mm Hex Screwdriver Bit, 56mmL	D-4	120	253507	1/4" Dr. 7mm Universal Hand Socket (12-Point)	B-4	480
2325	1/4" Hex Shank, 2.5mm Hex Screwdriver Bit, 56mmL	D-4	120	253508	1/4" Dr. 8mm Universal Hand Socket (12-Point)	B-4	480
232505	1/4" Dr. 5mm Hand Socket (12-Point)	B-3	140	253509	1/4" Dr. 9mm Universal Hand Socket (12-Point)	B-4	480
2325055	1/4" Dr. 5.5mm Hand Socket (12-Point)	B-3	140	253510	1/4" Dr. 10mm Universal Hand Socket (12-Point)	B-4	480
232506	1/4" Dr. 6mm Hand Socket (12-Point)	B-3	140	253511	1/4" Dr. 11mm Universal Hand Socket (12-Point)	B-4	520
232507	1/4" Dr. 7mm Hand Socket (12-Point)	B-3	140	253512	1/4" Dr. 12mm Universal Hand Socket (12-Point)	B-4	520
232508	1/4" Dr. 8mm Hand Socket (12-Point)	B-3	140	253513	1/4" Dr. 13mm Universal Hand Socket (12-Point)	B-4	520
232509	1/4" Dr. 9mm Hand Socket (12-Point)	B-3	140	253514	1/4" Dr. 14mm Universal Hand Socket (12-Point)	B-4	520
232510	1/4" Dr. 10mm Hand Socket (12-Point)	B-3	140	2536	1/4" Hex Shank, 6mm Hex Screwdriver Bit, 88mmL	D-4	260
232511	1/4" Dr. 11mm Hand Socket (12-Point)	B-3	140	2547	5/16" Hex Shank, 7mm Hex Screwdriver Bit, 88mmL	D-4	300
232512	1/4" Dr. 12mm Hand Socket (12-Point)	B-3	140	2548	5/16" Hex Shank, 8mm Hex Screwdriver Bit, 88mmL	D-4	300
232513	1/4" Dr. 13mm Hand Socket (12-Point)	B-3	140	2549	9mm Hex Shank, 9mm Hex Screwdriver Bit, 88mmL	D-4	400
232514	1/4" Dr. 14mm Hand Socket (12-Point)	B-3	140	2550	10mm Hex Shank, 10mm Hex Screwdriver Bit, 88mmL	D-4	400
232803	1/4" Dr. 3mm Hex Head Hand Socket	B-5	160	255001	1/4" Hex Shank, PZ.1 Posidriv Power Screwdriver Bit, 50mmL	D-18	100
232804	1/4" Dr. 4mm Hex Head Hand Socket	B-5	160	255002	1/4" Hex Shank, PZ.2 Posidriv Power Screwdriver Bit, 50mmL	D-18	100
232805	1/4" Dr. 5mm Hex Head Hand Socket	B-5	160	255003	1/4" Hex Shank, PZ.3 Posidriv Power Screwdriver Bit, 50mmL	D-18	100
232806	1/4" Dr. 6mm Hex Head Hand Socket	B-5	160	2551	11mm Hex Shank, 11mm Hex Screwdriver Bit, 88mmL	D-4	540
232807	1/4" Dr. 7mm Hex Head Hand Socket	B-5	160	2552	12mm Hex Shank, 12mm Hex Screwdriver Bit, 88mmL	D-4	540
232808	1/4" Dr. 8mm Hex Head Hand Socket	B-5	160	2553	13mm Hex Shank, 13mm Hex Screwdriver Bit, 88mmL	D-4	680
232809	1/4" Dr. 9mm Hex Head Hand Socket	B-5	160	2554	14mm Hex Shank, 14mm Hex Screwdriver Bit, 88mmL	D-4	680
232810	1/4" Dr. 10mm Hex Head Hand Socket	B-5	160	2556	16mm Hex Shank, 16mm Hex Screwdriver Bit, 88mmL	D-4	770
2333	1/4" Hex Shank, 3mm Hex Screwdriver Bit, 56mmL	D-4	120	2557	17mm Hex Shank, 17mm Hex Screwdriver Bit, 88mmL	D-4	820
2334	1/4" Hex Shank, 4mm Hex Screwdriver Bit, 56mmL	D-4	120	2559	19mm Hex Shank, 19mm Hex Screwdriver Bit, 88mmL	D-4	920
2335	1/4" Hex Shank, 5mm Hex Screwdriver Bit, 56mmL	D-4	120	2622	1/4" Hex Shank, 2mm Hex Screwdriver Bit, 125mmL	D-5	300
2336	1/4" Hex Shank, 6mm Hex Screwdriver Bit, 56mmL	D-4	120	2625	1/4" Hex Shank, 2.5mm Hex Screwdriver Bit, 125mmL	D-5	300
2347	5/16" Hex Shank, 7mm Hex Screwdriver Bit, 56mmL	D-4	160	262508	1/4" Dr. 1/4" Double Square Hand Socket (8-Point)	B-4	180
2348	5/16" Hex Shank, 8mm Hex Screwdriver Bit, 56mmL	D-4	160	262510	1/4" Dr. 5/16" Double Square Hand Socket (8-Point)	B-4	180
2349	9mm Hex Shank, 9mm Hex Screwdriver Bit, 56mmL	D-4	220	262512	1/4" Dr. 3/8" Double Square Hand Socket (8-Point)	B-4	180
2350	10mm Hex Shank, 10mm Hex Screwdriver Bit, 56mmL	D-4	220	262808	1/4" Dr. 1/4" Hex Shank Impact Bit Holder, 28mmL	A-3	800
235000	1/4" Hex Shank, PH.0 Philips Power Screwdriver Bit, 50mmL	D-18	100	2633	1/4" Hex Shank, 3mm Hex Screwdriver Bit, 125mmL	D-5	300
235001	1/4" Hex Shank, PH.1 Philips Power Screwdriver Bit, 50mmL	D-18	100	2634	1/4" Hex Shank, 4mm Hex Screwdriver Bit, 125mmL	D-5	300
235002	1/4" Hex Shank, PH.2 Philips Power Screwdriver Bit, 50mmL	D-18	100	2635	1/4" Hex Shank, 5mm Hex Screwdriver Bit, 125mmL	D-5	300
235003	1/4" Hex Shank, PH.3 Philips Power Screwdriver Bit, 50mmL	D-18	100	263508	1/4" Dr. 1/4" Hex Shank Impact Bit Holder, 35mmL	A-3	475
2351	11mm Hex Shank, 11mm Hex Screwdriver Bit, 56mmL	D-4	280	263510	1/4" Dr. 5/16" Hex Shank Impact Bit Holder, 35mmL	A-3	495
2352	12mm Hex Shank, 12mm Hex Screwdriver Bit, 56mmL	D-4	280	2636	1/4" Hex Shank, 6mm Hex Screwdriver Bit, 125mmL	D-5	300
235205	1/4" Dr. 5mm Deep Hand Socket (12-Point)	B-3	260	263708	1/4" Dr. 1/4" Universal Hand Socket (12-Point)	B-4	480
2352055	1/4" Dr. 5.5mm Deep Hand Socket (12-Point)	B-3	260	263710	1/4" Dr. 5/16" Universal Hand Socket (12-Point)	B-4	480
235206	1/4" Dr. 6mm Deep Hand Socket (12-Point)	B-3	260	263712	1/4" Dr. 3/8" Universal Hand Socket (12-Point)	B-4	480
235207	1/4" Dr. 7mm Deep Hand Socket (12-Point)	B-3	260	263714	1/4" Dr. 7/16" Universal Hand Socket (12-Point)	B-4	520
235208	1/4" Dr. 8mm Deep Hand Socket (12-Point)	B-3	260	263716	1/4" Dr. 1/2" Universal Hand Socket (12-Point)	B-4	520
235209	1/4" Dr. 9mm Deep Hand Socket (12-Point)	B-3	260	263718	1/4" Dr. 9/16" Universal Hand Socket (12-Point)	B-4	520
235210	1/4" Dr. 10mm Deep Hand Socket (12-Point)	B-3	260	2647	5/16" Hex Shank, 7mm Hex Screwdriver Bit, 125mmL	D-5	400
235211	1/4" Dr. 11mm Deep Hand Socket (12-Point)	B-3	260	2648	5/16" Hex Shank, 8mm Hex Screwdriver Bit, 125mmL	D-5	400
235212	1/4" Dr. 12mm Deep Hand Socket (12-Point)	B-3	260	2649	9mm Hex Shank, 9mm Hex Screwdriver Bit, 125mmL	D-5	600
235213	1/4" Dr. 13mm Deep Hand Socket (12-Point)	B-3	260	2650	10mm Hex Shank, 10mm Hex Screwdriver Bit, 125mmL	D-5	600
235214	1/4" Dr. 14mm Deep Hand Socket (12-Point)	B-3	260	265020	1/4" Hex Shank, 2mm Hex Power Screwdriver Bit, 50mmL	D-19	100
2353	13mm Hex Shank, 13mm Hex Screwdriver Bit, 56mmL	D-4	310	265025	1/4" Hex Shank, 2.5mm Hex Power Screwdriver Bit, 50mmL	D-19	100
2354	14mm Hex Shank, 14mm Hex Screwdriver Bit, 56mmL	D-4	340	265030	1/4" Hex Shank, 3mm Hex Power Screwdriver Bit, 50mmL	D-19	100
2356	16mm Hex Shank, 16mm Hex Screwdriver Bit, 56mmL	D-4	410	265040	1/4" Hex Shank, 4mm Hex Power Screwdriver Bit, 50mmL	D-19	100
2357	17mm Hex Shank, 17mm Hex Screwdriver Bit, 56mmL	D-4	480	265050	1/4" Hex Shank, 5mm Hex Power Screwdriver Bit, 50mmL	D-19	100
2359	19mm Hex Shank, 19mm Hex Screwdriver Bit, 56mmL	D-4	540	265060	1/4" Hex Shank, 6mm Hex Power Screwdriver Bit, 50mmL	D-19	100
242508	1/4" Dr. 8mm Double Square Hand Socket (8-Point)	B-4	180	2651	11mm Hex Shank, 11mm Hex Screwdriver Bit, 125mmL	D-5	750
242510	1/4" Dr. 10mm Double Square Hand Socket (8-Point)	B-4	180	2652	12mm Hex Shank, 12mm Hex Screwdriver Bit, 125mmL	D-5	750
247201	5/16" Hex Shank, PH.1 Philips Power Screwdriver Bit, 72mmL	D-18	220	2653	13mm Hex Shank, 13mm Hex Screwdriver Bit, 125mmL	D-5	900
247202	5/16" Hex Shank, PH.2 Philips Power Screwdriver Bit, 72mmL	D-18	220	2654	14mm Hex Shank, 14mm Hex Screwdriver Bit, 125mmL	D-5	900
247203	5/16" Hex Shank, PH.3 Philips Power Screwdriver Bit, 72mmL	D-18	220	2656	16mm Hex Shank, 16mm Hex Screwdriver Bit, 125mmL	D-5	1050
247204	5/16" Hex Shank, PH.4 Philips Power Screwdriver Bit, 72mmL	D-18	220	2657	17mm Hex Shank, 17mm Hex Screwdriver Bit, 125mmL	D-5	1160
2522	1/4" Hex Shank, 2mm Hex Screwdriver Bit, 88mmL	D-4	260	2659	19mm Hex Shank, 19mm Hex Screwdriver Bit, 125mmL	D-5	1310
2525	1/4" Hex Shank, 2.5mm Hex Screwdriver Bit, 88mmL	D-4	260	272065	1/4" Hex Dr. 1/4" Dr. Spinner Handle, 65mmL	D-22	200
252504	1/4" Dr. E-4 E-Star Hand Socket	B-4	260	27206A	1/4" Hex Dr. 1/4" Dr. Spinner Handle(for Electric Drill), 65mmL	D-22	200
252505	1/4" Dr. E-5 E-Star Hand Socket	B-4	260	27206P	1/4" Hex Dr. 1/4" Dr. Spinner Handle(for Electric Drill), 65mmL	D-22	200
252506	1/4" Dr. E-6 E-Star Hand Socket	B-4	260	272140	1/4" Hex Dr. 1/4" Dr. Spinner Handle, 140mmL	D-22	400
252507	1/4" Dr. E-7 E-Star Hand Socket	B-4	260	2722	1/4" Hex Shank, 2mm Hex Screwdriver Bit, 160mmL	D-5	380
252508	1/4" Dr. E-8 E-Star Hand Socket	B-4	260	2725	1/4" Hex Shank, 2.5mm Hex Screwdriver Bit, 160mmL	D-5	380
252510	1/4" Dr. E-10 E-Star Hand Socket	B-4	260	272506	1/4" Dr. 3/16" Hand Socket (12-Point)	B-3	140
252511	1/4" Dr. E-11 E-Star Hand Socket	B-4	260	272507	1/4" Dr. 7/32" Hand Socket (12-Point)	B-3	140
2533	1/4" Hex Shank, 3mm Hex Screwdriver Bit, 88mmL	D-4	260	272508	1/4" Dr. 1/4" Hand Socket (12-Point)	B-3	140
2534	1/4" Hex Shank, 4mm Hex Screwdriver Bit, 88mmL	D-4	260	272509	1/4" Dr. 9/32" Hand Socket (12-Point)	B-3	140
2535	1/4" Hex Shank, 5mm Hex Screwdriver Bit, 88mmL	D-4	260	272510	1/4" Dr. 5/16" Hand Socket (12-Point)	B-3	140
253506	1/4" Dr. 6mm Universal Hand Socket (12-Point)	B-4	480	272511	1/4" Dr. 11/32" Hand Socket (12-Point)	B-3	140

Item No.	Description	Pg.	Code
272512	1/4" Dr. 3/8" Hand Socket (12-Point)	B-3	140
272514	1/4" Dr. 7/16" Hand Socket (12-Point)	B-3	140
272516	1/4" Dr. 1/2" Hand Socket (12-Point)	B-3	140
272518	1/4" Dr. 9/16" Hand Socket (12-Point)	B-3	140
272804	1/4" Dr. 1/8" Hex Head Hand Socket	B-5	160
272805	1/4" Dr. 5/32" Hex Head Hand Socket	B-5	160
272806	1/4" Dr. 3/16" Hex Head Hand Socket	B-5	160
272807	1/4" Dr. 7/32" Hex Head Hand Socket	B-5	160
272808	1/4" Dr. 1/4" Hex Head Hand Socket	B-5	160
272809	1/4" Dr. 9/32" Hex Head Hand Socket	B-5	160
272810	1/4" Dr. 5/16" Hex Head Hand Socket	B-5	160
272812	1/4" Dr. 3/8" Hex Head Hand Socket	B-5	160
273065	1/4" Hex Dr. 3/8" Dr. Spinner Handle, 65mmL	D-22	250
27306A	1/4" Hex Dr. 3/8" Dr. Spinner Handle(for Electric Drill), 65mmL	D-22	250
27306P	1/4" Hex Dr. 3/8" Dr. Spinner Handle(for Electric Drill), 65mmL	D-22	250
2733	1/4" Hex Shank, 3mm Hex Screwdriver Bit, 160mmL	D-5	380
2734	1/4" Hex Shank, 4mm Hex Screwdriver Bit, 160mmL	D-5	380
2735	1/4" Hex Shank, 5mm Hex Screwdriver Bit, 160mmL	D-5	380
2736	1/4" Hex Shank, 6mm Hex Screwdriver Bit, 160mmL	D-5	380
274065	1/4" Hex Dr. 1/2" Dr. Spinner Handle, 65mmL	D-22	320
27406A	1/4" Hex Dr. 1/2" Dr. Spinner Handle(for Electric Drill), 65mmL	D-22	320
27406P	1/4" Hex Dr. 1/2" Dr. Spinner Handle(for Electric Drill), 65mmL	D-22	320
2747	5/16" Hex Shank, 7mm Hex Screwdriver Bit, 160mmL	D-5	500
2748	5/16" Hex Shank, 8mm Hex Screwdriver Bit, 160mmL	D-5	500
2749	9mm Hex Shank, 9mm Hex Screwdriver Bit, 160mmL	D-5	700
2750	10mm Hex Shank, 10mm Hex Screwdriver Bit, 160mmL	D-5	700
275003	1/4" Hex Shank, 3/32" Hex Power Screwdriver Bit, 50mmL	D-19	100
275004	1/4" Hex Shank, 1/8" Hex Power Screwdriver Bit, 50mmL	D-19	100
275005	1/4" Hex Shank, 5/32" Hex Power Screwdriver Bit, 50mmL	D-19	100
275006	1/4" Hex Shank, 3/16" Hex Power Screwdriver Bit, 50mmL	D-19	100
275007	1/4" Hex Shank, 7/32" Hex Power Screwdriver Bit, 50mmL	D-19	100
275008	1/4" Hex Shank, 1/4" Hex Power Screwdriver Bit, 50mmL	D-19	100
2751	11mm Hex Shank, 11mm Hex Screwdriver Bit, 160mmL	D-5	880
2752	12mm Hex Shank, 12mm Hex Screwdriver Bit, 160mmL	D-5	880
275206	1/4" Dr. 3/16" Deep Hand Socket (12-Point)	B-3	260
275207	1/4" Dr. 7/32" Deep Hand Socket (12-Point)	B-3	260
275208	1/4" Dr. 1/4" Deep Hand Socket (12-Point)	B-3	260
275209	1/4" Dr. 9/32" Deep Hand Socket (12-Point)	B-3	260
275210	1/4" Dr. 5/16" Deep Hand Socket (12-Point)	B-3	260
275211	1/4" Dr. 11/32" Deep Hand Socket (12-Point)	B-3	260
275212	1/4" Dr. 3/8" Deep Hand Socket (12-Point)	B-3	260
275214	1/4" Dr. 7/16" Deep Hand Socket (12-Point)	B-3	260
275216	1/4" Dr. 1/2" Deep Hand Socket (12-Point)	B-3	260
275218	1/4" Dr. 9/16" Deep Hand Socket (12-Point)	B-3	260
2753	13mm Hex Shank, 13mm Hex Screwdriver Bit, 160mmL	D-5	1050
2754	14mm Hex Shank, 14mm Hex Screwdriver Bit, 160mmL	D-5	1050
2756	16mm Hex Shank, 16mm Hex Screwdriver Bit, 160mmL	D-5	1230
2757	17mm Hex Shank, 17mm Hex Screwdriver Bit, 160mmL	D-5	1340
2759	19mm Hex Shank, 19mm Hex Screwdriver Bit, 160mmL	D-5	1520
277201	5/16" Hex Shank, PZ.1 Posidriv Power Screwdriver Bit, 72mmL	D-18	220
277202	5/16" Hex Shank, PZ.2 Posidriv Power Screwdriver Bit, 72mmL	D-18	220
277203	5/16" Hex Shank, PZ.3 Posidriv Power Screwdriver Bit, 72mmL	D-18	220
277204	5/16" Hex Shank, PZ.4 Posidriv Power Screwdriver Bit, 72mmL	D-18	220
280002B	1/4" Dr. 1/4" Hex Dr. Socket Holder Adapter	D-24	100
280005N	1/4" Dr. Torque Screwdrivers, 1 ~ 5 Nm	D-39	11000
280020	1/4" Dr. Sliding T-Handle	B-7	550
280030	1/4" Dr. Adapter 1/4" F x 3/8" M	B-7	210
280030N	1/4" Dr. Torque Wrench, 6 ~ 30 Nm	F-36	10200
280045L	1/4" Dr. Torque Screwdrivers, 9 ~ 50 in. lbs.	D-39	11000
280060	1/4" Hex Shank Magnetic Bit Holder With Handle	D-24	540
280070	1/4" Dr. Universal Joint	B-7	360
280120	OMNIDRIVER 3 in 1 Handgrip, 120mmL	D-23	990
280121M	OMNIDRIVER 4 in 1 Handgrip, 120mmL	D-23	1100
280150	1/4" Hex Shank Bit Holder With Handle	D-24	700
280222R	1/4" Dr. Reversible Ratchet	B-5	1690
280226	1/4" Dr. Hinge Handle	B-6	1000
280226A	1/4" Dr. Hinge Handle	B-6	1000
280226P	1/4" Dr. Hinge Handle	B-6	1100
280226S	1/4" Dr. Hinge Handle	B-6	1200
280231P	1/4" Dr. 36 Teeth Ratchet w/ Quick Release	B-5	2700

Item No.	Description	Pg.	Code
280231R	1/4" Dr. 36 Teeth Ratchet w/ Quick Release	B-5	2600
280231S	1/4" Dr. 36 Teeth Ratchet w/ Quick Release	B-5	2800
280250L	1/4" Dr. Torque Wrench, 40 ~ 250 in. lbs.	F-36	10200
280272	1/4" Dr. 72 Teeth Reversible Ratchet	B-5	1850
280272P	1/4" Dr. 72 Teeth Reversible Ratchet	B-5	1950
280272S	1/4" Dr. 72 Teeth Reversible Ratchet	B-5	2050
281802	1/4" Dr. 72 Teeth Rotor Ratchet	B-6	3220
281802P	1/4" Dr. 72 Teeth Rotor Ratchet	B-6	3320
281802S	1/4" Dr. 72 Teeth Rotor Ratchet	B-6	3420
282150	1/4" Dr. 1/4" Square Dr. Flexible Extension, 150mmL	D-25	440
282165	1/4" Hex Shank 1/4" Dr. Flexible Bit Holder, 165mmL	D-25	380
282262	1/4" Dr. 72 Teeth Flex Head Ratchet	B-6	2000
282262P	1/4" Dr. 72 Teeth Flex Head Ratchet	B-6	2100
282262S	1/4" Dr. 72 Teeth Flex Head Ratchet	B-6	2200
282408	1/4" Dr. 1/4" Hex Shank Bit Holder, 25mmL	B-7	475
282504	1/4" Dr. 1/8" Hand Socket	B-2	140
282506	1/4" Dr. 3/16" Hand Socket	B-2	140
282507	1/4" Dr. 7/32" Hand Socket	B-2	140
282508	1/4" Dr. 1/4" Hand Socket	B-2	140
282509	1/4" Dr. 9/32" Hand Socket	B-2	140
282510	1/4" Dr. 5/16" Hand Socket	B-2	140
282511	1/4" Dr. 11/32" Hand Socket	B-2	140
282512	1/4" Dr. 3/8" Hand Socket	B-2	140
282514	1/4" Dr. 7/16" Hand Socket	B-2	140
282516	1/4" Dr. 1/2" Hand Socket	B-2	140
282518	1/4" Dr. 9/16" Hand Socket	B-2	140
2833	1/4" Hex Shank, 3mm Hex Screwdriver Bit, 200mmL	D-5	450
2834	1/4" Hex Shank, 4mm Hex Screwdriver Bit, 200mmL	D-5	450
2835	1/4" Hex Shank, 5mm Hex Screwdriver Bit, 200mmL	D-5	450
283508	1/4" Dr. 1/4" Hex Shank Bit Holder(quick change), 35mmL	B-7	475
283510	1/4" Dr. 5/16" Hex Shank Bit Holder(quick change), 35mmL	B-7	495
2836	1/4" Hex Shank, 6mm Hex Screwdriver Bit, 200mmL	D-5	450
2847	5/16" Hex Shank, 7mm Hex Screwdriver Bit, 200mmL	D-5	600
2848	5/16" Hex Shank, 8mm Hex Screwdriver Bit, 200mmL	D-5	600
2849	9mm Hex Shank, 9mm Hex Screwdriver Bit, 200mmL	D-5	800
2850	10mm Hex Shank, 10mm Hex Screwdriver Bit, 200mmL	D-5	800
285008	1/4" Hex Shank, T-8 Star Power Screwdriver Bit, 50mmL	D-19	100
285010	1/4" Hex Shank, T-10 Star Power Screwdriver Bit, 50mmL	D-19	100
285015	1/4" Hex Shank, T-15 Star Power Screwdriver Bit, 50mmL	D-19	100
285020	1/4" Hex Shank, T-20 Star Power Screwdriver Bit, 50mmL	D-19	100
285025	1/4" Hex Shank, T-25 Star Power Screwdriver Bit, 50mmL	D-19	100
285027	1/4" Hex Shank, T-27 Star Power Screwdriver Bit, 50mmL	D-19	100
285030	1/4" Hex Shank, T-30 Star Power Screwdriver Bit, 50mmL	D-19	100
285040	1/4" Hex Shank, T-40 Star Power Screwdriver Bit, 50mmL	D-19	100
2851	11mm Hex Shank, 11mm Hex Screwdriver Bit, 200mmL	D-5	1000
2852	12mm Hex Shank, 12mm Hex Screwdriver Bit, 200mmL	D-5	1000
285206	1/4" Dr. 3/16" Deep Hand Socket	B-2	260
285207	1/4" Dr. 7/32" Deep Hand Socket	B-2	260
285208	1/4" Dr. 1/4" Deep Hand Socket	B-2	260
285209	1/4" Dr. 9/32" Deep Hand Socket	B-2	260
285210	1/4" Dr. 5/16" Deep Hand Socket	B-2	260
285211	1/4" Dr. 11/32" Deep Hand Socket	B-2	260
285212	1/4" Dr. 3/8" Deep Hand Socket	B-2	260
285214	1/4" Dr. 7/16" Deep Hand Socket	B-2	260
285216	1/4" Dr. 1/2" Deep Hand Socket	B-2	260
285218	1/4" Dr. 9/16" Deep Hand Socket	B-2	260
2853	13mm Hex Shank, 13mm Hex Screwdriver Bit, 200mmL	D-5	1200
2854	14mm Hex Shank, 14mm Hex Screwdriver Bit, 200mmL	D-5	1200
2856	16mm Hex Shank, 16mm Hex Screwdriver Bit, 200mmL	D-5	1400
285608	1/4" Hex Shank 1/4" Hex Dr. Bit Holder Adapter	D-24	220
2857	17mm Hex Shank, 17mm Hex Screwdriver Bit, 200mmL	D-5	1520
285708	1/4" Hex Shank 1/4" Hex Dr. Magnetic Bit Holder Adapter	D-24	580
285708M	1/4" Hex Shank 1/4" Hex Dr. Magnetic Bit Holder Adapter	D-24	580
2859	19mm Hex Shank, 19mm Hex Screwdriver Bit, 200mmL	D-5	1720
286008	1/4" Hex Shank 1/4" Hex Dr. Magnetic Bit Holder Adapter	D-24	320
286008M	1/4" Hex Shank 1/4" Hex Dr. Magnetic Bit Holder Adapter	D-24	320
290030	1/4" Dr. Impact Adapter, 1/4" F x 3/8" M	A-3	230
2914	19mm Hex Shank, 14mm Hex Impact Screwdriver Bit, 45mmL	D-20	700
2916	19mm Hex Shank, 16mm Hex Impact Screwdriver Bit, 45mmL	D-20	700
2917	19mm Hex Shank, 17mm Hex Impact Screwdriver Bit, 45mmL	D-20	700

Item No.	Description	Pg.	Code	Item No.	Description	Pg.	Code
2918	19mm Hex Shank, 18mm Hex Impact Screwdriver Bit, 45mmL D-20	700		308+1103	1/4" Dr. PH.3 Philips Bit Socket, 50mmL	C-23	285
2919	19mm Hex Shank, 19mm Hex Impact Screwdriver Bit, 45mmL D-20	700		308+1140	1/4" Dr. 0.6 x 4.0mm Slotted Bit Socket, 50mmL	C-23	285
2922	22mm Hex Shank, 22mm Hex Impact Screwdriver Bit, 50mmL D-20	800		308+1150	1/4" Dr. 0.8 x 5.0mm Slotted Bit Socket, 50mmL	C-23	285
2924	22mm Hex Shank, 24mm Hex Impact Screwdriver Bit, 50mmL D-20	950		308+1160	1/4" Dr. 1.0 x 6.0mm Slotted Bit Socket, 50mmL	C-23	285
292504	1/4" Dr. 1/8" Impact Socket	A-2	190	308+1501	1/4" Dr. PH.1 Philips Bit Socket, 110mmL	C-23	490
292506	1/4" Dr. 3/16" Impact Socket	A-2	190	308+1502	1/4" Dr. PH.2 Philips Bit Socket, 110mmL	C-23	490
292507	1/4" Dr. 7/32" Impact Socket	A-2	190	308+1503	1/4" Dr. PH.3 Philips Bit Socket, 110mmL	C-23	490
292508	1/4" Dr. 1/4" Impact Socket	A-2	190	308+1540	1/4" Dr. 0.8 x 4.0mm Slotted Bit Socket, 110mmL	C-23	490
292509	1/4" Dr. 9/32" Impact Socket	A-2	190	308+1550	1/4" Dr. 0.8 x 5.0mm Slotted Bit Socket, 110mmL	C-23	490
292510	1/4" Dr. 5/16" Impact Socket	A-2	190	308+1560	1/4" Dr. 1.0 x 6.0mm Slotted Bit Socket, 110mmL	C-23	490
292511	1/4" Dr. 11/32" Impact Socket	A-2	190	308+1601	1/4" Dr. PH.1 Philips Bit Socket, 140mmL	C-23	530
292512	1/4" Dr. 3/8" Impact Socket	A-2	190	308+1602	1/4" Dr. PH.2 Philips Bit Socket, 140mmL	C-23	530
292514	1/4" Dr. 7/16" Impact Socket	A-2	190	308+1603	1/4" Dr. PH.3 Philips Bit Socket, 140mmL	C-23	530
292516	1/4" Dr. 1/2" Impact Socket	A-2	190	308+1640	1/4" Dr. 0.6 x 4.0mm Slotted Bit Socket, 140mmL	C-23	530
292518	1/4" Dr. 9/16" Impact Socket	A-2	190	308+1650	1/4" Dr. 0.8 x 5.0mm Slotted Bit Socket, 140mmL	C-23	530
2927	27mm Hex Shank, 27mm Hex Impact Screwdriver Bit, 55mmL D-20	1100		308+1660	1/4" Dr. 1.0 x 6.0mm Slotted Bit Socket, 140mmL	C-23	530
2930	27mm Hex Shank, 30mm Hex Impact Screwdriver Bit, 55mmL D-20	1300		308+1701	1/4" Dr. PH.1 Philips Bit Socket, 180mmL	C-23	610
2932	27mm Hex Shank, 32mm Hex Impact Screwdriver Bit, 55mmL D-20	1500		308+1702	1/4" Dr. PH.2 Philips Bit Socket, 180mmL	C-23	610
2933	32mm Hex Shank, 33mm Hex Impact Screwdriver Bit, 60mmL D-20	1650		308+1703	1/4" Dr. PH.3 Philips Bit Socket, 180mmL	C-23	610
2936	32mm Hex Shank, 36mm Hex Impact Screwdriver Bit, 60mmL D-20	1800		308+1740	1/4" Dr. 0.6 x 4.0mm Slotted Bit Socket, 180mmL	C-23	610
295206	1/4" Dr. 3/16" Deep Impact Socket	A-3	305	308+1750	1/4" Dr. 0.8 x 5.0mm Slotted Bit Socket, 180mmL	C-23	610
295207	1/4" Dr. 7/32" Deep Impact Socket	A-3	305	308+1760	1/4" Dr. 1.0 x 6.0mm Slotted Bit Socket, 180mmL	C-23	610
295208	1/4" Dr. 1/4" Deep Impact Socket	A-3	305	308+1801	1/4" Dr. PH.1 Philips Bit Socket, 220mmL	C-23	680
295209	1/4" Dr. 9/32" Deep Impact Socket	A-3	305	308+1802	1/4" Dr. PH.2 Philips Bit Socket, 220mmL	C-23	680
295210	1/4" Dr. 5/16" Deep Impact Socket	A-3	305	308+1803	1/4" Dr. PH.3 Philips Bit Socket, 220mmL	C-23	680
295211	1/4" Dr. 11/32" Deep Impact Socket	A-3	305	308+1840	1/4" Dr. 0.6 x 4.0mm Slotted Bit Socket, 220mmL	C-23	680
295212	1/4" Dr. 3/8" Deep Impact Socket	A-3	305	308+1850	1/4" Dr. 0.8 x 5.0mm Slotted Bit Socket, 220mmL	C-23	680
295214	1/4" Dr. 7/16" Deep Impact Socket	A-3	305	308+1860	1/4" Dr. 1.0 x 6.0mm Slotted Bit Socket, 220mmL	C-23	680
295216	1/4" Dr. 1/2" Deep Impact Socket	A-3	305	308+2133	3/8" Dr. 3mm Hex Bit Socket, 50mmL	C-24	285
295218	1/4" Dr. 9/16" Deep Impact Socket	A-3	305	308+2134	3/8" Dr. 4mm Hex Bit Socket, 50mmL	C-24	285
297204	5/16" Hex Shank, 1/8" Hex Power Screwdriver Bit, 72mmL D-19	220		308+2135	3/8" Dr. 5mm Hex Bit Socket, 50mmL	C-24	285
297205	5/16" Hex Shank, 5/32" Hex Power Screwdriver Bit, 72mmL D-19	220		308+2136	3/8" Dr. 6mm Hex Bit Socket, 50mmL	C-24	285
297206	5/16" Hex Shank, 3/16" Hex Power Screwdriver Bit, 72mmL D-19	220		308+2533	3/8" Dr. 3mm Hex Bit Socket, 110mmL	C-24	490
297207	5/16" Hex Shank, 7/32" Hex Power Screwdriver Bit, 72mmL D-19	220		308+2534	3/8" Dr. 4mm Hex Bit Socket, 110mmL	C-24	490
297208	5/16" Hex Shank, 1/4" Hex Power Screwdriver Bit, 72mmL D-19	220		308+2535	3/8" Dr. 5mm Hex Bit Socket, 110mmL	C-24	490
297209	5/16" Hex Shank, 9/32" Hex Power Screwdriver Bit, 72mmL D-19	220		308+2536	3/8" Dr. 6mm Hex Bit Socket, 110mmL	C-24	490
297210	5/16" Hex Shank, 5/16" Hex Power Screwdriver Bit, 72mmL D-19	220		308+2633	3/8" Dr. 3mm Hex Bit Socket, 140mmL	C-24	530
297230	5/16" Hex Shank, 3mm Hex Power Screwdriver Bit, 72mmL D-19	220		308+2634	3/8" Dr. 4mm Hex Bit Socket, 140mmL	C-24	530
297240	5/16" Hex Shank, 4mm Hex Power Screwdriver Bit, 72mmL D-19	220		308+2635	3/8" Dr. 5mm Hex Bit Socket, 140mmL	C-24	530
297250	5/16" Hex Shank, 5mm Hex Power Screwdriver Bit, 72mmL D-19	220		308+2636	3/8" Dr. 6mm Hex Bit Socket, 140mmL	C-24	530
297260	5/16" Hex Shank, 6mm Hex Power Screwdriver Bit, 72mmL D-19	220		308+2733	3/8" Dr. 3mm Hex Bit Socket, 180mmL	C-24	610
297270	5/16" Hex Shank, 7mm Hex Power Screwdriver Bit, 72mmL D-19	220		308+2734	3/8" Dr. 4mm Hex Bit Socket, 180mmL	C-24	610
297280	5/16" Hex Shank, 8mm Hex Power Screwdriver Bit, 72mmL D-19	220		308+2735	3/8" Dr. 5mm Hex Bit Socket, 180mmL	C-24	610
				308+2736	3/8" Dr. 6mm Hex Bit Socket, 180mmL	C-24	610
				308+2836	3/8" Dr. 6mm Hex Bit Socket, 220mmL	C-24	680
				308+3108	3/8" Dr. 1/8" Hex Bit Socket, 50mmL	C-25	285
				308+3110	3/8" Dr. 5/32" Hex Bit Socket, 50mmL	C-25	285
				308+3112	3/8" Dr. 3/16" Hex Bit Socket, 50mmL	C-25	285
				308+3114	3/8" Dr. 7/32" Hex Bit Socket, 50mmL	C-25	285
				308+3116	3/8" Dr. 1/4" Hex Bit Socket, 50mmL	C-25	285
				308+3508	3/8" Dr. 1/8" Hex Bit Socket, 110mmL	C-25	490
				308+3510	3/8" Dr. 5/32" Hex Bit Socket, 110mmL	C-25	490
				308+3512	3/8" Dr. 3/16" Hex Bit Socket, 110mmL	C-25	490
				308+3514	3/8" Dr. 7/32" Hex Bit Socket, 110mmL	C-25	490
				308+3516	3/8" Dr. 1/4" Hex Bit Socket, 110mmL	C-25	490
				308+3608	3/8" Dr. 1/8" Hex Bit Socket, 140mmL	C-25	530
				308+3610	3/8" Dr. 5/32" Hex Bit Socket, 140mmL	C-25	530
				308+3612	3/8" Dr. 3/16" Hex Bit Socket, 140mmL	C-25	530
				308+3614	3/8" Dr. 7/32" Hex Bit Socket, 140mmL	C-25	530
				308+3616	3/8" Dr. 1/4" Hex Bit Socket, 140mmL	C-25	530
				308+3708	3/8" Dr. 1/8" Hex Bit Socket, 180mmL	C-25	610
				308+3710	3/8" Dr. 5/32" Hex Bit Socket, 180mmL	C-25	610
				308+3712	3/8" Dr. 3/16" Hex Bit Socket, 180mmL	C-25	610
				308+3714	3/8" Dr. 7/32" Hex Bit Socket, 180mmL	C-25	610
				308+3716	3/8" Dr. 1/4" Hex Bit Socket, 180mmL	C-25	610
				308+3816	3/8" Dr. 1/4" Hex Bit Socket, 220mmL	C-25	680
				308+4133	3/8" Dr. 3mm Wobble Hex Bit Socket, 50mmL	C-26	315
				308+4134	3/8" Dr. 4mm Wobble Hex Bit Socket, 50mmL	C-26	315
				308+4135	3/8" Dr. 5mm Wobble Hex Bit Socket, 50mmL	C-26	315
				308+4136	3/8" Dr. 6mm Wobble Hex Bit Socket, 50mmL	C-26	315
<b>3</b>							
300200	3/8" Dr. Air Impact Wrench, 200ft. lbs. / 271 Nm	E-4	28900				
300300G	3/8" Dr. Air Impact Wrench, 160 ft. lbs. / 217 Nm	E-3	21000				
300350	3/8" Dr. Air Impact Wrench, 350 ft. lbs. / 471 Nm	E-4	32000				
300450	3/8" Dr. Air Impact Wrench, 450 ft. lbs. / 610 Nm	E-3	26740				
3027	41mm Hex Shank, 27mm Hex Impact Screwdriver Bit, 60mmL D-20	1900					
3030	41mm Hex Shank, 30mm Hex Impact Screwdriver Bit, 60mmL D-20	1900					
3032	41mm Hex Shank, 32mm Hex Impact Screwdriver Bit, 60mmL D-20	1900					
3036	41mm Hex Shank, 36mm Hex Impact Screwdriver Bit, 60mmL D-20	1900					
3038	41mm Hex Shank, 38mm Hex Impact Screwdriver Bit, 60mmL D-20	1900					
3041	41mm Hex Shank, 41mm Hex Impact Screwdriver Bit, 65mmL D-20	1900					
3046	41mm Hex Shank, 46mm Hex Impact Screwdriver Bit, 65mmL D-20	2370					
3050	41mm Hex Shank, 50mm Hex Impact Screwdriver Bit, 70mmL D-20	2770					
305052X	3/8" Dr. Air Ratchet Wrench, 50 ft. lbs. / 68 Nm	E-2	10000				
3055	41mm Hex Shank, 55mm Hex Impact Screwdriver Bit, 75mmL D-20	3240					
3060	41mm Hex Shank, 60mm Hex Impact Screwdriver Bit, 80mmL D-20	3820					
306100	3/8" Dr. M6 x 1.00mm Stud Bolt Socket	J-19	500				
308+	3/8" Dr. 1/4" Hex Shank Bit Holder, 28mmL	D-21	260				
308+1101	1/4" Dr. PH.1 Philips Bit Socket, 50mmL	C-23	285				
308+1102	1/4" Dr. PH.2 Philips Bit Socket, 50mmL	C-23	285				



Item No.	Description	Pg.	Code	Item No.	Description	Pg.	Code
308+9004	3/8" Dr. M4 Ribe Bit Socket, 50mmL	C-32	310	310+5818	3/8" Dr. 9/32" Wobble Hex Bit Socket, 220mmL	C-27	890
308+9005	3/8" Dr. M5 Ribe Bit Socket, 50mmL	C-32	310	310+5820	3/8" Dr. 5/16" Wobble Hex Bit Socket, 220mmL	C-27	890
308+9006	3/8" Dr. M6 Ribe Bit Socket, 50mmL	C-32	310	310+6245	3/8" Dr. T-45 Star Bit Socket, 50mmL	C-28	325
308+9204	3/8" Dr. M4 Ribe Bit Socket, 76mmL	C-32	380	310+6250	3/8" Dr. T-50 Star Bit Socket, 50mmL	C-28	325
308+9205	3/8" Dr. M5 Ribe Bit Socket, 76mmL	C-32	380	310+6545	3/8" Dr. T-45 Star Bit Socket, 110mmL	C-28	530
308+9206	3/8" Dr. M6 Ribe Bit Socket, 76mmL	C-32	380	310+6550	3/8" Dr. T-50 Star Bit Socket, 110mmL	C-28	530
308+9404	3/8" Dr. M4 Ribe Bit Socket, 110mmL	C-32	550	310+6645	3/8" Dr. T-45 Star Bit Socket, 140mmL	C-28	630
308+9405	3/8" Dr. M5 Ribe Bit Socket, 110mmL	C-32	550	310+6650	3/8" Dr. T-50 Star Bit Socket, 140mmL	C-28	630
308+9406	3/8" Dr. M6 Ribe Bit Socket, 110mmL	C-32	550	310+6745	3/8" Dr. T-45 Star Bit Socket, 180mmL	C-28	730
308125	3/8" Dr. M8 x 1.25mm Stud Bolt Socket	J-19	500	310+6750	3/8" Dr. T-50 Star Bit Socket, 180mmL	C-28	730
310+	3/8" Dr. 5/16" Hex Shank Bit Holder, 30mmL	D-21	260	310+6845	3/8" Dr. T-45 Star Bit Socket, 220mmL	C-28	830
310+1124	1/4" Dr. PH.4 Philips Bit Socket, 50mmL	C-23	325	310+6850	3/8" Dr. T-50 Star Bit Socket, 220mmL	C-28	830
310+1280	1/4" Dr. 1.2 x 8.0mm Slotted Bit Socket, 50mmL	C-23	325	310+7145	3/8" Dr. T-45 Tamperproof Star Bit Socket, 50mmL	C-29	355
310+1290	1/4" Dr. 1.6 x 9.0mm Slotted Bit Socket, 50mmL	C-23	325	310+7150	3/8" Dr. T-50 Tamperproof Star Bit Socket, 50mmL	C-29	355
310+1504	1/4" Dr. PH.4 Philips Bit Socket, 110mmL	C-23	530	310+7545	3/8" Dr. T-45 Tamperproof Star Bit Socket, 110mmL	C-29	570
310+1580	1/4" Dr. 1.2 x 8.0mm Slotted Bit Socket, 110mmL	C-23	530	310+7550	3/8" Dr. T-50 Tamperproof Star Bit Socket, 110mmL	C-29	570
310+1590	1/4" Dr. 1.6 x 9.0mm Slotted Bit Socket, 110mmL	C-23	530	310+7645	3/8" Dr. T-45 Tamperproof Star Bit Socket, 140mmL	C-29	680
310+1604	1/4" Dr. PH.4 Philips Bit Socket, 140mmL	C-23	630	310+7650	3/8" Dr. T-50 Tamperproof Star Bit Socket, 140mmL	C-29	680
310+1680	1/4" Dr. 1.2 x 8.0mm Slotted Bit Socket, 140mmL	C-23	630	310+7745	3/8" Dr. T-45 Tamperproof Star Bit Socket, 180mmL	C-29	790
310+1690	1/4" Dr. 1.6 x 9.0mm Slotted Bit Socket, 140mmL	C-23	630	310+7750	3/8" Dr. T-50 Tamperproof Star Bit Socket, 180mmL	C-29	790
310+1704	1/4" Dr. PH.4 Philips Bit Socket, 180mmL	C-23	730	310+7845	3/8" Dr. T-45 Tamperproof Star Bit Socket, 220mmL	C-29	890
310+1780	1/4" Dr. 1.2 x 8.0mm Slotted Bit Socket, 180mmL	C-23	730	310+7850	3/8" Dr. T-50 Tamperproof Star Bit Socket, 220mmL	C-29	890
310+1790	1/4" Dr. 1.6 x 9.0mm Slotted Bit Socket, 180mmL	C-23	730	310+8108	3/8" Dr. M8 Triple Square Bit Socket, 50mmL	C-30	325
310+1804	1/4" Dr. PH.4 Philips Bit Socket, 220mmL	C-23	830	310+8508	3/8" Dr. M8 Triple Square Bit Socket, 110mmL	C-30	530
310+1880	1/4" Dr. 1.2 x 8.0mm Slotted Bit Socket, 220mmL	C-23	830	310+8608	3/8" Dr. M8 Triple Square Bit Socket, 140mmL	C-30	630
310+1890	1/4" Dr. 1.6 x 9.0mm Slotted Bit Socket, 220mmL	C-23	830	310+8708	3/8" Dr. M8 Triple Square Bit Socket, 180mmL	C-30	730
310+2147	3/8" Dr. 7mm Hex Bit Socket, 50mmL	C-24	325	310+8808	3/8" Dr. M8 Triple Square Bit Socket, 220mmL	C-30	830
310+2148	3/8" Dr. 8mm Hex Bit Socket, 50mmL	C-24	325	310+9007	3/8" Dr. M7 Ribe Bit Socket, 50mmL	C-32	350
310+2547	3/8" Dr. 7mm Hex Bit Socket, 110mmL	C-24	530	310+9008	3/8" Dr. M8 Ribe Bit Socket, 50mmL	C-32	350
310+2548	3/8" Dr. 8mm Hex Bit Socket, 110mmL	C-24	530	310+9207	3/8" Dr. M7 Ribe Bit Socket, 76mmL	C-32	430
310+2647	3/8" Dr. 7mm Hex Bit Socket, 140mmL	C-24	630	310+9208	3/8" Dr. M8 Ribe Bit Socket, 76mmL	C-32	430
310+2648	3/8" Dr. 8mm Hex Bit Socket, 140mmL	C-24	630	310+9407	3/8" Dr. M7 Ribe Bit Socket, 110mmL	C-32	590
310+2747	3/8" Dr. 7mm Hex Bit Socket, 180mmL	C-24	730	310+9408	3/8" Dr. M8 Ribe Bit Socket, 110mmL	C-32	590
310+2748	3/8" Dr. 8mm Hex Bit Socket, 180mmL	C-24	730	310125	3/8" Dr. M10 x 1.25mm Stud Bolt Socket	J-19	500
310+2847	3/8" Dr. 7mm Hex Bit Socket, 220mmL	C-24	830	310150	3/8" Dr. M10 x 1.50mm Stud Bolt Socket	J-19	500
310+2848	3/8" Dr. 8mm Hex Bit Socket, 220mmL	C-24	830	3104	1/4" Hex Shank, 1/16" Hex Screwdriver Bit, 30mmL	D-6	55
310+3128	3/8" Dr. 9/32" Hex Bit Socket, 50mmL	C-25	325	3105	1/4" Hex Shank, 5/64" Hex Screwdriver Bit, 30mmL	D-6	55
310+3130	3/8" Dr. 5/16" Hex Bit Socket, 50mmL	C-25	325	3106	1/4" Hex Shank, 3/32" Hex Screwdriver Bit, 30mmL	D-6	55
310+3518	3/8" Dr. 9/32" Hex Bit Socket, 110mmL	C-25	530	3107	1/4" Hex Shank, 7/64" Hex Screwdriver Bit, 30mmL	D-6	55
310+3520	3/8" Dr. 5/16" Hex Bit Socket, 110mmL	C-25	530	3108	1/4" Hex Shank, 1/8" Hex Screwdriver Bit, 30mmL	D-6	55
310+3618	3/8" Dr. 9/32" Hex Bit Socket, 140mmL	C-25	630	3110	1/4" Hex Shank, 5/32" Hex Screwdriver Bit, 30mmL	D-6	55
310+3620	3/8" Dr. 5/16" Hex Bit Socket, 140mmL	C-25	630	3112	1/4" Hex Shank, 3/16" Hex Screwdriver Bit, 30mmL	D-6	55
310+3718	3/8" Dr. 9/32" Hex Bit Socket, 180mmL	C-25	730	3114	1/4" Hex Shank, 7/32" Hex Screwdriver Bit, 30mmL	D-6	55
310+3720	3/8" Dr. 5/16" Hex Bit Socket, 180mmL	C-25	730	3116	1/4" Hex Shank, 1/4" Hex Screwdriver Bit, 30mmL	D-6	55
310+3818	3/8" Dr. 9/32" Hex Bit Socket, 220mmL	C-25	830	3118	5/16" Hex Shank, 1/8" Hex Screwdriver Bit, 30mmL	D-6	92
310+3820	3/8" Dr. 5/16" Hex Bit Socket, 220mmL	C-25	830	312+	3/8" Dr. 3/8" Hex Shank Bit Holder, 30mmL	D-21	300
310+4147	3/8" Dr. 7mm Wobble Hex Bit Socket, 50mmL	C-26	355	312+3134	3/8" Dr. 3/8" Hex Bit Socket, 50mmL	C-25	420
310+4148	3/8" Dr. 8mm Wobble Hex Bit Socket, 50mmL	C-26	355	312+3524	3/8" Dr. 3/8" Hex Bit Socket, 110mmL	C-25	670
310+4547	3/8" Dr. 7mm Wobble Hex Bit Socket, 110mmL	C-26	570	312+3624	3/8" Dr. 3/8" Hex Bit Socket, 140mmL	C-25	870
310+4548	3/8" Dr. 8mm Wobble Hex Bit Socket, 110mmL	C-26	570	312+3724	3/8" Dr. 3/8" Hex Bit Socket, 180mmL	C-25	970
310+4647	3/8" Dr. 7mm Wobble Hex Bit Socket, 140mmL	C-26	680	312+3824	3/8" Dr. 3/8" Hex Bit Socket, 220mmL	C-25	1070
310+4648	3/8" Dr. 8mm Wobble Hex Bit Socket, 140mmL	C-26	680	312+5124	3/8" Dr. 3/8" Wobble Hex Bit Socket, 50mmL	C-27	450
310+4747	3/8" Dr. 7mm Wobble Hex Bit Socket, 180mmL	C-26	790	312+5524	3/8" Dr. 3/8" Wobble Hex Bit Socket, 110mmL	C-27	710
310+4748	3/8" Dr. 8mm Wobble Hex Bit Socket, 180mmL	C-26	790	312+5624	3/8" Dr. 3/8" Wobble Hex Bit Socket, 140mmL	C-27	920
310+4847	3/8" Dr. 7mm Wobble Hex Bit Socket, 220mmL	C-26	890	312+5724	3/8" Dr. 3/8" Wobble Hex Bit Socket, 180mmL	C-27	1030
310+4848	3/8" Dr. 8mm Wobble Hex Bit Socket, 220mmL	C-26	890	312+5824	3/8" Dr. 3/8" Wobble Hex Bit Socket, 220mmL	C-27	1130
310+5040	3/8" Dr. T-40 Pentacle Bit Socket, 50mmL	C-31	380	3120	5/16" Hex Shank, 5/32" Hex Screwdriver Bit, 30mmL	D-6	92
310+5045	3/8" Dr. T-45 Pentacle Bit Socket, 50mmL	C-31	380	3122	5/16" Hex Shank, 3/16" Hex Screwdriver Bit, 30mmL	D-6	92
310+5118	3/8" Dr. 9/32" Wobble Hex Bit Socket, 50mmL	C-27	355	3124	5/16" Hex Shank, 7/32" Hex Screwdriver Bit, 30mmL	D-6	92
310+5120	3/8" Dr. 5/16" Wobble Hex Bit Socket, 50mmL	C-27	355	3126	5/16" Hex Shank, 1/4" Hex Screwdriver Bit, 30mmL	D-6	92
310+5240	3/8" Dr. T-40 Pentacle Bit Socket, 76mmL	C-31	460	3128	5/16" Hex Shank, 9/32" Hex Screwdriver Bit, 30mmL	D-6	92
310+5245	3/8" Dr. T-45 Pentacle Bit Socket, 76mmL	C-31	460	3130	5/16" Hex Shank, 5/16" Hex Screwdriver Bit, 30mmL	D-6	92
310+5440	3/8" Dr. T-40 Pentacle Bit Socket, 110mmL	C-31	640	313006	3/8" Dr. 6mm Impact Socket	A-5	135
310+5445	3/8" Dr. T-45 Pentacle Bit Socket, 110mmL	C-31	640	313007	3/8" Dr. 7mm Impact Socket	A-5	135
310+5518	3/8" Dr. 9/32" Wobble Hex Bit Socket, 110mmL	C-27	570	313008	3/8" Dr. 8mm Impact Socket	A-5	135
310+5520	3/8" Dr. 5/16" Wobble Hex Bit Socket, 110mmL	C-27	570	313009	3/8" Dr. 9mm Impact Socket	A-5	135
310+5618	3/8" Dr. 9/32" Wobble Hex Bit Socket, 140mmL	C-27	680	313010	3/8" Dr. 10mm Impact Socket	A-5	135
310+5620	3/8" Dr. 5/16" Wobble Hex Bit Socket, 140mmL	C-27	680	313011	3/8" Dr. 11mm Impact Socket	A-5	135
310+5718	3/8" Dr. 9/32" Wobble Hex Bit Socket, 180mmL	C-27	790	313012	3/8" Dr. 12mm Impact Socket	A-5	135
310+5720	3/8" Dr. 5/16" Wobble Hex Bit Socket, 180mmL	C-27	790	313013	3/8" Dr. 13mm Impact Socket	A-5	135



Item No.	Description	Pg.	Code	Item No.	Description	Pg.	Code
313014	3/8" Dr. 14mm Impact Socket	A-5	135	323218	3/8" Dr. 18mm Hand Socket	B-20	285
313015	3/8" Dr. 15mm Impact Socket	A-5	155	323219	3/8" Dr. 19mm Hand Socket	B-20	305
313016	3/8" Dr. 16mm Impact Socket	A-5	170	323220	3/8" Dr. 20mm Hand Socket	B-20	335
313017	3/8" Dr. 17mm Impact Socket	A-5	190	323221	3/8" Dr. 21mm Hand Socket	B-20	390
313018	3/8" Dr. 18mm Impact Socket	A-5	210	323222	3/8" Dr. 22mm Hand Socket	B-20	450
313019	3/8" Dr. 19mm Impact Socket	A-5	230	323503T	3/8" Dr. T-Handle (Ball Joint), 350mmL	B-25	1500
313020	3/8" Dr. 20mm Impact Socket	A-5	265	323910	3/8" Dr. 10mm Hex Shank Bit Holder(quick change), 39mmL	B-25	520
313021	3/8" Dr. 21mm Impact Socket	A-5	300	324203	3/8" Dr. T-Handle (Quick Release), 420mmL	B-25	2000
313022	3/8" Dr. 22mm Impact Socket	A-5	385	324203U	3/8" Dr. T-Handle (Universal Joint), 420mmL	B-25	2000
3134	3/8" Hex Shank, 3/8" Hex Screwdriver Bit, 30mmL	D-6	150	325003T	3/8" Dr. T-Handle (Ball Joint), 500mmL	B-25	1700
3138	7/16" Hex Shank, 7/16" Hex Screwdriver Bit, 30mmL	D-6	195	326014	3/8" Dr. 14.0mm Spark Plug Socket	B-25	505
314+	3/8" Dr. 7/16" Hex Shank Bit Holder, 30mmL	D-21	300	326016	3/8" Dr. 16.0mm(5/8") Spark Plug Socket	B-25	505
314+3138	3/8" Dr. 7/16" Hex Bit Socket, 50mmL	C-25	465	326021	3/8" Dr. 20.6mm(13/16") Spark Plug Socket	B-25	590
314+3528	3/8" Dr. 7/16" Hex Bit Socket, 110mmL	C-25	810	326306	3/8" Dr. 6mm Deep Hand Socket	B-21	305
314+3628	3/8" Dr. 7/16" Hex Bit Socket, 140mmL	C-25	1020	326307	3/8" Dr. 7mm Deep Hand Socket	B-21	305
314+3728	3/8" Dr. 7/16" Hex Bit Socket, 180mmL	C-25	1150	326308	3/8" Dr. 8mm Deep Hand Socket	B-21	305
314+3828	3/8" Dr. 7/16" Hex Bit Socket, 220mmL	C-25	1270	326309	3/8" Dr. 9mm Deep Hand Socket	B-21	305
3142	1/2" Hex Shank, 1/2" Hex Screwdriver Bit, 30mmL	D-6	240	326310	3/8" Dr. 10mm Deep Hand Socket	B-21	305
316+	3/8" Dr. 1/2" Hex Shank Bit Holder, 30mmL	D-21	300	326311	3/8" Dr. 11mm Deep Hand Socket	B-21	305
316+3142	3/8" Dr. 1/2" Hex Bit Socket, 50mmL	C-25	510	326312	3/8" Dr. 12mm Deep Hand Socket	B-21	305
316+3532	3/8" Dr. 1/2" Hex Bit Socket, 110mmL	C-25	950	326313	3/8" Dr. 13mm Deep Hand Socket	B-21	305
316+3632	3/8" Dr. 1/2" Hex Bit Socket, 140mmL	C-25	1170	326314	3/8" Dr. 14mm Deep Hand Socket	B-21	305
316+3732	3/8" Dr. 1/2" Hex Bit Socket, 180mmL	C-25	1320	326315	3/8" Dr. 15mm Deep Hand Socket	B-21	330
316+3832	3/8" Dr. 1/2" Hex Bit Socket, 220mmL	C-25	1470	326316	3/8" Dr. 16mm Deep Hand Socket	B-21	350
316306	3/8" Dr. 6mm Deep Impact Socket	A-6	210	326317	3/8" Dr. 17mm Deep Hand Socket	B-21	375
316307	3/8" Dr. 7mm Deep Impact Socket	A-6	210	326318	3/8" Dr. 18mm Deep Hand Socket	B-21	395
316308	3/8" Dr. 8mm Deep Impact Socket	A-6	210	326319	3/8" Dr. 19mm Deep Hand Socket	B-21	415
316309	3/8" Dr. 9mm Deep Impact Socket	A-6	210	326320	3/8" Dr. 20mm Deep Hand Socket	B-21	450
316310	3/8" Dr. 10mm Deep Impact Socket	A-6	210	326321	3/8" Dr. 21mm Deep Hand Socket	B-21	475
316311	3/8" Dr. 11mm Deep Impact Socket	A-6	210	326322	3/8" Dr. 22mm Deep Hand Socket	B-21	550
316312	3/8" Dr. 12mm Deep Impact Socket	A-6	210	327003	3/8" Dr. T-Handle (Quick Release), 700mmL	B-25	2200
316313	3/8" Dr. 13mm Deep Impact Socket	A-6	210	327003U	3/8" Dr. T-Handle (Universal Joint), 700mmL	B-25	2200
316314	3/8" Dr. 14mm Deep Impact Socket	A-6	210	3304	1/4" Hex Shank, 1/16" Hex Screwdriver Bit, 56mmL	D-6	120
316315	3/8" Dr. 15mm Deep Impact Socket	A-6	250	3305	1/4" Hex Shank, 5/64" Hex Screwdriver Bit, 56mmL	D-6	120
316316	3/8" Dr. 16mm Deep Impact Socket	A-6	250	3306	1/4" Hex Shank, 3/32" Hex Screwdriver Bit, 56mmL	D-6	120
316317	3/8" Dr. 17mm Deep Impact Socket	A-6	275	3307	1/4" Hex Shank, 7/64" Hex Screwdriver Bit, 56mmL	D-6	120
316318	3/8" Dr. 18mm Deep Impact Socket	A-6	275	3308	1/4" Hex Shank, 1/8" Hex Screwdriver Bit, 56mmL	D-6	120
316319	3/8" Dr. 19mm Deep Impact Socket	A-6	300	3310	1/4" Hex Shank, 5/32" Hex Screwdriver Bit, 56mmL	D-6	120
316320	3/8" Dr. 20mm Deep Impact Socket	A-6	340	3312	1/4" Hex Shank, 3/16" Hex Screwdriver Bit, 56mmL	D-6	120
316321	3/8" Dr. 21mm Deep Impact Socket	A-6	360	3314	1/4" Hex Shank, 7/32" Hex Screwdriver Bit, 56mmL	D-6	120
316322	3/8" Dr. 22mm Deep Impact Socket	A-6	420	3316	1/4" Hex Shank, 1/4" Hex Screwdriver Bit, 56mmL	D-6	120
318516	3/8" Dr. 16.0mm(5/8") Swivel Spark Plug Socket	B-25	1500	3318	5/16" Hex Shank, 9/32" Hex Screwdriver Bit, 56mmL	D-6	160
318521	3/8" Dr. 20.6mm(13/16") Swivel Spark Plug Socket	B-25	1700	3320	5/16" Hex Shank, 5/16" Hex Screwdriver Bit, 56mmL	D-6	160
320002B	3/8" Dr. Wobble Extension Bar, 45mmL	B-24	430	3324	3/8" Hex Shank, 3/8" Hex Screwdriver Bit, 56mmL	D-6	220
320003B	3/8" Dr. Wobble Extension Bar, 75mmL	B-24	490	3328	7/16" Hex Shank, 7/16" Hex Screwdriver Bit, 56mmL	D-6	280
320006B	3/8" Dr. Wobble Extension Bar, 150mmL	B-24	650	3332	1/2" Hex Shank, 1/2" Hex Screwdriver Bit, 56mmL	D-6	310
320008B	3/8" Dr. Wobble Extension Bar, 200mmL	B-24	920	333206	3/8" Dr. 6mm Hand Socket (12-Point)	B-22	190
320012B	3/8" Dr. Wobble Extension Bar, 300mmL	B-24	1180	333207	3/8" Dr. 7mm Hand Socket (12-Point)	B-22	190
320018B	3/8" Dr. Wobble Extension Bar, 450mmL	B-24	1500	333208	3/8" Dr. 8mm Hand Socket (12-Point)	B-22	190
320020	3/8" Dr. Adapter 3/8" F x 1/4" M	B-24	215	333209	3/8" Dr. 9mm Hand Socket (12-Point)	B-22	190
320025	3/8" Dr. Extension Bar, 25mmL	B-24	210	333210	3/8" Dr. 10mm Hand Socket (12-Point)	B-22	190
320040	3/8" Dr. Adapter 3/8" F x 1/2" M	B-24	195	333211	3/8" Dr. 11mm Hand Socket (12-Point)	B-22	190
320045	3/8" Dr. Extension Bar, 45mmL	B-24	235	333212	3/8" Dr. 12mm Hand Socket (12-Point)	B-22	190
320075	3/8" Dr. Extension Bar, 75mmL	B-24	265	333213	3/8" Dr. 13mm Hand Socket (12-Point)	B-22	190
320150	3/8" Dr. Extension Bar, 150mmL	B-24	420	333214	3/8" Dr. 14mm Hand Socket (12-Point)	B-22	190
320160L	3/8" Dr. L-Handle	B-25	900	333215	3/8" Dr. 15mm Hand Socket (12-Point)	B-22	210
320200	3/8" Dr. Extension Bar, 200mmL	B-24	710	333216	3/8" Dr. 16mm Hand Socket (12-Point)	B-22	235
320250	3/8" Dr. Extension Bar, 250mmL	B-24	900	333217	3/8" Dr. 17mm Hand Socket (12-Point)	B-22	255
323206	3/8" Dr. 6mm Hand Socket	B-20	190	333218	3/8" Dr. 18mm Hand Socket (12-Point)	B-22	285
323207	3/8" Dr. 7mm Hand Socket	B-20	190	333219	3/8" Dr. 19mm Hand Socket (12-Point)	B-22	305
323208	3/8" Dr. 8mm Hand Socket	B-20	190	333220	3/8" Dr. 20mm Hand Socket (12-Point)	B-22	335
323209	3/8" Dr. 9mm Hand Socket	B-20	190	333221	3/8" Dr. 21mm Hand Socket (12-Point)	B-22	390
323210	3/8" Dr. 10mm Hand Socket	B-20	190	333222	3/8" Dr. 22mm Hand Socket (12-Point)	B-22	450
323211	3/8" Dr. 11mm Hand Socket	B-20	190	3336	9/16" Hex Shank, 9/16" Hex Screwdriver Bit, 56mmL	D-6	340
323212	3/8" Dr. 12mm Hand Socket	B-20	190	3340	5/8" Hex Shank, 5/8" Hex Screwdriver Bit, 56mmL	D-6	410
323213	3/8" Dr. 13mm Hand Socket	B-20	190	3344	11/16" Hex Shank, 11/16" Hex Screwdriver Bit, 56mmL	D-6	480
323214	3/8" Dr. 14mm Hand Socket	B-20	190	3348	3/4" Hex Shank, 3/4" Hex Screwdriver Bit, 56mmL	D-6	540
323215	3/8" Dr. 15mm Hand Socket	B-20	210	336306	3/8" Dr. 6mm Deep Hand Socket (12-Point)	B-23	305
323216	3/8" Dr. 16mm Hand Socket	B-20	235	336307	3/8" Dr. 7mm Deep Hand Socket (12-Point)	B-23	305
323217	3/8" Dr. 17mm Hand Socket	B-20	255	336308	3/8" Dr. 8mm Deep Hand Socket (12-Point)	B-23	305

Item No.	Description	Pg.	Code	Item No.	Description	Pg.	Code
336309	3/8" Dr. 9mm Deep Hand Socket (12-Point)	B-23	305	341+2151	3/8" Dr. 11mm Hex Bit Socket, 50mmL	C-24	465
336310	3/8" Dr. 10mm Deep Hand Socket (12-Point)	B-23	305	341+2551	3/8" Dr. 11mm Hex Bit Socket, 110mmL	C-24	810
336311	3/8" Dr. 11mm Deep Hand Socket (12-Point)	B-23	305	341+2651	3/8" Dr. 11mm Hex Bit Socket, 140mmL	C-24	1020
336312	3/8" Dr. 12mm Deep Hand Socket (12-Point)	B-23	305	341+2751	3/8" Dr. 11mm Hex Bit Socket, 180mmL	C-24	1150
336313	3/8" Dr. 13mm Deep Hand Socket (12-Point)	B-23	305	341+2851	3/8" Dr. 11mm Hex Bit Socket, 220mmL	C-24	1270
336314	3/8" Dr. 14mm Deep Hand Socket (12-Point)	B-23	305	342+	3/8" Dr. 12mm Hex Shank Bit Holder, 30mmL	D-21	300
336315	3/8" Dr. 15mm Deep Hand Socket (12-Point)	B-23	330	342+2152	3/8" Dr. 12mm Hex Bit Socket, 50mmL	C-24	465
336316	3/8" Dr. 16mm Deep Hand Socket (12-Point)	B-23	350	342+2552	3/8" Dr. 12mm Hex Bit Socket, 110mmL	C-24	810
336317	3/8" Dr. 17mm Deep Hand Socket (12-Point)	B-23	375	342+2652	3/8" Dr. 12mm Hex Bit Socket, 140mmL	C-24	1020
336318	3/8" Dr. 18mm Deep Hand Socket (12-Point)	B-23	395	342+2752	3/8" Dr. 12mm Hex Bit Socket, 180mmL	C-24	1150
336319	3/8" Dr. 19mm Deep Hand Socket (12-Point)	B-23	415	342+2852	3/8" Dr. 12mm Hex Bit Socket, 220mmL	C-24	1270
336320	3/8" Dr. 20mm Deep Hand Socket (12-Point)	B-23	450	342+5055	3/8" Dr. T-55 Pentacle Bit Socket, 50mmL	C-31	540
336321	3/8" Dr. 21mm Deep Hand Socket (12-Point)	B-23	475	342+5255	3/8" Dr. T-55 Pentacle Bit Socket, 76mmL	C-31	650
336322	3/8" Dr. 22mm Deep Hand Socket (12-Point)	B-23	550	342+5455	3/8" Dr. T-55 Pentacle Bit Socket, 110mmL	C-31	970
339+	3/8" Dr. 9mm Hex Shank Bit Holder, 30mmL	D-21	300	342+8112	3/8" Dr. M12 Triple Square Bit Socket, 50mmL	C-30	465
339+2149	3/8" Dr. 9mm Hex Bit Socket, 50mmL	C-24	420	342+8512	3/8" Dr. M12 Triple Square Bit Socket, 110mmL	C-30	810
339+2549	3/8" Dr. 9mm Hex Bit Socket, 110mmL	C-24	670	342+8612	3/8" Dr. M12 Triple Square Bit Socket, 140mmL	C-30	1020
339+2649	3/8" Dr. 9mm Hex Bit Socket, 140mmL	C-24	830	342+8712	3/8" Dr. M12 Triple Square Bit Socket, 180mmL	C-30	1150
339+2749	3/8" Dr. 9mm Hex Bit Socket, 180mmL	C-24	970	342+8812	3/8" Dr. M12 Triple Square Bit Socket, 220mmL	C-30	1270
339+2849	3/8" Dr. 9mm Hex Bit Socket, 220mmL	C-24	1070	342+9012	3/8" Dr. M12 Ribe Bit Socket, 50mmL	C-32	510
339+4149	3/8" Dr. 9mm Wobble Hex Bit Socket, 50mmL	C-26	450	342+9212	3/8" Dr. M12 Ribe Bit Socket, 76mmL	C-32	610
339+4549	3/8" Dr. 9mm Wobble Hex Bit Socket, 110mmL	C-26	710	342+9412	3/8" Dr. M12 Ribe Bit Socket, 110mmL	C-32	920
339+4649	3/8" Dr. 9mm Wobble Hex Bit Socket, 140mmL	C-26	920	343206	3/8" Dr. 6mm Impact Socket (CR-Mo)	A-12	210
339+4749	3/8" Dr. 9mm Wobble Hex Bit Socket, 180mmL	C-26	1030	343207	3/8" Dr. 7mm Impact Socket (CR-Mo)	A-12	210
339+4849	3/8" Dr. 9mm Wobble Hex Bit Socket, 220mmL	C-26	1130	343208	3/8" Dr. 8mm Impact Socket (CR-Mo)	A-12	210
340+	3/8" Dr. 10mm Hex Shank Bit Holder, 30mmL	D-21	300	343209	3/8" Dr. 9mm Impact Socket (CR-Mo)	A-12	210
340+2150	3/8" Dr. 10mm Hex Bit Socket, 50mmL	C-24	420	343210	3/8" Dr. 10mm Impact Socket (CR-Mo)	A-12	210
340+2550	3/8" Dr. 10mm Hex Bit Socket, 110mmL	C-24	670	343211	3/8" Dr. 11mm Impact Socket (CR-Mo)	A-12	210
340+2650	3/8" Dr. 10mm Hex Bit Socket, 140mmL	C-24	830	343212	3/8" Dr. 12mm Impact Socket (CR-Mo)	A-12	210
340+2750	3/8" Dr. 10mm Hex Bit Socket, 180mmL	C-24	970	343213	3/8" Dr. 13mm Impact Socket (CR-Mo)	A-12	210
340+2850	3/8" Dr. 10mm Hex Bit Socket, 220mmL	C-24	1070	343214	3/8" Dr. 14mm Impact Socket (CR-Mo)	A-12	210
340+4150	3/8" Dr. 10mm Wobble Hex Bit Socket, 50mmL	C-26	450	343215	3/8" Dr. 15mm Impact Socket (CR-Mo)	A-12	235
340+4550	3/8" Dr. 10mm Wobble Hex Bit Socket, 110mmL	C-26	710	343216	3/8" Dr. 16mm Impact Socket (CR-Mo)	A-12	255
340+4650	3/8" Dr. 10mm Wobble Hex Bit Socket, 140mmL	C-26	920	343217	3/8" Dr. 17mm Impact Socket (CR-Mo)	A-12	280
340+4750	3/8" Dr. 10mm Wobble Hex Bit Socket, 180mmL	C-26	1030	343218	3/8" Dr. 18mm Impact Socket (CR-Mo)	A-12	310
340+4850	3/8" Dr. 10mm Wobble Hex Bit Socket, 220mmL	C-26	1130	343219	3/8" Dr. 19mm Impact Socket (CR-Mo)	A-12	335
340+5050	3/8" Dr. T-50 Pentacle Bit Socket, 50mmL	C-31	490	343220	3/8" Dr. 20mm Impact Socket (CR-Mo)	A-12	365
340+5250	3/8" Dr. T-50 Pentacle Bit Socket, 76mmL	C-31	570	343221	3/8" Dr. 21mm Impact Socket (CR-Mo)	A-12	435
340+5450	3/8" Dr. T-50 Pentacle Bit Socket, 110mmL	C-31	800	343222	3/8" Dr. 22mm Impact Socket (CR-Mo)	A-12	495
340+6255	3/8" Dr. T-55 Star Bit Socket, 50mmL	C-28	420	344+	3/8" Dr. 14mm Hex Shank Bit Holder, 30mmL	D-21	340
340+6555	3/8" Dr. T-55 Star Bit Socket, 110mmL	C-28	670	344+8114	3/8" Dr. M14 Triple Square Bit Socket, 50mmL	C-30	510
340+6655	3/8" Dr. T-55 Star Bit Socket, 140mmL	C-28	870	344+8514	3/8" Dr. M14 Triple Square Bit Socket, 110mmL	C-30	950
340+6755	3/8" Dr. T-55 Star Bit Socket, 180mmL	C-28	970	344+8614	3/8" Dr. M14 Triple Square Bit Socket, 140mmL	C-30	1170
340+6855	3/8" Dr. T-55 Star Bit Socket, 220mmL	C-28	1070	344+8714	3/8" Dr. M14 Triple Square Bit Socket, 180mmL	C-30	1320
340+7155	3/8" Dr. T-55 Tamperproof Star Bit Socket, 50mmL	C-29	450	344+8814	3/8" Dr. M14 Triple Square Bit Socket, 220mmL	C-30	1470
340+7555	3/8" Dr. T-55 Tamperproof Star Bit Socket, 110mmL	C-29	710	344+9013	3/8" Dr. M13 Ribe Bit Socket, 50mmL	C-32	600
340+7655	3/8" Dr. T-55 Tamperproof Star Bit Socket, 140mmL	C-29	920	344+9014	3/8" Dr. M14 Ribe Bit Socket, 50mmL	C-32	600
340+7755	3/8" Dr. T-55 Tamperproof Star Bit Socket, 180mmL	C-29	1030	344+9213	3/8" Dr. M13 Ribe Bit Socket, 76mmL	C-32	720
340+7855	3/8" Dr. T-55 Tamperproof Star Bit Socket, 220mmL	C-29	1130	344+9214	3/8" Dr. M14 Ribe Bit Socket, 76mmL	C-32	720
340+8110	3/8" Dr. M10 Triple Square Bit Socket, 50mmL	C-30	420	344+9413	3/8" Dr. M13 Ribe Bit Socket, 110mmL	C-32	1130
340+8510	3/8" Dr. M10 Triple Square Bit Socket, 110mmL	C-30	670	344+9414	3/8" Dr. M14 Ribe Bit Socket, 110mmL	C-32	1130
340+8610	3/8" Dr. M10 Triple Square Bit Socket, 140mmL	C-30	870	345204	3/8" Dr. 4mm Hex Head Driver, 52mmL	C-4	445
340+8710	3/8" Dr. M10 Triple Square Bit Socket, 180mmL	C-30	970	345205	3/8" Dr. 5mm Hex Head Driver, 52mmL	C-4	445
340+8810	3/8" Dr. M10 Triple Square Bit Socket, 220mmL	C-30	1070	345206	3/8" Dr. 6mm Hex Head Driver, 52mmL	C-4	445
340+9009	3/8" Dr. M9 Ribe Bit Socket, 50mmL	C-32	450	345207	3/8" Dr. 7mm Hex Head Driver, 52mmL	C-4	465
340+9010	3/8" Dr. M10 Ribe Bit Socket, 50mmL	C-32	450	345208	3/8" Dr. 8mm Hex Head Driver, 52mmL	C-4	465
340+9209	3/8" Dr. M9 Ribe Bit Socket, 76mmL	C-32	540	345209	3/8" Dr. 9mm Hex Head Driver, 52mmL	C-4	465
340+9210	3/8" Dr. M10 Ribe Bit Socket, 76mmL	C-32	540	345210	3/8" Dr. 10mm Hex Head Driver, 52mmL	C-4	465
340+9409	3/8" Dr. M9 Ribe Bit Socket, 110mmL	C-32	750	345212	3/8" Dr. 12mm Hex Head Driver, 52mmL	C-4	465
340+9410	3/8" Dr. M10 Ribe Bit Socket, 110mmL	C-32	750	345214	3/8" Dr. 14mm Hex Head Driver, 52mmL	C-4	465
340020	3/8" Dr. Impact Adapter 3/8" F x 1/4" M w/Steel Ball (CR-Mo)	A-14	330	345216	3/8" Dr. 16mm Hex Head Driver, 52mmL	C-4	495
340040	3/8" Dr. Impact Adapter 3/8" F x 1/2" M w/Pin Hole (CR-Mo)	A-14	300	345217	3/8" Dr. 17mm Hex Head Driver, 52mmL	C-4	495
340040B	3/8" Dr. Impact Adapter 3/8" F x 1/2" M w/Steel Ball (CR-Mo)	A-14	300	3452P055	3/8" Dr. 1.0 x 5.5mm Slotted Head Driver, 52mmL	C-2	475
340075	3/8" Dr. Impact Extension Bar w/Pin Hole, 75mmL (CR-Mo)	A-14	285	3452P08	3/8" Dr. 1.2 x 8.0mm Slotted Head Driver, 52mmL	C-2	475
340075B	3/8" Dr. Impact Extension Bar w/Steel Ball, 75mmL (CR-Mo)	A-14	285	3452P10	3/8" Dr. 1.6 x 10.0mm Slotted Head Driver, 52mmL	C-2	475
340125	3/8" Dr. Impact Extension Bar w/Pin Hole, 125mmL (CR-Mo)	A-14	475	3452R01	3/8" Dr. PH.1 Phillips Head Driver, 52mmL	C-2	475
340125B	3/8" Dr. Impact Extension Bar w/Steel Ball, 125mmL (CR-Mo)	A-14	475	3452R02	3/8" Dr. PH.2 Phillips Head Driver, 52mmL	C-2	475
340200	3/8" Dr. Impact Extension Bar w/Pin Hole, 200mmL (CR-Mo)	A-14	790	3452R03	3/8" Dr. PH.3 Phillips Head Driver, 52mmL	C-2	475
340200B	3/8" Dr. Impact Extension Bar w/Steel Ball, 200mmL (CR-Mo)	A-14	790	3452R04	3/8" Dr. PH.4 Phillips Head Driver, 52mmL	C-2	475
341+	3/8" Dr. 11mm Hex Shank Bit Holder, 30mmL	D-21	300	3452S10	3/8" Dr. T-10 Star Head Driver, 52mmL	C-3	475

Item No.	Description	Pg.	Code	Item No.	Description	Pg.	Code
3452S15	3/8" Dr. T-15 Star Head Driver, 52mmL	C-3	475	347608	3/8" Dr. 8mm Hex Head Driver, 76mmL	C-4	525
3452S20	3/8" Dr. T-20 Star Head Driver, 52mmL	C-3	475	347609	3/8" Dr. 9mm Hex Head Driver, 76mmL	C-4	525
3452S25	3/8" Dr. T-25 Star Head Driver, 52mmL	C-3	475	347610	3/8" Dr. 10mm Hex Head Driver, 76mmL	C-4	525
3452S27	3/8" Dr. T-27 Star Head Driver, 52mmL	C-3	475	347612	3/8" Dr. 12mm Hex Head Driver, 76mmL	C-4	525
3452S30	3/8" Dr. T-30 Star Head Driver, 52mmL	C-3	475	347614	3/8" Dr. 14mm Hex Head Driver, 76mmL	C-4	525
3452S40	3/8" Dr. T-40 Star Head Driver, 52mmL	C-3	475	347616	3/8" Dr. 16mm Hex Head Driver, 76mmL	C-4	525
3452S45	3/8" Dr. T-45 Star Head Driver, 52mmL	C-3	475	347617	3/8" Dr. 17mm Hex Head Driver, 76mmL	C-4	525
3452S50	3/8" Dr. T-50 Star Head Driver, 52mmL	C-3	475	3476P055	3/8" Dr. 1.0 x 5.5mm Slotted Head Driver, 76mmL	C-2	525
3452S55	3/8" Dr. T-55 Star Head Driver, 52mmL	C-3	475	3476P08	3/8" Dr. 1.2 x 8.0mm Slotted Head Driver, 76mmL	C-2	525
3452S60	3/8" Dr. T-60 Star Head Driver, 52mmL	C-3	475	3476P10	3/8" Dr. 1.6 x 10.0mm Slotted Head Driver, 76mmL	C-2	525
3452T05	3/8" Dr. M5 Triple Square Head Driver, 52mmL	C-6	475	3476R01	3/8" Dr. PH.1 Philips Head Driver, 76mmL	C-2	525
3452T06	3/8" Dr. M6 Triple Square Head Driver, 52mmL	C-6	475	3476R02	3/8" Dr. PH.2 Philips Head Driver, 76mmL	C-2	525
3452T08	3/8" Dr. M8 Triple Square Head Driver, 52mmL	C-6	475	3476R03	3/8" Dr. PH.3 Philips Head Driver, 76mmL	C-2	525
3452T10	3/8" Dr. M10 Triple Square Head Driver, 52mmL	C-6	475	3476R04	3/8" Dr. PH.4 Philips Head Driver, 76mmL	C-2	525
3452T12	3/8" Dr. M12 Triple Square Head Driver, 52mmL	C-6	475	3476S10	3/8" Dr. T-10 Star Head Driver, 76mmL	C-3	590
346004	3/8" Dr. 4mm Hex Head Driver, 60mmL	C-4	500	3476S15	3/8" Dr. T-15 Star Head Driver, 76mmL	C-3	590
346005	3/8" Dr. 5mm Hex Head Driver, 60mmL	C-4	500	3476S20	3/8" Dr. T-20 Star Head Driver, 76mmL	C-3	590
346006	3/8" Dr. 6mm Hex Head Driver, 60mmL	C-4	500	3476S25	3/8" Dr. T-25 Star Head Driver, 76mmL	C-3	590
346007	3/8" Dr. 7mm Hex Head Driver, 60mmL	C-4	500	3476S27	3/8" Dr. T-27 Star Head Driver, 76mmL	C-3	590
346008	3/8" Dr. 8mm Hex Head Driver, 60mmL	C-4	500	3476S30	3/8" Dr. T-30 Star Head Driver, 76mmL	C-3	590
346009	3/8" Dr. 9mm Hex Head Driver, 60mmL	C-4	500	3476S40	3/8" Dr. T-40 Star Head Driver, 76mmL	C-3	590
346010	3/8" Dr. 10mm Hex Head Driver, 60mmL	C-4	500	3476S45	3/8" Dr. T-45 Star Head Driver, 76mmL	C-3	590
346012	3/8" Dr. 12mm Hex Head Driver, 60mmL	C-4	500	3476S50	3/8" Dr. T-50 Star Head Driver, 76mmL	C-3	590
346014	3/8" Dr. 14mm Hex Head Driver, 60mmL	C-4	500	3476S55	3/8" Dr. T-55 Star Head Driver, 76mmL	C-3	590
346016	3/8" Dr. 16mm Hex Head Driver, 60mmL	C-4	500	3476S60	3/8" Dr. T-60 Star Head Driver, 76mmL	C-3	590
346017	3/8" Dr. 17mm Hex Head Driver, 60mmL	C-4	500	3476T05	3/8" Dr. M5 Triple Square Head Driver, 76mmL	C-6	525
3460P055	3/8" Dr. 1.0 x 5.5mm Slotted Head Driver, 60mmL	C-2	500	3476T06	3/8" Dr. M6 Triple Square Head Driver, 76mmL	C-6	525
3460P08	3/8" Dr. 1.2 x 8.0mm Slotted Head Driver, 60mmL	C-2	500	3476T08	3/8" Dr. M8 Triple Square Head Driver, 76mmL	C-6	525
3460P10	3/8" Dr. 1.6 x 10.0mm Slotted Head Driver, 60mmL	C-2	500	3476T10	3/8" Dr. M10 Triple Square Head Driver, 76mmL	C-6	525
3460R01	3/8" Dr. PH.1 Philips Head Driver, 60mmL	C-2	500	3476T12	3/8" Dr. M12 Triple Square Head Driver, 76mmL	C-6	525
3460R02	3/8" Dr. PH.2 Philips Head Driver, 60mmL	C-2	500	3504	1/4" Hex Shank, 1/16" Hex Screwdriver Bit, 88mmL	D-6	260
3460R03	3/8" Dr. PH.3 Philips Head Driver, 60mmL	C-2	500	3505	1/4" Hex Shank, 5/64" Hex Screwdriver Bit, 88mmL	D-6	260
3460R04	3/8" Dr. PH.4 Philips Head Driver, 60mmL	C-2	500	3506	1/4" Hex Shank, 3/32" Hex Screwdriver Bit, 88mmL	D-6	260
3460S10	3/8" Dr. T-10 Star Head Driver, 60mmL	C-3	500	3507	1/4" Hex Shank, 7/64" Hex Screwdriver Bit, 88mmL	D-6	260
3460S15	3/8" Dr. T-15 Star Head Driver, 60mmL	C-3	500	3508	1/4" Hex Shank, 1/8" Hex Screwdriver Bit, 88mmL	D-6	260
3460S20	3/8" Dr. T-20 Star Head Driver, 60mmL	C-3	500	3510	1/4" Hex Shank, 5/32" Hex Screwdriver Bit, 88mmL	D-6	260
3460S25	3/8" Dr. T-25 Star Head Driver, 60mmL	C-3	500	3512	1/4" Hex Shank, 3/16" Hex Screwdriver Bit, 88mmL	D-6	260
3460S27	3/8" Dr. T-27 Star Head Driver, 60mmL	C-3	500	3514	1/4" Hex Shank, 7/32" Hex Screwdriver Bit, 88mmL	D-6	260
3460S30	3/8" Dr. T-30 Star Head Driver, 60mmL	C-3	500	3516	1/4" Hex Shank, 1/4" Hex Screwdriver Bit, 88mmL	D-6	260
3460S40	3/8" Dr. T-40 Star Head Driver, 60mmL	C-3	500	3518	5/16" Hex Shank, 9/32" Hex Screwdriver Bit, 88mmL	D-6	300
3460S45	3/8" Dr. T-45 Star Head Driver, 60mmL	C-3	500	351800	Air Reversible Drill (Keyless)	E-24	14130
3460S50	3/8" Dr. T-50 Star Head Driver, 60mmL	C-3	500	351801	Air Reversible Drill	E-24	13940
3460S55	3/8" Dr. T-55 Star Head Driver, 60mmL	C-3	500	3520	5/16" Hex Shank, 5/16" Hex Screwdriver Bit, 88mmL	D-6	300
3460S60	3/8" Dr. T-60 Star Head Driver, 60mmL	C-3	500	3524	3/8" Hex Shank, 3/8" Hex Screwdriver Bit, 88mmL	D-6	400
3460T05	3/8" Dr. M5 Triple Square Head Driver, 60mmL	C-6	500	3528	7/16" Hex Shank, 7/16" Hex Screwdriver Bit, 88mmL	D-6	540
3460T06	3/8" Dr. M6 Triple Square Head Driver, 60mmL	C-6	500	3532	1/2" Hex Shank, 1/2" Hex Screwdriver Bit, 88mmL	D-6	680
3460T08	3/8" Dr. M8 Triple Square Head Driver, 60mmL	C-6	500	353510	3/8" Dr. E-10 E-Star Hand Socket	B-20	360
3460T10	3/8" Dr. M10 Triple Square Head Driver, 60mmL	C-6	500	353511	3/8" Dr. E-11 E-Star Hand Socket	B-20	360
3460T12	3/8" Dr. M12 Triple Square Head Driver, 60mmL	C-6	500	353512	3/8" Dr. E-12 E-Star Hand Socket	B-20	360
346306	3/8" Dr. 6mm Deep Impact Socket (CR-Mo)	A-13	340	353514	3/8" Dr. E-14 E-Star Hand Socket	B-20	435
346307	3/8" Dr. 7mm Deep Impact Socket (CR-Mo)	A-13	340	353516	3/8" Dr. E-16 E-Star Hand Socket	B-20	435
346308	3/8" Dr. 8mm Deep Impact Socket (CR-Mo)	A-13	340	353518	3/8" Dr. E-18 E-Star Hand Socket	B-20	435
346309	3/8" Dr. 9mm Deep Impact Socket (CR-Mo)	A-13	340	353520	3/8" Dr. E-20 E-Star Hand Socket	B-20	475
346310	3/8" Dr. 10mm Deep Impact Socket (CR-Mo)	A-13	340	3536	9/16" Hex Shank, 9/16" Hex Screwdriver Bit, 88mmL	D-6	740
346311	3/8" Dr. 11mm Deep Impact Socket (CR-Mo)	A-13	340	3540	5/8" Hex Shank, 5/8" Hex Screwdriver Bit, 88mmL	D-6	770
346312	3/8" Dr. 12mm Deep Impact Socket (CR-Mo)	A-13	340	3544	11/16" Hex Shank, 11/16" Hex Screwdriver Bit, 88mmL	D-6	820
346313	3/8" Dr. 13mm Deep Impact Socket (CR-Mo)	A-13	340	3548	3/4" Hex Shank, 3/4" Hex Screwdriver Bit, 88mmL	D-6	920
346314	3/8" Dr. 14mm Deep Impact Socket (CR-Mo)	A-13	340	355610	3/8" Dr. 10mm Universal Hand Socket (12-Point)	B-23	590
346315	3/8" Dr. 15mm Deep Impact Socket (CR-Mo)	A-13	360	355611	3/8" Dr. 11mm Universal Hand Socket (12-Point)	B-23	590
346316	3/8" Dr. 16mm Deep Impact Socket (CR-Mo)	A-13	385	355612	3/8" Dr. 12mm Universal Hand Socket (12-Point)	B-23	590
346317	3/8" Dr. 17mm Deep Impact Socket (CR-Mo)	A-13	415	355613	3/8" Dr. 13mm Universal Hand Socket (12-Point)	B-23	590
346318	3/8" Dr. 18mm Deep Impact Socket (CR-Mo)	A-13	440	355614	3/8" Dr. 14mm Universal Hand Socket (12-Point)	B-23	610
346319	3/8" Dr. 19mm Deep Impact Socket (CR-Mo)	A-13	460	355615	3/8" Dr. 15mm Universal Hand Socket (12-Point)	B-23	610
346320	3/8" Dr. 20mm Deep Impact Socket (CR-Mo)	A-13	495	355616	3/8" Dr. 16mm Universal Hand Socket (12-Point)	B-23	610
346321	3/8" Dr. 21mm Deep Impact Socket (CR-Mo)	A-13	525	355617	3/8" Dr. 17mm Universal Hand Socket (12-Point)	B-23	650
346322	3/8" Dr. 22mm Deep Impact Socket (CR-Mo)	A-13	605	355618	3/8" Dr. 18mm Universal Hand Socket (12-Point)	B-23	650
347604	3/8" Dr. 4mm Hex Head Driver, 76mmL	C-4	525	355619	3/8" Dr. 19mm Universal Hand Socket (12-Point)	B-23	650
347605	3/8" Dr. 5mm Hex Head Driver, 76mmL	C-4	525	3604	1/4" Hex Shank, 1/16" Hex Screwdriver Bit, 125mmL	D-7	300
347606	3/8" Dr. 6mm Hex Head Driver, 76mmL	C-4	525	3605	1/4" Hex Shank, 5/64" Hex Screwdriver Bit, 125mmL	D-7	300
347607	3/8" Dr. 7mm Hex Head Driver, 76mmL	C-4	525	3606	1/4" Hex Shank, 3/32" Hex Screwdriver Bit, 125mmL	D-7	300

Item No.	Description	Pg.	Code	Item No.	Description	Pg.	Code
3607	1/4" Hex Shank, 7/64" Hex Screwdriver Bit, 125mmL	D-7	300	3708	1/4" Hex Shank, 1/8" Hex Screwdriver Bit, 160mmL	D-7	380
3608	1/4" Hex Shank, 1/8" Hex Screwdriver Bit, 125mmL	D-7	300	3710	1/4" Hex Shank, 5/32" Hex Screwdriver Bit, 160mmL	D-7	380
3610	1/4" Hex Shank, 5/32" Hex Screwdriver Bit, 125mmL	D-7	300	3712	1/4" Hex Shank, 3/16" Hex Screwdriver Bit, 160mmL	D-7	380
3612	1/4" Hex Shank, 3/16" Hex Screwdriver Bit, 125mmL	D-7	300	3714	1/4" Hex Shank, 7/32" Hex Screwdriver Bit, 160mmL	D-7	380
3614	1/4" Hex Shank, 7/32" Hex Screwdriver Bit, 125mmL	D-7	300	3716	1/4" Hex Shank, 1/4" Hex Screwdriver Bit, 160mmL	D-7	380
3616	1/4" Hex Shank, 1/4" Hex Screwdriver Bit, 125mmL	D-7	300	3718	5/16" Hex Shank, 9/32" Hex Screwdriver Bit, 160mmL	D-7	500
3618	5/16" Hex Shank, 9/32" Hex Screwdriver Bit, 125mmL	D-7	400	3720	5/16" Hex Shank, 5/16" Hex Screwdriver Bit, 160mmL	D-7	500
3620	5/16" Hex Shank, 5/16" Hex Screwdriver Bit, 125mmL	D-7	400	3724	3/8" Hex Shank, 3/8" Hex Screwdriver Bit, 160mmL	D-7	700
3624	3/8" Hex Shank, 3/8" Hex Screwdriver Bit, 125mmL	D-7	600	3728	7/16" Hex Shank, 7/16" Hex Screwdriver Bit, 160mmL	D-7	880
3628	7/16" Hex Shank, 7/16" Hex Screwdriver Bit, 125mmL	D-7	750	3732	1/2" Hex Shank, 1/2" Hex Screwdriver Bit, 160mmL	D-7	1050
363008	3/8" Dr. 1/4" Hex Shank Impact Bit Holder, 30mmL (CR-Mo)	A-14	800	373208	3/8" Dr. 1/4" Hand Socket (12-Point)	B-22	190
363010	3/8" Dr. 5/16" Hex Shank Impact Bit Holder, 30mmL (CR-Mo)	A-14	800	373210	3/8" Dr. 5/16" Hand Socket (12-Point)	B-22	190
3632	1/2" Hex Shank, 1/2" Hex Screwdriver Bit, 125mmL	D-7	900	373211	3/8" Dr. 11/32" Hand Socket (12-Point)	B-22	190
363208	3/8" Dr. 1/4" Impact Socket (CR-Mo)	A-12	210	373212	3/8" Dr. 3/8" Hand Socket (12-Point)	B-22	190
363210	3/8" Dr. 5/16" Impact Socket (CR-Mo)	A-12	210	373214	3/8" Dr. 7/16" Hand Socket (12-Point)	B-22	190
363211	3/8" Dr. 11/32" Impact Socket (CR-Mo)	A-12	210	373216	3/8" Dr. 1/2" Hand Socket (12-Point)	B-22	190
363212	3/8" Dr. 3/8" Impact Socket (CR-Mo)	A-12	210	373218	3/8" Dr. 9/16" Hand Socket (12-Point)	B-22	190
363214	3/8" Dr. 7/16" Impact Socket (CR-Mo)	A-12	210	373219	3/8" Dr. 19/32" Hand Socket (12-Point)	B-22	210
363216	3/8" Dr. 1/2" Impact Socket (CR-Mo)	A-12	210	373220	3/8" Dr. 5/8" Hand Socket (12-Point)	B-22	235
363218	3/8" Dr. 9/16" Impact Socket (CR-Mo)	A-12	210	373222	3/8" Dr. 11/16" Hand Socket (12-Point)	B-22	255
363219	3/8" Dr. 19/32" Impact Socket (CR-Mo)	A-12	235	373224	3/8" Dr. 3/4" Hand Socket (12-Point)	B-22	305
363220	3/8" Dr. 5/8" Impact Socket (CR-Mo)	A-12	255	373225	3/8" Dr. 25/32" Hand Socket (12-Point)	B-22	335
363222	3/8" Dr. 11/16" Impact Socket (CR-Mo)	A-12	280	373226	3/8" Dr. 13/16" Hand Socket (12-Point)	B-22	390
363224	3/8" Dr. 3/4" Impact Socket (CR-Mo)	A-12	335	373228	3/8" Dr. 7/8" Hand Socket (12-Point)	B-22	450
363225	3/8" Dr. 25/32" Impact Socket (CR-Mo)	A-12	365	3736	9/16" Hex Shank, 9/16" Hex Screwdriver Bit, 160mmL	D-7	1140
363226	3/8" Dr. 13/16" Impact Socket (CR-Mo)	A-12	435	3740	5/8" Hex Shank, 5/8" Hex Screwdriver Bit, 160mmL	D-7	1230
363228	3/8" Dr. 7/8" Impact Socket (CR-Mo)	A-12	495	3744	11/16" Hex Shank, 11/16" Hex Screwdriver Bit, 160mmL	D-7	1340
3636	9/16" Hex Shank, 9/16" Hex Screwdriver Bit, 125mmL	D-7	980	3748	3/4" Hex Shank, 3/4" Hex Screwdriver Bit, 160mmL	D-7	1520
363908	3/8" Dr. 1/4" Hex Shank Impact Bit Holder, 39mmL (CR-Mo)	A-14	475	376308	3/8" Dr. 1/4" Deep Hand Socket (12-Point)	B-23	305
363910	3/8" Dr. 5/16" Hex Shank Impact Bit Holder, 39mmL (CR-Mo)	A-14	495	376310	3/8" Dr. 5/16" Deep Hand Socket (12-Point)	B-23	305
3640	5/8" Hex Shank, 5/8" Hex Screwdriver Bit, 125mmL	D-7	1050	376311	3/8" Dr. 11/32" Deep Hand Socket (12-Point)	B-23	305
3644	11/16" Hex Shank, 11/16" Hex Screwdriver Bit, 125mmL	D-7	1160	376312	3/8" Dr. 3/8" Deep Hand Socket (12-Point)	B-23	305
364608	3/8" Dr. 1/4" Hex Shank Impact Bit Holder, 46mmL (CR-Mo)	A-14	475	376314	3/8" Dr. 7/16" Deep Hand Socket (12-Point)	B-23	305
364610	3/8" Dr. 5/16" Hex Shank Impact Bit Holder, 46mmL (CR-Mo)	A-14	495	376316	3/8" Dr. 1/2" Deep Hand Socket (12-Point)	B-23	305
3648	3/4" Hex Shank, 3/4" Hex Screwdriver Bit, 125mmL	D-7	1310	376318	3/8" Dr. 9/16" Deep Hand Socket (12-Point)	B-23	305
365205	3/8" Dr. 5/32" Hex Head Driver, 52mmL	C-4	475	376319	3/8" Dr. 19/32" Deep Hand Socket (12-Point)	B-23	330
365206	3/8" Dr. 3/16" Hex Head Driver, 52mmL	C-4	475	376320	3/8" Dr. 5/8" Deep Hand Socket (12-Point)	B-23	350
365207	3/8" Dr. 7/32" Hex Head Driver, 52mmL	C-4	475	376322	3/8" Dr. 11/16" Deep Hand Socket (12-Point)	B-23	375
365208	3/8" Dr. 1/4" Hex Head Driver, 52mmL	C-4	500	376324	3/8" Dr. 3/4" Deep Hand Socket (12-Point)	B-23	415
365210	3/8" Dr. 5/16" Hex Head Driver, 52mmL	C-4	500	376325	3/8" Dr. 25/32" Deep Hand Socket (12-Point)	B-23	450
365212	3/8" Dr. 3/8" Hex Head Driver, 52mmL	C-4	500	376326	3/8" Dr. 13/16" Deep Hand Socket (12-Point)	B-23	475
365214	3/8" Dr. 7/16" Hex Head Driver, 52mmL	C-4	500	376328	3/8" Dr. 7/8" Deep Hand Socket (12-Point)	B-23	550
365216	3/8" Dr. 1/2" Hex Head Driver, 52mmL	C-4	500	380005	3/8" Dr. Impact Extension Bar, 45mmL	A-7	180
365218	3/8" Dr. 9/16" Hex Head Driver, 52mmL	C-4	500	380008M	3/8" Dr. 8mm Swivel Impact Socket	A-9	735
365220	3/8" Dr. 5/8" Hex Head Driver, 52mmL	C-4	525	380008MD	3/8" Dr. 8mm Deep Swivel Impact Socket	A-10	1155
365612	3/8" Dr. 3/8" Universal Hand Socket (12-Point)	B-23	590	380009M	3/8" Dr. 9mm Swivel Impact Socket	A-9	735
365614	3/8" Dr. 7/16" Universal Hand Socket (12-Point)	B-23	590	380009MD	3/8" Dr. 9mm Deep Swivel Impact Socket	A-10	1155
365616	3/8" Dr. 1/2" Universal Hand Socket (12-Point)	B-23	590	380010M	3/8" Dr. 10mm Swivel Impact Socket	A-9	735
365618	3/8" Dr. 9/16" Universal Hand Socket (12-Point)	B-23	610	380010MD	3/8" Dr. 10mm Deep Swivel Impact Socket	A-10	1155
365620	3/8" Dr. 5/8" Universal Hand Socket (12-Point)	B-23	610	380011M	3/8" Dr. 11mm Swivel Impact Socket	A-9	735
365622	3/8" Dr. 11/16" Universal Hand Socket (12-Point)	B-23	650	380011MD	3/8" Dr. 11mm Deep Swivel Impact Socket	A-10	1155
365624	3/8" Dr. 3/4" Universal Hand Socket (12-Point)	B-23	650	380012M	3/8" Dr. 12mm Swivel Impact Socket	A-9	735
366308	3/8" Dr. 1/4" Deep Impact Socket (CR-Mo)	A-13	340	380012MD	3/8" Dr. 12mm Deep Swivel Impact Socket	A-10	1155
366310	3/8" Dr. 5/16" Deep Impact Socket (CR-Mo)	A-13	340	380013M	3/8" Dr. 13mm Swivel Impact Socket	A-9	735
366311	3/8" Dr. 11/32" Deep Impact Socket (CR-Mo)	A-13	340	380013MD	3/8" Dr. 13mm Deep Swivel Impact Socket	A-10	1155
366312	3/8" Dr. 3/8" Deep Impact Socket (CR-Mo)	A-13	340	380014M	3/8" Dr. 14mm Swivel Impact Socket	A-9	735
366314	3/8" Dr. 7/16" Deep Impact Socket (CR-Mo)	A-13	340	380014MD	3/8" Dr. 14mm Deep Swivel Impact Socket	A-10	1155
366316	3/8" Dr. 1/2" Deep Impact Socket (CR-Mo)	A-13	340	380015M	3/8" Dr. 15mm Swivel Impact Socket	A-9	735
366318	3/8" Dr. 9/16" Deep Impact Socket (CR-Mo)	A-13	340	380015MD	3/8" Dr. 15mm Deep Swivel Impact Socket	A-10	1155
366319	3/8" Dr. 19/32" Deep Impact Socket (CR-Mo)	A-13	360	380016M	3/8" Dr. 16mm Swivel Impact Socket	A-9	735
366320	3/8" Dr. 5/8" Deep Impact Socket (CR-Mo)	A-13	385	380016MD	3/8" Dr. 16mm Deep Swivel Impact Socket	A-10	1155
366322	3/8" Dr. 11/16" Deep Impact Socket (CR-Mo)	A-13	410	380017M	3/8" Dr. 17mm Swivel Impact Socket	A-9	765
366324	3/8" Dr. 3/4" Deep Impact Socket (CR-Mo)	A-13	460	380017MD	3/8" Dr. 17mm Deep Swivel Impact Socket	A-10	1210
366325	3/8" Dr. 25/32" Deep Impact Socket (CR-Mo)	A-13	495	380018M	3/8" Dr. 18mm Swivel Impact Socket	A-9	790
366326	3/8" Dr. 13/16" Deep Impact Socket (CR-Mo)	A-13	525	380018MD	3/8" Dr. 18mm Deep Swivel Impact Socket	A-10	1260
366328	3/8" Dr. 7/8" Deep Impact Socket (CR-Mo)	A-13	605	380019M	3/8" Dr. 19mm Swivel Impact Socket	A-9	825
3704	1/4" Hex Shank, 1/16" Hex Screwdriver Bit, 160mmL	D-7	380	380019MD	3/8" Dr. 19mm Deep Swivel Impact Socket	A-10	1260
3705	1/4" Hex Shank, 5/64" Hex Screwdriver Bit, 160mmL	D-7	380	380020	3/8" Dr. Impact Adapter 3/8" F x 1/4" M	A-7	215
3706	1/4" Hex Shank, 3/32" Hex Screwdriver Bit, 160mmL	D-7	380	380021D	3/8" Dr. 5/16" Deep Swivel Impact Socket	A-10	1155
3707	1/4" Hex Shank, 7/64" Hex Screwdriver Bit, 160mmL	D-7	380	380022	3/8" Dr. 3/8" Swivel Impact Socket	A-9	735

Item No.	Description	Pg.	Code
380022D	3/8" Dr. 3/8" Deep Swivel Impact Socket	A-10	1155
380023	3/8" Dr. 7/16" Swivel Impact Socket	A-9	735
380023D	3/8" Dr. 7/16" Deep Swivel Impact Socket	A-10	1155
380024	3/8" Dr. 1/2" Swivel Impact Socket	A-9	735
380024D	3/8" Dr. 1/2" Deep Swivel Impact Socket	A-10	1155
380025	3/8" Dr. 9/16" Swivel Impact Socket	A-9	735
380025D	3/8" Dr. 9/16" Deep Swivel Impact Socket	A-10	1155
380026	3/8" Dr. 5/8" Swivel Impact Socket	A-9	735
380026D	3/8" Dr. 5/8" Deep Swivel Impact Socket	A-10	1155
380027	3/8" Dr. 11/16" Swivel Impact Socket	A-9	765
380027D	3/8" Dr. 11/16" Deep Swivel Impact Socket	A-10	1210
380028	3/8" Dr. 3/4" Swivel Impact Socket	A-9	825
380028D	3/8" Dr. 3/4" Deep Swivel Impact Socket	A-10	1260
380029	3/8" Dr. Impact Extension Bar, 75mmL	A-7	195
380030	3/8" Dr. Sliding T-Handle	B-25	930
380030N	3/8" Dr. Torque Wrench, 6 ~ 30 Nm	F-36	10200
380031	3/8" Dr. 1/4" Hex Shank Impact Bit Holder, 75mmL	A-7	415
380032	3/8" Dr. 1/4" Hex Shank Impact Bit Holder, 28mmL	A-7	280
380033	3/8" Dr. 5/16" Hex Shank Impact Bit Holder, 30mmL	A-7	280
380036	3/8" Dr. Impact Extension Bar, 150mmL	A-7	360
380037	3/8" Dr. Impact Extension Bar, 200mmL	A-7	415
380040	3/8" Dr. Impact Adapter 3/8" F x 1/2" M	A-7	195
380070	3/8" Dr. Universal Joint	B-24	465
380080F	3/8" Dr. Torque Wrench, 15 ~ 80 ft. lbs.	F-36	10400
380110N	3/8" Dr. Torque Wrench, 19 ~ 110 Nm	F-36	10400
380250L	3/8" Dr. Torque Wrench, 40 ~ 250 in. lbs.	F-36	10200
380331P	3/8" Dr. 36 Teeth Ratchet w/ Quick Release	B-26	3360
380331R	3/8" Dr. 36 Teeth Ratchet w/ Quick Release	B-26	3260
380331S	3/8" Dr. 36 Teeth Ratchet w/ Quick Release	B-26	3460
380333R	3/8" Dr. Reversible Ratchet	B-26	2215
380336	3/8" Dr. Hinge Handle, 200nnL	B-26	1720
380336A	3/8" Dr. Hinge Handle, 200nnL	B-26	1720
380336P	3/8" Dr. Hinge Handle, 230mmL	B-26	1820
380336S	3/8" Dr. Hinge Handle, 240mmL	B-26	1920
380338	3/8" Dr. Hinge Handle, 255mmL	B-26	2400
380338P	3/8" Dr. Hinge Handle, 240mmL	B-26	2500
380338S	3/8" Dr. Hinge Handle, 280mmL	B-26	2600
380370	3/8" Dr. 72 Teeth Stubby Ratchet	B-27	2280
380371	1/4" & 3/8" Double Drive Ratchet	B-6	3260
380372	3/8" Dr. 72 Teeth Reversible Ratchet	B-26	2450
380372P	3/8" Dr. 72 Teeth Reversible Ratchet	B-26	2550
380372S	3/8" Dr. 72 Teeth Reversible Ratchet	B-26	2650
380375	3/8" Dr. Flex Head Ratchet	B-27	3150
380400	3/8" Dr. Speed Handle	B-25	2330
3808	1/4" Hex Shank, 1/8" Hex Screwdriver Bit, 200mmL	D-7	450
380J21	3/8" Dr. 5/16" Swivel Impact Socket	A-9	735
3810	1/4" Hex Shank, 5/32" Hex Screwdriver Bit, 200mmL	D-7	450
3812	1/4" Hex Shank, 3/16" Hex Screwdriver Bit, 200mmL	D-7	450
3814	1/4" Hex Shank, 7/32" Hex Screwdriver Bit, 200mmL	D-7	450
3816	1/4" Hex Shank, 1/4" Hex Screwdriver Bit, 200mmL	D-7	450
3818	5/16" Hex Shank, 9/32" Hex Screwdriver Bit, 200mmL	D-7	600
381803	3/8" Dr. 72 Teeth Rotor Ratchet	B-27	4250
381803P	3/8" Dr. 72 Teeth Rotor Ratchet	B-27	4350
381803S	3/8" Dr. 72 Teeth Rotor Ratchet	B-27	4450
3820	5/16" Hex Shank, 5/16" Hex Screwdriver Bit, 200mmL	D-7	600
3824	3/8" Hex Shank, 3/8" Hex Screwdriver Bit, 200mmL	D-7	800
3828	7/16" Hex Shank, 7/16" Hex Screwdriver Bit, 200mmL	D-7	1000
3832	1/2" Hex Shank, 1/2" Hex Screwdriver Bit, 200mmL	D-7	1200
383208	3/8" Dr. 1/4" Hand Socket	B-20	190
383210	3/8" Dr. 5/16" Hand Socket	B-20	190
383211	3/8" Dr. 11/32" Hand Socket	B-20	190
383212	3/8" Dr. 3/8" Hand Socket	B-20	190
383214	3/8" Dr. 7/16" Hand Socket	B-20	190
383216	3/8" Dr. 1/2" Hand Socket	B-20	190
383218	3/8" Dr. 9/16" Hand Socket	B-20	190
383219	3/8" Dr. 19/32" Hand Socket	B-20	210
383220	3/8" Dr. 5/8" Hand Socket	B-20	235
383222	3/8" Dr. 11/16" Hand Socket	B-20	255
383224	3/8" Dr. 3/4" Hand Socket	B-20	305
383225	3/8" Dr. 25/32" Hand Socket	B-20	335

Item No.	Description	Pg.	Code
383226	3/8" Dr. 13/16" Hand Socket	B-20	390
383228	3/8" Dr. 7/8" Hand Socket	B-20	450
383338	3/8" Dr. 72 Teeth Flex Head Ratchet, 280mmL	B-27	2900
383338P	3/8" Dr. 72 Teeth Flex Head Ratchet, 300mmL	B-27	3100
383338S	3/8" Dr. 72 Teeth Flex Head Ratchet, 320mmL	B-27	3200
383363	3/8" Dr. 72 Teeth Flex Head Ratchet, 230mmL	B-27	2700
383363P	3/8" Dr. 72 Teeth Flex Head Ratchet, 250mmL	B-27	2800
383363S	3/8" Dr. 72 Teeth Flex Head Ratchet, 270mmL	B-27	2900
383383L	3/8" Dr. Bent Handle Flex Head Ratchet	B-27	3000
383383P	3/8" Dr. Bent Handle Flex Head Ratchet	B-27	3100
383383S	3/8" Dr. 72 Teeth Flex Head Ratchet, 310mmL	B-27	3200
3836	9/16" Hex Shank, 9/16" Hex Screwdriver Bit, 200mmL	D-7	1300
383908	3/8" Dr. 1/4" Hex Shank Bit Holder(quick change), 39mmL	B-25	475
383910	3/8" Dr. 5/16" Hex Shank Bit Holder(quick change), 39mmL	B-25	495
383912	3/8" Dr. 3/8" Hex Shank Bit Holder(quick change), 39mmL	B-25	520
3840	5/8" Hex Shank, 5/8" Hex Screwdriver Bit, 200mmL	D-7	1400
3844	11/16" Hex Shank, 11/16" Hex Screwdriver Bit, 200mmL	D-7	1520
384608	3/8" Dr. 1/4" Hex Shank Bit Holder(quick change), 46mmL	B-25	475
384610	3/8" Dr. 5/16" Hex Shank Bit Holder(quick change), 46mmL	B-25	495
3848	3/4" Hex Shank, 3/4" Hex Screwdriver Bit, 200mmL	D-7	1720
386308	3/8" Dr. 1/4" Deep Hand Socket	B-21	305
386310	3/8" Dr. 5/16" Deep Hand Socket	B-21	305
386311	3/8" Dr. 11/32" Deep Hand Socket	B-21	305
386312	3/8" Dr. 3/8" Deep Hand Socket	B-21	305
386314	3/8" Dr. 7/16" Deep Hand Socket	B-21	305
386316	3/8" Dr. 1/2" Deep Hand Socket	B-21	305
386318	3/8" Dr. 9/16" Deep Hand Socket	B-21	305
386319	3/8" Dr. 19/32" Deep Hand Socket	B-21	330
386320	3/8" Dr. 5/8" Deep Hand Socket	B-21	350
386322	3/8" Dr. 11/16" Deep Hand Socket	B-21	375
386324	3/8" Dr. 3/4" Deep Hand Socket	B-21	415
386325	3/8" Dr. 25/32" Deep Hand Socket	B-21	450
386326	3/8" Dr. 13/16" Deep Hand Socket	B-21	475
386328	3/8" Dr. 7/8" Deep Hand Socket	B-21	550
393008	3/8" Dr. 1/4" Impact Socket	A-5	135
393010	3/8" Dr. 5/16" Impact Socket	A-5	135
393011	3/8" Dr. 11/32" Impact Socket	A-5	135
393012	3/8" Dr. 3/8" Impact Socket	A-5	135
393014	3/8" Dr. 7/16" Impact Socket	A-5	135
393016	3/8" Dr. 1/2" Impact Socket	A-5	135
393018	3/8" Dr. 9/16" Impact Socket	A-5	135
393019	3/8" Dr. 19/32" Impact Socket	A-5	155
393020	3/8" Dr. 5/8" Impact Socket	A-5	170
393022	3/8" Dr. 11/16" Impact Socket	A-5	190
393024	3/8" Dr. 3/4" Impact Socket	A-5	230
393025	3/8" Dr. 25/32" Impact Socket	A-5	265
393026	3/8" Dr. 13/16" Impact Socket	A-5	300
393028	3/8" Dr. 7/8" Impact Socket	A-5	385
3936	19mm Hex Shank, 9/16" Hex Impact Screwdriver Bit, 45mmL	D-20	700
3940	19mm Hex Shank, 5/8" Hex Impact Screwdriver Bit, 45mmL	D-20	700
3948	19mm Hex Shank, 3/4" Hex Impact Screwdriver Bit, 45mmL	D-20	700
3952	22mm Hex Shank, 13/16" Hex Impact Screwdriver Bit, 50mmL	D-20	800
3956	22mm Hex Shank, 7/8" Hex Impact Screwdriver Bit, 50mmL	D-20	800
3960	22mm Hex Shank, 15/16" Hex Impact Screwdriver Bit, 50mmL	D-20	950
396308	3/8" Dr. 1/4" Deep Impact Socket	A-6	210
396310	3/8" Dr. 5/16" Deep Impact Socket	A-6	210
396311	3/8" Dr. 11/32" Deep Impact Socket	A-6	210
396312	3/8" Dr. 3/8" Deep Impact Socket	A-6	210
396314	3/8" Dr. 7/16" Deep Impact Socket	A-6	210
396316	3/8" Dr. 1/2" Deep Impact Socket	A-6	210
396318	3/8" Dr. 9/16" Deep Impact Socket	A-6	210
396319	3/8" Dr. 19/32" Deep Impact Socket	A-6	250
396320	3/8" Dr. 5/8" Deep Impact Socket	A-6	250
396322	3/8" Dr. 11/16" Deep Impact Socket	A-6	275
396324	3/8" Dr. 3/4" Deep Impact Socket	A-6	300
396325	3/8" Dr. 25/32" Deep Impact Socket	A-6	340
396326	3/8" Dr. 13/16" Deep Impact Socket	A-6	360
396328	3/8" Dr. 7/8" Deep Impact Socket	A-6	420
3964	22mm Hex Shank, 1" Hex Impact Screwdriver Bit, 50mmL	D-20	950
3968	27mm Hex Shank, 1-1/16" Hex Impact Screwdriver Bit, 55mmL	D-20	1100

Item No.	Description	Pg.	Code
3972	27mm Hex Shank, 1-1/8" Hex Impact Screwdriver Bit, 55mmL	D-20	1300
3976	27mm Hex Shank, 1-3/16" Hex Impact Screwdriver Bit, 55mmL	D-20	1400
3980	27mm Hex Shank, 1-1/4" Hex Impact Screwdriver Bit, 55mmL	D-20	1500
3984	32mm Hex Shank, 1-5/16" Hex Impact Screwdriver Bit, 60mmL	D-20	1650
3988	32mm Hex Shank, 1-3/8" Hex Impact Screwdriver Bit, 60mmL	D-20	1800
<b>4</b>			
400230	1/2" Dr. Air Impact Wrench, 230 ft. lbs. / 312 Nm	E-4	11300
400400G	1/2" Dr. Air Impact Wrench, 380 ft. lbs. / 516 Nm	E-6	24150
400401	1/2" Dr. Air Impact Wrench, 400 ft. lbs. / 542 Nm	E-6	32000
400402	1/2" Dr. Long Anvil Air Impact Wrench, 400 ft. lbs. / 542 Nm	E-6	34000
400420	1/2" Dr. Air Impact Wrench, 420 ft. lbs. / 570 Nm	E-7	28900
400422	1/2" Dr. Long Anvil Air Impact Wrench, 420 ft. lbs. / 570 Nm	E-7	30900
400450	1/2" Dr. Air Impact Wrench, 450 ft. lbs. / 610 Nm	E-7	28900
400452	1/2" Dr. Long Anvil Air Impact Wrench, 450 ft. lbs. / 610 Nm	E-7	30900
400500	1/2" Dr. Air Impact Wrench, 500 ft. lbs. / 678 Nm	E-8	35600
400502	1/2" Dr. Long Anvil Air Impact Wrench, 500 ft. lbs. / 678 Nm	E-8	37600
400511	1/2" Dr. Lightweight Air Impact Wrench, 500 ft. lbs. / 678 Nm	E-8	26740
400800	1/2" Dr. Air Impact Wrench, 800 ft. lbs. / 1,085 Nm	E-9	37800
400802	1/2" Dr. Long Anvil Air Impact Wrench, 800 ft. lbs. / 1,085 Nm	E-9	41000
401000	1/2" x 3/4" Dr. Torque Multiplier, 1000 ft. lbs./1400 Nm	F-37	48500
401500	1/2" x 3/4" Dr. Torque Multiplier, 1100 ft. lbs./1500 Nm	F-37	50000
404508	1/2" Dr. E-8 E-Star Impact Socket	A-35	700
404510	1/2" Dr. E-10 E-Star Impact Socket	A-35	700
404511	1/2" Dr. E-11 E-Star Impact Socket	A-35	700
404512	1/2" Dr. E-12 E-Star Impact Socket	A-35	700
404514	1/2" Dr. E-14 E-Star Impact Socket	A-35	700
404516	1/2" Dr. E-16 E-Star Impact Socket	A-35	700
404518	1/2" Dr. E-18 E-Star Impact Socket	A-35	700
404520	1/2" Dr. E-20 E-Star Impact Socket	A-35	700
404522	1/2" Dr. E-22 E-Star Impact Socket	A-35	900
404524	1/2" Dr. E-24 E-Star Impact Socket	A-35	980
404526	1/2" Dr. E-26 E-Star Impact Socket	A-35	1070
404528	1/2" Dr. E-28 E-Star Impact Socket	A-35	1150
404530	1/2" Dr. E-30 E-Star Impact Socket	A-35	1240
404532	1/2" Dr. E-32 E-Star Impact Socket	A-35	1330
405053X	1/2" Dr. Air Ratchet Wrench, 50 ft. lbs. / 68 Nm	E-2	10500
405054X	1/2" Dr. Air Ratchet Wrench, 65 ft. lbs. / 88 Nm	E-2	25750
406100	1/2" Dr. M6 x 1.00mm Stud Bolt Socket	J-19	500
407808	1/2" Dr. E-8 E-Star Deep Impact Socket	A-35	840
407810	1/2" Dr. E-10 E-Star Deep Impact Socket	A-35	840
407811	1/2" Dr. E-11 E-Star Deep Impact Socket	A-35	840
407812	1/2" Dr. E-12 E-Star Deep Impact Socket	A-35	840
407814	1/2" Dr. E-14 E-Star Deep Impact Socket	A-35	840
407816	1/2" Dr. E-16 E-Star Deep Impact Socket	A-35	840
407818	1/2" Dr. E-18 E-Star Deep Impact Socket	A-35	960
407820	1/2" Dr. E-20 E-Star Deep Impact Socket	A-35	1120
407822	1/2" Dr. E-22 E-Star Deep Impact Socket	A-35	1120
407824	1/2" Dr. E-24 E-Star Deep Impact Socket	A-35	1200
407826	1/2" Dr. E-26 E-Star Deep Impact Socket	A-35	1300
407828	1/2" Dr. E-28 E-Star Deep Impact Socket	A-35	1400
407830	1/2" Dr. E-30 E-Star Deep Impact Socket	A-35	1500
407832	1/2" Dr. E-32 E-Star Deep Impact Socket	A-35	1600
408+	1/2" Dr. 1/4" Hex Shank Bit Holder, 36mmL	D-21	380
408+1102	1/2" Dr. PH.2 Philips Bit Socket, 55mmL	C-48	420
408+1103	1/2" Dr. PH.3 Philips Bit Socket, 55mmL	C-48	420
408+1165	1/2" Dr. 1.0 x 6.5mm Slotted Bit Socket, 55mmL	C-48	420
408+1170	1/2" Dr. 1.2 x 7.0mm Slotted Bit Socket, 55mmL	C-48	420
408+1302	1/2" Dr. PH.2 Philips Bit Socket, 80mmL	C-48	460
408+1303	1/2" Dr. PH.3 Philips Bit Socket, 80mmL	C-48	460
408+1502	1/2" Dr. PH.2 Philips Bit Socket, 110mmL	C-48	600
408+1503	1/2" Dr. PH.3 Philips Bit Socket, 110mmL	C-48	600
408+1602	1/2" Dr. PH.2 Philips Bit Socket, 150mmL	C-48	640
408+1603	1/2" Dr. PH.3 Philips Bit Socket, 150mmL	C-48	640
408+1702	1/2" Dr. PH.2 Philips Bit Socket, 190mmL	C-48	720
408+1703	1/2" Dr. PH.3 Philips Bit Socket, 190mmL	C-48	720

Item No.	Description	Pg.	Code
408+1802	1/2" Dr. PH.2 Philips Bit Socket, 230mmL	C-48	790
408+1803	1/2" Dr. PH.3 Philips Bit Socket, 230mmL	C-48	790
408+2134	1/2" Dr. 4mm Hex Bit Socket, 55mmL	C-49	435
408+2135	1/2" Dr. 5mm Hex Bit Socket, 55mmL	C-49	435
408+2136	1/2" Dr. 6mm Hex Bit Socket, 55mmL	C-49	435
408+2334	1/2" Dr. 4mm Hex Bit Socket, 80mmL	C-49	460
408+2335	1/2" Dr. 5mm Hex Bit Socket, 80mmL	C-49	460
408+2336	1/2" Dr. 6mm Hex Bit Socket, 80mmL	C-49	460
408+2534	1/2" Dr. 4mm Hex Bit Socket, 110mmL	C-49	600
408+2535	1/2" Dr. 5mm Hex Bit Socket, 110mmL	C-49	600
408+2536	1/2" Dr. 6mm Hex Bit Socket, 110mmL	C-49	600
408+2634	1/2" Dr. 4mm Hex Bit Socket, 150mmL	C-49	640
408+2635	1/2" Dr. 5mm Hex Bit Socket, 150mmL	C-49	640
408+2636	1/2" Dr. 6mm Hex Bit Socket, 150mmL	C-49	640
408+2734	1/2" Dr. 4mm Hex Bit Socket, 190mmL	C-50	720
408+2735	1/2" Dr. 5mm Hex Bit Socket, 190mmL	C-50	720
408+2736	1/2" Dr. 6mm Hex Bit Socket, 190mmL	C-50	720
408+2836	1/2" Dr. 6mm Hex Bit Socket, 230mmL	C-50	940
408+3112	1/2" Dr. 3/16" Hex Bit Socket, 55mmL	C-50	420
408+3114	1/2" Dr. 7/32" Hex Bit Socket, 55mmL	C-50	420
408+3116	1/2" Dr. 1/4" Hex Bit Socket, 55mmL	C-50	420
408+3310	1/2" Dr. 5/32" Hex Bit Socket, 80mmL	C-50	460
408+3312	1/2" Dr. 3/16" Hex Bit Socket, 80mmL	C-50	460
408+3314	1/2" Dr. 7/32" Hex Bit Socket, 80mmL	C-50	460
408+3316	1/2" Dr. 1/4" Hex Bit Socket, 80mmL	C-50	460
408+3510	1/2" Dr. 5/32" Hex Bit Socket, 110mmL	C-51	600
408+3512	1/2" Dr. 3/16" Hex Bit Socket, 110mmL	C-51	600
408+3514	1/2" Dr. 7/32" Hex Bit Socket, 110mmL	C-51	600
408+3516	1/2" Dr. 1/4" Hex Bit Socket, 110mmL	C-51	600
408+3610	1/2" Dr. 5/32" Hex Bit Socket, 150mmL	C-51	640
408+3612	1/2" Dr. 3/16" Hex Bit Socket, 150mmL	C-51	640
408+3614	1/2" Dr. 7/32" Hex Bit Socket, 150mmL	C-51	640
408+3616	1/2" Dr. 1/4" Hex Bit Socket, 150mmL	C-51	640
408+3710	1/2" Dr. 5/32" Hex Bit Socket, 190mmL	C-51	720
408+3712	1/2" Dr. 3/16" Hex Bit Socket, 190mmL	C-51	720
408+3714	1/2" Dr. 7/32" Hex Bit Socket, 190mmL	C-51	720
408+3716	1/2" Dr. 1/4" Hex Bit Socket, 190mmL	C-51	720
408+3816	1/2" Dr. 1/4" Hex Bit Socket, 230mmL	C-51	790
408+4335	1/2" Dr. 5mm Wobble Hex Bit Socket, 80mmL	C-52	490
408+4336	1/2" Dr. 6mm Wobble Hex Bit Socket, 80mmL	C-52	490
408+4535	1/2" Dr. 5mm Wobble Hex Bit Socket, 110mmL	C-52	640
408+4536	1/2" Dr. 6mm Wobble Hex Bit Socket, 110mmL	C-52	640
408+4635	1/2" Dr. 5mm Wobble Hex Bit Socket, 150mmL	C-52	690
408+4636	1/2" Dr. 6mm Wobble Hex Bit Socket, 150mmL	C-52	690
408+4735	1/2" Dr. 5mm Wobble Hex Bit Socket, 190mmL	C-52	770
408+4736	1/2" Dr. 6mm Wobble Hex Bit Socket, 190mmL	C-52	770
408+4836	1/2" Dr. 6mm Wobble Hex Bit Socket, 230mmL	C-52	1000
408+5020	1/2" Dr. T-20 Pentacle Bit Socket, 55mmL	C-53	450
408+5025	1/2" Dr. T-25 Pentacle Bit Socket, 55mmL	C-53	450
408+5027	1/2" Dr. T-27 Pentacle Bit Socket, 55mmL	C-53	450
408+5030	1/2" Dr. T-30 Pentacle Bit Socket, 55mmL	C-53	450
408+5220	1/2" Dr. T-20 Pentacle Bit Socket, 80mmL	C-53	520
408+5225	1/2" Dr. T-25 Pentacle Bit Socket, 80mmL	C-53	520
408+5227	1/2" Dr. T-27 Pentacle Bit Socket, 80mmL	C-53	520
408+5230	1/2" Dr. T-30 Pentacle Bit Socket, 80mmL	C-53	520
408+5312	1/2" Dr. 3/16" Wobble Hex Bit Socket, 80mmL	C-52	490
408+5314	1/2" Dr. 7/32" Wobble Hex Bit Socket, 80mmL	C-52	490
408+5316	1/2" Dr. 1/4" Wobble Hex Bit Socket, 80mmL	C-52	490
408+5420	1/2" Dr. T-20 Pentacle Bit Socket, 110mmL	C-53	700
408+5425	1/2" Dr. T-25 Pentacle Bit Socket, 110mmL	C-53	700
408+5427	1/2" Dr. T-27 Pentacle Bit Socket, 110mmL	C-53	700
408+5430	1/2" Dr. T-30 Pentacle Bit Socket, 110mmL	C-53	700
408+5512	1/2" Dr. 3/16" Wobble Hex Bit Socket, 110mmL	C-52	640
408+5514	1/2" Dr. 7/32" Wobble Hex Bit Socket, 110mmL	C-52	640
408+5516	1/2" Dr. 1/4" Wobble Hex Bit Socket, 110mmL	C-52	640
408+5612	1/2" Dr. 3/16" Wobble Hex Bit Socket, 150mmL	C-52	690
408+5614	1/2" Dr. 7/32" Wobble Hex Bit Socket, 150mmL	C-52	690
408+5616	1/2" Dr. 1/4" Wobble Hex Bit Socket, 150mmL	C-52	690
408+5712	1/2" Dr. 3/16" Wobble Hex Bit Socket, 190mmL	C-52	770
408+5714	1/2" Dr. 7/32" Wobble Hex Bit Socket, 190mmL	C-52	770

Item No.	Description	Pg.	Code
408+5716	1/2" Dr. 1/4" Wobble Hex Bit Socket, 190mmL	C-52	770
408+5816	1/2" Dr. 1/4" Wobble Hex Bit Socket, 230mmL	C-52	1000
408+6120	1/2" Dr. T-20 Star Bit Socket, 55mmL	C-54	435
408+6125	1/2" Dr. T-25 Star Bit Socket, 55mmL	C-54	435
408+6127	1/2" Dr. T-27 Star Bit Socket, 55mmL	C-54	435
408+6130	1/2" Dr. T-30 Star Bit Socket, 55mmL	C-54	435
408+6140	1/2" Dr. T-40 Star Bit Socket, 55mmL	C-54	435
408+6320	1/2" Dr. T-20 Star Bit Socket, 80mmL	C-54	460
408+6325	1/2" Dr. T-25 Star Bit Socket, 80mmL	C-54	460
408+6327	1/2" Dr. T-27 Star Bit Socket, 80mmL	C-54	460
408+6330	1/2" Dr. T-30 Star Bit Socket, 80mmL	C-54	460
408+6340	1/2" Dr. T-40 Star Bit Socket, 80mmL	C-54	460
408+6520	1/2" Dr. T-20 Star Bit Socket, 110mmL	C-54	600
408+6525	1/2" Dr. T-25 Star Bit Socket, 110mmL	C-54	600
408+6527	1/2" Dr. T-27 Star Bit Socket, 110mmL	C-54	600
408+6530	1/2" Dr. T-30 Star Bit Socket, 110mmL	C-54	600
408+6540	1/2" Dr. T-40 Star Bit Socket, 110mmL	C-54	600
408+6620	1/2" Dr. T-20 Star Bit Socket, 150mmL	C-54	640
408+6625	1/2" Dr. T-25 Star Bit Socket, 150mmL	C-54	640
408+6627	1/2" Dr. T-27 Star Bit Socket, 150mmL	C-54	640
408+6630	1/2" Dr. T-30 Star Bit Socket, 150mmL	C-54	640
408+6640	1/2" Dr. T-40 Star Bit Socket, 150mmL	C-54	640
408+6720	1/2" Dr. T-20 Star Bit Socket, 190mmL	C-54	720
408+6725	1/2" Dr. T-25 Star Bit Socket, 190mmL	C-54	720
408+6727	1/2" Dr. T-27 Star Bit Socket, 190mmL	C-54	720
408+6730	1/2" Dr. T-30 Star Bit Socket, 190mmL	C-54	720
408+6740	1/2" Dr. T-40 Star Bit Socket, 190mmL	C-54	720
408+6830	1/2" Dr. T-30 Star Bit Socket, 230mmL	C-54	790
408+6840	1/2" Dr. T-40 Star Bit Socket, 230mmL	C-54	790
408+7120	1/2" Dr. T-20 Tamperproof Star Bit Socket, 55mmL	C-55	450
408+7125	1/2" Dr. T-25 Tamperproof Star Bit Socket, 55mmL	C-55	450
408+7127	1/2" Dr. T-27 Tamperproof Star Bit Socket, 55mmL	C-55	450
408+7130	1/2" Dr. T-30 Tamperproof Star Bit Socket, 55mmL	C-55	450
408+7140	1/2" Dr. T-40 Tamperproof Star Bit Socket, 55mmL	C-55	450
408+7320	1/2" Dr. T-20 Tamperproof Star Bit Socket, 80mmL	C-55	490
408+7325	1/2" Dr. T-25 Tamperproof Star Bit Socket, 80mmL	C-55	490
408+7327	1/2" Dr. T-27 Tamperproof Star Bit Socket, 80mmL	C-55	490
408+7330	1/2" Dr. T-30 Tamperproof Star Bit Socket, 80mmL	C-55	490
408+7340	1/2" Dr. T-40 Tamperproof Star Bit Socket, 80mmL	C-55	490
408+7520	1/2" Dr. T-20 Tamperproof Star Bit Socket, 110mmL	C-55	640
408+7525	1/2" Dr. T-25 Tamperproof Star Bit Socket, 110mmL	C-55	640
408+7527	1/2" Dr. T-27 Tamperproof Star Bit Socket, 110mmL	C-55	640
408+7530	1/2" Dr. T-30 Tamperproof Star Bit Socket, 110mmL	C-55	640
408+7540	1/2" Dr. T-40 Tamperproof Star Bit Socket, 110mmL	C-55	640
408+7620	1/2" Dr. T-20 Tamperproof Star Bit Socket, 150mmL	C-55	690
408+7625	1/2" Dr. T-25 Tamperproof Star Bit Socket, 150mmL	C-55	690
408+7627	1/2" Dr. T-27 Tamperproof Star Bit Socket, 150mmL	C-55	690
408+7630	1/2" Dr. T-30 Tamperproof Star Bit Socket, 150mmL	C-55	690
408+7640	1/2" Dr. T-40 Tamperproof Star Bit Socket, 150mmL	C-55	690
408+7720	1/2" Dr. T-20 Tamperproof Star Bit Socket, 190mmL	C-55	770
408+7725	1/2" Dr. T-25 Tamperproof Star Bit Socket, 190mmL	C-55	770
408+7727	1/2" Dr. T-27 Tamperproof Star Bit Socket, 190mmL	C-55	770
408+7730	1/2" Dr. T-30 Tamperproof Star Bit Socket, 190mmL	C-55	770
408+7740	1/2" Dr. T-40 Tamperproof Star Bit Socket, 190mmL	C-55	770
408+7830	1/2" Dr. T-30 Tamperproof Star Bit Socket, 230mmL	C-55	850
408+7840	1/2" Dr. T-40 Tamperproof Star Bit Socket, 230mmL	C-55	850
408+8104	1/2" Dr. M4 Triple Square Bit Socket, 55mmL	C-56	420
408+8105	1/2" Dr. M5 Triple Square Bit Socket, 55mmL	C-56	420
408+8106	1/2" Dr. M6 Triple Square Bit Socket, 55mmL	C-56	420
408+8304	1/2" Dr. M4 Triple Square Bit Socket, 80mmL	C-56	460
408+8305	1/2" Dr. M5 Triple Square Bit Socket, 80mmL	C-56	460
408+8306	1/2" Dr. M6 Triple Square Bit Socket, 80mmL	C-56	460
408+8504	1/2" Dr. M4 Triple Square Bit Socket, 110mmL	C-56	600
408+8505	1/2" Dr. M5 Triple Square Bit Socket, 110mmL	C-56	600
408+8506	1/2" Dr. M6 Triple Square Bit Socket, 110mmL	C-56	600
408+8604	1/2" Dr. M4 Triple Square Bit Socket, 150mmL	C-56	640
408+8605	1/2" Dr. M5 Triple Square Bit Socket, 150mmL	C-56	640
408+8606	1/2" Dr. M6 Triple Square Bit Socket, 150mmL	C-56	640
408+8704	1/2" Dr. M4 Triple Square Bit Socket, 190mmL	C-56	720
408+8705	1/2" Dr. M5 Triple Square Bit Socket, 190mmL	C-56	720

Item No.	Description	Pg.	Code
408+8706	1/2" Dr. M6 Triple Square Bit Socket, 190mmL	C-56	720
408+8806	1/2" Dr. M6 Triple Square Bit Socket, 230mmL	C-56	790
408+9004	1/2" Dr. M4 Ribe Bit Socket, 55mmL	C-53	420
408+9005	1/2" Dr. M5 Ribe Bit Socket, 55mmL	C-53	420
408+9006	1/2" Dr. M6 Ribe Bit Socket, 55mmL	C-53	420
408+9204	1/2" Dr. M4 Ribe Bit Socket, 80mmL	C-53	490
408+9205	1/2" Dr. M5 Ribe Bit Socket, 80mmL	C-53	490
408+9206	1/2" Dr. M6 Ribe Bit Socket, 80mmL	C-53	490
408+9404	1/2" Dr. M4 Ribe Bit Socket, 110mmL	C-53	660
408+9405	1/2" Dr. M5 Ribe Bit Socket, 110mmL	C-53	660
408+9406	1/2" Dr. M6 Ribe Bit Socket, 110mmL	C-53	660
408100	1/2" Dr. M8 x 1.00mm Stud Bolt Socket	J-19	500
408125	1/2" Dr. M8 x 1.25mm Stud Bolt Socket	J-19	500
410+	1/2" Dr. 5/16" Hex Shank Bit Holder, 38mmL	D-21	380
410+1124	1/2" Dr. PH.4 Philips Bit Socket, 55mmL	C-48	472
410+1280	1/2" Dr. 1.2 x 8.0mm Slotted Bit Socket, 55mmL	C-48	472
410+1290	1/2" Dr. 1.6 x 9.0mm Slotted Bit Socket, 55mmL	C-48	472
410+1404	1/2" Dr. PH.4 Philips Bit Socket, 80mmL	C-48	500
410+1480	1/2" Dr. 1.2 x 8.0mm Slotted Bit Socket, 80mmL	C-48	500
410+1490	1/2" Dr. 1.6 x 9.0mm Slotted Bit Socket, 80mmL	C-48	500
410+1504	1/2" Dr. PH.4 Philips Bit Socket, 110mmL	C-48	640
410+1580	1/2" Dr. 1.2 x 8.0mm Slotted Bit Socket, 110mmL	C-48	640
410+1590	1/2" Dr. 1.6 x 9.0mm Slotted Bit Socket, 110mmL	C-48	640
410+1604	1/2" Dr. PH.4 Philips Bit Socket, 150mmL	C-48	740
410+1680	1/2" Dr. 1.2 x 8.0mm Slotted Bit Socket, 150mmL	C-48	740
410+1690	1/2" Dr. 1.6 x 9.0mm Slotted Bit Socket, 150mmL	C-48	740
410+1704	1/2" Dr. PH.4 Philips Bit Socket, 190mmL	C-48	840
410+1780	1/2" Dr. 1.2 x 8.0mm Slotted Bit Socket, 190mmL	C-48	840
410+1790	1/2" Dr. 1.6 x 9.0mm Slotted Bit Socket, 190mmL	C-48	840
410+1804	1/2" Dr. PH.4 Philips Bit Socket, 230mmL	C-48	940
410+1880	1/2" Dr. 1.2 x 8.0mm Slotted Bit Socket, 230mmL	C-48	940
410+1890	1/2" Dr. 1.6 x 9.0mm Slotted Bit Socket, 230mmL	C-48	940
410+2147	1/2" Dr. 7mm Hex Bit Socket, 55mmL	C-49	472
410+2148	1/2" Dr. 8mm Hex Bit Socket, 55mmL	C-49	472
410+2347	1/2" Dr. 7mm Hex Bit Socket, 80mmL	C-49	500
410+2348	1/2" Dr. 8mm Hex Bit Socket, 80mmL	C-49	500
410+2547	1/2" Dr. 7mm Hex Bit Socket, 110mmL	C-49	640
410+2548	1/2" Dr. 8mm Hex Bit Socket, 110mmL	C-49	640
410+2647	1/2" Dr. 7mm Hex Bit Socket, 150mmL	C-49	760
410+2648	1/2" Dr. 8mm Hex Bit Socket, 150mmL	C-49	760
410+2747	1/2" Dr. 7mm Hex Bit Socket, 190mmL	C-50	840
410+2748	1/2" Dr. 8mm Hex Bit Socket, 190mmL	C-50	840
410+2847	1/2" Dr. 7mm Hex Bit Socket, 230mmL	C-50	940
410+2848	1/2" Dr. 8mm Hex Bit Socket, 230mmL	C-50	940
410+3128	1/2" Dr. 9/32" Hex Bit Socket, 55mmL	C-50	472
410+3130	1/2" Dr. 5/16" Hex Bit Socket, 55mmL	C-50	472
410+3318	1/2" Dr. 9/32" Hex Bit Socket, 80mmL	C-50	500
410+3320	1/2" Dr. 5/16" Hex Bit Socket, 80mmL	C-50	500
410+3518	1/2" Dr. 9/32" Hex Bit Socket, 110mmL	C-51	640
410+3520	1/2" Dr. 5/16" Hex Bit Socket, 110mmL	C-51	640
410+3618	1/2" Dr. 9/32" Hex Bit Socket, 150mmL	C-51	740
410+3620	1/2" Dr. 5/16" Hex Bit Socket, 150mmL	C-51	740
410+3718	1/2" Dr. 9/32" Hex Bit Socket, 190mmL	C-51	840
410+3720	1/2" Dr. 5/16" Hex Bit Socket, 190mmL	C-51	840
410+3818	1/2" Dr. 9/32" Hex Bit Socket, 230mmL	C-51	940
410+3820	1/2" Dr. 5/16" Hex Bit Socket, 230mmL	C-51	940
410+4347	1/2" Dr. 7mm Wobble Hex Bit Socket, 80mmL	C-52	530
410+4348	1/2" Dr. 8mm Wobble Hex Bit Socket, 80mmL	C-52	530
410+4547	1/2" Dr. 7mm Wobble Hex Bit Socket, 110mmL	C-52	680
410+4548	1/2" Dr. 8mm Wobble Hex Bit Socket, 110mmL	C-52	680
410+4647	1/2" Dr. 7mm Wobble Hex Bit Socket, 150mmL	C-52	790
410+4648	1/2" Dr. 8mm Wobble Hex Bit Socket, 150mmL	C-52	790
410+4747	1/2" Dr. 7mm Wobble Hex Bit Socket, 190mmL	C-52	900
410+4748	1/2" Dr. 8mm Wobble Hex Bit Socket, 190mmL	C-52	900
410+4847	1/2" Dr. 7mm Wobble Hex Bit Socket, 230mmL	C-52	1000
410+4848	1/2" Dr. 8mm Wobble Hex Bit Socket, 230mmL	C-52	1000
410+5040	1/2" Dr. T-40 Pentacle Bit Socket, 55mmL	C-53	490
410+5045	1/2" Dr. T-45 Pentacle Bit Socket, 55mmL	C-53	490
410+5240	1/2" Dr. T-40 Pentacle Bit Socket, 80mmL	C-53	570
410+5245	1/2" Dr. T-45 Pentacle Bit Socket, 80mmL	C-53	570

Item No.	Description	Pg.	Code	Item No.	Description	Pg.	Code
410+5318	1/2" Dr. 9/32" Wobble Hex Bit Socket, 80mmL	C-52	530	413808	1/2" Dr. 8mm Impact Socket	A-17	210
410+5320	1/2" Dr. 5/16" Wobble Hex Bit Socket, 80mmL	C-52	530	413809	1/2" Dr. 9mm Impact Socket	A-17	210
410+5440	1/2" Dr. T-40 Pentacle Bit Socket, 110mmL	C-53	750	413810	1/2" Dr. 10mm Impact Socket	A-17	210
410+5445	1/2" Dr. T-45 Pentacle Bit Socket, 110mmL	C-53	750	413811	1/2" Dr. 11mm Impact Socket	A-17	210
410+5518	1/2" Dr. 9/32" Wobble Hex Bit Socket, 110mmL	C-52	680	413812	1/2" Dr. 12mm Impact Socket	A-17	210
410+5520	1/2" Dr. 5/16" Wobble Hex Bit Socket, 110mmL	C-52	680	413813	1/2" Dr. 13mm Impact Socket	A-17	210
410+5618	1/2" Dr. 9/32" Wobble Hex Bit Socket, 150mmL	C-52	790	413814	1/2" Dr. 14mm Impact Socket	A-17	210
410+5620	1/2" Dr. 5/16" Wobble Hex Bit Socket, 150mmL	C-52	790	413815	1/2" Dr. 15mm Impact Socket	A-17	210
410+5718	1/2" Dr. 9/32" Wobble Hex Bit Socket, 190mmL	C-52	900	413816	1/2" Dr. 16mm Impact Socket	A-17	210
410+5720	1/2" Dr. 5/16" Wobble Hex Bit Socket, 190mmL	C-52	900	413817	1/2" Dr. 17mm Impact Socket	A-17	210
410+5818	1/2" Dr. 9/32" Wobble Hex Bit Socket, 230mmL	C-52	1000	413818	1/2" Dr. 18mm Impact Socket	A-17	240
410+5820	1/2" Dr. 5/16" Wobble Hex Bit Socket, 230mmL	C-52	1000	413819	1/2" Dr. 19mm Impact Socket	A-17	240
410+6245	1/2" Dr. T-45 Star Bit Socket, 55mmL	C-54	472	413820	1/2" Dr. 20mm Impact Socket	A-17	265
410+6250	1/2" Dr. T-50 Star Bit Socket, 55mmL	C-54	472	413821	1/2" Dr. 21mm Impact Socket	A-17	265
410+6345	1/2" Dr. T-45 Star Bit Socket, 80mmL	C-54	500	413822	1/2" Dr. 22mm Impact Socket	A-17	300
410+6350	1/2" Dr. T-50 Star Bit Socket, 80mmL	C-54	500	413823	1/2" Dr. 23mm Impact Socket	A-17	330
410+6545	1/2" Dr. T-45 Star Bit Socket, 110mmL	C-54	640	413824	1/2" Dr. 24mm Impact Socket	A-17	360
410+6550	1/2" Dr. T-50 Star Bit Socket, 110mmL	C-54	640	413825	1/2" Dr. 25mm Impact Socket	A-17	400
410+6645	1/2" Dr. T-45 Star Bit Socket, 150mmL	C-54	740	413826	1/2" Dr. 26mm Impact Socket	A-17	445
410+6650	1/2" Dr. T-50 Star Bit Socket, 150mmL	C-54	740	413827	1/2" Dr. 27mm Impact Socket	A-17	445
410+6745	1/2" Dr. T-45 Star Bit Socket, 190mmL	C-54	840	413828	1/2" Dr. 28mm Impact Socket	A-17	565
410+6750	1/2" Dr. T-50 Star Bit Socket, 190mmL	C-54	840	413829	1/2" Dr. 29mm Impact Socket	A-17	565
410+6845	1/2" Dr. T-45 Star Bit Socket, 230mmL	C-54	940	413830	1/2" Dr. 30mm Impact Socket	A-17	565
410+6850	1/2" Dr. T-50 Star Bit Socket, 230mmL	C-54	940	413831	1/2" Dr. 31mm Impact Socket	A-17	620
410+7145	1/2" Dr. T-45 Tamperproof Star Bit Socket, 55mmL	C-55	500	413832	1/2" Dr. 32mm Impact Socket	A-17	620
410+7150	1/2" Dr. T-50 Tamperproof Star Bit Socket, 55mmL	C-55	500	414+	1/2" Dr. 7/16" Hex Shank Bit Holder, 40mmL	D-21	400
410+7345	1/2" Dr. T-45 Tamperproof Star Bit Socket, 80mmL	C-55	530	414+3138	1/2" Dr. 7/16" Hex Bit Socket, 55mmL	C-50	580
410+7350	1/2" Dr. T-50 Tamperproof Star Bit Socket, 80mmL	C-55	530	414+3328	1/2" Dr. 7/16" Hex Bit Socket, 80mmL	C-50	640
410+7545	1/2" Dr. T-45 Tamperproof Star Bit Socket, 110mmL	C-55	680	414+3528	1/2" Dr. 7/16" Hex Bit Socket, 110mmL	C-51	900
410+7550	1/2" Dr. T-50 Tamperproof Star Bit Socket, 110mmL	C-55	680	414+3628	1/2" Dr. 7/16" Hex Bit Socket, 150mmL	C-51	1110
410+7645	1/2" Dr. T-45 Tamperproof Star Bit Socket, 150mmL	C-55	790	414+3728	1/2" Dr. 7/16" Hex Bit Socket, 190mmL	C-51	1240
410+7650	1/2" Dr. T-50 Tamperproof Star Bit Socket, 150mmL	C-55	790	414+3828	1/2" Dr. 7/16" Hex Bit Socket, 230mmL	C-51	1360
410+7745	1/2" Dr. T-45 Tamperproof Star Bit Socket, 190mmL	C-55	900	414150	1/2" Dr. M14 x 1.50mm Stud Bolt Socket	J-19	580
410+7750	1/2" Dr. T-50 Tamperproof Star Bit Socket, 190mmL	C-55	900	414200	1/2" Dr. M14 x 2.00mm Stud Bolt Socket	J-19	580
410+7845	1/2" Dr. T-45 Tamperproof Star Bit Socket, 230mmL	C-55	1000	4147	5/16" Hex Shank, 7mm Wobble Hex Hex Screwdriver Bit, 30mmL	D-8	125
410+7850	1/2" Dr. T-50 Tamperproof Star Bit Socket, 230mmL	C-55	1000	4148	5/16" Hex Shank, 8mm Wobble Hex Hex Screwdriver Bit, 30mmL	D-8	125
410+8108	1/2" Dr. M8 Triple Square Bit Socket, 55mmL	C-56	460	4149	9mm Hex Shank, 9mm Wobble Hex Hex Screwdriver Bit, 30mmL	D-8	180
410+8308	1/2" Dr. M8 Triple Square Bit Socket, 80mmL	C-56	500	4150	10mm Hex Shank, 10mm Wobble Hex Hex Screwdriver Bit, 30mmL	D-8	180
410+8508	1/2" Dr. M8 Triple Square Bit Socket, 110mmL	C-56	640	416+	1/2" Dr. 1/2" Hex Shank Bit Holder, 40mmL	D-21	400
410+8608	1/2" Dr. M8 Triple Square Bit Socket, 150mmL	C-56	740	416+3142	1/2" Dr. 1/2" Hex Bit Socket, 55mmL	C-50	620
410+8708	1/2" Dr. M8 Triple Square Bit Socket, 190mmL	C-56	840	416+3332	1/2" Dr. 1/2" Hex Bit Socket, 80mmL	C-50	670
410+8808	1/2" Dr. M8 Triple Square Bit Socket, 230mmL	C-56	940	416+3532	1/2" Dr. 1/2" Hex Bit Socket, 110mmL	C-51	1040
410+9007	1/2" Dr. M7 Ribe Bit Socket, 55mmL	C-53	460	416+3632	1/2" Dr. 1/2" Hex Bit Socket, 150mmL	C-51	1260
410+9008	1/2" Dr. M8 Ribe Bit Socket, 55mmL	C-53	460	416+3732	1/2" Dr. 1/2" Hex Bit Socket, 190mmL	C-51	1410
410+9207	1/2" Dr. M7 Ribe Bit Socket, 80mmL	C-53	540	416+3832	1/2" Dr. 1/2" Hex Bit Socket, 230mmL	C-51	1560
410+9208	1/2" Dr. M8 Ribe Bit Socket, 80mmL	C-53	540	41601719	1/2" Dr. 17mm x 19mm Flip Socket	J-19	465
410+9407	1/2" Dr. M7 Ribe Bit Socket, 110mmL	C-53	700	416150	1/2" Dr. M16 x 1.50mm Stud Bolt Socket	J-19	580
410+9408	1/2" Dr. M8 Ribe Bit Socket, 110mmL	C-53	700	416200	1/2" Dr. M16 x 2.00mm Stud Bolt Socket	J-19	580
410100	1/2" Dr. M10 x 1.00mm Stud Bolt Socket	J-19	500	41651921	1/2" Dr. 19mm x 21mm Flip Socket	J-19	465
410125	1/2" Dr. M10 x 1.25mm Stud Bolt Socket	J-19	500	417808	1/2" Dr. 8mm Deep Impact Socket	A-18	335
410150	1/2" Dr. M10 x 1.50mm Stud Bolt Socket	J-19	500	417809	1/2" Dr. 9mm Deep Impact Socket	A-18	335
412+	1/2" Dr. 3/8" Hex Shank Bit Holder, 40mmL	D-21	400	417810	1/2" Dr. 10mm Deep Impact Socket	A-18	335
412+3134	1/2" Dr. 3/8" Hex Bit Socket, 55mmL	C-50	540	417811	1/2" Dr. 11mm Deep Impact Socket	A-18	335
412+3324	1/2" Dr. 3/8" Hex Bit Socket, 80mmL	C-50	580	417812	1/2" Dr. 12mm Deep Impact Socket	A-18	335
412+3524	1/2" Dr. 3/8" Hex Bit Socket, 110mmL	C-51	760	417813	1/2" Dr. 13mm Deep Impact Socket	A-18	335
412+3624	1/2" Dr. 3/8" Hex Bit Socket, 150mmL	C-51	960	417814	1/2" Dr. 14mm Deep Impact Socket	A-18	335
412+3724	1/2" Dr. 3/8" Hex Bit Socket, 190mmL	C-51	1060	417815	1/2" Dr. 15mm Deep Impact Socket	A-18	360
412+3824	1/2" Dr. 3/8" Hex Bit Socket, 230mmL	C-51	1140	417816	1/2" Dr. 16mm Deep Impact Socket	A-18	385
412+5324	1/2" Dr. 3/8" Wobble Hex Bit Socket, 80mmL	C-52	610	417817	1/2" Dr. 17mm Deep Impact Socket	A-18	405
412+5524	1/2" Dr. 3/8" Wobble Hex Bit Socket, 110mmL	C-52	800	417818	1/2" Dr. 18mm Deep Impact Socket	A-18	420
412+5624	1/2" Dr. 3/8" Wobble Hex Bit Socket, 150mmL	C-52	1010	417819	1/2" Dr. 19mm Deep Impact Socket	A-18	450
412+5724	1/2" Dr. 3/8" Wobble Hex Bit Socket, 190mmL	C-52	1120	417820	1/2" Dr. 20mm Deep Impact Socket	A-18	495
412+5824	1/2" Dr. 3/8" Wobble Hex Bit Socket, 230mmL	C-52	1220	417821	1/2" Dr. 21mm Deep Impact Socket	A-18	495
412125	1/2" Dr. M12 x 1.25mm Stud Bolt Socket	J-19	500	417822	1/2" Dr. 22mm Deep Impact Socket	A-18	520
412150	1/2" Dr. M12 x 1.50mm Stud Bolt Socket	J-19	500	417823	1/2" Dr. 23mm Deep Impact Socket	A-18	545
412175	1/2" Dr. M12 x 1.75mm Stud Bolt Socket	J-19	500	417824	1/2" Dr. 24mm Deep Impact Socket	A-18	570
4133	1/4" Hex Shank, 3mm Wobble Hex Hex Screwdriver Bit, 30mmL	D-8	85	417825	1/2" Dr. 25mm Deep Impact Socket	A-18	685
4134	1/4" Hex Shank, 4mm Wobble Hex Hex Screwdriver Bit, 30mmL	D-8	85	417826	1/2" Dr. 26mm Deep Impact Socket	A-18	765
4135	1/4" Hex Shank, 5mm Wobble Hex Hex Screwdriver Bit, 30mmL	D-8	85	417827	1/2" Dr. 27mm Deep Impact Socket	A-18	765
4136	1/4" Hex Shank, 6mm Wobble Hex Hex Screwdriver Bit, 30mmL	D-8	85	417828	1/2" Dr. 28mm Deep Impact Socket	A-18	825



Item No.	Description	Pg.	Code
417829	1/2" Dr. 29mm Deep Impact Socket	A-18	825
417830	1/2" Dr. 30mm Deep Impact Socket	A-18	825
417831	1/2" Dr. 31mm Deep Impact Socket	A-18	885
417832	1/2" Dr. 32mm Deep Impact Socket	A-18	885
417M055	1/2" Dr. 17mm Torque Socket, 55 ft.lbs.(75Nm)	J-11	2760
417M080	1/2" Dr. 17mm Torque Socket, 80 ft.lbs.(108Nm)	J-11	2760
418+	1/2" Dr. 9/16" Hex Shank Bit Holder, 40mmL	D-21	400
418+3336	1/2" Dr. 9/16" Hex Bit Socket, 80mmL	C-50	700
418+3536	1/2" Dr. 9/16" Hex Bit Socket, 110mmL	C-51	1100
418+3636	1/2" Dr. 9/16" Hex Bit Socket, 150mmL	C-51	1340
418+3736	1/2" Dr. 9/16" Hex Bit Socket, 190mmL	C-51	1500
418+3836	1/2" Dr. 9/16" Hex Bit Socket, 230mmL	C-51	1660
418516	1/2" Dr. 16.0mm(5/8") Swivel Spark Plug Socket	B-43	1700
418521	1/2" Dr. 20.6mm(13/16") Swivel Spark Plug Socket	B-43	1800
419M065	1/2" Dr. 19mm(3/4") Torque Socket, 65 ft.lbs.(88Nm)	J-11	2760
419M080	1/2" Dr. 19mm(3/4") Torque Socket, 80 ft.lbs.(108Nm)	J-11	2760
419M100	1/2" Dr. 19mm(3/4") Torque Socket, 100 ft.lbs.(135Nm)	J-11	2760
420+	1/2" Dr. 5/8" Hex Shank Bit Holder, 40mmL	D-21	430
420+3340	1/2" Dr. 5/8" Hex Bit Socket, 80mmL	C-50	800
420+3540	1/2" Dr. 5/8" Hex Bit Socket, 110mmL	C-51	1160
420+3640	1/2" Dr. 5/8" Hex Bit Socket, 150mmL	C-51	1440
420+3740	1/2" Dr. 5/8" Hex Bit Socket, 190mmL	C-51	1620
420+3840	1/2" Dr. 5/8" Hex Bit Socket, 230mmL	C-51	1790
420002B	1/2" Dr. Wobble Extension Bar, 50mmL	B-46	650
420003B	1/2" Dr. Wobble Extension Bar, 75mmL	B-46	670
420005B	1/2" Dr. Wobble Extension Bar, 125mmL	B-46	820
420008B	1/2" Dr. Wobble Extension Bar, 200mmL	B-46	1050
420010B	1/2" Dr. Wobble Extension Bar, 250mmL	B-46	1320
420015B	1/2" Dr. Wobble Extension Bar, 375mmL	B-46	2000
420024B	1/2" Dr. Wobble Extension Bar, 600mmL	B-46	3170
420033	1/2" Dr. Adapter 1/2"F x 3/8"M	B-42	360
420066	1/2" Dr. Adapter 1/2"F x 3/4"M	B-42	550
420260L	1/2" Dr. L-Handle	B-43	1300
421M060	1/2" Dr. 21mm Torque Socket, 60 ft.lbs.(81Nm)	J-11	2760
421M080	1/2" Dr. 21mm Torque Socket, 80 ft.lbs.(108Nm)	J-11	2760
421M147D	1/2" Dr. 21mm Torque Socket, 147 ft.lbs.(200Nm)	J-11	2880
422+	1/2" Dr. 11/16" Hex Shank Bit Holder, 40mmL	D-21	450
422+3344	1/2" Dr. 11/16" Hex Bit Socket, 80mmL	C-50	890
422+3544	1/2" Dr. 11/16" Hex Bit Socket, 110mmL	C-51	1230
422+3644	1/2" Dr. 11/16" Hex Bit Socket, 150mmL	C-51	1570
422+3744	1/2" Dr. 11/16" Hex Bit Socket, 190mmL	C-51	1750
422+3844	1/2" Dr. 11/16" Hex Bit Socket, 230mmL	C-51	1930
422M120D	1/2" Dr. 22mm Torque Socket, 120 ft.lbs.(163Nm)	J-11	2880
422M140D	1/2" Dr. 22mm Torque Socket, 140 ft.lbs.(190Nm)	J-11	2880
423504T	1/2" Dr. T-Handle (Ball Joint), 350mmL	B-43	1500
4238014T	1/2" Dr. 14.0mm T-Handle Spark Plug Socket, 380mmL	B-43	1600
4238016T	1/2" Dr. 16.0mm T-Handle Spark Plug Socket, 380mmL	B-43	1600
4238021T	1/2" Dr. 20.6mm T-Handle Spark Plug Socket, 380mmL	B-43	1600
423808	1/2" Dr. 8mm Hand Socket	B-38	300
423809	1/2" Dr. 9mm Hand Socket	B-38	300
423810	1/2" Dr. 10mm Hand Socket	B-38	300
423811	1/2" Dr. 11mm Hand Socket	B-38	300
423812	1/2" Dr. 12mm Hand Socket	B-38	300
423813	1/2" Dr. 13mm Hand Socket	B-38	300
423814	1/2" Dr. 14mm Hand Socket	B-38	300
423815	1/2" Dr. 15mm Hand Socket	B-38	315
423816	1/2" Dr. 16mm Hand Socket	B-38	345
423817	1/2" Dr. 17mm Hand Socket	B-38	365
423818	1/2" Dr. 18mm Hand Socket	B-38	385
423819	1/2" Dr. 19mm Hand Socket	B-38	405
423820	1/2" Dr. 20mm Hand Socket	B-38	425
423821	1/2" Dr. 21mm Hand Socket	B-38	450
423822	1/2" Dr. 22mm Hand Socket	B-38	470
423823	1/2" Dr. 23mm Hand Socket	B-38	490
423824	1/2" Dr. 24mm Hand Socket	B-38	510
423825	1/2" Dr. 25mm Hand Socket	B-38	525
423826	1/2" Dr. 26mm Hand Socket	B-38	555
423827	1/2" Dr. 27mm Hand Socket	B-38	580
423828	1/2" Dr. 28mm Hand Socket	B-38	660
423829	1/2" Dr. 29mm Hand Socket	B-38	685

Item No.	Description	Pg.	Code
423830	1/2" Dr. 30mm Hand Socket	B-38	700
423831	1/2" Dr. 31mm Hand Socket	B-38	755
423832	1/2" Dr. 32mm Hand Socket	B-38	755
423833	1/2" Dr. 33mm Hand Socket	B-38	1000
423834	1/2" Dr. 34mm Hand Socket	B-38	1000
423835	1/2" Dr. 35mm Hand Socket	B-38	1000
423836	1/2" Dr. 36mm Hand Socket	B-38	1000
423837	1/2" Dr. 37mm Hand Socket	B-38	1000
423838	1/2" Dr. 38mm Hand Socket	B-38	1000
423839	1/2" Dr. 39mm Hand Socket	B-38	1170
423840	1/2" Dr. 40mm Hand Socket	B-38	1260
423841	1/2" Dr. 41mm Hand Socket	B-38	1350
424+	1/2" Dr. 3/4" Hex Shank Bit Holder, 40mmL	D-21	500
424+3348	1/2" Dr. 3/4" Hex Bit Socket, 80mmL	C-50	990
424+3548	1/2" Dr. 3/4" Hex Bit Socket, 110mmL	C-51	1370
424+3648	1/2" Dr. 3/4" Hex Bit Socket, 150mmL	C-51	1760
424+3748	1/2" Dr. 3/4" Hex Bit Socket, 190mmL	C-51	1970
424+3848	1/2" Dr. 3/4" Hex Bit Socket, 230mmL	C-51	2170
424050	1/2" Dr. Extension Bar, 50mmL	B-46	490
424075	1/2" Dr. Extension Bar, 75mmL	B-46	525
424110	1/2" Dr. 10mm Hex Shank Bit Holder(quick change), 41mmL	B-42	620
424111	1/2" Dr. 11mm Hex Shank Bit Holder, 41mmL	D-21	620
424125	1/2" Dr. Extension Bar, 125mmL	B-46	590
424312	1/2" Dr. 12mm Hex Shank Bit Holder(quick change), 43mmL	B-42	660
424320	1/2" Dr. Extension Bar, 250mmL	B-46	825
424514	1/2" Dr. 14mm Hex Shank Bit Holder(quick change), 45mmL	B-42	700
425004	1/2" Dr. T-Handle (Quick Release), 500mmL	B-43	2350
425004T	1/2" Dr. T-Handle (Ball Joint), 500mmL	B-43	1700
425004U	1/2" Dr. T-Handle (Universal Joint), 500mmL	B-43	2350
4253014T	1/2" Dr. 14.0mm T-Handle Spark Plug Socket, 530mmL	B-43	1800
4253016T	1/2" Dr. 16.0mm T-Handle Spark Plug Socket, 530mmL	B-43	1800
4253021T	1/2" Dr. 20.6mm T-Handle Spark Plug Socket, 530mmL	B-43	1800
426306	1/2" Dr. 6mm Stud Remover Socket	J-20	1105
426308	1/2" Dr. 8mm Stud Remover Socket	J-20	1105
426S100	1/2" Dr. 13/16" Torque Socket, 100 ft.lbs.(135Nm)	J-11	2760
427004	1/2" Dr. T-Handle (Quick Release), 700mmL	B-43	2600
427004U	1/2" Dr. T-Handle (Universal Joint), 700mmL	B-43	2600
427016	1/2" Dr. 16mm(5/8") Spark Plug Socket	B-43	565
427021	1/2" Dr. 20.6mm(13/16") Spark Plug Socket	B-43	655
427410	1/2" Dr. 10mm Stud Remover Socket	J-20	1130
427412	1/2" Dr. 12mm Stud Remover Socket	J-20	1130
427413	1/2" Dr. 13mm Stud Remover Socket	J-20	1150
427414	1/2" Dr. 14mm Stud Remover Socket	J-20	1200
427416	1/2" Dr. 16mm Stud Remover Socket	J-20	1200
427808	1/2" Dr. 8mm Deep Hand Socket	B-39	540
427809	1/2" Dr. 9mm Deep Hand Socket	B-39	540
427810	1/2" Dr. 10mm Deep Hand Socket	B-39	540
427811	1/2" Dr. 11mm Deep Hand Socket	B-39	540
427812	1/2" Dr. 12mm Deep Hand Socket	B-39	540
427813	1/2" Dr. 13mm Deep Hand Socket	B-39	540
427814	1/2" Dr. 14mm Deep Hand Socket	B-39	540
427815	1/2" Dr. 15mm Deep Hand Socket	B-39	540
427816	1/2" Dr. 16mm Deep Hand Socket	B-39	540
427817	1/2" Dr. 17mm Deep Hand Socket	B-39	565
427818	1/2" Dr. 18mm Deep Hand Socket	B-39	590
427819	1/2" Dr. 19mm Deep Hand Socket	B-39	615
427820	1/2" Dr. 20mm Deep Hand Socket	B-39	645
427821	1/2" Dr. 21mm Deep Hand Socket	B-39	645
427822	1/2" Dr. 22mm Deep Hand Socket	B-39	710
427823	1/2" Dr. 23mm Deep Hand Socket	B-39	775
427824	1/2" Dr. 24mm Deep Hand Socket	B-39	775
427825	1/2" Dr. 25mm Deep Hand Socket	B-39	895
427826	1/2" Dr. 26mm Deep Hand Socket	B-39	895
427827	1/2" Dr. 27mm Deep Hand Socket	B-39	930
427828	1/2" Dr. 28mm Deep Hand Socket	B-39	1050
427829	1/2" Dr. 29mm Deep Hand Socket	B-39	1050
427830	1/2" Dr. 30mm Deep Hand Socket	B-39	1135
427831	1/2" Dr. 31mm Deep Hand Socket	B-39	1220
427832	1/2" Dr. 32mm Deep Hand Socket	B-39	1220
427833	1/2" Dr. 33mm Deep Hand Socket	B-39	1400

Item No.	Description	Pg.	Code	Item No.	Description	Pg.	Code
427834	1/2" Dr. 34mm Deep Hand Socket	B-39	1450	437826	1/2" Dr. 26mm Deep Hand Socket (12-Point)	B-41	895
427835	1/2" Dr. 35mm Deep Hand Socket	B-39	1450	437827	1/2" Dr. 27mm Deep Hand Socket (12-Point)	B-41	930
427836	1/2" Dr. 36mm Deep Hand Socket	B-39	1450	437828	1/2" Dr. 28mm Deep Hand Socket (12-Point)	B-41	1050
427837	1/2" Dr. 37mm Deep Hand Socket	B-39	1450	437829	1/2" Dr. 29mm Deep Hand Socket (12-Point)	B-41	1050
427838	1/2" Dr. 38mm Deep Hand Socket	B-39	1450	437830	1/2" Dr. 30mm Deep Hand Socket (12-Point)	B-41	1135
427839	1/2" Dr. 39mm Deep Hand Socket	B-39	1550	437831	1/2" Dr. 31mm Deep Hand Socket (12-Point)	B-41	1220
427840	1/2" Dr. 40mm Deep Hand Socket	B-39	1550	437832	1/2" Dr. 32mm Deep Hand Socket (12-Point)	B-41	1220
427841	1/2" Dr. 41mm Deep Hand Socket	B-39	1550	437833	1/2" Dr. 33mm Deep Hand Socket (12-Point)	B-41	1400
430S140D	1/2" Dr. 15/16" Torque Socket, 140 ft.lbs.(190Nm)	J-11	2880	437834	1/2" Dr. 34mm Deep Hand Socket (12-Point)	B-41	1450
4333	1/4" Hex Shank, 3mm Wobble Hex Hex Screwdriver Bit, 56mmL	D-8	150	437835	1/2" Dr. 35mm Deep Hand Socket (12-Point)	B-41	1450
4334	1/4" Hex Shank, 4mm Wobble Hex Hex Screwdriver Bit, 56mmL	D-8	150	437836	1/2" Dr. 36mm Deep Hand Socket (12-Point)	B-41	1450
4335	1/4" Hex Shank, 5mm Wobble Hex Hex Screwdriver Bit, 56mmL	D-8	150	437837	1/2" Dr. 37mm Deep Hand Socket (12-Point)	B-41	1450
4336	1/4" Hex Shank, 6mm Wobble Hex Hex Screwdriver Bit, 56mmL	D-8	150	437838	1/2" Dr. 38mm Deep Hand Socket (12-Point)	B-41	1450
433808	1/2" Dr. 8mm Hand Socket (12-Point)	B-40	300	437839	1/2" Dr. 39mm Deep Hand Socket (12-Point)	B-41	1550
433809	1/2" Dr. 9mm Hand Socket (12-Point)	B-40	300	437840	1/2" Dr. 40mm Deep Hand Socket (12-Point)	B-41	1550
433810	1/2" Dr. 10mm Hand Socket (12-Point)	B-40	300	437841	1/2" Dr. 41mm Deep Hand Socket (12-Point)	B-41	1550
433811	1/2" Dr. 11mm Hand Socket (12-Point)	B-40	300	439+	1/2" Dr. 9mm Hex Shank Bit Holder, 40mmL	D-21	400
433812	1/2" Dr. 12mm Hand Socket (12-Point)	B-40	300	439+2149	1/2" Dr. 9mm Hex Bit Socket, 55mmL	C-49	550
433813	1/2" Dr. 13mm Hand Socket (12-Point)	B-40	300	439+2349	1/2" Dr. 9mm Hex Bit Socket, 80mmL	C-49	580
433814	1/2" Dr. 14mm Hand Socket (12-Point)	B-40	300	439+2549	1/2" Dr. 9mm Hex Bit Socket, 110mmL	C-49	760
433815	1/2" Dr. 15mm Hand Socket (12-Point)	B-40	315	439+2649	1/2" Dr. 9mm Hex Bit Socket, 150mmL	C-49	960
433816	1/2" Dr. 16mm Hand Socket (12-Point)	B-40	345	439+2749	1/2" Dr. 9mm Hex Bit Socket, 190mmL	C-50	1060
433817	1/2" Dr. 17mm Hand Socket (12-Point)	B-40	365	439+2849	1/2" Dr. 9mm Hex Bit Socket, 230mmL	C-50	1160
433818	1/2" Dr. 18mm Hand Socket (12-Point)	B-40	385	439+4349	1/2" Dr. 9mm Wobble Hex Bit Socket, 80mmL	C-52	610
433819	1/2" Dr. 19mm Hand Socket (12-Point)	B-40	405	439+4549	1/2" Dr. 9mm Wobble Hex Bit Socket, 110mmL	C-52	800
433820	1/2" Dr. 20mm Hand Socket (12-Point)	B-40	425	439+4649	1/2" Dr. 9mm Wobble Hex Bit Socket, 150mmL	C-52	1010
433821	1/2" Dr. 21mm Hand Socket (12-Point)	B-40	450	439+4749	1/2" Dr. 9mm Wobble Hex Bit Socket, 190mmL	C-52	1120
433822	1/2" Dr. 22mm Hand Socket (12-Point)	B-40	470	439+4849	1/2" Dr. 9mm Wobble Hex Bit Socket, 230mmL	C-52	1220
433823	1/2" Dr. 23mm Hand Socket (12-Point)	B-40	490	440+	1/2" Dr. 10mm Hex Shank Bit Holder, 40mmL	D-21	400
433824	1/2" Dr. 24mm Hand Socket (12-Point)	B-40	510	440+1292	1/2" Dr. 2.0 x 12.0mm Slotted Bit Socket, 60mmL	C-48	540
433825	1/2" Dr. 25mm Hand Socket (12-Point)	B-40	525	440+1492	1/2" Dr. 2.0 x 12.0mm Slotted Bit Socket, 80mmL	C-48	580
433826	1/2" Dr. 26mm Hand Socket (12-Point)	B-40	555	440+1592	1/2" Dr. 2.0 x 12.0mm Slotted Bit Socket, 110mmL	C-48	760
433827	1/2" Dr. 27mm Hand Socket (12-Point)	B-40	580	440+1692	1/2" Dr. 2.0 x 12.0mm Slotted Bit Socket, 150mmL	C-48	960
433828	1/2" Dr. 28mm Hand Socket (12-Point)	B-40	660	440+1792	1/2" Dr. 2.0 x 12.0mm Slotted Bit Socket, 190mmL	C-48	1060
433829	1/2" Dr. 29mm Hand Socket (12-Point)	B-40	685	440+1892	1/2" Dr. 2.0 x 12.0mm Slotted Bit Socket, 230mmL	C-48	1160
433830	1/2" Dr. 30mm Hand Socket (12-Point)	B-40	700	440+2150	1/2" Dr. 10mm Hex Bit Socket, 55mmL	C-49	550
433831	1/2" Dr. 31mm Hand Socket (12-Point)	B-40	755	440+2350	1/2" Dr. 10mm Hex Bit Socket, 80mmL	C-49	580
433832	1/2" Dr. 32mm Hand Socket (12-Point)	B-40	755	440+2550	1/2" Dr. 10mm Hex Bit Socket, 110mmL	C-49	760
433833	1/2" Dr. 33mm Hand Socket (12-Point)	B-40	1000	440+2650	1/2" Dr. 10mm Hex Bit Socket, 150mmL	C-49	960
433834	1/2" Dr. 34mm Hand Socket (12-Point)	B-40	1000	440+2750	1/2" Dr. 10mm Hex Bit Socket, 190mmL	C-50	1060
433835	1/2" Dr. 35mm Hand Socket (12-Point)	B-40	1000	440+2850	1/2" Dr. 10mm Hex Bit Socket, 230mmL	C-50	1160
433836	1/2" Dr. 36mm Hand Socket (12-Point)	B-40	1000	440+4350	1/2" Dr. 10mm Wobble Hex Bit Socket, 80mmL	C-52	610
433837	1/2" Dr. 37mm Hand Socket (12-Point)	B-40	1000	440+4550	1/2" Dr. 10mm Wobble Hex Bit Socket, 110mmL	C-52	800
433838	1/2" Dr. 38mm Hand Socket (12-Point)	B-40	1000	440+4650	1/2" Dr. 10mm Wobble Hex Bit Socket, 150mmL	C-52	1010
433839	1/2" Dr. 39mm Hand Socket (12-Point)	B-40	1170	440+4750	1/2" Dr. 10mm Wobble Hex Bit Socket, 190mmL	C-52	1120
433840	1/2" Dr. 40mm Hand Socket (12-Point)	B-40	1260	440+4850	1/2" Dr. 10mm Wobble Hex Bit Socket, 230mmL	C-52	1220
433841	1/2" Dr. 41mm Hand Socket (12-Point)	B-40	1350	440+5050	1/2" Dr. T-50 Pentacle Bit Socket, 55mmL	C-53	580
4347	5/16" Hex Shank, 7mm Wobble Hex Hex Screwdriver Bit, 56mmL	D-8	190	440+5250	1/2" Dr. T-50 Pentacle Bit Socket, 80mmL	C-53	660
4348	5/16" Hex Shank, 8mm Wobble Hex Hex Screwdriver Bit, 56mmL	D-8	190	440+5450	1/2" Dr. T-50 Pentacle Bit Socket, 110mmL	C-53	890
4349	9mm Hex Shank, 9mm Wobble Hex Hex Screwdriver Bit, 56mmL	D-8	250	440+6255	1/2" Dr. T-55 Star Bit Socket, 55mmL	C-54	550
434S140D	1/2" Dr. 1-1/16" Torque Socket, 140 ft.lbs.(190Nm)	J-11	2880	440+6355	1/2" Dr. T-55 Star Bit Socket, 80mmL	C-54	580
4350	10mm Hex Shank, 10mm Wobble Hex Hex Screwdriver Bit, 56mmL	D-8	250	440+6555	1/2" Dr. T-55 Star Bit Socket, 110mmL	C-54	760
437808	1/2" Dr. 8mm Deep Hand Socket (12-Point)	B-41	540	440+6655	1/2" Dr. T-55 Star Bit Socket, 150mmL	C-54	960
437809	1/2" Dr. 9mm Deep Hand Socket (12-Point)	B-41	540	440+6755	1/2" Dr. T-55 Star Bit Socket, 190mmL	C-54	1060
437810	1/2" Dr. 10mm Deep Hand Socket (12-Point)	B-41	540	440+6855	1/2" Dr. T-55 Star Bit Socket, 230mmL	C-54	1160
437811	1/2" Dr. 11mm Deep Hand Socket (12-Point)	B-41	540	440+7155	1/2" Dr. T-55 Tamperproof Star Bit Socket, 55mmL	C-55	570
437812	1/2" Dr. 12mm Deep Hand Socket (12-Point)	B-41	540	440+7355	1/2" Dr. T-55 Tamperproof Star Bit Socket, 80mmL	C-55	610
437813	1/2" Dr. 13mm Deep Hand Socket (12-Point)	B-41	540	440+7555	1/2" Dr. T-55 Tamperproof Star Bit Socket, 110mmL	C-55	800
437814	1/2" Dr. 14mm Deep Hand Socket (12-Point)	B-41	540	440+7655	1/2" Dr. T-55 Tamperproof Star Bit Socket, 150mmL	C-55	1010
437815	1/2" Dr. 15mm Deep Hand Socket (12-Point)	B-41	540	440+7755	1/2" Dr. T-55 Tamperproof Star Bit Socket, 190mmL	C-55	1120
437816	1/2" Dr. 16mm Deep Hand Socket (12-Point)	B-41	540	440+7855	1/2" Dr. T-55 Tamperproof Star Bit Socket, 230mmL	C-55	1220
437817	1/2" Dr. 17mm Deep Hand Socket (12-Point)	B-41	565	440+8110	1/2" Dr. M10 Triple Square Bit Socket, 55mmL	C-56	540
437818	1/2" Dr. 18mm Deep Hand Socket (12-Point)	B-41	590	440+8310	1/2" Dr. M10 Triple Square Bit Socket, 80mmL	C-56	580
437819	1/2" Dr. 19mm Deep Hand Socket (12-Point)	B-41	615	440+8510	1/2" Dr. M10 Triple Square Bit Socket, 110mmL	C-56	760
437820	1/2" Dr. 20mm Deep Hand Socket (12-Point)	B-41	645	440+8610	1/2" Dr. M10 Triple Square Bit Socket, 150mmL	C-56	960
437821	1/2" Dr. 21mm Deep Hand Socket (12-Point)	B-41	645	440+8710	1/2" Dr. M10 Triple Square Bit Socket, 190mmL	C-56	1060
437822	1/2" Dr. 22mm Deep Hand Socket (12-Point)	B-41	710	440+8810	1/2" Dr. M10 Triple Square Bit Socket, 230mmL	C-56	1160
437823	1/2" Dr. 23mm Deep Hand Socket (12-Point)	B-41	775	440+9009	1/2" Dr. M9 Ribe Bit Socket, 55mmL	C-53	540
437824	1/2" Dr. 24mm Deep Hand Socket (12-Point)	B-41	775	440+9010	1/2" Dr. M10 Ribe Bit Socket, 55mmL	C-53	540
437825	1/2" Dr. 25mm Deep Hand Socket (12-Point)	B-41	895	440+9209	1/2" Dr. M9 Ribe Bit Socket, 80mmL	C-53	630

Item No.	Description	Pg.	Code	Item No.	Description	Pg.	Code
440+9210	1/2" Dr. M10 Ribe Bit Socket, 80mmL	C-53	630	443823	1/2" Dr. 23mm Thin Wall Impact Socket (CR-Mo)	A-32	500
440+9409	1/2" Dr. M9 Ribe Bit Socket, 110mmL	C-53	840	443824	1/2" Dr. 24mm Thin Wall Impact Socket (CR-Mo)	A-32	525
440+9410	1/2" Dr. M10 Ribe Bit Socket, 110mmL	C-53	840	443825	1/2" Dr. 25mm Thin Wall Impact Socket (CR-Mo)	A-32	660
441+	1/2" Dr. 11mm Hex Shank Bit Holder, 40mmL	D-21	400	443826	1/2" Dr. 26mm Thin Wall Impact Socket (CR-Mo)	A-32	660
441+2151	1/2" Dr. 11mm Hex Bit Socket, 55mmL	C-49	595	443827	1/2" Dr. 27mm Thin Wall Impact Socket (CR-Mo)	A-32	660
441+2351	1/2" Dr. 11mm Hex Bit Socket, 80mmL	C-49	640	443828	1/2" Dr. 28mm Thin Wall Impact Socket (CR-Mo)	A-32	780
441+2551	1/2" Dr. 11mm Hex Bit Socket, 110mmL	C-49	900	443829	1/2" Dr. 29mm Thin Wall Impact Socket (CR-Mo)	A-32	780
441+2651	1/2" Dr. 11mm Hex Bit Socket, 150mmL	C-49	1110	443830	1/2" Dr. 30mm Thin Wall Impact Socket (CR-Mo)	A-32	810
441+2751	1/2" Dr. 11mm Hex Bit Socket, 190mmL	C-50	1240	443831	1/2" Dr. 31mm Thin Wall Impact Socket (CR-Mo)	A-32	885
441+2851	1/2" Dr. 11mm Hex Bit Socket, 230mmL	C-50	1360	443832	1/2" Dr. 32mm Thin Wall Impact Socket (CR-Mo)	A-32	885
4412711	1/2" Dr. 11mm Extra-Deep Impact Socket (CR-Mo)	A-35	1200	443833	1/2" Dr. 33mm Thin Wall Impact Socket (CR-Mo)	A-32	1110
4412715	1/2" Dr. 15mm Extra-Deep Impact Socket (CR-Mo)	A-35	1300	443834	1/2" Dr. 34mm Thin Wall Impact Socket (CR-Mo)	A-32	1110
442+	1/2" Dr. 12mm Hex Shank Bit Holder, 40mmL	D-21	400	443835	1/2" Dr. 35mm Thin Wall Impact Socket (CR-Mo)	A-32	1110
442+1294	1/2" Dr. 2.5 x 14.0mm Slotted Bit Socket, 60mmL	C-48	600	443836	1/2" Dr. 36mm Thin Wall Impact Socket (CR-Mo)	A-32	1110
442+1494	1/2" Dr. 2.5 x 14.0mm Slotted Bit Socket, 80mmL	C-48	640	443837	1/2" Dr. 37mm Thin Wall Impact Socket (CR-Mo)	A-32	1110
442+1594	1/2" Dr. 2.5 x 14.0mm Slotted Bit Socket, 110mmL	C-48	900	443838	1/2" Dr. 38mm Thin Wall Impact Socket (CR-Mo)	A-32	1110
442+1694	1/2" Dr. 2.5 x 14.0mm Slotted Bit Socket, 150mmL	C-48	1110	443839	1/2" Dr. 39mm Thin Wall Impact Socket (CR-Mo)	A-32	1300
442+1794	1/2" Dr. 2.5 x 14.0mm Slotted Bit Socket, 190mmL	C-48	1240	443840	1/2" Dr. 40mm Thin Wall Impact Socket (CR-Mo)	A-32	1400
442+1894	1/2" Dr. 2.5 x 14.0mm Slotted Bit Socket, 230mmL	C-48	1360	443841	1/2" Dr. 41mm Thin Wall Impact Socket (CR-Mo)	A-32	1500
442+2152	1/2" Dr. 12mm Hex Bit Socket, 55mmL	C-49	595	444+	1/2" Dr. 14mm Hex Shank Bit Holder, 40mmL	D-21	400
442+2352	1/2" Dr. 12mm Hex Bit Socket, 80mmL	C-49	640	444+1296	1/2" Dr. 2.5 x 16.0mm Slotted Bit Socket, 60mmL	C-48	670
442+2552	1/2" Dr. 12mm Hex Bit Socket, 110mmL	C-49	900	444+1496	1/2" Dr. 2.5 x 16.0mm Slotted Bit Socket, 80mmL	C-48	700
442+2652	1/2" Dr. 12mm Hex Bit Socket, 150mmL	C-49	1110	444+1596	1/2" Dr. 2.5 x 16.0mm Slotted Bit Socket, 110mmL	C-48	1040
442+2752	1/2" Dr. 12mm Hex Bit Socket, 190mmL	C-50	1240	444+1696	1/2" Dr. 2.5 x 16.0mm Slotted Bit Socket, 150mmL	C-48	1260
442+2852	1/2" Dr. 12mm Hex Bit Socket, 230mmL	C-50	1360	444+1796	1/2" Dr. 2.5 x 16.0mm Slotted Bit Socket, 190mmL	C-48	1410
442+5055	1/2" Dr. T-55 Pentacle Bit Socket, 55mmL	C-53	630	444+1896	1/2" Dr. 2.5 x 16.0mm Slotted Bit Socket, 230mmL	C-48	1560
442+5255	1/2" Dr. T-55 Pentacle Bit Socket, 80mmL	C-53	740	444+2354	1/2" Dr. 14mm Hex Bit Socket, 80mmL	C-49	700
442+5455	1/2" Dr. T-55 Pentacle Bit Socket, 110mmL	C-53	1060	444+2554	1/2" Dr. 14mm Hex Bit Socket, 110mmL	C-49	1040
442+6260	1/2" Dr. T-60 Star Bit Socket, 60mmL	C-54	620	444+2654	1/2" Dr. 14mm Hex Bit Socket, 150mmL	C-49	1260
442+6360	1/2" Dr. T-60 Star Bit Socket, 80mmL	C-54	640	444+2754	1/2" Dr. 14mm Hex Bit Socket, 190mmL	C-50	1410
442+6560	1/2" Dr. T-60 Star Bit Socket, 110mmL	C-54	900	444+2854	1/2" Dr. 14mm Hex Bit Socket, 230mmL	C-50	1560
442+6660	1/2" Dr. T-60 Star Bit Socket, 150mmL	C-54	1110	444+6270	1/2" Dr. T-70 Star Bit Socket, 60mmL	C-54	680
442+6760	1/2" Dr. T-60 Star Bit Socket, 190mmL	C-54	1240	444+6370	1/2" Dr. T-70 Star Bit Socket, 80mmL	C-54	700
442+6860	1/2" Dr. T-60 Star Bit Socket, 230mmL	C-54	1360	444+6570	1/2" Dr. T-70 Star Bit Socket, 110mmL	C-54	1040
442+7160	1/2" Dr. T-60 Tamperproof Star Bit Socket, 60mmL	C-55	650	444+6670	1/2" Dr. T-70 Star Bit Socket, 150mmL	C-54	1260
442+7360	1/2" Dr. T-60 Tamperproof Star Bit Socket, 80mmL	C-55	670	444+6770	1/2" Dr. T-70 Star Bit Socket, 190mmL	C-54	1410
442+7560	1/2" Dr. T-60 Tamperproof Star Bit Socket, 110mmL	C-55	940	444+6870	1/2" Dr. T-70 Star Bit Socket, 230mmL	C-54	1560
442+7660	1/2" Dr. T-60 Tamperproof Star Bit Socket, 150mmL	C-55	1160	444+7170	1/2" Dr. T-70 Tamperproof Star Bit Socket, 60mmL	C-55	710
442+7760	1/2" Dr. T-60 Tamperproof Star Bit Socket, 190mmL	C-55	1290	444+7370	1/2" Dr. T-70 Tamperproof Star Bit Socket, 80mmL	C-55	730
442+7860	1/2" Dr. T-60 Tamperproof Star Bit Socket, 230mmL	C-55	1420	444+7570	1/2" Dr. T-70 Tamperproof Star Bit Socket, 110mmL	C-55	1080
442+8112	1/2" Dr. M12 Triple Square Bit Socket, 55mmL	C-56	620	444+7670	1/2" Dr. T-70 Tamperproof Star Bit Socket, 150mmL	C-55	1310
442+8312	1/2" Dr. M12 Triple Square Bit Socket, 80mmL	C-56	640	444+7770	1/2" Dr. T-70 Tamperproof Star Bit Socket, 190mmL	C-55	1470
442+8512	1/2" Dr. M12 Triple Square Bit Socket, 110mmL	C-56	900	444+7870	1/2" Dr. T-70 Tamperproof Star Bit Socket, 230mmL	C-55	1620
442+8612	1/2" Dr. M12 Triple Square Bit Socket, 150mmL	C-56	1110	444+8114	1/2" Dr. M14 Triple Square Bit Socket, 55mmL	C-56	680
442+8712	1/2" Dr. M12 Triple Square Bit Socket, 190mmL	C-56	1240	444+8314	1/2" Dr. M14 Triple Square Bit Socket, 80mmL	C-56	700
442+8812	1/2" Dr. M12 Triple Square Bit Socket, 230mmL	C-56	1360	444+8514	1/2" Dr. M14 Triple Square Bit Socket, 110mmL	C-56	1040
442+9012	1/2" Dr. M12 Ribe Bit Socket, 55mmL	C-53	600	444+8614	1/2" Dr. M14 Triple Square Bit Socket, 150mmL	C-56	1260
442+9212	1/2" Dr. M12 Ribe Bit Socket, 80mmL	C-53	700	444+8714	1/2" Dr. M14 Triple Square Bit Socket, 190mmL	C-56	1410
442+9412	1/2" Dr. M12 Ribe Bit Socket, 110mmL	C-53	1010	444+8814	1/2" Dr. M14 Triple Square Bit Socket, 230mmL	C-56	1560
443+	1/2" Dr. 13mm Hex Shank Bit Holder, 40mmL	D-21	400	444+9013	1/2" Dr. M13 Ribe Bit Socket, 55mmL	C-53	650
443+2353	1/2" Dr. 13mm Hex Bit Socket, 80mmL	C-49	670	444+9014	1/2" Dr. M14 Ribe Bit Socket, 55mmL	C-53	650
443+2553	1/2" Dr. 13mm Hex Bit Socket, 110mmL	C-49	1040	444+9213	1/2" Dr. M13 Ribe Bit Socket, 80mmL	C-53	770
443+2653	1/2" Dr. 13mm Hex Bit Socket, 150mmL	C-49	1260	444+9214	1/2" Dr. M14 Ribe Bit Socket, 80mmL	C-53	770
443+2753	1/2" Dr. 13mm Hex Bit Socket, 190mmL	C-50	1410	444+9413	1/2" Dr. M13 Ribe Bit Socket, 110mmL	C-53	1180
443+2853	1/2" Dr. 13mm Hex Bit Socket, 230mmL	C-50	1560	444+9414	1/2" Dr. M14 Ribe Bit Socket, 110mmL	C-53	1180
443808	1/2" Dr. 8mm Thin Wall Impact Socket (CR-Mo)	A-32	360	444008	1/2" Dr. 8mm Impact Socket (CR-Mo)	A-30	360
443809	1/2" Dr. 9mm Thin Wall Impact Socket (CR-Mo)	A-32	360	444009	1/2" Dr. 9mm Impact Socket (CR-Mo)	A-30	360
443810	1/2" Dr. 10mm Thin Wall Impact Socket (CR-Mo)	A-32	360	444010	1/2" Dr. 10mm Impact Socket (CR-Mo)	A-30	360
443811	1/2" Dr. 11mm Thin Wall Impact Socket (CR-Mo)	A-32	360	444011	1/2" Dr. 11mm Impact Socket (CR-Mo)	A-30	360
443812	1/2" Dr. 12mm Thin Wall Impact Socket (CR-Mo)	A-32	360	444012	1/2" Dr. 12mm Impact Socket (CR-Mo)	A-30	360
443813	1/2" Dr. 13mm Thin Wall Impact Socket (CR-Mo)	A-32	360	444013	1/2" Dr. 13mm Impact Socket (CR-Mo)	A-30	360
443814	1/2" Dr. 14mm Thin Wall Impact Socket (CR-Mo)	A-32	360	444014	1/2" Dr. 14mm Impact Socket (CR-Mo)	A-30	360
443815	1/2" Dr. 15mm Thin Wall Impact Socket (CR-Mo)	A-32	435	444015	1/2" Dr. 15mm Impact Socket (CR-Mo)	A-30	435
443816	1/2" Dr. 16mm Thin Wall Impact Socket (CR-Mo)	A-32	435	444016	1/2" Dr. 16mm Impact Socket (CR-Mo)	A-30	435
443817	1/2" Dr. 17mm Thin Wall Impact Socket (CR-Mo)	A-32	435	444017	1/2" Dr. 17mm Impact Socket (CR-Mo)	A-30	435
443818	1/2" Dr. 18mm Thin Wall Impact Socket (CR-Mo)	A-32	435	444018	1/2" Dr. 18mm Impact Socket (CR-Mo)	A-30	435
443819	1/2" Dr. 19mm Thin Wall Impact Socket (CR-Mo)	A-32	435	444019	1/2" Dr. 19mm Impact Socket (CR-Mo)	A-30	435
443820	1/2" Dr. 20mm Thin Wall Impact Socket (CR-Mo)	A-32	460	444020	1/2" Dr. 20mm Impact Socket (CR-Mo)	A-30	460
443821	1/2" Dr. 21mm Thin Wall Impact Socket (CR-Mo)	A-32	460	444021	1/2" Dr. 21mm Impact Socket (CR-Mo)	A-30	460
443822	1/2" Dr. 22mm Thin Wall Impact Socket (CR-Mo)	A-32	475	444022	1/2" Dr. 22mm Impact Socket (CR-Mo)	A-30	475

Item No.	Description	Pg.	Code	Item No.	Description	Pg.	Code
444023	1/2" Dr. 23mm Impact Socket (CR-Mo)	A-30	500	4460R03	1/2" Dr. PH.3 Philips Head Driver, 60mmL	C-7	590
444024	1/2" Dr. 24mm Impact Socket (CR-Mo)	A-30	525	4460R04	1/2" Dr. PH.4 Philips Head Driver, 60mmL	C-7	590
444025	1/2" Dr. 25mm Impact Socket (CR-Mo)	A-30	660	4460S10	1/2" Dr. T-10 Star Head Driver, 60mmL	C-7	590
444026	1/2" Dr. 26mm Impact Socket (CR-Mo)	A-30	660	4460S15	1/2" Dr. T-15 Star Head Driver, 60mmL	C-7	590
444027	1/2" Dr. 27mm Impact Socket (CR-Mo)	A-30	660	4460S20	1/2" Dr. T-20 Star Head Driver, 60mmL	C-7	590
444028	1/2" Dr. 28mm Impact Socket (CR-Mo)	A-30	780	4460S25	1/2" Dr. T-25 Star Head Driver, 60mmL	C-7	590
444029	1/2" Dr. 29mm Impact Socket (CR-Mo)	A-30	780	4460S27	1/2" Dr. T-27 Star Head Driver, 60mmL	C-7	590
444030	1/2" Dr. 30mm Impact Socket (CR-Mo)	A-30	810	4460S30	1/2" Dr. T-30 Star Head Driver, 60mmL	C-7	590
444031	1/2" Dr. 31mm Impact Socket (CR-Mo)	A-30	885	4460S40	1/2" Dr. T-40 Star Head Driver, 60mmL	C-7	590
444032	1/2" Dr. 32mm Impact Socket (CR-Mo)	A-30	885	4460S45	1/2" Dr. T-45 Star Head Driver, 60mmL	C-7	590
444033	1/2" Dr. 33mm Impact Socket (CR-Mo)	A-30	1110	4460S50	1/2" Dr. T-50 Star Head Driver, 60mmL	C-7	590
444034	1/2" Dr. 34mm Impact Socket (CR-Mo)	A-30	1110	4460S55	1/2" Dr. T-55 Star Head Driver, 60mmL	C-7	590
444035	1/2" Dr. 35mm Impact Socket (CR-Mo)	A-30	1110	4460S60	1/2" Dr. T-60 Star Head Driver, 60mmL	C-7	590
444036	1/2" Dr. 36mm Impact Socket (CR-Mo)	A-30	1110	4460S70	1/2" Dr. T-70 Star Head Driver, 60mmL	C-7	590
444037	1/2" Dr. 37mm Impact Socket (CR-Mo)	A-30	1110	4460S80	1/2" Dr. T-80 Star Head Driver, 60mmL	C-7	590
444038	1/2" Dr. 38mm Impact Socket (CR-Mo)	A-30	1110	4460T05	1/2" Dr. M5 Triple Square Head Driver, 60mmL	C-8	590
444039	1/2" Dr. 39mm Impact Socket (CR-Mo)	A-30	1300	4460T06	1/2" Dr. M6 Triple Square Head Driver, 60mmL	C-8	590
444040	1/2" Dr. 40mm Impact Socket (CR-Mo)	A-30	1400	4460T08	1/2" Dr. M8 Triple Square Head Driver, 60mmL	C-8	590
444041	1/2" Dr. 41mm Impact Socket (CR-Mo)	A-30	1500	4460T10	1/2" Dr. M10 Triple Square Head Driver, 60mmL	C-8	590
445210	1/2" Dr. 10mm Semi-Deep Thin Wall Impact Socket (CR-Mo)	A-33	500	4460T12	1/2" Dr. M12 Triple Square Head Driver, 60mmL	C-8	590
445211	1/2" Dr. 11mm Semi-Deep Thin Wall Impact Socket (CR-Mo)	A-33	500	447+	1/2" Dr. 17mm Hex Shank Bit Holder, 40mmL	D-21	450
445212	1/2" Dr. 12mm Semi-Deep Thin Wall Impact Socket (CR-Mo)	A-33	500	447+2357	1/2" Dr. 17mm Hex Bit Socket, 80mmL	C-49	890
445213	1/2" Dr. 13mm Semi-Deep Thin Wall Impact Socket (CR-Mo)	A-33	500	447+2557	1/2" Dr. 17mm Hex Bit Socket, 110mmL	C-49	1230
445214	1/2" Dr. 14mm Semi-Deep Thin Wall Impact Socket (CR-Mo)	A-33	520	447+2657	1/2" Dr. 17mm Hex Bit Socket, 150mmL	C-49	1570
445215	1/2" Dr. 15mm Semi-Deep Thin Wall Impact Socket (CR-Mo)	A-33	520	447+2757	1/2" Dr. 17mm Hex Bit Socket, 190mmL	C-50	1750
445216	1/2" Dr. 16mm Semi-Deep Thin Wall Impact Socket (CR-Mo)	A-33	520	447+2857	1/2" Dr. 17mm Hex Bit Socket, 230mmL	C-50	1930
445217	1/2" Dr. 17mm Semi-Deep Thin Wall Impact Socket (CR-Mo)	A-33	520	447604	1/2" Dr. 4mm Hex Head Driver, 76mmL	C-8	735
445218	1/2" Dr. 18mm Semi-Deep Thin Wall Impact Socket (CR-Mo)	A-33	550	447605	1/2" Dr. 5mm Hex Head Driver, 76mmL	C-8	735
445219	1/2" Dr. 19mm Semi-Deep Thin Wall Impact Socket (CR-Mo)	A-33	570	447606	1/2" Dr. 6mm Hex Head Driver, 76mmL	C-8	735
445220	1/2" Dr. 20mm Semi-Deep Thin Wall Impact Socket (CR-Mo)	A-33	600	447607	1/2" Dr. 7mm Hex Head Driver, 76mmL	C-8	735
445221	1/2" Dr. 21mm Semi-Deep Thin Wall Impact Socket (CR-Mo)	A-33	600	447608	1/2" Dr. 8mm Hex Head Driver, 76mmL	C-8	735
445222	1/2" Dr. 22mm Semi-Deep Thin Wall Impact Socket (CR-Mo)	A-33	670	447609	1/2" Dr. 9mm Hex Head Driver, 76mmL	C-8	735
445223	1/2" Dr. 23mm Semi-Deep Thin Wall Impact Socket (CR-Mo)	A-33	720	447610	1/2" Dr. 10mm Hex Head Driver, 76mmL	C-8	735
445224	1/2" Dr. 24mm Semi-Deep Thin Wall Impact Socket (CR-Mo)	A-33	720	447612	1/2" Dr. 12mm Hex Head Driver, 76mmL	C-8	735
446+	1/2" Dr. 16mm Hex Shank Bit Holder, 40mmL	D-21	430	447614	1/2" Dr. 14mm Hex Head Driver, 76mmL	C-8	735
446+2356	1/2" Dr. 16mm Hex Bit Socket, 80mmL	C-49	800	447616	1/2" Dr. 16mm Hex Head Driver, 76mmL	C-8	885
446+2556	1/2" Dr. 16mm Hex Bit Socket, 110mmL	C-49	1160	447617	1/2" Dr. 17mm Hex Head Driver, 76mmL	C-8	885
446+2656	1/2" Dr. 16mm Hex Bit Socket, 150mmL	C-49	1440	447619	1/2" Dr. 19mm Hex Head Driver, 76mmL	C-8	885
446+2756	1/2" Dr. 16mm Hex Bit Socket, 190mmL	C-50	1620	447621	1/2" Dr. 21mm Hex Head Driver, 76mmL	C-8	885
446+2856	1/2" Dr. 16mm Hex Bit Socket, 230mmL	C-50	1790	4476P08	1/2" Dr. 1.2 x 8.0mm Slotted Head Driver, 76mmL	C-7	735
446+8116	1/2" Dr. M16 Triple Square Bit Socket, 60mmL	C-56	750	4476P10	1/2" Dr. 1.6 x 10.0mm Slotted Head Driver, 76mmL	C-7	735
446+8316	1/2" Dr. M16 Triple Square Bit Socket, 80mmL	C-56	800	4476P12	1/2" Dr. 2.0 x 12.0mm Slotted Head Driver, 76mmL	C-7	735
446+8516	1/2" Dr. M16 Triple Square Bit Socket, 110mmL	C-56	1160	4476P14	1/2" Dr. 2.5 x 14.0mm Slotted Head Driver, 76mmL	C-7	735
446+8616	1/2" Dr. M16 Triple Square Bit Socket, 150mmL	C-56	1440	4476P16	1/2" Dr. 2.5 x 16.0mm Slotted Head Driver, 76mmL	C-7	735
446+8716	1/2" Dr. M16 Triple Square Bit Socket, 190mmL	C-56	1620	4476R01	1/2" Dr. PH.1 Philips Head Driver, 76mmL	C-7	735
446+8816	1/2" Dr. M16 Triple Square Bit Socket, 230mmL	C-56	1790	4476R02	1/2" Dr. PH.2 Philips Head Driver, 76mmL	C-7	735
446+9016	1/2" Dr. M16 Ribe Bit Socket, 55mmL	C-53	730	4476R03	1/2" Dr. PH.3 Philips Head Driver, 76mmL	C-7	735
446+9216	1/2" Dr. M16 Ribe Bit Socket, 80mmL	C-53	890	4476R04	1/2" Dr. PH.4 Philips Head Driver, 76mmL	C-7	735
446+9416	1/2" Dr. M16 Ribe Bit Socket, 110mmL	C-53	1320	4476S10	1/2" Dr. T-10 Star Head Driver, 76mmL	C-7	735
446004	1/2" Dr. 4mm Hex Head Driver, 60mmL	C-8	590	4476S15	1/2" Dr. T-15 Star Head Driver, 76mmL	C-7	735
446005	1/2" Dr. 5mm Hex Head Driver, 60mmL	C-8	590	4476S20	1/2" Dr. T-20 Star Head Driver, 76mmL	C-7	735
446006	1/2" Dr. 6mm Hex Head Driver, 60mmL	C-8	590	4476S25	1/2" Dr. T-25 Star Head Driver, 76mmL	C-7	735
446007	1/2" Dr. 7mm Hex Head Driver, 60mmL	C-8	590	4476S27	1/2" Dr. T-27 Star Head Driver, 76mmL	C-7	735
446008	1/2" Dr. 8mm Hex Head Driver, 60mmL	C-8	590	4476S30	1/2" Dr. T-30 Star Head Driver, 76mmL	C-7	735
446009	1/2" Dr. 9mm Hex Head Driver, 60mmL	C-8	590	4476S40	1/2" Dr. T-40 Star Head Driver, 76mmL	C-7	735
446010	1/2" Dr. 10mm Hex Head Driver, 60mmL	C-8	590	4476S45	1/2" Dr. T-45 Star Head Driver, 76mmL	C-7	735
446011	1/2" Dr. 11mm Hex Head Driver, 60mmL	C-8	590	4476S50	1/2" Dr. T-50 Star Head Driver, 76mmL	C-7	735
446012	1/2" Dr. 12mm Hex Head Driver, 60mmL	C-8	590	4476S55	1/2" Dr. T-55 Star Head Driver, 76mmL	C-7	735
446013	1/2" Dr. 13mm Hex Head Driver, 60mmL	C-8	590	4476S60	1/2" Dr. T-60 Star Head Driver, 76mmL	C-7	735
446014	1/2" Dr. 14mm Hex Head Driver, 60mmL	C-8	590	4476S70	1/2" Dr. T-70 Star Head Driver, 76mmL	C-7	735
446015	1/2" Dr. 15mm Hex Head Driver, 60mmL	C-8	650	4476T05	1/2" Dr. M5 Triple Square Head Driver, 76mmL	C-8	735
446016	1/2" Dr. 16mm Hex Head Driver, 60mmL	C-8	650	4476T06	1/2" Dr. M6 Triple Square Head Driver, 76mmL	C-8	735
446017	1/2" Dr. 17mm Hex Head Driver, 60mmL	C-8	650	4476T08	1/2" Dr. M8 Triple Square Head Driver, 76mmL	C-8	735
446018	1/2" Dr. 18mm Hex Head Driver, 60mmL	C-8	650	4476T10	1/2" Dr. M10 Triple Square Head Driver, 76mmL	C-8	735
446019	1/2" Dr. 19mm Hex Head Driver, 60mmL	C-8	650	4476T12	1/2" Dr. M12 Triple Square Head Driver, 76mmL	C-8	735
446020	1/2" Dr. 20mm Hex Head Driver, 60mmL	C-8	650	4476T14	1/2" Dr. M14 Triple Square Head Driver, 76mmL	C-8	735
446021	1/2" Dr. 21mm Hex Head Driver, 60mmL	C-8	650	4476T16	1/2" Dr. M16 Triple Square Head Driver, 76mmL	C-8	885
446022	1/2" Dr. 22mm Hex Head Driver, 60mmL	C-8	650	447808	1/2" Dr. 8mm Deep Impact Socket (CR-Mo)	A-31	590
4460P08	1/2" Dr. 1.2 x 8.0mm Slotted Head Driver, 60mmL	C-7	590	447809	1/2" Dr. 9mm Deep Impact Socket (CR-Mo)	A-31	590
4460P10	1/2" Dr. 1.6 x 10.0mm Slotted Head Driver, 60mmL	C-7	590	447810	1/2" Dr. 10mm Deep Impact Socket (CR-Mo)	A-31	590
4460P12	1/2" Dr. 2.0 x 12.0mm Slotted Head Driver, 60mmL	C-7	590				
4460P14	1/2" Dr. 2.5 x 14.0mm Slotted Head Driver, 60mmL	C-7	590				
4460P16	1/2" Dr. 2.5 x 16.0mm Slotted Head Driver, 60mmL	C-7	590				
4460R01	1/2" Dr. PH.1 Philips Head Driver, 60mmL	C-7	590				
4460R02	1/2" Dr. PH.2 Philips Head Driver, 60mmL	C-7	590				



Item No.	Description	Pg.	Code	Item No.	Description	Pg.	Code
457822	1/2" Dr. E-22 E-Star Deep Hand Socket	B-42	940	4650	10mm Hex Shank, 10mm Wobble Hex Hex Screwdriver Bit, 125mmL	D-8	650
457824	1/2" Dr. E-24 E-Star Deep Hand Socket	B-42	1010	466005	1/2" Dr. 5/32" Hex Head Driver, 60mmL	C-8	590
457826	1/2" Dr. E-26 E-Star Deep Hand Socket	B-42	1090	466006	1/2" Dr. 3/16" Hex Head Driver, 60mmL	C-8	590
457828	1/2" Dr. E-28 E-Star Deep Hand Socket	B-42	1180	466007	1/2" Dr. 7/32" Hex Head Driver, 60mmL	C-8	590
457830	1/2" Dr. E-30 E-Star Deep Hand Socket	B-42	1260	466008	1/2" Dr. 1/4" Hex Head Driver, 60mmL	C-8	590
457832	1/2" Dr. E-32 E-Star Deep Hand Socket	B-42	1340	466010	1/2" Dr. 5/16" Hex Head Driver, 60mmL	C-8	590
4612716	1/2" Dr. 1/2" Extra-Deep Impact Socket (CR-Mo)	A-35	1200	466012	1/2" Dr. 3/8" Hex Head Driver, 60mmL	C-8	650
4612720	1/2" Dr. 5/8" Extra-Deep Impact Socket (CR-Mo)	A-35	1300	466014	1/2" Dr. 7/16" Hex Head Driver, 60mmL	C-8	650
4612722	1/2" Dr. 11/16" Extra-Deep Impact Socket (CR-Mo)	A-35	1300	466016	1/2" Dr. 1/2" Hex Head Driver, 60mmL	C-8	650
4633	1/4" Hex Shank, 3mm Wobble Hex Hex Screwdriver Bit, 125mmL	D-8	350	466018	1/2" Dr. 9/16" Hex Head Driver, 60mmL	C-8	650
4634	1/4" Hex Shank, 4mm Wobble Hex Hex Screwdriver Bit, 125mmL	D-8	350	466020	1/2" Dr. 5/8" Hex Head Driver, 60mmL	C-8	650
4635	1/4" Hex Shank, 5mm Wobble Hex Hex Screwdriver Bit, 125mmL	D-8	350	466022	1/2" Dr. 11/16" Hex Head Driver, 60mmL	C-8	650
4636	1/4" Hex Shank, 6mm Wobble Hex Hex Screwdriver Bit, 125mmL	D-8	350	466024	1/2" Dr. 3/4" Hex Head Driver, 60mmL	C-8	650
463608	1/2" Dr. 1/4" Hex Shank Impact Bit Holder, 38mmL (CR-Mo)	A-36	800	466026	1/2" Dr. 13/16" Hex Head Driver, 60mmL	C-8	650
463610	1/2" Dr. 5/16" Hex Shank Impact Bit Holder, 38mmL (CR-Mo)	A-36	800	467810	1/2" Dr. 5/16" Deep Impact Socket (CR-Mo)	A-31	590
463810	1/2" Dr. 5/16" Thin Wall Impact Socket (CR-Mo)	A-32	360	467812	1/2" Dr. 3/8" Deep Impact Socket (CR-Mo)	A-31	590
463812	1/2" Dr. 3/8" Thin Wall Impact Socket (CR-Mo)	A-32	360	467814	1/2" Dr. 7/16" Deep Impact Socket (CR-Mo)	A-31	590
463814	1/2" Dr. 7/16" Thin Wall Impact Socket (CR-Mo)	A-32	360	467816	1/2" Dr. 1/2" Deep Impact Socket (CR-Mo)	A-31	590
463816	1/2" Dr. 1/2" Thin Wall Impact Socket (CR-Mo)	A-32	360	467818	1/2" Dr. 9/16" Deep Impact Socket (CR-Mo)	A-31	590
463818	1/2" Dr. 9/16" Thin Wall Impact Socket (CR-Mo)	A-32	360	467819	1/2" Dr. 19/32" Deep Impact Socket (CR-Mo)	A-31	590
463819	1/2" Dr. 19/32" Thin Wall Impact Socket (CR-Mo)	A-32	435	467820	1/2" Dr. 5/8" Deep Impact Socket (CR-Mo)	A-31	590
463820	1/2" Dr. 5/8" Thin Wall Impact Socket (CR-Mo)	A-32	435	467822	1/2" Dr. 11/16" Deep Impact Socket (CR-Mo)	A-31	620
463822	1/2" Dr. 11/16" Thin Wall Impact Socket (CR-Mo)	A-32	435	467824	1/2" Dr. 3/4" Deep Impact Socket (CR-Mo)	A-31	680
463824	1/2" Dr. 3/4" Thin Wall Impact Socket (CR-Mo)	A-32	435	467825	1/2" Dr. 25/32" Deep Impact Socket (CR-Mo)	A-31	705
463825	1/2" Dr. 25/32" Thin Wall Impact Socket (CR-Mo)	A-32	460	467826	1/2" Dr. 13/16" Deep Impact Socket (CR-Mo)	A-31	705
463826	1/2" Dr. 13/16" Thin Wall Impact Socket (CR-Mo)	A-32	460	467828	1/2" Dr. 7/8" Deep Impact Socket (CR-Mo)	A-31	790
463828	1/2" Dr. 7/8" Thin Wall Impact Socket (CR-Mo)	A-32	475	467830	1/2" Dr. 15/16" Deep Impact Socket (CR-Mo)	A-31	855
463830	1/2" Dr. 15/16" Thin Wall Impact Socket (CR-Mo)	A-32	525	467832	1/2" Dr. 1" Deep Impact Socket (CR-Mo)	A-31	970
463832	1/2" Dr. 1" Thin Wall Impact Socket (CR-Mo)	A-32	660	467834	1/2" Dr. 1-1/16" Deep Impact Socket (CR-Mo)	A-31	1025
463834	1/2" Dr. 1-1/16" Thin Wall Impact Socket (CR-Mo)	A-32	660	467836	1/2" Dr. 1-1/8" Deep Impact Socket (CR-Mo)	A-31	1170
463836	1/2" Dr. 1-1/8" Thin Wall Impact Socket (CR-Mo)	A-32	780	467838	1/2" Dr. 1-3/16" Deep Impact Socket (CR-Mo)	A-31	1260
463838	1/2" Dr. 1-3/16" Thin Wall Impact Socket (CR-Mo)	A-32	810	467840	1/2" Dr. 1-1/4" Deep Impact Socket (CR-Mo)	A-31	1350
463840	1/2" Dr. 1-1/4" Thin Wall Impact Socket (CR-Mo)	A-32	885	467842	1/2" Dr. 1-5/16" Deep Impact Socket (CR-Mo)	A-31	1610
463842	1/2" Dr. 1-5/16" Thin Wall Impact Socket (CR-Mo)	A-32	1110	467844	1/2" Dr. 1-3/8" Deep Impact Socket (CR-Mo)	A-31	1610
463844	1/2" Dr. 1-3/8" Thin Wall Impact Socket (CR-Mo)	A-32	1110	467846	1/2" Dr. 1-7/16" Deep Impact Socket (CR-Mo)	A-31	1610
463846	1/2" Dr. 1-7/16" Thin Wall Impact Socket (CR-Mo)	A-32	1110	467848	1/2" Dr. 1-1/2" Deep Impact Socket (CR-Mo)	A-31	1610
463848	1/2" Dr. 1-1/2" Thin Wall Impact Socket (CR-Mo)	A-32	1110	467850	1/2" Dr. 1-9/16" Deep Impact Socket (CR-Mo)	A-31	1750
463850	1/2" Dr. 1-9/16" Thin Wall Impact Socket (CR-Mo)	A-32	1400	467852	1/2" Dr. 1-5/8" Deep Impact Socket (CR-Mo)	A-31	1750
463852	1/2" Dr. 1-5/8" Thin Wall Impact Socket (CR-Mo)	A-32	1500	468526W	1/2" Dr. 13/16" Thin Wall Deep Impact Socket w/Plastic Sleeve	J-14	1160
464010	1/2" Dr. 5/16" Impact Socket (CR-Mo)	A-30	360	4733	1/4" Hex Shank, 3mm Wobble Hex Hex Screwdriver Bit, 160mmL	D-8	430
464012	1/2" Dr. 3/8" Impact Socket (CR-Mo)	A-30	360	4734	1/4" Hex Shank, 4mm Wobble Hex Hex Screwdriver Bit, 160mmL	D-8	430
464014	1/2" Dr. 7/16" Impact Socket (CR-Mo)	A-30	360	4735	1/4" Hex Shank, 5mm Wobble Hex Hex Screwdriver Bit, 160mmL	D-8	430
464016	1/2" Dr. 1/2" Impact Socket (CR-Mo)	A-30	360	4736	1/4" Hex Shank, 6mm Wobble Hex Hex Screwdriver Bit, 160mmL	D-8	430
464018	1/2" Dr. 9/16" Impact Socket (CR-Mo)	A-30	360	473810	1/2" Dr. 5/16" Hand Socket (12-Point)	B-40	300
464019	1/2" Dr. 19/32" Impact Socket (CR-Mo)	A-30	435	473812	1/2" Dr. 3/8" Hand Socket (12-Point)	B-40	300
464020	1/2" Dr. 5/8" Impact Socket (CR-Mo)	A-30	435	473814	1/2" Dr. 7/16" Hand Socket (12-Point)	B-40	300
464022	1/2" Dr. 11/16" Impact Socket (CR-Mo)	A-30	435	473816	1/2" Dr. 1/2" Hand Socket (12-Point)	B-40	300
464024	1/2" Dr. 3/4" Impact Socket (CR-Mo)	A-30	435	473818	1/2" Dr. 9/16" Hand Socket (12-Point)	B-40	300
464025	1/2" Dr. 25/32" Impact Socket (CR-Mo)	A-30	460	473819	1/2" Dr. 19/32" Hand Socket (12-Point)	B-40	315
464026	1/2" Dr. 13/16" Impact Socket (CR-Mo)	A-30	460	473820	1/2" Dr. 5/8" Hand Socket (12-Point)	B-40	345
464028	1/2" Dr. 7/8" Impact Socket (CR-Mo)	A-30	475	473821	1/2" Dr. 21/32" Hand Socket (12-Point)	B-40	365
464030	1/2" Dr. 15/16" Impact Socket (CR-Mo)	A-30	525	473822	1/2" Dr. 11/16" Hand Socket (12-Point)	B-40	365
464032	1/2" Dr. 1" Impact Socket (CR-Mo)	A-30	660	473824	1/2" Dr. 3/4" Hand Socket (12-Point)	B-40	405
464034	1/2" Dr. 1-1/16" Impact Socket (CR-Mo)	A-30	660	473825	1/2" Dr. 25/32" Hand Socket (12-Point)	B-40	420
464036	1/2" Dr. 1-1/8" Impact Socket (CR-Mo)	A-30	780	473826	1/2" Dr. 13/16" Hand Socket (12-Point)	B-40	450
464038	1/2" Dr. 1-3/16" Impact Socket (CR-Mo)	A-30	810	473828	1/2" Dr. 7/8" Hand Socket (12-Point)	B-40	470
464040	1/2" Dr. 1-1/4" Impact Socket (CR-Mo)	A-30	885	473830	1/2" Dr. 15/16" Hand Socket (12-Point)	B-40	510
464042	1/2" Dr. 1-5/16" Impact Socket (CR-Mo)	A-30	1110	473832	1/2" Dr. 1" Hand Socket (12-Point)	B-40	525
464044	1/2" Dr. 1-3/8" Impact Socket (CR-Mo)	A-30	1110	473834	1/2" Dr. 1-1/16" Hand Socket (12-Point)	B-40	580
464046	1/2" Dr. 1-7/16" Impact Socket (CR-Mo)	A-30	1110	473836	1/2" Dr. 1-1/8" Hand Socket (12-Point)	B-40	660
464048	1/2" Dr. 1-1/2" Impact Socket (CR-Mo)	A-30	1110	473838	1/2" Dr. 1-3/16" Hand Socket (12-Point)	B-40	700
464050	1/2" Dr. 1-9/16" Impact Socket (CR-Mo)	A-30	1400	473840	1/2" Dr. 1-1/4" Hand Socket (12-Point)	B-40	755
464052	1/2" Dr. 1-5/8" Impact Socket (CR-Mo)	A-30	1500	473842	1/2" Dr. 1-5/16" Hand Socket (12-Point)	B-40	1000
464108	1/2" Dr. 1/4" Hex Shank Impact Bit Holder, 41mmL (CR-Mo)	A-36	525	473844	1/2" Dr. 1-3/8" Hand Socket (12-Point)	B-40	1000
464110	1/2" Dr. 5/16" Hex Shank Impact Bit Holder, 41mmL (CR-Mo)	A-36	565	473846	1/2" Dr. 1-7/16" Hand Socket (12-Point)	B-40	1000
4647	5/16" Hex Shank, 7mm Wobble Hex Hex Screwdriver Bit, 125mmL	D-8	450	473848	1/2" Dr. 1-1/2" Hand Socket (12-Point)	B-40	1000
4648	5/16" Hex Shank, 8mm Wobble Hex Hex Screwdriver Bit, 125mmL	D-8	450	473850	1/2" Dr. 1-9/16" Hand Socket (12-Point)	B-40	1260
464808	1/2" Dr. 1/4" Hex Shank Impact Bit Holder, 48mmL (CR-Mo)	A-36	525	473852	1/2" Dr. 1-5/8" Hand Socket (12-Point)	B-40	1350
464810	1/2" Dr. 5/16" Hex Shank Impact Bit Holder, 48mmL (CR-Mo)	A-36	565	4747	5/16" Hex Shank, 7mm Wobble Hex Hex Screwdriver Bit, 160mmL	D-8	560
4649	9mm Hex Shank, 9mm Wobble Hex Hex Screwdriver Bit, 125mmL	D-8	650	4748	5/16" Hex Shank, 8mm Wobble Hex Hex Screwdriver Bit, 160mmL	D-8	560

Item No.	Description	Pg.	Code	Item No.	Description	Pg.	Code
4749	9mm Hex Shank, 9mm Wobble Hex Hex Screwdriver Bit, 160mmL	D-8	760	480036	1/2" Dr. Impact Extension Bar, 125mmL	A-18	360
4750	10mm Hex Shank, 10mm Wobble Hex Hex Screwdriver Bit, 160mmL	D-8	760	480036CM	1/2" Dr. Impact Extension Bar w/pin hole, 125mmL (CR-Mo)	A-36	680
477810	1/2" Dr. 5/16" Deep Hand Socket (12-Point)	B-41	540	480036MB	1/2" Dr. Impact Extension Bar w/steel ball, 125mmL (CR-Mo)	A-36	680
477812	1/2" Dr. 3/8" Deep Hand Socket (12-Point)	B-41	540	480038	1/2" Dr. 1/4" Hex Shank Impact Bit Holder, 75mmL	A-17	445
477814	1/2" Dr. 7/16" Deep Hand Socket (12-Point)	B-41	540	480040	1/2" Dr. Sliding T-Handle	B-43	1425
477816	1/2" Dr. 1/2" Deep Hand Socket (12-Point)	B-41	540	480066	1/2" Dr. Impact Adapter 1/2" F x 3/4" M	A-17	475
477818	1/2" Dr. 9/16" Deep Hand Socket (12-Point)	B-41	540	480066CM	1/2" Dr. Impact Adapter 1/2" F x 3/4" M w/pin hole (CR-Mo)	A-36	620
477819	1/2" Dr. 19/32" Deep Hand Socket (12-Point)	B-41	540	480066MB	1/2" Dr. Impact Adapter 1/2" F x 3/4" M w/steel ball (CR-Mo)	A-36	620
477820	1/2" Dr. 5/8" Deep Hand Socket (12-Point)	B-41	540	480070	1/2" Dr. Universal Joint	B-43	655
477822	1/2" Dr. 11/16" Deep Hand Socket (12-Point)	B-41	565	480150CM	1/2" Dr. Impact Extension Bar w/pin hole, 150mmL (CR-Mo)	A-36	700
477824	1/2" Dr. 3/4" Deep Hand Socket (12-Point)	B-41	615	480150F	1/2" Dr. Torque Wrench, 30 ~ 150 ft. lbs.	F-36	12900
477825	1/2" Dr. 25/32" Deep Hand Socket (12-Point)	B-41	645	480150MB	1/2" Dr. Impact Extension Bar w/steel ball, 150mmL (CR-Mo)	A-36	700
477826	1/2" Dr. 13/16" Deep Hand Socket (12-Point)	B-41	645	480200CM	1/2" Dr. Impact Extension Bar w/pin hole, 200mmL (CR-Mo)	A-36	1050
477828	1/2" Dr. 7/8" Deep Hand Socket (12-Point)	B-41	710	480200MB	1/2" Dr. Impact Extension Bar w/steel ball, 200mmL (CR-Mo)	A-36	1050
477830	1/2" Dr. 15/16" Deep Hand Socket (12-Point)	B-41	775	480210N	1/2" Dr. Torque Wrench, 40 ~ 210 Nm	F-36	12900
477832	1/2" Dr. 1" Deep Hand Socket (12-Point)	B-41	895	480250CM	1/2" Dr. Impact Extension Bar w/pin hole, 250mmL (CR-Mo)	A-36	1250
477834	1/2" Dr. 1-1/16" Deep Hand Socket (12-Point)	B-41	930	480250F	1/2" Dr. Torque Wrench, 50 ~ 250 ft. lbs.	F-36	16500
477836	1/2" Dr. 1-1/8" Deep Hand Socket (12-Point)	B-41	1050	480250MB	1/2" Dr. Impact Extension Bar w/steel ball, 250mmL (CR-Mo)	A-36	1250
477838	1/2" Dr. 1-3/16" Deep Hand Socket (12-Point)	B-41	1135	480320	1/2" Dr. Impact Extension Bar, 250mmL	A-18	680
477840	1/2" Dr. 1-1/4" Deep Hand Socket (12-Point)	B-41	1220	480350N	1/2" Dr. Torque Wrench, 70 ~ 350 Nm	F-36	16500
477842	1/2" Dr. 1-5/16" Deep Hand Socket (12-Point)	B-41	1450	480415	1/2" Dr. "Spud" Reversible Ratchet	B-44	3800
477844	1/2" Dr. 1-3/8" Deep Hand Socket (12-Point)	B-41	1450	480420	1/2" Dr. Speed Handle, 420mmL	B-42	2330
477846	1/2" Dr. 1-7/16" Deep Hand Socket (12-Point)	B-41	1450	480431P	1/2" Dr. 36 Teeth Ratchet w/ Quick Release	B-44	4375
477848	1/2" Dr. 1-1/2" Deep Hand Socket (12-Point)	B-41	1450	480431R	1/2" Dr. 36 Teeth Ratchet w/ Quick Release	B-44	4275
477850	1/2" Dr. 1-9/16" Deep Hand Socket (12-Point)	B-41	1550	480431S	1/2" Dr. 36 Teeth Ratchet w/ Quick Release	B-44	4500
477852	1/2" Dr. 1-5/8" Deep Hand Socket (12-Point)	B-41	1550	480444H	1/2" Dr. 24 Teeth Sanitary Ratchet	B-44	2800
480002	1/2" Dr. Impact Extension Bar, 50mmL	A-18	235	480444R	1/2" Dr. Reversible Ratchet	B-44	2680
480011M	1/2" Dr. 11mm Swivel Impact Socket	A-26	960	480446	1/2" Dr. Hinge Handle	B-44	2770
480011MD	1/2" Dr. 11mm Deep Swivel Impact Socket	A-27	1250	480446A	1/2" Dr. Hinge Handle	B-44	2770
480012M	1/2" Dr. 12mm Swivel Impact Socket	A-26	960	480446P	1/2" Dr. Hinge Handle, 410mmL	B-44	2870
480012MD	1/2" Dr. 12mm Deep Swivel Impact Socket	A-27	1250	480446S	1/2" Dr. Hinge Handle, 420mmL	B-44	2970
480013M	1/2" Dr. 13mm Swivel Impact Socket	A-26	960	480448P	1/2" Dr. Hinge Handle, 620mmL	B-44	3300
480013MD	1/2" Dr. 13mm Deep Swivel Impact Socket	A-27	1250	480448S	1/2" Dr. Hinge Handle, 640mmL	B-44	3400
480014M	1/2" Dr. 14mm Swivel Impact Socket	A-26	960	480472	1/2" Dr. 72 Teeth Reversible Ratchet	B-45	2950
480014MD	1/2" Dr. 14mm Deep Swivel Impact Socket	A-27	1250	480472P	1/2" Dr. 72 Teeth Reversible Ratchet	B-45	3050
480015M	1/2" Dr. 15mm Swivel Impact Socket	A-26	960	480472S	1/2" Dr. 72 Teeth Reversible Ratchet	B-45	3200
480015MD	1/2" Dr. 15mm Deep Swivel Impact Socket	A-27	1250	480490	1/2" Dr. Speed Handle, 490mmL	B-42	2550
480016M	1/2" Dr. 16mm Swivel Impact Socket	A-26	960	480J24	7/16" Dr. 1/2" Swivel Impact Socket	A-26	960
480016MD	1/2" Dr. 16mm Deep Swivel Impact Socket	A-27	1250	481804	1/2" Dr. 72 Teeth Rotor Ratchet	B-45	5000
480017M	1/2" Dr. 17mm Swivel Impact Socket	A-26	990	481804P	1/2" Dr. 72 Teeth Rotor Ratchet	B-45	5100
480017MD	1/2" Dr. 17mm Deep Swivel Impact Socket	A-27	1285	481804S	1/2" Dr. 72 Teeth Rotor Ratchet	B-45	5200
480018M	1/2" Dr. 18mm Swivel Impact Socket	A-26	1020	4833	1/4" Hex Shank, 3mm Wobble Hex Hex Screwdriver Bit, 200mmL	D-8	510
480018MD	1/2" Dr. 18mm Deep Swivel Impact Socket	A-27	1315	4834	1/4" Hex Shank, 4mm Wobble Hex Hex Screwdriver Bit, 200mmL	D-8	510
480019M	1/2" Dr. 19mm Swivel Impact Socket	A-26	1050	4835	1/4" Hex Shank, 5mm Wobble Hex Hex Screwdriver Bit, 200mmL	D-8	510
480019MD	1/2" Dr. 19mm Deep Swivel Impact Socket	A-27	1350	4836	1/4" Hex Shank, 6mm Wobble Hex Hex Screwdriver Bit, 200mmL	D-8	510
480021M	1/2" Dr. 22mm Swivel Impact Socket	A-26	1090	483810	1/2" Dr. 5/16" Hand Socket	B-38	300
480021MD	1/2" Dr. 22mm Deep Swivel Impact Socket	A-27	1385	483812	1/2" Dr. 3/8" Hand Socket	B-38	300
480022M	1/2" Dr. 7/16" Swivel Impact Socket	A-26	1120	483814	1/2" Dr. 7/16" Hand Socket	B-38	300
480022MD	1/2" Dr. 22mm Deep Swivel Impact Socket	A-27	1410	483816	1/2" Dr. 1/2" Hand Socket	B-38	300
480024D	1/2" Dr. 7/16" Deep Swivel Impact Socket	A-27	1250	483818	1/2" Dr. 9/16" Hand Socket	B-38	300
480025	1/2" Dr. 1/2" Swivel Impact Socket	A-26	960	483819	1/2" Dr. 19/32" Hand Socket	B-38	315
480025D	1/2" Dr. 1/2" Deep Swivel Impact Socket	A-27	1250	483820	1/2" Dr. 5/8" Hand Socket	B-38	345
480026	1/2" Dr. 9/16" Swivel Impact Socket	A-26	960	483821	1/2" Dr. 21/32" Hand Socket	B-38	365
480026D	1/2" Dr. 9/16" Deep Swivel Impact Socket	A-27	1250	483822	1/2" Dr. 11/16" Hand Socket	B-38	365
480027	1/2" Dr. 5/8" Swivel Impact Socket	A-26	960	483824	1/2" Dr. 3/4" Hand Socket	B-38	405
480027D	1/2" Dr. 5/8" Deep Swivel Impact Socket	A-27	1250	483825	1/2" Dr. 25/32" Hand Socket	B-38	420
480028	1/2" Dr. 11/16" Swivel Impact Socket	A-26	990	483826	1/2" Dr. 13/16" Hand Socket	B-38	450
480028D	1/2" Dr. 11/16" Deep Swivel Impact Socket	A-27	1285	483828	1/2" Dr. 7/8" Hand Socket	B-38	470
480029	1/2" Dr. 3/4" Swivel Impact Socket	A-26	1050	483830	1/2" Dr. 15/16" Hand Socket	B-38	510
480029D	1/2" Dr. 3/4" Deep Swivel Impact Socket	A-27	1350	483832	1/2" Dr. 1" Hand Socket	B-38	525
480030	1/2" Dr. 13/16" Swivel Impact Socket	A-26	1090	483834	1/2" Dr. 1-1/16" Hand Socket	B-38	580
480030D	1/2" Dr. 13/16" Deep Swivel Impact Socket	A-27	1385	483836	1/2" Dr. 1-1/8" Hand Socket	B-38	660
480031	1/2" Dr. 7/8" Swivel Impact Socket	A-26	1120	483838	1/2" Dr. 1-3/16" Hand Socket	B-38	700
480031D	1/2" Dr. 7/8" Deep Swivel Impact Socket	A-27	1415	483840	1/2" Dr. 1-1/4" Hand Socket	B-38	755
480032	1/2" Dr. Impact Extension Bar, 75mmL	A-18	265	483842	1/2" Dr. 1-5/16" Hand Socket	B-38	1000
480032CM	1/2" Dr. Impact Extension Bar w/pin hole, 75mmL (CR-Mo)	A-36	620	483844	1/2" Dr. 1-3/8" Hand Socket	B-38	1000
480032MB	1/2" Dr. Impact Extension Bar w/steel ball, 75mmL (CR-Mo)	A-36	620	483846	1/2" Dr. 1-7/16" Hand Socket	B-38	1000
480033	1/2" Dr. Impact Adapter 1/2" F x 3/8" M	A-17	215	483848	1/2" Dr. 1-1/2" Hand Socket	B-38	1000
480033CM	1/2" Dr. Impact Adapter 1/2" F x 3/8" M w/pin hole (CR-Mo)	A-36	460	483850	1/2" Dr. 1-9/16" Hand Socket	B-38	1260
480033MB	1/2" Dr. Impact Adapter 1/2" F x 3/8" M w/steel ball (CR-Mo)	A-36	460	483852	1/2" Dr. 1-5/8" Hand Socket	B-38	1350

Item No.	Description	Pg.	Code	Item No.	Description	Pg.	Code
484108	1/2" Dr. 1/4" Hex Shank Bit Holder(quick change), 41mmL	B-42	525	488018	1/2" Dr. 9/16" Semi-Deep Swivel Impact Socket	A-26	1170
484110	1/2" Dr. 5/16" Hex Shank Bit Holder(quick change), 41mmL	B-42	565	488020	1/2" Dr. 5/8" Semi-Deep Swivel Impact Socket	A-26	1170
484112	1/2" Dr. 3/8" Hex Shank Bit Holder(quick change), 41mmL	B-42	620	488022	1/2" Dr. 11/16" Semi-Deep Swivel Impact Socket	A-26	1170
484314	1/2" Dr. 7/16" Hex Shank Bit Holder(quick change), 43mmL	B-42	660	488024	1/2" Dr. 3/4" Semi-Deep Swivel Impact Socket	A-26	1280
484464	1/2" Dr. 72 Teeth Flex Head Ratchet	B-45	3800	488026	1/2" Dr. 13/16" Semi-Deep Swivel Impact Socket	A-26	1330
484464P	1/2" Dr. 72 Teeth Flex Head Ratchet, 430mmL	B-45	3900	488028	1/2" Dr. 7/8" Semi-Deep Swivel Impact Socket	A-26	1360
484464S	1/2" Dr. 72 Teeth Flex Head Ratchet, 440mmL	B-45	4000	493810	1/2" Dr. 5/16" Impact Socket	A-17	210
484468P	1/2" Dr. 72 Teeth Flex Head Ratchet, 650mmL	B-45	4490	493812	1/2" Dr. 3/4" Impact Socket	A-17	210
484468S	1/2" Dr. 72 Teeth Flex Head Ratchet, 670mmL	B-45	4590	493814	1/2" Dr. 7/16" Impact Socket	A-17	210
484516	1/2" Dr. 1/2" Hex Shank Bit Holder(quick change), 45mmL	B-42	700	493816	1/2" Dr. 1/2" Impact Socket	A-17	210
4847	5/16" Hex Shank, 7mm Wobble Hex Hex Screwdriver Bit, 200mmL	D-8	660	493818	1/2" Dr. 9/16" Impact Socket	A-17	210
4848	5/16" Hex Shank, 8mm Wobble Hex Hex Screwdriver Bit, 200mmL	D-8	660	493819	1/2" Dr. 19/32" Impact Socket	A-17	210
484808	1/2" Dr. 1/4" Hex Shank Bit Holder(quick change), 48mmL	B-42	525	493820	1/2" Dr. 5/8" Impact Socket	A-17	210
484810	1/2" Dr. 5/16" Hex Shank Bit Holder(quick change), 48mmL	B-42	565	493822	1/2" Dr. 11/16" Impact Socket	A-17	210
4849	9mm Hex Shank, 9mm Wobble Hex Hex Screwdriver Bit, 200mmL	D-8	860	493824	1/2" Dr. 3/4" Impact Socket	A-17	240
4850	10mm Hex Shank, 10mm Wobble Hex Hex Screwdriver Bit, 200mmL	D-8	860	493825	1/2" Dr. 25/32" Impact Socket	A-17	265
486308	1/2" Dr. 1/4" Stud Remover Socket	J-20	1105	493826	1/2" Dr. 13/16" Impact Socket	A-17	265
486310	1/2" Dr. 5/16" Stud Remover Socket	J-20	1105	493828	1/2" Dr. 7/8" Impact Socket	A-17	300
487065	1/2" Dr. Torque Extension Bar, 65 ft.lbs.(90Nm)	J-13	2400	493830	1/2" Dr. 15/16" Impact Socket	A-17	360
487075	1/2" Dr. Torque Extension Bar, 75 ft.lbs.(100Nm)	J-13	2400	493832	1/2" Dr. 1" Impact Socket	A-17	400
487080	1/2" Dr. Torque Extension Bar, 80 ft.lbs.(110Nm)	J-13	2400	493834	1/2" Dr. 1-1/16" Impact Socket	A-17	445
487090	1/2" Dr. Torque Extension Bar, 90 ft.lbs.(120Nm)	J-13	2400	493836	1/2" Dr. 1-1/8" Impact Socket	A-17	565
487100	1/2" Dr. Torque Extension Bar, 100 ft.lbs.(135Nm)	J-13	2400	493838	1/2" Dr. 1-3/16" Impact Socket	A-17	565
487110	1/2" Dr. Torque Extension Bar, 110 ft.lbs.(150Nm)	J-13	2400	493840	1/2" Dr. 1-1/4" Impact Socket	A-17	620
487120	1/2" Dr. Torque Extension Bar, 120 ft.lbs.(160Nm)	J-13	2400	49602224	1/2" Dr. 11/16" x 3/4" Flip Socket	J-19	465
487130	1/2" Dr. Torque Extension Bar, 130 ft.lbs.(175Nm)	J-13	2400	49652426	1/2" Dr. 3/4" x 13/16" Flip Socket	J-19	465
487140	1/2" Dr. Torque Extension Bar, 140 ft.lbs.(190Nm)	J-13	2400	49762426	1/2" Dr. 3/4" x 13/16" Extra-Thin Wall Flip Impact Socket (CR-Mo)	A-35	580
487150	1/2" Dr. Torque Extension Bar, 150 ft.lbs.(200Nm)	J-13	2400	497810	1/2" Dr. 5/16" Deep Impact Socket	A-18	335
487412	1/2" Dr. 3/8" Stud Remover Socket	J-20	1130	497812	1/2" Dr. 3/8" Deep Impact Socket	A-18	335
487414	1/2" Dr. 7/16" Stud Remover Socket	J-20	1130	497814	1/2" Dr. 7/16" Deep Impact Socket	A-18	335
487416	1/2" Dr. 1/2" Stud Remover Socket	J-20	1150	497816	1/2" Dr. 1/2" Deep Impact Socket	A-18	335
487418	1/2" Dr. 9/16" Stud Remover Socket	J-20	1200	497818	1/2" Dr. 9/16" Deep Impact Socket	A-18	335
487420	1/2" Dr. 5/8" Stud Remover Socket	J-20	1200	497819	1/2" Dr. 19/32" Deep Impact Socket	A-18	360
487810	1/2" Dr. 5/16" Deep Hand Socket	B-39	540	497820	1/2" Dr. 5/8" Deep Impact Socket	A-18	385
487812	1/2" Dr. 3/8" Deep Hand Socket	B-39	540	497822	1/2" Dr. 11/16" Deep Impact Socket	A-18	405
487814	1/2" Dr. 7/16" Deep Hand Socket	B-39	540	497824	1/2" Dr. 3/4" Deep Impact Socket	A-18	450
487816	1/2" Dr. 1/2" Deep Hand Socket	B-39	540	497825	1/2" Dr. 25/32" Deep Impact Socket	A-18	495
487818	1/2" Dr. 9/16" Deep Hand Socket	B-39	540	497826	1/2" Dr. 13/16" Deep Impact Socket	A-18	495
487819	1/2" Dr. 19/32" Deep Hand Socket	B-39	540	497828	1/2" Dr. 7/8" Deep Impact Socket	A-18	520
487820	1/2" Dr. 5/8" Deep Hand Socket	B-39	540	497830	1/2" Dr. 15/16" Deep Impact Socket	A-18	570
487822	1/2" Dr. 11/16" Deep Hand Socket	B-39	565	497832	1/2" Dr. 1" Deep Impact Socket	A-18	600
487824	1/2" Dr. 3/4" Deep Hand Socket	B-39	615	497834	1/2" Dr. 1-1/16" Deep Impact Socket	A-18	765
487825	1/2" Dr. 25/32" Deep Hand Socket	B-39	645	497836	1/2" Dr. 1-1/8" Deep Impact Socket	A-18	825
487826	1/2" Dr. 13/16" Deep Hand Socket	B-39	645	497838	1/2" Dr. 1-3/16" Deep Impact Socket	A-18	825
487828	1/2" Dr. 7/8" Deep Hand Socket	B-39	710	497840	1/2" Dr. 1-1/4" Deep Impact Socket	A-18	885
487830	1/2" Dr. 15/16" Deep Hand Socket	B-39	775	4K0950	1/2" Dr. Air Impact Wrench, 700 ft. lbs. / 950 Nm	E-9	35000
487832	1/2" Dr. 1" Deep Hand Socket	B-39	895	4K0952	1/2" Dr. Long Anvil Air Impact Wrench, 700 ft. lbs. / 950 Nm	E-9	37000
487834	1/2" Dr. 1-1/16" Deep Hand Socket	B-39	930				
487836	1/2" Dr. 1-1/8" Deep Hand Socket	B-39	1050				
487838	1/2" Dr. 1-3/16" Deep Hand Socket	B-39	1135				
487840	1/2" Dr. 1-1/4" Deep Hand Socket	B-39	1220				
487842	1/2" Dr. 1-5/16" Deep Hand Socket	B-39	1450				
487844	1/2" Dr. 1-3/8" Deep Hand Socket	B-39	1450				
487846	1/2" Dr. 1-7/16" Deep Hand Socket	B-39	1450				
487848	1/2" Dr. 1-1/2" Deep Hand Socket	B-39	1450				
487850	1/2" Dr. 1-9/16" Deep Hand Socket	B-39	1550				
487852	1/2" Dr. 1-5/8" Deep Hand Socket	B-39	1550				
487911M	1/2" Dr. 11mm Semi-Deep Swivel Impact Socket	A-26	1170				
487912M	1/2" Dr. 12mm Semi-Deep Swivel Impact Socket	A-26	1170				
487913M	1/2" Dr. 13mm Semi-Deep Swivel Impact Socket	A-26	1170				
487914M	1/2" Dr. 14mm Semi-Deep Swivel Impact Socket	A-26	1170				
487915M	1/2" Dr. 15mm Semi-Deep Swivel Impact Socket	A-26	1170				
487916M	1/2" Dr. 16mm Semi-Deep Swivel Impact Socket	A-26	1170				
487917M	1/2" Dr. 17mm Semi-Deep Swivel Impact Socket	A-26	1200				
487918M	1/2" Dr. 18mm Semi-Deep Swivel Impact Socket	A-26	1240				
487919M	1/2" Dr. 19mm Semi-Deep Swivel Impact Socket	A-26	1280				
487921M	1/2" Dr. 21mm Semi-Deep Swivel Impact Socket	A-26	1330				
487922M	1/2" Dr. 22mm Semi-Deep Swivel Impact Socket	A-26	1360				
488014	1/2" Dr. 7/16" Semi-Deep Swivel Impact Socket	A-26	1170				
488016	1/2" Dr. 1/2" Semi-Deep Swivel Impact Socket	A-26	1170				



Item No.	Description	Pg.	Code	Item No.	Description	Pg.	Code
<b>5</b>				502126	1/4" Hex Shank, PH.2~1.0x6.0mm Reversible Blade, 180mmL	D-48	350
500050	#0 Square Screwdriver w/Plastic Handle, 100mmL	D-51	435	502137	1/4" Hex Shank, PH.3~1.2x7.0mm Reversible Blade, 180mmL	D-48	350
500051	#1 Square Screwdriver w/Plastic Handle, 100mmL	D-51	435	502201	1/4" Hex Shank, PH.0~PH.1 Reversible Blade, 180mmL	D-48	350
500052	#2 Square Screwdriver w/Plastic Handle, 100mmL	D-51	545	502212	1/4" Hex Shank, PH.1~PH.2 Reversible Blade, 180mmL	D-48	350
500053	#3 Square Screwdriver w/Plastic Handle, 100mmL	D-51	545	502223	1/4" Hex Shank, PH.2~PH.3 Reversible Blade, 180mmL	D-48	350
500054	#4 Square Screwdriver w/Plastic Handle, 100mmL	D-51	655	502311	1/4" Hex Shank, PH.1~PZ.1 Reversible Blade, 180mmL	D-48	350
500106	6" Flat Type Machinists File (2nd. Cut)	G-13	880	502322	1/4" Hex Shank, PH.2~PZ.2 Reversible Blade, 180mmL	D-48	350
500108	8" Flat Type Machinists File (2nd. Cut)	G-13	1050	502401	1/4" Hex Shank, PZ.0~PZ.1 Reversible Blade, 180mmL	D-48	350
500110	10" Flat Type Machinists File (2nd. Cut)	G-13	1350	502412	1/4" Hex Shank, PZ.1~PZ.2 Reversible Blade, 180mmL	D-48	350
500112	12" Flat Type Machinists File (2nd. Cut)	G-13	1580	502423	1/4" Hex Shank, PZ.2~PZ.3 Reversible Blade, 180mmL	D-48	350
500206	6" Round Type Machinists File (2nd. Cut)	G-13	880	502427	Double Flexible Socket Wrenches -Mirror Finish 24 x 27 mm	F-15	4110
500208	8" Round Type Machinists File (2nd. Cut)	G-13	1050	5025	1/4" Hex Shank, T-25 Pentacle Screwdriver Bit, 30mmL	D-16	110
500210	10" Round Type Machinists File (2nd. Cut)	G-13	1350	502515	1/4" Hex Shank, T10~T15 Reversible Blade, 180mmL	D-48	350
500212	12" Round Type Machinists File (2nd. Cut)	G-13	1580	502525	1/4" Hex Shank, T20~T25 Reversible Blade, 180mmL	D-48	350
500306	6" Half Round Type Machinists File (2nd. Cut)	G-13	1050	502540	1/4" Hex Shank, T30~T40 Reversible Blade, 180mmL	D-48	350
500308	8" Half Round Type Machinists File (2nd. Cut)	G-13	1200	502625	1/4" Hex Shank, 2.5mm~2.5mm Reversible Blade, 180mmL	D-48	350
500310	10" Half Round Type Machinists File (2nd. Cut)	G-13	1520	502630	1/4" Hex Shank, 3.0mm~3.0mm Reversible Blade, 180mmL	D-48	350
500312	12" Half Round Type Machinists File (2nd. Cut)	G-13	1780	502640	1/4" Hex Shank, 4.0mm~4.0mm Reversible Blade, 180mmL	D-48	350
500406	6" Square Type Machinists File (2nd. Cut)	G-13	880	502650	1/4" Hex Shank, 5.0mm~5.0mm Reversible Blade, 180mmL	D-48	350
500408	8" Square Type Machinists File (2nd. Cut)	G-13	1050	502653	Air Tire Buffer	E-25	13100
500410	10" Square Type Machinists File (2nd. Cut)	G-13	1350	502660	1/4" Hex Shank, 6.0mm~6.0mm Reversible Blade, 180mmL	D-48	350
500412	12" Square Type Machinists File (2nd. Cut)	G-13	1580	5027	1/4" Hex Shank, T-27 Pentacle Screwdriver Bit, 30mmL	D-16	110
500506	6" Triangle Type Machinists File (2nd. Cut)	G-13	950	5030	1/4" Hex Shank, T-30 Pentacle Screwdriver Bit, 30mmL	D-16	110
500508	8" Triangle Type Machinists File (2nd. Cut)	G-13	1020	503032	Double Flexible Socket Wrenches -Mirror Finish 30 x 32 mm	F-15	4850
500510	10" Triangle Type Machinists File (2nd. Cut)	G-13	1300	503100	Ultra Duty Air Riveter	E-23	72400
500512	12" Triangle Type Machinists File (2nd. Cut)	G-13	1480	504+0400	PH.0 Philips Screwdriver w/Soft Handle, 155mmL	D-40	420
500607	Double Flexible Socket Wrenches -Mirror Finish 6 x 7 mm	F-15	1050	504+0430	0.5 x 3.0mm Slotted Screwdriver w/Soft Handle, 155mmL	D-40	420
500681	Flat Type Small File	G-12	700	504+0440	0.8 x 4.0mm Slotted Screwdriver w/Soft Handle, 180mmL	D-40	450
500682	Round Type Small File	G-12	700	504+0450	PZ.0 Posidriv Screwdriver w/Soft Handle, 155mmL	D-40	420
500683	Half Round Type Small File	G-12	700	504+0531	PH.1 Philips Screwdriver w/Soft Handle, 330mmL	D-40	700
500684	Square Type Square Type Small File	G-12	700	504+0550	0.8 x 5.0mm Slotted Screwdriver w/Soft Handle, 330mmL	D-40	700
500685	Triangle Type Small File	G-12	700	504+0561	PZ.1 Posidriv Screwdriver w/Soft Handle, 230mmL	D-40	500
500686	Trapezoid Type Small File	G-12	700	504+1240	0.8 x 4.0mm Slotted Screwdriver w/Soft Handle, 180mmL	D-40	480
500687	Warding Type Small File	G-12	700	504+1401	PH.1 Philips Screwdriver w/Soft Handle, 170mmL	D-40	480
500781	Flat Type Diamond File, dia. 4mm	G-12	750	504+1421	PH.1 Philips Screwdriver w/Soft Handle, 200mmL	D-40	500
500782	Round Type Diamond File, dia. 4mm	G-12	750	504+1741	PZ.1 Posidriv Screwdriver w/Soft Handle, 155mmL	D-40	460
500783	Half Round Type Diamond File, dia. 4mm	G-12	750	504+1841	PZ.1 Posidriv Screwdriver w/Soft Handle, 180mmL	D-40	480
500784	Square Type Diamond File, dia. 4mm	G-12	750	504+1951	PZ.1 Posidriv Screwdriver w/Soft Handle, 205mmL	D-40	500
500785	Triangle Type Diamond File, dia. 4mm	G-12	750	504+1971	PZ.1 Posidriv Screwdriver w/Soft Handle, 330mmL	D-40	750
5008	1/4" Hex Shank, T-8 Pentacle Screwdriver Bit, 30mmL	D-16	110	504+2622	2mm Hex Screwdriver w/Soft Handle, 150mmL	D-42	490
500809	Double Flexible Socket Wrenches -Mirror Finish 8 x 9 mm	F-15	1050	504+2625	2.5mm Hex Screwdriver w/Soft Handle, 150mmL	D-42	490
500861	Flat Type Air File, dia. 5mm	G-12	700	504+2633	3mm Hex Screwdriver w/Soft Handle, 150mmL	D-42	490
500862	Round Type Air File, dia. 5mm	G-12	700	504+3604	1/16" Hex Screwdriver w/Soft Handle, 150mmL	D-42	490
500863	Half Round Type Air File, dia. 5mm	G-12	700	504+3605	5/64" Hex Screwdriver w/Soft Handle, 150mmL	D-42	490
500864	Square Type Air File, dia. 5mm	G-12	700	504+3606	3/32" Hex Screwdriver w/Soft Handle, 150mmL	D-42	490
500865	Triangle Type Air File, dia. 5mm	G-12	700	504+3607	7/64" Hex Screwdriver w/Soft Handle, 150mmL	D-42	490
5010	1/4" Hex Shank, T-10 Pentacle Screwdriver Bit, 30mmL	D-16	110	504+3608	1/8" Hex Screwdriver w/Soft Handle, 150mmL	D-42	490
501011	Double Flexible Socket Wrenches -Mirror Finish 10 x 11 mm	F-15	1050	504+4633	3mm Wobble Hex Screwdriver w/Soft Handle, 150mmL	D-42	540
501213	Double Flexible Socket Wrenches -Mirror Finish 12 x 13 mm	F-15	1280	504+5608	1/8" Wobble Hex Screwdriver w/Soft Handle, 150mmL	D-42	540
501300	Super Duty Air Riveter	E-22	8900	504+6606	T-6 Star Screwdriver w/Soft Handle, 150mmL	D-41	490
501415	Double Flexible Socket Wrenches -Mirror Finish 14 x 15 mm	F-15	1500	504+6607	T-7 Star Screwdriver w/Soft Handle, 150mmL	D-41	490
5015	1/4" Hex Shank, T-15 Pentacle Screwdriver Bit, 30mmL	D-16	110	504+6608	T-8 Star Screwdriver w/Soft Handle, 150mmL	D-41	490
501600	Super Duty Air Riveter	E-23	11300	504+6609	T-9 Star Screwdriver w/Soft Handle, 150mmL	D-41	490
501617	Double Flexible Socket Wrenches -Mirror Finish 16 x 17 mm	F-15	1710	504+7606	T-6 Tamperproof Star Screwdriver w/Soft Handle, 150mmL	D-41	540
501800	#5 Spline Dr. Air Impact Wrench, 1,800 ft. lbs. / 2,439 Nm	E-18	152000	504+7607	T-7 Tamperproof Star Screwdriver w/Soft Handle, 150mmL	D-41	540
501806	#5 Spline Dr. Long Anvil Air Impact Wrench, 1,800 ft. lbs. / 2,439 Nm	E-18	159000	504+7608	T-8 Tamperproof Star Screwdriver w/Soft Handle, 150mmL	D-41	540
501819	Double Flexible Socket Wrenches -Mirror Finish 18 x 19 mm	F-15	1950	504+7609	T-9 Tamperproof Star Screwdriver w/Soft Handle, 150mmL	D-41	540
501940	Super Duty Air Riveter	E-23	17500	5040	5/16" Hex Shank, T-40 Pentacle Screwdriver Bit, 30mmL	D-16	150
501990	Heavy Duty Air Riveter	E-23	26400	5045	5/16" Hex Shank, T-45 Pentacle Screwdriver Bit, 30mmL	D-16	150
502+0501	PZ.1 Posidriv Screwdriver w/Soft Handle, 98mmL	D-40	380	5050	10mm Hex Shank, T-50 Pentacle Screwdriver Bit, 30mmL	D-16	220
502+0502	PZ.2 Posidriv Screwdriver w/Soft Handle, 98mmL	D-40	400	505105	5" Heavy Duty Air Angle Grinder	E-19	47750
502+1201	PH.1 Philips Screwdriver w/Soft Handle, 98mmL	D-40	400	5055	12mm Hex Shank, T-55 Pentacle Screwdriver Bit, 30mmL	D-16	270
502+1202	PH.2 Philips Screwdriver w/Soft Handle, 98mmL	D-40	430	505506	5" Air Angle Grinder	E-19	20150
502+1465	1.2 x 6.5mm Slotted Screwdriver w/Soft Handle, 98mmL	D-40	430	506+0175	1/4" Dr. Socket Driver	B-7	810
5020	1/4" Hex Shank, T-20 Pentacle Screwdriver Bit, 30mmL	D-16	110	506+0560	1.0 x 6.0mm Slotted Screwdriver w/Soft Handle, 250mmL	D-40	640
502022	Double Flexible Socket Wrenches -Mirror Finish 20 x 22 mm	F-15	2970	506+0602	PH.2 Philips Screwdriver w/Soft Handle, 175mmL	D-40	540
502046	1/4" Hex Shank, 0.8x4.0~1.2x6.5mm Reversible Blade, 180mmL	D-48	350	506+0612	PH.2 Philips Screwdriver w/Soft Handle, 250mmL	D-40	640
502057	1/4" Hex Shank, 1.0x5.5~1.5x7.0mm Reversible Blade, 180mmL	D-48	350	506+0632	PH.2 Philips Screwdriver w/Soft Handle, 400mmL	D-40	740
502114	1/4" Hex Shank, PH.1~0.6x4.0mm Reversible Blade, 180mmL	D-48	350	506+0662	PZ.2 Posidriv Screwdriver w/Soft Handle, 300mmL	D-40	740
502123	Double Flexible Socket Wrenches -Mirror Finish 21 x 23 mm	F-15	3080	506+0680	1.2 x 8.0mm Slotted Screwdriver w/Soft Handle, 300mmL	D-40	840

Item No.	Description	Pg.	Code	Item No.	Description	Pg.	Code
506+1455	1.0 x 5.5mm Slotted Screwdriver w/Soft Handle, 200mmL	D-40	540	508+9803	#3 Square Screwdriver w/Soft Handle, 245mmL	D-41	770
506+1712	PH.2 Philips Screwdriver w/Soft Handle, 200mmL	D-40	660	508+9804	#4 Square Screwdriver w/Soft Handle, 245mmL	D-41	770
506+1802	PH.2 Philips Screwdriver w/Soft Handle, 225mmL	D-40	690	508003	4 in 1 Screwdriver, PH.1, PH.2, 0.8 x 5.0mm, 1.0 x 6.0mm	D-50	1360
506+1842	PZ.2 Posidriv Screwdriver w/Soft Handle, 200mmL	D-40	660	509+1801	PH.1 Philips Tang-Thru Screwdriver, 220mmL	D-43	870
506+1902	PH.2 Philips Screwdriver w/Soft Handle, 300mmL	D-40	860	509+1812	PH.2 Philips Tang-Thru Screwdriver, 245mmL	D-43	920
506+1952	PZ.2 Posidriv Screwdriver w/Soft Handle, 250mmL	D-40	740	509+1843	PH.3 Philips Tang-Thru Screwdriver, 255mmL	D-43	1220
506+1965	1.2 x 6.5mm Slotted Screwdriver w/Soft Handle, 200mmL	D-40	660	509+1924	PH.4 Philips Tang-Thru Screwdriver, 305mmL	D-43	1560
506+1966	1.2 x 6.5mm Slotted Screwdriver w/Soft Handle, 250mmL	D-40	740	509+1943	PZ.3 Posidriv Tang-Thru Screwdriver, 270mmL	D-43	1240
506+1972	PZ.2 Posidriv Screwdriver w/Soft Handle, 400mmL	D-40	990	509+1951	PZ.1 Posidriv Tang-Thru Screwdriver, 220mmL	D-43	870
506+1980	1.2 x 8.0mm Slotted Screwdriver w/Soft Handle, 280mmL	D-40	1060	509+1952	PZ.2 Posidriv Tang-Thru Screwdriver, 245mmL	D-43	920
506+2634	4mm Hex Screwdriver w/Soft Handle, 170mmL	D-42	540	509+1966	1.2 x 6.5mm Slotted Tang-Thru Screwdriver, 245mmL	D-43	920
506+2735	5mm Hex Screwdriver w/Soft Handle, 185mmL	D-42	540	509+1974	PZ.4 Posidriv Tang-Thru Screwdriver, 320mmL	D-43	1620
506+2736	6mm Hex Screwdriver w/Soft Handle, 185mmL	D-42	540	509+1990	1.6 x 10.0mm Slotted Tang-Thru Screwdriver, 305mmL	D-43	1560
506+3610	5/32" Hex Screwdriver w/Soft Handle, 170mmL	D-42	540	509+1992	2.0 x 12.0mm Slotted Tang-Thru Screwdriver, 315mmL	D-43	1820
506+3712	3/16" Hex Screwdriver w/Soft Handle, 185mmL	D-42	620	509+1994	2.5 x 14.0mm Slotted Tang-Thru Screwdriver, 365mmL	D-43	1920
506+3714	7/32" Hex Screwdriver w/Soft Handle, 185mmL	D-42	620	5108	1/4" Hex Shank, 1/8" Wobble Hex Hex Screwdriver Bit, 30mmL	D-9	85
506+3816	1/4" Hex Screwdriver w/Soft Handle, 225mmL	D-42	690	5110	1/4" Hex Shank, 5/32" Wobble Hex Hex Screwdriver Bit, 30mmL	D-9	85
506+4634	4mm Wobble Hex Screwdriver w/Soft Handle, 170mmL	D-42	590	511001L	Left Cut Aviation Snip, 250mmL	G-10	1950
506+4735	5mm Wobble Hex Screwdriver w/Soft Handle, 185mmL	D-42	670	511002R	Right Cut Aviation Snip, 250mmL	G-10	1950
506+4736	6mm Wobble Hex Screwdriver w/Soft Handle, 185mmL	D-42	670	511003S	Straight Cut Aviation Snip, 250mmL	G-10	1950
506+5610	5/32" Wobble Hex Screwdriver w/Soft Handle, 170mmL	D-42	590	511004L	Offset-Left Cut Aviation Snip, 250mmL	G-10	2550
506+5712	3/16" Wobble Hex Screwdriver w/Soft Handle, 185mmL	D-42	670	511005R	Offset-Right Cut Aviation Snip, 250mmL	G-10	2550
506+5714	7/32" Wobble Hex Screwdriver w/Soft Handle, 185mmL	D-42	670	5112	1/4" Hex Shank, 3/16" Wobble Hex Hex Screwdriver Bit, 30mmL	D-9	85
506+5816	1/4" Wobble Hex Screwdriver w/Soft Handle, 225mmL	D-42	750	511214	Double Flexible Socket Wrenches -Mirror Finish 3/8" x 7/16" mm	F-15	1070
506+6710	T-10 Star Screwdriver w/Soft Handle, 185mmL	D-41	620	5114	1/4" Hex Shank, 7/32" Wobble Hex Hex Screwdriver Bit, 30mmL	D-9	85
506+6715	T-15 Star Screwdriver w/Soft Handle, 185mmL	D-41	620	5116	1/4" Hex Shank, 1/4" Wobble Hex Hex Screwdriver Bit, 30mmL	D-9	85
506+6720	T-20 Star Screwdriver w/Soft Handle, 185mmL	D-41	620	511618	Double Flexible Socket Wrenches -Mirror Finish 1/2" x 9/16" mm	F-15	1340
506+6725	T-25 Star Screwdriver w/Soft Handle, 185mmL	D-41	620	5118	5/16" Hex Shank, 9/32" Wobble Hex Hex Screwdriver Bit, 30mmL	D-9	125
506+6827	T-27 Star Screwdriver w/Soft Handle, 225mmL	D-41	690	5120	5/16" Hex Shank, 5/16" Wobble Hex Hex Screwdriver Bit, 30mmL	D-9	125
506+6830	T-30 Star Screwdriver w/Soft Handle, 225mmL	D-41	690	512022	Double Flexible Socket Wrenches -Mirror Finish 5/8" x 11/16" mm	F-15	1740
506+7710	T-10 Tamperproof Star Screwdriver w/Soft Handle, 180mmL	D-41	670	5124	3/8" Hex Shank, 3/8" Wobble Hex Hex Screwdriver Bit, 30mmL	D-9	180
506+7715	T-15 Tamperproof Star Screwdriver w/Soft Handle, 180mmL	D-41	670	512428	Double Flexible Socket Wrenches -Mirror Finish 3/4" x 7/8" mm	F-15	2670
506+7827	T-27 Tamperproof Star Screwdriver w/Soft Handle, 225mmL	D-41	750	520+2982	T-Handle Ratcheting Screwdriver, 72mmL	D-23	2100
506+7830	T-30 Tamperproof Star Screwdriver w/Soft Handle, 225mmL	D-41	750	520+2983	T-Handle Ratcheting Screwdriver, 72mmL	D-23	2300
506+7920	T-20 Tamperproof Star Screwdriver w/Soft Handle, 200mmL	D-41	720	520+2985	T-Handle Ratcheting Screwdriver, 100mmL	D-23	2300
506+7925	T-25 Tamperproof Star Screwdriver w/Soft Handle, 200mmL	D-41	720	520+2988	T-Handle Ratcheting Screwdriver, 135mmL	D-23	2500
506+9800	#0 Square Screwdriver w/Soft Handle, 225mmL	D-41	690	520+2990	T-Handle Ratcheting Screwdriver, 250mmL	D-23	3200
506+9801	#1 Square Screwdriver w/Soft Handle, 225mmL	D-41	690	5208	1/4" Hex Shank, T-8 Pentacle Screwdriver Bit, 56mmL	D-16	180
508+0833	PH.3 Philips Screwdriver w/Soft Handle, 390mmL	D-40	1120	5210	1/4" Hex Shank, T-10 Pentacle Screwdriver Bit, 56mmL	D-16	180
508+0890	1.6 x 10.0mm Slotted Screwdriver w/Soft Handle, 370mmL	D-40	1320	521205	T-5 Micro-Tech Star Screwdriver, 122mmL	D-55	280
508+1843	PH.3 Philips Screwdriver w/Soft Handle, 270mmL	D-40	1120	521206	T-6 Micro-Tech Star Screwdriver, 122mmL	D-55	280
508+1913	PH.3 Philips Screwdriver w/Soft Handle, 245mmL	D-40	1070	521207	T-7 Micro-Tech Star Screwdriver, 122mmL	D-55	280
508+1923	PH.3 Philips Screwdriver w/Soft Handle, 320mmL	D-40	1170	521208	T-8 Micro-Tech Star Screwdriver, 122mmL	D-55	280
508+1924	PH.4 Philips Screwdriver w/Soft Handle, 320mmL	D-40	1460	5215	1/4" Hex Shank, T-15 Pentacle Screwdriver Bit, 56mmL	D-16	180
508+1943	PZ.3 Posidriv Screwdriver w/Soft Handle, 295mmL	D-40	1140	521505	T-5 Micro-Tech Star Screwdriver, 155mmL	D-55	320
508+1974	PZ.4 Posidriv Screwdriver w/Soft Handle, 340mmL	D-40	1520	521506	T-6 Micro-Tech Star Screwdriver, 155mmL	D-55	320
508+1990	1.6 x 10.0mm Slotted Screwdriver w/Soft Handle, 320mmL	D-40	1460	521507	T-7 Micro-Tech Star Screwdriver, 155mmL	D-55	320
508+1992	2.0 x 12.0mm Slotted Screwdriver w/Soft Handle, 320mmL	D-40	1720	521508	T-8 Micro-Tech Star Screwdriver, 155mmL	D-55	320
508+1994	2.5 x 14.0mm Slotted Screwdriver w/Soft Handle, 370mmL	D-40	1820	521509	T-9 Micro-Tech Star Screwdriver, 155mmL	D-55	320
508+2847	7mm Hex Screwdriver w/Soft Handle, 235mmL	D-42	920	521510	T-10 Micro-Tech Star Screwdriver, 155mmL	D-55	320
508+2848	8mm Hex Screwdriver w/Soft Handle, 235mmL	D-42	920	521515	T-15 Micro-Tech Star Screwdriver, 155mmL	D-55	320
508+2849	9mm Hex Screwdriver w/Soft Handle, 235mmL	D-42	1120	521520	T-20 Micro-Tech Star Screwdriver, 155mmL	D-55	320
508+2850	10mm Hex Screwdriver w/Soft Handle, 235mmL	D-42	1120	522+2982	Stubby Handle Ratcheting Screwdriver, 87mmL	D-23	2000
508+3818	9/32" Hex Screwdriver w/Soft Handle, 235mmL	D-42	920	522+2983	Stubby Handle Ratcheting Screwdriver, 87mmL	D-23	2200
508+3820	5/16" Hex Screwdriver w/Soft Handle, 235mmL	D-42	920	522+2985	Stubby Handle Ratcheting Screwdriver, 115mmL	D-23	2200
508+3824	3/8" Hex Screwdriver w/Soft Handle, 235mmL	D-42	1120	5220	1/4" Hex Shank, T-20 Pentacle Screwdriver Bit, 56mmL	D-16	180
508+4847	7mm Wobble Hex Screwdriver w/Soft Handle, 235mmL	D-42	980	5225	1/4" Hex Shank, T-25 Pentacle Screwdriver Bit, 56mmL	D-16	180
508+4848	8mm Wobble Hex Screwdriver w/Soft Handle, 235mmL	D-42	980	5227	1/4" Hex Shank, T-27 Pentacle Screwdriver Bit, 56mmL	D-16	180
508+4849	9mm Wobble Hex Screwdriver w/Soft Handle, 235mmL	D-42	1180	5230	1/4" Hex Shank, T-30 Pentacle Screwdriver Bit, 56mmL	D-16	180
508+4850	10mm Wobble Hex Screwdriver w/Soft Handle, 235mmL	D-42	1180	523209	0.9mm Micro-Tech Hex Screwdriver, 122mmL	D-55	280
508+5818	9/32" Wobble Hex Screwdriver w/Soft Handle, 235mmL	D-42	980	523213	1.3mm Micro-Tech Hex Screwdriver, 122mmL	D-55	280
508+5820	5/16" Wobble Hex Screwdriver w/Soft Handle, 235mmL	D-42	980	523215	1.5mm Micro-Tech Hex Screwdriver, 122mmL	D-55	280
508+5824	3/8" Wobble Hex Screwdriver w/Soft Handle, 235mmL	D-42	1180	523520	2.0mm Micro-Tech Hex Screwdriver, 155mmL	D-55	320
508+6840	T-40 Star Screwdriver w/Soft Handle, 235mmL	D-41	770	523525	2.5mm Micro-Tech Hex Screwdriver, 155mmL	D-55	320
508+6845	T-45 Star Screwdriver w/Soft Handle, 235mmL	D-41	920	523530	3.0mm Micro-Tech Hex Screwdriver, 155mmL	D-55	320
508+6850	T-50 Star Screwdriver w/Soft Handle, 235mmL	D-41	920	524+2982	Standard Handle Ratcheting Screwdriver, 162mmL	D-23	2100
508+7850	T-50 Tamperproof Star Screwdriver w/Soft Handle, 235mmL	D-41	980	524+2983	Standard Handle Ratcheting Screwdriver, 162mmL	D-23	2300
508+7940	T-40 Tamperproof Star Screwdriver w/Soft Handle, 255mmL	D-41	910	524+2985	Standard Handle Ratcheting Screwdriver, 190mmL	D-23	2300
508+7945	T-45 Tamperproof Star Screwdriver w/Soft Handle, 255mmL	D-41	1080	524+2988	Standard Handle Ratcheting Screwdriver, 225mmL	D-23	2500
508+9802	#2 Square Screwdriver w/Soft Handle, 245mmL	D-41	770	524+2990	Standard Handle Ratcheting Screwdriver, 340mmL	D-23	3200

Item No.	Description	Pg.	Code
5240	5/16" Hex Shank, T-40 Pentacle Screwdriver Bit, 56mmL	D-16	230
524403	1/20" Micro-Tech Hex Screwdriver, 122mmL	D-55	280
524404	1/16" Micro-Tech Hex Screwdriver, 122mmL	D-55	280
5245	5/16" Hex Shank, T-45 Pentacle Screwdriver Bit, 56mmL	D-16	230
524505	5/64" Micro-Tech Hex Screwdriver, 155mmL	D-55	320
524506	3/32" Micro-Tech Hex Screwdriver, 155mmL	D-55	320
524507	7/64" Micro-Tech Hex Screwdriver, 155mmL	D-55	320
5250	10mm Hex Shank, T-50 Pentacle Screwdriver Bit, 56mmL	D-16	300
5255	12mm Hex Shank, T-55 Pentacle Screwdriver Bit, 56mmL	D-16	380
526+2983	Pistol Grip Handle Ratcheting Screwdriver, 215mmL	D-23	2800
526+2985	Pistol Grip Handle Ratcheting Screwdriver, 215mmL	D-23	2800
526+2986	Pistol Grip Handle Ratcheting Screwdriver, 215mmL	D-23	3000
526+2988	Pistol Grip Handle Ratcheting Screwdriver, 250mmL	D-23	3000
530305A	Curved Jaw Locking Pliers with Cutter, 125mmL	G-5	1500
530306AR	Locking "C" Clamp w/ Swivel Pads, 150mmL	G-5	2300
530307A	Curved Jaw Locking Pliers with Cutter, 175mmL	G-5	1550
530307RA	Straight Jaw Locking Pliers, 175mmL	G-5	1690
530310A	Curved Jaw Locking Pliers with Cutter, 250mmL	G-5	1625
530310RA	Straight Jaw Locking Pliers, 250mmL	G-5	1750
530311AR	Locking "C" Clamp w/ Swivel Pads, 280mmL	G-5	3300
530318AR	Locking "C" Clamp w/ Swivel Pads, 460mmL	G-5	4100
530324AR	Locking "C" Clamp w/ Swivel Pads, 610mmL	G-5	6100
5308	1/4" Hex Shank, 1/8" Wobble Hex Hex Screwdriver Bit, 56mmL	D-9	150
5310	1/4" Hex Shank, 5/32" Wobble Hex Hex Screwdriver Bit, 56mmL	D-9	150
5312	1/4" Hex Shank, 3/16" Wobble Hex Hex Screwdriver Bit, 56mmL	D-9	150
531306LN	Long Nose Locking Pliers with Cutter, 150mmL	G-5	1750
531309LN	Long Nose Locking Pliers with Cutter, 225mmL	G-5	2100
5314	1/4" Hex Shank, 7/32" Wobble Hex Hex Screwdriver Bit, 56mmL	D-9	150
5316	1/4" Hex Shank, 1/4" Wobble Hex Hex Screwdriver Bit, 56mmL	D-9	150
5318	5/16" Hex Shank, 9/32" Wobble Hex Hex Screwdriver Bit, 56mmL	D-9	190
5320	5/16" Hex Shank, 5/16" Wobble Hex Hex Screwdriver Bit, 56mmL	D-9	190
532308SM	Sheet Metal Pliers, 200mmL	G-5	2700
5324	3/8" Hex Shank, 3/8" Wobble Hex Hex Screwdriver Bit, 56mmL	D-9	250
533309LW	Locking Welding Clamp, 225mmL	G-5	3300
534312LJ	Large Jaw Locking Pliers, 250mmL	G-5	2600
535307	7" HOSE CLAMP PLIERS, 175mmL	G-6	3830
535309	9" HOSE CLAMP PLIERS, 230mmL	G-6	4360
536062	Glaw-Grip Pliers, 150mmL	G-6	1500
536064	Glaw-Grip Pliers, 150mmL	G-6	1500
537807	Pinch-Off Locking Pliers, 180mmL	G-5	2000
537811	Pinch-Off Locking Pliers, 280mmL	G-5	4400
538418	Locking Chain Pliers, 460mmL	G-6	2400
539606	Locking "C" Clamp, 150mmL	G-5	1800
539611	Locking "C" Clamp, 280mmL	G-5	2700
539618	Locking "C" Clamp, 460mmL	G-5	3900
539624	Locking "C" Clamp, 610mmL	G-5	6000
540200	#5 Spline Dr. Impact Extension Bar, 200mmL (CR-Mo)	A-78	14000
540380	#5 Spline Dr. Impact Extension Bar, 380mmL (CR-Mo)	A-78	18900
540505	#5 Spline Dr. Impact Universal Joint (CR-Mo)	A-78	13200
540508	#5 Spline Dr. Impact Adapter, #5 F x 1" M (CR-Mo)	A-78	7800
5408	1/4" Hex Shank, T-8 Pentacle Screwdriver Bit, 88mmL	D-16	360
5410	1/4" Hex Shank, T-10 Pentacle Screwdriver Bit, 88mmL	D-16	360
5415	1/4" Hex Shank, T-15 Pentacle Screwdriver Bit, 88mmL	D-16	360
5420	1/4" Hex Shank, T-20 Pentacle Screwdriver Bit, 88mmL	D-16	360
5425	1/4" Hex Shank, T-25 Pentacle Screwdriver Bit, 88mmL	D-16	360
5427	1/4" Hex Shank, T-27 Pentacle Screwdriver Bit, 88mmL	D-16	360
5430	1/4" Hex Shank, T-30 Pentacle Screwdriver Bit, 88mmL	D-16	360
5440	5/16" Hex Shank, T-40 Pentacle Screwdriver Bit, 88mmL	D-16	410
5445	5/16" Hex Shank, T-45 Pentacle Screwdriver Bit, 88mmL	D-16	410
5450	10mm Hex Shank, T-50 Pentacle Screwdriver Bit, 88mmL	D-16	530
5455	12mm Hex Shank, T-55 Pentacle Screwdriver Bit, 88mmL	D-16	700
546017S	#5 Spline Dr. 17mm Budd Wheel Impact Socket	A-76	5040
546019S	#5 Spline Dr. 19mm Budd Wheel Impact Socket	A-76	5040
546020S	#5 Spline Dr. 20mm Budd Wheel Impact Socket	A-76	5040
546021S	#5 Spline Dr. 21mm Budd Wheel Impact Socket	A-76	5040
547022	#5 Spline Dr. 22mm Impact Socket (CR-Mo)	A-76	4650
547024	#5 Spline Dr. 24mm Impact Socket (CR-Mo)	A-76	4650
547025	#5 Spline Dr. 25mm Impact Socket (CR-Mo)	A-76	4650
547027	#5 Spline Dr. 27mm Impact Socket (CR-Mo)	A-76	4650
547029	#5 Spline Dr. 29mm Impact Socket (CR-Mo)	A-76	4650

Item No.	Description	Pg.	Code
547030	#5 Spline Dr. 30mm Impact Socket (CR-Mo)	A-76	4650
547032	#5 Spline Dr. 32mm Impact Socket (CR-Mo)	A-76	4650
547033	#5 Spline Dr. 33mm Impact Socket (CR-Mo)	A-76	4650
547035	#5 Spline Dr. 35mm Impact Socket (CR-Mo)	A-76	4650
547038	#5 Spline Dr. 38mm Impact Socket (CR-Mo)	A-76	4650
547041	#5 Spline Dr. 41mm Impact Socket (CR-Mo)	A-76	4650
547046	#5 Spline Dr. 46mm Impact Socket (CR-Mo)	A-76	4860
549522	#5 Spline Dr. 22mm Deep Impact Socket (CR-Mo)	A-77	7760
549524	#5 Spline Dr. 24mm Deep Impact Socket (CR-Mo)	A-77	7760
549525	#5 Spline Dr. 25mm Deep Impact Socket (CR-Mo)	A-77	7760
549527	#5 Spline Dr. 27mm Deep Impact Socket (CR-Mo)	A-77	7760
549529	#5 Spline Dr. 29mm Deep Impact Socket (CR-Mo)	A-77	7760
549530	#5 Spline Dr. 30mm Deep Impact Socket (CR-Mo)	A-77	7760
549532	#5 Spline Dr. 32mm Deep Impact Socket (CR-Mo)	A-77	7760
549533	#5 Spline Dr. 33mm Deep Impact Socket (CR-Mo)	A-77	7760
549535	#5 Spline Dr. 35mm Deep Impact Socket (CR-Mo)	A-77	7760
549538	#5 Spline Dr. 38mm Deep Impact Socket (CR-Mo)	A-77	7760
549541	#5 Spline Dr. 41mm Deep Impact Socket (CR-Mo)	A-77	7760
549546	#5 Spline Dr. 46mm Deep Impact Socket (CR-Mo)	A-77	8100
550504	Chain Nose Pliers with Cutter, 125mmL	G-3	2020
550507	Diagonal Cutting Pliers, 125mmL	G-3	2020
550550	External Straight Retaining Ring Pliers, 125mmL	G-2	2050
550551	Internal Straight Retaining Ring Pliers, 125mmL	G-2	2050
550552	External 90 degree Retaining Ring Pliers, 125mmL	G-2	2050
550553	Internal 90 degree Retaining Ring Pliers, 125mmL	G-2	2050
550604	Chain Nose Pliers with Cutter, 150mmL	G-3	2080
550604D	Chain Nose Pliers with Cutter w/plastic handle, 150mmL	G-4	1700
550604S	Chain Nose Pliers with Cutter w/soft handle, 150mmL	G-2	1800
550606	Needle Nose Pliers, 150mmL	G-3	2080
550607	Diagonal Cutting Pliers, 150mmL	G-3	2080
550607D	Diagonal Cutting Pliers w/plastic handle, 150mmL	G-4	2150
550607S	Diagonal Cutting Pliers w/soft handle, 150mmL	G-2	2250
550609	Combination (Slip Joint) Pliers, 150mmL	G-3	1500
550611	Tongue and Groove Pliers, 150mmL	G-3	2100
550612D	Side Cutter Pliers w/plastic handle, 150mmL	G-4	2020
550612S	Side Cutter Pliers w/soft handle, 150mmL	G-2	2120
550613	End Cutter Pliers, 150mmL	G-3	2100
550614D	Bent Nose Pliers w/plastic handle, 150mmL	G-4	2000
550614S	Bent Nose Pliers w/soft handle, 150mmL	G-2	2100
550707	Diagonal Cutting Pliers, 175mmL	G-3	2130
550708	Heavy Duty Diagonal Cutting Pliers, 175mmL	G-3	2350
550708D	Heavy Duty Diagonal Cutting Pliers w/plastic handle, 175mmL	G-4	2220
550708S	Heavy Duty Diagonal Cutting Pliers w/soft handle, 175mmL	G-2	2330
550712	Side Cutter Pliers, 175mmL	G-3	2220
550712D	Side Cutter Pliers w/plastic handle, 175mmL	G-4	2250
550712S	Side Cutter Pliers w/soft handle, 175mmL	G-2	2350
550750	External Straight Retaining Ring Pliers, 175mmL	G-2	2200
550751	Internal Straight Retaining Ring Pliers, 175mmL	G-2	2200
550752	External 90 degree Retaining Ring Pliers, 175mmL	G-2	2200
550753	Internal 90 degree Retaining Ring Pliers, 175mmL	G-2	2200
5508	1/4" Hex Shank, 1/8" Wobble Hex Hex Screwdriver Bit, 88mmL	D-9	300
550804	Chain Nose Pliers with Cutter, 200mmL	G-3	2450
550804D	Chain Nose Pliers with Cutter w/plastic handle, 200mmL	G-4	2200
550804S	Chain Nose Pliers with Cutter w/soft handle, 200mmL	G-2	2300
550805	Duckbill Pliers, 200mmL	G-3	1800
550808	Heavy Duty Diagonal Cutting Pliers, 200mmL	G-3	2500
550808D	Heavy Duty Diagonal Cutting Pliers w/plastic handle, 200mmL	G-4	2670
550808S	Heavy Duty Diagonal Cutting Pliers w/soft handle, 200mmL	G-2	2800
550809	Combination (Slip Joint) Pliers, 200mmL	G-3	1680
550810	Hose Clamp Pliers, 200mmL	G-3	1680
550811	Tongue and Groove Pliers, 200mmL	G-3	2350
550812	Side Cutter Pliers, 200mmL	G-3	2480
550812D	Side Cutter Pliers w/plastic handle, 200mmL	G-4	2880
550812S	Side Cutter Pliers w/soft handle, 200mmL	G-2	3000
550814D	Bent Nose Pliers w/plastic handle, 200mmL	G-4	2460
550814S	Bent Nose Pliers w/soft handle, 200mmL	G-2	2560
550950	External Straight Retaining Ring Pliers, 225mmL	G-2	3400
550951	Internal Straight Retaining Ring Pliers, 225mmL	G-2	3400
550952	External 90 degree Retaining Ring Pliers, 225mmL	G-2	3400
550953	Internal 90 degree Retaining Ring Pliers, 225mmL	G-2	3400

Item No.	Description	Pg.	Code	Item No.	Description	Pg.	Code
5510	1/4" Hex Shank, 5/32" Wobble Hex Hex Screwdriver Bit, 88mmL	D-9	300	565166	6mm Pin Punch, 160mmL	G-15	650
551009	Combination (Slip Joint) Pliers, 250mmL	G-3	1820	565205	5mm Pin Punch, 200mmL	G-15	700
551011	Tongue and Groove Pliers, 250mmL	G-3	2780	565206	6mm Pin Punch, 200mmL	G-15	750
551011D	Water Pump Pliers w/plastic handle, 250mmL	G-4	2770	565208	8mm Pin Punch, 200mmL	G-15	850
5512	1/4" Hex Shank, 3/16" Wobble Hex Hex Screwdriver Bit, 88mmL	D-9	300	565311	11 x 6mm Oval Bearing Punch, 150mmL	G-14	460
551211	Tongue and Groove Pliers, 300mmL	G-3	4030	565313	13 x 7mm Oval Bearing Punch, 250mmL	G-14	600
551250	External Straight Retaining Ring Pliers, 300mmL	G-2	4100	565315	15 x 8mm Oval Bearing Punch, 350mmL	G-14	880
551251	Internal Straight Retaining Ring Pliers, 300mmL	G-2	4100	565317	17 x 9mm Oval Bearing Punch, 500mmL	G-14	1260
551252	External 90 degree Retaining Ring Pliers, 300mmL	G-2	4100	5660245	#5 Spline Dr. 3/4" Budd Wheel Impact Socket	A-76	5040
551253	Internal 90 degree Retaining Ring Pliers, 300mmL	G-2	4100	5660265	#5 Spline Dr. 13/16" Budd Wheel Impact Socket	A-76	5040
5514	1/4" Hex Shank, 7/32" Wobble Hex Hex Screwdriver Bit, 88mmL	D-9	300	5660305	#5 Spline Dr. 15/16" Budd Wheel Impact Socket	A-76	5040
5516	1/4" Hex Shank, 1/4" Wobble Hex Hex Screwdriver Bit, 88mmL	D-9	300	566102	1/16" Pin Punch, 100mmL	G-15	400
551611	Tongue and Groove Pliers, 400mmL	G-3	5450	566103	3/32" Pin Punch, 100mmL	G-15	400
5518	5/16" Hex Shank, 9/32" Wobble Hex Hex Screwdriver Bit, 88mmL	D-9	340	566124	1/8" Pin Punch, 125mmL	G-15	400
5520	5/16" Hex Shank, 5/16" Wobble Hex Hex Screwdriver Bit, 88mmL	D-9	340	566145	5/32" Pin Punch, 140mmL	G-15	500
5524	3/8" Hex Shank, 3/8" Wobble Hex Hex Screwdriver Bit, 88mmL	D-9	440	566166	3/16" Pin Punch, 160mmL	G-15	550
560008	Pry Bar, 200mmL	G-18	450	566168	1/4" Pin Punch, 160mmL	G-15	650
560012	Pry Bar, 300mmL	G-18	580	566206	3/16" Pin Punch, 200mmL	G-15	700
560018	Pry Bar, 450mmL	G-18	1300	566208	1/4" Pin Punch, 200mmL	G-15	750
560024	Pry Bar, 600mmL	G-18	2100	566210	5/16" Pin Punch, 200mmL	G-15	850
560036	Pry Bar, 900mmL	G-18	4500	567028	#5 Spline Dr. 7/8" Impact Socket (CR-Mo)	A-76	4650
5601270	0.3 x 1.2mm Micro-Tech Slotted Screwdriver, 122mmL	D-55	280	567030	#5 Spline Dr. 15/16" Impact Socket (CR-Mo)	A-76	4650
5601670	0.3 x 1.6mm Micro-Tech Slotted Screwdriver, 122mmL	D-55	280	567032	#5 Spline Dr. 1" Impact Socket (CR-Mo)	A-76	4650
5602070	0.4 x 2.0mm Micro-Tech Slotted Screwdriver, 122mmL	D-55	280	567034	#5 Spline Dr. 1-1/16" Impact Socket (CR-Mo)	A-76	4650
560210	Air Micro Die Grinder	E-22	18700	567036	#5 Spline Dr. 1-1/8" Impact Socket (CR-Mo)	A-76	4650
5602570	0.4 x 2.5mm Micro-Tech Slotted Screwdriver, 122mmL	D-55	280	567038	#5 Spline Dr. 1-3/16" Impact Socket (CR-Mo)	A-76	4650
5603070	0.5 x 3.0mm Micro-Tech Slotted Screwdriver, 122mmL	D-55	280	567040	#5 Spline Dr. 1-1/4" Impact Socket (CR-Mo)	A-76	4650
560425	10" Wheel Balancing Weight Tool	J-10	2680	567042	#5 Spline Dr. 1-5/16" Impact Socket (CR-Mo)	A-76	4650
560610	1.0 x 6.0mm Offset Slotted Screwdriver, 125mmL	F-27	500	567044	#5 Spline Dr. 1-3/8" Impact Socket (CR-Mo)	A-76	4650
5608	1/4" Hex Shank, 1/8" Wobble Hex Hex Screwdriver Bit, 125mmL	D-9	350	567046	#5 Spline Dr. 1-7/16" Impact Socket (CR-Mo)	A-76	4650
560812	1.2 x 8.0mm Offset Slotted Screwdriver, 150mmL	F-27	500	567048	#5 Spline Dr. 1-1/2" Impact Socket (CR-Mo)	A-76	4650
560916	1.6 x 9.0mm Offset Slotted Screwdriver, 175mmL	F-27	500	567050	#5 Spline Dr. 1-9/16" Impact Socket (CR-Mo)	A-76	4650
5610	1/4" Hex Shank, 5/32" Wobble Hex Hex Screwdriver Bit, 125mmL	D-9	350	567052	#5 Spline Dr. 1-5/8" Impact Socket (CR-Mo)	A-76	4650
5612	1/4" Hex Shank, 3/16" Wobble Hex Hex Screwdriver Bit, 125mmL	D-9	350	567054	#5 Spline Dr. 1-11/16" Impact Socket (CR-Mo)	A-76	4650
561206	6mm Flat Chisel, 125mmL	G-15	350	567056	#5 Spline Dr. 1-3/4" Impact Socket (CR-Mo)	A-76	4650
5614	1/4" Hex Shank, 7/32" Wobble Hex Hex Screwdriver Bit, 125mmL	D-9	350	567058	#5 Spline Dr. 1-13/16" Impact Socket (CR-Mo)	A-76	4860
561410	10mm Flat Chisel, 140mmL	G-15	400	567060	#5 Spline Dr. 1-7/8" Impact Socket (CR-Mo)	A-76	4860
561512	0.3 x 1.2mm Micro-Tech Slotted Screwdriver, 155mmL	D-55	320	567062	#5 Spline Dr. 1-15/16" Impact Socket (CR-Mo)	A-76	4860
561516	0.3 x 1.6mm Micro-Tech Slotted Screwdriver, 155mmL	D-55	320	567064	#5 Spline Dr. 2" Impact Socket (CR-Mo)	A-76	4860
561520	0.4 x 2.0mm Micro-Tech Slotted Screwdriver, 155mmL	D-55	320	567068	#5 Spline Dr. 2-1/8" Impact Socket (CR-Mo)	A-76	4860
561525	0.4 x 2.5mm Micro-Tech Slotted Screwdriver, 155mmL	D-55	320	567070	#5 Spline Dr. 2-3/16" Impact Socket (CR-Mo)	A-76	4980
561530	0.5 x 3.0mm Micro-Tech Slotted Screwdriver, 155mmL	D-55	320	567072	#5 Spline Dr. 2-1/4" Impact Socket (CR-Mo)	A-76	5700
5616	1/4" Hex Shank, 1/4" Wobble Hex Hex Screwdriver Bit, 125mmL	D-9	350	567076	#5 Spline Dr. 2-3/8" Impact Socket (CR-Mo)	A-76	6480
561612	12mm Flat Chisel, 150mmL	G-15	500	567080	#5 Spline Dr. 2-1/2" Impact Socket (CR-Mo)	A-76	7250
561614	14mm Flat Chisel, 150mmL	G-15	600	567084	#5 Spline Dr. 2-5/8" Impact Socket (CR-Mo)	A-76	7620
561616	16mm Flat Chisel, 160mmL	G-15	650	567088	#5 Spline Dr. 2-3/4" Impact Socket (CR-Mo)	A-76	8170
5618	5/16" Hex Shank, 9/32" Wobble Hex Hex Screwdriver Bit, 125mmL	D-9	450	567096	#5 Spline Dr. 3" Impact Socket (CR-Mo)	A-76	9400
5620	5/16" Hex Shank, 5/16" Wobble Hex Hex Screwdriver Bit, 125mmL	D-9	450	569528	#5 Spline Dr. 7/8" Deep Impact Socket (CR-Mo)	A-77	7760
562019	19mm Flat Chisel, 200mmL	G-15	900	569530	#5 Spline Dr. 15/16" Deep Impact Socket (CR-Mo)	A-77	7760
562022	22mm Flat Chisel, 200mmL	G-15	1100	569532	#5 Spline Dr. 1" Deep Impact Socket (CR-Mo)	A-77	7760
562025	25mm Flat Chisel, 200mmL	G-15	1350	569534	#5 Spline Dr. 1-1/16" Deep Impact Socket (CR-Mo)	A-77	7760
5624	3/8" Hex Shank, 3/8" Wobble Hex Hex Screwdriver Bit, 125mmL	D-9	650	569534T	#5 Spline Dr. 1-1/16" Deep Thin Wall Impact Socket (CR-Mo)	A-77	7760
563019	19mm Flat Chisel, 300mmL	G-15	1100	569536	#5 Spline Dr. 1-1/8" Deep Impact Socket (CR-Mo)	A-77	7760
563022	22mm Flat Chisel, 300mmL	G-15	1400	569536T	#5 Spline Dr. 1-1/8" Deep Thin Wall Impact Socket (CR-Mo)	A-77	7760
563100	3mm Center Punch, 100mmL	G-15	350	569538	#5 Spline Dr. 1-3/16" Deep Impact Socket (CR-Mo)	A-77	7760
563110	4mm Center Punch, 110mmL	G-15	400	569540	#5 Spline Dr. 1-1/4" Deep Impact Socket (CR-Mo)	A-77	7760
563125	5mm Center Punch, 125mmL	G-15	600	569540T	#5 Spline Dr. 1-1/4" Deep Thin Wall Impact Socket (CR-Mo)	A-77	7760
563140	6mm Center Punch, 140mmL	G-15	680	569542	#5 Spline Dr. 1-5/16" Deep Impact Socket (CR-Mo)	A-77	7760
563160	8mm Center Punch, 160mmL	G-15	800	569544	#5 Spline Dr. 1-3/8" Deep Impact Socket (CR-Mo)	A-77	7760
563819P	5/8" Hex Shank, 19mm Flat Chisel with Handle Guard	G-18	2000	569546	#5 Spline Dr. 1-7/16" Deep Impact Socket (CR-Mo)	A-77	7760
563822P	3/4" Hex Shank, 22mm Flat Chisel with Handle Guard	G-18	2500	569548	#5 Spline Dr. 1-1/2" Deep Impact Socket (CR-Mo)	A-77	7760
564202	2mm Long Taper Line Up Punch, 200mmL	G-15	660	569548B	#5 Spline Dr. 1-1/2" Budd Wheel Impact Socket	A-76	11025
564203	3mm Long Taper Line Up Punch, 200mmL	G-15	660	569550	#5 Spline Dr. 1-9/16" Deep Impact Socket (CR-Mo)	A-77	7760
564254	4mm Long Taper Line Up Punch, 250mmL	G-15	1050	569552	#5 Spline Dr. 1-5/8" Deep Impact Socket (CR-Mo)	A-77	7760
564255	5mm Long Taper Line Up Punch, 250mmL	G-15	1050	569554	#5 Spline Dr. 1-11/16" Deep Impact Socket (CR-Mo)	A-77	7760
564286	6mm Long Taper Line Up Punch, 280mmL	G-15	1200	569556	#5 Spline Dr. 1-3/4" Deep Impact Socket (CR-Mo)	A-77	7760
565102	2mm Pin Punch, 100mmL	G-15	400	569558	#5 Spline Dr. 1-13/16" Deep Impact Socket (CR-Mo)	A-77	8100
565123	3mm Pin Punch, 125mmL	G-15	400	569560	#5 Spline Dr. 1-7/8" Deep Impact Socket (CR-Mo)	A-77	8100
565144	4mm Pin Punch, 140mmL	G-15	500	569562	#5 Spline Dr. 1-15/16" Deep Impact Socket (CR-Mo)	A-77	8100
565165	5mm Pin Punch, 160mmL	G-15	550	569564	#5 Spline Dr. 2" Deep Impact Socket (CR-Mo)	A-77	8100

Item No.	Description	Pg.	Code	Item No.	Description	Pg.	Code
569568	#5 Spline Dr. 2-1/8" Deep Impact Socket (CR-Mo)	A-77	8100	5724	3/8" Hex Shank, 3/8" Wobble Hex Hex Screwdriver Bit, 160mmL	D-9	760
569570	#5 Spline Dr. 2-3/16" Deep Impact Socket (CR-Mo)	A-77	8330	572411L	11mm L-Shaped Long Hex Key Wrench, 236mmL	F-29	620
569572	#5 Spline Dr. 2-1/4" Deep Impact Socket (CR-Mo)	A-77	9500	572512L	12mm L-Shaped Long Hex Key Wrench, 250mmL	F-29	740
569576	#5 Spline Dr. 2-3/8" Deep Impact Socket (CR-Mo)	A-77	10800	572613L	13mm L-Shaped Long Hex Key Wrench, 260mmL	F-29	930
569580	#5 Spline Dr. 2-1/2" Deep Impact Socket (CR-Mo)	A-77	12080	572814L	14mm L-Shaped Long Hex Key Wrench, 280mmL	F-29	1090
569584	#5 Spline Dr. 2-5/8" Deep Impact Socket (CR-Mo)	A-77	12700	572916L	16mm L-Shaped Long Hex Key Wrench, 300mmL	F-29	1520
569588	#5 Spline Dr. 2-3/4" Deep Impact Socket (CR-Mo)	A-77	13610	573117L	17mm L-Shaped Long Hex Key Wrench, 320mmL	F-29	1690
569596	#5 Spline Dr. 3" Deep Impact Socket (CR-Mo)	A-77	15670	573219L	19mm L-Shaped Long Hex Key Wrench, 360mmL	F-29	2330
570012	#1 - #2 Offset Philips Screwdriver, 125mmL	F-27	500	580506	T-6 L-Shaped Star Key Wrench, 44mmL	F-32	180
570034	#3 - #4 Offset Philips Screwdriver, 175mmL	F-27	500	580507	T-7 L-Shaped Star Key Wrench, 47mmL	F-32	180
570071	#000 Micro-Tech Philips Screwdriver, 122mmL	D-55	280	580508	T-8 L-Shaped Star Key Wrench, 50mmL	F-32	180
570072	#00 Micro-Tech Philips Screwdriver, 122mmL	D-55	280	580509	T-9 L-Shaped Star Key Wrench, 55mmL	F-32	190
570073	#0 Micro-Tech Philips Screwdriver, 122mmL	D-55	280	580510	T-10 L-Shaped Star Key Wrench, 60mmL	F-32	200
570515	1.5mm L-Shaped Hex Key Wrench, 45mmL	F-28	100	580615	T-15 L-Shaped Star Key Wrench, 64mmL	F-32	210
570520	2mm L-Shaped Hex Key Wrench, 50mmL	F-28	100	580620	T-20 L-Shaped Star Key Wrench, 68mmL	F-32	220
570625	2.5mm L-Shaped Hex Key Wrench, 56mmL	F-28	115	580625	T-25 L-Shaped Star Key Wrench, 72mmL	F-32	250
570630	3mm L-Shaped Hex Key Wrench, 63mmL	F-28	120	580627	T-27 L-Shaped Star Key Wrench, 78mmL	F-32	260
570735	3.5mm L-Shaped Hex Key Wrench, 65mmL	F-28	120	580730	T-30 L-Shaped Star Key Wrench, 83mmL	F-32	270
570740	4mm L-Shaped Hex Key Wrench, 70mmL	F-28	120	5808	1/4" Hex Shank, 1/8" Wobble Hex Hex Screwdriver Bit, 200mmL	D-9	510
5708	1/4" Hex Shank, 1/8" Wobble Hex Hex Screwdriver Bit, 160mmL	D-9	430	580807T	T-7 L-Shaped Tamperproof Star Key Wrench, 71mmL	F-33	260
570845	4.5mm L-Shaped Hex Key Wrench, 75mmL	F-28	120	580808T	T-8 L-Shaped Tamperproof Star Key Wrench, 76mmL	F-33	260
570850	5mm L-Shaped Hex Key Wrench, 80mmL	F-28	135	580809T	T-9 L-Shaped Tamperproof Star Key Wrench, 80mmL	F-33	270
570855	5.5mm L-Shaped Hex Key Wrench, 85mmL	F-28	150	580840	T-40 L-Shaped Star Key Wrench, 89mmL	F-32	280
570915B	1.5mm L-Shaped Wobble Hex Key Wrench, 90mmL	F-31	200	580845	T-45 L-Shaped Star Key Wrench, 96mmL	F-32	340
570915L	1.5mm L-Shaped Long Hex Key Wrench, 90mmL	F-29	160	580910T	T-10 L-Shaped Tamperproof Star Key Wrench, 86mmL	F-33	280
570960	6mm L-Shaped Hex Key Wrench, 90mmL	F-28	170	580915T	T-15 L-Shaped Tamperproof Star Key Wrench, 90mmL	F-33	290
570970	7mm L-Shaped Hex Key Wrench, 95mmL	F-28	220	580950	T-50 L-Shaped Star Key Wrench, 105mmL	F-32	370
5710	1/4" Hex Shank, 5/32" Wobble Hex Hex Screwdriver Bit, 160mmL	D-9	430	5810	1/4" Hex Shank, 5/32" Wobble Hex Hex Screwdriver Bit, 200mmL	D-9	510
571020B	2mm L-Shaped Wobble Hex Key Wrench, 100mmL	F-31	200	581020T	T-20 L-Shaped Tamperproof Star Key Wrench, 95mmL	F-33	300
571020L	2mm L-Shaped Long Hex Key Wrench, 100mmL	F-29	160	581025T	T-25 L-Shaped Tamperproof Star Key Wrench, 100mmL	F-33	350
571080	8mm L-Shaped Hex Key Wrench, 100mmL	F-28	250	581055	T-55 L-Shaped Star Key Wrench, 116mmL	F-32	530
571125B	2.5mm L-Shaped Wobble Hex Key Wrench, 112mmL	F-31	230	581127T	T-27 L-Shaped Tamperproof Star Key Wrench, 105mmL	F-33	360
571125L	2.5mm L-Shaped Long Hex Key Wrench, 112mmL	F-29	190	5812	1/4" Hex Shank, 3/16" Wobble Hex Hex Screwdriver Bit, 200mmL	D-9	510
571190	9mm L-Shaped Hex Key Wrench, 106mmL	F-28	280	581230T	T-30 L-Shaped Tamperproof Star Key Wrench, 114mmL	F-33	370
5712	1/4" Hex Shank, 3/16" Wobble Hex Hex Screwdriver Bit, 160mmL	D-9	430	581240T	T-40 L-Shaped Tamperproof Star Key Wrench, 124mmL	F-33	400
571210	10mm L-Shaped Hex Key Wrench, 112mmL	F-28	320	581260	T-60 L-Shaped Star Key Wrench, 125mmL	F-32	720
571211	11mm L-Shaped Hex Key Wrench, 118mmL	F-28	400	581345T	T-45 L-Shaped Tamperproof Star Key Wrench, 137mmL	F-33	480
571230B	3mm L-Shaped Wobble Hex Key Wrench, 126mmL	F-31	240	5814	1/4" Hex Shank, 7/32" Wobble Hex Hex Screwdriver Bit, 200mmL	D-9	510
571230L	3mm L-Shaped Long Hex Key Wrench, 126mmL	F-29	200	581470	T-70 L-Shaped Star Key Wrench, 140mmL	F-32	1150
571312	12mm L-Shaped Hex Key Wrench, 125mmL	F-28	500	581550T	T-50 L-Shaped Tamperproof Star Key Wrench, 152mmL	F-33	530
571313	13mm L-Shaped Hex Key Wrench, 132mmL	F-28	600	5816	1/4" Hex Shank, 1/4" Wobble Hex Hex Screwdriver Bit, 200mmL	D-9	510
571335B	3.5mm L-Shaped Wobble Hex Key Wrench, 134mmL	F-31	240	581755T	T-55 L-Shaped Tamperproof Star Key Wrench, 171mmL	F-33	760
571335L	3.5mm L-Shaped Long Hex Key Wrench, 134mmL	F-29	200	5818	5/16" Hex Shank, 9/32" Wobble Hex Hex Screwdriver Bit, 200mmL	D-9	660
5714	1/4" Hex Shank, 7/32" Wobble Hex Hex Screwdriver Bit, 160mmL	D-9	430	581960T	T-60 L-Shaped Tamperproof Star Key Wrench, 190mmL	F-33	1020
571414	14mm L-Shaped Hex Key Wrench, 140mmL	F-28	720	5820	5/16" Hex Shank, 5/16" Wobble Hex Hex Screwdriver Bit, 200mmL	D-9	660
571440B	4mm L-Shaped Wobble Hex Key Wrench, 142mmL	F-31	240	582270T	T-70 L-Shaped Tamperproof Star Key Wrench, 220mmL	F-33	1380
571440L	4mm L-Shaped Long Hex Key Wrench, 142mmL	F-29	200	5824	3/8" Hex Shank, 3/8" Wobble Hex Hex Screwdriver Bit, 200mmL	D-9	860
571516	16mm L-Shaped Hex Key Wrench, 153mmL	F-28	960	582705M	M5 L-Shaped Triple Square Key Wrench, 72mmL	F-33	260
571545B	4.5mm L-Shaped Wobble Hex Key Wrench, 150mmL	F-31	240	582806M	M6 L-Shaped Triple Square Key Wrench, 80mmL	F-33	285
571545L	4.5mm L-Shaped Long Hex Key Wrench, 150mmL	F-29	220	582908M	M8 L-Shaped Triple Square Key Wrench, 90mmL	F-33	390
571571	#000 Micro-Tech Philips Screwdriver, 155mmL	D-55	320	583010M	M10 L-Shaped Triple Square Key Wrench, 100mmL	F-33	530
571572	#00 Micro-Tech Philips Screwdriver, 155mmL	D-55	320	583112M	M12 L-Shaped Triple Square Key Wrench, 112mmL	F-33	635
571573	#0 Micro-Tech Philips Screwdriver, 155mmL	D-55	320	583214M	M14 L-Shaped Triple Square Key Wrench, 125mmL	F-33	865
5716	1/4" Hex Shank, 1/4" Wobble Hex Hex Screwdriver Bit, 160mmL	D-9	430	583416M	M16 L-Shaped Triple Square Key Wrench, 140mmL	F-33	1175
571617	17mm L-Shaped Hex Key Wrench, 160mmL	F-28	1170	590116	Claw Hammer, 1 lbs.	G-14	4470
571650B	5mm L-Shaped Wobble Hex Key Wrench, 160mmL	F-31	270	590120	Claw Hammer, 1-1/4 lbs.	G-14	4900
571650L	5mm L-Shaped Long Hex Key Wrench, 160mmL	F-29	230	590208	Ball Peen Hammer, 1/2 lbs.	G-14	3120
571719	19mm L-Shaped Hex Key Wrench, 180mmL	F-28	1500	590212	Ball Peen Hammer, 3/4 lbs.	G-14	3370
571760B	6mm L-Shaped Wobble Hex Key Wrench, 180mmL	F-31	280	590216	Ball Peen Hammer, 1 lbs.	G-14	4240
571760L	6mm L-Shaped Long Hex Key Wrench, 180mmL	F-29	260	590224	Ball Peen Hammer, 1-1/2 lbs.	G-14	4890
5718	5/16" Hex Shank, 9/32" Wobble Hex Hex Screwdriver Bit, 160mmL	D-9	560	590232	Ball Peen Hammer, 2 lbs.	G-14	5420
571870B	7mm L-Shaped Wobble Hex Key Wrench, 190mmL	F-31	350	590348	Drilling Hammer, 2-1/2 lbs.	G-14	4830
571870L	7mm L-Shaped Long Hex Key Wrench, 190mmL	F-29	300	590364	Drilling Hammer, 4 lbs.	G-14	5890
5720	5/16" Hex Shank, 5/16" Wobble Hex Hex Screwdriver Bit, 160mmL	D-9	560	590416	Rubber Mallet, 1 lbs.	G-14	3150
572080B	8mm L-Shaped Wobble Hex Key Wrench, 200mmL	F-31	420	590503	1/20" L-Shaped Hex Key Wrench, 40mmL	F-28	115
572080L	8mm L-Shaped Long Hex Key Wrench, 200mmL	F-29	360	590504	1/16" L-Shaped Hex Key Wrench, 45mmL	F-28	115
572190B	9mm L-Shaped Wobble Hex Key Wrench, 210mmL	F-31	520	590524	Rubber Mallet, 1-1/2 lbs.	G-14	1960
572190L	9mm L-Shaped Long Hex Key Wrench, 210mmL	F-29	430	590605	5/64" L-Shaped Hex Key Wrench, 50mmL	F-28	115
572210B	10mm L-Shaped Wobble Hex Key Wrench, 224mmL	F-31	550	590606	3/32" L-Shaped Hex Key Wrench, 56mmL	F-28	120
572210L	10mm L-Shaped Long Hex Key Wrench, 224mmL	F-29	480	590607	7/64" L-Shaped Hex Key Wrench, 59mmL	F-28	120

Item No.	Description	Pg.	Code	Item No.	Description	Pg.	Code
590608	1/8" L-Shaped Hex Key Wrench, 63mmL	F-28	120	593+1240	0.8 x 4.0mm Slotted Screwdriver w/Plastic Handle, 195mmL	D-49	480
590709	9/64" L-Shaped Hex Key Wrench, 65mmL	F-28	120	593+1250	0.8 x 5.0mm Slotted Screwdriver w/Plastic Handle, 345mmL	D-49	650
590710	5/32" L-Shaped Hex Key Wrench, 70mmL	F-28	120	593+1400	PH.0 Philips Screwdriver w/Plastic Handle, 170mmL	D-49	430
590803L	1/20" L-Shaped Long Hex Key Wrench, 72mmL	F-29	190	593+1401	PH.1 Philips Screwdriver w/Plastic Handle, 170mmL	D-49	400
590812	3/16" L-Shaped Hex Key Wrench, 80mmL	F-28	135	593+1421	PH.1 Philips Screwdriver w/Plastic Handle, 195mmL	D-49	450
590814	7/32" L-Shaped Hex Key Wrench, 85mmL	F-28	160	593+1431	PH.1 Philips Screwdriver w/Plastic Handle, 345mmL	D-49	600
590904B	1/16" L-Shaped Wobble Hex Key Wrench, 90mmL	F-31	230	593+1455	1.0 x 5.5mm Slotted Screwdriver w/Plastic Handle, 195mmL	D-49	480
590904L	1/16" L-Shaped Long Hex Key Wrench, 90mmL	F-29	190	593+1457	1.0 x 5.5mm Slotted Screwdriver w/Plastic Handle, 245mmL	D-49	520
590916	1/4" L-Shaped Hex Key Wrench, 90mmL	F-28	180	593+1602	PH.2 Philips Screwdriver w/Plastic Handle, 140mmL	D-49	400
591+1201	PH.1 Philips Screwdriver w/Plastic Handle, 86mmL	D-49	350	593+1802	PH.2 Philips Screwdriver w/Plastic Handle, 220mmL	D-49	500
591+1202	PH.2 Philips Screwdriver w/Plastic Handle, 86mmL	D-49	350	593+1902	PH.2 Philips Screwdriver w/Plastic Handle, 295mmL	D-49	600
591+1465	1.2 x 6.5mm Slotted Screwdriver w/Plastic Handle, 86mmL	D-49	350	593+1932	PH.2 Philips Screwdriver w/Plastic Handle, 395mmL	D-49	700
591005B	5/64" L-Shaped Wobble Hex Key Wrench, 100mmL	F-31	230	593+1965	1.2 x 6.5mm Slotted Screwdriver w/Plastic Handle, 195mmL	D-49	500
591005L	5/64" L-Shaped Long Hex Key Wrench, 100mmL	F-29	190	593+1966	1.2 x 6.5mm Slotted Screwdriver w/Plastic Handle, 245mmL	D-49	540
591020	5/16" L-Shaped Hex Key Wrench, 100mmL	F-28	250	593+1967	1.2 x 6.5mm Slotted Screwdriver w/Plastic Handle, 295mmL	D-49	620
591106B	3/32" L-Shaped Wobble Hex Key Wrench, 112mmL	F-31	240	593+2735	5mm Hex Screwdriver w/Plastic Handle, 180mmL	D-50	560
591106L	3/32" L-Shaped Long Hex Key Wrench, 112mmL	F-29	200	593+2736	6mm Hex Screwdriver w/Plastic Handle, 180mmL	D-50	560
591124	3/8" L-Shaped Hex Key Wrench, 112mmL	F-28	320	593+3712	3/16" Hex Screwdriver w/Plastic Handle, 180mmL	D-50	560
591208B	1/8" L-Shaped Wobble Hex Key Wrench, 126mmL	F-31	240	593+3714	7/32" Hex Screwdriver w/Plastic Handle, 180mmL	D-50	560
591208L	1/8" L-Shaped Long Hex Key Wrench, 126mmL	F-29	200	593+4735	5mm Wobble Hex Screwdriver w/Plastic Handle, 180mmL	D-50	610
591310B	5/32" L-Shaped Wobble Hex Key Wrench, 142mmL	F-31	240	593+4736	6mm Wobble Hex Screwdriver w/Plastic Handle, 180mmL	D-50	610
591310L	5/32" L-Shaped Long Hex Key Wrench, 142mmL	F-29	200	593+5712	3/16" Wobble Hex Screwdriver w/Plastic Handle, 180mmL	D-50	610
591328	7/16" L-Shaped Hex Key Wrench, 118mmL	F-28	420	593+5714	7/32" Wobble Hex Screwdriver w/Plastic Handle, 180mmL	D-50	610
591432	1/2" L-Shaped Hex Key Wrench, 125mmL	F-28	570	593+6710	T-10 Star Screwdriver w/Plastic Handle, 175mmL	D-51	560
591512B	3/16" L-Shaped Wobble Hex Key Wrench, 160mmL	F-31	270	593+6715	T-15 Star Screwdriver w/Plastic Handle, 175mmL	D-51	560
591512L	3/16" L-Shaped Long Hex Key Wrench, 160mmL	F-29	230	593+6720	T-20 Star Screwdriver w/Plastic Handle, 175mmL	D-51	560
591536	9/16" L-Shaped Hex Key Wrench, 140mmL	F-28	760	593+6725	T-25 Star Screwdriver w/Plastic Handle, 175mmL	D-51	560
591540	5/8" L-Shaped Hex Key Wrench, 160mmL	F-28	930	593+7710	T-10 Tamperproof Star Screwdriver w/Plastic Handle, 175mmL	D-51	580
591614B	7/32" L-Shaped Wobble Hex Key Wrench, 170mmL	F-31	280	593+7715	T-15 Tamperproof Star Screwdriver w/Plastic Handle, 175mmL	D-51	580
591614L	7/32" L-Shaped Long Hex Key Wrench, 170mmL	F-29	250	593+7920	T-20 Tamperproof Star Screwdriver w/Plastic Handle, 195mmL	D-51	630
591816B	1/4" L-Shaped Wobble Hex Key Wrench, 180mmL	F-31	280	593+7925	T-25 Tamperproof Star Screwdriver w/Plastic Handle, 195mmL	D-51	630
591816L	1/4" L-Shaped Long Hex Key Wrench, 180mmL	F-29	260	593040L	5/8" L-Shaped Long Hex Key Wrench, 320mmL	F-29	1530
591848	3/4" L-Shaped Hex Key Wrench, 180mmL	F-28	1500	593248L	3/4" L-Shaped Long Hex Key Wrench, 360mmL	F-29	2330
592+1230	0.5 x 3.0mm Slotted Screwdriver w/Plastic Handle, 150mmL	D-49	350	593516	1/4" Hex Nut Driver (with magnet), 165mmL	D-60	780
592+1240	0.8 x 4.0mm Slotted Screwdriver w/Plastic Handle, 175mmL	D-49	400	593556	6mm Hex Nut Driver (with magnet), 165mmL	D-60	780
592+1400	PH.0 Philips Screwdriver w/Plastic Handle, 150mmL	D-49	350	593616	1/4" Long Hex Nut Driver (with magnet), 245mmL	D-60	1090
592+2622	2mm Hex Screwdriver w/Plastic Handle, 145mmL	D-50	400	593656	6mm Long Hex Nut Driver (with magnet), 245mmL	D-60	1090
592+2625	2.5mm Hex Screwdriver w/Plastic Handle, 145mmL	D-50	400	593712	3/16" Hex Nut Driver, 165mmL	D-58	640
592+2633	3mm Hex Screwdriver w/Plastic Handle, 145mmL	D-50	400	593716	1/4" Hex Nut Driver, 165mmL	D-58	640
592+2634	4mm Hex Screwdriver w/Plastic Handle, 145mmL	D-50	400	593744	4mm Hex Nut Driver, 165mmL	D-58	640
592+3604	1/16" Hex Screwdriver w/Plastic Handle, 145mmL	D-50	400	593745	5mm Hex Nut Driver, 165mmL	D-58	640
592+3605	5/64" Hex Screwdriver w/Plastic Handle, 145mmL	D-50	400	593755	5.5mm Hex Nut Driver, 165mmL	D-58	640
592+3606	3/32" Hex Screwdriver w/Plastic Handle, 145mmL	D-50	400	593756	6mm Hex Nut Driver, 165mmL	D-58	640
592+3607	7/64" Hex Screwdriver w/Plastic Handle, 145mmL	D-50	400	593812	3/16" Long Hex Nut Driver, 245mmL	D-58	890
592+3608	1/8" Hex Screwdriver w/Plastic Handle, 145mmL	D-50	400	593816	1/4" Long Hex Nut Driver, 245mmL	D-58	890
592+3610	5/32" Hex Screwdriver w/Plastic Handle, 145mmL	D-50	400	593844	4mm Long Hex Nut Driver, 245mmL	D-58	890
592+4633	3mm Wobble Hex Screwdriver w/Plastic Handle, 145mmL	D-50	450	593845	5mm Long Hex Nut Driver, 245mmL	D-58	890
592+4634	4mm Wobble Hex Screwdriver w/Plastic Handle, 145mmL	D-50	450	593855	5.5mm Long Hex Nut Driver, 245mmL	D-58	890
592+5608	1/8" Wobble Hex Screwdriver w/Plastic Handle, 145mmL	D-50	450	593856	6mm Long Hex Nut Driver, 245mmL	D-58	890
592+5610	5/32" Wobble Hex Screwdriver w/Plastic Handle, 145mmL	D-50	450	594+0230	1/4" Hex Shank Magnetic Bit Holder With Handle	D-24	800
592+6606	T-6 Star Screwdriver w/Plastic Handle, 145mmL	D-51	400	594+0250	1/4" Hex Shank Flexible Spinner With Handle	D-24	800
592+6607	T-7 Star Screwdriver w/Plastic Handle, 145mmL	D-51	400	594+0260	1/4" Hex Shank Flexible Bit Holder With Handle	D-24	710
592+6608	T-8 Star Screwdriver w/Plastic Handle, 145mmL	D-51	400	594+1250	0.8 x 5.0mm Slotted Screwdriver w/Plastic Handle, 360mmL	D-49	700
592+6609	T-9 Star Screwdriver w/Plastic Handle, 145mmL	D-51	400	594+1401	PH.1 Philips Screwdriver w/Plastic Handle, 185mmL	D-49	450
592+7606	T-6 Tamperproof Star Screwdriver w/Plastic Handle, 145mmL	D-51	450	594+1421	PH.1 Philips Screwdriver w/Plastic Handle, 210mmL	D-49	500
592+7607	T-7 Tamperproof Star Screwdriver w/Plastic Handle, 145mmL	D-51	450	594+1431	PH.1 Philips Screwdriver w/Plastic Handle, 360mmL	D-49	650
592+7608	T-8 Tamperproof Star Screwdriver w/Plastic Handle, 145mmL	D-51	450	594+1455	1.0 x 5.5mm Slotted Screwdriver w/Plastic Handle, 210mmL	D-49	530
592+7609	T-9 Tamperproof Star Screwdriver w/Plastic Handle, 145mmL	D-51	450	594+1457	1.0 x 5.5mm Slotted Screwdriver w/Plastic Handle, 260mmL	D-49	570
592020B	5/16" L-Shaped Wobble Hex Key Wrench, 200mmL	F-31	420	594+1602	PH.2 Philips Screwdriver w/Plastic Handle, 155mmL	D-49	450
592020L	5/16" L-Shaped Long Hex Key Wrench, 200mmL	F-29	360	594+1712	PH.2 Philips Screwdriver w/Plastic Handle, 210mmL	D-49	520
592324B	3/8" L-Shaped Wobble Hex Key Wrench, 224mmL	F-31	540	594+1802	PH.2 Philips Screwdriver w/Plastic Handle, 235mmL	D-49	550
592324L	3/8" L-Shaped Long Hex Key Wrench, 224mmL	F-29	480	594+1812	PH.2 Philips Screwdriver w/Plastic Handle, 260mmL	D-49	620
592428L	7/16" L-Shaped Long Hex Key Wrench, 236mmL	F-29	630	594+1902	PH.2 Philips Screwdriver w/Plastic Handle, 310mmL	D-49	650
592632L	1/2" L-Shaped Long Hex Key Wrench, 250mmL	F-29	820	594+1913	PH.3 Philips Screwdriver w/Plastic Handle, 235mmL	D-49	650
592801	Miniature Awl	J-9	320	594+1923	PH.3 Philips Screwdriver w/Plastic Handle, 310mmL	D-49	700
592802	Miniature Hook	J-9	320	594+1924	PH.4 Philips Screwdriver w/Plastic Handle, 310mmL	D-49	850
592803	Miniature Bent Tip 45°	J-9	320	594+1932	PH.2 Philips Screwdriver w/Plastic Handle, 410mmL	D-49	750
592804	Miniature Bent Tip 90°	J-9	320	594+1933	PH.3 Philips Screwdriver w/Plastic Handle, 380mmL	D-49	850
592836L	9/16" L-Shaped Long Hex Key Wrench, 280mmL	F-29	1120	594+1965	1.2 x 6.5mm Slotted Screwdriver w/Plastic Handle, 210mmL	D-49	550
593+1230	0.5 x 3.0mm Slotted Screwdriver w/Plastic Handle, 170mmL	D-49	430	594+1966	1.2 x 6.5mm Slotted Screwdriver w/Plastic Handle, 260mmL	D-49	590

Item No.	Description	Pg.	Code
594+1967	1.2 x 6.5mm Slotted Screwdriver w/Plastic Handle, 310mmL	D-49	670
594+1980	1.2 x8.0mm Slotted Screwdriver w/Plastic Handle, 285mmL	D-49	700
594+1990	1.6 x 10.0mm Slotted Screwdriver w/Plastic Handle, 310mmL	D-49	750
594+1991	1.6 x 10.0mm Slotted Screwdriver w/Plastic Handle, 360mmL	D-49	800
594+2847	7mm Hex Screwdriver w/Plastic Handle, 225mmL	D-50	830
594+2848	8mm Hex Screwdriver w/Plastic Handle, 225mmL	D-50	830
594+3816	1/4" Hex Screwdriver w/Plastic Handle, 225mmL	D-50	680
594+3818	9/32" Hex Screwdriver w/Plastic Handle, 225mmL	D-50	830
594+3820	5/16" Hex Screwdriver w/Plastic Handle, 225mmL	D-50	830
594+4847	7mm Wobble Hex Screwdriver w/Plastic Handle, 225mmL	D-50	890
594+4848	8mm Wobble Hex Screwdriver w/Plastic Handle, 225mmL	D-50	890
594+5816	1/4" Wobble Hex Screwdriver w/Plastic Handle, 225mmL	D-50	740
594+5818	9/32" Wobble Hex Screwdriver w/Plastic Handle, 225mmL	D-50	890
594+5820	5/16" Wobble Hex Screwdriver w/Plastic Handle, 225mmL	D-50	890
594+6827	T-27 Star Screwdriver w/Plastic Handle, 215mmL	D-51	680
594+6830	T-30 Star Screwdriver w/Plastic Handle, 215mmL	D-51	680
594+7827	T-27 Tamperproof Star Screwdriver w/Plastic Handle, 215mmL	D-51	740
594+7830	T-30 Tamperproof Star Screwdriver w/Plastic Handle, 215mmL	D-51	740
594520	5/16" Hex Nut Driver (with magnet), 180mmL	D-60	830
594522	11/32" Hex Nut Driver (with magnet), 180mmL	D-60	830
594524	3/8" Hex Nut Driver (with magnet), 180mmL	D-60	830
594528	7/16" Hex Nut Driver (with magnet), 180mm	D-60	830
594557	7mm Hex Nut Driver (with magnet), 180mmL	D-60	830
594558	8mm Hex Nut Driver (with magnet), 180mmL	D-60	830
594559	9mm Hex Nut Driver (with magnet), 180mmL	D-60	830
594560	10mm Hex Nut Driver (with magnet), 180mmL	D-60	830
594561	11mm Hex Nut Driver (with magnet), 180mmL	D-60	830
594562	12mm Hex Nut Driver (with magnet), 180mmL	D-60	830
594620	5/16" Long Hex Nut Driver (with magnet), 260mmL	D-60	1140
594622	11/32" Long Hex Nut Driver (with magnet), 260mmL	D-60	1140
594624	3/8" Long Hex Nut Driver (with magnet), 260mmL	D-60	1140
594628	7/16" Long Hex Nut Driver (with magnet), 260mmL	D-60	1140
594657	7mm Long Hex Nut Driver (with magnet), 260mmL	D-60	1140
594658	8mm Long Hex Nut Driver (with magnet), 260mmL	D-60	1140
594659	9mm Long Hex Nut Driver (with magnet), 260mmL	D-60	1140
594660	10mm Long Hex Nut Driver (with magnet), 260mmL	D-60	1140
594661	11mm Long Hex Nut Driver (with magnet), 260mmL	D-60	1140
594662	12mm Long Hex Nut Driver (with magnet), 260mmL	D-60	1140
594720	5/16" Hex Nut Driver, 180mmL	D-58	690
594722	11/32" Hex Nut Driver, 180mmL	D-58	690
594724	3/8" Hex Nut Driver, 180mmL	D-58	690
594728	7/16" Hex Nut Driver, 180mmL	D-58	690
594757	7mm Hex Nut Driver, 180mmL	D-58	690
594758	8mm Hex Nut Driver, 180mmL	D-58	690
594759	9mm Hex Nut Driver, 180mmL	D-58	690
594760	10mm Hex Nut Driver, 180mmL	D-58	690
594761	11mm Hex Nut Driver, 180mmL	D-58	690
594762	12mm Hex Nut Driver, 180mmL	D-58	690
594820	5/16" Long Hex Nut Driver, 260mmL	D-58	940
594822	11/32" Long Hex Nut Driver, 260mmL	D-58	940
594824	3/8" Long Hex Nut Driver, 260mmL	D-58	940
594828	7/16" Long Hex Nut Driver, 260mmL	D-58	940
594857	7mm Long Hex Nut Driver, 260mmL	D-58	940
594858	8mm Long Hex Nut Driver, 260mmL	D-58	940
594859	9mm Long Hex Nut Driver, 260mmL	D-58	940
594860	10mm Long Hex Nut Driver, 260mmL	D-58	940
594861	11mm Long Hex Nut Driver, 260mmL	D-58	940
594862	12mm Long Hex Nut Driver, 260mmL	D-58	940
595+1843	PH.3 Philips Screwdriver w/Plastic Handle, 270mmL	D-49	730
595+1913	PH.3 Philips Screwdriver w/Plastic Handle, 245mmL	D-49	700
595+1923	PH.3 Philips Screwdriver w/Plastic Handle, 320mmL	D-49	750
595+1924	PH.4 Philips Screwdriver w/Plastic Handle, 320mmL	D-49	900
595+1933	PH.3 Philips Screwdriver w/Plastic Handle, 390mmL	D-49	900
595+1980	1.2 x 8.0mm Slotted Screwdriver w/Plastic Handle, 295mmL	D-49	750
595+1990	1.6 x 10.0mm Slotted Screwdriver w/Plastic Handle, 320mmL	D-49	800
595+1991	1.6 x 10.0mm Slotted Screwdriver w/Plastic Handle, 370mmL	D-49	850
595+1992	2.0 x 12.0mm Slotted Screwdriver w/Plastic Handle, 320mmL	D-49	880
595+1994	2.5 x 14.0mm Slotted Screwdriver w/Plastic Handle, 370mmL	D-49	1050
595+2849	9mm Hex Screwdriver w/Plastic Handle, 225mmL	D-50	1080
595+2850	10mm Hex Screwdriver w/Plastic Handle, 225mmL	D-50	1080

Item No.	Description	Pg.	Code
595+3824	3/8" Hex Screwdriver w/Plastic Handle, 225mmL	D-50	1080
595+4849	9mm Wobble Hex Screwdriver w/Plastic Handle, 225mmL	D-50	1140
595+4850	10mm Wobble Hex Screwdriver w/Plastic Handle, 225mmL	D-50	1140
595+5824	3/8" Wobble Hex Screwdriver w/Plastic Handle, 225mmL	D-50	1140
595+6840	T-40 Star Screwdriver w/Plastic Handle, 225mmL	D-51	730
595+6845	T-45 Star Screwdriver w/Plastic Handle, 225mmL	D-51	880
595+6850	T-50 Star Screwdriver w/Plastic Handle, 225mmL	D-51	880
595+7850	T-50 Tamperproof Star Screwdriver w/Plastic Handle, 225mmL	D-51	940
595+7940	T-40 Tamperproof Star Screwdriver w/Plastic Handle, 250mmL	D-51	870
595+7945	T-45 Tamperproof Star Screwdriver w/Plastic Handle, 250mmL	D-51	1040
595212	12mm Straight Type Rigid Carbon Scraper, 250mm	J-9	800
595226	16mm Straight Type Rigid Carbon Scraper, 200mm	J-9	850
595232	16mm Straight Type Rigid Carbon Scraper, 300mm	J-9	900
595532	1/2" Hex Nut Driver (with magnet), 190mmL	D-60	1000
595563	13mm Hex Nut Driver (with magnet), 190mmL	D-60	1000
595564	14mm Hex Nut Driver (with magnet), 190mmL	D-60	1000
595632	1/2" Long Hex Nut Driver (with magnet), 270mmL	D-60	1340
595663	13mm Long Hex Nut Driver (with magnet), 270mmL	D-60	1340
595664	14mm Long Hex Nut Driver (with magnet), 270mmL	D-60	1340
595732	1/2" Hex Nut Driver, 190mmL	D-58	840
595763	13mm Hex Nut Driver, 190mmL	D-58	840
595764	14mm Hex Nut Driver, 190mmL	D-58	840
595832	1/2" Long Hex Nut Driver, 270mmL	D-58	1140
595863	13mm Long Hex Nut Driver, 270mmL	D-58	1140
595864	14mm Long Hex Nut Driver, 270mmL	D-58	1140
596+0146	6mm Hose Clamp Driver	J-8	850
596+0147	7mm Hose Clamp Driver	J-8	850
596+0148	8mm Hose Clamp Driver	J-8	850
596+0150	10mm Hose Clamp Driver	J-8	950
596+1992	2.0 x 12.0mm Slotted Screwdriver w/Plastic Handle, 340mmL	D-49	990
596+1994	2.5 x 14.0mm Slotted Screwdriver w/Plastic Handle, 390mmL	D-49	1160
<b>6</b>			
600750	3/4" Dr. Air Impact Wrench, 750 ft. lbs. / 1,016 Nm	E-10	55600
600756	3/4" Dr. Long Anvil Air Impact Wrench, 750 ft. lbs. / 1,016 Nm	E-10	61600
600850	3/4" Dr. Air Impact Wrench, 850 ft. lbs. / 1,152 Nm	E-10	45000
600856	3/4" Dr. Long Anvil Air Impact Wrench, 850 ft. lbs. / 1,152 Nm	E-10	48000
600900G	3/4" Dr. Air Impact Wrench, 900 ft. lbs. / 1,220 Nm	E-11	28820
601100	3/4" Dr. Air Impact Wrench, 1,100 ft. lbs. / 1,491 Nm	E-11	68000
601106	3/4" Dr. Long Anvil Air Impact Wrench, 1,100 ft. lbs. / 1,491 Nm	E-11	78000
601200G	3/4" Dr. Air Impact Wrench, 1,200 ft. lbs. / 1,627 Nm	E-12	65880
601400	3/4" Dr. Air Impact Wrench, 1,400 ft. lbs. / 1,898 Nm	E-12	77760
601406	3/4" Dr. Long Anvil Air Impact Wrench, 1,400 ft. lbs. / 1,898 Nm	E-12	86440
602000	3/4" x 1" Dr. Torque Multiplier, 2000 ft. lbs./2700 Nm	F-37	53600
6106	1/4" Hex Shank, T-6 Star Screwdriver Bit, 30mmL	D-10	55
6107	1/4" Hex Shank, T-7 Star Screwdriver Bit, 30mmL	D-10	55
6108	1/4" Hex Shank, T-8 Star Screwdriver Bit, 30mmL	D-10	55
6109	1/4" Hex Shank, T-9 Star Screwdriver Bit, 30mmL	D-10	55
6110	1/4" Hex Shank, T-10 Star Screwdriver Bit, 30mmL	D-10	55
6115	1/4" Hex Shank, T-15 Star Screwdriver Bit, 30mmL	D-10	55
6120	1/4" Hex Shank, T-20 Star Screwdriver Bit, 30mmL	D-10	55
6125	1/4" Hex Shank, T-25 Star Screwdriver Bit, 30mmL	D-10	55
6127	1/4" Hex Shank, T-27 Star Screwdriver Bit, 30mmL	D-10	55
6130	1/4" Hex Shank, T-30 Star Screwdriver Bit, 30mmL	D-10	55
6140	1/4" Hex Shank, T-40 Star Screwdriver Bit, 30mmL	D-10	55
619+	3/4" Dr. 19mm Hex Shank Impact Bit Holder, 55mmL	D-20	1200
619+2914	3/4" Dr. 14mm Hex Bit Socket, 80mmL	C-12	1900
619+2916	3/4" Dr. 16mm Hex Bit Socket, 80mmL	C-12	1900
619+2917	3/4" Dr. 17mm Hex Bit Socket, 80mmL	C-12	1900
619+2918	3/4" Dr. 18mm Hex Bit Socket, 80mmL	C-12	1900
619+2919	3/4" Dr. 19mm Hex Bit Socket, 80mmL	C-12	1900
619+3936	3/4" Dr. 9/16" Hex Bit Socket, 80mmL	C-12	1900

Item No.	Description	Pg.	Code	Item No.	Description	Pg.	Code
619+3940	3/4" Dr. 5/8" Hex Bit Socket, 80mmL	C-12	1900	625255	3/4" Dr. 55mm Hand Socket (CR-Mo)	B-78	2890
619+3948	3/4" Dr. 3/4" Hex Bit Socket, 80mmL	C-12	1900	625256	3/4" Dr. 56mm Hand Socket (CR-Mo)	B-78	3100
619+6980	3/4" Dr. T-80 Star Bit Socket, 95mmL	C-13	1900	625257	3/4" Dr. 57mm Hand Socket (CR-Mo)	B-78	3100
619+6990	3/4" Dr. T-90 Star Bit Socket, 95mmL	C-13	1900	625258	3/4" Dr. 58mm Hand Socket (CR-Mo)	B-78	3100
619+6995	3/4" Dr. T-100 Star Bit Socket, 95mmL	C-13	1900	625259	3/4" Dr. 59mm Hand Socket (CR-Mo)	B-78	3755
619+9916	3/4" Dr. M16 Triple Square Bit Socket, 95mmL	C-13	1900	625260	3/4" Dr. 60mm Hand Socket (CR-Mo)	B-78	3755
619+9918	3/4" Dr. M18 Triple Square Bit Socket, 95mmL	C-13	1900	625261	3/4" Dr. 61mm Hand Socket (CR-Mo)	B-78	4465
620100	3/4" Dr. Extension Bar, 100mmL (CR-Mo)	B-83	1765	625262	3/4" Dr. 62mm Hand Socket (CR-Mo)	B-78	4465
620150	3/4" Dr. Extension Bar, 150mmL (CR-Mo)	B-83	1945	625263	3/4" Dr. 63mm Hand Socket (CR-Mo)	B-78	4465
620200	3/4" Dr. Extension Bar, 200mmL (CR-Mo)	B-83	2100	625264	3/4" Dr. 64mm Hand Socket (CR-Mo)	B-78	5250
620250	3/4" Dr. Extension Bar, 250mmL (CR-Mo)	B-83	2205	625265	3/4" Dr. 65mm Hand Socket (CR-Mo)	B-78	5250
620330L	3/4" Dr. L-Handle, 330mmL (CR-Mo)	B-83	2550	625266	3/4" Dr. 66mm Hand Socket (CR-Mo)	B-78	6825
620400	3/4" Dr. Extension Bar, 400mmL (CR-Mo)	B-83	3530	625267	3/4" Dr. 67mm Hand Socket (CR-Mo)	B-78	6825
620400L	3/4" Dr. L-Handle, 400mmL (CR-Mo)	B-83	3280	625268	3/4" Dr. 68mm Hand Socket (CR-Mo)	B-78	6825
620604	3/4" Dr. Adapter, 3/4"F x 1/2"M (CR-Mo)	B-83	930	625269	3/4" Dr. 69mm Hand Socket (CR-Mo)	B-78	6825
620608	3/4" Dr. Adapter, 3/4"F x 1"M (CR-Mo)	B-83	945	625270	3/4" Dr. 70mm Hand Socket (CR-Mo)	B-78	6825
6210	5/16" Hex Shank, T-10 Star Screwdriver Bit, 30mmL	D-10	92	625271	3/4" Dr. 71mm Hand Socket (CR-Mo)	B-78	9900
6215	5/16" Hex Shank, T-15 Star Screwdriver Bit, 30mmL	D-10	92	625272	3/4" Dr. 72mm Hand Socket (CR-Mo)	B-78	11700
622+	3/4" Dr. 22mm Hex Shank Impact Bit Holder, 55mmL	D-20	1200	625273	3/4" Dr. 73mm Hand Socket (CR-Mo)	B-78	11700
622+2922	3/4" Dr. 22mm Hex Bit Socket, 85mmL	C-12	2000	625274	3/4" Dr. 74mm Hand Socket (CR-Mo)	B-78	11700
622+2924	3/4" Dr. 24mm Hex Bit Socket, 85mmL	C-12	2150	625275	3/4" Dr. 75mm Hand Socket (CR-Mo)	B-78	11700
622+3952	3/4" Dr. 13/16" Hex Bit Socket, 85mmL	C-12	2000	625276	3/4" Dr. 76mm Hand Socket (CR-Mo)	B-78	13500
622+3956	3/4" Dr. 7/8" Hex Bit Socket, 85mmL	C-12	2000	6255	10mm Hex Shank, T-55 Star Screwdriver Bit, 30mmL	D-10	150
622+3960	3/4" Dr. 15/16" Hex Bit Socket, 85mmL	C-12	2150	6260	12mm Hex Shank, T-60 Star Screwdriver Bit, 36mmL	D-10	260
622+3964	3/4" Dr. 1" Hex Bit Socket, 85mmL	C-12	2150	627+	3/4" Dr. 27mm Hex Shank Impact Bit Holder, 60mmL	D-20	1200
6220	5/16" Hex Shank, T-20 Star Screwdriver Bit, 30mmL	D-10	92	627+2927	3/4" Dr. 27mm Hex Bit Socket, 90mmL	C-12	2300
6225	5/16" Hex Shank, T-25 Star Screwdriver Bit, 30mmL	D-10	92	627+2930	3/4" Dr. 30mm Hex Bit Socket, 90mmL	C-12	2500
6227	5/16" Hex Shank, T-27 Star Screwdriver Bit, 30mmL	D-10	92	627+2932	3/4" Dr. 32mm Hex Bit Socket, 90mmL	C-12	2700
6230	5/16" Hex Shank, T-30 Star Screwdriver Bit, 30mmL	D-10	92	627+3968	3/4" Dr. 1-1/16" Hex Bit Socket, 90mmL	C-12	2300
6240	5/16" Hex Shank, T-40 Star Screwdriver Bit, 30mmL	D-10	92	627+3972	3/4" Dr. 1-1/8" Hex Bit Socket, 90mmL	C-12	2500
6245	5/16" Hex Shank, T-45 Star Screwdriver Bit, 30mmL	D-10	92	627+3976	3/4" Dr. 1-3/16" Hex Bit Socket, 90mmL	C-12	2600
6250	5/16" Hex Shank, T-50 Star Screwdriver Bit, 30mmL	D-10	92	627+3980	3/4" Dr. 1-1/4" Hex Bit Socket, 90mmL	C-12	2700
625217	3/4" Dr. 17mm Hand Socket (CR-Mo)	B-78	630	6270	14mm Hex Shank, T-70 Star Screwdriver Bit, 36mmL	D-10	320
625218	3/4" Dr. 18mm Hand Socket (CR-Mo)	B-78	630	629517	3/4" Dr. 17mm Deep Hand Socket (CR-Mo)	B-80	1525
625219	3/4" Dr. 19mm Hand Socket (CR-Mo)	B-78	630	629518	3/4" Dr. 18mm Deep Hand Socket (CR-Mo)	B-80	1525
625220	3/4" Dr. 20mm Hand Socket (CR-Mo)	B-78	630	629519	3/4" Dr. 19mm Deep Hand Socket (CR-Mo)	B-80	1525
625221	3/4" Dr. 21mm Hand Socket (CR-Mo)	B-78	630	629520	3/4" Dr. 20mm Deep Hand Socket (CR-Mo)	B-80	1525
625222	3/4" Dr. 22mm Hand Socket (CR-Mo)	B-78	630	629521	3/4" Dr. 21mm Deep Hand Socket (CR-Mo)	B-80	1525
625223	3/4" Dr. 23mm Hand Socket (CR-Mo)	B-78	630	629522	3/4" Dr. 22mm Deep Hand Socket (CR-Mo)	B-80	1525
625224	3/4" Dr. 24mm Hand Socket (CR-Mo)	B-78	685	629523	3/4" Dr. 23mm Deep Hand Socket (CR-Mo)	B-80	1525
625225	3/4" Dr. 25mm Hand Socket (CR-Mo)	B-78	685	629524	3/4" Dr. 24mm Deep Hand Socket (CR-Mo)	B-80	1525
625226	3/4" Dr. 26mm Hand Socket (CR-Mo)	B-78	685	629525	3/4" Dr. 25mm Deep Hand Socket (CR-Mo)	B-80	1525
625227	3/4" Dr. 27mm Hand Socket (CR-Mo)	B-78	735	629526	3/4" Dr. 26mm Deep Hand Socket (CR-Mo)	B-80	1525
625228	3/4" Dr. 28mm Hand Socket (CR-Mo)	B-78	735	629527	3/4" Dr. 27mm Deep Hand Socket (CR-Mo)	B-80	1525
625229	3/4" Dr. 29mm Hand Socket (CR-Mo)	B-78	840	629528	3/4" Dr. 28mm Deep Hand Socket (CR-Mo)	B-80	1630
625230	3/4" Dr. 30mm Hand Socket (CR-Mo)	B-78	840	629529	3/4" Dr. 29mm Deep Hand Socket (CR-Mo)	B-80	1630
625231	3/4" Dr. 31mm Hand Socket (CR-Mo)	B-78	840	629530	3/4" Dr. 30mm Deep Hand Socket (CR-Mo)	B-80	1735
625232	3/4" Dr. 32mm Hand Socket (CR-Mo)	B-78	840	629531	3/4" Dr. 31mm Deep Hand Socket (CR-Mo)	B-80	1785
625233	3/4" Dr. 33mm Hand Socket (CR-Mo)	B-78	1050	629532	3/4" Dr. 32mm Deep Hand Socket (CR-Mo)	B-80	1785
625234	3/4" Dr. 34mm Hand Socket (CR-Mo)	B-78	1050	629533	3/4" Dr. 33mm Deep Hand Socket (CR-Mo)	B-80	1840
625235	3/4" Dr. 35mm Hand Socket (CR-Mo)	B-78	1050	629534	3/4" Dr. 34mm Deep Hand Socket (CR-Mo)	B-80	1890
625236	3/4" Dr. 36mm Hand Socket (CR-Mo)	B-78	1155	629535	3/4" Dr. 35mm Deep Hand Socket (CR-Mo)	B-80	1995
625237	3/4" Dr. 37mm Hand Socket (CR-Mo)	B-78	1155	629536	3/4" Dr. 36mm Deep Hand Socket (CR-Mo)	B-80	2100
625238	3/4" Dr. 38mm Hand Socket (CR-Mo)	B-78	1155	629537	3/4" Dr. 37mm Deep Hand Socket (CR-Mo)	B-80	2365
625239	3/4" Dr. 39mm Hand Socket (CR-Mo)	B-78	1365	629538	3/4" Dr. 38mm Deep Hand Socket (CR-Mo)	B-80	2365
625240	3/4" Dr. 40mm Hand Socket (CR-Mo)	B-78	1365	629539	3/4" Dr. 39mm Deep Hand Socket (CR-Mo)	B-80	2625
625241	3/4" Dr. 41mm Hand Socket (CR-Mo)	B-78	1365	629540	3/4" Dr. 40mm Deep Hand Socket (CR-Mo)	B-80	2625
625242	3/4" Dr. 42mm Hand Socket (CR-Mo)	B-78	1470	629541	3/4" Dr. 41mm Deep Hand Socket (CR-Mo)	B-80	2890
625243	3/4" Dr. 43mm Hand Socket (CR-Mo)	B-78	1470	629542	3/4" Dr. 42mm Deep Hand Socket (CR-Mo)	B-80	3150
625244	3/4" Dr. 44mm Hand Socket (CR-Mo)	B-78	2075	629543	3/4" Dr. 43mm Deep Hand Socket (CR-Mo)	B-80	3150
625245	3/4" Dr. 45mm Hand Socket (CR-Mo)	B-78	2075	629544	3/4" Dr. 44mm Deep Hand Socket (CR-Mo)	B-80	3415
625246	3/4" Dr. 46mm Hand Socket (CR-Mo)	B-78	2075	629545	3/4" Dr. 45mm Deep Hand Socket (CR-Mo)	B-80	3415
625247	3/4" Dr. 47mm Hand Socket (CR-Mo)	B-78	2235	629546	3/4" Dr. 46mm Deep Hand Socket (CR-Mo)	B-80	3940
625248	3/4" Dr. 48mm Hand Socket (CR-Mo)	B-78	2235	629547	3/4" Dr. 47mm Deep Hand Socket (CR-Mo)	B-80	4200
625249	3/4" Dr. 49mm Hand Socket (CR-Mo)	B-78	2235	629548	3/4" Dr. 48mm Deep Hand Socket (CR-Mo)	B-80	4200
625250	3/4" Dr. 50mm Hand Socket (CR-Mo)	B-78	2235	629549	3/4" Dr. 49mm Deep Hand Socket (CR-Mo)	B-80	4465
625251	3/4" Dr. 51mm Hand Socket (CR-Mo)	B-78	2365	629550	3/4" Dr. 50mm Deep Hand Socket (CR-Mo)	B-80	4465
625252	3/4" Dr. 52mm Hand Socket (CR-Mo)	B-78	2365	629551	3/4" Dr. 51mm Deep Hand Socket (CR-Mo)	B-80	4900
625253	3/4" Dr. 53mm Hand Socket (CR-Mo)	B-78	2890	629552	3/4" Dr. 52mm Deep Hand Socket (CR-Mo)	B-80	4900
625254	3/4" Dr. 54mm Hand Socket (CR-Mo)	B-78	2890	629553	3/4" Dr. 53mm Deep Hand Socket (CR-Mo)	B-80	5200



Item No.	Description	Pg.	Code
629554	3/4" Dr. 54mm Deep Hand Socket (CR-Mo)	B-80	5200
629555	3/4" Dr. 55mm Deep Hand Socket (CR-Mo)	B-80	5400
629556	3/4" Dr. 56mm Deep Hand Socket (CR-Mo)	B-80	5700
629557	3/4" Dr. 57mm Deep Hand Socket (CR-Mo)	B-80	5700
629558	3/4" Dr. 58mm Deep Hand Socket (CR-Mo)	B-80	5900
629559	3/4" Dr. 59mm Deep Hand Socket (CR-Mo)	B-80	6300
629560	3/4" Dr. 60mm Deep Hand Socket (CR-Mo)	B-80	6900
629561	3/4" Dr. 61mm Deep Hand Socket (CR-Mo)	B-80	7500
629562	3/4" Dr. 62mm Deep Hand Socket (CR-Mo)	B-80	7500
629563	3/4" Dr. 63mm Deep Hand Socket (CR-Mo)	B-80	7500
629564	3/4" Dr. 64mm Deep Hand Socket (CR-Mo)	B-80	8600
629565	3/4" Dr. 65mm Deep Hand Socket (CR-Mo)	B-80	8600
629566	3/4" Dr. 66mm Deep Hand Socket (CR-Mo)	B-80	10800
629567	3/4" Dr. 67mm Deep Hand Socket (CR-Mo)	B-80	10800
629568	3/4" Dr. 68mm Deep Hand Socket (CR-Mo)	B-80	11300
629569	3/4" Dr. 69mm Deep Hand Socket (CR-Mo)	B-80	11300
629570	3/4" Dr. 70mm Deep Hand Socket (CR-Mo)	B-80	11300
629571	3/4" Dr. 71mm Deep Hand Socket (CR-Mo)	B-80	13300
629572	3/4" Dr. 72mm Deep Hand Socket (CR-Mo)	B-80	13300
629573	3/4" Dr. 73mm Deep Hand Socket (CR-Mo)	B-80	13300
629574	3/4" Dr. 74mm Deep Hand Socket (CR-Mo)	B-80	13300
629575	3/4" Dr. 75mm Deep Hand Socket (CR-Mo)	B-80	13300
629576	3/4" Dr. 76mm Deep Hand Socket (CR-Mo)	B-80	15300
6306	1/4" Hex Shank, T-6 Star Screwdriver Bit, 56mmL	D-10	120
6307	1/4" Hex Shank, T-7 Star Screwdriver Bit, 56mmL	D-10	120
6308	1/4" Hex Shank, T-8 Star Screwdriver Bit, 56mmL	D-10	120
6309	1/4" Hex Shank, T-9 Star Screwdriver Bit, 56mmL	D-10	120
6310	1/4" Hex Shank, T-10 Star Screwdriver Bit, 56mmL	D-10	120
6315	1/4" Hex Shank, T-15 Star Screwdriver Bit, 56mmL	D-10	120
6320	1/4" Hex Shank, T-20 Star Screwdriver Bit, 56mmL	D-10	120
6325	1/4" Hex Shank, T-25 Star Screwdriver Bit, 56mmL	D-10	120
6327	1/4" Hex Shank, T-27 Star Screwdriver Bit, 56mmL	D-10	120
6330	1/4" Hex Shank, T-30 Star Screwdriver Bit, 56mmL	D-10	120
6340	1/4" Hex Shank, T-40 Star Screwdriver Bit, 56mmL	D-10	120
6345	5/16" Hex Shank, T-45 Star Screwdriver Bit, 56mmL	D-10	160
6350	5/16" Hex Shank, T-50 Star Screwdriver Bit, 56mmL	D-10	160
635217	3/4" Dr. 17mm Hand Socket (12-Point) (CR-Mo)	B-82	630
635218	3/4" Dr. 18mm Hand Socket (12-Point) (CR-Mo)	B-82	630
635219	3/4" Dr. 19mm Hand Socket (12-Point) (CR-Mo)	B-82	630
635220	3/4" Dr. 20mm Hand Socket (12-Point) (CR-Mo)	B-82	630
635221	3/4" Dr. 21mm Hand Socket (12-Point) (CR-Mo)	B-82	630
635222	3/4" Dr. 22mm Hand Socket (12-Point) (CR-Mo)	B-82	630
635223	3/4" Dr. 23mm Hand Socket (12-Point) (CR-Mo)	B-82	630
635224	3/4" Dr. 24mm Hand Socket (12-Point) (CR-Mo)	B-82	685
635225	3/4" Dr. 25mm Hand Socket (12-Point) (CR-Mo)	B-82	685
635226	3/4" Dr. 26mm Hand Socket (12-Point) (CR-Mo)	B-82	685
635227	3/4" Dr. 27mm Hand Socket (12-Point) (CR-Mo)	B-82	735
635228	3/4" Dr. 28mm Hand Socket (12-Point) (CR-Mo)	B-82	735
635229	3/4" Dr. 29mm Hand Socket (12-Point) (CR-Mo)	B-82	840
635230	3/4" Dr. 30mm Hand Socket (12-Point) (CR-Mo)	B-82	840
635231	3/4" Dr. 31mm Hand Socket (12-Point) (CR-Mo)	B-82	840
635232	3/4" Dr. 32mm Hand Socket (12-Point) (CR-Mo)	B-82	840
635233	3/4" Dr. 33mm Hand Socket (12-Point) (CR-Mo)	B-82	1050
635234	3/4" Dr. 34mm Hand Socket (12-Point) (CR-Mo)	B-82	1050
635235	3/4" Dr. 35mm Hand Socket (12-Point) (CR-Mo)	B-82	1050
635236	3/4" Dr. 36mm Hand Socket (12-Point) (CR-Mo)	B-82	1155
635237	3/4" Dr. 37mm Hand Socket (12-Point) (CR-Mo)	B-82	1155
635238	3/4" Dr. 38mm Hand Socket (12-Point) (CR-Mo)	B-82	1155
635239	3/4" Dr. 39mm Hand Socket (12-Point) (CR-Mo)	B-82	1365
635240	3/4" Dr. 40mm Hand Socket (12-Point) (CR-Mo)	B-82	1365
635241	3/4" Dr. 41mm Hand Socket (12-Point) (CR-Mo)	B-82	1365
635242	3/4" Dr. 42mm Hand Socket (12-Point) (CR-Mo)	B-82	1470
635243	3/4" Dr. 43mm Hand Socket (12-Point) (CR-Mo)	B-82	1470
635244	3/4" Dr. 44mm Hand Socket (12-Point) (CR-Mo)	B-82	2075
635245	3/4" Dr. 45mm Hand Socket (12-Point) (CR-Mo)	B-82	2075
635246	3/4" Dr. 46mm Hand Socket (12-Point) (CR-Mo)	B-82	2075
635247	3/4" Dr. 47mm Hand Socket (12-Point) (CR-Mo)	B-82	2235
635248	3/4" Dr. 48mm Hand Socket (12-Point) (CR-Mo)	B-82	2235
635249	3/4" Dr. 49mm Hand Socket (12-Point) (CR-Mo)	B-82	2235
635250	3/4" Dr. 50mm Hand Socket (12-Point) (CR-Mo)	B-82	2235

Item No.	Description	Pg.	Code
635251	3/4" Dr. 51mm Hand Socket (12-Point) (CR-Mo)	B-82	2365
635252	3/4" Dr. 52mm Hand Socket (12-Point) (CR-Mo)	B-82	2365
635253	3/4" Dr. 53mm Hand Socket (12-Point) (CR-Mo)	B-82	2890
635254	3/4" Dr. 54mm Hand Socket (12-Point) (CR-Mo)	B-82	2890
635255	3/4" Dr. 55mm Hand Socket (12-Point) (CR-Mo)	B-82	2890
635256	3/4" Dr. 56mm Hand Socket (12-Point) (CR-Mo)	B-82	3100
635257	3/4" Dr. 57mm Hand Socket (12-Point) (CR-Mo)	B-82	3100
635258	3/4" Dr. 58mm Hand Socket (12-Point) (CR-Mo)	B-82	3100
635259	3/4" Dr. 59mm Hand Socket (12-Point) (CR-Mo)	B-82	3755
635260	3/4" Dr. 60mm Hand Socket (12-Point) (CR-Mo)	B-82	3755
635261	3/4" Dr. 61mm Hand Socket (12-Point) (CR-Mo)	B-82	4465
635262	3/4" Dr. 62mm Hand Socket (12-Point) (CR-Mo)	B-82	4465
635263	3/4" Dr. 63mm Hand Socket (12-Point) (CR-Mo)	B-82	4465
635264	3/4" Dr. 64mm Hand Socket (12-Point) (CR-Mo)	B-82	5250
635265	3/4" Dr. 65mm Hand Socket (12-Point) (CR-Mo)	B-82	5250
635266	3/4" Dr. 66mm Hand Socket (12-Point) (CR-Mo)	B-82	6825
635267	3/4" Dr. 67mm Hand Socket (12-Point) (CR-Mo)	B-82	6825
635268	3/4" Dr. 68mm Hand Socket (12-Point) (CR-Mo)	B-82	6825
635269	3/4" Dr. 69mm Hand Socket (12-Point) (CR-Mo)	B-82	6825
635270	3/4" Dr. 70mm Hand Socket (12-Point) (CR-Mo)	B-82	6825
6355	10mm Hex Shank, T-55 Star Screwdriver Bit, 56mmL	D-10	220
6360	12mm Hex Shank, T-60 Star Screwdriver Bit, 56mmL	D-10	280
6370	14mm Hex Shank, T-70 Star Screwdriver Bit, 56mmL	D-10	340
640100	3/4" Dr. Impact Extension Bar w/pin hole, 100mmL (CR-Mo)	A-47	2205
640100B	3/4" Dr. Impact Extension Bar w/steel ball, 100mmL (CR-Mo)	A-47	2205
6401050	3/4" Dr. Impact Extension Bar w/pin hole, 150mmL (CR-Mo)	A-47	2435
640150B	3/4" Dr. Impact Extension Bar w/steel ball, 150mmL (CR-Mo)	A-47	2435
640200	3/4" Dr. Impact Extension Bar w/pin hole, 200mmL (CR-Mo)	A-47	2565
640200B	3/4" Dr. Impact Extension Bar w/steel ball, 200mmL (CR-Mo)	A-47	2565
640250	3/4" Dr. Impact Extension Bar w/pin hole, 250mmL (CR-Mo)	A-47	2695
640250B	3/4" Dr. Impact Extension Bar w/steel ball, 250mmL (CR-Mo)	A-47	2695
640604	3/4" Dr. Impact Adapter w/pin hole, 3/4" F x 1/2" M (CR-Mo)	A-46	1040
640604B	3/4" Dr. Impact Adapter w/steel ball, 3/4" F x 1/2" M (CR-Mo)	A-46	1040
640606	3/4" Dr. Impact Universal Joint w/pin hole (CR-Mo)	A-47	4870
640606B	3/4" Dr. Impact Universal Joint w/steel ball (CR-Mo)	A-47	4870
640608	3/4" Dr. Impact Adapter w/pin hole, 3/4" F x 1" M (CR-Mo)	A-46	1090
640608B	3/4" Dr. Impact Adapter w/steel ball, 3/4" F x 1" M (CR-Mo)	A-46	1090
645217	3/4" Dr. 17mm Impact Socket (CR-Mo)	A-42	855
645218	3/4" Dr. 18mm Impact Socket (CR-Mo)	A-42	855
645219	3/4" Dr. 19mm Impact Socket (CR-Mo)	A-42	855
645220	3/4" Dr. 20mm Impact Socket (CR-Mo)	A-42	855
645221	3/4" Dr. 21mm Impact Socket (CR-Mo)	A-42	855
645222	3/4" Dr. 22mm Impact Socket (CR-Mo)	A-42	855
645223	3/4" Dr. 23mm Impact Socket (CR-Mo)	A-42	855
645224	3/4" Dr. 24mm Impact Socket (CR-Mo)	A-42	855
645225	3/4" Dr. 25mm Impact Socket (CR-Mo)	A-42	855
645226	3/4" Dr. 26mm Impact Socket (CR-Mo)	A-42	855
645227	3/4" Dr. 27mm Impact Socket (CR-Mo)	A-42	855
645228	3/4" Dr. 28mm Impact Socket (CR-Mo)	A-42	910
645229	3/4" Dr. 29mm Impact Socket (CR-Mo)	A-42	970
645230	3/4" Dr. 30mm Impact Socket (CR-Mo)	A-42	970
645231	3/4" Dr. 31mm Impact Socket (CR-Mo)	A-42	1025
645232	3/4" Dr. 32mm Impact Socket (CR-Mo)	A-42	1025
645233	3/4" Dr. 33mm Impact Socket (CR-Mo)	A-42	1115
645234	3/4" Dr. 34mm Impact Socket (CR-Mo)	A-42	1115
645235	3/4" Dr. 35mm Impact Socket (CR-Mo)	A-42	1175
645236	3/4" Dr. 36mm Impact Socket (CR-Mo)	A-42	1260
645237	3/4" Dr. 37mm Impact Socket (CR-Mo)	A-42	1315
645238	3/4" Dr. 38mm Impact Socket (CR-Mo)	A-42	1315
645239	3/4" Dr. 39mm Impact Socket (CR-Mo)	A-42	1645
645240	3/4" Dr. 40mm Impact Socket (CR-Mo)	A-42	1645
645241	3/4" Dr. 41mm Impact Socket (CR-Mo)	A-42	1645
645242	3/4" Dr. 42mm Impact Socket (CR-Mo)	A-42	2100
645243	3/4" Dr. 43mm Impact Socket (CR-Mo)	A-42	2100
645244	3/4" Dr. 44mm Impact Socket (CR-Mo)	A-42	2300
645245	3/4" Dr. 45mm Impact Socket (CR-Mo)	A-42	2300
645246	3/4" Dr. 46mm Impact Socket (CR-Mo)	A-42	2300
645247	3/4" Dr. 47mm Impact Socket (CR-Mo)	A-42	2435
645248	3/4" Dr. 48mm Impact Socket (CR-Mo)	A-42	2435
645249	3/4" Dr. 49mm Impact Socket (CR-Mo)	A-42	2435

Item No.	Description	Pg.	Code	Item No.	Description	Pg.	Code
645250	3/4" Dr. 50mm Impact Socket (CR-Mo)	A-42	2435	649547	3/4" Dr. 47mm Deep Impact Socket (CR-Mo)	A-44	4935
645251	3/4" Dr. 51mm Impact Socket (CR-Mo)	A-42	3675	649548	3/4" Dr. 48mm Deep Impact Socket (CR-Mo)	A-44	4935
645252	3/4" Dr. 52mm Impact Socket (CR-Mo)	A-42	3675	649549	3/4" Dr. 49mm Deep Impact Socket (CR-Mo)	A-44	4935
645253	3/4" Dr. 53mm Impact Socket (CR-Mo)	A-42	3940	649550	3/4" Dr. 50mm Deep Impact Socket (CR-Mo)	A-44	4935
645254	3/4" Dr. 54mm Impact Socket (CR-Mo)	A-42	3940	649551	3/4" Dr. 51mm Deep Impact Socket (CR-Mo)	A-44	5100
645255	3/4" Dr. 55mm Impact Socket (CR-Mo)	A-42	3940	649552	3/4" Dr. 52mm Deep Impact Socket (CR-Mo)	A-44	5100
645256	3/4" Dr. 56mm Impact Socket (CR-Mo)	A-42	4620	649553	3/4" Dr. 53mm Deep Impact Socket (CR-Mo)	A-44	5400
645257	3/4" Dr. 57mm Impact Socket (CR-Mo)	A-42	4620	649554	3/4" Dr. 54mm Deep Impact Socket (CR-Mo)	A-44	5400
645258	3/4" Dr. 58mm Impact Socket (CR-Mo)	A-42	5145	649555	3/4" Dr. 55mm Deep Impact Socket (CR-Mo)	A-44	5650
645259	3/4" Dr. 59mm Impact Socket (CR-Mo)	A-42	5670	649556	3/4" Dr. 56mm Deep Impact Socket (CR-Mo)	A-44	5950
645260	3/4" Dr. 60mm Impact Socket (CR-Mo)	A-42	6195	649557	3/4" Dr. 57mm Deep Impact Socket (CR-Mo)	A-44	5950
645261	3/4" Dr. 61mm Impact Socket (CR-Mo)	A-42	6825	649558	3/4" Dr. 58mm Deep Impact Socket (CR-Mo)	A-44	6200
645262	3/4" Dr. 62mm Impact Socket (CR-Mo)	A-42	6825	649559	3/4" Dr. 59mm Deep Impact Socket (CR-Mo)	A-44	6600
645263	3/4" Dr. 63mm Impact Socket (CR-Mo)	A-42	6825	649560	3/4" Dr. 60mm Deep Impact Socket (CR-Mo)	A-44	7160
645264	3/4" Dr. 64mm Impact Socket (CR-Mo)	A-42	7350	649561	3/4" Dr. 61mm Deep Impact Socket (CR-Mo)	A-44	7850
645265	3/4" Dr. 65mm Impact Socket (CR-Mo)	A-42	7350	649562	3/4" Dr. 62mm Deep Impact Socket (CR-Mo)	A-44	7850
645266	3/4" Dr. 66mm Impact Socket (CR-Mo)	A-42	7875	649563	3/4" Dr. 63mm Deep Impact Socket (CR-Mo)	A-44	7850
645267	3/4" Dr. 67mm Impact Socket (CR-Mo)	A-42	7875	649564	3/4" Dr. 64mm Deep Impact Socket (CR-Mo)	A-44	8960
645268	3/4" Dr. 68mm Impact Socket (CR-Mo)	A-42	7875	649565	3/4" Dr. 65mm Deep Impact Socket (CR-Mo)	A-44	8960
645269	3/4" Dr. 69mm Impact Socket (CR-Mo)	A-42	7875	649566	3/4" Dr. 66mm Deep Impact Socket (CR-Mo)	A-44	11300
645270	3/4" Dr. 70mm Impact Socket (CR-Mo)	A-42	7875	649567	3/4" Dr. 67mm Deep Impact Socket (CR-Mo)	A-44	11300
645271	3/4" Dr. 71mm Impact Socket (CR-Mo)	A-42	11000	649568	3/4" Dr. 68mm Deep Impact Socket (CR-Mo)	A-44	11850
645272	3/4" Dr. 72mm Impact Socket (CR-Mo)	A-42	13000	649569	3/4" Dr. 69mm Deep Impact Socket (CR-Mo)	A-44	11850
645273	3/4" Dr. 73mm Impact Socket (CR-Mo)	A-42	13000	649570	3/4" Dr. 70mm Deep Impact Socket (CR-Mo)	A-44	11850
645274	3/4" Dr. 74mm Impact Socket (CR-Mo)	A-42	13000	649571	3/4" Dr. 71mm Deep Impact Socket (CR-Mo)	A-44	13950
645275	3/4" Dr. 75mm Impact Socket (CR-Mo)	A-42	13000	649572	3/4" Dr. 72mm Deep Impact Socket (CR-Mo)	A-44	13950
645276	3/4" Dr. 76mm Impact Socket (CR-Mo)	A-42	14800	649573	3/4" Dr. 73mm Deep Impact Socket (CR-Mo)	A-44	13950
648814	3/4" Dr. 14mm Hex Head Driver, 88mmL	C-12	1940	649574	3/4" Dr. 74mm Deep Impact Socket (CR-Mo)	A-44	13950
648817	3/4" Dr. 17mm Hex Head Driver, 88mmL	C-12	1940	649575	3/4" Dr. 75mm Deep Impact Socket (CR-Mo)	A-44	13950
648819	3/4" Dr. 19mm Hex Head Driver, 88mmL	C-12	1940	649576	3/4" Dr. 76mm Deep Impact Socket (CR-Mo)	A-44	16000
648821	3/4" Dr. 21mm Hex Head Driver, 88mmL	C-12	1940	649833	3/4" Dr. 33mm Extra Long Budd Wheel Impact Socket	J-10	8600
648822	3/4" Dr. 22mm Hex Head Driver, 88mmL	C-12	1940	6506	1/4" Hex Shank, T-6 Star Screwdriver Bit, 88mmL	D-10	260
648824	3/4" Dr. 24mm Hex Head Driver, 88mmL	C-12	2070	6507	1/4" Hex Shank, T-7 Star Screwdriver Bit, 88mmL	D-10	260
648827	3/4" Dr. 27mm Hex Head Driver, 88mmL	C-12	2070	6508	1/4" Hex Shank, T-8 Star Screwdriver Bit, 88mmL	D-10	260
648830	3/4" Dr. 30mm Hex Head Driver, 88mmL	C-12	2200	6509	1/4" Hex Shank, T-9 Star Screwdriver Bit, 88mmL	D-10	260
648832	3/4" Dr. 32mm Hex Head Driver, 88mmL	C-12	2200	6510	1/4" Hex Shank, T-10 Star Screwdriver Bit, 88mmL	D-10	260
649517	3/4" Dr. 17mm Deep Impact Socket (CR-Mo)	A-44	1640	6515	1/4" Hex Shank, T-15 Star Screwdriver Bit, 88mmL	D-10	260
649517S	3/4" Dr. 17mm Budd Wheel Impact Socket	A-43	1905	6520	1/4" Hex Shank, T-20 Star Screwdriver Bit, 88mmL	D-10	260
649518	3/4" Dr. 18mm Deep Impact Socket (CR-Mo)	A-44	1640	6525	1/4" Hex Shank, T-25 Star Screwdriver Bit, 88mmL	D-10	260
649519	3/4" Dr. 19mm Deep Impact Socket (CR-Mo)	A-44	1640	6527	1/4" Hex Shank, T-27 Star Screwdriver Bit, 88mmL	D-10	260
649519S	3/4" Dr. 19mm Budd Wheel Impact Socket	A-43	1905	6530	1/4" Hex Shank, T-30 Star Screwdriver Bit, 88mmL	D-10	260
649520	3/4" Dr. 20mm Deep Impact Socket (CR-Mo)	A-44	1640	6540	1/4" Hex Shank, T-40 Star Screwdriver Bit, 88mmL	D-10	260
649520S	3/4" Dr. 20mm Budd Wheel Impact Socket	A-43	1905	6545	5/16" Hex Shank, T-45 Star Screwdriver Bit, 88mmL	D-10	300
649521	3/4" Dr. 21mm Deep Impact Socket (CR-Mo)	A-44	1640	6550	1/16" Hex Shank, T-50 Star Screwdriver Bit, 88mmL	D-10	300
649521S	3/4" Dr. 21mm Budd Wheel Impact Socket	A-43	1905	655217	3/4" Dr. 17mm Thin Wall Impact Socket (12-Point) (CR-Mo)	A-46	855
649522	3/4" Dr. 22mm Deep Impact Socket (CR-Mo)	A-44	1640	655218	3/4" Dr. 18mm Thin Wall Impact Socket (12-Point) (CR-Mo)	A-46	855
649523	3/4" Dr. 23mm Deep Impact Socket (CR-Mo)	A-44	1640	655219	3/4" Dr. 19mm Thin Wall Impact Socket (12-Point) (CR-Mo)	A-46	855
649524	3/4" Dr. 24mm Deep Impact Socket (CR-Mo)	A-44	1640	655220	3/4" Dr. 20mm Thin Wall Impact Socket (12-Point) (CR-Mo)	A-46	855
649525	3/4" Dr. 25mm Deep Impact Socket (CR-Mo)	A-44	1640	655221	3/4" Dr. 21mm Thin Wall Impact Socket (12-Point) (CR-Mo)	A-46	855
649526	3/4" Dr. 26mm Deep Impact Socket (CR-Mo)	A-44	1640	655222	3/4" Dr. 22mm Thin Wall Impact Socket (12-Point) (CR-Mo)	A-46	855
649527	3/4" Dr. 27mm Deep Impact Socket (CR-Mo)	A-44	1640	655223	3/4" Dr. 23mm Thin Wall Impact Socket (12-Point) (CR-Mo)	A-46	855
649528	3/4" Dr. 28mm Deep Impact Socket (CR-Mo)	A-44	1760	655224	3/4" Dr. 24mm Thin Wall Impact Socket (12-Point) (CR-Mo)	A-46	855
649529	3/4" Dr. 29mm Deep Impact Socket (CR-Mo)	A-44	1760	655225	3/4" Dr. 25mm Thin Wall Impact Socket (12-Point) (CR-Mo)	A-46	855
649530	3/4" Dr. 30mm Deep Impact Socket (CR-Mo)	A-44	1875	655226	3/4" Dr. 26mm Thin Wall Impact Socket (12-Point) (CR-Mo)	A-46	855
649531	3/4" Dr. 31mm Deep Impact Socket (CR-Mo)	A-44	1935	655227	3/4" Dr. 27mm Thin Wall Impact Socket (12-Point) (CR-Mo)	A-46	855
649532	3/4" Dr. 32mm Deep Impact Socket (CR-Mo)	A-44	1935	655228	3/4" Dr. 28mm Thin Wall Impact Socket (12-Point) (CR-Mo)	A-46	910
649533	3/4" Dr. 33mm Deep Impact Socket (CR-Mo)	A-44	1995	655229	3/4" Dr. 29mm Thin Wall Impact Socket (12-Point) (CR-Mo)	A-46	970
649534	3/4" Dr. 34mm Deep Impact Socket (CR-Mo)	A-44	2075	655230	3/4" Dr. 30mm Thin Wall Impact Socket (12-Point) (CR-Mo)	A-46	970
649535	3/4" Dr. 35mm Deep Impact Socket (CR-Mo)	A-44	2155	655231	3/4" Dr. 31mm Thin Wall Impact Socket (12-Point) (CR-Mo)	A-46	1025
649536	3/4" Dr. 36mm Deep Impact Socket (CR-Mo)	A-44	2260	655232	3/4" Dr. 32mm Thin Wall Impact Socket (12-Point) (CR-Mo)	A-46	1025
649537	3/4" Dr. 37mm Deep Impact Socket (CR-Mo)	A-44	2400	655233	3/4" Dr. 33mm Thin Wall Impact Socket (12-Point) (CR-Mo)	A-46	1025
649538	3/4" Dr. 38mm Deep Impact Socket (CR-Mo)	A-44	2400	655234	3/4" Dr. 34mm Thin Wall Impact Socket (12-Point) (CR-Mo)	A-46	1115
649539	3/4" Dr. 39mm Deep Impact Socket (CR-Mo)	A-44	2890	655235	3/4" Dr. 35mm Thin Wall Impact Socket (12-Point) (CR-Mo)	A-46	1175
649540	3/4" Dr. 40mm Deep Impact Socket (CR-Mo)	A-44	2890	655236	3/4" Dr. 36mm Thin Wall Impact Socket (12-Point) (CR-Mo)	A-46	1260
649541	3/4" Dr. 41mm Deep Impact Socket (CR-Mo)	A-44	3415	655237	3/4" Dr. 37mm Thin Wall Impact Socket (12-Point) (CR-Mo)	A-46	1315
649542	3/4" Dr. 42mm Deep Impact Socket (CR-Mo)	A-44	3675	655238	3/4" Dr. 38mm Thin Wall Impact Socket (12-Point) (CR-Mo)	A-46	1315
649543	3/4" Dr. 43mm Deep Impact Socket (CR-Mo)	A-44	3675	655239	3/4" Dr. 39mm Thin Wall Impact Socket (12-Point) (CR-Mo)	A-46	1645
649544	3/4" Dr. 44mm Deep Impact Socket (CR-Mo)	A-44	3940	655240	3/4" Dr. 40mm Thin Wall Impact Socket (12-Point) (CR-Mo)	A-46	1645
649545	3/4" Dr. 45mm Deep Impact Socket (CR-Mo)	A-44	3940	655241	3/4" Dr. 41mm Thin Wall Impact Socket (12-Point) (CR-Mo)	A-46	1645
649546	3/4" Dr. 46mm Deep Impact Socket (CR-Mo)	A-44	4465	655242	3/4" Dr. 42mm Thin Wall Impact Socket (12-Point) (CR-Mo)	A-46	2100

Item No.	Description	Pg.	Code	Item No.	Description	Pg.	Code
655243	3/4" Dr. 43mm Thin Wall Impact Socket (12-Point) (CR-Mo)	A-46	2100	665286	3/4" Dr. 2-11/16" Impact Socket (CR-Mo)	A-43	7875
655244	3/4" Dr. 44mm Thin Wall Impact Socket (12-Point) (CR-Mo)	A-46	2300	665288	3/4" Dr. 2-3/4" Impact Socket (CR-Mo)	A-43	7875
655245	3/4" Dr. 45mm Thin Wall Impact Socket (12-Point) (CR-Mo)	A-46	2300	665290	3/4" Dr. 2-13/16" Impact Socket (CR-Mo)	A-43	13000
655246	3/4" Dr. 46mm Thin Wall Impact Socket (12-Point) (CR-Mo)	A-46	2300	665292	3/4" Dr. 2-7/8" Impact Socket (CR-Mo)	A-43	13000
655247	3/4" Dr. 47mm Thin Wall Impact Socket (12-Point) (CR-Mo)	A-46	2435	665294	3/4" Dr. 2-15/16" Impact Socket (CR-Mo)	A-43	13000
655248	3/4" Dr. 48mm Thin Wall Impact Socket (12-Point) (CR-Mo)	A-46	2435	665296	3/4" Dr. 3" Impact Socket (CR-Mo)	A-43	14800
655249	3/4" Dr. 49mm Thin Wall Impact Socket (12-Point) (CR-Mo)	A-46	2435	6655	10mm Hex Shank, T-55 Star Screwdriver Bit, 125mmL	D-11	600
655250	3/4" Dr. 50mm Thin Wall Impact Socket (12-Point) (CR-Mo)	A-46	2435	6660	12mm Hex Shank, T-60 Star Screwdriver Bit, 125mmL	D-11	750
655251	3/4" Dr. 51mm Thin Wall Impact Socket (12-Point) (CR-Mo)	A-46	3675	6670	14mm Hex Shank, T-70 Star Screwdriver Bit, 125mmL	D-11	900
655252	3/4" Dr. 52mm Thin Wall Impact Socket (12-Point) (CR-Mo)	A-46	3675	668824	3/4" Dr. 3/4" Hex Head Driver, 88mmL	C-12	2050
655253	3/4" Dr. 53mm Thin Wall Impact Socket (12-Point) (CR-Mo)	A-46	3940	668826	3/4" Dr. 13/16" Hex Head Driver, 88mmL	C-12	2050
655254	3/4" Dr. 54mm Thin Wall Impact Socket (12-Point) (CR-Mo)	A-46	3940	668828	3/4" Dr. 7/8" Hex Head Driver, 88mmL	C-12	2050
655255	3/4" Dr. 55mm Thin Wall Impact Socket (12-Point) (CR-Mo)	A-46	3940	668830	3/4" Dr. 15/16" Hex Head Driver, 88mmL	C-12	2310
655256	3/4" Dr. 56mm Thin Wall Impact Socket (12-Point) (CR-Mo)	A-46	4620	668832	3/4" Dr. 1" Hex Head Driver, 88mmL	C-12	2310
655257	3/4" Dr. 57mm Thin Wall Impact Socket (12-Point) (CR-Mo)	A-46	4620	668834	3/4" Dr. 1-1/16" Hex Head Driver, 88mmL	C-12	2310
655258	3/4" Dr. 58mm Thin Wall Impact Socket (12-Point) (CR-Mo)	A-46	5145	668836	3/4" Dr. 1-1/8" Hex Head Driver, 88mmL	C-12	2470
655259	3/4" Dr. 59mm Thin Wall Impact Socket (12-Point) (CR-Mo)	A-46	5670	668838	3/4" Dr. 1-3/16" Hex Head Driver, 88mmL	C-12	2470
655260	3/4" Dr. 60mm Thin Wall Impact Socket (12-Point) (CR-Mo)	A-46	6195	668840	3/4" Dr. 1-1/4" Hex Head Driver, 88mmL	C-12	2470
655263	3/4" Dr. 63mm Thin Wall Impact Socket (12-Point) (CR-Mo)	A-46	6825	669522	3/4" Dr. 11/16" Impact Socket (CR-Mo)	A-45	1640
655265	3/4" Dr. 65mm Thin Wall Impact Socket (12-Point) (CR-Mo)	A-46	7350	669522S	3/4" Dr. 11/16" Budd Wheel Impact Socket	A-43	1905
655270	3/4" Dr. 70mm Thin Wall Impact Socket (12-Point) (CR-Mo)	A-46	7875	669524	3/4" Dr. 3/4" Impact Socket (CR-Mo)	A-45	1640
6555	10mm Hex Shank, T-55 Star Screwdriver Bit, 88mmL	D-10	400	669524S	3/4" Dr. 3/4" Budd Wheel Impact Socket	A-43	1905
6560	12mm Hex Shank, T-60 Star Screwdriver Bit, 88mmL	D-10	540	669525	3/4" Dr. 25/32" Impact Socket (CR-Mo)	A-45	1640
6570	14mm Hex Shank, T-70 Star Screwdriver Bit, 88mmL	D-10	680	669526	3/4" Dr. 13/16" Impact Socket (CR-Mo)	A-45	1640
6606	1/4" Hex Shank, T-6 Star Screwdriver Bit, 125mmL	D-11	300	669526S	3/4" Dr. 13/16" Budd Wheel Impact Socket	A-43	1905
6607	1/4" Hex Shank, T-7 Star Screwdriver Bit, 125mmL	D-11	300	669528	3/4" Dr. 7/8" Impact Socket (CR-Mo)	A-45	1640
6608	1/4" Hex Shank, T-8 Star Screwdriver Bit, 125mmL	D-11	300	669530	3/4" Dr. 15/16" Impact Socket (CR-Mo)	A-45	1640
6609	1/4" Hex Shank, T-9 Star Screwdriver Bit, 125mmL	D-11	300	669532	3/4" Dr. 1" Impact Socket (CR-Mo)	A-45	1640
6610	1/4" Hex Shank, T-10 Star Screwdriver Bit, 125mmL	D-11	300	669534	3/4" Dr. 1-1/16" Impact Socket (CR-Mo)	A-45	1640
6615	1/4" Hex Shank, T-15 Star Screwdriver Bit, 125mmL	D-11	300	669534T	3/4" Dr. 1-1/16" Deep Thin Wall Impact Socket (CR-Mo)	A-45	1640
6620	1/4" Hex Shank, T-20 Star Screwdriver Bit, 125mmL	D-11	300	669536	3/4" Dr. 1-1/8" Impact Socket (CR-Mo)	A-45	1760
6625	1/4" Hex Shank, T-25 Star Screwdriver Bit, 125mmL	D-11	300	669536T	3/4" Dr. 1-1/8" Deep Thin Wall Impact Socket (CR-Mo)	A-45	1760
6627	1/4" Hex Shank, T-27 Star Screwdriver Bit, 125mmL	D-11	300	669538	3/4" Dr. 1-3/16" Impact Socket (CR-Mo)	A-45	1875
6630	1/4" Hex Shank, T-30 Star Screwdriver Bit, 125mmL	D-11	300	669540	3/4" Dr. 1-1/4" Impact Socket (CR-Mo)	A-45	1935
6640	1/4" Hex Shank, T-40 Star Screwdriver Bit, 125mmL	D-11	300	669540T	3/4" Dr. 1-1/4" Deep Thin Wall Impact Socket (CR-Mo)	A-45	1935
6645	5/16" Hex Shank, T-45 Star Screwdriver Bit, 125mmL	D-11	400	669542	3/4" Dr. 1-5/16" Impact Socket (CR-Mo)	A-45	2075
6650	5/16" Hex Shank, T-50 Star Screwdriver Bit, 125mmL	D-11	400	669544	3/4" Dr. 1-3/8" Impact Socket (CR-Mo)	A-45	2155
665222	3/4" Dr. 11/16" Impact Socket (CR-Mo)	A-43	855	669546	3/4" Dr. 1-7/16" Impact Socket (CR-Mo)	A-45	2260
665224	3/4" Dr. 3/4" Impact Socket (CR-Mo)	A-43	855	669548	3/4" Dr. 1-1/2" Impact Socket (CR-Mo)	A-45	2890
665225	3/4" Dr. 25/32" Impact Socket (CR-Mo)	A-43	855	669548B	3/4" Dr. 1-1/2" Deep Budd Wheel Impact Socket (CR-Mo)	J-16	2750
665226	3/4" Dr. 13/16" Impact Socket (CR-Mo)	A-43	855	669550	3/4" Dr. 1-9/16" Impact Socket (CR-Mo)	A-45	2890
665228	3/4" Dr. 7/8" Impact Socket (CR-Mo)	A-43	855	669552	3/4" Dr. 1-5/8" Impact Socket (CR-Mo)	A-45	3415
665230	3/4" Dr. 15/16" Impact Socket (CR-Mo)	A-43	855	669554	3/4" Dr. 1-11/16" Impact Socket (CR-Mo)	A-45	3675
665232	3/4" Dr. 1" Impact Socket (CR-Mo)	A-43	855	669556	3/4" Dr. 1-3/4" Impact Socket (CR-Mo)	A-45	3940
665234	3/4" Dr. 1-1/16" Impact Socket (CR-Mo)	A-43	855	669558	3/4" Dr. 1-13/16" Impact Socket (CR-Mo)	A-45	4465
665236	3/4" Dr. 1-1/8" Impact Socket (CR-Mo)	A-43	910	669560	3/4" Dr. 1-7/8" Impact Socket (CR-Mo)	A-45	4935
665238	3/4" Dr. 1-3/16" Impact Socket (CR-Mo)	A-43	970	669562	3/4" Dr. 1-15/16" Impact Socket (CR-Mo)	A-45	4935
665240	3/4" Dr. 1-1/4" Impact Socket (CR-Mo)	A-43	1025	669564	3/4" Dr. 2" Impact Socket (CR-Mo)	A-45	5250
665242	3/4" Dr. 1-5/16" Impact Socket (CR-Mo)	A-43	1115	669566	3/4" Dr. 2-1/16" Impact Socket (CR-Mo)	A-45	5500
665244	3/4" Dr. 1-3/8" Impact Socket (CR-Mo)	A-43	1175	669568	3/4" Dr. 2-1/8" Impact Socket (CR-Mo)	A-45	5700
665246	3/4" Dr. 1-7/16" Impact Socket (CR-Mo)	A-43	1260	669570	3/4" Dr. 2-3/16" Impact Socket (CR-Mo)	A-45	6000
665248	3/4" Dr. 1-1/2" Impact Socket (CR-Mo)	A-43	1315	669572	3/4" Dr. 2-1/4" Impact Socket (CR-Mo)	A-45	6300
665250	3/4" Dr. 1-9/16" Impact Socket (CR-Mo)	A-43	1645	669574	3/4" Dr. 2-5/16" Impact Socket (CR-Mo)	A-45	6800
665252	3/4" Dr. 1-5/8" Impact Socket (CR-Mo)	A-43	1645	669576	3/4" Dr. 2-3/8" Impact Socket (CR-Mo)	A-45	7300
665254	3/4" Dr. 1-11/16" Impact Socket (CR-Mo)	A-43	2100	669578	3/4" Dr. 2-7/16" Impact Socket (CR-Mo)	A-45	8100
665256	3/4" Dr. 1-3/4" Impact Socket (CR-Mo)	A-43	2300	669580	3/4" Dr. 2-1/2" Impact Socket (CR-Mo)	A-45	8100
665258	3/4" Dr. 1-13/16" Impact Socket (CR-Mo)	A-43	2300	669582	3/4" Dr. 2-9/16" Impact Socket (CR-Mo)	A-45	9000
665260	3/4" Dr. 1-7/8" Impact Socket (CR-Mo)	A-43	2435	669584	3/4" Dr. 2-5/8" Impact Socket (CR-Mo)	A-45	11700
665262	3/4" Dr. 1-15/16" Impact Socket (CR-Mo)	A-43	3150	669586	3/4" Dr. 2-11/16" Impact Socket (CR-Mo)	A-45	11700
665264	3/4" Dr. 2" Impact Socket (CR-Mo)	A-43	3940	669588	3/4" Dr. 2-3/4" Impact Socket (CR-Mo)	A-45	11700
665266	3/4" Dr. 2-1/16" Impact Socket (CR-Mo)	A-43	3940	669590	3/4" Dr. 2-13/16" Impact Socket (CR-Mo)	A-45	15600
665268	3/4" Dr. 2-1/8" Impact Socket (CR-Mo)	A-43	3940	669592	3/4" Dr. 2-7/8" Impact Socket (CR-Mo)	A-45	16400
665270	3/4" Dr. 2-3/16" Impact Socket (CR-Mo)	A-43	3940	669594	3/4" Dr. 2-15/16" Impact Socket (CR-Mo)	A-45	16400
665272	3/4" Dr. 2-1/4" Impact Socket (CR-Mo)	A-43	4620	669596	3/4" Dr. 3" Impact Socket (CR-Mo)	A-45	17200
665274	3/4" Dr. 2-5/16" Impact Socket (CR-Mo)	A-43	5670	669826S	3/4" Dr. 13/16" Square Extra Long Budd Wheel Impact Socket	J-10	8600
665276	3/4" Dr. 2-3/8" Impact Socket (CR-Mo)	A-43	6195	669834	3/4" Dr. 1-1/16" Extra Long Budd Wheel Impact Socket	J-10	8600
665278	3/4" Dr. 2-7/16" Impact Socket (CR-Mo)	A-43	6825	669836	3/4" Dr. 1-1/8" Extra Long Budd Wheel Impact Socket	J-10	8600
665280	3/4" Dr. 2-1/2" Impact Socket (CR-Mo)	A-43	6825	669840	3/4" Dr. 1-1/4" Extra Long Budd Wheel Impact Socket	J-10	8600
665282	3/4" Dr. 2-9/16" Impact Socket (CR-Mo)	A-43	7350	669848	3/4" Dr. 1-1/2" Extra Long Budd Wheel Impact Socket	J-10	8600
665284	3/4" Dr. 2-5/8" Impact Socket (CR-Mo)	A-43	7875	6706	1/4" Hex Shank, T-6 Star Screwdriver Bit, 160mmL	D-11	380

Item No.	Description	Pg.	Code	Item No.	Description	Pg.	Code
6707	1/4" Hex Shank, T-7 Star Screwdriver Bit, 160mmL	D-11	380	6808	1/4" Hex Shank, T-8 Star Screwdriver Bit, 200mmL	D-11	450
6708	1/4" Hex Shank, T-8 Star Screwdriver Bit, 160mmL	D-11	380	680850	3/4" & 1" Dr. Tube Handle, 850mmL	B-84	5160
6709	1/4" Hex Shank, T-9 Star Screwdriver Bit, 160mmL	D-11	380	6809	1/4" Hex Shank, T-9 Star Screwdriver Bit, 200mmL	D-11	450
6710	1/4" Hex Shank, T-10 Star Screwdriver Bit, 160mmL	D-11	380	680980N	3/4" Dr. Torque Wrench, 140 ~ 980 Nm	F-36	86500
6715	1/4" Hex Shank, T-15 Star Screwdriver Bit, 160mmL	D-11	380	6810	1/4" Hex Shank, T-10 Star Screwdriver Bit, 200mmL	D-11	450
6720	1/4" Hex Shank, T-20 Star Screwdriver Bit, 160mmL	D-11	380	681000F	3/4" Dr. Torque Wrench, 200 ~ 1000 ft. lbs.	F-36	98200
6725	1/4" Hex Shank, T-25 Star Screwdriver Bit, 160mmL	D-11	380	6815	1/4" Hex Shank, T-15 Star Screwdriver Bit, 200mmL	D-11	450
6727	1/4" Hex Shank, T-27 Star Screwdriver Bit, 160mmL	D-11	380	681500N	3/4" Dr. Torque Wrench, 300 ~ 1500 Nm	F-36	98200
6730	1/4" Hex Shank, T-30 Star Screwdriver Bit, 160mmL	D-11	380	6820	1/4" Hex Shank, T-20 Star Screwdriver Bit, 200mmL	D-11	450
6740	1/4" Hex Shank, T-40 Star Screwdriver Bit, 160mmL	D-11	380	6825	1/4" Hex Shank, T-25 Star Screwdriver Bit, 200mmL	D-11	450
6745	5/16" Hex Shank, T-45 Star Screwdriver Bit, 160mmL	D-11	500	6827	1/4" Hex Shank, T-27 Star Screwdriver Bit, 200mmL	D-11	450
6750	5/16" Hex Shank, T-50 Star Screwdriver Bit, 160mmL	D-11	500	6830	1/4" Hex Shank, T-30 Star Screwdriver Bit, 200mmL	D-11	450
675222	3/4" Dr. 11/16" Hand Socket (12-Point) (CR-Mo)	B-83	630	6840	1/4" Hex Shank, T-40 Star Screwdriver Bit, 200mmL	D-11	450
675224	3/4" Dr. 3/4" Hand Socket (12-Point) (CR-Mo)	B-83	630	6845	5/16" Hex Shank, T-45 Star Screwdriver Bit, 200mmL	D-11	600
675225	3/4" Dr. 25/32" Hand Socket (12-Point) (CR-Mo)	B-83	630	6850	5/16" Hex Shank, T-50 Star Screwdriver Bit, 200mmL	D-11	600
675226	3/4" Dr. 13/16" Hand Socket (12-Point) (CR-Mo)	B-83	630	685222	3/4" Dr. 11/16" Hand Socket (CR-Mo)	B-79	630
675228	3/4" Dr. 7/8" Hand Socket (12-Point) (CR-Mo)	B-83	630	685224	3/4" Dr. 3/4" Hand Socket (CR-Mo)	B-79	630
675230	3/4" Dr. 15/16" Hand Socket (12-Point) (CR-Mo)	B-83	685	685225	3/4" Dr. 25/32" Hand Socket (CR-Mo)	B-79	630
675232	3/4" Dr. 1" Hand Socket (12-Point) (CR-Mo)	B-83	685	685226	3/4" Dr. 13/16" Hand Socket (CR-Mo)	B-79	630
675234	3/4" Dr. 1-1/16" Hand Socket (12-Point) (CR-Mo)	B-83	735	685228	3/4" Dr. 7/8" Hand Socket (CR-Mo)	B-79	630
675236	3/4" Dr. 1-1/8" Hand Socket (12-Point) (CR-Mo)	B-83	840	685230	3/4" Dr. 15/16" Hand Socket (CR-Mo)	B-79	685
675238	3/4" Dr. 1-3/16" Hand Socket (12-Point) (CR-Mo)	B-83	840	685232	3/4" Dr. 1" Hand Socket (CR-Mo)	B-79	685
675240	3/4" Dr. 1-1/4" Hand Socket (12-Point) (CR-Mo)	B-83	840	685234	3/4" Dr. 1-1/16" Hand Socket (CR-Mo)	B-79	735
675242	3/4" Dr. 1-5/16" Hand Socket (12-Point) (CR-Mo)	B-83	1050	685236	3/4" Dr. 1-1/8" Hand Socket (CR-Mo)	B-79	840
675244	3/4" Dr. 1-3/8" Hand Socket (12-Point) (CR-Mo)	B-83	1050	685238	3/4" Dr. 1-3/16" Hand Socket (CR-Mo)	B-79	840
675246	3/4" Dr. 1-7/16" Hand Socket (12-Point) (CR-Mo)	B-83	1155	685240	3/4" Dr. 1-1/4" Hand Socket (CR-Mo)	B-79	840
675248	3/4" Dr. 1-1/2" Hand Socket (12-Point) (CR-Mo)	B-83	1155	685242	3/4" Dr. 1-5/16" Hand Socket (CR-Mo)	B-79	1050
675250	3/4" Dr. 1-9/16" Hand Socket (12-Point) (CR-Mo)	B-83	1365	685244	3/4" Dr. 1-3/8" Hand Socket (CR-Mo)	B-79	1050
675252	3/4" Dr. 1-5/8" Hand Socket (12-Point) (CR-Mo)	B-83	1365	685246	3/4" Dr. 1-7/16" Hand Socket (CR-Mo)	B-79	1155
675254	3/4" Dr. 1-11/16" Hand Socket (12-Point) (CR-Mo)	B-83	1470	685248	3/4" Dr. 1-1/2" Hand Socket (CR-Mo)	B-79	1155
675256	3/4" Dr. 1-3/4" Hand Socket (12-Point) (CR-Mo)	B-83	2075	685250	3/4" Dr. 1-9/16" Hand Socket (CR-Mo)	B-79	1365
675258	3/4" Dr. 1-13/16" Hand Socket (12-Point) (CR-Mo)	B-83	2075	685252	3/4" Dr. 1-5/8" Hand Socket (CR-Mo)	B-79	1365
675260	3/4" Dr. 1-7/8" Hand Socket (12-Point) (CR-Mo)	B-83	2235	685254	3/4" Dr. 1-11/16" Hand Socket (CR-Mo)	B-79	1470
675262	3/4" Dr. 1-15/16" Hand Socket (12-Point) (CR-Mo)	B-83	2235	685256	3/4" Dr. 1-3/4" Hand Socket (CR-Mo)	B-79	2075
675264	3/4" Dr. 2" Hand Socket (12-Point) (CR-Mo)	B-83	2365	685258	3/4" Dr. 1-13/16" Hand Socket (CR-Mo)	B-79	2075
675266	3/4" Dr. 2-1/16" Hand Socket (12-Point) (CR-Mo)	B-83	2365	685260	3/4" Dr. 1-7/8" Hand Socket (CR-Mo)	B-79	2235
675268	3/4" Dr. 2-1/8" Hand Socket (12-Point) (CR-Mo)	B-83	2890	685262	3/4" Dr. 1-15/16" Hand Socket (CR-Mo)	B-79	2235
675270	3/4" Dr. 2-3/16" Hand Socket (12-Point) (CR-Mo)	B-83	2890	685264	3/4" Dr. 2" Hand Socket (CR-Mo)	B-79	2365
675272	3/4" Dr. 2-1/4" Hand Socket (12-Point) (CR-Mo)	B-83	3100	685266	3/4" Dr. 2-1/16" Hand Socket (CR-Mo)	B-79	2365
675274	3/4" Dr. 2-5/16" Hand Socket (12-Point) (CR-Mo)	B-83	3755	685268	3/4" Dr. 2-1/8" Hand Socket (CR-Mo)	B-79	2890
675276	3/4" Dr. 2-3/8" Hand Socket (12-Point) (CR-Mo)	B-83	3755	685270	3/4" Dr. 2-3/16" Hand Socket (CR-Mo)	B-79	2890
675278	3/4" Dr. 2-7/16" Hand Socket (12-Point) (CR-Mo)	B-83	4465	685272	3/4" Dr. 2-1/4" Hand Socket (CR-Mo)	B-79	3100
675280	3/4" Dr. 2-1/2" Hand Socket (12-Point) (CR-Mo)	B-83	4465	685274	3/4" Dr. 2-5/16" Hand Socket (CR-Mo)	B-79	3755
675282	3/4" Dr. 2-9/16" Hand Socket (12-Point) (CR-Mo)	B-83	5775	685276	3/4" Dr. 2-3/8" Hand Socket (CR-Mo)	B-79	3755
675284	3/4" Dr. 2-5/8" Hand Socket (12-Point) (CR-Mo)	B-83	5775	685278	3/4" Dr. 2-7/16" Hand Socket (CR-Mo)	B-79	4465
675286	3/4" Dr. 2-11/16" Hand Socket (12-Point) (CR-Mo)	B-83	6825	685280	3/4" Dr. 2-1/2" Hand Socket (CR-Mo)	B-79	4465
675288	3/4" Dr. 2-3/4" Hand Socket (12-Point) (CR-Mo)	B-83	6825	685282	3/4" Dr. 2-9/16" Hand Socket (CR-Mo)	B-79	5775
6755	10mm Hex Shank, T-55 Star Screwdriver Bit, 160mmL	D-11	700	685284	3/4" Dr. 2-5/8" Hand Socket (CR-Mo)	B-79	5775
6760	12mm Hex Shank, T-60 Star Screwdriver Bit, 160mmL	D-11	880	685286	3/4" Dr. 2-11/16" Hand Socket (CR-Mo)	B-79	6825
6770	14mm Hex Shank, T-70 Star Screwdriver Bit, 160mmL	D-11	1050	685288	3/4" Dr. 2-3/4" Hand Socket (CR-Mo)	B-79	6825
680060	3/4" Dr. Sliding T-Handle (CR-Mo)	B-84	4080	685290	3/4" Dr. 2-13/16" Hand Socket (CR-Mo)	B-79	11700
680300F	3/4" Dr. Torque Wrench, 50 ~ 300 ft. lbs.	F-36	24300	685292	3/4" Dr. 2-7/8" Hand Socket (CR-Mo)	B-79	11700
680350	3/4" & 1" Dr. Tube Handle, 350mmL	B-84	2720	685294	3/4" Dr. 2-15/16" Hand Socket (CR-Mo)	B-79	11700
680446	3/4" Dr. Hinge Head (CR-Mo)	B-84	5100	685296	3/4" Dr. 3" Hand Socket (CR-Mo)	B-79	13500
680446A	3/4" Dr. Hinge Handle (CR-Mo)	B-84	6500	6855	10mm Hex Shank, T-55 Star Screwdriver Bit, 200mmL	D-11	800
680446E	3/4" Dr. Hinge Head with Tube Handle (CR-Mo)	B-84	7000	6860	12mm Hex Shank, T-60 Star Screwdriver Bit, 200mmL	D-11	1000
680500N	3/4" Dr. Torque Wrench, 100 ~ 500 Nm	F-36	24300	6870	14mm Hex Shank, T-70 Star Screwdriver Bit, 200mmL	D-11	1200
680580	3/4" & 1" Dr. Dr. Tube Handle, 580mmL	B-84	3700	687175	3/4" Dr. Torque Extension Bar, 175 ft.lbs.(240Nm)	J-13	6800
6806	1/4" Hex Shank, T-6 Star Screwdriver Bit, 200mmL	D-11	450	687250	3/4" Dr. Torque Extension Bar, 250 ft.lbs.(340Nm)	J-13	6800
680600F	3/4" Dr. Torque Wrench, 100 ~ 600 ft. lbs.	F-36	69200	687350	3/4" Dr. Torque Extension Bar, 350 ft.lbs.(475Nm)	J-13	6800
680606	3/4" Dr. Universal Joint (CR-Mo)	B-84	4080	687475	3/4" Dr. Torque Extension Bar, 475 ft.lbs.(645Nm)	J-13	6800
680610S	3/4" Dr. Ratchet with Plastic Handle (CR-Mo)	B-84	12000	689522	3/4" Dr. 11/16" Deep Hand Socket (CR-Mo)	B-81	1525
680666	3/4" Dr. Ratchet Head (CR-Mo)	B-84	8800	689524	3/4" Dr. 3/4" Deep Hand Socket (CR-Mo)	B-81	1525
680666R	3/4" Dr. Ratchet with Tube Handle (CR-Mo)	B-84	9900	689525	3/4" Dr. 25/32" Deep Hand Socket (CR-Mo)	B-81	1525
680666RA	3/4" Dr. Ratchet Head with Tube Handle (CR-Mo)	B-84	11110	689526	3/4" Dr. 13/16" Deep Hand Socket (CR-Mo)	B-81	1525
680672	3/4" Dr. Ratchet Head (CR-Mo)	B-84	7700	689528	3/4" Dr. 7/8" Deep Hand Socket (CR-Mo)	B-81	1525
680672E	3/4" Dr. Ratchet Head with Tube Handle (CR-Mo)	B-84	9600	689530	3/4" Dr. 15/16" Deep Hand Socket (CR-Mo)	B-81	1525
6807	1/4" Hex Shank, T-7 Star Screwdriver Bit, 200mmL	D-11	450	689532	3/4" Dr. 1" Deep Hand Socket (CR-Mo)	B-81	1525
680700F	3/4" Dr. Torque Wrench, 100 ~ 700 ft. lbs.	F-36	86500	689534	3/4" Dr. 1-1/16" Deep Hand Socket (CR-Mo)	B-81	1525
680700N	3/4" Dr. Torque Wrench, 140 ~ 700 Nm	F-36	69200	689536	3/4" Dr. 1-1/8" Deep Hand Socket (CR-Mo)	B-81	1630

Item No.	Description	Pg.	Code
689538	3/4" Dr. 1-3/16" Deep Hand Socket (CR-Mo)	B-81	1735
689540	3/4" Dr. 1-1/4" Deep Hand Socket (CR-Mo)	B-81	1785
689542	3/4" Dr. 1-5/16" Deep Hand Socket (CR-Mo)	B-81	1840
689544	3/4" Dr. 1-3/8" Deep Hand Socket (CR-Mo)	B-81	2100
689546	3/4" Dr. 1-7/16" Deep Hand Socket (CR-Mo)	B-81	2100
689548	3/4" Dr. 1-1/2" Deep Hand Socket (CR-Mo)	B-81	2365
689550	3/4" Dr. 1-9/16" Deep Hand Socket (CR-Mo)	B-81	2625
689552	3/4" Dr. 1-5/8" Deep Hand Socket (CR-Mo)	B-81	2890
689554	3/4" Dr. 1-11/16" Deep Hand Socket (CR-Mo)	B-81	3150
689556	3/4" Dr. 1-3/4" Deep Hand Socket (CR-Mo)	B-81	3415
689558	3/4" Dr. 1-13/16" Deep Hand Socket (CR-Mo)	B-81	3940
689560	3/4" Dr. 1-7/8" Deep Hand Socket (CR-Mo)	B-81	4200
689562	3/4" Dr. 1-15/16" Deep Hand Socket (CR-Mo)	B-81	4465
689564	3/4" Dr. 2" Deep Hand Socket (CR-Mo)	B-81	4990
689566	3/4" Dr. 2-1/16" Deep Hand Socket (CR-Mo)	B-81	5250
689568	3/4" Dr. 2-1/8" Deep Hand Socket (CR-Mo)	B-81	5450
689570	3/4" Dr. 2-3/16" Deep Hand Socket (CR-Mo)	B-81	5700
689572	3/4" Dr. 2-1/4" Deep Hand Socket (CR-Mo)	B-81	6000
689574	3/4" Dr. 2-5/16" Deep Hand Socket (CR-Mo)	B-81	6500
689576	3/4" Dr. 2-3/8" Deep Hand Socket (CR-Mo)	B-81	7000
689578	3/4" Dr. 2-7/16" Deep Hand Socket (CR-Mo)	B-81	7700
689580	3/4" Dr. 2-1/2" Deep Hand Socket (CR-Mo)	B-81	7700
689582	3/4" Dr. 2-9/16" Deep Hand Socket (CR-Mo)	B-81	8600
689584	3/4" Dr. 2-5/8" Deep Hand Socket (CR-Mo)	B-81	11200
689586	3/4" Dr. 2-11/16" Deep Hand Socket (CR-Mo)	B-81	13300
689588	3/4" Dr. 2-3/4" Deep Hand Socket (CR-Mo)	B-81	13300
689590	3/4" Dr. 2-13/16" Deep Hand Socket (CR-Mo)	B-81	15000
689592	3/4" Dr. 2-7/8" Deep Hand Socket (CR-Mo)	B-81	16000
689594	3/4" Dr. 2-15/16" Deep Hand Socket (CR-Mo)	B-81	16000
689596	3/4" Dr. 3" Deep Hand Socket (CR-Mo)	B-81	17000
695222	3/4" Dr. 11/16" Thin Wall Impact Socket (12-Point) (CR-Mo)	A-47	855
695224	3/4" Dr. 3/4" Thin Wall Impact Socket (12-Point) (CR-Mo)	A-47	855
695225	3/4" Dr. 25/32" Thin Wall Impact Socket (12-Point) (CR-Mo)	A-47	855
695226	3/4" Dr. 13/16" Thin Wall Impact Socket (12-Point) (CR-Mo)	A-47	855
695228	3/4" Dr. 7/8" Thin Wall Impact Socket (12-Point) (CR-Mo)	A-47	855
695230	3/4" Dr. 15/16" Thin Wall Impact Socket (12-Point) (CR-Mo)	A-47	855
695232	3/4" Dr. 1" Thin Wall Impact Socket (12-Point) (CR-Mo)	A-47	855
695234	3/4" Dr. 1-1/16" Thin Wall Impact Socket (12-Point) (CR-Mo)	A-47	855
695236	3/4" Dr. 1/1/8" Thin Wall Impact Socket (12-Point) (CR-Mo)	A-47	910
695238	3/4" Dr. 1-3/16" Thin Wall Impact Socket (12-Point) (CR-Mo)	A-47	970
695240	3/4" Dr. 1-1/4" Thin Wall Impact Socket (12-Point) (CR-Mo)	A-47	1025
695242	3/4" Dr. 1-5/16" Thin Wall Impact Socket (12-Point) (CR-Mo)	A-47	1115
695244	3/4" Dr. 1-3/8" Thin Wall Impact Socket (12-Point) (CR-Mo)	A-47	1175
695246	3/4" Dr. 1-7/16" Thin Wall Impact Socket (12-Point) (CR-Mo)	A-47	1260
695248	3/4" Dr. 1-1/2" Thin Wall Impact Socket (12-Point) (CR-Mo)	A-47	1315
695250	3/4" Dr. 1-9/16" Thin Wall Impact Socket (12-Point) (CR-Mo)	A-47	1645
695252	3/4" Dr. 1-5/8" Thin Wall Impact Socket (12-Point) (CR-Mo)	A-47	1645
695254	3/4" Dr. 1-11/16" Thin Wall Impact Socket (12-Point) (CR-Mo)	A-47	1910
695256	3/4" Dr. 1-3/4" Thin Wall Impact Socket (12-Point) (CR-Mo)	A-47	2100
695258	3/4" Dr. 1-13/16" Thin Wall Impact Socket (12-Point) (CR-Mo)	A-47	2300
695260	3/4" Dr. 1-7/8" Thin Wall Impact Socket (12-Point) (CR-Mo)	A-47	2435
695262	3/4" Dr. 1-15/16" Thin Wall Impact Socket (12-Point) (CR-Mo)	A-47	3150
695264	3/4" Dr. 2" Thin Wall Impact Socket (12-Point) (CR-Mo)	A-47	3150
695266	3/4" Dr. 2-1/16" Thin Wall Impact Socket (12-Point) (CR-Mo)	A-47	3940
695268	3/4" Dr. 2-1/8" Thin Wall Impact Socket (12-Point) (CR-Mo)	A-47	3940
695270	3/4" Dr. 2-3/16" Thin Wall Impact Socket (12-Point) (CR-Mo)	A-47	3940
695272	3/4" Dr. 2-1/4" Thin Wall Impact Socket (12-Point) (CR-Mo)	A-47	4620
695274	3/4" Dr. 2-5/16" Thin Wall Impact Socket (12-Point) (CR-Mo)	A-47	5670
695276	3/4" Dr. 2-3/8" Thin Wall Impact Socket (12-Point) (CR-Mo)	A-47	6195
695280	3/4" Dr. 2-1/2" Thin Wall Impact Socket (12-Point) (CR-Mo)	A-47	6825
695284	3/4" Dr. 2-5/8" Thin Wall Impact Socket (12-Point) (CR-Mo)	A-47	7350
695288	3/4" Dr. 2-3/4" Thin Wall Impact Socket (12-Point) (CR-Mo)	A-47	7875
6980	19mm Hex Shank, T-80 Star Impact Screwdriver Bit, 60mmL	D-20	700
6990	19mm Hex Shank, T-90 Star Impact Screwdriver Bit, 60mmL	D-20	700
6995	19mm Hex Shank, T-100 Star Impact Screwdriver Bit, 60mmL	D-20	700
6K1490	3/4" Dr. Air Impact Wrench, 1,100 ft. lbs. / 1,491 Nm	E-11	99000

Item No.	Description	Pg.	Code
<b>7</b>			
700007	3/8" Driver Impact Driver, 135mmL	D-38	2915
700008	1/2" Driver Impact Driver, 138mmL	D-38	2915
700106	1/4" Dr. Impact Universal Joint	A-3	755
700107	3/8" Dr. Impact Universal Joint	A-7	755
700108	1/2" Dr. Impact Universal Joint	A-18	915
7107	1/4" Hex Shank, T-7 Tamperproof Star Screwdriver Bit, 30mmLD-12	85	
7108	1/4" Hex Shank, T-8 Tamperproof Star Screwdriver Bit, 30mmLD-12	85	
710810	1/4x5/16" Double Ended Offset Ring Wrench (Matt Finish)	F-7	820
7109	1/4" Hex Shank, T-9 Tamperproof Star Screwdriver Bit, 30mmLD-12	85	
7110	1/4" Hex Shank, T-10 Tamperproof Star Screwdriver Bit, 30mmL	D-12	85
711214	3/8x7/16" Double Ended Offset Ring Wrench (Matt Finish)	F-7	1020
7115	1/4" Hex Shank, T-15 Tamperproof Star Screwdriver Bit, 30mmL	D-12	85
711618	1/2x9/16" Double Ended Offset Ring Wrench (Matt Finish)	F-7	1070
7120	1/4" Hex Shank, T-20 Tamperproof Star Screwdriver Bit, 30mmL	D-12	85
712022	5/8x11/16" Double Ended Offset Ring Wrench (Matt Finish)	F-7	1420
712426	3/4x13/16" Double Ended Offset Ring Wrench (Matt Finish)	F-7	1750
7125	1/4" Hex Shank, T-25 Tamperproof Star Screwdriver Bit, 30mmL	D-12	85
7127	1/4" Hex Shank, T-27 Tamperproof Star Screwdriver Bit, 30mmL	D-12	85
712830	7/8x15/16" Double Ended Offset Ring Wrench (Matt Finish)	F-7	2140
7130	1/4" Hex Shank, T-30 Tamperproof Star Screwdriver Bit, 30mmL	D-12	85
713234	1x1-1/16" Double Ended Offset Ring Wrench (Matt Finish)	F-7	2800
713640	1-1/8x1-1/4" Double Ended Offset Ring Wrench (Matt Finish)	F-7	3110
7140	1/4" Hex Shank, T-40 Tamperproof Star Screwdriver Bit, 30mmL	D-12	85
7145	5/16" Hex Shank, T-45 Tamperproof Star Screwdriver Bit, 30mmL	D-12	125
7150	5/16" Hex Shank, T-50 Tamperproof Star Screwdriver Bit, 30mmL	D-12	125
7155	10mm Hex Shank, T-55 Tamperproof Star Screwdriver Bit, 30mmL	D-12	180
7160	12mm Hex Shank, T-60 Tamperproof Star Screwdriver Bit, 36mmL	D-12	290
7170	14mm Hex Shank, T-70 Tamperproof Star Screwdriver Bit, 36mmL	D-12	350
720607	6x7mm Double Ended Offset Ring Wrench (Matt Finish)	F-7	820
720809	8x9mm Double Ended Offset Ring Wrench (Matt Finish)	F-7	860
721011	10x11mm Double Ended Offset Ring Wrench (Matt Finish)	F-7	1020
721213	12x13mm Double Ended Offset Ring Wrench (Matt Finish)	F-7	1070
721415	14x15mm Double Ended Offset Ring Wrench (Matt Finish)	F-7	1210
721617	16x17mm Double Ended Offset Ring Wrench (Matt Finish)	F-7	1420
721819	18x19mm Double Ended Offset Ring Wrench (Matt Finish)	F-7	1620
722022	20x22mm Double Ended Offset Ring Wrench (Matt Finish)	F-7	1750
722123	21x23mm Double Ended Offset Ring Wrench (Matt Finish)	F-7	2140
722426	24x26mm Double Ended Offset Ring Wrench (Matt Finish)	F-7	2370
722528	25x28mm Double Ended Offset Ring Wrench (Matt Finish)	F-7	2800
722729	27x29mm Double Ended Offset Ring Wrench (Matt Finish)	F-7	2970
723032	30x32mm Double Ended Offset Ring Wrench (Matt Finish)	F-7	3110
726006	6mm Combination Wrench - Matt Finish	F-2	300
726007	7mm Combination Wrench - Matt Finish	F-2	325
726008	8mm Combination Wrench - Matt Finish	F-2	325
726009	9mm Combination Wrench - Matt Finish	F-2	375
726010	10mm Combination Wrench - Matt Finish	F-2	375
726011	11mm Combination Wrench - Matt Finish	F-2	415
726012	12mm Combination Wrench - Matt Finish	F-2	475
726013	13mm Combination Wrench - Matt Finish	F-2	475
726014	14mm Combination Wrench - Matt Finish	F-2	550
726015	15mm Combination Wrench - Matt Finish	F-2	650
726016	16mm Combination Wrench - Matt Finish	F-2	650
726017	17mm Combination Wrench - Matt Finish	F-2	740
726018	18mm Combination Wrench - Matt Finish	F-2	740
726019	19mm Combination Wrench - Matt Finish	F-2	850
726020	20mm Combination Wrench - Matt Finish	F-2	975
726021	21mm Combination Wrench - Matt Finish	F-2	975
726022	22mm Combination Wrench - Matt Finish	F-2	1125
726023	23mm Combination Wrench - Matt Finish	F-2	1250
726024	24mm Combination Wrench - Matt Finish	F-2	1400
726025	25mm Combination Wrench - Matt Finish	F-2	1600
726026	26mm Combination Wrench - Matt Finish	F-2	1600
726027	27mm Combination Wrench - Matt Finish	F-2	1900
726030	30mm Combination Wrench - Matt Finish	F-2	2300
726032	32mm Combination Wrench - Matt Finish	F-2	2470
726033	33mm Combination Wrench - Matt Finish	F-2	3430
726034	34mm Combination Wrench - Matt Finish	F-2	3430
726035	35mm Combination Wrench - Matt Finish	F-2	3490
726036	36mm Combination Wrench - Matt Finish	F-2	4460

Item No.	Description	Pg.	Code	Item No.	Description	Pg.	Code
726038	38mm Combination Wrench - Matt Finish	F-2	4460	742426	24x26mm Double Ended Offset Ring Wrench (Mirror Finish)	F-7	2780
726040	40mm Combination Wrench - Matt Finish	F-2	5660	742528	25x28mm Double Ended Offset Ring Wrench (Mirror Finish)	F-7	3000
726041	41mm Combination Wrench - Matt Finish	F-2	5660	742729	27x29mm Double Ended Offset Ring Wrench (Mirror Finish)	F-7	3660
726042	42mm Combination Wrench - Matt Finish	F-2	5660	743032	30x32mm Double Ended Offset Ring Wrench (Mirror Finish)	F-7	4030
726045	45mm Combination Wrench - Matt Finish	F-2	6400	748206	6mm Combination Wrench (Mirror Finish)	F-5	370
726046	46mm Combination Wrench - Matt Finish	F-2	6400	748207	7mm Combination Wrench (Mirror Finish)	F-5	390
726050	50mm Combination Wrench - Matt Finish	F-2	7380	748208	8mm Combination Wrench (Mirror Finish)	F-5	410
726055	55mm Combination Wrench - Matt Finish	F-2	17570	748209	9mm Combination Wrench (Mirror Finish)	F-5	460
726060	60mm Combination Wrench - Matt Finish	F-2	23090	748210	10mm Combination Wrench (Mirror Finish)	F-5	460
726065	65mm Combination Wrench - Matt Finish	F-2	23090	748211	11mm Combination Wrench (Mirror Finish)	F-5	500
7307	1/4" Hex Shank, T-7 Tamperproof Star Screwdriver Bit, 56mmLD-12		150	748212	12mm Combination Wrench (Mirror Finish)	F-5	550
7308	1/4" Hex Shank, T-8 Tamperproof Star Screwdriver Bit, 56mmLD-12		150	748213	13mm Combination Wrench (Mirror Finish)	F-5	580
7309	1/4" Hex Shank, T-9 Tamperproof Star Screwdriver Bit, 56mmLD-12		150	748214	14mm Combination Wrench (Mirror Finish)	F-5	630
7310	1/4" Hex Shank, T-10 Tamperproof Star Screwdriver Bit, 56mmL	D-12	150	748215	15mm Combination Wrench (Mirror Finish)	F-5	720
7315	1/4" Hex Shank, T-15 Tamperproof Star Screwdriver Bit, 56mmL	D-12	150	748216	16mm Combination Wrench (Mirror Finish)	F-5	720
7320	1/4" Hex Shank, T-20 Tamperproof Star Screwdriver Bit, 56mmL	D-12	150	748217	17mm Combination Wrench (Mirror Finish)	F-5	830
7325	1/4" Hex Shank, T-25 Tamperproof Star Screwdriver Bit, 56mmL	D-12	150	748218	18mm Combination Wrench (Mirror Finish)	F-5	830
7327	1/4" Hex Shank, T-27 Tamperproof Star Screwdriver Bit, 56mmL	D-12	150	748219	19mm Combination Wrench (Mirror Finish)	F-5	970
7330	1/4" Hex Shank, T-30 Tamperproof Star Screwdriver Bit, 56mmL	D-12	150	748220	20mm Combination Wrench (Mirror Finish)	F-5	1080
7340	1/4" Hex Shank, T-40 Tamperproof Star Screwdriver Bit, 56mmL	D-12	150	748221	21mm Combination Wrench (Mirror Finish)	F-5	1180
7345	5/16" Hex Shank, T-45 Tamperproof Star Screwdriver Bit, 56mmL	D-12	190	748222	22mm Combination Wrench (Mirror Finish)	F-5	1360
7350	5/16" Hex Shank, T-50 Tamperproof Star Screwdriver Bit, 56mmL	D-12	190	748223	23mm Combination Wrench (Mirror Finish)	F-5	1430
7355	10mm Hex Shank, T-55 Tamperproof Star Screwdriver Bit, 56mmL	D-12	250	748224	24mm Combination Wrench (Mirror Finish)	F-5	1540
7360	12mm Hex Shank, T-60 Tamperproof Star Screwdriver Bit, 56mmL	D-12	310	748225	25mm Combination Wrench (Mirror Finish)	F-5	1740
7370	14mm Hex Shank, T-70 Tamperproof Star Screwdriver Bit, 56mmL	D-12	370	748226	26mm Combination Wrench (Mirror Finish)	F-5	1740
737008	1/4" Combination Wrench (Matt Finish)	F-3	300	748227	27mm Combination Wrench (Mirror Finish)	F-5	2050
737010	5/16" Combination Wrench (Matt Finish)	F-3	325	748228	28mm Combination Wrench (Mirror Finish)	F-5	2050
737012	3/8" Combination Wrench (Matt Finish)	F-3	375	748229	29mm Combination Wrench (Mirror Finish)	F-5	2500
737014	7/16" Combination Wrench (Matt Finish)	F-3	415	748230	30mm Combination Wrench (Mirror Finish)	F-5	2500
737016	1/2" Combination Wrench (Matt Finish)	F-3	475	748232	32mm Combination Wrench (Mirror Finish)	F-5	2700
737018	9/16" Combination Wrench (Matt Finish)	F-3	550	7507	1/4" Hex Shank, T-7 Tamperproof Star Screwdriver Bit, 88mmLD-12		300
737020	5/8" Combination Wrench (Matt Finish)	F-3	650	7508	1/4" Hex Shank, T-8 Tamperproof Star Screwdriver Bit, 88mmLD-12		300
737022	11/16" Combination Wrench (Matt Finish)	F-3	740	750810	1/4x5/16" Double Ended Offset Ring Wrench (Mirror Finish)	F-7	980
737024	3/4" Combination Wrench (Matt Finish)	F-3	850	7509	1/4" Hex Shank, T-9 Tamperproof Star Screwdriver Bit, 88mmLD-12		300
737026	13/16" Combination Wrench (Matt Finish)	F-3	975	7510	1/4" Hex Shank, T-10 Tamperproof Star Screwdriver Bit, 88mmL	D-12	300
737028	7/8" Combination Wrench (Matt Finish)	F-3	1125	751214	3/8x7/16" Double Ended Offset Ring Wrench (Mirror Finish)	F-7	1150
737030	15/16" Combination Wrench (Matt Finish)	F-3	1400	7515	1/4" Hex Shank, T-15 Tamperproof Star Screwdriver Bit, 88mmL	D-12	300
737032	1" Combination Wrench (Matt Finish)	F-3	1600	751618	1/2x9/16" Double Ended Offset Ring Wrench (Mirror Finish)	F-7	1450
737034	1-1/16" Combination Wrench (Matt Finish)	F-3	1900	7520	1/4" Hex Shank, T-20 Tamperproof Star Screwdriver Bit, 88mmL	D-12	300
737036	1-1/8" Combination Wrench (Matt Finish)	F-3	2100	752022	5/8x11/16" Double Ended Offset Ring Wrench (Mirror Finish)	F-7	1700
737040	1-1/4" Combination Wrench (Matt Finish)	F-3	2470	752426	3/4x13/16" Double Ended Offset Ring Wrench (Mirror Finish)	F-7	2250
737042	1-5/16" Combination Wrench (Matt Finish)	F-3	3430	7525	1/4" Hex Shank, T-25 Tamperproof Star Screwdriver Bit, 88mmL	D-12	300
737044	1-3/8" Combination Wrench (Matt Finish)	F-3	3490	7527	1/4" Hex Shank, T-27 Tamperproof Star Screwdriver Bit, 88mmL	D-12	300
737046	1-7/16" Combination Wrench (Matt Finish)	F-3	4460	752830	7/8x15/16" Double Ended Offset Ring Wrench (Mirror Finish)	F-7	2450
737048	1-1/2" Combination Wrench (Matt Finish)	F-3	4460	7530	1/4" Hex Shank, T-30 Tamperproof Star Screwdriver Bit, 88mmL	D-12	300
737052	1-5/8" Combination Wrench (Matt Finish)	F-3	5660	753234	1x1-1/16" Double Ended Offset Ring Wrench (Mirror Finish)	F-7	3000
737054	1-11/16" Combination Wrench (Matt Finish)	F-3	5660	753640	1-1/8x1-1/4" Double Ended Offset Ring Wrench (Mirror Finish)	F-7	4050
737056	1-3/4" Combination Wrench (Matt Finish)	F-3	6400	7540	1/4" Hex Shank, T-40 Tamperproof Star Screwdriver Bit, 88mmL	D-12	300
737058	1-13/16" Combination Wrench (Matt Finish)	F-3	6400	7545	5/16" Hex Shank, T-45 Tamperproof Star Screwdriver Bit, 88mmL	D-12	340
737060	1-7/8" Combination Wrench (Matt Finish)	F-3	7380	7550	5/16" Hex Shank, T-50 Tamperproof Star Screwdriver Bit, 88mmL	D-12	340
737064	2" Combination Wrench (Matt Finish)	F-3	7380	7555	10mm Hex Shank, T-55 Tamperproof Star Screwdriver Bit, 88mmL	D-12	440
737068	2-1/8" Combination Wrench (Matt Finish)	F-3	17570	7560	12mm Hex Shank, T-60 Tamperproof Star Screwdriver Bit, 88mmL	D-12	580
737072	2-1/4" Combination Wrench (Matt Finish)	F-3	17570	7570	14mm Hex Shank, T-70 Tamperproof Star Screwdriver Bit, 88mmL	D-12	720
737076	2-3/8" Combination Wrench (Matt Finish)	F-3	23090	759208	1/4" Combination Wrench (Mirror Finish)	F-5	370
737080	2-1/2" Combination Wrench (Matt Finish)	F-3	23090	759210	5/16" Combination Wrench (Mirror Finish)	F-5	410
740607	6x7mm Double Ended Offset Ring Wrench (Mirror Finish)	F-7	1000	759212	3/8" Combination Wrench (Mirror Finish)	F-5	460
740809	8x9mm Double Ended Offset Ring Wrench (Mirror Finish)	F-7	1070	759214	7/16" Combination Wrench (Mirror Finish)	F-5	500
740911	9 x 11mm Flare Nut Wrench	F-10	1090	759216	1/2" Combination Wrench (Mirror Finish)	F-5	580
741011	10x11mm Double Ended Offset Ring Wrench (Mirror Finish)	F-7	1150	759218	9/16" Combination Wrench (Mirror Finish)	F-5	630
741012	10 x 12mm Flare Nut Wrench	F-10	1120	759220	5/8" Combination Wrench (Mirror Finish)	F-5	720
741213	12x13mm Double Ended Offset Ring Wrench (Mirror Finish)	F-7	1280	759222	11/16" Combination Wrench (Mirror Finish)	F-5	830
741314	13 x 14mm Flare Nut Wrench	F-10	1180	759224	3/4" Combination Wrench (Mirror Finish)	F-5	970
741415	14x15mm Double Ended Offset Ring Wrench (Mirror Finish)	F-7	1400	759226	13/16" Combination Wrench (Mirror Finish)	F-5	1180
741517	15 x 17mm Flare Nut Wrench	F-10	1350	759228	7/8" Combination Wrench (Mirror Finish)	F-5	1360
741617	16x17mm Double Ended Offset Ring Wrench (Mirror Finish)	F-7	1850	759230	15/16" Combination Wrench (Mirror Finish)	F-5	1540
741618	16 x 18mm Flare Nut Wrench	F-10	1490	759232	1" Combination Wrench (Mirror Finish)	F-5	1740
741819	18x19mm Double Ended Offset Ring Wrench (Mirror Finish)	F-7	2200	759234	1-1/16" Combination Wrench (Mirror Finish)	F-5	2050
741921	19 x 21mm Flare Nut Wrench	F-10	1780	759236	1-1/8" Combination Wrench (Mirror Finish)	F-5	2500
742022	20x22mm Double Ended Offset Ring Wrench (Mirror Finish)	F-7	2330	759240	1-1/4" Combination Wrench (Mirror Finish)	F-5	2700
742123	21x23mm Double Ended Offset Ring Wrench (Mirror Finish)	F-7	2370	760210	10mm Stubby Combination Ratcheting Wrench	F-13	1110

Item No.	Description	Pg.	Code
760211	11mm Stubby Combination Ratcheting Wrench	F-13	1140
760212	12mm Stubby Combination Ratcheting Wrench	F-13	1190
760213	13mm Stubby Combination Ratcheting Wrench	F-13	1220
760214	14mm Stubby Combination Ratcheting Wrench	F-13	1300
760215	15mm Stubby Combination Ratcheting Wrench	F-13	1350
760216	16mm Stubby Combination Ratcheting Wrench	F-13	1410
760217	17mm Stubby Combination Ratcheting Wrench	F-13	1480
760218	18mm Stubby Combination Ratcheting Wrench	F-13	1600
760219	19mm Stubby Combination Ratcheting Wrench	F-13	1680
7607	1/4" Hex Shank, T-7 Tamperproof Star Screwdriver Bit, 125mmL	D-12	350
7608	1/4" Hex Shank, T-8 Tamperproof Star Screwdriver Bit, 125mmL	D-12	350
760810	1/4 x 5/16" Flare Nut Wrench	F-10	1090
7609	1/4" Hex Shank, T-9 Tamperproof Star Screwdriver Bit, 125mmL	D-12	350
7610	1/4" Hex Shank, T-10 Tamperproof Star Screwdriver Bit, 125mmL	D-12	350
761214	3/8 x 7/16" Flare Nut Wrench	F-10	1120
7615	1/4" Hex Shank, T-15 Tamperproof Star Screwdriver Bit, 125mmL	D-12	350
761618	1/2 x 9/16" Flare Nut Wrench	F-10	1300
7620	1/4" Hex Shank, T-20 Tamperproof Star Screwdriver Bit, 125mmL	D-12	350
762022	5/8 x 11/16" Flare Nut Wrench	F-10	1490
762428	3/4 x 7/8" Flare Nut Wrench	F-10	1780
7625	1/4" Hex Shank, T-25 Tamperproof Star Screwdriver Bit, 125mmL	D-12	350
7627	1/4" Hex Shank, T-27 Tamperproof Star Screwdriver Bit, 125mmL	D-12	350
7630	1/4" Hex Shank, T-30 Tamperproof Star Screwdriver Bit, 125mmL	D-12	350
7640	1/4" Hex Shank, T-40 Tamperproof Star Screwdriver Bit, 125mmL	D-12	350
7645	5/16" Hex Shank, T-45 Tamperproof Star Screwdriver Bit, 125mmL	D-12	450
7650	5/16" Hex Shank, T-50 Tamperproof Star Screwdriver Bit, 125mmL	D-12	450
7655	10mm Hex Shank, T-55 Tamperproof Star Screwdriver Bit, 125mmL	D-12	650
7660	12mm Hex Shank, T-60 Tamperproof Star Screwdriver Bit, 125mmL	D-12	800
7670	14mm Hex Shank, T-70 Tamperproof Star Screwdriver Bit, 125mmL	D-12	950
768508	8mm Combination Ratcheting Wrench	F-11	1150
768510	10mm Combination Ratcheting Wrench	F-11	1220
768511	11mm Combination Ratcheting Wrench	F-11	1270
768512	12mm Combination Ratcheting Wrench	F-11	1340
768513	13mm Combination Ratcheting Wrench	F-11	1390
768514	14mm Combination Ratcheting Wrench	F-11	1480
768515	15mm Combination Ratcheting Wrench	F-11	1570
768516	16mm Combination Ratcheting Wrench	F-11	1650
768517	17mm Combination Ratcheting Wrench	F-11	1770
768518	18mm Combination Ratcheting Wrench	F-11	1800
768519	19mm Combination Ratcheting Wrench	F-11	1890
768521	21mm Combination Ratcheting Wrench	F-11	2850
768522	22mm Combination Ratcheting Wrench	F-11	2850
768523	23mm Combination Ratcheting Wrench	F-11	2900
768524	24mm Combination Ratcheting Wrench	F-11	3400
768525	25mm Combination Ratcheting Wrench	F-11	3500
768526	26mm Combination Ratcheting Wrench	F-11	3600
768527	27mm Combination Ratcheting Wrench	F-11	4700
768528	28mm Combination Ratcheting Wrench	F-11	4900
768530	30mm Combination Ratcheting Wrench	F-11	6000
768532	32mm Combination Ratcheting Wrench	F-11	6000
770212	3/8" Stubby Combination Ratcheting Wrench	F-13	1110
770214	7/16" Stubby Combination Ratcheting Wrench	F-13	1140
770216	1/2" Stubby Combination Ratcheting Wrench	F-13	1220
770218	9/16" Stubby Combination Ratcheting Wrench	F-13	1300
770220	5/8" Stubby Combination Ratcheting Wrench	F-13	1410
770222	11/16" Stubby Combination Ratcheting Wrench	F-13	1480
770224	3/4" Stubby Combination Ratcheting Wrench	F-13	1680
7707	1/4" Hex Shank, T-7 Tamperproof Star Screwdriver Bit, 160mmL	D-13	430
7708	1/4" Hex Shank, T-8 Tamperproof Star Screwdriver Bit, 160mmL	D-13	430
770810	1/4 x 5/16" Open End Wrench	F-17	340
7709	1/4" Hex Shank, T-9 Tamperproof Star Screwdriver Bit, 160mmL	D-13	430
7710	1/4" Hex Shank, T-10 Tamperproof Star Screwdriver Bit, 160mmL	D-13	430
771214	3/8 x 7/16" Open End Wrench	F-17	400
7715	1/4" Hex Shank, T-15 Tamperproof Star Screwdriver Bit, 160mmL	D-13	430
771618	1/2 x 9/16" Open End Wrench	F-17	560
7720	1/4" Hex Shank, T-20 Tamperproof Star Screwdriver Bit, 160mmL	D-13	430
772022	5/8 x 11/16" Open End Wrench	F-17	680
772428	3/4 x 7/8" Open End Wrench	F-17	920
7725	1/4" Hex Shank, T-25 Tamperproof Star Screwdriver Bit, 160mmL	D-13	430
772628	13/16 x 7/8" Open End Wrench	F-17	1040

Item No.	Description	Pg.	Code
7727	1/4" Hex Shank, T-27 Tamperproof Star Screwdriver Bit, 160mmL	D-13	430
7730	1/4" Hex Shank, T-30 Tamperproof Star Screwdriver Bit, 160mmL	D-13	430
773032	15/16 x 1" Open End Wrench	F-17	1240
773236	1" x 1-1/8" Open End Wrench	F-17	1480
773440	1-1/16 x 1-1/4" Open End Wrench	F-17	1640
7740	1/4" Hex Shank, T-40 Tamperproof Star Screwdriver Bit, 160mmL	D-13	430
7745	5/16" Hex Shank, T-45 Tamperproof Star Screwdriver Bit, 160mmL	D-13	560
7750	5/16" Hex Shank, T-50 Tamperproof Star Screwdriver Bit, 160mmL	D-13	560
7755	10mm Hex Shank, T-55 Tamperproof Star Screwdriver Bit, 160mmL	D-13	760
7760	12mm Hex Shank, T-60 Tamperproof Star Screwdriver Bit, 160mmL	D-13	930
7770	14mm Hex Shank, T-70 Tamperproof Star Screwdriver Bit, 160mmL	D-13	1130
778510	5/16" Combination Ratcheting Wrench	F-11	1150
778512	3/8" Combination Ratcheting Wrench	F-11	1220
778514	7/16" Combination Ratcheting Wrench	F-11	1270
778516	1/2" Combination Ratcheting Wrench	F-11	1390
778518	9/16" Combination Ratcheting Wrench	F-11	1480
778520	5/8" Combination Ratcheting Wrench	F-11	1650
778522	11/16" Combination Ratcheting Wrench	F-11	1770
778524	3/4" Combination Ratcheting Wrench	F-11	1890
778526	13/16" Combination Ratcheting Wrench	F-11	2850
778528	7/8" Combination Ratcheting Wrench	F-11	2850
778530	15/16" Combination Ratcheting Wrench	F-11	3400
778532	1" Combination Ratcheting Wrench	F-11	3500
778534	1-1/16" Combination Ratcheting Wrench	F-11	4700
778536	1-1/8" Combination Ratcheting Wrench	F-11	6000
778540	1-1/4" Combination Ratcheting Wrench	F-11	6000
780128	13mm Adjustable Wrench, 100mmL	F-34	1870
780192	19mm Adjustable Wrench, 150mmL	F-34	1870
780256	24mm Adjustable Wrench, 200mmL	F-34	2120
780320	28mm Adjustable Wrench, 250mmL	F-34	2690
780384	33mm Adjustable Wrench, 300mmL	F-34	3500
780480	42mm Adjustable Wrench, 380mmL	F-34	6750
780576	52mm Adjustable Wrench, 450mmL	F-34	12000
780692	62mm Adjustable Wrench, 600mmL	F-34	25000
7807	1/4" Hex Shank, T-7 Tamperproof Star Screwdriver Bit, 200mmL	D-13	510
7808	1/4" Hex Shank, T-8 Tamperproof Star Screwdriver Bit, 200mmL	D-13	510
780810L	8 x 10mm Extra Long Box End Wrench, 235mmL	F-14	1900
7809	1/4" Hex Shank, T-9 Tamperproof Star Screwdriver Bit, 200mmL	D-13	510
7810	1/4" Hex Shank, T-10 Tamperproof Star Screwdriver Bit, 200mmL	D-13	510
781012L	10 x 12mm Extra Long Box End Wrench, 292mmL	F-14	2100
781214L	12 x 14mm Extra Long Box End Wrench, 330mmL	F-14	2400
781315L	13 x 15mm Extra Long Box End Wrench, 330mmL	F-14	2600
781417L	14 x 17mm Extra Long Box End Wrench, 369mmL	F-14	2900
7815	1/4" Hex Shank, T-15 Tamperproof Star Screwdriver Bit, 200mmL	D-13	510
781618L	16 x 18mm Extra Long Box End Wrench, 407mmL	F-14	3500
781719L	17 x 19mm Extra Long Box End Wrench, 407mmL	F-14	3500
7820	1/4" Hex Shank, T-20 Tamperproof Star Screwdriver Bit, 200mmL	D-13	510
782200	Heavy Duty Pipe Wrench, 200mmL(8")	F-34	2850
782224L	22 x 24mm Extra Long Box End Wrench, 435mmL	F-14	4300
782250	Heavy Duty Pipe Wrench, 250mmL(10")	F-34	3700
782300	Heavy Duty Pipe Wrench, 300mmL(12")	F-34	4360
782350	Heavy Duty Pipe Wrench, 350mmL(14")	F-34	5250
782460	Heavy Duty Pipe Wrench, 460mmL(18")	F-34	7400
7825	1/4" Hex Shank, T-25 Tamperproof Star Screwdriver Bit, 200mmL	D-13	510
782610	Heavy Duty Pipe Wrench, 610mmL(24")	F-34	11300
7827	1/4" Hex Shank, T-27 Tamperproof Star Screwdriver Bit, 200mmL	D-13	510
782910	Heavy Duty Pipe Wrench, 910mmL(36")	F-34	21600
7830	1/4" Hex Shank, T-30 Tamperproof Star Screwdriver Bit, 200mmL	D-13	510
783220	Heavy Duty Pipe Wrench, 1220mmL(48")	F-34	39300
7840	1/4" Hex Shank, T-40 Tamperproof Star Screwdriver Bit, 200mmL	D-13	510
784350	Aluminum Pipe Wrench, 350mmL(14")	F-34	5950
784460	Aluminum Pipe Wrench, 460mmL(18")	F-34	8500
7845	5/16" Hex Shank, T-45 Tamperproof Star Screwdriver Bit, 200mmL	D-13	660
784610	Aluminum Pipe Wrench, 610mmL(24")	F-34	12700
784910	Aluminum Pipe Wrench, 910mmL(36")	F-34	23800
7850	5/16" Hex Shank, T-50 Tamperproof Star Screwdriver Bit, 200mmL	D-13	660
785220	Aluminum Pipe Wrench, 1220mmL(48")	F-34	41700
7855	10mm Hex Shank, T-55 Tamperproof Star Screwdriver Bit, 200mmL	D-13	860
7860	12mm Hex Shank, T-60 Tamperproof Star Screwdriver Bit, 200mmL	D-13	1060
7870	14mm Hex Shank, T-70 Tamperproof Star Screwdriver Bit, 200mmL	D-13	1260

Item No.	Description	Pg.	Code
790607	6 x 7mm Open End Wrench	F-17	340
790608	E-6 x E-8 E-Star Wrench	F-16	500
790809	8 x 9mm Open End Wrench	F-17	360
791011	10 x 12mm Open End Wrench	F-17	400
791012	E-10 x E-12 E-Star Wrench	F-16	620
791012L	5/16 x 3/8" Extra Long Box End Wrench, 235mmL	F-14	1900
791213	12 x 13mm Open End Wrench	F-17	480
791415	14 x 15mm Open End Wrench	F-17	580
791416L	7/16 x 1/2" Extra Long Box End Wrench, 292mmL	F-14	2100
791418	E-14 x E-18 E-Star Wrench	F-16	790
791617	16 x 17mm Open End Wrench	F-17	680
791819	18 x 19mm Open End Wrench	F-17	740
791820L	9/16 x 5/8" Extra Long Box End Wrench, 369mmL	F-14	2900
792022	20 x 22mm Open End Wrench	F-17	920
792024	E-20 x E-24 E-Star Wrench	F-16	1200
792123	21 x 23mm Open End Wrench	F-17	1040
792224L	11/16 x 3/4" Extra Long Box End Wrench, 407mmL	F-14	3500
792426	24 x 26mm Open End Wrench	F-17	1240
792528	25 x 28mm Open End Wrench	F-17	1480
792730	27 x 30mm Open End Wrench	F-17	1640
793032	30 x 32mm Open End Wrench	F-17	1640
7940	1/4" Hex Shank, T-40 Tamperproof Star Screwdriver Bit, 225mmL	D-13	590
7945	5/16" Hex Shank, T-45 Tamperproof Star Screwdriver Bit, 225mmL	D-13	760
<b>8</b>			
801200	1" Dr. Air Impact Wrench, 1,200 ft. lbs. / 1,627 Nm	E-13	70000
801206	1" Dr. Long Anvil Air Impact Wrench, 1,200 ft. lbs. / 1,627 Nm	E-13	76500
801500	1" Dr. Air Impact Wrench, 1,500 ft. lbs. / 2,033 Nm	E-14	112000
801506	1" Dr. Long Anvil Air Impact Wrench, 1,500 ft. lbs. / 2,033 Nm	E-14	119000
801512	1" Dr. Air Impact Wrench, 1,500 ft. lbs. / 2,033 Nm	E-14	79440
801518	1" Dr. Long Anvil Air Impact Wrench, 1,500 ft. lbs. / 2,033 Nm	E-14	88440
801800	1" Dr. Air Impact Wrench, 1,800 ft. lbs. / 2,439 Nm	E-15	141000
801806	1" Dr. Long Anvil Air Impact Wrench, 1,800 ft. lbs. / 2,439 Nm	E-15	153000
802000	1" Dr. Air Impact Wrench, 2,000 ft. lbs. / 2,712 Nm	E-15	130000
802006	1" Dr. Long Anvil Air Impact Wrench, 2,000 ft. lbs. / 2,712 Nm	E-15	138000
8104	1/4" Hex Shank, M4 Triple Square Screwdriver Bit, 30mmL	D-14	60
8105	1/4" Hex Shank, M5 Triple Square Screwdriver Bit, 30mmL	D-14	60
8106	1/4" Hex Shank, M6 Triple Square Screwdriver Bit, 30mmL	D-14	60
8108	5/16" Hex Shank, M8 Triple Square Screwdriver Bit, 30mmL	D-14	95
8110	10mm Hex Shank, M10 Triple Square Screwdriver Bit, 30mmL	D-14	150
8112	12mm Hex Shank, M12 Triple Square Screwdriver Bit, 30mmL	D-14	195
8114	14mm Hex Shank, M14 Triple Square Screwdriver Bit, 30mmL	D-14	240
8116	16mm Hex Shank, M16 Triple Square Screwdriver Bit, 36mmL	D-14	350
8118	19mm Hex Shank, M18 Triple Square Screwdriver Bit, 36mmL	D-14	450
819+	1" Dr. 19mm Hex Shank Impact Bit Holder, 60mmL	D-20	2000
819+2916	1" Dr. 16mm Hex Bit Socket, 85mmL	C-14	2700
819+2917	1" Dr. 17mm Hex Bit Socket, 85mmL	C-14	2700
819+2918	1" Dr. 18mm Hex Bit Socket, 85mmL	C-14	2700
819+2919	1" Dr. 19mm Hex Bit Socket, 85mmL	C-14	2700
819+3940	1" Dr. 5/8" Hex Bit Socket, 85mmL	C-14	2700
819+3948	1" Dr. 3/4" Hex Bit Socket, 85mmL	C-14	2700
820150	1" Dr. Extension Bar, 150mmL (CR-Mo)	B-94	2890
820200	1" Dr. Extension Bar, 200mmL (CR-Mo)	B-94	3150
820250	1" Dr. Extension Bar, 250mmL (CR-Mo)	B-94	4465
820400	1" Dr. Extension Bar, 400mmL (CR-Mo)	B-94	7100
821006	1" Dr. Adapter, 1"F x 3/4"M (CR-Mo)	B-94	1925
821012	1" Dr. Adapter, 1"F x 1-1/2"M (CR-Mo)	B-94	1840
822+	1" Dr. 22mm Hex Shank Impact Bit Holder, 60mmL	D-20	2000
822+2922	1" Dr. 22mm Hex Bit Socket, 90mmL	C-14	2800
822+2924	1" Dr. 24mm Hex Bit Socket, 90mmL	C-14	2950
822+3952	1" Dr. 13/16" Hex Bit Socket, 90mmL	C-14	2800
822+3956	1" Dr. 7/8" Hex Bit Socket, 90mmL	C-14	2800
822+3960	1" Dr. 15/16" Hex Bit Socket, 90mmL	C-14	2950
822+3964	1" Dr. 1" Hex Bit Socket, 90mmL	C-14	2950

Item No.	Description	Pg.	Code
824M350	1" Dr. 24mm(5/16") Torque Socket, 350 ft.lbs.(475Nm)	J-11	10800
826S475	1" Dr. 1-3/16" Square Torque Socket, 475 ft.lbs.(644Nm)	J-11	10800
827+	1" Dr. 27mm Hex Shank Impact Bit Holder, 65mmL	D-20	2000
827+2927	1" Dr. 27mm Hex Bit Socket, 95mmL	C-14	3100
827+2930	1" Dr. 30mm Hex Bit Socket, 95mmL	C-14	3300
827+2932	1" Dr. 32mm Hex Bit Socket, 95mmL	C-14	3500
827+3968	1" Dr. 1-1/16" Hex Bit Socket, 95mmL	C-14	3100
827+3972	1" Dr. 1-1/8" Hex Bit Socket, 95mmL	C-14	3300
827+3976	1" Dr. 1-3/16" Hex Bit Socket, 95mmL	C-14	3400
827+3980	1" Dr. 1-1/4" Hex Bit Socket, 95mmL	C-14	3500
827017	1" Dr. 17mm Hand Socket (CR-Mo)	B-89	1420
827018	1" Dr. 18mm Hand Socket (CR-Mo)	B-89	1420
827019	1" Dr. 19mm Hand Socket (CR-Mo)	B-89	1420
827020	1" Dr. 20mm Hand Socket (CR-Mo)	B-89	1420
827021	1" Dr. 21mm Hand Socket (CR-Mo)	B-89	1420
827022	1" Dr. 22mm Hand Socket (CR-Mo)	B-89	1420
827023	1" Dr. 23mm Hand Socket (CR-Mo)	B-89	1420
827024	1" Dr. 24mm Hand Socket (CR-Mo)	B-89	1420
827025	1" Dr. 25mm Hand Socket (CR-Mo)	B-89	1420
827026	1" Dr. 26mm Hand Socket (CR-Mo)	B-89	1420
827027	1" Dr. 27mm Hand Socket (CR-Mo)	B-89	1420
827028	1" Dr. 28mm Hand Socket (CR-Mo)	B-89	1420
827029	1" Dr. 29mm Hand Socket (CR-Mo)	B-89	1420
827030	1" Dr. 30mm Hand Socket (CR-Mo)	B-89	1420
827031	1" Dr. 31mm Hand Socket (CR-Mo)	B-89	1525
827032	1" Dr. 32mm Hand Socket (CR-Mo)	B-89	1525
827033	1" Dr. 33mm Hand Socket (CR-Mo)	B-89	1575
827034	1" Dr. 34mm Hand Socket (CR-Mo)	B-89	1630
827035	1" Dr. 35mm Hand Socket (CR-Mo)	B-89	1680
827036	1" Dr. 36mm Hand Socket (CR-Mo)	B-89	1680
827037	1" Dr. 37mm Hand Socket (CR-Mo)	B-89	1785
827038	1" Dr. 38mm Hand Socket (CR-Mo)	B-89	1785
827039	1" Dr. 39mm Hand Socket (CR-Mo)	B-89	2100
827040	1" Dr. 40mm Hand Socket (CR-Mo)	B-89	2100
827041	1" Dr. 41mm Hand Socket (CR-Mo)	B-89	2100
827042	1" Dr. 42mm Hand Socket (CR-Mo)	B-89	2365
827043	1" Dr. 43mm Hand Socket (CR-Mo)	B-89	2365
827044	1" Dr. 44mm Hand Socket (CR-Mo)	B-89	2365
827045	1" Dr. 45mm Hand Socket (CR-Mo)	B-89	2365
827046	1" Dr. 46mm Hand Socket (CR-Mo)	B-89	2365
827047	1" Dr. 47mm Hand Socket (CR-Mo)	B-89	2625
827048	1" Dr. 48mm Hand Socket (CR-Mo)	B-89	2625
827049	1" Dr. 49mm Hand Socket (CR-Mo)	B-89	3150
827050	1" Dr. 50mm Hand Socket (CR-Mo)	B-89	3150
827051	1" Dr. 51mm Hand Socket (CR-Mo)	B-89	3415
827052	1" Dr. 52mm Hand Socket (CR-Mo)	B-89	3415
827053	1" Dr. 53mm Hand Socket (CR-Mo)	B-89	3415
827054	1" Dr. 54mm Hand Socket (CR-Mo)	B-89	3415
827055	1" Dr. 55mm Hand Socket (CR-Mo)	B-89	3570
827056	1" Dr. 56mm Hand Socket (CR-Mo)	B-89	3675
827057	1" Dr. 57mm Hand Socket (CR-Mo)	B-89	3675
827058	1" Dr. 58mm Hand Socket (CR-Mo)	B-89	3675
827059	1" Dr. 59mm Hand Socket (CR-Mo)	B-89	4200
827060	1" Dr. 60mm Hand Socket (CR-Mo)	B-89	4465
827061	1" Dr. 61mm Hand Socket (CR-Mo)	B-89	5250
827062	1" Dr. 62mm Hand Socket (CR-Mo)	B-89	5250
827063	1" Dr. 63mm Hand Socket (CR-Mo)	B-89	5250
827064	1" Dr. 64mm Hand Socket (CR-Mo)	B-89	5775
827065	1" Dr. 65mm Hand Socket (CR-Mo)	B-89	5775
827066	1" Dr. 66mm Hand Socket (CR-Mo)	B-89	7875
827067	1" Dr. 67mm Hand Socket (CR-Mo)	B-89	7875
827068	1" Dr. 68mm Hand Socket (CR-Mo)	B-89	7875
827069	1" Dr. 69mm Hand Socket (CR-Mo)	B-89	7875
827070	1" Dr. 70mm Hand Socket (CR-Mo)	B-89	7875
827071	1" Dr. 71mm Hand Socket (CR-Mo)	B-89	10500
827072	1" Dr. 72mm Hand Socket (CR-Mo)	B-89	10500
827073	1" Dr. 73mm Hand Socket (CR-Mo)	B-89	10500
827074	1" Dr. 74mm Hand Socket (CR-Mo)	B-89	10500
827075	1" Dr. 75mm Hand Socket (CR-Mo)	B-89	10500
827076	1" Dr. 76mm Hand Socket (CR-Mo)	B-90	13125



Item No.	Description	Pg.	Code	Item No.	Description	Pg.	Code
827077	1" Dr. 77mm Hand Socket (CR-Mo)	B-90	13125	837051	1" Dr. 51mm Hand Socket (12-Point) (CR-Mo)	B-92	3415
827078	1" Dr. 78mm Hand Socket (CR-Mo)	B-90	13125	837052	1" Dr. 52mm Hand Socket (12-Point) (CR-Mo)	B-92	3415
827079	1" Dr. 79mm Hand Socket (CR-Mo)	B-90	13125	837053	1" Dr. 53mm Hand Socket (12-Point) (CR-Mo)	B-92	3415
827080	1" Dr. 80mm Hand Socket (CR-Mo)	B-90	13125	837054	1" Dr. 54mm Hand Socket (12-Point) (CR-Mo)	B-92	3415
827082	1" Dr. 82mm Hand Socket (CR-Mo)	B-90	18375	837055	1" Dr. 55mm Hand Socket (12-Point) (CR-Mo)	B-92	3570
827083	1" Dr. 83mm Hand Socket (CR-Mo)	B-90	18375	837056	1" Dr. 56mm Hand Socket (12-Point) (CR-Mo)	B-92	3675
827085	1" Dr. 85mm Hand Socket (CR-Mo)	B-90	18375	837057	1" Dr. 57mm Hand Socket (12-Point) (CR-Mo)	B-92	3675
827090	1" Dr. 90mm Hand Socket (CR-Mo)	B-90	21500	837058	1" Dr. 58mm Hand Socket (12-Point) (CR-Mo)	B-92	3675
827095	1" Dr. 95mm Hand Socket (CR-Mo)	B-90	23600	837059	1" Dr. 59mm Hand Socket (12-Point) (CR-Mo)	B-92	4200
827100	1" Dr. 100mm Hand Socket (CR-Mo)	B-90	28800	837060	1" Dr. 60mm Hand Socket (12-Point) (CR-Mo)	B-92	4465
827105	1" Dr. 105mm Hand Socket (CR-Mo)	B-90	33200	837061	1" Dr. 61mm Hand Socket (12-Point) (CR-Mo)	B-92	5250
827110	1" Dr. 110mm Hand Socket (CR-Mo)	B-90	38300	837062	1" Dr. 62mm Hand Socket (12-Point) (CR-Mo)	B-92	5250
827115	1" Dr. 115mm Hand Socket (CR-Mo)	B-90	44000	837063	1" Dr. 63mm Hand Socket (12-Point) (CR-Mo)	B-92	5250
827M450	1" Dr. 27mm(1-1/16") Torque Socket, 450 ft.lbs.(610Nm)	J-11	10800	837064	1" Dr. 64mm Hand Socket (12-Point) (CR-Mo)	B-92	5775
8304	1/4" Hex Shank, M4 Triple Square Screwdriver Bit, 56mmL	D-14	120	837065	1" Dr. 65mm Hand Socket (12-Point) (CR-Mo)	B-92	5775
8305	1/4" Hex Shank, M5 Triple Square Screwdriver Bit, 56mmL	D-14	120	837066	1" Dr. 66mm Hand Socket (12-Point) (CR-Mo)	B-92	7875
8306	1/4" Hex Shank, M6 Triple Square Screwdriver Bit, 56mmL	D-14	120	837067	1" Dr. 67mm Hand Socket (12-Point) (CR-Mo)	B-92	7875
8308	5/16" Hex Shank, M8 Triple Square Screwdriver Bit, 56mmL	D-14	160	837068	1" Dr. 68mm Hand Socket (12-Point) (CR-Mo)	B-92	7875
830M550	1" Dr. 30mm(1-3/16") Torque Socket, 550 ft.lbs.(745Nm)	J-11	10800	837069	1" Dr. 69mm Hand Socket (12-Point) (CR-Mo)	B-92	7875
8310	10mm Hex Shank, M10 Triple Square Screwdriver Bit, 56mmL	D-14	220	837070	1" Dr. 70mm Hand Socket (12-Point) (CR-Mo)	B-92	7875
8312	12mm Hex Shank, M12 Triple Square Screwdriver Bit, 56mmL	D-14	280	837071	1" Dr. 71mm Hand Socket (12-Point) (CR-Mo)	B-92	10500
8314	14mm Hex Shank, M14 Triple Square Screwdriver Bit, 56mmL	D-14	340	837072	1" Dr. 72mm Hand Socket (12-Point) (CR-Mo)	B-92	10500
8316	16mm Hex Shank, M16 Triple Square Screwdriver Bit, 56mmL	D-14	410	837073	1" Dr. 73mm Hand Socket (12-Point) (CR-Mo)	B-92	10500
8318	19mm Hex Shank, M18 Triple Square Screwdriver Bit, 56mmL	D-14	480	837074	1" Dr. 74mm Hand Socket (12-Point) (CR-Mo)	B-92	10500
832+	1" Dr. 32mm Hex Shank Impact Bit Holder, 65mmL	D-20	2000	837075	1" Dr. 75mm Hand Socket (12-Point) (CR-Mo)	B-92	10500
832+2933	1" Dr. 33mm Hex Bit Socket, 100mmL	C-14	3650	837076	1" Dr. 76mm Hand Socket (12-Point) (CR-Mo)	B-92	13125
832+2936	1" Dr. 36mm Hex Bit Socket, 100mmL	C-14	3800	837077	1" Dr. 77mm Hand Socket (12-Point) (CR-Mo)	B-92	13125
832+3984	1" Dr. 1-5/16" Hex Bit Socket, 100mmL	C-14	3650	837078	1" Dr. 78mm Hand Socket (12-Point) (CR-Mo)	B-92	13125
832+3988	1" Dr. 1-3/8" Hex Bit Socket, 100mmL	C-14	3800	837079	1" Dr. 79mm Hand Socket (12-Point) (CR-Mo)	B-92	13125
832M600	1" Dr. 32mm(1-1/4") Torque Socket, 600 ft.lbs.(813Nm)	J-11	10800	837080	1" Dr. 80mm Hand Socket (12-Point) (CR-Mo)	B-92	13125
832M650	1" Dr. 32mm(1-1/4") Torque Socket, 650 ft.lbs.(881Nm)	J-11	10800	837082	1" Dr. 82mm Hand Socket (12-Point) (CR-Mo)	B-92	18375
833M600	1" Dr. 33mm Torque Socket, 600 ft.lbs.(813Nm)	J-11	10800	837083	1" Dr. 83mm Hand Socket (12-Point) (CR-Mo)	B-92	18375
833M650	1" Dr. 33mm Torque Socket, 650 ft.lbs.(881Nm)	J-11	10800	837085	1" Dr. 85mm Hand Socket (12-Point) (CR-Mo)	B-92	18375
834S200	1" Dr. 1-1/16"(27mm) Torque Socket, 200 ft.lbs.(271Nm)	J-11	10800	837090	1" Dr. 90mm Hand Socket (12-Point) (CR-Mo)	B-92	22315
834S300	1" Dr. 1-1/16"(27mm) Torque Socket, 300 ft.lbs.(407Nm)	J-11	10800	837095	1" Dr. 95mm Hand Socket (12-Point) (CR-Mo)	B-92	27820
836M650	1" Dr. 36mm Torque Socket, 650 ft.lbs.(881Nm)	J-11	10800	838S300	1" Dr. 1-3/16"(30mm) Torque Socket, 300 ft.lbs.(407Nm)	J-11	10800
837017	1" Dr. 17mm Hand Socket (12-Point) (CR-Mo)	B-92	1420	838S400	1" Dr. 1-3/16"(30mm) Torque Socket, 400 ft.lbs.(542Nm)	J-11	10800
837018	1" Dr. 18mm Hand Socket (12-Point) (CR-Mo)	B-92	1420	840150	1" Dr. Impact Extension Bar w/pin hole, 150mmL (CR-Mo)	A-59	4095
837019	1" Dr. 19mm Hand Socket (12-Point) (CR-Mo)	B-92	1420	840150B	1" Dr. Impact Extension Bar w/steel ball, 150mmL (CR-Mo)	A-59	4095
837020	1" Dr. 20mm Hand Socket (12-Point) (CR-Mo)	B-92	1420	840250	1" Dr. Impact Extension Bar w/pin hole, 250mmL (CR-Mo)	A-59	6300
837021	1" Dr. 21mm Hand Socket (12-Point) (CR-Mo)	B-92	1420	840250B	1" Dr. Impact Extension Bar w/steel ball, 250mmL (CR-Mo)	A-59	6300
837022	1" Dr. 22mm Hand Socket (12-Point) (CR-Mo)	B-92	1420	840400	1" Dr. Impact Extension Bar w/pin hole, 400mmL (CR-Mo)	A-59	10000
837023	1" Dr. 23mm Hand Socket (12-Point) (CR-Mo)	B-92	1420	840400B	1" Dr. Impact Extension Bar w/steel ball, 400mmL (CR-Mo)	A-59	10000
837024	1" Dr. 24mm Hand Socket (12-Point) (CR-Mo)	B-92	1420	840808	1" Dr. Impact Universal Joint w/pin hole (CR-Mo)	A-59	6490
837025	1" Dr. 25mm Hand Socket (12-Point) (CR-Mo)	B-92	1420	840808B	1" Dr. Impact Universal Joint w/steel ball (CR-Mo)	A-59	6490
837026	1" Dr. 26mm Hand Socket (12-Point) (CR-Mo)	B-92	1420	840S250	1" Dr. 1-1/4"(32mm) Torque Socket, 250 ft.lbs.(339Nm)	J-11	10800
837027	1" Dr. 27mm Hand Socket (12-Point) (CR-Mo)	B-92	1420	841005	1" Dr. Impact Adapter, 1" F x #5 Spline Dr. M (CR-Mo)	A-78	7800
837028	1" Dr. 28mm Hand Socket (12-Point) (CR-Mo)	B-92	1420	841006	1" Dr. Impact Adapter w/pin hole, 1" F x 3/4" M (CR-Mo)	A-59	2180
837029	1" Dr. 29mm Hand Socket (12-Point) (CR-Mo)	B-92	1420	841006B	1" Dr. Impact Adapter w/steel ball, 1" F x 3/4" M (CR-Mo)	A-59	2180
837030	1" Dr. 30mm Hand Socket (12-Point) (CR-Mo)	B-92	1420	841012	1" Dr. Impact Adapter w/pin hole, 1" F x 1-1/2" M (CR-Mo)	A-59	2600
837031	1" Dr. 31mm Hand Socket (12-Point) (CR-Mo)	B-92	1525	841012B	1" Dr. Impact Adapter w/steel ball, 1" F x 1-1/2" M (CR-Mo)	A-59	2600
837032	1" Dr. 32mm Hand Socket (12-Point) (CR-Mo)	B-92	1525	841064	1" Dr. Impact Extension Bar w/pin hole, 200mmL (CR-Mo)	A-59	4675
837033	1" Dr. 33mm Hand Socket (12-Point) (CR-Mo)	B-92	1575	841064B	1" Dr. Impact Extension Bar w/steel ball, 200mmL (CR-Mo)	A-59	4675
837034	1" Dr. 34mm Hand Socket (12-Point) (CR-Mo)	B-92	1630	841M400	1" Dr. 41mm Torque Socket, 400 ft.lbs.(542Nm)	J-11	10800
837035	1" Dr. 35mm Hand Socket (12-Point) (CR-Mo)	B-92	1680	841M650	1" Dr. 41mm(1-5/8") Torque Socket, 650 ft.lbs.(881Nm)	J-11	10800
837036	1" Dr. 36mm Hand Socket (12-Point) (CR-Mo)	B-92	1680	842S325	1" Dr. 1-5/16" Torque Socket, 325 ft.lbs.(441Nm)	J-11	10800
837037	1" Dr. 37mm Hand Socket (12-Point) (CR-Mo)	B-92	1785	842S475	1" Dr. 1-5/16" Torque Socket, 475 ft.lbs.(644Nm)	J-11	10800
837038	1" Dr. 38mm Hand Socket (12-Point) (CR-Mo)	B-92	1785	846017S	1" Dr. 17mm Budd Wheel Impact Socket (CR-Mo)	J-16	1680
837039	1" Dr. 39mm Hand Socket (12-Point) (CR-Mo)	B-92	2100	846019S	1" Dr. 19mm Budd Wheel Impact Socket (CR-Mo)	J-16	1680
837040	1" Dr. 40mm Hand Socket (12-Point) (CR-Mo)	B-92	2100	846020S	1" Dr. 20mm Budd Wheel Impact Socket (CR-Mo)	J-16	1680
837041	1" Dr. 41mm Hand Socket (12-Point) (CR-Mo)	B-92	2100	846021S	1" Dr. 21mm Budd Wheel Impact Socket (CR-Mo)	J-16	1680
837042	1" Dr. 42mm Hand Socket (12-Point) (CR-Mo)	B-92	2365	847017	1" Dr. 17mm Impact Socket (CR-Mo)	A-54	1550
837043	1" Dr. 43mm Hand Socket (12-Point) (CR-Mo)	B-92	2365	847018	1" Dr. 18mm Impact Socket (CR-Mo)	A-54	1550
837044	1" Dr. 44mm Hand Socket (12-Point) (CR-Mo)	B-92	2365	847019	1" Dr. 19mm Impact Socket (CR-Mo)	A-54	1550
837045	1" Dr. 45mm Hand Socket (12-Point) (CR-Mo)	B-92	2365	847020	1" Dr. 20mm Impact Socket (CR-Mo)	A-54	1550
837046	1" Dr. 46mm Hand Socket (12-Point) (CR-Mo)	B-92	2365	847021	1" Dr. 21mm Impact Socket (CR-Mo)	A-54	1550
837047	1" Dr. 47mm Hand Socket (12-Point) (CR-Mo)	B-92	2625	847022	1" Dr. 22mm Impact Socket (CR-Mo)	A-54	1550
837048	1" Dr. 48mm Hand Socket (12-Point) (CR-Mo)	B-92	2625	847023	1" Dr. 23mm Impact Socket (CR-Mo)	A-54	1550
837049	1" Dr. 49mm Hand Socket (12-Point) (CR-Mo)	B-92	3150	847024	1" Dr. 24mm Impact Socket (CR-Mo)	A-54	1550
837050	1" Dr. 50mm Hand Socket (12-Point) (CR-Mo)	B-92	3150	847025	1" Dr. 24mm Impact Socket (CR-Mo)	A-54	1550

Item No.	Description	Pg.	Code	Item No.	Description	Pg.	Code
847026	1" Dr. 26mm Impact Socket (CR-Mo)	A-54	1550	848025	1" Dr. 25mm Thin Wall Impact Socket (CR-Mo)	A-59	1995
847027	1" Dr. 27mm Impact Socket (CR-Mo)	A-54	1550	848026	1" Dr. 26mm Thin Wall Impact Socket (CR-Mo)	A-59	1995
847028	1" Dr. 28mm Impact Socket (CR-Mo)	A-54	1550	848027	1" Dr. 27mm Thin Wall Impact Socket (CR-Mo)	A-59	1995
847029	1" Dr. 29mm Impact Socket (CR-Mo)	A-54	1550	848028	1" Dr. 28mm Thin Wall Impact Socket (CR-Mo)	A-59	2050
847030	1" Dr. 30mm Impact Socket (CR-Mo)	A-54	1550	848029	1" Dr. 29mm Thin Wall Impact Socket (CR-Mo)	A-59	2050
847031	1" Dr. 31mm Impact Socket (CR-Mo)	A-54	1655	848030	1" Dr. 30mm Thin Wall Impact Socket (CR-Mo)	A-59	2050
847032	1" Dr. 32mm Impact Socket (CR-Mo)	A-54	1655	848032	1" Dr. 32mm Thin Wall Impact Socket (CR-Mo)	A-59	2050
847033	1" Dr. 33mm Impact Socket (CR-Mo)	A-54	1710	848033	1" Dr. 33mm Thin Wall Impact Socket (CR-Mo)	A-59	2260
847034	1" Dr. 34mm Impact Socket (CR-Mo)	A-54	1760	848034	1" Dr. 34mm Thin Wall Impact Socket (CR-Mo)	A-59	2260
847035	1" Dr. 35mm Impact Socket (CR-Mo)	A-54	1815	848035	1" Dr. 35mm Thin Wall Impact Socket (CR-Mo)	A-59	2310
847036	1" Dr. 36mm Impact Socket (CR-Mo)	A-54	1865	848036	1" Dr. 36mm Thin Wall Impact Socket (CR-Mo)	A-59	2310
847037	1" Dr. 37mm Impact Socket (CR-Mo)	A-54	1970	848038	1" Dr. 38mm Thin Wall Impact Socket (CR-Mo)	A-59	2365
847038	1" Dr. 38mm Impact Socket (CR-Mo)	A-54	1970	848041	1" Dr. 41mm Thin Wall Impact Socket (CR-Mo)	A-59	2625
847039	1" Dr. 39mm Impact Socket (CR-Mo)	A-54	2100	848S475	1" Dr. 1-1/2"(38mm) Torque Socket, 475 ft.lbs.(644Nm)	J-11	10800
847040	1" Dr. 40mm Impact Socket (CR-Mo)	A-54	2100	848S525	1" Dr. 1-1/2"(38mm) Torque Socket, 525 ft.lbs.(712Nm)	J-11	10800
847041	1" Dr. 41mm Impact Socket (CR-Mo)	A-54	2285	849035B	1" Dr. 35mm Hex & 17mm Dual Budd Wheel Socket (CR-Mo)	J-16	3150
847042	1" Dr. 42mm Impact Socket (CR-Mo)	A-54	2625	849038B	1" Dr. 38mm Hex & 20mm Dual Budd Wheel Socket (CR-Mo)	J-16	3675
847043	1" Dr. 43mm Impact Socket (CR-Mo)	A-54	2625	849041B	1" Dr. 41mm Hex & 21mm Dual Budd Wheel Socket (CR-Mo)	J-16	4200
847044	1" Dr. 44mm Impact Socket (CR-Mo)	A-54	3150	849517	1" Dr. 17mm Deep Impact Socket (CR-Mo)	A-55	2205
847045	1" Dr. 45mm Impact Socket (CR-Mo)	A-54	3150	849517S	1" Dr. 17mm Budd Wheel Impact Socket (CR-Mo)	J-16	2470
847046	1" Dr. 46mm Impact Socket (CR-Mo)	A-54	3150	849518	1" Dr. 18mm Deep Impact Socket (CR-Mo)	A-55	2205
847047	1" Dr. 47mm Impact Socket (CR-Mo)	A-54	3675	849519	1" Dr. 19mm Deep Impact Socket (CR-Mo)	A-55	2205
847048	1" Dr. 48mm Impact Socket (CR-Mo)	A-54	3675	849519S	1" Dr. 19mm Budd Wheel Impact Socket (CR-Mo)	J-16	2470
847049	1" Dr. 49mm Impact Socket (CR-Mo)	A-54	3940	849520	1" Dr. 20mm Deep Impact Socket (CR-Mo)	A-55	2205
847050	1" Dr. 50mm Impact Socket (CR-Mo)	A-54	3940	849520S	1" Dr. 20mm Budd Wheel Impact Socket (CR-Mo)	J-16	2470
847051	1" Dr. 51mm Impact Socket (CR-Mo)	A-54	4200	849521	1" Dr. 21mm Deep Impact Socket (CR-Mo)	A-55	2205
847052	1" Dr. 52mm Impact Socket (CR-Mo)	A-54	4200	849521S	1" Dr. 21mm Budd Wheel Impact Socket (CR-Mo)	J-16	2470
847053	1" Dr. 53mm Impact Socket (CR-Mo)	A-54	4465	849522	1" Dr. 22mm Deep Impact Socket (CR-Mo)	A-55	2205
847054	1" Dr. 54mm Impact Socket (CR-Mo)	A-54	4465	849522S	1" Dr. 22mm Budd Wheel Impact Socket (CR-Mo)	J-16	2470
847055	1" Dr. 55mm Impact Socket (CR-Mo)	A-54	4725	849523	1" Dr. 23mm Deep Impact Socket (CR-Mo)	A-55	2205
847056	1" Dr. 56mm Impact Socket (CR-Mo)	A-54	4990	849524	1" Dr. 24mm Deep Impact Socket (CR-Mo)	A-55	2205
847057	1" Dr. 57mm Impact Socket (CR-Mo)	A-54	4990	849525	1" Dr. 25mm Deep Impact Socket (CR-Mo)	A-55	2205
847058	1" Dr. 58mm Impact Socket (CR-Mo)	A-54	5250	849526	1" Dr. 26mm Deep Impact Socket (CR-Mo)	A-55	2205
847059	1" Dr. 59mm Impact Socket (CR-Mo)	A-54	5775	849527	1" Dr. 27mm Deep Impact Socket (CR-Mo)	A-55	2205
847060	1" Dr. 60mm Impact Socket (CR-Mo)	A-54	6300	849528	1" Dr. 28mm Deep Impact Socket (CR-Mo)	A-55	2285
847061	1" Dr. 61mm Impact Socket (CR-Mo)	A-54	6825	849529	1" Dr. 29mm Deep Impact Socket (CR-Mo)	A-55	2285
847062	1" Dr. 62mm Impact Socket (CR-Mo)	A-54	6825	849530	1" Dr. 30mm Deep Impact Socket (CR-Mo)	A-55	2285
847063	1" Dr. 63mm Impact Socket (CR-Mo)	A-54	6825	849531	1" Dr. 31mm Deep Impact Socket (CR-Mo)	A-55	2285
847064	1" Dr. 64mm Impact Socket (CR-Mo)	A-54	7875	849532	1" Dr. 32mm Deep Impact Socket (CR-Mo)	A-55	2285
847065	1" Dr. 65mm Impact Socket (CR-Mo)	A-54	7875	849533	1" Dr. 33mm Deep Impact Socket (CR-Mo)	A-55	2550
847066	1" Dr. 66mm Impact Socket (CR-Mo)	A-54	9500	849534	1" Dr. 34mm Deep Impact Socket (CR-Mo)	A-55	2680
847067	1" Dr. 67mm Impact Socket (CR-Mo)	A-54	9500	849535	1" Dr. 35mm Deep Impact Socket (CR-Mo)	A-55	2785
847068	1" Dr. 68mm Impact Socket (CR-Mo)	A-54	10500	849536	1" Dr. 36mm Deep Impact Socket (CR-Mo)	A-55	2940
847069	1" Dr. 69mm Impact Socket (CR-Mo)	A-54	10500	849537	1" Dr. 37mm Deep Impact Socket (CR-Mo)	A-55	3150
847070	1" Dr. 70mm Impact Socket (CR-Mo)	A-54	10550	849538	1" Dr. 38mm Deep Impact Socket (CR-Mo)	A-55	3150
847071	1" Dr. 71mm Impact Socket (CR-Mo)	A-55	12000	849539	1" Dr. 39mm Deep Impact Socket (CR-Mo)	A-55	3415
847072	1" Dr. 72mm Impact Socket (CR-Mo)	A-55	13650	849540	1" Dr. 40mm Deep Impact Socket (CR-Mo)	A-55	3415
847073	1" Dr. 73mm Impact Socket (CR-Mo)	A-55	13650	849541	1" Dr. 41mm Deep Impact Socket (CR-Mo)	A-56	3415
847074	1" Dr. 74mm Impact Socket (CR-Mo)	A-55	13650	849542	1" Dr. 42mm Deep Impact Socket (CR-Mo)	A-56	3675
847075	1" Dr. 75mm Impact Socket (CR-Mo)	A-55	13650	849543	1" Dr. 43mm Deep Impact Socket (CR-Mo)	A-56	3675
847076	1" Dr. 76mm Impact Socket (CR-Mo)	A-55	15500	849544	1" Dr. 44mm Deep Impact Socket (CR-Mo)	A-56	4200
847077	1" Dr. 77mm Impact Socket (CR-Mo)	A-55	15500	849545	1" Dr. 45mm Deep Impact Socket (CR-Mo)	A-56	4200
847078	1" Dr. 78mm Impact Socket (CR-Mo)	A-55	15500	849546	1" Dr. 46mm Deep Impact Socket (CR-Mo)	A-56	4465
847079	1" Dr. 79mm Impact Socket (CR-Mo)	A-55	15500	849547	1" Dr. 47mm Deep Impact Socket (CR-Mo)	A-56	4935
847080	1" Dr. 80mm Impact Socket (CR-Mo)	A-55	15500	849548	1" Dr. 48mm Deep Impact Socket (CR-Mo)	A-56	4935
847082	1" Dr. 82mm Impact Socket (CR-Mo)	A-55	18500	849549	1" Dr. 49mm Deep Impact Socket (CR-Mo)	A-56	5250
847083	1" Dr. 83mm Impact Socket (CR-Mo)	A-55	18500	849550	1" Dr. 50mm Deep Impact Socket (CR-Mo)	A-56	5250
847085	1" Dr. 85mm Impact Socket (CR-Mo)	A-55	18500	849551	1" Dr. 51mm Deep Impact Socket (CR-Mo)	A-56	5515
847090	1" Dr. 90mm Impact Socket (CR-Mo)	A-55	21500	849552	1" Dr. 52mm Deep Impact Socket (CR-Mo)	A-56	5515
847095	1" Dr. 95mm Impact Socket (CR-Mo)	A-55	24900	849553	1" Dr. 53mm Deep Impact Socket (CR-Mo)	A-56	5775
847100	1" Dr. 100mm Impact Socket (CR-Mo)	A-55	28800	849554	1" Dr. 54mm Deep Impact Socket (CR-Mo)	A-56	5775
847105	1" Dr. 105mm Impact Socket (CR-Mo)	A-55	33200	849555	1" Dr. 55mm Deep Impact Socket (CR-Mo)	A-56	6040
847110	1" Dr. 110mm Impact Socket (CR-Mo)	A-55	38300	849556	1" Dr. 56mm Deep Impact Socket (CR-Mo)	A-56	6300
847115	1" Dr. 115mm Impact Socket (CR-Mo)	A-55	44000	849557	1" Dr. 57mm Deep Impact Socket (CR-Mo)	A-56	6300
847617S	1" Dr. 17mm Budd Wheel Impact Socket (CR-Mo)	J-16	2365	849558	1" Dr. 58mm Deep Impact Socket (CR-Mo)	A-56	6565
847619S	1" Dr. 19mm Budd Wheel Impact Socket (CR-Mo)	J-16	2365	849559	1" Dr. 59mm Deep Impact Socket (CR-Mo)	A-56	6825
847621S	1" Dr. 21mm Budd Wheel Impact Socket (CR-Mo)	J-16	2365	849560	1" Dr. 60mm Deep Impact Socket (CR-Mo)	A-56	7350
848022	1" Dr. 22mm Thin Wall Impact Socket (CR-Mo)	A-59	1995	849561	1" Dr. 61mm Deep Impact Socket (CR-Mo)	A-56	8140
848023	1" Dr. 23mm Thin Wall Impact Socket (CR-Mo)	A-59	1995	849562	1" Dr. 62mm Deep Impact Socket (CR-Mo)	A-56	8140
848024	1" Dr. 24mm Thin Wall Impact Socket (CR-Mo)	A-59	1995	849563	1" Dr. 63mm Deep Impact Socket (CR-Mo)	A-56	8140

Item No.	Description	Pg.	Code	Item No.	Description	Pg.	Code
849564	1" Dr. 64mm Deep Impact Socket (CR-Mo)	A-56	9190	867048	1" Dr. 1-1/2" Impact Socket (CR-Mo)	A-57	1970
849565	1" Dr. 65mm Deep Impact Socket (CR-Mo)	A-56	9190	867050	1" Dr. 1-9/16" Impact Socket (CR-Mo)	A-57	2100
849566	1" Dr. 66mm Deep Impact Socket (CR-Mo)	A-56	12075	867052	1" Dr. 1-5/8" Impact Socket (CR-Mo)	A-57	2285
849567	1" Dr. 67mm Deep Impact Socket (CR-Mo)	A-56	12075	867054	1" Dr. 1-11/16" Impact Socket (CR-Mo)	A-57	2625
849568	1" Dr. 68mm Deep Impact Socket (CR-Mo)	A-56	12075	867056	1" Dr. 1-3/4" Impact Socket (CR-Mo)	A-57	3150
849569	1" Dr. 69mm Deep Impact Socket (CR-Mo)	A-56	12075	867058	1" Dr. 1-13/16" Impact Socket (CR-Mo)	A-57	3150
849570	1" Dr. 70mm Deep Impact Socket (CR-Mo)	A-56	12075	867060	1" Dr. 1-7/8" Impact Socket (CR-Mo)	A-57	3675
849571	1" Dr. 71mm Deep Impact Socket (CR-Mo)	A-56	14200	867062	1" Dr. 1-5/8" Impact Socket (CR-Mo)	A-57	3940
849572	1" Dr. 72mm Deep Impact Socket (CR-Mo)	A-56	14200	867064	1" Dr. 2" Impact Socket (CR-Mo)	A-57	4200
849573	1" Dr. 73mm Deep Impact Socket (CR-Mo)	A-56	14200	867066	1" Dr. 2-1/16" Impact Socket (CR-Mo)	A-57	4465
849574	1" Dr. 74mm Deep Impact Socket (CR-Mo)	A-56	14200	867068	1" Dr. 2-1/8" Impact Socket (CR-Mo)	A-57	4465
849575	1" Dr. 75mm Deep Impact Socket (CR-Mo)	A-56	14200	867070	1" Dr. 2-3/16" Impact Socket (CR-Mo)	A-57	4725
849576	1" Dr. 76mm Deep Impact Socket (CR-Mo)	A-56	16600	867072	1" Dr. 2-1/4" Impact Socket (CR-Mo)	A-57	4990
849577	1" Dr. 77mm Deep Impact Socket (CR-Mo)	A-56	16600	867074	1" Dr. 2-5/16" Impact Socket (CR-Mo)	A-57	5775
849578	1" Dr. 78mm Deep Impact Socket (CR-Mo)	A-56	16600	867076	1" Dr. 2-3/8" Impact Socket (CR-Mo)	A-57	6300
849579	1" Dr. 79mm Deep Impact Socket (CR-Mo)	A-56	16600	867078	1" Dr. 2-7/16" Impact Socket (CR-Mo)	A-57	6825
849580	1" Dr. 80mm Deep Impact Socket (CR-Mo)	A-56	16600	867080	1" Dr. 2-1/2" Impact Socket (CR-Mo)	A-57	6825
849582	1" Dr. 82mm Deep Impact Socket (CR-Mo)	A-56	19400	867082	1" Dr. 2-9/16" Impact Socket (CR-Mo)	A-57	8400
849583	1" Dr. 83mm Deep Impact Socket (CR-Mo)	A-56	19400	867084	1" Dr. 2-5/8" Impact Socket (CR-Mo)	A-57	10500
849585	1" Dr. 85mm Deep Impact Socket (CR-Mo)	A-56	19400	867086	1" Dr. 2-11/16" Impact Socket (CR-Mo)	A-57	10500
849590	1" Dr. 90mm Deep Impact Socket (CR-Mo)	A-56	22600	867088	1" Dr. 2-3/4" Impact Socket (CR-Mo)	A-57	10500
849595	1" Dr. 95mm Deep Impact Socket (CR-Mo)	A-56	26200	867090	1" Dr. 2-13/16" Impact Socket (CR-Mo)	A-57	12075
849600	1" Dr. 100mm Deep Impact Socket (CR-Mo)	A-56	30300	867092	1" Dr. 2-7/8" Impact Socket (CR-Mo)	A-57	13650
849605	1" Dr. 105mm Deep Impact Socket (CR-Mo)	A-56	35000	867094	1" Dr. 2-15/16" Impact Socket (CR-Mo)	A-57	13650
849610	1" Dr. 110mm Deep Impact Socket (CR-Mo)	A-56	40300	867096	1" Dr. 3" Impact Socket (CR-Mo)	A-57	16800
849615	1" Dr. 115mm Deep Impact Socket (CR-Mo)	A-56	46300	867098	1" Dr. 3-1/2" Impact Socket (CR-Mo)	A-57	16800
849819	1" Dr. 19mm Hex Head Driver, 98mmL	C-15	2970	867100	1" Dr. 3-1/8" Impact Socket (CR-Mo)	A-57	16800
849821	1" Dr. 21mm Hex Head Driver, 98mmL	C-15	3000	867102	1" Dr. 3-3/16" Impact Socket (CR-Mo)	A-57	18500
849822	1" Dr. 22mm Hex Head Driver, 98mmL	C-15	3080	867104	1" Dr. 3-1/4" Impact Socket (CR-Mo)	A-57	18500
849824	1" Dr. 24mm Hex Head Driver, 98mmL	C-15	3240	867106	1" Dr. 3-5/16" Impact Socket (CR-Mo)	A-57	18500
849826	1" Dr. 26mm Hex Head Driver, 98mmL	C-15	3300	867108	1" Dr. 3-3/8" Impact Socket (CR-Mo)	A-57	18500
849827	1" Dr. 27mm Hex Head Driver, 98mmL	C-15	3400	867110	1" Dr. 3-7/16" Impact Socket (CR-Mo)	A-57	21500
849830	1" Dr. 30mm Hex Head Driver, 98mmL	C-15	3600	867112	1" Dr. 3-1/2" Impact Socket (CR-Mo)	A-57	21500
849832	1" Dr. 32mm Hex Head Driver, 98mmL	C-15	3850	867114	1" Dr. 3-9/16" Impact Socket (CR-Mo)	A-57	21500
849833	1" Dr. 33mm Hex Head Driver, 98mmL	C-15	4000	867116	1" Dr. 3-5/8" Impact Socket (CR-Mo)	A-57	24900
849836	1" Dr. 36mm Hex Head Driver, 98mmL	C-15	4180	867118	1" Dr. 3-11/16" Impact Socket (CR-Mo)	A-57	24900
8504	1/4" Hex Shank, M4 Triple Square Screwdriver Bit, 88mmL	D-14	260	867120	1" Dr. 3-1/2" Impact Socket (CR-Mo)	A-57	24900
8505	1/4" Hex Shank, M5 Triple Square Screwdriver Bit, 88mmL	D-14	260	867122	1" Dr. 3-13/16" Impact Socket (CR-Mo)	A-57	28800
8506	1/4" Hex Shank, M6 Triple Square Screwdriver Bit, 88mmL	D-14	260	867124	1" Dr. 3-7/8" Impact Socket (CR-Mo)	A-57	28800
8508	5/16" Hex Shank, M8 Triple Square Screwdriver Bit, 88mmL	D-14	300	867126	1" Dr. 3-15/16" Impact Socket (CR-Mo)	A-57	28800
8510	10mm Hex Shank, M10 Triple Square Screwdriver Bit, 88mmL	D-14	400	867128	1" Dr. 4" Impact Socket (CR-Mo)	A-57	28800
8512	12mm Hex Shank, M12 Triple Square Screwdriver Bit, 88mmL	D-14	540	867130	1" Dr. 4-1/16" Impact Socket (CR-Mo)	A-57	33200
8514	14mm Hex Shank, M14 Triple Square Screwdriver Bit, 88mmL	D-14	680	867132	1" Dr. 4-1/8" Impact Socket (CR-Mo)	A-57	33200
8516	16mm Hex Shank, M16 Triple Square Screwdriver Bit, 88mmL	D-14	770	867134	1" Dr. 4-3/4" Impact Socket (CR-Mo)	A-57	38300
8518	19mm Hex Shank, M18 Triple Square Screwdriver Bit, 88mmL	D-14	880	867136	1" Dr. 4-1/4" Impact Socket (CR-Mo)	A-57	38300
8604	1/4" Hex Shank, M4 Triple Square Screwdriver Bit, 125mmL	D-14	300	867138	1" Dr. 4-5/16" Impact Socket (CR-Mo)	A-57	38300
8605	1/4" Hex Shank, M5 Triple Square Screwdriver Bit, 125mmL	D-14	300	867140	1" Dr. 4-3/8" Impact Socket (CR-Mo)	A-57	44000
8606	1/4" Hex Shank, M6 Triple Square Screwdriver Bit, 125mmL	D-14	300	867142	1" Dr. 4-7/16" Impact Socket (CR-Mo)	A-57	44000
8608	5/16" Hex Shank, M8 Triple Square Screwdriver Bit, 125mmL	D-14	400	867144	1" Dr. 4-1/2" Impact Socket (CR-Mo)	A-57	44000
8610	10mm Hex Shank, M10 Triple Square Screwdriver Bit, 125mmL	D-14	600	8676245	1" Dr. 3/4" Budd Wheel Impact Socket (CR-Mo)	J-16	2365
8612	12mm Hex Shank, M12 Triple Square Screwdriver Bit, 125mmL	D-14	750	8676265	1" Dr. 13/16" Budd Wheel Impact Socket (CR-Mo)	J-16	2365
8614	14mm Hex Shank, M14 Triple Square Screwdriver Bit, 125mmL	D-14	900	869048B	1" Dr. 1/2" Hex & 13/16" Dual Budd Wheel Socket (CR-Mo)	J-16	3675
8616	16mm Hex Shank, M16 Triple Square Screwdriver Bit, 125mmL	D-14	1050	8695225	1" Dr. 11/16" Budd Wheel Impact Socket (CR-Mo)	J-16	2470
8618	19mm Hex Shank, M18 Triple Square Screwdriver Bit, 125mmL	D-14	1200	869524	1" Dr. 3/4" Deep Impact Socket (CR-Mo)	A-58	2205
8660245	1" Dr. 3/4" Budd Wheel Impact Socket (CR-Mo)	J-16	1680	8695245	1" Dr. 3/4" Budd Wheel Impact Socket (CR-Mo)	J-16	2470
8660265	1" Dr. 13/16" Budd Wheel Impact Socket (CR-Mo)	J-16	1680	869525	1" Dr. 25/32" Deep Impact Socket (CR-Mo)	A-58	2205
8660305	1" Dr. 15/16" Budd Wheel Impact Socket (CR-Mo)	J-16	1980	869526	1" Dr. 13/16" Deep Impact Socket (CR-Mo)	A-58	2205
867024	1" Dr. 3/4" Impact Socket (CR-Mo)	A-57	1550	8695265	1" Dr. 13/16" Budd Wheel Impact Socket (CR-Mo)	J-16	2470
867025	1" Dr. 25/32" Impact Socket (CR-Mo)	A-57	1550	869528	1" Dr. 7/8" Deep Impact Socket (CR-Mo)	A-58	2205
867026	1" Dr. 13/16" Impact Socket (CR-Mo)	A-57	1550	869530	1" Dr. 15/16" Deep Impact Socket (CR-Mo)	A-58	2205
867028	1" Dr. 7/8" Impact Socket (CR-Mo)	A-57	1550	869532	1" Dr. 1" Deep Impact Socket (CR-Mo)	A-58	2205
867030	1" Dr. 15/16" Impact Socket (CR-Mo)	A-57	1550	869534	1" Dr. 1-1/16" Deep Impact Socket (CR-Mo)	A-58	2205
867032	1" Dr. 1" Impact Socket (CR-Mo)	A-57	1550	869534T	1" Dr. 1-1/16" Deep Thin Wall Impact Socket (CR-Mo)	A-59	2205
867034	1" Dr. 1-1/16" Impact Socket (CR-Mo)	A-57	1550	869536	1" Dr. 1-1/8" Deep Impact Socket (CR-Mo)	A-58	2285
867036	1" Dr. 1-1/8" Impact Socket (CR-Mo)	A-57	1550	869536T	1" Dr. 1-1/8" Deep Thin Wall Impact Socket (CR-Mo)	A-59	2285
867038	1" Dr. 1-13/16" Impact Socket (CR-Mo)	A-57	1550	869538	1" Dr. 1-13/16" Deep Impact Socket (CR-Mo)	A-58	2285
867040	1" Dr. 1-1/4" Impact Socket (CR-Mo)	A-57	1655	869540	1" Dr. 1-1/4" Deep Impact Socket (CR-Mo)	A-58	2285
867042	1" Dr. 1-5/16" Impact Socket (CR-Mo)	A-57	1710	869540T	1" Dr. 1-1/4" Deep Thin Wall Impact Socket (CR-Mo)	A-59	2285
867044	1" Dr. 1-3/8" Impact Socket (CR-Mo)	A-57	1815	869542	1" Dr. 1-5/16" Deep Impact Socket (CR-Mo)	A-58	2550
867046	1" Dr. 1-7/16" Impact Socket (CR-Mo)	A-57	1970	869544	1" Dr. 1-3/8" Deep Impact Socket (CR-Mo)	A-58	2785

Item No.	Description	Pg.	Code
869546	1" Dr. 1-7/16" Deep Impact Socket (CR-Mo)	A-58	2940
869548	1" Dr. 1-1/2" Deep Impact Socket (CR-Mo)	A-58	3150
869548B	1" Dr. 1-1/2" Deep Budd Wheel Impact Socket (CR-Mo)	J-16	3700
869550	1" Dr. 1-9/16" Deep Impact Socket (CR-Mo)	A-58	3415
869552	1" Dr. 1-5/8" Deep Impact Socket (CR-Mo)	A-58	3415
869554	1" Dr. 1-11/16" Deep Impact Socket (CR-Mo)	A-58	3675
869556	1" Dr. 1-3/4" Deep Impact Socket (CR-Mo)	A-58	4465
869558	1" Dr. 1-13/16" Deep Impact Socket (CR-Mo)	A-58	4465
869560	1" Dr. 1-7/8" Deep Impact Socket (CR-Mo)	A-58	4935
869562	1" Dr. 1-15/16" Deep Impact Socket (CR-Mo)	A-58	5250
869564	1" Dr. 2" Deep Impact Socket (CR-Mo)	A-58	5515
869566	1" Dr. 2-1/16" Deep Impact Socket (CR-Mo)	A-58	5515
869568	1" Dr. 2-1/8" Deep Impact Socket (CR-Mo)	A-58	5775
869570	1" Dr. 2-3/16" Deep Impact Socket (CR-Mo)	A-58	6040
869572	1" Dr. 2-1/4" Deep Impact Socket (CR-Mo)	A-58	6300
869574	1" Dr. 2-5/16" Deep Impact Socket (CR-Mo)	A-58	6825
869576	1" Dr. 2-3/8" Deep Impact Socket (CR-Mo)	A-58	7350
869578	1" Dr. 2-7/16" Deep Impact Socket (CR-Mo)	A-58	8140
869580	1" Dr. 2-1/2" Deep Impact Socket (CR-Mo)	A-58	8140
869582	1" Dr. 2-9/16" Deep Impact Socket (CR-Mo)	A-58	9450
869584	1" Dr. 2-5/8" Deep Impact Socket (CR-Mo)	A-58	12075
869586	1" Dr. 2-11/16" Deep Impact Socket (CR-Mo)	A-58	12075
869588	1" Dr. 2-3/4" Deep Impact Socket (CR-Mo)	A-58	12075
869590	1" Dr. 2-13/16" Deep Impact Socket (CR-Mo)	A-58	17500
869592	1" Dr. 2-7/8" Deep Impact Socket (CR-Mo)	A-58	17500
869594	1" Dr. 2-15/16" Deep Impact Socket (CR-Mo)	A-58	17500
869596	1" Dr. 3" Deep Impact Socket (CR-Mo)	A-58	17500
869598	1" Dr. 3-1/16" Deep Impact Socket (CR-Mo)	A-58	18300
869600	1" Dr. 3-1/8" Deep Impact Socket (CR-Mo)	A-58	18300
869602	1" Dr. 3-3/16" Deep Impact Socket (CR-Mo)	A-58	18300
869604	1" Dr. 3-1/4" Deep Impact Socket (CR-Mo)	A-58	19400
869606	1" Dr. 3-5/16" Deep Impact Socket (CR-Mo)	A-58	19400
869608	1" Dr. 3-3/8" Deep Impact Socket (CR-Mo)	A-58	19400
869610	1" Dr. 3-7/16" Deep Impact Socket (CR-Mo)	A-58	22600
869612	1" Dr. 3-1/2" Deep Impact Socket (CR-Mo)	A-58	22600
869614	1" Dr. 3-9/16" Deep Impact Socket (CR-Mo)	A-58	22600
869616	1" Dr. 3-5/8" Deep Impact Socket (CR-Mo)	A-58	26200
869618	1" Dr. 3-11/16" Deep Impact Socket (CR-Mo)	A-58	26200
869620	1" Dr. 3-3/4" Deep Impact Socket (CR-Mo)	A-58	26200
869622	1" Dr. 3-13/16" Deep Impact Socket (CR-Mo)	A-58	30300
869624	1" Dr. 3-7/8" Deep Impact Socket (CR-Mo)	A-58	30300
869626	1" Dr. 3-15/16" Deep Impact Socket (CR-Mo)	A-58	30300
869628	1" Dr. 4" Deep Impact Socket (CR-Mo)	A-58	30300
869630	1" Dr. 4-1/16" Deep Impact Socket (CR-Mo)	A-58	35000
869632	1" Dr. 4-1/8" Deep Impact Socket (CR-Mo)	A-58	35000
869634	1" Dr. 4-3/16" Deep Impact Socket (CR-Mo)	A-58	40300
869636	1" Dr. 4-1/4" Deep Impact Socket (CR-Mo)	A-58	40300
869638	1" Dr. 4-5/16" Deep Impact Socket (CR-Mo)	A-58	40300
869640	1" Dr. 4-3/8" Deep Impact Socket (CR-Mo)	A-58	46300
869642	1" Dr. 4-7/16" Deep Impact Socket (CR-Mo)	A-58	46300
869644	1" Dr. 4-1/2" Deep Impact Socket (CR-Mo)	A-58	46300
869824	1" Dr. 3/4" Hex Head Driver, 98mmL, 98mmL	C-15	2970
869826	1" Dr. 13/16" Hex Head Driver, 98mmL	C-15	3000
869828	1" Dr. 7/8" Hex Head Driver, 98mmL	C-15	3080
869830	1" Dr. 15/16" Hex Head Driver, 98mmL	C-15	3240
869832	1" Dr. 1" Hex Head Driver, 98mmL	C-15	3300
869834	1" Dr. 1-1/16" Hex Head Driver, 98mmL	C-15	3400
869836	1" Dr. 1-1/8" Hex Head Driver, 98mmL	C-15	3600
869838	1" Dr. 1-3/16" Hex Head Driver, 98mmL	C-15	3740
869840	1" Dr. 1-1/4" Hex Head Driver, 98mmL	C-15	3850
869842	1" Dr. 1-5/16" Hex Head Driver, 98mmL	C-15	4000
869844	1" Dr. 1-3/8" Hex Head Driver, 98mmL	C-15	4180
8704	1/4" Hex Shank, M4 Triple Square Screwdriver Bit, 160mmL	D-14	380
8705	1/4" Hex Shank, M5 Triple Square Screwdriver Bit, 160mmL	D-14	380
8706	1/4" Hex Shank, M6 Triple Square Screwdriver Bit, 160mmL	D-14	380
8708	5/16" Hex Shank, M8 Triple Square Screwdriver Bit, 160mmL	D-14	500
8710	10mm Hex Shank, M10 Triple Square Screwdriver Bit, 160mmL	D-14	700
8712	12mm Hex Shank, M12 Triple Square Screwdriver Bit, 160mmL	D-14	880
8714	14mm Hex Shank, M14 Triple Square Screwdriver Bit, 160mmL	D-14	1050
8716	16mm Hex Shank, M16 Triple Square Screwdriver Bit, 160mmL	D-14	1230

Item No.	Description	Pg.	Code
8718	19mm Hex Shank, M18 Triple Square Screwdriver Bit, 160mmL	D-14	1400
877024	1" Dr. 3/4" Hand Socket(12-Point) (CR-Mo)	B-93	1420
877025	1" Dr. 25/32" Hand Socket(12-Point) (CR-Mo)	B-93	1420
877026	1" Dr. 13/16" Hand Socket(12-Point) (CR-Mo)	B-93	1420
877028	1" Dr. 7/8" Hand Socket(12-Point) (CR-Mo)	B-93	1420
877030	1" Dr. 15/16" Hand Socket(12-Point) (CR-Mo)	B-93	1420
877032	1" Dr. 1" Hand Socket(12-Point) (CR-Mo)	B-93	1420
877034	1" Dr. 1-1/16" Hand Socket(12-Point) (CR-Mo)	B-93	1420
877036	1" Dr. 1-1/8" Hand Socket(12-Point) (CR-Mo)	B-93	1420
877038	1" Dr. 1-3/16" Hand Socket(12-Point) (CR-Mo)	B-93	1420
877040	1" Dr. 1-1/4" Hand Socket(12-Point) (CR-Mo)	B-93	1525
877042	1" Dr. 1-5/16" Hand Socket(12-Point) (CR-Mo)	B-93	1575
877044	1" Dr. 1-3/8" Hand Socket(12-Point) (CR-Mo)	B-93	1680
877046	1" Dr. 1-7/16" Hand Socket(12-Point) (CR-Mo)	B-93	1680
877048	1" Dr. 1-1/2" Hand Socket(12-Point) (CR-Mo)	B-93	1785
877050	1" Dr. 1-9/16" Hand Socket(12-Point) (CR-Mo)	B-93	2100
877052	1" Dr. 1-5/8" Hand Socket(12-Point) (CR-Mo)	B-93	2100
877054	1" Dr. 1-11/16" Hand Socket(12-Point) (CR-Mo)	B-93	2365
877056	1" Dr. 1-3/4" Hand Socket(12-Point) (CR-Mo)	B-93	2365
877058	1" Dr. 1-13/16" Hand Socket(12-Point) (CR-Mo)	B-93	2365
877060	1" Dr. 1-7/8" Hand Socket(12-Point) (CR-Mo)	B-93	2625
877062	1" Dr. 1-15/16" Hand Socket(12-Point) (CR-Mo)	B-93	3150
877064	1" Dr. 2" Hand Socket(12-Point) (CR-Mo)	B-93	3150
877066	1" Dr. 2-1/16" Hand Socket(12-Point) (CR-Mo)	B-93	3415
877068	1" Dr. 2-1/8" Hand Socket(12-Point) (CR-Mo)	B-93	3415
877070	1" Dr. 2-3/16" Hand Socket(12-Point) (CR-Mo)	B-93	3570
877072	1" Dr. 2-1/4" Hand Socket(12-Point) (CR-Mo)	B-93	3675
877074	1" Dr. 2-5/16" Hand Socket(12-Point) (CR-Mo)	B-93	4200
877076	1" Dr. 2-3/8" Hand Socket(12-Point) (CR-Mo)	B-93	4465
877078	1" Dr. 2-7/16" Hand Socket(12-Point) (CR-Mo)	B-93	5250
877080	1" Dr. 2-1/2" Hand Socket(12-Point) (CR-Mo)	B-93	5250
877082	1" Dr. 2-9/16" Hand Socket(12-Point) (CR-Mo)	B-93	6300
877084	1" Dr. 2-5/8" Hand Socket(12-Point) (CR-Mo)	B-93	6300
877086	1" Dr. 2-11/16" Hand Socket(12-Point) (CR-Mo)	B-93	7875
877088	1" Dr. 2-3/4" Hand Socket(12-Point) (CR-Mo)	B-93	7875
877090	1" Dr. 2-13/16" Hand Socket(12-Point) (CR-Mo)	B-93	8925
877092	1" Dr. 2-7/8" Hand Socket(12-Point) (CR-Mo)	B-93	10500
877094	1" Dr. 2-15/16" Hand Socket(12-Point) (CR-Mo)	B-93	10500
877096	1" Dr. 3" Hand Socket(12-Point) (CR-Mo)	B-93	11550
877098	1" Dr. 3-1/16" Hand Socket(12-Point) (CR-Mo)	B-93	13125
877100	1" Dr. 3-1/8" Hand Socket(12-Point) (CR-Mo)	B-93	13125
877102	1" Dr. 3-3/16" Hand Socket(12-Point) (CR-Mo)	B-93	16800
877104	1" Dr. 3-1/4" Hand Socket(12-Point) (CR-Mo)	B-93	18375
877106	1" Dr. 3-5/16" Hand Socket(12-Point) (CR-Mo)	B-93	18375
877108	1" Dr. 3-3/8" Hand Socket(12-Point) (CR-Mo)	B-93	18375
877110	1" Dr. 3-7/16" Hand Socket(12-Point) (CR-Mo)	B-93	21500
877112	1" Dr. 3-1/2" Hand Socket(12-Point) (CR-Mo)	B-93	22315
877114	1" Dr. 3-9/16" Hand Socket(12-Point) (CR-Mo)	B-93	22315
877116	1" Dr. 3-5/8" Hand Socket(12-Point) (CR-Mo)	B-93	24900
877118	1" Dr. 3-11/16" Hand Socket(12-Point) (CR-Mo)	B-93	24900
877120	1" Dr. 3-3/4" Hand Socket(12-Point) (CR-Mo)	B-93	24900
880063	1" Dr. Sliding T-Handle, 630mmL (CR-Mo)	B-94	11000
880080	1" Dr. Sliding T-Handle, 750mmL (CR-Mo)	B-94	11110
8804	1/4" Hex Shank, M4 Triple Square Screwdriver Bit, 200mmL	D-14	450
8805	1/4" Hex Shank, M5 Triple Square Screwdriver Bit, 200mmL	D-14	450
8806	1/4" Hex Shank, M6 Triple Square Screwdriver Bit, 200mmL	D-14	450
880700F	1" Dr. Torque Wrench, 100 ~ 700 ft. lbs.	F-36	86500
8808	5/16" Hex Shank, M8 Triple Square Screwdriver Bit, 200mmL	D-14	600
880808	1" Dr. Universal Joint (CR-Mo)	B-94	5720
880846	1" Dr. Hinge Head (CR-Mo)	B-94	16940
880846E	1" Dr. Hinge Head with Tube Handle (CR-Mo)	B-94	20140
880872	1" Dr. Ratchet Head (CR-Mo)	B-94	16300
880872E	1" Dr. Ratchet Head with Tube Handle (CR-Mo)	B-94	19500
880888R	1" Dr. Ratchet Head with Tube Handle (CR-Mo)	B-94	21660
880980N	1" Dr. Torque Wrench, 140 ~ 980 Nm	F-36	86500
8810	10mm Hex Shank, M10 Triple Square Screwdriver Bit, 200mmL	D-14	800
881000F	1" Dr. Torque Wrench, 200 ~ 1000 ft. lbs.	F-36	110700
8812	12mm Hex Shank, M12 Triple Square Screwdriver Bit, 200mmL	D-14	1000
8814	14mm Hex Shank, M14 Triple Square Screwdriver Bit, 200mmL	D-14	1200
881500N	1" Dr. Torque Wrench, 300 ~ 1500 Nm	F-36	110700

Item No.	Description	Pg.	Code
8816	16mm Hex Shank, M16 Triple Square Screwdriver Bit, 200mmL	D-14	1400
8818	19mm Hex Shank, M18 Triple Square Screwdriver Bit, 200mmL	D-14	1600
887024	1" Dr. 3/4" Hand Socket (CR-Mo)	B-91	1420
887025	1" Dr. 25/32" Hand Socket (CR-Mo)	B-91	1420
887026	1" Dr. 13/16" Hand Socket (CR-Mo)	B-91	1420
887028	1" Dr. 7/8" Hand Socket (CR-Mo)	B-91	1420
887030	1" Dr. 15/16" Hand Socket (CR-Mo)	B-91	1420
887032	1" Dr. 1" Hand Socket (CR-Mo)	B-91	1420
887034	1" Dr. 1-1/16" Hand Socket (CR-Mo)	B-91	1420
887036	1" Dr. 1-1/8" Hand Socket (CR-Mo)	B-91	1420
887038	1" Dr. 1-3/16" Hand Socket (CR-Mo)	B-91	1420
887040	1" Dr. 1-1/4" Hand Socket (CR-Mo)	B-91	1525
887042	1" Dr. 1-5/16" Hand Socket (CR-Mo)	B-91	1575
887044	1" Dr. 1-3/8" Hand Socket (CR-Mo)	B-91	1680
887046	1" Dr. 1-7/16" Hand Socket (CR-Mo)	B-91	1680
887048	1" Dr. 1-1/2" Hand Socket (CR-Mo)	B-91	1785
887050	1" Dr. 1-9/16" Hand Socket (CR-Mo)	B-91	2100
887052	1" Dr. 1-5/8" Hand Socket (CR-Mo)	B-91	2100
887054	1" Dr. 1-11/16" Hand Socket (CR-Mo)	B-91	2365
887056	1" Dr. 1-3/4" Hand Socket (CR-Mo)	B-91	2365
887058	1" Dr. 1-13/16" Hand Socket (CR-Mo)	B-91	2365
887060	1" Dr. 1-7/8" Hand Socket (CR-Mo)	B-91	2625
887062	1" Dr. 1-15/16" Hand Socket (CR-Mo)	B-91	3150
887064	1" Dr. 2" Hand Socket (CR-Mo)	B-91	3150
887066	1" Dr. 2-1/16" Hand Socket (CR-Mo)	B-91	3415
887068	1" Dr. 2-1/8" Hand Socket (CR-Mo)	B-91	3415
887070	1" Dr. 2-3/16" Hand Socket (CR-Mo)	B-91	3570
887072	1" Dr. 2-1/4" Hand Socket (CR-Mo)	B-91	3675
887074	1" Dr. 2-5/16" Hand Socket (CR-Mo)	B-91	4200
887076	1" Dr. 2-3/8" Hand Socket (CR-Mo)	B-91	4465
887078	1" Dr. 2-7/16" Hand Socket (CR-Mo)	B-91	5250
887080	1" Dr. 2-1/2" Hand Socket (CR-Mo)	B-91	5250
887082	1" Dr. 2-9/16" Hand Socket (CR-Mo)	B-91	6300
887084	1" Dr. 2-5/8" Hand Socket (CR-Mo)	B-91	7875
887086	1" Dr. 2-11/16" Hand Socket (CR-Mo)	B-91	7875
887088	1" Dr. 2-3/4" Hand Socket (CR-Mo)	B-91	7875
887090	1" Dr. 2-13/16" Hand Socket (CR-Mo)	B-91	10500
887092	1" Dr. 2-7/8" Hand Socket (CR-Mo)	B-91	10500
887094	1" Dr. 2-15/16" Hand Socket (CR-Mo)	B-91	10500
887096	1" Dr. 3" Hand Socket (CR-Mo)	B-91	13125
887098	1" Dr. 3-1/16" Hand Socket (CR-Mo)	B-91	13125
887100	1" Dr. 3-1/8" Hand Socket (CR-Mo)	B-91	13125
887102	1" Dr. 3-3/16" Hand Socket (CR-Mo)	B-91	16800
887104	1" Dr. 3-1/4" Hand Socket (CR-Mo)	B-91	18375
887106	1" Dr. 3-5/16" Hand Socket (CR-Mo)	B-91	18375
887108	1" Dr. 3-3/8" Hand Socket (CR-Mo)	B-91	18375
887110	1" Dr. 3-7/16" Hand Socket (CR-Mo)	B-91	21500
887112	1" Dr. 3-1/2" Hand Socket (CR-Mo)	B-91	21500
887114	1" Dr. 3-9/16" Hand Socket (CR-Mo)	B-91	21500
887116	1" Dr. 3-5/8" Hand Socket (CR-Mo)	B-91	24900
887118	1" Dr. 3-11/16" Hand Socket (CR-Mo)	B-91	24900
887120	1" Dr. 3-3/4" Hand Socket (CR-Mo)	B-91	24900
887122	1" Dr. 3-13/16" Hand Socket (CR-Mo)	B-91	28800
887124	1" Dr. 3-7/8" Hand Socket (CR-Mo)	B-91	28800
887126	1" Dr. 3-15/16" Hand Socket (CR-Mo)	B-91	28800
887128	1" Dr. 4" Hand Socket (CR-Mo)	B-91	28800
887130	1" Dr. 4-1/16" Hand Socket (CR-Mo)	B-91	33200
887132	1" Dr. 4-1/8" Hand Socket (CR-Mo)	B-91	33200
887134	1" Dr. 4-3/16" Hand Socket (CR-Mo)	B-91	38300
887136	1" Dr. 4-1/4" Hand Socket (CR-Mo)	B-91	38300
887138	1" Dr. 4-5/16" Hand Socket (CR-Mo)	B-91	38300
887140	1" Dr. 4-3/8" Hand Socket (CR-Mo)	B-91	44000
887142	1" Dr. 4-7/16" Hand Socket (CR-Mo)	B-91	44000
887144	1" Dr. 4-1/2" Hand Socket (CR-Mo)	B-91	44000
887250	1" Dr. Torque Extension Bar, 250 ft.lbs.(340Nm)	J-13	9000
887350	1" Dr. Torque Extension Bar, 350 ft.lbs.(475Nm)	J-13	9000
887475	1" Dr. Torque Extension Bar, 475 ft.lbs.(645Nm)	J-13	9000
887650	1" Dr. Torque Extension Bar, 650 ft.lbs.(880Nm)	J-13	9000
8K1630	1" Dr. Air Impact Wrench, 1,200 ft. lbs. / 1,627 Nm	E-13	107900
8K1636	1" Dr. Long Anvil Air Impact Wrench, 1,200 ft. lbs. / 1,627 Nm	E-13	117700

Item No.	Description	Pg.	Code
8K3390	1" Dr. Air Impact Wrench, 2,500 ft. lbs. / 3,390 Nm	E-16	229000
8K3398	1" Dr. Long Anvil Air Impact Wrench, 2,500 ft. lbs. / 3,390 Nmm	E-16	238000
9			
9004	1/4" Hex Shank, M4 Ribe Screwdriver Bit, 30mmL	D-17	80
9005	1/4" Hex Shank, M5 Ribe Screwdriver Bit, 30mmL	D-17	80
9006	1/4" Hex Shank, M6 Ribe Screwdriver Bit, 30mmL	D-17	80
9007	5/16" Hex Shank, M7 Ribe Screwdriver Bit, 30mmL	D-17	120
9008	5/16" Hex Shank, M8 Ribe Screwdriver Bit, 30mmL	D-17	120
9009	10mm Hex Shank, M9 Ribe Screwdriver Bit, 30mmL	D-17	180
9010	10mm Hex Shank, M10 Ribe Screwdriver Bit, 30mmL	D-17	180
9012	12mm Hex Shank, M12 Ribe Screwdriver Bit, 30mmL	D-17	240
9013	14mm Hex Shank, M13 Ribe Screwdriver Bit, 30mmL	D-17	290
9014	14mm Hex Shank, M14 Ribe Screwdriver Bit, 30mmL	D-17	290
9016	16mm Hex Shank, M16 Ribe Screwdriver Bit, 30mmL	D-17	340
9054	1/4" Hex Shank, SP4 Spanner Screwdriver Bit, 30mmL	D-17	80
9056	1/4" Hex Shank, SP6 Spanner Screwdriver Bit, 30mmL	D-17	80
9058	1/4" Hex Shank, SP8 Spanner Screwdriver Bit, 30mmL	D-17	80
9060	1/4" Hex Shank, SP10 Spanner Screwdriver Bit, 30mmL	D-17	80
9062	1/4" Hex Shank, SP12 Spanner Screwdriver Bit, 30mmL	D-17	80
9064	1/4" Hex Shank, SP14 Spanner Screwdriver Bit, 30mmL	D-17	80
9100	1/4" Hex Shank, S# 0 Square Screwdriver Bit, 30mmL	D-15	60
9101	1/4" Hex Shank, S# 1 Square Screwdriver Bit, 30mmL	D-15	60
9102	1/4" Hex Shank, S# 2 Square Screwdriver Bit, 30mmL	D-15	60
9103	1/4" Hex Shank, S# 3 Square Screwdriver Bit, 30mmL	D-15	60
9104	1/4" Hex Shank, S# 4 Square Screwdriver Bit, 30mmL	D-15	60
920012	2-1/2" Dr. Impact Adapter, 2-1/2" F x 1-1/2" M (CR-Mo)	A-70	180000
920250	2-1/2" Dr. Impact Extension Bar, 250mmL (CR-Mo)	A-70	210000
920320	2-1/2" Dr. Impact Extension Bar, 320mmL (CR-Mo)	A-70	255000
9204	1/4" Hex Shank, M4 Ribe Screwdriver Bit, 56mmL	D-17	150
920460	2-1/2" Dr. 60mm Jumbo Impact Socket (CR-Mo)	A-70	93000
920463	2-1/2" Dr. 63mm Jumbo Impact Socket (CR-Mo)	A-70	93000
920465	2-1/2" Dr. 65mm Jumbo Impact Socket (CR-Mo)	A-70	93000
920470	2-1/2" Dr. 70mm Jumbo Impact Socket (CR-Mo)	A-70	93000
920475	2-1/2" Dr. 75mm Jumbo Impact Socket (CR-Mo)	A-70	93000
920480	2-1/2" Dr. 80mm Jumbo Impact Socket (CR-Mo)	A-70	93000
920485	2-1/2" Dr. 85mm Jumbo Impact Socket (CR-Mo)	A-70	94500
920490	2-1/2" Dr. 90mm Jumbo Impact Socket (CR-Mo)	A-70	97500
920495	2-1/2" Dr. 95mm Jumbo Impact Socket (CR-Mo)	A-70	108000
9205	1/4" Hex Shank, M5 Ribe Screwdriver Bit, 56mmL	D-17	150
920500	2-1/2" Dr. 100mm Jumbo Impact Socket (CR-Mo)	A-70	111000
920505	2-1/2" Dr. 105mm Jumbo Impact Socket (CR-Mo)	A-70	117000
920510	2-1/2" Dr. 110mm Jumbo Impact Socket (CR-Mo)	A-70	126000
920515	2-1/2" Dr. 115mm Jumbo Impact Socket (CR-Mo)	A-70	132000
920520	2-1/2" Dr. 120mm Jumbo Impact Socket (CR-Mo)	A-70	142500
920525	2-1/2" Dr. 125mm Jumbo Impact Socket (CR-Mo)	A-70	153000
920530	2-1/2" Dr. 130mm Jumbo Impact Socket (CR-Mo)	A-70	165000
920535	2-1/2" Dr. 135mm Jumbo Impact Socket (CR-Mo)	A-70	195000
920540	2-1/2" Dr. 140mm Jumbo Impact Socket (CR-Mo)	A-70	221400
920545	2-1/2" Dr. 145mm Jumbo Impact Socket (CR-Mo)	A-70	235500
920550	2-1/2" Dr. 150mm Jumbo Impact Socket (CR-Mo)	A-70	268500
920555	2-1/2" Dr. 155mm Jumbo Impact Socket (CR-Mo)	A-70	288000
920560	2-1/2" Dr. 160mm Jumbo Impact Socket (CR-Mo)	A-70	309000
920565	2-1/2" Dr. 165mm Jumbo Impact Socket (CR-Mo)	A-70	333600
920570	2-1/2" Dr. 170mm Jumbo Impact Socket (CR-Mo)	A-70	354000
920575	2-1/2" Dr. 175mm Jumbo Impact Socket (CR-Mo)	A-70	375000
920580	2-1/2" Dr. 180mm Jumbo Impact Socket (CR-Mo)	A-70	407100
920585	2-1/2" Dr. 185mm Jumbo Impact Socket (CR-Mo)	A-70	426000
920590	2-1/2" Dr. 190mm Jumbo Impact Socket (CR-Mo)	A-70	457500
920595	2-1/2" Dr. 195mm Jumbo Impact Socket (CR-Mo)	A-70	487500
9206	1/4" Hex Shank, M6 Ribe Screwdriver Bit, 56mmL	D-17	150
920600	2-1/2" Dr. 200mm Jumbo Impact Socket (CR-Mo)	A-70	517500
920605	2-1/2" Dr. 205mm Jumbo Impact Socket (CR-Mo)	A-70	544500

Item No.	Description	Pg.	Code
920610	2-1/2" Dr. 210mm Jumbo Impact Socket (CR-Mo)	A-70	571500
920615	2-1/2" Dr. 215mm Jumbo Impact Socket (CR-Mo)	A-70	597600
920620	2-1/2" Dr. 220mm Jumbo Impact Socket (CR-Mo)	A-70	616000
920625	2-1/2" Dr. 225mm Jumbo Impact Socket (CR-Mo)	A-70	634500
920630	2-1/2" Dr. 230mm Jumbo Impact Socket (CR-Mo)	A-70	659000
920635	2-1/2" Dr. 235mm Jumbo Impact Socket (CR-Mo)	A-70	684600
9207	5/16" Hex Shank, M7 Ribe Screwdriver Bit, 56mmL	D-17	200
920776	2-1/2" Dr. 2-3/8" Jumbo Impact Socket (CR-Mo)	A-71	99000
920778	2-1/2" Dr. 2-7/16" Jumbo Impact Socket (CR-Mo)	A-71	99000
920780	2-1/2" Dr. 2-1/2" Jumbo Impact Socket (CR-Mo)	A-71	99000
920782	2-1/2" Dr. 2-9/16" Jumbo Impact Socket (CR-Mo)	A-71	99000
920784	2-1/2" Dr. 2-5/8" Jumbo Impact Socket (CR-Mo)	A-71	99000
920786	2-1/2" Dr. 2-11/16" Jumbo Impact Socket (CR-Mo)	A-71	102000
920788	2-1/2" Dr. 2-3/4" Jumbo Impact Socket (CR-Mo)	A-71	105000
920790	2-1/2" Dr. 2-13/16" Jumbo Impact Socket (CR-Mo)	A-71	108000
920792	2-1/2" Dr. 2-7/8" Jumbo Impact Socket (CR-Mo)	A-71	111000
920794	2-1/2" Dr. 2-15/16" Jumbo Impact Socket (CR-Mo)	A-71	114000
920796	2-1/2" Dr. 3" Jumbo Impact Socket (CR-Mo)	A-71	117000
920798	2-1/2" Dr. 3-1/16" Jumbo Impact Socket (CR-Mo)	A-71	120000
9208	5/16" Hex Shank, M8 Ribe Screwdriver Bit, 56mmL	D-17	200
920800	2-1/2" Dr. 3-1/8" Jumbo Impact Socket (CR-Mo)	A-71	120000
920802	2-1/2" Dr. 3-3/16" Jumbo Impact Socket (CR-Mo)	A-71	120000
920804	2-1/2" Dr. 3-1/4" Jumbo Impact Socket (CR-Mo)	A-71	120000
920806	2-1/2" Dr. 3-5/16" Jumbo Impact Socket (CR-Mo)	A-71	120000
920808	2-1/2" Dr. 3-3/8" Jumbo Impact Socket (CR-Mo)	A-71	120000
920810	2-1/2" Dr. 3-7/16" Jumbo Impact Socket (CR-Mo)	A-71	123000
920812	2-1/2" Dr. 3-1/2" Jumbo Impact Socket (CR-Mo)	A-71	123000
920814	2-1/2" Dr. 3-9/16" Jumbo Impact Socket (CR-Mo)	A-71	123000
920816	2-1/2" Dr. 3-5/8" Jumbo Impact Socket (CR-Mo)	A-71	123000
920818	2-1/2" Dr. 3-11/16" Jumbo Impact Socket (CR-Mo)	A-71	123000
920820	2-1/2" Dr. 3-3/4" Jumbo Impact Socket (CR-Mo)	A-71	123000
920822	2-1/2" Dr. 3-13/16" Jumbo Impact Socket (CR-Mo)	A-71	126000
920824	2-1/2" Dr. 3-7/8" Jumbo Impact Socket (CR-Mo)	A-71	126000
920826	2-1/2" Dr. 3-15/16" Jumbo Impact Socket (CR-Mo)	A-71	126000
920828	2-1/2" Dr. 4" Jumbo Impact Socket (CR-Mo)	A-71	126000
920830	2-1/2" Dr. 4-1/16" Jumbo Impact Socket (CR-Mo)	A-71	129000
920832	2-1/2" Dr. 4-1/8" Jumbo Impact Socket (CR-Mo)	A-71	129000
920834	2-1/2" Dr. 4-3/16" Jumbo Impact Socket (CR-Mo)	A-71	132000
920836	2-1/2" Dr. 4-1/4" Jumbo Impact Socket (CR-Mo)	A-71	132000
920838	2-1/2" Dr. 4-5/16" Jumbo Impact Socket (CR-Mo)	A-71	138000
920840	2-1/2" Dr. 4-3/8" Jumbo Impact Socket (CR-Mo)	A-71	138000
920842	2-1/2" Dr. 4-7/16" Jumbo Impact Socket (CR-Mo)	A-71	138000
920844	2-1/2" Dr. 4-1/2" Jumbo Impact Socket (CR-Mo)	A-71	138000
920846	2-1/2" Dr. 4-9/16" Jumbo Impact Socket (CR-Mo)	A-71	141000
920848	2-1/2" Dr. 4-5/8" Jumbo Impact Socket (CR-Mo)	A-71	141000
920850	2-1/2" Dr. 4-11/16" Jumbo Impact Socket (CR-Mo)	A-71	145500
920852	2-1/2" Dr. 4-3/4" Jumbo Impact Socket (CR-Mo)	A-71	150000
920854	2-1/2" Dr. 4-13/16" Jumbo Impact Socket (CR-Mo)	A-71	154500
920856	2-1/2" Dr. 4-7/8" Jumbo Impact Socket (CR-Mo)	A-71	159000
920858	2-1/2" Dr. 4-15/16" Jumbo Impact Socket (CR-Mo)	A-71	162000
920860	2-1/2" Dr. 5" Jumbo Impact Socket (CR-Mo)	A-71	162000
920862	2-1/2" Dr. 5-1/16" Jumbo Impact Socket (CR-Mo)	A-71	172500
920864	2-1/2" Dr. 5-1/8" Jumbo Impact Socket (CR-Mo)	A-71	183000
920866	2-1/2" Dr. 5-3/16" Jumbo Impact Socket (CR-Mo)	A-71	193500
920868	2-1/2" Dr. 5-1/4" Jumbo Impact Socket (CR-Mo)	A-71	204000
920870	2-1/2" Dr. 5-5/16" Jumbo Impact Socket (CR-Mo)	A-71	215000
920872	2-1/2" Dr. 5-3/8" Jumbo Impact Socket (CR-Mo)	A-71	225000
920874	2-1/2" Dr. 5-7/16" Jumbo Impact Socket (CR-Mo)	A-71	233000
920876	2-1/2" Dr. 5-1/2" Jumbo Impact Socket (CR-Mo)	A-71	240000
920878	2-1/2" Dr. 5-9/16" Jumbo Impact Socket (CR-Mo)	A-71	252000
920880	2-1/2" Dr. 5-5/8" Jumbo Impact Socket (CR-Mo)	A-71	252000
920882	2-1/2" Dr. 5-11/16" Jumbo Impact Socket (CR-Mo)	A-71	255000
920884	2-1/2" Dr. 5-3/4" Jumbo Impact Socket (CR-Mo)	A-71	255000
920886	2-1/2" Dr. 5-13/16" Jumbo Impact Socket (CR-Mo)	A-71	261000
920888	2-1/2" Dr. 5-7/8" Jumbo Impact Socket (CR-Mo)	A-71	267000
920890	2-1/2" Dr. 5-15/16" Jumbo Impact Socket (CR-Mo)	A-71	273000
920892	2-1/2" Dr. 6" Jumbo Impact Socket (CR-Mo)	A-72	279000
920894	2-1/2" Dr. 6-1/16" Jumbo Impact Socket (CR-Mo)	A-72	286500
920896	2-1/2" Dr. 6-1/8" Jumbo Impact Socket (CR-Mo)	A-72	294000
920898	2-1/2" Dr. 6-3/16" Jumbo Impact Socket (CR-Mo)	A-72	307000

Item No.	Description	Pg.	Code
9209	10mm Hex Shank, M9 Ribe Screwdriver Bit, 56mmL	D-17	270
920900	2-1/2" Dr. 6-1/4" Jumbo Impact Socket (CR-Mo)	A-72	307000
920902	2-1/2" Dr. 6-5/16" Jumbo Impact Socket (CR-Mo)	A-72	319500
920904	2-1/2" Dr. 6-3/8" Jumbo Impact Socket (CR-Mo)	A-72	319500
920906	2-1/2" Dr. 6-7/16" Jumbo Impact Socket (CR-Mo)	A-72	332000
920908	2-1/2" Dr. 6-1/2" Jumbo Impact Socket (CR-Mo)	A-72	332000
920910	2-1/2" Dr. 6-9/16" Jumbo Impact Socket (CR-Mo)	A-72	345000
920912	2-1/2" Dr. 6-5/8" Jumbo Impact Socket (CR-Mo)	A-72	345000
920914	2-1/2" Dr. 6-11/16" Jumbo Impact Socket (CR-Mo)	A-72	357500
920916	2-1/2" Dr. 6-3/4" Jumbo Impact Socket (CR-Mo)	A-72	370000
920918	2-1/2" Dr. 6-13/16" Jumbo Impact Socket (CR-Mo)	A-72	382500
920920	2-1/2" Dr. 6-7/8" Jumbo Impact Socket (CR-Mo)	A-72	395000
920922	2-1/2" Dr. 6-15/16" Jumbo Impact Socket (CR-Mo)	A-72	407500
920924	2-1/2" Dr. 7" Jumbo Impact Socket (CR-Mo)	A-72	420000
920926	2-1/2" Dr. 7-1/16" Jumbo Impact Socket (CR-Mo)	A-72	428000
920928	2-1/2" Dr. 7-1/8" Jumbo Impact Socket (CR-Mo)	A-72	433000
920930	2-1/2" Dr. 7-3/16" Jumbo Impact Socket (CR-Mo)	A-72	440000
920932	2-1/2" Dr. 7-1/4" Jumbo Impact Socket (CR-Mo)	A-72	440000
920934	2-1/2" Dr. 7-5/16" Jumbo Impact Socket (CR-Mo)	A-72	448000
920936	2-1/2" Dr. 7-3/8" Jumbo Impact Socket (CR-Mo)	A-72	460000
920938	2-1/2" Dr. 7-7/16" Jumbo Impact Socket (CR-Mo)	A-72	473000
920940	2-1/2" Dr. 7-1/2" Jumbo Impact Socket (CR-Mo)	A-72	481000
920942	2-1/2" Dr. 7-9/16" Jumbo Impact Socket (CR-Mo)	A-72	493000
920944	2-1/2" Dr. 7-5/8" Jumbo Impact Socket (CR-Mo)	A-72	504000
920946	2-1/2" Dr. 7-11/16" Jumbo Impact Socket (CR-Mo)	A-72	512000
920948	2-1/2" Dr. 7-3/4" Jumbo Impact Socket (CR-Mo)	A-72	525000
920950	2-1/2" Dr. 7-13/16" Jumbo Impact Socket (CR-Mo)	A-72	538000
920952	2-1/2" Dr. 7-7/8" Jumbo Impact Socket (CR-Mo)	A-72	544000
920954	2-1/2" Dr. 7-15/16" Jumbo Impact Socket (CR-Mo)	A-72	555000
920956	2-1/2" Dr. 8" Jumbo Impact Socket (CR-Mo)	A-72	560000
920958	2-1/2" Dr. 8-1/16" Jumbo Impact Socket (CR-Mo)	A-72	572000
920960	2-1/2" Dr. 8-1/8" Jumbo Impact Socket (CR-Mo)	A-72	577000
920962	2-1/2" Dr. 8-3/16" Jumbo Impact Socket (CR-Mo)	A-72	588000
920964	2-1/2" Dr. 8-1/4" Jumbo Impact Socket (CR-Mo)	A-72	600000
920966	2-1/2" Dr. 8-5/16" Jumbo Impact Socket (CR-Mo)	A-72	606000
920968	2-1/2" Dr. 8-3/8" Jumbo Impact Socket (CR-Mo)	A-72	617000
920970	2-1/2" Dr. 8-7/16" Jumbo Impact Socket (CR-Mo)	A-72	628000
920972	2-1/2" Dr. 8-1/2" Jumbo Impact Socket (CR-Mo)	A-72	630000
920974	2-1/2" Dr. 8-9/16" Jumbo Impact Socket (CR-Mo)	A-72	641000
920976	2-1/2" Dr. 8-5/8" Jumbo Impact Socket (CR-Mo)	A-72	647000
920978	2-1/2" Dr. 8-11/16" Jumbo Impact Socket (CR-Mo)	A-72	651000
920980	2-1/2" Dr. 8-3/4" Jumbo Impact Socket (CR-Mo)	A-72	656000
920982	2-1/2" Dr. 8-13/16" Jumbo Impact Socket (CR-Mo)	A-72	663000
920984	2-1/2" Dr. 8-7/8" Jumbo Impact Socket (CR-Mo)	A-72	667000
920986	2-1/2" Dr. 8-15/16" Jumbo Impact Socket (CR-Mo)	A-72	677000
920988	2-1/2" Dr. 9" Jumbo Impact Socket (CR-Mo)	A-72	688000
920990	2-1/2" Dr. 9-1/16" Jumbo Impact Socket (CR-Mo)	A-72	692000
920992	2-1/2" Dr. 9-1/8" Jumbo Impact Socket (CR-Mo)	A-72	703000
920994	2-1/2" Dr. 9-3/16" Jumbo Impact Socket (CR-Mo)	A-72	709000
920996	2-1/2" Dr. 9-1/4" Jumbo Impact Socket (CR-Mo)	A-72	719000
9210	10mm Hex Shank, M10 Ribe Screwdriver Bit, 56mmL	D-17	270
9212	12mm Hex Shank, M12 Ribe Screwdriver Bit, 56mmL	D-17	340
9213	14mm Hex Shank, M13 Ribe Screwdriver Bit, 56mmL	D-17	410
9214	14mm Hex Shank, M14 Ribe Screwdriver Bit, 56mmL	D-17	410
9216	16mm Hex Shank, M16 Ribe Screwdriver Bit, 56mmL	D-17	500
9254	1/4" Hex Shank, SP4 Spanner Screwdriver Bit, 56mmL	D-17	150
9256	1/4" Hex Shank, SP6 Spanner Screwdriver Bit, 56mmL	D-17	150
9258	1/4" Hex Shank, SP8 Spanner Screwdriver Bit, 56mmL	D-17	150
9260	1/4" Hex Shank, SP10 Spanner Screwdriver Bit, 56mmL	D-17	150
9262	1/4" Hex Shank, SP12 Spanner Screwdriver Bit, 56mmL	D-17	150
9264	1/4" Hex Shank, SP14 Spanner Screwdriver Bit, 56mmL	D-17	150
928105	3-1/2" Dr. 105mm Jumbo Impact Socket (CR-Mo)	A-73	195000
928110	3-1/2" Dr. 110mm Jumbo Impact Socket (CR-Mo)	A-73	195000
928115	3-1/2" Dr. 115mm Jumbo Impact Socket (CR-Mo)	A-73	195000
928120	3-1/2" Dr. 120mm Jumbo Impact Socket (CR-Mo)	A-73	195000
928125	3-1/2" Dr. 125mm Jumbo Impact Socket (CR-Mo)	A-73	216000
928130	3-1/2" Dr. 130mm Jumbo Impact Socket (CR-Mo)	A-73	261000
928135	3-1/2" Dr. 135mm Jumbo Impact Socket (CR-Mo)	A-73	267000
928140	3-1/2" Dr. 140mm Jumbo Impact Socket (CR-Mo)	A-73	298800
928145	3-1/2" Dr. 145mm Jumbo Impact Socket (CR-Mo)	A-73	315000

Item No.	Description	Pg.	Code	Item No.	Description	Pg.	Code
928150	3-1/2" Dr. 150mm Jumbo Impact Socket (CR-Mo)	A-73	318000	928436	3-1/2" Dr. 7-3/8" Jumbo Impact Socket (CR-Mo)	A-75	540000
928155	3-1/2" Dr. 155mm Jumbo Impact Socket (CR-Mo)	A-73	345000	928438	3-1/2" Dr. 7-7/16" Jumbo Impact Socket (CR-Mo)	A-75	550000
928160	3-1/2" Dr. 160mm Jumbo Impact Socket (CR-Mo)	A-73	364500	928440	3-1/2" Dr. 7-1/2" Jumbo Impact Socket (CR-Mo)	A-75	566000
928165	3-1/2" Dr. 165mm Jumbo Impact Socket (CR-Mo)	A-73	393450	928442	3-1/2" Dr. 7-9/16" Jumbo Impact Socket (CR-Mo)	A-75	570000
928170	3-1/2" Dr. 170mm Jumbo Impact Socket (CR-Mo)	A-73	416400	928444	3-1/2" Dr. 7-5/8" Jumbo Impact Socket (CR-Mo)	A-75	590000
928175	3-1/2" Dr. 175mm Jumbo Impact Socket (CR-Mo)	A-73	442500	928446	3-1/2" Dr. 7-11/16" Jumbo Impact Socket (CR-Mo)	A-75	601000
928180	3-1/2" Dr. 180mm Jumbo Impact Socket (CR-Mo)	A-73	481500	928448	3-1/2" Dr. 7-3/4" Jumbo Impact Socket (CR-Mo)	A-75	610000
928185	3-1/2" Dr. 185mm Jumbo Impact Socket (CR-Mo)	A-73	501600	928450	3-1/2" Dr. 7-13/16" Jumbo Impact Socket (CR-Mo)	A-75	630000
928190	3-1/2" Dr. 190mm Jumbo Impact Socket (CR-Mo)	A-73	538500	928452	3-1/2" Dr. 7-7/8" Jumbo Impact Socket (CR-Mo)	A-75	642000
928195	3-1/2" Dr. 195mm Jumbo Impact Socket (CR-Mo)	A-73	574500	928454	3-1/2" Dr. 7-15/16" Jumbo Impact Socket (CR-Mo)	A-75	660000
928200	3-1/2" Dr. 200mm Jumbo Impact Socket (CR-Mo)	A-73	610500	928456	3-1/2" Dr. 8" Jumbo Impact Socket (CR-Mo)	A-75	670000
928205	3-1/2" Dr. 205mm Jumbo Impact Socket (CR-Mo)	A-73	642700	928458	3-1/2" Dr. 8-1/16" Jumbo Impact Socket (CR-Mo)	A-75	675000
928210	3-1/2" Dr. 210mm Jumbo Impact Socket (CR-Mo)	A-73	675000	928460	3-1/2" Dr. 8-1/8" Jumbo Impact Socket (CR-Mo)	A-75	690000
928215	3-1/2" Dr. 215mm Jumbo Impact Socket (CR-Mo)	A-73	705000	928462	3-1/2" Dr. 8-3/16" Jumbo Impact Socket (CR-Mo)	A-75	700000
928220	3-1/2" Dr. 220mm Jumbo Impact Socket (CR-Mo)	A-73	716000	928464	3-1/2" Dr. 8-1/4" Jumbo Impact Socket (CR-Mo)	A-75	709000
928225	3-1/2" Dr. 225mm Jumbo Impact Socket (CR-Mo)	A-73	727300	928466	3-1/2" Dr. 8-5/16" Jumbo Impact Socket (CR-Mo)	A-75	720000
928230	3-1/2" Dr. 230mm Jumbo Impact Socket (CR-Mo)	A-73	738500	928468	3-1/2" Dr. 8-3/8" Jumbo Impact Socket (CR-Mo)	A-75	730000
928235	3-1/2" Dr. 235mm Jumbo Impact Socket (CR-Mo)	A-73	750000	928470	3-1/2" Dr. 8-7/16" Jumbo Impact Socket (CR-Mo)	A-75	741000
928332	3-1/2" Dr. 4-1/8" Jumbo Impact Socket (CR-Mo)	A-72	210000	928472	3-1/2" Dr. 8-1/2" Jumbo Impact Socket (CR-Mo)	A-75	745000
928334	3-1/2" Dr. 4-3/16" Jumbo Impact Socket (CR-Mo)	A-72	210000	928474	3-1/2" Dr. 8-9/16" Jumbo Impact Socket (CR-Mo)	A-75	750000
928336	3-1/2" Dr. 4-1/4" Jumbo Impact Socket (CR-Mo)	A-72	210000	928476	3-1/2" Dr. 8-5/8" Jumbo Impact Socket (CR-Mo)	A-75	752000
928338	3-1/2" Dr. 4-5/16" Jumbo Impact Socket (CR-Mo)	A-72	210000	928478	3-1/2" Dr. 8-11/16" Jumbo Impact Socket (CR-Mo)	A-75	760000
928340	3-1/2" Dr. 4-3/8" Jumbo Impact Socket (CR-Mo)	A-72	210000	928480	3-1/2" Dr. 8-3/4" Jumbo Impact Socket (CR-Mo)	A-75	760000
928342	3-1/2" Dr. 4-7/16" Jumbo Impact Socket (CR-Mo)	A-72	210000	928482	3-1/2" Dr. 8-13/16" Jumbo Impact Socket (CR-Mo)	A-75	760000
928344	3-1/2" Dr. 4-1/2" Jumbo Impact Socket (CR-Mo)	A-72	210000	928484	3-1/2" Dr. 8-7/8" Jumbo Impact Socket (CR-Mo)	A-75	764000
928346	3-1/2" Dr. 4-9/16" Jumbo Impact Socket (CR-Mo)	A-72	210000	928486	3-1/2" Dr. 8-15/16" Jumbo Impact Socket (CR-Mo)	A-75	770000
928348	3-1/2" Dr. 4-5/8" Jumbo Impact Socket (CR-Mo)	A-72	210000	928488	3-1/2" Dr. 9" Jumbo Impact Socket (CR-Mo)	A-75	770000
928350	3-1/2" Dr. 4-11/16" Jumbo Impact Socket (CR-Mo)	A-72	210000	928490	3-1/2" Dr. 9-1/16" Jumbo Impact Socket (CR-Mo)	A-75	776000
928352	3-1/2" Dr. 4-3/4" Jumbo Impact Socket (CR-Mo)	A-72	210000	928492	3-1/2" Dr. 9-1/8" Jumbo Impact Socket (CR-Mo)	A-75	780000
928354	3-1/2" Dr. 4-13/16" Jumbo Impact Socket (CR-Mo)	A-72	222000	928494	3-1/2" Dr. 9-3/16" Jumbo Impact Socket (CR-Mo)	A-75	780000
928356	3-1/2" Dr. 4-7/8" Jumbo Impact Socket (CR-Mo)	A-72	234000	928496	3-1/2" Dr. 9-1/4" Jumbo Impact Socket (CR-Mo)	A-75	788000
928358	3-1/2" Dr. 4-15/16" Jumbo Impact Socket (CR-Mo)	A-72	257000	9300	1/4" Hex Shank, S# 0 Square Screwdriver Bit, 56mmL	D-15	120
928360	3-1/2" Jumbo Impact Socket (CR-Mo)	A-72	279000	9301	1/4" Hex Shank, S# 1 Square Screwdriver Bit, 56mmL	D-15	120
928362	3-1/2" Dr. 5-1/16" Jumbo Impact Socket (CR-Mo)	A-72	279000	9302	1/4" Hex Shank, S# 2 Square Screwdriver Bit, 56mmL	D-15	120
928364	3-1/2" Dr. 5-1/8" Jumbo Impact Socket (CR-Mo)	A-72	279000	9303	1/4" Hex Shank, S# 3 Square Screwdriver Bit, 56mmL	D-15	120
928366	3-1/2" Dr. 5-3/16" Jumbo Impact Socket (CR-Mo)	A-72	285000	9304	1/4" Hex Shank, S# 4 Square Screwdriver Bit, 56mmL	D-15	120
928368	3-1/2" Dr. 5-1/4" Jumbo Impact Socket (CR-Mo)	A-72	285000	938008	1-1/2" Dr. Impact Adapter w/pin hole, 1-1/2" F x 1" M (CR-Mo)	A-67	20000
928370	3-1/2" Dr. 5-5/16" Jumbo Impact Socket (CR-Mo)	A-72	300000	938008B	1-1/2" Dr. Impact Adapter w/steel ball, 1-1/2" F x 1" M (CR-Mo)	A-67	20000
928372	3-1/2" Dr. 5-3/8" Jumbo Impact Socket (CR-Mo)	A-72	315000	938020	1-1/2" Dr. Impact Adapter, 1-1/2" F x 2-1/2" M (CR-Mo)	A-67	66000
928374	3-1/2" Dr. 5-7/16" Jumbo Impact Socket (CR-Mo)	A-72	315000	938175	1-1/2" Dr. Impact Extension Bar, 150mmL (CR-Mo)	A-69	36000
928376	3-1/2" Dr. 5-1/2" Jumbo Impact Socket (CR-Mo)	A-72	315000	938250	1-1/2" Dr. Impact Extension Bar, 250mmL (CR-Mo)	A-69	51000
928378	3-1/2" Dr. 5-9/16" Jumbo Impact Socket (CR-Mo)	A-72	330000	938330	1-1/2" Dr. Impact Extension Bar, 330mmL (CR-Mo)	A-69	68000
928380	3-1/2" Dr. 5-5/8" Jumbo Impact Socket (CR-Mo)	A-72	330000	938441	1-1/2" Dr. 41mm Jumbo Impact Socket (CR-Mo)	A-66	18780
928382	3-1/2" Dr. 5-11/16" Jumbo Impact Socket (CR-Mo)	A-72	345000	938442	1-1/2" Dr. 42mm Jumbo Impact Socket (CR-Mo)	A-66	18780
928384	3-1/2" Dr. 5-3/4" Jumbo Impact Socket (CR-Mo)	A-74	360000	938443	1-1/2" Dr. 43mm Jumbo Impact Socket (CR-Mo)	A-66	18780
928386	3-1/2" Dr. 5-13/16" Jumbo Impact Socket (CR-Mo)	A-74	360000	938446	1-1/2" Dr. 46mm Jumbo Impact Socket (CR-Mo)	A-66	18780
928388	3-1/2" Dr. 5-7/8" Jumbo Impact Socket (CR-Mo)	A-74	360000	938450	1-1/2" Dr. 50mm Jumbo Impact Socket (CR-Mo)	A-66	18780
928390	3-1/2" Dr. 5-15/16" Jumbo Impact Socket (CR-Mo)	A-74	375000	938452	1-1/2" Dr. 52mm Jumbo Impact Socket (CR-Mo)	A-66	18780
928392	3-1/2" Dr. 6" Jumbo Impact Socket (CR-Mo)	A-74	375000	938454	1-1/2" Dr. 54mm Jumbo Impact Socket (CR-Mo)	A-66	20220
928394	3-1/2" Dr. 6-1/16" Jumbo Impact Socket (CR-Mo)	A-74	375000	938455	1-1/2" Dr. 55mm Jumbo Impact Socket (CR-Mo)	A-66	21440
928396	3-1/2" Dr. 6-1/8" Jumbo Impact Socket (CR-Mo)	A-74	375000	938458	1-1/2" Dr. 58mm Jumbo Impact Socket (CR-Mo)	A-66	24440
928398	3-1/2" Dr. 6-3/16" Jumbo Impact Socket (CR-Mo)	A-74	390000	938460	1-1/2" Dr. 60mm Jumbo Impact Socket (CR-Mo)	A-66	26000
928400	3-1/2" Dr. 6-1/4" Jumbo Impact Socket (CR-Mo)	A-74	390000	938463	1-1/2" Dr. 63mm Jumbo Impact Socket (CR-Mo)	A-66	27000
928402	3-1/2" Dr. 6-5/16" Jumbo Impact Socket (CR-Mo)	A-74	405000	938465	1-1/2" Dr. 65mm Jumbo Impact Socket (CR-Mo)	A-66	27000
928404	3-1/2" Dr. 6-3/8" Jumbo Impact Socket (CR-Mo)	A-74	405000	938470	1-1/2" Dr. 70mm Jumbo Impact Socket (CR-Mo)	A-66	31500
928406	3-1/2" Dr. 6-7/16" Jumbo Impact Socket (CR-Mo)	A-74	405000	938475	1-1/2" Dr. 75mm Jumbo Impact Socket (CR-Mo)	A-66	32000
928408	3-1/2" Dr. 6-1/2" Jumbo Impact Socket (CR-Mo)	A-74	405000	938480	1-1/2" Dr. 80mm Jumbo Impact Socket (CR-Mo)	A-66	39000
928410	3-1/2" Dr. 6-9/16" Jumbo Impact Socket (CR-Mo)	A-74	425000	938485	1-1/2" Dr. 85mm Jumbo Impact Socket (CR-Mo)	A-66	41500
928412	3-1/2" Dr. 6-5/8" Jumbo Impact Socket (CR-Mo)	A-74	444000	938490	1-1/2" Dr. 90mm Jumbo Impact Socket (CR-Mo)	A-66	45500
928414	3-1/2" Dr. 6-11/16" Jumbo Impact Socket (CR-Mo)	A-74	459000	938495	1-1/2" Dr. 95mm Jumbo Impact Socket (CR-Mo)	A-66	51000
928416	3-1/2" Dr. 6-3/4" Jumbo Impact Socket (CR-Mo)	A-74	474000	938500	1-1/2" Dr. 100mm Jumbo Impact Socket (CR-Mo)	A-66	60000
928418	3-1/2" Dr. 6-13/16" Jumbo Impact Socket (CR-Mo)	A-74	474000	938505	1-1/2" Dr. 105mm Jumbo Impact Socket (CR-Mo)	A-66	66000
928420	3-1/2" Dr. 6-7/8" Jumbo Impact Socket (CR-Mo)	A-74	474000	938510	1-1/2" Dr. 110mm Jumbo Impact Socket (CR-Mo)	A-66	68500
928422	3-1/2" Dr. 6-15/16" Jumbo Impact Socket (CR-Mo)	A-74	485000	938515	1-1/2" Dr. 115mm Jumbo Impact Socket (CR-Mo)	A-66	79000
928424	3-1/2" Dr. 7" Jumbo Impact Socket (CR-Mo)	A-75	495000	938520	1-1/2" Dr. 120mm Jumbo Impact Socket (CR-Mo)	A-66	86000
928426	3-1/2" Dr. 7-1/16" Jumbo Impact Socket (CR-Mo)	A-75	506000	938525	1-1/2" Dr. 125mm Jumbo Impact Socket (CR-Mo)	A-66	90000
928428	3-1/2" Dr. 7-1/8" Jumbo Impact Socket (CR-Mo)	A-75	515000	938530	1-1/2" Dr. 130mm Jumbo Impact Socket (CR-Mo)	A-66	126000
928430	3-1/2" Dr. 7-3/16" Jumbo Impact Socket (CR-Mo)	A-75	520000	938535	1-1/2" Dr. 135mm Jumbo Impact Socket (CR-Mo)	A-66	167000
928432	3-1/2" Dr. 7-1/4" Jumbo Impact Socket (CR-Mo)	A-75	525000	938540	1-1/2" Dr. 140mm Jumbo Impact Socket (CR-Mo)	A-66	203000
928434	3-1/2" Dr. 7-5/16" Jumbo Impact Socket (CR-Mo)	A-75	527000	938545	1-1/2" Dr. 145mm Jumbo Impact Socket (CR-Mo)	A-66	226000

Item No.	Description	Pg.	Code
938550	1-1/2" Dr. 150mm Jumbo Impact Socket (CR-Mo)	A-66	246000
938555	1-1/2" Dr. 155mm Jumbo Impact Socket (CR-Mo)	A-66	275000
938560	1-1/2" Dr. 160mm Jumbo Impact Socket (CR-Mo)	A-66	300000
938565	1-1/2" Dr. 165mm Jumbo Impact Socket (CR-Mo)	A-66	329000
938652	1-1/2" Dr. 1-5/8" Jumbo Impact Socket (CR-Mo)	A-66	18780
938654	1-1/2" Dr. 1-11/16" Jumbo Impact Socket (CR-Mo)	A-66	18780
938656	1-1/2" Dr. 1-3/4" Jumbo Impact Socket (CR-Mo)	A-66	18780
938658	1-1/2" Dr. 1-13/16" Jumbo Impact Socket (CR-Mo)	A-66	18780
938660	1-1/2" Dr. 1-7/8" Jumbo Impact Socket (CR-Mo)	A-66	18780
938662	1-1/2" Dr. 1-15/16" Jumbo Impact Socket (CR-Mo)	A-66	18780
938664	1-1/2" Dr. 2" Jumbo Impact Socket (CR-Mo)	A-66	18780
938666	1-1/2" Dr. 2-1/16" Jumbo Impact Socket (CR-Mo)	A-66	18780
938668	1-1/2" Dr. 2-1/8" Jumbo Impact Socket (CR-Mo)	A-66	20220
938670	1-1/2" Dr. 2-3/16" Jumbo Impact Socket (CR-Mo)	A-66	21440
938672	1-1/2" Dr. 2-1/4" Jumbo Impact Socket (CR-Mo)	A-66	22780
938674	1-1/2" Dr. 2-5/16" Jumbo Impact Socket (CR-Mo)	A-66	23000
938676	1-1/2" Dr. 2-3/8" Jumbo Impact Socket (CR-Mo)	A-66	26000
938678	1-1/2" Dr. 2-7/16" Jumbo Impact Socket (CR-Mo)	A-66	27110
938680	1-1/2" Dr. 2-1/2" Jumbo Impact Socket (CR-Mo)	A-66	27330
938682	1-1/2" Dr. 2-9/16" Jumbo Impact Socket (CR-Mo)	A-66	27330
938684	1-1/2" Dr. 2-5/8" Jumbo Impact Socket (CR-Mo)	A-66	28560
938686	1-1/2" Dr. 2-11/16" Jumbo Impact Socket (CR-Mo)	A-66	29500
938688	1-1/2" Dr. 2-3/4" Jumbo Impact Socket (CR-Mo)	A-66	31000
938690	1-1/2" Dr. 2-13/16" Jumbo Impact Socket (CR-Mo)	A-66	32500
938692	1-1/2" Dr. 2-7/8" Jumbo Impact Socket (CR-Mo)	A-66	32500
938694	1-1/2" Dr. 2-15/16" Jumbo Impact Socket (CR-Mo)	A-66	32500
938696	1-1/2" Dr. 3" Jumbo Impact Socket (CR-Mo)	A-66	34500
938698	1-1/2" Dr. 3-1/16" Jumbo Impact Socket (CR-Mo)	A-66	35000
938700	1-1/2" Dr. 3-1/8" Jumbo Impact Socket (CR-Mo)	A-66	37500
938702	1-1/2" Dr. 3-3/16" Jumbo Impact Socket (CR-Mo)	A-66	39500
938704	1-1/2" Dr. 3-1/4" Jumbo Impact Socket (CR-Mo)	A-66	40500
938706	1-1/2" Dr. 3-5/16" Jumbo Impact Socket (CR-Mo)	A-67	41500
938708	1-1/2" Dr. 3-3/8" Jumbo Impact Socket (CR-Mo)	A-67	42000
938710	1-1/2" Dr. 3-7/16" Jumbo Impact Socket (CR-Mo)	A-67	42000
938712	1-1/2" Dr. 3-1/2" Jumbo Impact Socket (CR-Mo)	A-67	43500
938714	1-1/2" Dr. 3-9/16" Jumbo Impact Socket (CR-Mo)	A-67	45500
938716	1-1/2" Dr. 3-5/8" Jumbo Impact Socket (CR-Mo)	A-67	46000
938718	1-1/2" Dr. 3-11/16" Jumbo Impact Socket (CR-Mo)	A-67	46500
938720	1-1/2" Dr. 3-3/4" Jumbo Impact Socket (CR-Mo)	A-67	51000
938722	1-1/2" Dr. 3-13/16" Jumbo Impact Socket (CR-Mo)	A-67	57000
938724	1-1/2" Dr. 3-7/8" Jumbo Impact Socket (CR-Mo)	A-67	58000
938726	1-1/2" Dr. 3-15/16" Jumbo Impact Socket (CR-Mo)	A-67	60000
938728	1-1/2" Dr. 4" Jumbo Impact Socket (CR-Mo)	A-67	61700
938730	1-1/2" Dr. 4-1/16" Jumbo Impact Socket (CR-Mo)	A-67	66000
938732	1-1/2" Dr. 4-1/8" Jumbo Impact Socket (CR-Mo)	A-67	66000
938734	1-1/2" Dr. 4-3/16" Jumbo Impact Socket (CR-Mo)	A-67	66000
938736	1-1/2" Dr. 4-1/4" Jumbo Impact Socket (CR-Mo)	A-67	66000
938738	1-1/2" Dr. 4-5/16" Jumbo Impact Socket (CR-Mo)	A-67	69000
938740	1-1/2" Dr. 4-3/8" Jumbo Impact Socket (CR-Mo)	A-67	78000
938742	1-1/2" Dr. 4-7/16" Jumbo Impact Socket (CR-Mo)	A-67	78000
938744	1-1/2" Dr. 4-1/2" Jumbo Impact Socket (CR-Mo)	A-67	79000
938746	1-1/2" Dr. 4-9/16" Jumbo Impact Socket (CR-Mo)	A-67	85000
938748	1-1/2" Dr. 4-5/8" Jumbo Impact Socket (CR-Mo)	A-67	86000
938750	1-1/2" Dr. 4-11/16" Jumbo Impact Socket (CR-Mo)	A-67	87000
938752	1-1/2" Dr. 4-3/4" Jumbo Impact Socket (CR-Mo)	A-67	90300
938754	1-1/2" Dr. 4-13/16" Jumbo Impact Socket (CR-Mo)	A-67	94500
938756	1-1/2" Dr. 4-7/8" Jumbo Impact Socket (CR-Mo)	A-67	94500
938758	1-1/2" Dr. 4-15/16" Jumbo Impact Socket (CR-Mo)	A-67	94500
938760	1-1/2" Dr. 5" Jumbo Impact Socket (CR-Mo)	A-67	113300
938762	1-1/2" Dr. 5-1/16" Jumbo Impact Socket (CR-Mo)	A-67	119000
938764	1-1/2" Dr. 5-1/8" Jumbo Impact Socket (CR-Mo)	A-67	133000
938766	1-1/2" Dr. 5-3/16" Jumbo Impact Socket (CR-Mo)	A-67	151000
938768	1-1/2" Dr. 5-1/4" Jumbo Impact Socket (CR-Mo)	A-67	159000
938770	1-1/2" Dr. 5-5/16" Jumbo Impact Socket (CR-Mo)	A-67	176000
938772	1-1/2" Dr. 5-3/8" Jumbo Impact Socket (CR-Mo)	A-67	181000
938774	1-1/2" Dr. 5-7/16" Jumbo Impact Socket (CR-Mo)	A-67	197000
938776	1-1/2" Dr. 5-1/2" Jumbo Impact Socket (CR-Mo)	A-67	214000
938778	1-1/2" Dr. 5-9/16" Jumbo Impact Socket (CR-Mo)	A-67	221000
938780	1-1/2" Dr. 5-5/8" Jumbo Impact Socket (CR-Mo)	A-67	226000
938782	1-1/2" Dr. 5-11/16" Jumbo Impact Socket (CR-Mo)	A-67	238000

Item No.	Description	Pg.	Code
938784	1-1/2" Dr. 5-3/4" Jumbo Impact Socket (CR-Mo)	A-67	242000
938786	1-1/2" Dr. 5-13/16" Jumbo Impact Socket (CR-Mo)	A-67	251000
938788	1-1/2" Dr. 5-7/8" Jumbo Impact Socket (CR-Mo)	A-67	258000
938790	1-1/2" Dr. 5-15/16" Jumbo Impact Socket (CR-Mo)	A-67	264000
938792	1-1/2" Dr. 6" Jumbo Impact Socket (CR-Mo)	A-67	270000
938794	1-1/2" Dr. 6-1/16" Jumbo Impact Socket (CR-Mo)	A-67	289000
938796	1-1/2" Dr. 6-1/8" Jumbo Impact Socket (CR-Mo)	A-67	293000
938798	1-1/2" Dr. 6-3/16" Jumbo Impact Socket (CR-Mo)	A-67	300000
938800	1-1/2" Dr. 6-1/4" Jumbo Impact Socket (CR-Mo)	A-67	310000
938802	1-1/2" Dr. 6-5/16" Jumbo Impact Socket (CR-Mo)	A-67	316000
938804	1-1/2" Dr. 6-3/8" Jumbo Impact Socket (CR-Mo)	A-67	327000
938806	1-1/2" Dr. 6-7/16" Jumbo Impact Socket (CR-Mo)	A-67	340000
938808	1-1/2" Dr. 6-1/2" Jumbo Impact Socket (CR-Mo)	A-67	346000
939441	1-1/2" Dr. 41mm Deep Jumbo Impact Socket (CR-Mo)	A-68	28170
939442	1-1/2" Dr. 42mm Deep Jumbo Impact Socket (CR-Mo)	A-68	28170
939443	1-1/2" Dr. 43mm Deep Jumbo Impact Socket (CR-Mo)	A-68	28170
939446	1-1/2" Dr. 46mm Deep Jumbo Impact Socket (CR-Mo)	A-68	29060
939450	1-1/2" Dr. 50mm Deep Jumbo Impact Socket (CR-Mo)	A-68	31300
939452	1-1/2" Dr. 52mm Deep Jumbo Impact Socket (CR-Mo)	A-68	31300
939454	1-1/2" Dr. 54mm Deep Jumbo Impact Socket (CR-Mo)	A-68	33700
939455	1-1/2" Dr. 55mm Deep Jumbo Impact Socket (CR-Mo)	A-68	35730
939458	1-1/2" Dr. 58mm Deep Jumbo Impact Socket (CR-Mo)	A-68	40730
939460	1-1/2" Dr. 60mm Deep Jumbo Impact Socket (CR-Mo)	A-68	43330
939463	1-1/2" Dr. 63mm Deep Jumbo Impact Socket (CR-Mo)	A-68	43330
939465	1-1/2" Dr. 65mm Deep Jumbo Impact Socket (CR-Mo)	A-68	43330
939470	1-1/2" Dr. 70mm Deep Jumbo Impact Socket (CR-Mo)	A-68	47250
939475	1-1/2" Dr. 75mm Deep Jumbo Impact Socket (CR-Mo)	A-68	50400
939480	1-1/2" Dr. 80mm Deep Jumbo Impact Socket (CR-Mo)	A-68	60270
939485	1-1/2" Dr. 85mm Deep Jumbo Impact Socket (CR-Mo)	A-68	64140
939490	1-1/2" Dr. 90mm Deep Jumbo Impact Socket (CR-Mo)	A-68	73130
939495	1-1/2" Dr. 95mm Deep Jumbo Impact Socket (CR-Mo)	A-68	81960
939500	1-1/2" Dr. 100mm Deep Jumbo Impact Socket (CR-Mo)	A-68	99130
939505	1-1/2" Dr. 105mm Deep Jumbo Impact Socket (CR-Mo)	A-68	104500
939510	1-1/2" Dr. 110mm Deep Jumbo Impact Socket (CR-Mo)	A-68	110480
939515	1-1/2" Dr. 115mm Deep Jumbo Impact Socket (CR-Mo)	A-68	123440
939520	1-1/2" Dr. 120mm Deep Jumbo Impact Socket (CR-Mo)	A-68	136820
939525	1-1/2" Dr. 125mm Deep Jumbo Impact Socket (CR-Mo)	A-68	138970
939530	1-1/2" Dr. 130mm Deep Jumbo Impact Socket (CR-Mo)	A-68	174000
939535	1-1/2" Dr. 135mm Deep Jumbo Impact Socket (CR-Mo)	A-68	228000
939540	1-1/2" Dr. 140mm Deep Jumbo Impact Socket (CR-Mo)	A-68	269000
939545	1-1/2" Dr. 145mm Deep Jumbo Impact Socket (CR-Mo)	A-68	293000
939550	1-1/2" Dr. 150mm Deep Jumbo Impact Socket (CR-Mo)	A-68	310000
939555	1-1/2" Dr. 155mm Deep Jumbo Impact Socket (CR-Mo)	A-68	350000
939560	1-1/2" Dr. 160mm Deep Jumbo Impact Socket (CR-Mo)	A-68	375000
939565	1-1/2" Dr. 165mm Deep Jumbo Impact Socket (CR-Mo)	A-68	403000
939652	1-1/2" Dr. 1-5/8" Deep Jumbo Impact Socket (CR-Mo)	A-68	28170
939654	1-1/2" Dr. 1-11/16" Deep Jumbo Impact Socket (CR-Mo)	A-68	28170
939656	1-1/2" Dr. 1-3/4" Deep Jumbo Impact Socket (CR-Mo)	A-68	28170
939658	1-1/2" Dr. 1-13/16" Deep Jumbo Impact Socket (CR-Mo)	A-68	29060
939660	1-1/2" Dr. 1-7/8" Deep Jumbo Impact Socket (CR-Mo)	A-68	29060
939662	1-1/2" Dr. 1-15/16" Deep Jumbo Impact Socket (CR-Mo)	A-68	29060
939664	1-1/2" Dr. 2" Deep Jumbo Impact Socket (CR-Mo)	A-68	31300
939666	1-1/2" Dr. 2-1/16" Deep Jumbo Impact Socket (CR-Mo)	A-68	31300
939668	1-1/2" Dr. 2-1/8" Deep Jumbo Impact Socket (CR-Mo)	A-68	33700
939670	1-1/2" Dr. 2-3/16" Deep Jumbo Impact Socket (CR-Mo)	A-68	35730
939672	1-1/2" Dr. 2-1/4" Deep Jumbo Impact Socket (CR-Mo)	A-68	37970
939674	1-1/2" Dr. 2-5/16" Deep Jumbo Impact Socket (CR-Mo)	A-68	38330
939676	1-1/2" Dr. 2-3/8" Deep Jumbo Impact Socket (CR-Mo)	A-68	43330
939678	1-1/2" Dr. 2-7/16" Deep Jumbo Impact Socket (CR-Mo)	A-68	43330
939680	1-1/2" Dr. 2-1/2" Deep Jumbo Impact Socket (CR-Mo)	A-68	43330
939682	1-1/2" Dr. 2-9/16" Deep Jumbo Impact Socket (CR-Mo)	A-68	43330
939684	1-1/2" Dr. 2-5/8" Deep Jumbo Impact Socket (CR-Mo)	A-68	43330
939686	1-1/2" Dr. 2-11/16" Deep Jumbo Impact Socket (CR-Mo)	A-68	44250
939688	1-1/2" Dr. 2-3/4" Deep Jumbo Impact Socket (CR-Mo)	A-68	46500
939690	1-1/2" Dr. 2-13/16" Deep Jumbo Impact Socket (CR-Mo)	A-68	49520
939692	1-1/2" Dr. 2-7/8" Deep Jumbo Impact Socket (CR-Mo)	A-68	49520
939694	1-1/2" Dr. 2-15/16" Deep Jumbo Impact Socket (CR-Mo)	A-68	49520
939696	1-1/2" Dr. 3" Deep Jumbo Impact Socket (CR-Mo)	A-68	55860
939698	1-1/2" Dr. 3-1/16" Deep Jumbo Impact Socket (CR-Mo)	A-68	56670
939700	1-1/2" Dr. 3-1/8" Deep Jumbo Impact Socket (CR-Mo)	A-68	57950



Item No.	Description	Pg.	Code	Item No.	Description	Pg.	Code
939702	1-1/2" Dr. 3-3/16" Deep Jumbo Impact Socket (CR-Mo)	A-68	61050	941+3055	1-1/2" Dr. 55mm Hex Bit Socket, 125mmL	C-16	22840
939704	1-1/2" Dr. 3-1/4" Deep Jumbo Impact Socket (CR-Mo)	A-68	62590	941+3060	1-1/2" Dr. 60mm Hex Bit Socket, 130mmL	C-16	23420
939706	1-1/2" Dr. 3-5/16" Deep Jumbo Impact Socket (CR-Mo)	A-69	64140	9410	10mm Hex Shank, M10 Ribe Screwdriver Bit, 88mmL	D-17	480
939708	1-1/2" Dr. 3-3/8" Deep Jumbo Impact Socket (CR-Mo)	A-69	64910	9412	12mm Hex Shank, M12 Ribe Screwdriver Bit, 88mmL	D-17	650
939710	1-1/2" Dr. 3-7/16" Deep Jumbo Impact Socket (CR-Mo)	A-69	64910	9413	14mm Hex Shank, M13 Ribe Screwdriver Bit, 88mmL	D-17	820
939712	1-1/2" Dr. 3-1/2" Deep Jumbo Impact Socket (CR-Mo)	A-69	69910	9414	14mm Hex Shank, M14 Ribe Screwdriver Bit, 88mmL	D-17	820
939714	1-1/2" Dr. 3-9/16" Deep Jumbo Impact Socket (CR-Mo)	A-69	69910	9416	16mm Hex Shank, M16 Ribe Screwdriver Bit, 88mmL	D-17	930
939716	1-1/2" Dr. 3-5/8" Deep Jumbo Impact Socket (CR-Mo)	A-69	73930	943000	1-1/2" Dr. Air Impact Wrench, 3,000 ft. lbs. / 4,068 Nm	E-18	219500
939718	1-1/2" Dr. 3-11/16" Deep Jumbo Impact Socket (CR-Mo)	A-69	74730	943008	1-1/2" Dr. Long Anvil Air Impact Wrench, 3,000 ft. lbs. / 4,068 Nm	E-18	263300
939720	1-1/2" Dr. 3-3/4" Deep Jumbo Impact Socket (CR-Mo)	A-69	81960	9500	1/4" Hex Shank, S# 0 Square Screwdriver Bit, 88mmL	D-15	260
939722	1-1/2" Dr. 3-13/16" Deep Jumbo Impact Socket (CR-Mo)	A-69	94170	9501	1/4" Hex Shank, S# 1 Square Screwdriver Bit, 88mmL	D-15	260
939724	1-1/2" Dr. 3-7/8" Deep Jumbo Impact Socket (CR-Mo)	A-69	95830	9502	1/4" Hex Shank, S# 2 Square Screwdriver Bit, 88mmL	D-15	260
939726	1-1/2" Dr. 3-15/16" Deep Jumbo Impact Socket (CR-Mo)	A-69	99130	9503	1/4" Hex Shank, S# 3 Square Screwdriver Bit, 88mmL	D-15	260
939728	1-1/2" Dr. 4" Deep Jumbo Impact Socket (CR-Mo)	A-69	99130	9504	1/4" Hex Shank, S# 4 Square Screwdriver Bit, 88mmL	D-15	260
939730	1-1/2" Dr. 4-1/16" Deep Jumbo Impact Socket (CR-Mo)	A-69	104500	9600	1/4" Hex Shank, S# 0 Square Screwdriver Bit, 125mmL	D-15	300
939732	1-1/2" Dr. 4-1/8" Deep Jumbo Impact Socket (CR-Mo)	A-69	104500	9601	1/4" Hex Shank, S# 1 Square Screwdriver Bit, 125mmL	D-15	300
939734	1-1/2" Dr. 4-3/16" Deep Jumbo Impact Socket (CR-Mo)	A-69	104500	9602	1/4" Hex Shank, S# 2 Square Screwdriver Bit, 125mmL	D-15	300
939736	1-1/2" Dr. 4-1/4" Deep Jumbo Impact Socket (CR-Mo)	A-69	104500	9603	1/4" Hex Shank, S# 3 Square Screwdriver Bit, 125mmL	D-15	300
939738	1-1/2" Dr. 4-5/16" Deep Jumbo Impact Socket (CR-Mo)	A-69	111290	9604	1/4" Hex Shank, S# 4 Square Screwdriver Bit, 125mmL	D-15	300
939740	1-1/2" Dr. 4-3/8" Deep Jumbo Impact Socket (CR-Mo)	A-69	125810	9700	1/4" Hex Shank, S# 0 Square Screwdriver Bit, 160mmL	D-15	380
939742	1-1/2" Dr. 4-7/16" Deep Jumbo Impact Socket (CR-Mo)	A-69	125810	9701	1/4" Hex Shank, S# 1 Square Screwdriver Bit, 160mmL	D-15	380
939744	1-1/2" Dr. 4-1/2" Deep Jumbo Impact Socket (CR-Mo)	A-69	125810	9702	1/4" Hex Shank, S# 2 Square Screwdriver Bit, 160mmL	D-15	380
939746	1-1/2" Dr. 4-9/16" Deep Jumbo Impact Socket (CR-Mo)	A-69	132810	9703	1/4" Hex Shank, S# 3 Square Screwdriver Bit, 160mmL	D-15	380
939748	1-1/2" Dr. 4-5/8" Deep Jumbo Impact Socket (CR-Mo)	A-69	132810	9704	1/4" Hex Shank, S# 4 Square Screwdriver Bit, 160mmL	D-15	380
939750	1-1/2" Dr. 4-11/16" Deep Jumbo Impact Socket (CR-Mo)	A-69	132810	9800	1/4" Hex Shank, S# 0 Square Screwdriver Bit, 200mmL	D-15	450
939752	1-1/2" Dr. 4-3/4" Deep Jumbo Impact Socket (CR-Mo)	A-69	144000	980090	1-1/2" Dr. Sliding T-Handle	A-69	25000
939754	1-1/2" Dr. 4-13/16" Deep Jumbo Impact Socket (CR-Mo)	A-69	145000	9801	1/4" Hex Shank, S# 1 Square Screwdriver Bit, 200mmL	D-15	450
939756	1-1/2" Dr. 4-7/8" Deep Jumbo Impact Socket (CR-Mo)	A-69	146000	9802	1/4" Hex Shank, S# 2 Square Screwdriver Bit, 200mmL	D-15	450
939758	1-1/2" Dr. 4-15/16" Deep Jumbo Impact Socket (CR-Mo)	A-69	146000	9803	1/4" Hex Shank, S# 3 Square Screwdriver Bit, 200mmL	D-15	450
939760	1-1/2" Dr. 5" Deep Jumbo Impact Socket (CR-Mo)	A-69	161000	9804	1/4" Hex Shank, S# 4 Square Screwdriver Bit, 200mmL	D-15	450
939762	1-1/2" Dr. 5-1/16" Deep Jumbo Impact Socket (CR-Mo)	A-69	169000	9916	19mm Hex Shank, M16 Triple Square Impact Screwdriver Bit, 60mmL	D-20	800
939764	1-1/2" Dr. 5-1/8" Deep Jumbo Impact Socket (CR-Mo)	A-69	183000	9918	19mm Hex Shank, M18 Triple Square Impact Screwdriver Bit, 60mmL	D-20	800
939766	1-1/2" Dr. 5-3/16" Deep Jumbo Impact Socket (CR-Mo)	A-69	208000	9K3390	1-1/2" Dr. Air Impact Wrench, 2,500 ft. lbs. / 3,390 Nm	E-17	290000
939768	1-1/2" Dr. 5-1/4" Deep Jumbo Impact Socket (CR-Mo)	A-69	219000	9K3398	1-1/2" Dr. Long Anvil Air Impact Wrench, 2,500 ft. lbs. / 3,390 Nm	E-17	348000
939770	1-1/2" Dr. 5-5/16" Deep Jumbo Impact Socket (CR-Mo)	A-69	240000	9K4070	1-1/2" Dr. Air Impact Wrench, 3,000 ft. lbs. / 4,070 Nm	E-17	386000
939772	1-1/2" Dr. 5-3/8" Deep Jumbo Impact Socket (CR-Mo)	A-69	249000	9K4078	1-1/2" Dr. Long Anvil Air Impact Wrench, 3,000 ft. lbs. / 4,070 Nm	E-17	444000
939774	1-1/2" Dr. 5-7/16" Deep Jumbo Impact Socket (CR-Mo)	A-69	266000				
939776	1-1/2" Dr. 5-1/2" Deep Jumbo Impact Socket (CR-Mo)	A-69	283000				
939778	1-1/2" Dr. 5-9/16" Deep Jumbo Impact Socket (CR-Mo)	A-69	292000				
939780	1-1/2" Dr. 5-5/8" Deep Jumbo Impact Socket (CR-Mo)	A-69	298000				
939782	1-1/2" Dr. 5-11/16" Deep Jumbo Impact Socket (CR-Mo)	A-69	308000				
939784	1-1/2" Dr. 5-3/4" Deep Jumbo Impact Socket (CR-Mo)	A-69	310000				
939786	1-1/2" Dr. 5-13/16" Deep Jumbo Impact Socket (CR-Mo)	A-69	318000				
939788	1-1/2" Dr. 5-7/8" Deep Jumbo Impact Socket (CR-Mo)	A-69	326000				
939790	1-1/2" Dr. 5-15/16" Deep Jumbo Impact Socket (CR-Mo)	A-69	334000				
939792	1-1/2" Dr. 6" Deep Jumbo Impact Socket (CR-Mo)	A-69	343000				
939794	1-1/2" Dr. 6-1/16" Deep Jumbo Impact Socket (CR-Mo)	A-69	368000				
939796	1-1/2" Dr. 6-1/8" Deep Jumbo Impact Socket (CR-Mo)	A-69	373000				
939798	1-1/2" Dr. 6-3/16" Deep Jumbo Impact Socket (CR-Mo)	A-69	378000				
939800	1-1/2" Dr. 6-1/4" Deep Jumbo Impact Socket (CR-Mo)	A-69	389000				
939802	1-1/2" Dr. 6-5/16" Deep Jumbo Impact Socket (CR-Mo)	A-69	394000				
939804	1-1/2" Dr. 6-3/8" Deep Jumbo Impact Socket (CR-Mo)	A-69	403000				
939806	1-1/2" Dr. 6-7/16" Deep Jumbo Impact Socket (CR-Mo)	A-69	417000				
939808	1-1/2" Dr. 6-1/2" Deep Jumbo Impact Socket (CR-Mo)	A-69	424000				
9404	1/4" Hex Shank, M4 Ribe Screwdriver Bit, 88mmL	D-17	320				
9405	1/4" Hex Shank, M5 Ribe Screwdriver Bit, 88mmL	D-17	320				
9406	1/4" Hex Shank, M6 Ribe Screwdriver Bit, 88mmL	D-17	320				
9407	5/16" Hex Shank, M7 Ribe Screwdriver Bit, 88mmL	D-17	360				
9408	5/16" Hex Shank, M8 Ribe Screwdriver Bit, 88mmL	D-17	360				
9409	10mm Hex Shank, M9 Ribe Screwdriver Bit, 88mmL	D-17	480				
940909	1-1/2" Dr. Impact Universal Joint (CR-Mo)	A-67	17500				
941+	1-1/2" Dr. 41mm Hex Shank Impact Bit Holder, 80mmL	D-20	19600				
941+3027	1-1/2" Dr. 27mm Hex Bit Socket, 110mmL	C-16	21500				
941+3030	1-1/2" Dr. 30mm Hex Bit Socket, 110mmL	C-16	21500				
941+3032	1-1/2" Dr. 32mm Hex Bit Socket, 110mmL	C-16	21500				
941+3036	1-1/2" Dr. 36mm Hex Bit Socket, 110mmL	C-16	21500				
941+3038	1-1/2" Dr. 38mm Hex Bit Socket, 110mmL	C-16	21500				
941+3041	1-1/2" Dr. 41mm Hex Bit Socket, 115mmL	C-16	21500				
941+3046	1-1/2" Dr. 46mm Hex Bit Socket, 115mmL	C-16	21970				
941+3050	1-1/2" Dr. 50mm Hex Bit Socket, 120mmL	C-16	22370				

Item No.	Description	Pg.	Code
<b>A</b>			
AC-23117	117pc 1/4" & 3/8" Dr. Metric & SAE Tool Set	B-76	21000
AC-2331	31pc 1/4" & 3/8" Dr. Hand Accessory Display Board	H-64	29735
AC-234125	125pc 1/4", 3/8" & 1/2" Dr. Metric Tool Set	B-76	25500
AC-234151	151pc 1/4", 3/8" & 1/2" Dr. Metric & SAE Master Set	B-77	42000
AC-2487	87pc 1/4" & 1/2" Dr. Metric Master Tool Set	B-74	17500
AC-2487A	87pc 1/4" & 1/2" Dr. Metric Master Tool Set	B-75	20430
AC-359	59pc 3/8" Dr. Metric Hand Socket & Bit Set (12-Point)	B-34	11000
AC-359A	59pc 3/8" Dr. Metric Hand Socket & Bit Set	B-35	11000
AC-417	17pc 1/2" Dr. Hand Accessory Display Board	H-65	26545
AC-612	12pc 3/4" Dr. Hand Accessory Display Board	H-66	47875
AF-3406	6pc Air File Set	E-25	27000
AJ-1062	Short & long Nozzle Air Blow Gun	E-29	2840
AJ-106L	Long Nozzle Air Blow Gun	E-29	2740
AJ-106S	Short Nozzle Air Blow Gun	E-29	2740
AT-08	10pc Disc Brake Caliper Tool Set	J-3	12990
AT-09	9pc Valve Spring Compressor Set	J-3	6890
AT-0914	14pc Ball Joint Adapter Set	J-4	23700
AT-3500	Oil Suction Gun	K-3	2470
AT-46012	Grease Gun	K-3	4000
AT-4808	8pc Inner Tie Rod Tool Set	J-3	8000
AT-7207	7pc Ball Joint Removal & Installing Set	J-2	21000
AT-B01	Three-Legged Oli Filter Wrench, capacity: 3" ~ 5" (75mm ~ 125mm)	J-7	2400
AT-B16	Telescoping Magnetic Pick-Up Tool	K-3	1550
AT-B24	Flexible Magnetic Pick-Up Tool	K-3	2000
AT-BC08	11pc Brake Piston Wind Back Set	J-2	13800
AT-BC18	18pc Master Universal Caliper Wind Back Set	J-2	16600
AT-BOF2	Swivel Handle Oil Filter Wrench, 60~73mm	J-7	1400
AT-BOF3	Swivel Handle Oil Filter Wrench, 73~85mm	J-7	1400
AT-BOF4	Swivel Handle Oil Filter Wrench, 85~95mm	J-7	1470
AT-BOF5	Swivel Handle Oil Filter Wrench, 95~100mm	J-7	1470
AT-BSP	Brake Spring Pliers	J-9	2100
AT-BW08	8pc Belt Tensioning Wrench Set	J-5	7300
AT-BW15	15pc Belt Tensioning Wrench Set	J-5	11300
AT-EX5	5pc Screw Extractor Set	J-8	1530
AT-EX6	6pc Screw Extractor Set	J-8	860
AT-HC10	Heater Hose Clamp Pliers	J-10	1790
AT-HC12	Heater Hose Clamp Pliers	J-10	1790
AT-HC14	Heater Hose Clamp Pliers	J-10	1790
AT-HC16	Heater Hose Clamp Pliers	J-10	2500
AT-OF10	Heavy Duty Oli Filter Pliers, 60~90mm	J-7	1980
AT-OF10A	Locking Chain Pliers, 460mmL	G-6	3000
AT-OF12	Heavy Duty Oli Filter Pliers, 50~115mm	J-7	2100
AT-PU22	Magnetic Pick-Up Tool	K-3	920
AT-PU33	Flexible Magnetic Pick-Up Tool	K-3	1760
AT-RM14	50mm Diameter Hinged Mirror	K-3	1440
AT-RM15	50mm x 90mm Hinged Mirror	K-3	1440
AT-SC230	2pc Spring Compressor Set	J-4	4960
AT-TPR	Trim Pad Remover	J-9	1190
<b>B</b>			
BE-22406	3pc 1/4" Dr. Wobble Extension Bar Set	B-7	1180
BE-2343	3pc Spinner Handle Set	D-22	770
BE-2343A	3pc Spinner Handle Set (for Electric Drill)	D-22	770
BE-2343P	3pc Spinner Handle Set (for Electric Drill)	D-22	770
BE-2349	9pc 1/4", 3/8" & 1/2" Dr. Wobble Extension Bar Set	H-24	5260
BE-32306	3pc 3/8" Dr. Wobble Extension Bar Set	B-24	1570
BE-42305	3pc 1/2" Dr. Wobble Extension Bar Set	B-46	2140
BE-42510	3pc 1/2" Dr. Wobble Extension Bar Set	B-47	2790
BS-206S	6pc 1/4" Dr. Spanner Bit Socket Set	C-22	1740
BS-207L	7pc 1/4" Dr. Slotted & Philips Bit Socket Set	C-33	2770
BS-207S	7pc 1/4" Dr. Slotted & Philips Bit Socket Set	C-33	1480
BS-214PL	14pc 1/4" Dr. Slotted & Philips Bit Socket Set	C-17	4500
BS-2307TL	7pc 1/4" & 3/8" Dr. Triple Square Bit Socket Set	C-47	3850
BS-2307TS	7pc 1/4" & 3/8" Dr. Triple Square Bit Socket Set	C-47	2200
BS-2308SR	8pc 1/4" & 3/8" Dr. SAE Wobble Hex Bit Socket Set	C-39	2240
BS-2308SW	8pc 1/4" & 3/8" Dr. SAE Wobble Hex Bit Socket Set	C-39	3150
BS-2308WH	8pc 1/4" & 3/8" Dr. Metric Wobble Hex Bit Socket Set	C-38	3490
BS-2308WR	8pc 1/4" & 3/8" Dr. Metric Wobble Hex Bit Socket Set	C-38	2400
BS-2310S	10pc 1/4" & 3/8" Dr. Ribe Bit Socket Set	C-32	4750

Item No.	Description	Pg.	Code
BS-2311P	11pc 1/4" & 3/8" Dr. Pentacle Bit Socket Set	C-31	3560
BS-2312H	12pc 1/4" & 3/8" Dr. Metric Hex Bit Socket Set	C-34	3440
BS-2312HL	12pc 1/4" & 3/8" Dr. Metric Hex Bit Socket Set	C-34	5990
BS-2313TA	13pc 1/4" & 3/8" Dr. Tamperproof Star Bit Socket Set	C-45	4630
BS-2313TP	13pc 1/4" & 3/8" Dr. Tamperproof Star Bit Socket Set	C-45	3430
BS-2314H	14pc 1/4" & 3/8" Dr. SAE Hex Bit Socket Set	C-35	3740
BS-2314HL	12pc 1/4" & 3/8" Dr. SAE Long Hex Bit Socket Set	C-35	6700
BS-2314T	14pc 1/4" & 3/8" Dr. Star Bit Socket Set	C-42	3290
BS-2314TL	14pc 1/4" & 3/8" Dr. Star Bit Socket Set	C-42	5920
BS-2314TR	14pc 1/4" & 3/8" Dr. Triple Square Bit Socket Set	C-47	6810
BS-2316WH	16pc 1/4" & 3/8" Dr. Metric Wobble Hex Bit Socket Set	C-40	7190
BS-2316WS	16pc 1/4" & 3/8" Dr. SAE Wobble Hex Bit Socket Set	C-40	6670
BS-2324HL	24pc 1/4" & 3/8" Dr. Metric Hex Bit Socket Set	C-36	10500
BS-2326TAL	26pc 1/4" & 3/8" Dr. Tamperproof Star Bit Socket Set	C-44	10250
BS-2328HL	28pc 1/4" & 3/8" Dr. SAE Hex Bit Socket Set	C-37	11520
BS-2328TL	28pc 1/4" & 3/8" Dr. Star Bit Socket Set	C-42	9950
BS-23441	41pc 1/4" & 3/8" & 1/2" Dr. Complete Star Bit Socket Set	C-45	13500
BS-307M	7pc 3/8" Dr. Triple Square Bit Socket Set	C-30	2330
BS-307ML	7pc 3/8" Dr. Triple Square Bit Socket Set	C-30	3990
BS-308WH	8pc 3/8" Dr. Metric Wobble Hex Bit Socket Set	C-26	2590
BS-308WHL	8pc 3/8" Dr. Metric Wobble Hex Bit Socket Set	C-26	4970
BS-308WHS	8pc 3/8" Dr. SAE Wobble Hex Bit Socket Set	C-27	2460
BS-308WSL	8pc 3/8" Dr. SAE Wobble Hex Bit Socket Set	C-27	4050
BS-309L	9pc 3/8" Dr. Slotted & Philips Bit Socket	C-33	4080
BS-309S	9pc 3/8" Dr. Slotted & Philips Bit Socket	C-33	2410
BS-310HM	10pc 3/8" Dr. Metric Hex Bit Socket Set	C-24	3200
BS-310HML	10pc 3/8" Dr. Metric Hex Bit Socket Set	C-34	5380
BS-310HS	10pc 3/8" Dr. SAE Hex Bit Socket Set	C-25	3120
BS-310HSL	10pc 3/8" Dr. SAE Hex Bit Socket Set	C-35	6270
BS-310T	10pc 3/8" Dr. Star Bit Socket Set	C-43	2760
BS-310TA	10pc 3/8" Dr. Tamperproof Star Bit Socket Set	C-44	3030
BS-310TAL	10pc 3/8" Dr. Tamperproof Star Bit Socket Set	C-44	5000
BS-310TL	10pc 3/8" Dr. Star Bit Socket Set	C-43	4650
BS-311PL	11pc 3/8" Dr. Pentacle Bit Socket Set	C-31	6350
BS-314MX	14pc 3/8" Dr. Triple Square Bit Socket Set	C-46	7730
BS-316WHX	16pc 3/8" Dr. Metric Wobble Hex Bit Socket Set	C-40	8230
BS-316WSX	16pc 3/8" Dr. SAE Wobble Hex Bit Socket Set	C-41	7780
BS-318PL	18pc 3/8" Dr. Slotted & Philips Long Bit Socket	C-33	7680
BS-320HMX	20pc 3/8" Dr. Metric Hex Bit Socket Set	C-36	10500
BS-320HSX	20pc 3/8" Dr. SAE Hex Bit Socket Set	C-36	10300
BS-320TAX	20pc 3/8" Dr. Tamperproof Star Bit Socket Set	C-44	9540
BS-320TX	20pc 3/8" Dr. Star Bit Socket Set	C-43	8790
BS-3411S	11pc 3/8" & 1/2" Dr. Ribe Bit Socket Set	C-32	5460
BS-3416M	16pc 3/8" & 1/2" Dr. Triple Square Bit Socket Set	C-46	10070
BS-3416WM	16pc 3/8" & 1/2" Dr. Metric Wobble Bit Socket Set	C-41	8510
BS-3416WS	16pc 3/8" & 1/2" Dr. SAE Wobble Hex Bit Socket Set	C-41	7860
BS-3424H	24pc 3/8" & 1/2" Dr. SAE Hex Bit Socket Set	H-35	13930
BS-3424P	24pc 3/8" & 1/2" Dr. Slotted & Philips Bit Socket Set	H-33	12210
BS-3424T	24pc 3/8" & 1/2" Dr. Star Bit Socket Set	H-34	12090
BS-3424TA	24pc 3/8" & 1/2" Dr. Tamperproof Star Bit Socket Set	H-34	12950
BS-3428H	28pc 3/8" & 1/2" Dr. Metric Hex Bit Socket Set	C-59	18300
BS-407H	7pc 1/2" Dr. SAE Hex Bit Socket Set	C-58	4880
BS-407P	7pc 1/2" Dr. Slotted & Philips Bit Socket Set	C-57	3200
BS-408H	8pc 1/2" Dr. Metric Hex Bit Socket Set	C-58	3940
BS-408PE	8pc 1/2" Dr. Pentacle Bit Socket Set	C-57	4090
BS-408T	8pc 1/2" Dr. Star Bit Socket Set	C-60	3660
BS-409H	9pc 1/2" Dr. Metric Hex Bit Socket Set	C-59	5190
BS-409L	9pc 1/2" Dr. Metric Hex Bit Socket Set	C-58	5120
BS-409T	9pc 1/2" Dr. Star Bit Socket Set	C-60	4520
BS-410M	10pc 1/2" Dr. Triple Square Bit Socket Set	C-57	6000
BS-410TA	10pc 1/2" Dr. Tamperproof Star Bit Socket Set	C-61	5150
BS-410TB	10pc 1/2" Dr. Tamperproof Star Bit Socket Set	C-61	7380
BS-410TC	10pc 1/2" Dr. Tamperproof Star Bit Socket Set	C-61	8510
BS-614H	14pc 3/4" Dr. Metric Hex Bit Socket Set	C-13	12500
BS-615H	15pc 3/4" Dr. SAE Hex Bit Socket Set	C-13	14200
BS-6817H	17pc 3/4" & 1" Dr. Metric Hex Bit Socket Set	C-15	18500
BS-6818H	18pc 3/4" & 1" Dr. SAE Hex Bit Socket Set	C-15	19900
BS-816H	16pc 1" Dr. Metric Hex Bit Socket Set	C-14	19000
BS-817H	17pc 1" Dr. SAE Hex Bit Socket Set	C-14	20700
BT-015MF	15 in 1 Multi-Function Bike Tool Folding Test	F-24	2080

Item No.	Description	Pg.	Code
<b>C</b>			
CD-108M5	8pc 1" Dr. Metric Deep Impact Socket Set (CR-Mo) <b>NEW: CD-808M5</b>	A-63	18160
CD-108S5	8pc 1" Dr. SAE Deep Impact Socket Set (CR-Mo) <b>NEW: CD-808S5</b>	A-63	17650
CD-4131M	131pc 1/2" Dr. Metric Deep Impact Socket Display (CR-Mo)	H-61	112000
CD-4133S	133pc 1/2" Dr. SAE Deep Impact Socket Display (CR-Mo)	H-61	112000
CD-415M	13pc 1/2" Dr. Metric Deep Impact Socket Set (CR-Mo) <b>NEW: CD-413M</b>	A-39	12550
CD-808MD	8pc 1" Dr. Metric Deep Impact Socket Set (CR-Mo)	A-63	17700
CD-808SD	8pc 1" Dr. SAE Deep Impact Socket Set (CR-Mo)	A-63	16940
CD-809S	9pc 1" Dr. SAE Deep Impact Socket Set (CR-Mo)	A-62	18000
CK-007BW	7pc Folding Hex & Screwdriver Key Wrench Set	F-24	1390
CK-008G	8pc SAE Folding Wobble Hex Key Wrench Set	F-27	1610
CM-003	8pc 3/8" Dr. SAE Deep Impact Socket Set (CR-Mo) <b>NEW: CD-308S</b>	A-15	3730
CM-004	8pc 3/8" Dr. Metric Deep Impact Socket Set (CR-Mo) <b>NEW: CD-308M</b>	A-15	3730
CM-007	10pc 1/2" Dr. SAE Deep Impact Socket Set (CR-Mo) <b>NEW: CD-410S</b>	A-38	7875
CM-008	10pc 1/2" Dr. Metric Deep Impact Socket Set (CR-Mo) <b>NEW: CD-410M</b>	A-38	7875
CM-021	8pc 3/4" Dr. SAE Impact Socket Set (CR-Mo) <b>NEW: CM-608S</b>	A-48	8600
CM-022	8pc 3/4" Dr. Metric Impact Socket Set (CR-Mo) <b>NEW: CM-608M</b>	A-48	8600
CM-023-1	8pc 3/4" Dr. SAE Deep Impact Socket Set (CR-Mo) <b>NEW: CD-608S</b>	A-50	15440
CM-023M2	8pc 3/4" Dr. Metric Deep Impact Socket Set (CR-Mo) <b>NEW: CD-608M</b>	A-50	15440
CM-025-2	5pc 1" Dr. SAE Impact Socket Set (CR-Mo) <b>NEW: CM-805S</b>	A-60	10240
CM-029	9pc 1" Dr. SAE Impact Socket Set (CR-Mo) <b>NEW: CM-809S</b>	A-60	24150
CM-031	13pc 1/2" Dr. SAE Deep Impact Socket Set (CR-Mo) <b>NEW: CD-413S</b>	A-39	12970
CM-037-1	7pc 1" Dr. SAE Deep Impact Socket Set (CR-Mo) <b>NEW: CD-807S</b>	A-62	17955
CM-106M	5pc 1" Dr. Metric Impact Socket Set (CR-Mo) <b>NEW: CM-805M</b>	A-60	10500
CM-107DM	7pc 1" Dr. Metric Deep Impact Socket Set (CR-Mo) <b>NEW: CD-807M</b>	A-62	18535
CM-108M3	8pc 1" Dr. Metric Impact Socket Set (CR-Mo) <b>NEW: CM-808M3</b>	A-61	16015
CM-108S3	8pc 1" Dr. SAE Impact Socket Set (CR-Mo) <b>NEW: CM-808S3</b>	A-61	15225
CM-109DM	8pc 1" Dr. Metric Deep Impact Socket Set (CR-Mo) <b>NEW: CD-808M2</b>	A-62	22750
CM-110M	9pc 1" Dr. Metric Impact Socket Set (CR-Mo) <b>NEW: CM-809M</b>	A-60	21000
CM-308M	8pc 3/8" Dr. Metric Impact Socket Set (CR-Mo)	A-12	2050
CM-308S	8pc 3/8" Dr. SAE Impact Socket Set (CR-Mo)	A-12	2050
CM-313S	13pc 3/8" Dr. SAE Impact Socket Set (CR-Mo)	A-14	3300
CM-313SD	13pc 3/8" Dr. SAE Deep Impact Socket Set (CR-Mo)	A-13	4750
CM-316M	16pc 3/8" Dr. Metric Impact Socket Set (CR-Mo)	A-14	3950
CM-316MD	16pc 3/8" Dr. Metric Deep Impact Socket Set (CR-Mo)	A-13	5760
CM-326S	26pc 3/8" Dr. SAE Impact Socket Set (CR-Mo)	A-16	8550
CM-332M	32pc 3/8" Dr. Metric Deep Impact Socket Set (CR-Mo)	H-26	10500
CM-3472ACS	72pc 3/8" & 1/2" Dr. SAE Socket & Accessory Display Board	H-67	43190
CM-3490ACM	90pc 3/8" & 1/2" Dr. Metric Socket & Accessory Display Board	H-67	52965
CM-4131M	131pc 1/2" Dr. Metric Impact Socket Display (CR-Mo)	H-60	78750
CM-4133S	133pc 1/2" Dr. SAE Impact Socket Display (CR-Mo)	H-60	81375
CM-608M4	8pc 3/4" Dr. Metric Budd Wheel Impact Socket Set (CR-Mo) <b>NEW: CD-608M4</b>	A-50	18745
CM-608S4	8pc 3/4" Dr. SAE Budd Wheel Impact Socket Set (CR-Mo) <b>NEW: CD-608S4</b>	A-50	18745
CM-610M	10pc 3/4" Dr. Metric Impact Socket Set (CR-Mo)	A-52	15070
CM-610S	10pc 3/4" Dr. SAE Impact Socket Set (CR-Mo)	A-52	15070
CM-630ACM	30pc 3/4" Dr. Metric Impact Socket & Accessory Display Board	H-68	44800
CM-630ACS	30pc 3/4" Dr. SAE Impact Socket & Accessory Display Board	H-68	54260
CM-808M	8pc 1" Dr. Metric Impact Socket Set (CR-Mo)	A-61	12020
CM-808S	8pc 1" Dr. SAE Impact Socket Set (CR-Mo)	A-61	11630
CP-5312	12pc Locking Pliers Set	H-51	22500
CP-5704	4pc Pliers Set	H-29	6900
CP-5804	4pc General Purpose Pliers Set	H-29	8700
CW-007M	7pc Metric Combination Wrench Set (Mirror Finish)	H-39	6340
CW-403M	3pc Metric Car Wheel Thin Wall Deep Impact Socket Set	J-14	3310
CW-404MS	4pc Metric & SAE Car Wheel Thin Wall Deep Impact Socket Set	H-24	4470
CW-406M	6pc Metric Car Wheel COLOUR MATCH® Set	H-24	9550
CW-408MS	8pc Metric & SAE Car Wheel COLOUR MATCH® Set	H-29	13110
<b>D</b>			
DE-704S	4pc SAE Extra Long Box End Wrench Set	F-14	10400
DE-706M	6pc Metric Extra Long Box End Wrench Set	F-14	17000
DE-706S	6pc SAE Double Ended Offset Ring Wrench Set (Mirror Finish)	F-8	9980
DE-707M	7pc Metric Offset Box End Wrench Set (Mirror Finish)	H-39	9950
DE-708M	8pc Metric Double Ended Offset Ring Wrench Set (Mirror Finish)	F-8	12200
DE-708S	8pc SAE Double Ended Offset Ring Wrench Set (Mirror Finish)	F-8	17000
DE-7106S	6pc SAE Double Ended Offset Ring Wrench Set (Matt Finish)	F-9	7850
DE-7108S	8pc SAE Double Ended Offset Ring Wrench Set (Matt Finish)	F-9	13300
DE-713M	13pc Metric Double Ended Offset Ring Wrench Set	F-8	27600

Item No.	Description	Pg.	Code
DE-7208M	8pc Metric Double Ended Offset Ring Wrench Set (Matt Finish)	F-9	9450
DE-7213M	13pc Metric Double Ended Offset Ring Wrench Set (Matt Finish)	F-9	21600
DF-504S	4pc SAE Double Flexible Socket Wrench Set (Mirror Finish)	F-15	7200
DF-506M	6pc Metric Double Flexible Socket Wrench Set (Mirror Finish)	F-15	8700
DG-1516	16 Piece Air Micro Die Grinder Set	E-22	11400
DI-404M	4pc 1/2" Dr. Metric Spindle Nut Impact Socket set (12-Point) (CR-Mo)	A-34	7900
DI-407M	7pc 1/2" Dr. Metric Deep Impact Socket Set (CR-Mo)	H-21	10070
DI-407S	7pc 1/2" Dr. SAE Deep Impact Socket Set (CR-Mo)	H-21	9700
DI-408M	8pc 1/2" Dr. Metric Spindle Nut Impact Socket set (12-Point) (CR-Mo)	A-34	15600
DI-415M	15pc 1/2" Dr. Metric Semi-Deep Thin Wall Impact Socket Set (CR-Mo)	H-22	7660
DI-417MD	17pc 1/2" Dr. Metric Deep Thin Wall Impact Socket Set (12-Point) (CR-Mo)	H-26	15500
DI-422S	22pc 1/2" Dr. SAE Deep Impact Socket Set (CR-Mo)	H-28	20700
DI-425M	25pc 1/2" Dr. Metric Deep Impact Socket Set (CR-Mo)	H-28	20700
DI-621M	21pc 3/4" Dr. Metric Deep Impact Socket Set (CR-Mo)	A-51	54500
DI-621S	21pc 3/4" Dr. SAE Deep Impact Socket Set (CR-Mo)	A-51	56000
DS-038B	Display Stand Set, 945 x 500 x 2235mm	I-8	145000
DS-111	Display Stand Set, 945 x 400 x 2245mm	I-8	82000
DS-422S	22pc 1/2" Dr. SAE Deep Hand Socket Set	H-32	18765
DS-424	1/2" Drive Sockets Display Stand	I-2	15700
DS-425M	25pc 1/2" Dr. Metric Deep Hand Socket Set	H-31	18805
DS-434S	34pc 1/2" Dr. SAE Hand Stocket Set	B-61	19500
DS-440M	40pc 1/2" Dr. Metric Hand Stocket Set	B-61	21000
<b>E</b>			
EU-228M	28pc 1/4" Dr. Metric Hand Socket Set	B-15	7300
EU-228S	28pc 1/4" Dr. SAE Hand Socket Set	B-14	7300
EU-230MS	30pc 1/4" Dr. Metric & SAE Hand Socket Set	B-15	8200
EU-232M	32pc 1/4" Dr. Metric Deep Hand Socket Set	B-16	9900
EU-240M	40pc 1/4" Dr. Metric Hand Socket Set	B-16	7210
EU-2454M	54pc 1/4" & 1/2" Dr. Metric Hand Socket & Bit Set	B-56	17900
EU-319M	19pc 3/8" Dr. Metric Hand Socket Set	B-36	8150
EU-335M	35pc 3/8" Dr. Metric Deep Hand Socket Set	H-30	14400
EU-354M	54pc 3/8" Dr. Metric Hand Socket & Hex Bit Socket Set	B-36	22400
EU-421S	21pc 1/2" Dr. SAE Hand Stocket Set (12-Point)	B-57	14400
EU-422M	22pc 1/2" Dr. Metric Hand Socket Set	B-57	13000
EU-426M	26pc 1/2" Dr. Metric Hand Stocket Set	B-57	17000
EU-615M	15pc 3/4" Dr. Metric Hand Socket Set (CR-Mo)	B-87	34370
EX-2349	9pc 1/4", 3/8" & 1/2" Dr. Extension Bar Set	H-24	3270
<b>F</b>			
FC-086	800 x 600mm Magnetic Fender Cover	J-8	3800
FC-116	1050 x 580mm Magnetic Fender Cover	J-8	4000
FD-404	4pc 1/2 Dr. SAE Stud Remover Socket Set	J-20	5000
FD-404M	4pc 1/2 Dr. Metric Stud Remover Socket Set	J-20	5000
FD-410M	9pc 1/2" Dr. Metric Wheel Impact Socket	A-19	2825
FD-414M1	13pc 1/2" Dr. Metric Deep Impact Socket Set <b>NEW: TD-413M</b>	A-20	6090
FG-020M	20 Blades Metric Feeler Gauge Set (0.05~1.00mm)	J-5	1650
FG-025M	25 Blades Metric Feeler Gauge Set (0.04~1.00mm)	J-5	1650
FG-026S	26 Blades SAE Feeler Gauge Set (0.0015~0.025")	J-5	1650
FL-0687	7pc Small File Set	G-12	4500
FL-0785	5pc Diamond File Set	G-12	3400
FL-0865	5pc Air File Set	G-12	3200
FN-005S	5pc SAE Flare Nut Wrench Set	F-10	6200
FN-006M	6pc Metric Flare Nut Wrench Set	F-10	7300
FS-409S	9pc 1/2" Dr. SAE Impact Socket Set (CR-Mo)	A-37	4210

Item No.	Description	Pg.	Code
<b>G</b>			
GA-015A	15pc 1/4" Hex Shank Ratcheting Screwdriver Accessory Set	D-25	10700
GD-2105	10pc 1/4" Dr. SAE Deep Hand Socket Set	B-9	2740
GD-211M	11pc 1/4" Dr. Metric Deep Hand Socket Set	B-9	3000
GD-217S	17pc 1/4" Dr. SAE Deep Hand Socket Set	B-10	7110
GD-220M	20pc 1/4" Dr. Metric Deep Hand Socket Set	B-10	7890
GD-312M	12pc 3/8" Dr. Metric Deep Hand Socket Set	B-29	4190
GD-408M1	8pc 1/2" Dr. Metric Impact Socket Set	B-49	7200
GD-408S1	8pc 1/2" Dr. SAE Impact Socket Set	B-49	7200
GD-412M	12pc 1/2" Dr. Metric Deep Hand Socket Set	B-47	6850
GD-412S	12pc 1/2" Dr. SAE Deep Hand Socket Set	B-47	7445
GD-4131M	131pc 1/2" Dr. Metric Deep Hand Socket Display	H-63	102500
GD-4133S	133pc 1/2" Dr. SAE Deep Hand Socket Display	H-63	102500
GS-215S	15pc 1/4" Dr. SAE Hand Socket Set	B-11	3280
GS-216S	16pc 1/4" Dr. SAE Hand Socket Set	B-12	3390
GS-217M	17pc 1/4" Dr. Metric Hand Socket Set	B-11	3520
GS-218M	18pc 1/4" Dr. Metric Hand Socket Set	B-12	3630
GS-219M	19pc 1/4" Dr. Metric Hand Socket Set	B-12	5315
GS-220M	20pc 1/4" Dr. Metric Hand Socket Set	B-10	6410
GS-221M	21pc 1/4" Dr. Metric Deep Hand Socket Set	B-9	4200
GS-222M	22pc 1/4" Dr. Metric Deep Hand Socket Set	H-23	7300
GS-229M	29pc 1/4" Dr. Metric Hand Socket Set	B-14	6540
GS-234105M	105pc 1/4", 3/8" & 1/2" Dr. Metric Hand Socket Display Board	H-64	46890
GS-2343MS	43pc 1/4" & 3/8" Dr. Metric & SAE Hand Socket Set	B-37	9680
GS-23485S	85pc 1/4", 3/8" & 1/2" Dr. SAE Hand Socket Display Board	H-65	38695
GS-2353M	53pc 1/4" & 3/8" Dr. Metric Deep Hand Socket Set	B-37	16320
GS-237S	37pc 1/4" Dr. SAE Hand Socket Set	B-13	7400
GS-239M	39pc 1/4" Dr. Metric Hand Socket Set	B-13	7800
GS-244MS	44pc 1/4" Dr. Metric & SAE Deep Hand Socket Set	B-17	7000
GS-255MS	55pc 1/4" Dr. Metric & SAE Hand Socket Set	B-19	12000
GS-312M	12pc 3/8" Dr. Metric Hand Socket Set	B-28	2810
GS-313M	13pc 3/8" Dr. Metric Deep Hand Socket Set	B-31	6950
GS-313S	13pc 3/8" Dr. SAE Deep Hand Socket Set	B-31	6950
GS-314S	14pc 3/8" Dr. SAE Hand Socket Set	B-28	3510
GS-314SD	14pc 3/8" Dr. SAE Deep Hand Socket Set	B-29	5080
GS-319M1	19pc 3/8" Dr. Metric Hand Socket Set <b>NEW: GS-318M1</b>	B-32	7500
GS-319M2	19pc 3/8" Dr. Metric Hand Socket Set <b>NEW: GS-318M2</b>	B-32	7500
GS-320M	20pc 3/8" Dr. Metric Hand Socket Set	B-32	10000
GS-320S	20pc 3/8" Dr. SAE Hand Socket Set	B-31	10200
GS-330S	30pc 3/8" Dr. SAE Deep Hand Socket Set	H-30	13200
GS-331M	31pc 3/8" Dr. Metric Hand Socket Set	B-29	13800
GS-332M	32pc 3/8" Dr. Metric Hand Socket Set	H-29	8980
GS-332MS	32pc 3/8" Dr. Metric & SAE Hand Socket Set	B-33	12250
GS-347MS	47pc 3/8" Dr. Metric & SAE Deep Hand Socket Set	B-33	12000
GS-409M	9pc 1/2" Dr. Metric Impact Socket Set (CR-Mo)	A-36	4210
GS-409M2	9pc 1/2" Dr. Metric Impact Socket Set (CR-Mo)	A-36	4200
GS-410DM	10pc 1/2" Dr. Metric Deep Hand Socket Set <b>NEW: GD-410M</b>	B-48	6726
GS-410RM	10pc 1/2" Dr. Metric Hand Socket Set	B-48	4141
GS-412M	12pc 1/2" Dr. Metric Hand Socket Set	B-47	4140
GS-412S	12pc 1/2" Dr. Metric Hand Socket Set	B-47	4570
GS-4131M	131pc 1/2" Dr. Metric Hand Socket Display	H-62	68250
GS-4133S	133pc 1/2" Dr. SAE Hand Socket Display	H-62	68250
GS-415M	new item no: IW-415MT	A-39	6400
GS-416M	16pc 1/2" Dr. Metric Hand Socket Set	B-48	10850
GS-416MA	16pc 1/2" Dr. Metric Hand Socket Set	B-58	10850
GS-416S	16pc 1/2" Dr. SAE Hand Socket Set	B-48	11000
GS-417	17pc 1/2" Dr. Metric Impact Socket Set (CR-Mo)	A-37	8500
GS-417M	17pc 1/2" Dr. Metric Hand Socket Set	B-50	11600
GS-417S	17pc 1/2" Dr. SAE Hand Socket Set	B-50	11600
GS-418M	18pc 1/2" Dr. Metric Hand Socket Set	B-50	12350
GS-418S	18pc 1/2" Dr. SAE Hand Socket Set	B-51	12350
GS-422M	22pc 1/2" Dr. Metric Hand Socket Set	B-51	13950
GS-422M2	22pc 1/2" Dr. Metric Hand Socket Set	B-52	14700
GS-422M3	22pc 1/2" Dr. Metric Hand Socket Set	B-52	14500
GS-422M4	22pc 1/2" Dr. Metric Hand Socket Set	B-52	13950
GS-422S	22pc 1/2" Dr. SAE Hand Socket Set	B-51	13950
GS-424M	24pc 1/2" Dr. Metric Hand Socket Set	B-55	15200
GS-424M3	23pc 1/2" Dr. Metric Hand Socket Set <b>NEW: GS-423M3</b>	B-53	15995
GS-424M4	23pc 1/2" Dr. Metric Hand Socket Set <b>NEW: GS-423M4</b>	B-53	16600
GS-424MA	24pc 1/2" Dr. Metric Hand Socket Set	B-55	16700

Item No.	Description	Pg.	Code
GS-424S	24pc 1/2" Dr. SAE Hand Socket Set	B-56	15700
GS-424S4	23pc 1/2" Dr. SAE Hand Socket Set	B-53	17010
GS-425K	27 Piece 1/2" Dr. Metric Air Impact Wrench Set	E-5	21800
GS-425KS	27 Piece 1/2" Dr. SAE Air Impact Wrench Set	E-5	23000
GS-425M	24pc 1/2" Dr. Metric Hand Socket Set <b>NEW: GS-424M5</b>	B-58	15350
GS-425S	24pc 1/2" Dr. SAE Hand Socket Set <b>NEW: GS-424S5</b>	B-58	15350
GS-427M	27pc 1/2" Dr. Metric Hand Socket Set	B-59	19000
GS-427S	27pc 1/2" Dr. SAE Hand Socket Set	B-59	19000
GS-432S	32pc 1/2" Dr. SAE Hand Socket Set (6-Point)	B-60	18100
GS-434S	34pc 1/2" Dr. SAE Master Impact Socket Set (CR-Mo)	A-41	20630
GS-439M	39pc 1/2" Dr. Metric Hand Socket Set (6-Point)	B-60	21000
GS-440M	40pc 1/2" Dr. Metric Master Impact Socket Set (CR-Mo)	A-41	21890
GS-446MS	46pc 1/2" Dr. Metric & SAE Hand Socket Set	B-62	27800
GS-615M	15pc 3/4" Dr. Metric Hand Socket Set (CR-Mo)	B-85	32550
GS-615S	15pc 3/4" Dr. SAE Hand Socket Set (CR-Mo)	B-85	35700
GS-617AS	17pc 3/4" Dr. SAE Hand Socket Set (CR-Mo)	B-81	35600
GS-617M	17pc 3/4" Dr. Metric Hand Socket Set (CR-Mo)	B-86	33865
GS-617S	17pc 3/4" Dr. SAE Hand Socket Set (CR-Mo)	B-86	33865
GS-627M	27pc 3/4" Dr. Metric Hand Socket Set (CR-Mo)	B-85	34500
GS-627S	27pc 3/4" Dr. SAE Hand Socket Set (CR-Mo)	B-86	37500
GS-815M	15pc 1" Dr. Metric Hand Socket Set (CR-Mo)	B-95	57750
GS-815M1	15pc 1" Dr. Metric Hand Socket Set (CR-Mo)	B-95	60000
GS-815S	15pc 1" Dr. SAE Hand Socket Set (CR-Mo)	B-95	60375
GS-816M	16pc 1" Dr. Metric Hand Socket Set (6 & 12-Point) (CR-Mo)	B-90	96580
GS-816S	16pc 1" Dr. SAE Hand Socket Set (6 & 12-Point) (CR-Mo)	B-90	100400
GS-817M	17pc 1" Dr. Metric Hand Socket Set (CR-Mo)	B-96	50200
GS-817S	17pc 1" Dr. SAE Hand Socket Set (CR-Mo)	B-96	68900
GW-7607M	7pc Metric Combination Ratcheting Wrench Set	H-39	10200
GW-7610M	10pc Metric Stubby Combination Ratcheting Wrench Set	F-13	12820
GW-7611M	11pc Metric Combination Ratcheting Wrench Set	F-12	15700
GW-7617M	17pc Metric Combination Ratcheting Wrench Set	F-12	42330
GW-7707S	7pc SAE Stubby Combination Ratcheting Wrench Set	F-13	8900
GW-7708S	8pc SAE Combination Ratcheting Wrench Set	F-12	11250
GW-7715S	15pc SAE Combination Ratcheting Wrench Set	F-12	41120
<b>H</b>			
HK-007BM	7pc Metric Folding Hex Key Wrench Set	F-25	1270
HK-007BMW	7pc Metric Folding Wobble Hex Key Wrench Set	F-25	1520
HK-007GMB	7pc Metric Folding Wobble Hex Key Wrench Set	F-26	1650
HK-007GMF	7pc Metric Folding Hex Key Wrench Set	F-26	1450
HK-007MF	7pc Metric Hex Key Wrench Folding Set	F-30	960
HK-007TS	7pc Triple Square Key Wrench Set	F-33	3520
HK-008BS	8pc SAE Folding Hex Key Wrench Set	F-25	1390
HK-008BSW	8pc SAE Folding Wobble Hex Key Wrench Set	F-25	1650
HK-008GSB	8pc SAE Folding Wobble Hex Key Wrench Set	F-26	1790
HK-008GSF	8pc SAE Folding Wobble Hex Key Wrench Set	F-26	1590
HK-009ASM	9pc Metric Long Anti-Slip Hex Key Wrench Set (S2 Material)	F-23	3270
HK-009ASS	9pc SAE Long Anti-Slip Hex Key Wrench Set (S2 Material)	F-23	3260
HK-009GMB	9pc Metric Folding Wobble Hex Key Wrench Set	F-26	2150
HK-009GMF	9pc Metric Folding Hex Key Wrench Set	F-26	1870
HK-009M	9pc Metric Hex Key Wrench Set	F-30	1230
HK-009MB	9pc Metric Wobble Hex Key Wrench Set	F-31	2120
HK-009ML	9pc Metric Long Hex Key Wrench Set	F-29	1870
HK-009S	9pc SAE Hex Key Wrench Set	F-30	1230
HK-009SB	9pc L-Shaped SAE Ball Hex Key Wrench Set	F-31	2120
HK-009SF	9pc SAE Hex Key Wrench Folding Set	F-30	1020
HK-010M	10pc Metric Hex Key Wrench Set	F-30	1050
HK-010S	10pc SAE Hex Key Wrench Set	F-30	1050
HK-025MS	25pc Metric & SAE Hex Key Wrench Set	F-28	2820
HK-07TSS	7pc Triple Square Key Wrench Set (S2 Material)	F-24	4390
HK-09MBS	9pc Metric Wobble Hex Key Wrench Set (S2 Material)	F-23	2560
HK-09MLS	9pc Metric Long Hex Key Wrench Set (S2 Material)	F-22	2350
HK-09MS	9pc Metric Hex Wrench Set (S2 Material)	F-22	1650
HK-09SBS	9pc SAE Wobble Hex Key Wrench Set (S2 Material)	F-23	2560
HK-09SSF	9pc SAE Hex Wrench Set (S2 Material)	F-22	1650

Item No.	Description	Pg.	Code
HK-10MS	10pc Metric Hex Wrench Set (S2 Material)	F-22	1650
HK-10SS	10pc SAE Hex Wrench Set (S2 Material)	F-22	1650
HR-5608M	8pc Metric Hex Screwdriver Set	H-36	4930
HR-5611S	11pc SAE Hex Screwdriver Set	H-36	6760
HR-578MW	8pc Metric Wobble Hex Screwdriver Set	H-37	6790
HR-578SW	8pc SAE Wobble Hex Screwdriver Set	H-37	5380
HS-007M	7pc Metric Combination Wrench Set (Matt Finish)	H-39	5515
HS-009S	9pc SAE Combination Wrench (Matt Finish)	F-3	6365
HS-011M	11pc Metric Combination Wrench (Matt Finish)	F-4	5550
HS-011S	11pc SAE Combination Wrench (Matt Finish)	F-4	6750
HS-013M	13pc Metric Combination Wrench (Matt Finish)	F-4	8405
HS-016M	16pc Metric Combination Wrench (Matt Finish)	F-2	15075
HS-016S	16pc SAE Combination Wrench (Matt Finish)	F-3	14250
HS-024M	24pc Metric Combination Wrench Set (Matt Finish)	F-4	19800
HS-44AWS	44pc SAE Adjustable & Combination Wrench Display Board	H-68	68240
HS-48M	48pc Metric Combination Wrench Display Board	H-66	44600
HS-5610M	10pc Metric Hex Screwdriver Set	H-38	6200
HS-5612S	12pc SAE Hex Screwdriver Set	H-38	6590
HS-5708MW	8pc Metric Wobble Hex Screwdriver Set	H-38	5870
HS-5708SW	8pc SAE Wobble Hex Screwdriver Set	H-38	5490
I			
ID-314	14pc 3/8" Dr. Impact Driver Set	D-38	4490
ID-321M	21pc 3/8" Dr. Metric Impact Driver Set (CR-Mo)	A-16	9360
ID-321S	21pc 3/8" Dr. SAE Impact Driver Set (CR-Mo)	A-16	9550
ID-414	14pc 1/2" Dr. Impact Driver Set	D-38	4560
ID-424M	24pc 1/2" Dr. Metric Impact Driver Set	C-10	13090
ID-424S	24pc 1/2" Dr. SAE Impact Driver Set	C-10	13210
IE-2349	9pc 1/4", 3/8" & 1/2" Dr. Impact Extension Bar Set	H-22	2560
IS-314M	14pc 3/8" Dr. Metric Impact Socket Set (CR-Mo)	H-21	3800
IS-415M	15pc 1/2" Dr. Metric Impact Socket Set (CR-Mo)	H-21	6600
IS-422S	22pc 1/2" Dr. SAE Impact Socket Set (CR-Mo)	H-27	13655
IS-425M	25pc 1/2" Dr. Metric Impact Socket Set (CR-Mo)	H-27	13500
IS-609DE	9pc 3/4" Dr. Metric Deep Impact Socket Set (CR-Mo)	A-49	16700
IS-609E	9pc 3/4" Dr. Metric Impact Socket Set (CR-Mo)	A-48	9000
IS-609M	9pc 3/4" Dr. Metric Impact Socket Set (CR-Mo)	A-48	9670
IS-609MD	9pc 3/4" Dr. Metric Deep Impact Socket Set (CR-Mo)	A-49	17600
IS-617E	17pc 3/4" Dr. Metric Impact Socket Set (CR-Mo)	A-53	24120
IS-617M	17pc 3/4" Dr. Metric Impact Socket Set (CR-Mo)	A-52	21500
IS-617S	17pc 3/4" Dr. SAE Impact Socket Set (CR-Mo)	A-52	27720
IS-627M	27pc 3/4" Dr. Metric Impact Socket Set (CR-Mo)	A-53	40920
IS-627S	27pc 3/4" Dr. SAE Impact Socket Set (CR-Mo)	A-53	49250
IS-817M	17pc 1" Dr. Metric Impact Socket Set (CR-Mo)	A-64	63500
IS-817S	17pc 1" Dr. SAE Impact Socket Set (CR-Mo)	A-64	89480
IW-415MT	15pc 1/2" Dr. Metric Thin Wall Impact Socket Set (12-Point) (CR-Mo)	A-39	6400
K			
KA-2080	80mm Two-Arm Gear Puller	G-11	6000
KA-2120	120mm Two-Arm Gear Puller	G-11	6800
KA-2160	160mm Two-Arm Gear Puller	G-11	10800
KA-2200	200mm Two-Arm Gear Puller	G-11	11900
KJ-2076	3" Two-Jaw Gear Puller	G-11	2450
KJ-2102	4" Two-Jaw Gear Puller	G-11	3500
KJ-2127	5" Two-Jaw Gear Puller	G-11	5150
KJ-2152	6" Two-Jaw Gear Puller	G-11	6050
KJ-2203	8" Two-Jaw Gear Puller	G-11	11000
KJ-2254	10" Two-Jaw Gear Puller	G-11	17100
KJ-2305	12" Two-Jaw Gear Puller	G-11	23000
KJ-3076	3" Three-Jaw Gear Puller	G-11	3650
KJ-3102	4" Three-Jaw Gear Puller	G-11	4800
KJ-3127	5" Three-Jaw Gear Puller	G-11	6400
KJ-3152	6" Three-Jaw Gear Puller	G-11	7800
KJ-3203	8" Three-Jaw Gear Puller	G-11	16900
KJ-3254	10" Three-Jaw Gear Puller	G-11	26100
KJ-3305	12" Three-Jaw Gear Puller	G-11	35500

Item No.	Description	Pg.	Code
M			
MS-007P	7pc Pliers Set	H-44	15200
MS-008R	8pc Retaining Ring Pliers & Oil Filter Wrench Set	H-46	15100
MS-013	13pc Tang-Thru Screwdriver, Pry Bar & Carbon Scraper Set	H-48	13500
MS-013SP	13pc Slotted & Phillips Screwdriver Set	H-48	7940
MS-013T	13pc Star Screwdriver Set	H-47	8430
MS-014	14pc Slotted, Phillips & Posidriv Screwdriver Set	H-47	14000
MS-014A	14pc Combination Auto Repair Tool Set	H-45	12290
MS-015	15pc Pliers Set	H-59	28200
MS-019	19pc Punch, Chisel & Hammer Set	H-43	18000
MS-020B	20pc Metric Offset Box End, Open End & E-Star Wrench Set	H-50	19800
MS-020M	20pc Metric Combination Wrench Set	H-50	19750
MS-023	23pc Punch, Chisel & Hammer Set	H-56	29700
MS-024M	24pc Metric Combination & Offset Box End Wrench Set	H-50	23200
MS-025R	25pc Hex Screwdriver & Ratcheting Screwdriver Set	H-48	16610
MS-027S	27pc 1/2" Dr. SAE Impact Socket & Accessory Set	H-41	29500
MS-028S	28pc SAE Flare Nut, E-Star & L-Shaped Key Wrench	H-49	24500
MS-035M	35pc Metric Flare Nut & L-Shaped Key Wrench Set	H-49	25000
MS-035MS	35pc Pliers & Screwdriver Set	H-58	21600
MS-035S	35pc SAE Complete Wrench Set	H-57	48100
MS-041MS	41pc Metric & SAE Combination & Flare Nut Wrench Set	H-57	36800
MS-042M	42pc 3/8" Dr. Metric Impact Socket & Star Hand Socket Set	H-40	25500
MS-044M	44pc Metric Complete Wrench Set	H-56	64780
MS-048MS	48pc Hex, Star, Triple Square & Square Bit Set	H-47	20800
MS-057M	57pc 1/4" & 1/2" Dr. Swivel Socket & Bit Socket Set	H-45	43000
MS-065S	65pc 3/8" Dr. Head Driver & Impact Socket Set	H-40	31500
MS-071M	71pc 3/8" Dr. Metric Hand Socket & Bit Socket Set	H-46	29290
MS-086	86pc Screwdriver & Bit Set	H-58	22500
MS-090S	90pc 3/8" Dr. SAE Tool Set	H-53	47300
MS-098M	98pc 1/4" & 1/2" Dr. Metric Tool Set	H-54	50100
MS-100S	100pc 1/4" & 1/2" Dr. SAE Tool Set	H-55	45600
MS-106M	106pc 3/8" Dr. Metric Tool Set	H-52	43100
MS-110TS	110pc 1/4", 3/8" & 1/2" Dr. Metric Mechanic Tool Set	H-14	77700
MS-121M	121pc 1/4" Dr. Metric Hand Socket & Bit Socket Set	H-44	22680
MS-139MS	139pc 1/4", 3/8" & 1/2" Dr. Metric & SAE Tool Set	H-59	61500
MS-142TS	142pc 1/4" & 1/2" Dr. Metric Mechanic Tool Set	H-14	66000
MS-190TS	190pc 1/4", 3/8" & 1/2" Dr. Metric & SAE Mechanic Tool Set	H-15	107900
MS-215TA	215pc 1/4", 3/8" & 1/2" Dr. Metric & SAE Tool Set	H-13	178800
MS-215TS	215pc 1/4", 3/8" & 1/2" Dr. Metric & SAE Tool Set	H-13	194000
MS-221TS	221pc 1/4" & 1/2" Dr. Metric Mechanic Tool Set	H-12	162400
MS-236TS	236pc 3/8" Dr. Metric Mechanic Tool Set	H-11	212000
MS-243TS	243pc 1/4" & 1/2" Dr. Metric Mechanic Tool Set	H-12	234200
MS-266TS	266pc 1/4" & 1/2" Dr. Metric Mechanic Tool Set	H-11	290000
MS-322TS	322pc 1/4" & 1/2" Dr. Metric & SAE Mechanic Tool Set	H-10	275000
MS-361TS	361pc 3/8" Dr. Metric & SAE Mechanic Tool Set	H10	305000
MS-363TS	363pc 1/4", 3/8" & 1/2" Dr. Metric Mechanic Tool Set	H-9	288500
MS-385TS	385pc 1/4" & 1/2" Dr. Metric Master Tool Set	H-8	435000
MS-399TS	399pc 3/8" Dr. Metric & SAE Master Tool Set	H-8	410000
MS-401TS	401pc 1/4" & 1/2" Dr. Metric & SAE Master Tool Set	H-7	440000
MS-433TS	433pc 1/4" & 1/2" Dr. Metric Master Tool Set	H-7	430000
MS-435I	35pc 1/2" Dr. Metric Deep Impact Socket Set	H-41	14380
MS-435M	35pc 1/2" Dr. Metric Deep Hand Socket Set	H-42	21020
MS-437M	37pc 1/2" Dr. Metric Hand Socket Set	H-42	25710
MS-442B	42pc 1/2" Dr. Complete Bit Socket Set	H-43	28040
MS-480TS	480pc 1/4", 3/8" & 1/2" Dr. Metric Mechanic Tool Set	H-6	423700
MS-541	541pc 1/4", 3/8" & 1/2" Dr. Metric & SAE Master Tool Set	H-5	325560
MS-541TS	541pc Metric & SAE Master Tool Set w/Tool Storage	H-5	581010
MS-548TS	548pc 1/4" & 1/2" Dr. Metric & SAE Master Tool Set	H-4	620000
MS-771	771pc 1/4", 3/8" & 1/2" Dr. Metric & SAE Master Tool Set	H-3	421000
MS-771TS	771pc Metric & SAE Master Tool Set w/Tool Storage	H-3	982200
MS-926TS	926pc 1/4", 3/8" & 1/2" Dr. Metric & SAE Master Tool Set	H-2	820000
MT-508	8pc Micro-Tech Screwdriver Set	D-56	2130
MT-508L	8pc Micro-Tech Screwdriver Set	D-56	2430
MT-5206	6pc Micro-Tech Screwdriver Set	D-57	1680
MT-5208	8pc Micro-Tech Star Screwdriver Set	D-57	2560
MT-5306	6pc Micro-Tech Metric Hex Screwdriver Set	D-57	1800
MT-5405	5pc Micro-Tech SAE Hex Screwdriver Set	D-57	1520

Item No.	Description	Pg.	Code
<b>N</b>			
NB-021M	21pc Metric Hex Nut Driver & Bit Set	D-62	10500
ND-007S	7pc SAE Hex Nut Driver Set	D-59	4630
ND-007SD	7pc SAE Long Hex Nut Driver Set	D-59	6340
ND-012M	12pc Metric Hex Nut Driver Set	D-59	7960
ND-012MD	12pc Metric Long Hex Nut Driver Set	D-59	10900
ND-020MS	20pc Metric & SAE Hex Nut Driver Set	D-62	10800
NM-006S	6pc SAE Hex Nut Driver Set (with magnet)	D-61	4840
NM-006SD	6pc SAE Long Hex Nut Driver Set (with magnet)	D-61	6640
NM-009M	9pc Metric Hex Nut Driver Set (with magnet)	D-61	7370
NM-009MD	9pc Metric Long Hex Nut Driver Set (with magnet)	D-61	10070
<b>O</b>			
OS-505SP	5pc Slotted & Philips Offset Screwdriver Set	F-27	2370
OW-705S	5pc SAE Open End Wrench Set	H-25	3770
OW-706S	6pc SAE Open End Wrench Set	F-18	5040
OW-707M	7pc Metric Open End Wrench Set	H-25	4450
OW-708M	8pc Metric Open End Wrench Set	F-18	5490
OW-709S	9pc SAE Open End Wrench Set	F-18	9120
OW-713M	13pc Metric Open End Wrench Set	F-18	13300
<b>P</b>			
PB-5094	4pc Pry Bar Set	G-18	3950
PC-514M	14pc Metric Punch & Chisel Set	G-17	6900
PC-514S	14pc SAE Punch & Chisel Set	G-17	6900
PC-565LU	5pc Long Taper Line Up Punch Set	G-16	4380
PC-566MP	6pc Metric Pin Punch Set	G-16	3180
PC-567F	7pc Flat Chisel Set	G-17	4270
PC-575C	5pc Center Punch Set	G-17	2680
PC-577SP	7pc SAE Pin Punch Set	G-16	3560
PC-BP4	4pc Oval Bearing Punch Set	G-14	3200
PK-AHP4	4pc Miniature Pick Set	J-9	1240
PK-OSP4	2pc O-Ring Ril Seal Pick Set	J-9	650
PR-009S	9pc SAE Combination Wrench Set (Mirror Finish)	F-5	7000
PR-011S	11pc SAE Combination Wrench Set (Mirror Finish)	F-6	9370
PR-015M	15pc Metric Combination Wrench Set (Mirror Finish)	H-39	10900
PR-016S	16pc SAE Combination Wrench (Mirror Finish)	F-6	17600
PR-017M	17pc Metric Combination Wrench Set (Mirror Finish)	F-6	11400
PR-026M	26pc Metric Combination Wrench Set (Mirror Finish)	F-6	28700
PR-1253	Piston Ring Compressor, capacity: 53~125mm, 3"L	J-6	2260
PR-1254	Piston Ring Compressor, capacity: 53~125mm, 3-1/2"L	J-6	2410
PR-1753	Piston Ring Compressor, capacity: 90~175mm, 3"L	J-6	2470
PR-1754	Piston Ring Compressor, capacity: 90~175mm, 3-1/2"L	J-6	2670
PR-1755	Piston Ring Compressor, capacity: 90~175mm, 4"L	J-6	2730
PR-1756	Piston Ring Compressor, capacity: 90~175mm, 6"L	J-6	3960
PR-1757	Piston Ring Compressor, capacity: 90~175mm, 6-1/2"L	J-6	4550
PR-5100	Piston Ring Pliers, capacity: 50~100mm	J-6	3070
PR-6120	Piston Ring Pliers, capacity: 80~120mm	J-6	3340
PR-7160	Piston Ring Pliers, capacity: 110~160mm	J-6	3740
PR-804	4 Piece Piston Ring Groove Cleaner Set	J-6	3680
PR-9809	9 Piece Piston Ring Service Tool Set	J-6	18480
<b>R</b>			
RB-207W	7pc Combination Reversible Blade Set	D-48	2600
RB-211W	11pc Combination Reversible Blade Set	D-48	3800
RP-280C	10pc Rust & Paint Removal Tool (Central-Vacuum Type)	E-27	67680
RP-280N	10pc Rust & Paint Removal Tool (Non-Vacuum Type)	E-27	63180
RP-5504	4pc Retaining Ring Pliers Set	H-23	8800

Item No.	Description	Pg.	Code
<b>S</b>			
SB-111SP	11pc Slotted & Philips Screwdriver Bit Set	D-26	620
SB-211MH	11pc Metric Hex & Triple Square Screwdriver Bit Set	D-26	610
SB-216TS	16pc Triple Square Screwdriver Bit Set	D-29	3130
SB-218MWH	18pc Metric Wobble Hex Screwdriver Bit Set	D-27	4370
SB-219SWH	19pc SAE Wobble Hex Screwdriver Bit Set	D-28	4800
SB-220MH	20pc Metric Hex Screwdriver Bit Set	D-27	4630
SB-221SP	21pc Slotted & Philips Screwdriver Bit Set	D-3	5150
SB-223SH	23pc SAE Hex Screwdriver Bit Set	D-28	5730
SB-224TOT	24pc Tamperproof Star Screwdriver Bit Set	D-13	6990
SB-225RHM	25pc Metric Hex & Square Screwdriver Bit Set	D-15	6150
SB-225TO	25pc Star Screwdriver Bit Set	D-29	6440
SB-227RHS	27pc SAE Hex & Square Screwdriver Bit Set	D-28	7180
SB-247M	47pc Screwdriver Bit Set	H-35	10100
SB-252M	52pc Metric Screwdriver Bit with OMNIDRIVE® Set	D-34	6950
SB-276MS	76pc Metric & SAE Screwdriver Complete Bit with OMNIDRIVE® Set	D-35	8750
SB-311SH	11pc SAE Hex Screwdriver Bit Set	D-26	600
SB-711TP	11pc Star Screwdriver Bit Set	D-26	580
SB-811TP	11pc Tamperproof Star Screwdriver Bit Set	D-26	960
SC-233	33pc 5/16" Hex Shank Screwdriver Bit Set	D-32	7000
SC-234A	34pc Ratcheting Screwdriver & Bit Set	D-30	4440
SC-237M	37pc Ratcheting Screwdriver & Bit Set	D-30	4760
SC-243	43pc 1/4" Hex Shank Screwdriver Bit Set	D-32	5000
SC-710	Scissor Action Industrial Riveter	G-7	7900
SC-714	Industrial Lever Riveter	G-7	6000
SC-715	Heavy Duty Hand Riveter Suitable For Stainless Steel Riveter	G-6	2800
SC-736	Free Section Hand Riveter	G-7	4100
SC-758A	Heavy Duty Hand Nut Riveter	G-7	6000
SC-785E	Effortless Industrial Hand Lever Riveter Set	G-8	7900
SC-785H	Effortless Industrial Hand Lever Riveter Set	G-8	9630
SC-785M	Effortless Industrial Hand Nut Riveter Set	G-8	13410
SC-785S	Effortless Industrial Hand Nut Riveter Set	G-8	13410
SC-GS701	Heavy Duty Hand Riveter	G-6	2600
SK-007BTW	7pc Folding Tamperproof Star Key Wrench Set	F-25	1540
SK-007BW	7pc Folding Star Key Wrench Set	F-25	1450
SK-009G	9pc Folding Star Key Wrench Set	F-27	1910
SK-009GT	9pc Folding Tamperproof Star Key Wrench Set	F-27	2040
SK-010L	10pc Star Key Wrench Set	F-32	2430
SK-010S	10pc Star Key Wrench Set	F-32	1400
SK-010SS	10pc Star Key Wrench Set (S2 Material)	F-24	1880
SK-010T	10pc Extra Long Tamperproof Star Key Wrench Set	F-33	2720
SK-010TS	10pc Extra Long Tamperproof Star Key Wrench Set (S2 Material)	F-24	3150
SP-304A	4pc Spark Plug Socket Set	J-7	4050
SS-422S	22pc 1/2" Dr. SAE Hand Socket Set	H-31	12000
SS-425M	25pc 1/2" Dr. Metric Hand Socket Set	H-31	11700
SS-619S	19pc 3/4" Dr. SAE Hand Socket Set (CR-Mo)	B-79	26000
SW-234105M	105pc 1/4", 3/8" & 1/2" Dr. Metric Hand Socket Display Board	H-64	46890
SW-23485S	85pc 1/4", 3/8" & 1/2" Dr. SAE Hand Socket Display Board	H-65	38695
SW-646M	46pc 3/4" Dr. Metric Hand Socket Display Board	H-66	43970
<b>T</b>			
TD-210S	10pc 1/4" Dr. SAE Deep Impact Socket Set	A-4	2890
TD-211M	11pc 1/4" Dr. Metric Deep Impact Socket Set	A-4	3190
TD-3415M	14pc 1/2" Dr. Metric Deep Impact Socket Set	A-22	3980
TD-3415S	14pc 1/2" Dr. SAE Deep Impact Socket Set	A-22	3980
TD-416M	16pc 1/2" Dr. Metric Deep Impact Socket Set	A-23	7365
TD-416M1	16pc 1/2" Dr. Metric Deep Impact Socket Set	A-23	8260
TD-416S	16pc 1/2" Dr. SAE Deep Impact Socket Set	A-23	8950
TF-001	8pc 3/8" Dr. SAE Impact Socket Set <b>NEW: TF-308S</b>	A-7	1265
TF-002	8pc 3/8" Dr. Metric Impact Socket Set <b>NEW: TF-308M</b>	A-7	1265
TF-003	8pc 3/8" Dr. SAE Deep Impact Socket Set <b>NEW: TD-308M</b>	A-6	1875
TF-004	8pc 3/8" Dr. Metric Deep Impact Socket Set <b>NEW: TD-308S</b>	A-6	1875
TF-005	10pc 1/2" Dr. SAE Impact Socket Set <b>NEW: TF-410S</b>	A-19	2210
TF-006	10pc 1/2" Dr. Metric Impact Socket Set <b>NEW: TF-410M</b>	A-19	2210
TF-007	10pc 1/2" Dr. SAE Deep Impact Socket Set <b>NEW: TD-410S</b>	A-21	3600
TF-008	10pc 1/2" Dr. Metric Deep Impact Socket Set <b>NEW: TD-410M</b>	A-21	3600
TF-008-1	10pc 1/2" Dr. Metric Deep Impact Socket Set <b>NEW: TD-410M1</b>	A-21	4600
TF-008-2	10pc 1/2" Dr. Metric Deep Impact Socket Set	A-21	4200
TF-015	14pc 1/2" Dr. SAE Impact Socket Set <b>NEW: TF-415S</b>	A-20	4060
TF-016	15pc 1/2" Dr. Metric Impact Socket Set <b>NEW: TF-415M</b>	A-20	4100
TF-019MS	18pc 1/2" Dr. Metric & SAE Impact Socket Set	A-24	4100

Item No.	Description	Pg.	Code	Item No.	Description	Pg.	Code
TF-031	13pc 1/2" Dr. SAE Deep Impact Socket Set <b>NEW: TD-4135</b>	A-20	6480	TO-210F25	10pc Torque Handle Set, 50 ~ 250 in. lbs.	F-38	21800
TF-2115	11pc 1/4" Dr. SAE Impact Socket Set	A-2	1990	TO-210N30	10pc Torque Handle Set, 6 ~ 30 Nm	F-38	21800
TF-214M	14pc 1/4" Dr. Metric Impact Socket Set	A-2	2530	TO-227L	27pc Torque Screwdriver Set, 9 ~ 50 in. lbs.	D-39	12420
TF-255MS	55pc 1/4" Dr. Metric & SAE Impact Socket Set	A-4	12000	TO-227N	27pc Torque Screwdriver Set, 1 ~ 5 Nm	D-39	12420
TF-313S	13pc 3/8" Dr. SAE Impact Socket Set	A-5	2000	TO-312F80	12pc Torque Handle Set, 15 ~ 80 ft. lbs.	F-38	25100
TF-313SD	13pc 3/8" Dr. SAE Deep Impact Socket Set	A-8	2900	TO-312N11	12pc Torque Handle Set, 19 ~ 110 Nm	F-38	25100
TF-316M	16pc 3/8" Dr. Metric Impact Socket Set	A-5	2400	TO-405EXT	5pc 1/2" Dr. Torque Extension Bar Set	J-13	11400
TF-316M1	16 Piece 3/8" Dr. Metric Air Impact Wrench Set	E-3	22500	TO-407M	7pc 1/2" Dr. Metric Car Wheel Torque Socket Set	J-11	18000
TF-316S1	16 Piece 3/8" Dr. SAE Air Impact Wrench Set	E-3	22500	TO-408F60	8pc Torque Handle Set, 10 ~ 60 ft. lbs.	F-38	20250
TF-326S	26pc 3/8" Dr. SAE Impact Socket Set	A-8	4410	TO-408N80	8pc Torque Handle Set, 15 ~ 80 Nm	F-38	20250
TF-332M	32pc 3/8" Dr. Metric Deep Impact Socket Set	H-26	5310	TO-408S	8pc 1/2" Dr. Metric & SAE Car Wheel Torque Socket Set	J-12	20600
TF-407	7pc 1/2" Dr. SAE Impact Socket Set	A-19	1490	TO-410EXT	10pc 1/2" Dr. Torque Extension Bar Set	J-13	21600
TF-407M1	7pc 1/2" Dr. Metric Impact Socket Set	A-19	1490	TO-410M	10pc 1/2" Dr. Metric Car Wheel Torque Socket Set	J-12	20360
TF-4131M	131pc 1/2" Dr. Metric Impact Socket Display (CR-V)	H-60	55500	TO-411F15	11pc Torque Handle Set, 30 ~ 150 ft. lbs.	F-39	27500
TF-4131MD	131pc 1/2" Dr. Metric Deep Impact Socket Display (CR-V)	H-61	78500	TO-411N21	11pc Torque Handle Set, 40 ~ 210 Nm	F-39	27500
TF-4133S	133pc 1/2" Dr. SAE Impact Socket Display (CR-V)	H-60	55500	TO-412MS	12pc 1/2" Dr. Metric & SAE Car Wheel Torque Socket Set	J-12	23890
TF-4133SD	133pc 1/2" Dr. SAE Deep Impact Socket Display (CR-V)	H-61	78500	TR-504S	4pc Square Screwdriver Set	D-41	2900
TF-416K1	16 Piece 1/2" Dr. Metric Air Impact Wrench Set	E-4	16800	TR-507S	7pc Slotted & Philips Screwdriver Set	H-36	3890
TF-416M	16pc 1/2" Dr. Metric Impact Socket Set	B-49	9050	TR-508Z	8pc Combination Screwdriver Set	H-36	4550
TF-416S	16pc 1/2" Dr. SAE Impact Socket Set	B-49	9050	TR-510TA	10pc Tamperproof Star Screwdriver Set	H-36	7790
TF-416S1	16 Piece 1/2" Dr. SAE Air Impact Wrench Set	E-5	16800	TR-511MS	11pc #5 Spline Dr. Metric & SAE Truck Wheel Impact Socket Set (CR-Mo)	A-78	72400
TF-425M	25pc 1/2" Dr. Metric Impact Socket Set	H-27	6660	TR-511S	11pc #5 Spline Dr. SAE Truck Wheel Impact Socket Set (CR-Mo)	A-78	63670
TF-425MD	25pc 1/2" Dr. Metric Deep Impact Socket Set	H-28	10800	TR-513ST	13pc Star Screwdriver Set	D-44	8430
TG-213	7pc 3/8" Dr. SAE Swivel Impact Socket Set	A-11	5010	TR-520PZ	20pc Combination Screwdriver Set	D-44	9600
TG-213-D	7pc 3/8" Dr. SAE Deep Swivel Impact Socket Set	A-11	7840	TR-611MS	11pc 3/4" Dr. Metric & SAE Truck Wheel Impact Socket Set (CR-Mo)	A-49	23090
TG-213M1	7pc 3/8" Dr. Metric Swivel Impact Socket Set	A-9	4920	TR-811M	11pc 1" Dr. Metric Truck Wheel Impact Socket Set (CR-Mo)	A-65	23400
TG-213M1D	7pc 3/8" Dr. Metric Deep Swivel Impact Socket Set	A-10	7740	TR-811MS	11pc 1" Dr. Metric & SAE Truck Wheel Impact Socket Set (CR-Mo)	A-65	26760
TG-215	7pc 1/2" Dr. SAE Swivel Impact Socket Set	A-28	6780	TR-811S	11pc 1" Dr. SAE Truck Wheel Impact Socket Set (CR-Mo)	A-65	23670
TG-215-D	7pc 1/2" Dr. SAE Deep Swivel Impact Socket Set	A-29	8730	TS-123	3 Drawer Tool Chest, 575 x 230 x 311mm	I-2	27800
TG-215M1	7pc 1/2" Dr. Metric Swivel Impact Socket Set	A-28	6680	TS-125	5 Tier Portable Tool Chest, 536 x 258 x 220mm	I-2	17500
TG-215M1D	7pc 1/2" Dr. Metric Deep Swivel Impact Socket Set	A-29	8630	TS-2270	70pc 1/4" Dr. Metric Hand Socket Set & Bit Set	H-17	11160
TG-308S	8pc 3/8" Dr. SAE Swivel Impact Socket Set	A-9	5700	TS-244	4 Drawer Top Chest, 655 x 450 x 390mm	I-2	60000
TG-308SD	8pc 3/8" Dr. SAE Deep Swivel Impact Socket Set	A-10	8930	TS-246	6 Drawer Top Chest, 968 x 450 x 600mm	I-4	113100
TG-312M	12pc 3/8" Dr. Metric Swivel Impact Socket Set	A-9	8550	TS-3244	44pc 1/4" & 3/8" Dr. Metric Hand Socket Set	H-17	19120
TG-312MD	12pc 3/8" Dr. Metric Deep Swivel Impact Socket Set	A-10	13420	TS-4222	22pc 1/2" Dr. Metric Hand Socket Set	H-16	16645
TG-406B	6pc 1/2" Dr. Impact Driver Set	D-38	3800	TS-4223	23pc 1/2" Dr. Metric Hand Socket Set	H-16	13255
TG-408S	8pc 1/2" Dr. SAE Swivel Impact Socket Set	A-28	7690	TS-465	5 Drawer Roller Cabinet, 686 x 466 x 666mm	I-3	108600
TG-408SA	8pc 1/2" Dr. SAE Semi-Deep Swivel Impact Socket Set	A-29	9330	TS-465P	5 Drawer Roller Cabinet (w/ Top Tray), 686 x 466 x 666mm	I-3	115100
TG-408SD	8pc 1/2" Dr. SAE Deep Swivel Impact Socket Set	A-29	9920	TS-467	7 Drawer Roller Cabinet, 686 x 466 x 820mm	I-3	124700
TG-411M	11pc 1/2" Dr. Metric Swivel Impact Socket Set	A-28	10480	TS-467P	7 Drawer Roller Cabinet (w/ Top Tray), 686 x 466 x 820mm	I-3	131200
TG-411MA	11pc 1/2" Dr. Metric Semi-Deep Swivel Impact Socket Set	A-28	12760	TS-468	7 Drawer Roller Cabinet, 980 x 463 x 820mm	I-4	163800
TG-411MD	11pc 1/2" Dr. Metric Deep Swivel Impact Socket Set	A-29	13540	TS-4763	63pc 1/4", 3/8" & 1/2" Dr. SAE Hand Socket Set	H-18	20015
TH-310M	10pc 3/8" Dr. Metric Hex Head Driver Set	C-5	4650	TS-5010	10pc Combination Screwdriver Set	H-18	5670
TH-310S	10pc 3/8" Dr. SAE Hex Head Driver Set	C-4	4950	TS-5026	26pc Combination Screwdriver Set	H-18	7745
TH-312M	12pc 3/8" Dr. Metric Hex Head Driver Set	C-5	8400	TS-710	6 Drawer Top Chest, 806 x 484 x 541mm	I-6	179800
TH-312S	12pc 3/8" Dr. SAE Hex Head Driver Set	C-5	8715	TS-7417	17pc Metric Combination Wrench Set (Mirror Finish)	H-19	12500
TH-321M	21pc 3/8" Dr. Metric Hex Head Driver Component Set	C-5	12120	TS-7418	18pc Metric Combination Wrench Set (Mirror Finish)	H-19	13930
TH-3416	16pc 3/8" & 1/2" Dr. Auto Repair Bit Socket Set	C-47	10460	TS-748	8 Drawer Side Cabinet, 506 x 495 x 920mm	I-6	193600
TH-408M	8pc 1/2" Dr. Metric Hex Head Driver Set	C-11	5330	TS-7517	17pc SAE Combination Wrench Set (Mirror Finish)	H-19	16330
TH-408MD	8pc 1/2" Dr. Metric Hex Head Driver Set	C-9	6180	TS-764	Roll Cart with 4 Drawers, 778 x 512 x 888mm	I-4	122400
TH-408S	8pc 1/2" Dr. SAE Hex Head Driver Set	C-11	5330	TS-768	Roll Cart with 5 Drawers, 1240 x 517 x 888mm	I-4	157200
TH-41015	15pc 1/2" Dr. 10mm Hex Shank Hex Bit Set	D-34	3100	TS-790	10 Drawer Top Chest, 660 x 455 x 483mm	I-5	91000
TH-410S	10pc 1/2" Dr. SAE Hex Head Driver Set	C-9	6000	TS-796	8 Drawer Roller Cabinet, 850 x 495 x 946mm	I-6	254000
TH-411M	11pc 1/2" Dr. Metric Hex Head Driver Set	C-9	6340	TS-797	7 Drawer Side Cabinet, 380 x 460 x 798mm	I-5	71900
TH-412H	12pc 1/2" Dr. Metric Hex Head Driver Set	C-11	11550	TS-798	7 Drawer Roller Cabinet, 670 x 460 x 813mm	I-5	104300
TH-412S	12pc 1/2" Dr. SAE Hex Head Driver Set	C-11	11550	TT-508SP	8pc Slotted & Philips Tang-Thru Screwdriver Set	D-43	10800
TH-415H	15pc 1/2" Dr. Metric Hex Head Driver Set	C-10	9900	TT-512PZ	12pc Combination Tang-Thru Screwdriver Set	D-43	12000
TL-504A	4pc Square Screwdriver Set	D-51	1862	TW-210S	10pc 1/4" Dr. SAE Hand Socket Set (12-Point)	B-8	1400
TL-506	6pc Micro-Tech Screwdriver Set	D-56	1650	TW-210SD	10pc 1/4" Dr. SAE Deep Hand Socket Set (12-Point)	B-9	2600
TL-506A	6pc Micro-Tech Screwdriver Set	D-56	1650	TW-211M	11pc 1/4" Dr. Metric Hand Socket Set (12-Point)	B-8	1540
TL-508	8pc Slotted & Philips Screwdriver Set	H-37	3800	TW-211MD	11pc 1/4" Dr. Metric Deep Hand Socket Set (12-Point)	B-8	2860
TL-508X	8pc Slotted & Philips Screwdriver Set	H-37	4450	TW-227MS	27pc 1/4" Dr. Metric & SAE Hand Socket Set	H-23	7990
TL-515X	15pc Combination Screwdriver & Pry Bar Set	D-54	8250	TW-230M	30pc 1/4" Dr. Metric Deep Hand Socket Set	H-22	9980
TL-517X	17pc Combination Screwdriver Set	D-54	8730	TW-242MS	42pc 1/4" Dr. Metric & SAE Deep Hand Socket Set (12-Point)	B-17	11000
TL-518	18pc Slotted & Philips Screwdriver Set	H-51	7600	TW-314S	14pc 3/8" Dr. SAE Hand Socket Set (12-Point)	B-30	3510
TM-305	5pc 3/8" Dr. Triple Square Head Driver Set	C-6	2625	TW-314SD	14pc 3/8" Dr. SAE Deep Hand Socket Set (12-Point)	B-30	5080
TM-405	5pc 1/2" Dr. Triple Square Head Driver Set	C-9	3675	TW-316M	16pc 3/8" Dr. Metric Hand Socket Set (12-Point)	B-30	3725
TO-148F15	8pc Torque Handle Hook Head Set, 30 ~ 150 ft. lbs.	F-40	40100	TW-316MD	16pc 3/8" Dr. Metric Deep Hand Socket Set (12-Point)	B-30	5535
TO-148N21	8pc Torque Handle Hook Head Set, 40 ~ 210 Nm	F-40	40100	TW-408M1	8pc 1/2" Dr. Metric Hand Socket Set (12-Point)	B-63	7200
				TW-408S1	8pc 1/2" Dr. SAE Hand Socket Set (12-Point)	B-63	7200

Item No.	Description	Pg.	Code
TW-4131M	131pc 1/2" Dr. Metric Hand Socket Display (12-Point)	H-62	68250
TW-4131MD	131pc 1/2" Dr. Metric Deep Hand Socket Display (12-Point)	H-63	102500
TW-4133S	133pc 1/2" Dr. SAE Hand Socket Display (12-Point)	H-62	68250
TW-4133SD	133pc 1/2" Dr. SAE Deep Hand Socket Display (12-Point)	H-63	102500
TW-414S	14pc 1/2" Dr. SAE Hand Socket Set (12-Point) <b>NEW: TW-415S</b>	B-63	6000
TW-415M	15pc 1/2" Dr. Metric Hand Socket Set (12-Point)	B-63	5750
TW-416M	16pc 1/2" Dr. Metric Hand Socket Set (12-Point)	B-64	10850
TW-416MAM	16pc 1/2" Dr. Metric Hand Socket Set (12-Point)	B-65	11600
TW-416S	16pc 1/2" Dr. SAE Hand Socket Set (12-Point)	B-64	11000
TW-418M	18pc 1/2" Dr. Metric Hand Socket Set (12-Point)	B-65	12450
TW-418S	18pc 1/2" Dr. SAE Hand Socket Set (12-Point)	B-65	12450
TW-422M1	22pc 1/2" Dr. Metric Hand Socket Set (12-Point)	B-66	14700
TW-423M	23pc 1/2" Dr. Metric Hand Socket Set	H-32	15560
TW-423S	23pc 1/2" Dr. SAE Hand Socket Set	H-32	15990
TW-424M	24pc 1/2" Dr. Metric Hand Socket Set (12-Point)	B-67	15200
TW-424M4	23pc 1/2" Dr. Metric Hand Socket Set (12-Point) <b>NEW: TW-423M4</b>	B-66	16600
TW-424S	24pc 1/2" Dr. SAE Hand Socket Set (12-Point)	B-67	15700
TW-424S4	23pc 1/2" Dr. SAE Hand Socket Set (12-Point) <b>NEW: TW-423S4</b>	B-66	17010
TW-432S	32pc 1/2" Dr. SAE Hand Socket Set (12-Point)	B-68	18100
TW-439M	39pc 1/2" Dr. Metric Hand Socket Set (12-Point)	B-68	21000
TW-446MS	46pc 1/2" Dr. Metric & SAE Hand Socket Set (12-Point)	B-69	27800
TW-625M	25pc 3/4" Dr. Metric Hand Socket Set (12-Point) (CR-Mo)	B-87	41230
TW-625S	25pc 3/4" Dr. SAE Hand Socket Set (12-Point) (CR-Mo)	B-87	46670
TW-626MS	26pc 3/4" Dr. Metric & SAE Hand Socket Set (6 & 12-Point)	B-88	38480
TW-628MS	28pc 3/4" Dr. Metric & SAE Hand Socket Set (6 & 12-Point)	B-88	46180
TX-2315	15pc 1/2" Dr. Star Hand Socket Set	B-72	5065
TX-2319	19pc 1/2" Dr. Star Hand Socket Set	B-72	8500
TX-2324	24pc Star Wrench Set	H-25	9100
TX-23414	14pc 1/2" Dr. Star Hand Socket Set	B-20	5760
TX-23440	40pc 1/4", 3/8" & 1/2" Dr. Star Type Component Set	D-31	10000
TX-23475M	75pc Metric Extra Complete Screwdriver Bit Set	D-36	18700
TX-23478S	78pc SAE Extra Complete Screwdriver Bit Set	D-37	19700
TX-2353	53pc 1/4" & 3/8" Dr. Complete Bit Socket Set	H-33	13580
TX-2356	56pc 1/2" Dr. Complete Star Type Wrench Set	B-73	20200
TX-246M	46pc Metric Long Screwdriver Bit With OMNIDRIVE® Set	D-33	14700
TX-246S	46pc SAE Long Screwdriver Bit With OMNIDRIVE® Set	D-33	14700
TX-311	11pc 3/8" Dr. Star Head Driver Set	C-3	5500
TX-321	21pc 3/8" Dr. Star Head Driver Component Set	C-2	12120
TX-3440	40pc 3/8" & 1/2" 10mm Hex Shank Mechanics Bit Set	D-31	7000
TX-409	9pc 1/2" Dr. Star Hand Socket Set	B-72	5750
TX-41015	15pc 1/2" Dr. 10mm Hex Shank Star Bit Set	D-35	3100
TX-412	12pc 1/2" Dr. Bit Socket Set	H-25	8760
TX-415	15pc 1/2" Dr. Star Head Driver Component Set	C-9	11400
TX-512A	12pc Tamperproof Star Screwdriver Set	H-37	5800
TX-513T	13pc Star Screwdriver Set	D-54	6150
TX-E04	4pc E-Star Wrench Set	F-16	3100
U			
UA-23411	11pc 1/4", 3/8" & 1/2" Dr. Universal Joint & Adapter Set	A-22	5845
US-206S	6pc 1/4" Dr. SAE Universal Hand Socket Set (12-Point)	B-8	3000
US-209M	9pc 1/4" Dr. Metric Universal Hand Socket Set (12-Point)	B-8	4400
US-307S	7pc 3/8" Dr. SAE Universal Hand Socket Set (12-Point)	B-28	4250
US-310M	10pc 3/8" Dr. Metric Universal Hand Socket Set (12-Point)	B-28	6000
V			
V38200	3/8" Dr. Digital Torque Wrench, 20~200 Nm	F-37	VMARK
V48340	1/2" Dr. Digital Torque Wrench, 20~200 Nm	F-37	VMARK
V782S08	Heavy Duty Pipe Wrench, 200mmL(8")	F-34	VMARK
V782S10	Heavy Duty Pipe Wrench, 250mmL(10")	F-34	VMARK
V782S12	Heavy Duty Pipe Wrench, 300mmL(12")	F-34	VMARK
V782S14	Heavy Duty Pipe Wrench, 350mmL(14")	F-34	VMARK
V782S18	Heavy Duty Pipe Wrench, 460mmL(18")	F-34	VMARK
V782S24	Heavy Duty Pipe Wrench, 610mmL(24")	F-34	VMARK
V782S36	Heavy Duty Pipe Wrench, 910mmL(36")	F-34	VMARK

Item No.	Description	Pg.	Code
V782S48	Heavy Duty Pipe Wrench, 1220mmL(48")	F-34	VMARK
V794A14	Aluminum Pipe Wrench, 350mmL(14")	F-34	VMARK
V794A18	Aluminum Pipe Wrench, 460mmL(18")	F-34	VMARK
V794A24	Aluminum Pipe Wrench, 610mmL(24")	F-34	VMARK
V794A36	Aluminum Pipe Wrench, 910mmL(36")	F-34	VMARK
V794A48	Aluminum Pipe Wrench, 1220mmL(48")	F-34	VMARK
W			
WS-759	Multi-Function Workstation Set, 1530 x 706 x 1590mm	I-7	157300
X			
XV-246M	46pc 1/4" Dr. Metric Hand Socket Set	B-18	VMARK
XV-424M	24pc 1/2" Dr. Metric Hand Socket Set	B-55	VMARK
XV-424MW	24pc 1/2" Dr. Metric Hand Socket Set (12-Point)	B-54	VMARK
XV-424MW4	24pc 1/2" Dr. Metric Hand Socket Set (12-Point)	B-54	VMARK
XVOT209	7pc Oxygen Sensor Wrench Set	J-4	VMARK
XVS-424M	24pc 1/2" Dr. Metric Hand Socket Set	B-54	VMARK



# Alphabetical Index

## A

### Air Impact Wrenches

3/8" Drive	E-3
1/2" Drive	E-4
3/4" Drive	E-10
1" Drive	E-13
1-1/2" Drive	E-17
#5 Spline Drive	E-18

### Air Ratchets

1/4" Drive	E-2
3/8" Drive	E-2
1/2" Drive	E-2

### Air Tools

Air Angle Grinders	E-19
Air Blow Guns	E-29
Air Cutter	E-25
Air Die Grinders	E-20
Air Drills	E-24
Air Eraser	E-25
Air Files	E-25
Air Micro Die Grinders	E-22
Air Sanders	E-26
Air Spray Guns	E-28
Air Riveters	E-22
Air Screwdrivers	E-19
Air Tire Buffer	E-25
Rust & Paint Removal Tools	E-27

### Automotive Tools

Automotive Tools	J-2
Budd Wheel Impact Sockets	J-15
Extractors	J-8
Extra Long Budd Wheel Impact Sockets	J-10
Feeler Gauge	J-5
Flip Sockets	J-19
Heater Hose Clamp Pliers	J-10
Hose Clamp Drivers	J-8
Oil Filter Pliers	J-7
Piston Ring Service Tools	J-6
Wheel Balancing Weight Tool	J-10

## D

### Deep Hand Sockets

1/4" Drive (6-Point)	B-2
1/4" Drive (12-Point)	B-3
3/8" Drive (6-Point)	B-21
3/8" Drive (12-Point)	B-23
1/2" Drive (6-Point)	B-39
1/2" Drive (12-Point)	B-41
3/4" Drive	B-80

### Deep Impact Sockets

1/4" Drive	A-3
3/8" Drive (CRV)	A-6
3/8" Drive (CRMO)	A-13
1/2" Drive (CRV)	A-18
1/2" Drive (CRMO)	A-31
3/4" Drive	A-44
1" Drive	A-55
1-1/2" Drive	A-68
#5 Spline Drive	A-77

### Double Square Hand Sockets

1/4" Drive	B-4
------------	-----

## E

### E-Star Deep Hand Sockets

1/2" Drive	B-42
------------	------

### E-Star Deep Impact Sockets

1/2" Drive	A-35
------------	------

### E-Star Hand Sockets

1/4" Drive	B-4
3/8" Drive	B-20
1/2" Drive	B-42

### E-Star Impact Sockets

1/2" Drive	A-35
------------	------

## F

### Files

Air Files	G-12
Diamond Files	G-12
Machinists Files (2nd. Cut)	G-13
Small Files	G-12

## H

### Hammers

Ball Peen Hammers	G-14
Claw Hammers	G-14
Drilling Hammers	G-14
Rubber Mallet	G-14
Soft Face Hammer	G-14

### Hand Adapters

1/4" Drive	B-7
3/8" Drive	B-24
1/2" Drive	B-42
3/4" Drive	B-83
1" Drive	B-94

### Hand Bit Holders

1/4" Drive	D-21
3/8" Drive	D-21
1/2" Drive	D-21

### Hand Extension Bars

1/4" Drive	B-7
3/8" Drive	B-24
1/2" Drive	B-46
3/4" Drive	B-83
1" Drive	B-94

### Hand Sockets

1/4" Drive (6-Point)	B-2
1/4" Drive (12-Point)	B-3
3/8" Drive (6-Point)	B-20
3/8" Drive (12-Point)	B-22
1/2" Drive (6-Point)	B-38
1/2" Drive (12-Point)	B-40
3/4" Drive (6-Point)	B-78
3/4" Drive (12-Point)	B-82
1" Drive (6-Point)	B-89
1" Drive (12-Point)	B-92

**Hex Bit Sockets**

1/4" Drive	C-18
3/8" Drive	C-24
1/2" Drive	C-49
3/4" Drive	C-12
1" Drive	C-14
1-1/2" Drive	C-16

**Hex Head Drivers**

3/8" Drive	C-4
1/2" Drive	C-8
3/4" Drive	C-12
1" Drive	C-15

**Hex Head Hand Sockets**

1/4" Drive	B-5
------------	-----

**Hinge Handles**

1/4" Drive	B-6
3/8" Drive	B-26
1/2" Drive	B-44
3/4" Drive	B-84
1" Drive	B-94

**I****Impact Adapters**

1/4" Drive	A-3
3/8" Drive (CRV)	A-7
3/8" Drive (CRMO)	A-14
1/2" Drive (CRV)	A-17
1/2" Drive (CRMO)	A-36
3/4" Drive	A-46
1" Drive	A-59
1-1/2" Drive	A-67
2-1/2" Drive	A-70
#5 Spline Drive	A-78

**Impact Bit Holders**

1/4" Drive	A-3
3/8" Drive (CRV)	A-7
3/8" Drive (CRMO)	A-14
1/2" Drive (CRV)	A-17
1/2" Drive (CRMO)	A-36
3/4" Drive	D-20
1" Drive	D-20
1-1/2" Drive	D-20

**Impact Drivers**

3/8" Drive	D-38
1/2" Drive	D-38

**Impact Extension Bars**

1/4" Drive	A-3
3/8" Drive (CRV)	A-7
3/8" Drive (CRMO)	A-14
1/2" Drive (CRV)	A-18
1/2" Drive (CRMO)	A-36
3/4" Drive	A-47
1" Drive	A-59
1-1/2" Drive	A-69
2-1/2" Drive	A-70
#5 Spline Drive	A-78

**Impact Screwdriver Bits**

Impact Hex Screwdriver Bits	D-20
Impact Star Screwdriver Bits	D-20
Impact Triple Square Screwdriver Bits	D-20

**Impact Sockets**

1/4" Drive	A-2
3/8" Drive (CRV)	A-5
3/8" Drive (CRMO)	A-12
1/2" Drive (CRV)	A-17
1/2" Drive (CRMO)	A-30
3/4" Drive	A-42
1" Drive	A-54
1-1/2" Drive	A-66
2-1/2" Drive	A-70
3-1/2" Drive	A-73
#5 Spline Drive	A-76

**Impact Universal Joints**

1/4" Drive	A-3
3/8" Drive	A-7
1/2" Drive	A-18
3/4" Drive	A-47
1" Drive	A-59
1-1/2" Drive	A-67
#5 Spline Drive	A-78

**K****Key Wrenches**

Folding Key Wrench Sets - S2 Material	F-25
Hex key Wrenches	F-28
Key Wrench Sets - S2 Material	F-22
Long Hex key Wrenches	F-29
Star key Wrenches	F-32
Tamperproof Star key Wrenches	F-33
Triple Square Key Wrenches	F-33
Wobble Hex key Wrenches	F-31

**L****L-Handles**

3/8" Drive	B-25
1/2" Drive	B-43
3/4" Drive	B-83

**Locking Pliers**

Claw-Grip Pliers	
Curved Jaw Locking Pliers with Cutter	G-5
Hose Clamp Pliers	G-6
Oil Filter Locking Pliers	G-6
Large Jaw Locking Pliers	G-5
Locking "C" Clamps	G-5
Locking Chain Pliers	G-6
Locking Welding Clamp	G-5
Long Nose Locking Pliers with Cutter	G-5
Pinch-Off Locking Pliers	G-5
Sheet Metal Pliers	G-5
Straight Jaw Locking Pliers	G-5

**M****Master Sets**

Display Boards	H-64
Display Cases	H-60
Long Size Tool Trays	H-16
1/6 Size Tool Trays	H-21
1/3 Size Tool Trays	H-26
1/2 Size Tool Trays	H-40
2/3 Size Tool Trays	H-51
Full Size Tool Trays	H-52
Master Sets	H-2

**Miscellaneous Tools**

Grease Gun	K-3
Magnetic Bar Tool Holders	K-2
Magnetic Fender Covers	J-8
Magnetic Parts Trays	K-2
Mirror Tools	K-3
Oil Suction Gun	K-3
Pick-Up Tools	K-3
Socket Rails with Clips	K-2

**P****Pentacle Bit Sockets**

1/4" Drive	C-22
3/8" Drive	C-31
1/2" Drive	C-53

**Philips Bit Sockets**

1/4" Drive	C-17
3/8" Drive	C-23
1/2" Drive	C-48

**Philips Head Drivers**

3/8" Drive	C-2
1/2" Drive	C-7

**Philips Head Hand Sockets**

1/4" Drive	B-4
------------	-----

**Pliers**

Aviation Snips	G-10
Bent Nose Pliers	G-2
Chain Nose Pliers with Cutter	G-2
Combination (Slip Joint) Pliers	G-3
Diagonal Cutting Pliers	G-2
Duckbill Pliers	G-3
End Cutter Pliers	G-3
Hose Clamp Pliers	G-3
Needle Nose Pliers	G-3
Retaining Ring Pliers	G-2
Side Cutter Pliers	G-2
Tongue and Groove Pliers	G-3
Water Pump Pliers	G-4

**Power Screwdriver Bits**

Power Hex Screwdriver Bits	D-19
Power Philips Screwdriver Bits	D-18
Power Posidriv Screwdriver Bits	D-18
Power Slotted Screwdriver Bits	D-18
Power Star Screwdriver Bits	D-19

**Pry Bars**

Close Quarters Bar	G-18
Pry Bars	G-18

**Pullers**

Three-Jaw Gear Pullers	G-11
Two-Arm Gear Pullers	G-11
Two-Jaw Gear Pullers	G-11

**Punches**

Center Punches	G-15
Flat Chisels	G-15
Flat Chisels with Handle Guard	G-18
Long Taper Line Up Punches	G-15
Oval Bearing Punches	G-14
Pin Punches	G-15

**R****Ratchets**

1/4" Drive	B-5
3/8" Drive	B-26
1/2" Drive	B-44
3/4" Drive	B-84
1" Drive	B-94

**Ribe Bit Sockets**

1/4" Drive	C-20
3/8" Drive	C-32
1/2" Drive	C-53

**Riveters**

Hand Nut Riveters	G-7
Hand Riveters	G-6
Air Riveters	E-22

**S****Screwdriver Bits**

Hex Screwdriver Bits	D-4
Pentacle Screwdriver Bits	D-16
Philips Screwdriver Bits	D-3
Posidriv Screwdriver Bits	D-16
Ribe Screwdriver Bits	D-17
Slotted Screwdriver Bits	D-2
Spanner Screwdriver Bits	D-17
Square Screwdriver Bits	D-15
Star Screwdriver Bits	D-10
Tamperproof Star Screwdriver Bits	D-12
Triple Square Screwdriver Bits	D-14
Wobble Hex Screwdriver Bits	D-8

**Screwdrivers**

Hex Nut Drivers	D-62
Hex Screwdrivers	D-42
Micro-Tech Screwdrivers	D-55
Nut Drivers	D-58
Offset Screwdrivers	F-27
Philips Screwdrivers	D-40
Posidriv Screwdrivers	D-40
Ratcheting Screwdrivers	D-23
Reversible Blades	D-48
Slotted Screwdrivers	D-40
Square Screwdrivers	D-41
Star Screwdrivers	D-41
Tamperproof Star Screwdrivers	D-41
Torque Screwdrivers	D-39
Wobble Hex Screwdrivers	D-42

**Sliding T-Handles**

1/4" Drive	B-7
3/8" Drive	B-25
1/2" Drive	B-43
3/4" Drive	B-84
1" Drive	B-94
1-1/2" Drive	A-69

**Slotted Bit Sockets**

1/4" Drive	C-17
3/8" Drive	C-23
1/2" Drive	C-48

**Slotted Head Drivers**

3/8" Drive	C-2
1/2" Drive	C-7

<b>Slotted Head Hand Sockets</b>	
1/4" Drive	B-4
<b>Spanner Bit Sockets</b>	
1/4" Drive	C-22
<b>Spark Plug Sockets</b>	
3/8" Drive	B-25
1/2" Drive	B-43
<b>Spinner Handles</b>	
Spinner Handles	D-22
Spinner Handles (for Electric Drill)	D-22
<b>Speed Handles</b>	
3/8" Drive	B-25
1/2" Drive	B-42
<b>Star Bit Sockets</b>	
1/4" Drive	C-20
3/8" Drive	C-28
1/2" Drive	C-54
3/4" Drive	C-13
<b>Star Head Drivers</b>	
3/8" Drive	C-3
1/2" Drive	C-7
<b>Stud Bolt Sockets</b>	
3/8" Drive	J-19
1/2" Drive	J-19
<b>Stud Remover Sockets</b>	
3/8" Drive	J-20
1/2" Drive	J-20
<b>Swivel Impact Sockets</b>	
3/8" Drive	A-9
1/2" Drive	A-26

## T

<b>Tang-Thru Screwdrivers</b>	
Philips Tang-Thru Screwdrivers	D-43
Posidriv Tang-Thru Screwdrivers	D-43
Slotted Tang-Thru Screwdrivers	D-43
<b>Tamperproof Star Bit Sockets</b>	
1/4" Drive	C-21
3/8" Drive	C-29
1/2" Drive	C-55
<b>Thin Wall Impact Sockets</b>	
1/2" Drive (6-Point)	A-32
1/2" Drive (12-Point)	A-33
1/2" Drive Semi-Deep (6-Point)	A-33
1/2" Drive Deep (12-Point)	A-34
3/4" Drive (12-Point)	A-46
3/4" Drive Deep (6-Point)	A-45
1" Drive (6-Point)	A-59
1" Drive Deep (6-Point)	A-59
#5 Spline Drive (6-Point)	A-77
<b>Tool Storage</b>	
Display Stands	I-8
Roller Cabinets	I-3
Side Cabinets	I-5
Tool Chests	I-2
Top Chests	I-2
Workstation Set	I-7

<b>Torque Tools</b>	
Digital Torque Wrenches	F-37
Torque Extensions	J-13
Torque Handle Sets	F-38
Torque Multipliers	F-37
Torque Screwdrivers	F-35
Torque Sockets	J-11
Torque Wrenches	F-36
<b>Triple Square Bit Sockets</b>	
1/4" Drive	C-21
3/8" Drive	C-30
1/2" Drive	C-56
3/4" Drive	C-13
<b>Triple Square Head Drivers</b>	
3/8" Drive	C-6
1/2" Drive	C-8
<b>Truck Wheel Impact Sockets</b>	
3/4" Drive	A-49
1" Drive	A-65
#5 Spline Drive	A-78

## U

<b>Universal Hand Sockets</b>	
1/4" Drive	B-4
3/8" Drive	B-23
<b>Universal Joints</b>	
1/4" Drive	B-7
3/8" Drive	B-24
1/2" Drive	B-43
3/4" Drive	B-83
1" Drive	B-94

## W

<b>Wobble Extension Bars</b>	
1/4" Drive	B-7
3/8" Drive	B-24
1/2" Drive	B-46
<b>Wobble Hex Bit Sockets</b>	
1/4" Drive	C-18
3/8" Drive	C-26
1/2" Drive	C-52
<b>Wrenches</b>	
Adjustable Wrenches	F-34
Combination Wrenches - Matt Finish	F-2
Combination Wrenches - Mirror Finish	F-5
Combination Ratcheting Wrenches	F-11
Double Ended Offset Ring Wrenches - Matt Finish	F-7
Double Ended Offset Ring Wrenches - Mirror Finish	F-7
Double Flexible Socket Wrenches - Mirror Finish	F-15
E-Star Wrenches	F-16
Extra Long Box End Wrenches	F-14
Flare Nut Wrenches	F-10
Open End Wrenches	F-17
Pipe Wrenches	F-34
Stubby Combination Ratcheting Wrenches	F-13

# CONVERSION TABLE

Inches & Millimeters Conversion Table														
Inch	=	mm	Inch	=	mm	Inch	=	mm	Inch	=	mm			
1/32	=	0.7938	1-1/32	=	26.1938	2-1/32	=	51.5938	3-1/32	=	76.9938	4-1/32	=	102.3938
1/16	=	1.5875	1-1/16	=	26.9875	2-1/16	=	52.3875	3-1/16	=	77.7875	4-1/16	=	103.1875
3/32	=	2.3812	1-3/32	=	27.7812	2-3/32	=	53.1812	3-3/32	=	78.5812	4-3/32	=	103.9812
1/8	=	3.1750	1-1/8	=	28.5750	2-1/8	=	53.9750	3-1/8	=	79.3750	4-1/8	=	104.7750
5/32	=	3.9688	1-5/32	=	29.3688	2-5/32	=	54.7688	3-5/32	=	80.1688	4-5/32	=	105.5688
3/16	=	4.7625	1-3/16	=	30.1625	2-3/16	=	55.5625	3-3/16	=	80.9625	4-3/16	=	106.3625
7/32	=	5.5562	1-7/32	=	30.9562	2-7/32	=	56.3562	3-7/32	=	81.7562	4-7/32	=	107.1562
1/4	=	6.3500	1-1/4	=	31.7500	2-1/4	=	57.1500	3-1/4	=	82.5500	4-1/4	=	107.9500
9/32	=	7.1438	1-9/32	=	32.5438	2-9/32	=	57.9438	3-9/32	=	83.3438	4-9/32	=	108.7438
5/16	=	7.9375	1-5/16	=	33.3375	2-5/16	=	58.7375	3-5/16	=	84.1375	4-5/16	=	109.5375
11/32	=	8.7312	1-11/32	=	34.1312	2-11/32	=	59.5312	3-11/32	=	84.9312	4-11/32	=	110.3312
3/8	=	9.5250	1-3/8	=	34.9250	2-3/8	=	60.3250	3-3/8	=	85.7250	4-3/8	=	111.1250
13/32	=	10.3188	1-13/32	=	35.7188	2-13/32	=	61.1188	3-13/32	=	86.5188	4-13/32	=	111.9188
7/16	=	11.1125	1-7/16	=	36.5125	2-7/16	=	61.9125	3-7/16	=	87.3125	4-7/16	=	112.7125
15/32	=	11.9062	1-15/32	=	37.3062	2-15/32	=	62.7062	3-15/32	=	88.1062	4-15/32	=	113.5062
1/2	=	12.7000	1-1/2	=	38.1000	2-1/2	=	63.5000	3-1/2	=	88.9000	4-1/2	=	114.3000
17/32	=	13.4938	1-17/32	=	38.8938	2-17/32	=	64.2938	3-17/32	=	89.6938	4-17/32	=	115.0938
9/16	=	14.2875	1-9/16	=	39.6875	2-9/16	=	65.0875	3-9/16	=	90.4875	4-9/16	=	115.8875
19/32	=	15.0812	1-19/32	=	40.4812	2-19/32	=	65.8812	3-19/32	=	91.2812	4-19/32	=	116.6812
5/8	=	15.8750	1-5/8	=	41.2750	2-5/8	=	66.6750	3-5/8	=	92.0750	4-5/8	=	117.4750
21/32	=	16.6688	1-21/32	=	42.0688	2-21/32	=	67.4688	3-21/32	=	92.8688	4-21/32	=	118.2688
11/16	=	17.4625	1-11/16	=	42.8625	2-11/16	=	68.2625	3-11/16	=	93.6625	4-11/16	=	119.0625
23/32	=	18.2562	1-23/32	=	43.6562	2-23/32	=	69.0562	3-23/32	=	94.4562	4-23/32	=	119.8562
3/4	=	19.0500	1-3/4	=	44.4500	2-3/4	=	69.8500	3-3/4	=	95.2500	4-3/4	=	120.4500
25/32	=	19.8438	1-25/32	=	45.2438	2-25/32	=	70.6438	3-25/32	=	96.0438	4-25/32	=	121.4438
13/16	=	20.6375	1-13/16	=	46.0375	2-13/16	=	71.4375	3-13/16	=	96.8375	4-13/16	=	122.2375
27/32	=	21.4312	1-27/32	=	46.8312	2-27/32	=	72.2312	3-27/32	=	97.6312	4-27/32	=	123.0312
7/8	=	22.2250	1-7/8	=	47.6250	2-7/8	=	73.0250	3-7/8	=	98.4250	4-7/8	=	123.8250
29/32	=	23.0188	1-29/32	=	48.4188	2-29/32	=	73.8188	3-29/32	=	99.2188	4-29/32	=	124.6188
15/16	=	23.8125	1-15/16	=	49.2125	2-15/16	=	74.6125	3-15/16	=	100.0125	4-15/16	=	125.4125
31/32	=	24.6062	1-31/32	=	50.0062	2-31/32	=	75.4062	3-31/32	=	100.8062	4-31/32	=	126.2062
1	=	25.4000	2	=	50.8000	3	=	76.2000	4	=	101.6000	5	=	127.0000

Torque Conversion Table				
Nm	kgf m	kgf cm	lbf feet	lbf inch
1.00000	0.10197	10.1970	0.73756	8.85070
9.80680	1.00000	100.000	7.23300	86.8055
0.09806	0.01000	1.00000	0.07233	0.86800
1.35580	0.13825	13.8250	1.00000	12.0000
0.11298	0.01152	1.15207	0.08333	1.00000

# Collections



## **FC-086** **MAGNETIC FENDER COVER**

**Feature**  
Includes strong magnets which attract and stay on any metal surface easily.  
80 x 60cm (also available in 105 x 58cm)

## **CL-2299** **TOOLMAN STATUE**

**Feature**  
Dimension: W545 x D370 x H1,000 mm



## **CL-2204** **KNIFE SET**

**Feature**  
4 piece set including chefs, bread, paring and utility knives.

## **CL-2203** **BASEBALL CAP**

**Feature**  
Embroidered logo



## **KN-4018** **Snap-off Knife**

**Feature**  
18mm Blade  
Auto-Loading System



## **MT-83525** **Measuring Tape**

**Feature**  
Two-Side Scale  
Rubber Hook w/Magnet  
Rubber Grip & Anti-Slip Hook



## **MT-80525** **Measuring Tape**

**Feature**  
Double Locking System  
(Stop & Pause Button)



## **CL-2201** **JACKET**

**Feature**  
Embroidered logo.  
Available in Size S to 3L.



## **CL-2202** **POLO SHIRT**

**Feature**  
Embroidered logo.  
Available in Size XS to 6L.



## **CL-2855** **BINDER**

**Feature**  
4-Ring Binder  
Dimension: 285 x 320 x 55 mm



## **CL-2259** **TOOL BAG**

**Feature**  
A tool bag to keep tools organized.  
43x25x36cm (17x10x14"), shoulder straps.



## **CL-2258** **TOOL BELT**

**Feature**  
A tool belt for keeping tools and supplies handy.  
76x36cm (30x14"), adjustable belt.



## **CL-2260** **TOTE BAG**

**Feature**  
An excellent replacement for plastic or paper bags.  
38x38cm (15x15") canvas tote bag.