



DLAB

DLAB

CATALOGUE

www.dlabsci.com

2021

DLAB

DLAB Scientific Inc.

Add: 18150 Rowland st. City of Industry, CA 91748

Tel: +1- 424- 248-3580

Fax: +1-909-230-5275

E-mail: info@dlabsci.com

Service contact: service@dlabsci.com

web: www.dlabsci.com



CENTRIFUGES



THERMAL CONTROL



MISCELLANEOUS



DISTILLING

MIXING & HEATING

LIQUID HANDLING





Company Profile

DLAB Scientific Co., Ltd, known as Dragon Lab - founded in 2002, is now one of the leading companies worldwide for high quality laboratory instruments and equipment for chemical, biological and clinical diagnostical labs.

All our products are designed and manufactured in accordance with ISO9001/13485 by our dedicated and experienced R&D Engineering team. Our quality control processes start from the metal processing all the way through to the final inspections of the end products and adhere to worldwide accepted quality standards.

With growing international presence and to create a new corporate identity, we have created a new brand "DLAB". Consequently, Dragon Laboratory Instruments changed to DLAB Scientific, the original manufacturer of bench top equipments. DLAB has subsidiaries in USA as DLAB Scientific Inc., in Europe as DLAB Scientific S.A.S and in India as DLAB Scientific Private Limited.

DLAB Scientific is committed to become a one-stop partner for distributors worldwide with a growing range of general laboratory instruments. Our products are characterized by reliability, high accuracy and have a highly competitive value along with skilled application and after-sales support.

Our brands include: DRAGONLAB™, DLAB™, DRAGONMED™, DRAGON™ and so on.

"DLAB, your accessible solution"



www.dlabsci.com

Contents



Liquid Handling

- liquid handling Series / 03
- Electronic Pipette / 05
- Mechanical Pipettes / 09
- Pipette Fillers / 17
- Pipette Controllers & Pumps / 19
- Stepper / 20
- Electronic Titrator / 22
- Electronic Bottle-Top Dispenser / 23
- Bottle-Top Dispensers / 24
- Vacuum Aspiration System / 25



- Thermal Control Series/31
- Thermal Cyclers / 33
- Real-time PCR System/35
- Dry Bath / 38
- Thermo Mix / 42
- Water Bath / 44



Distilling

- Distilling Series / 46
- Rotary Evaporator / 47
- Low Temperature Circulator / 53
- Vacuum Controller / 56



Thermal Control

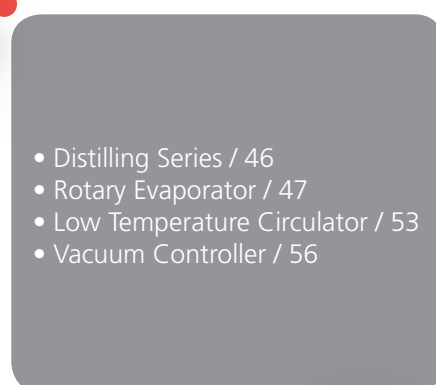

Mixing & Heating

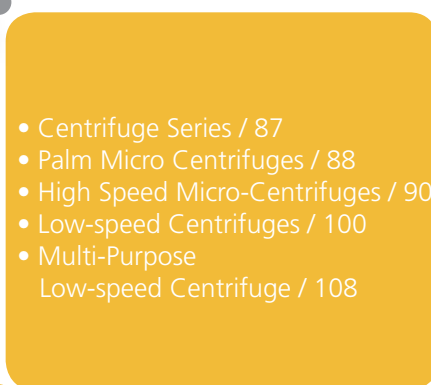

- Centrifuge Series / 87
- Palm Micro Centrifuges / 88
- High Speed Micro-Centrifuges / 90
- Low-speed Centrifuges / 100
- Multi-Purpose Low-speed Centrifuge / 108



Miscellaneous

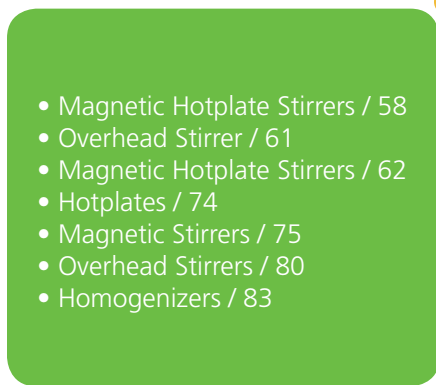

- Magnetic Hotplate Stirrers / 58
- Overhead Stirrer / 61
- Magnetic Hotplate Stirrers / 62
- Hotplates / 74
- Magnetic Stirrers / 75
- Overhead Stirrers / 80
- Homogenizers / 83



Centrifuges

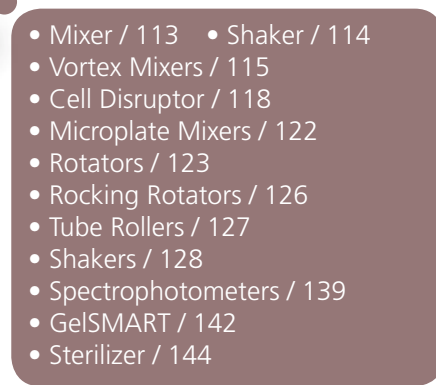

- Mixer / 113
- Shaker / 114
- Vortex Mixers / 115
- Cell Disruptor / 118
- Microplate Mixers / 122
- Rotators / 123
- Rocking Rotators / 126
- Tube Rollers / 127
- Shakers / 128
- Spectrophotometers / 139
- GelSMART / 142
- Sterilizer / 144

DLAB products are manufactured in accordance with ISO9001 and ISO13485. All products comply with EU and North America standards, CE, cTUVus, FCC marked and subjected to the strict QC control.

DLAB instruments are tested and conform to the following safety and EMC standards:

EN 61010-1 UL 3101-1 CAN/CSA C22.2(1010-1)

EN 61010-2-10 EN 61326-1 EMC-guidelines: 89/336/EWG Instrument guidelines: 73/023/EWG

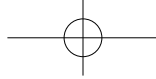

Liquid Handling

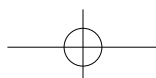

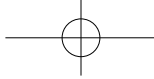

DLAB liquid handling range includes micropipettes(electronic pipettes & mechanical pipettes), pipette filler, pipette controller and stepper.

List of DLAB models:

Series	Image	Model	Application	Operation Method	Volume Range	Channel Option	Autoclavable	Page
Electronic Pipette		dPette+	Aqueous solution	Electronic	0.5-1000 μ L	Single Channel Adj.	YES (lower part)	P.05
					0.5-300 μ L	8 Channel Adj.		
		dPette	Aqueous solution	Electronic	0.5-1000 μ L	Single Channel Adj.	YES (lower part)	P.07
Mechanical Pipette		Hipette	Aqueous solution	Manual	0.1 μ L-10ml	Single channel	YES	P.09
		MicroPette	Aqueous solution	Manual	0.1 μ L-10ml	Single Channel Adj. & Fixed; 8 Channel Adj.; 12 Channel Adj.;	YES (lower part)	P.11
		MicroPette Plus	Aqueous solution	Manual	0.1 μ L-5000 μ L	Single Channel Adj. & Fixed; 8 Channel Adj.; 12 Channel Adj.;	YES	P.13
		MiniPette	Aqueous solution	Manual	25-200 μ L	Single Channel Fixed	NO	P.15
Pipette Filler		Levo Plus	Aqueous solution	Electronic	0.1-100ml	Single channel	YES (silicon adapter&nozzle)	P.17
		Levo Me	Aqueous solution	Electronic	0.1-100ml	Single channel	YES (silicon adapter&nozzle)	P.18
Pipette Controller		Levo	Aqueous solution	Manual	0.1-100ml	Single channel	YES (silicon adapter&nozzle)	P.19
Pipette Pump		Levo E	Aqueous solution	Manual	2-25ml	Single channel	NO	P.19
Stepper		StepMate	Aqueous solution, high viscosity or volatile solution	Manual	0.5-50ml	Single channel	NO	P.20

In addition to pipettes, liquid handling series products also include various dispensers, electronic titrator and vacuum aspiration system, which are used for the pipetting, dispensing, and collection of reagents with a wider range.

List of DLAB models:



Product Name	Bottle-Top Dispenser	New Bottle-Top Dispenser	Electronic Bottle-Top Dispenser	Electronic Titrator	Vacuum Aspiration System	Economical Vacuum Aspirator
Model	DispensMate	DispensMate-Pro/S	dFlow	dTrite	SAFEVAC	EcoVAC
Application	Reagent pipetting and liquid dispensing			Used in titration operations in chemical analysis, food industry, environmental analysis	Liquid collection and storage treatment, including cell culture medium, suspension, supernatant.	
Operation	Manual	Manual	Electronic	Electronic	Electronic	Electronic
Volume Range	0.5-5ml 1.0-10ml 2.5-25ml 5.0-50ml	0.5-5ml 1.0-10ml 2.5-25ml 5.0-50ml 10-100ml	0.1ml-99.9ml	0.01ml-99.99ml	Vacuum range: 0-600mbar Bottle volume:4L	Vacuum range: 0-500mbar Bottle volume:2L
Reagent Recovery Function	No	Yes	Yes	Yes	No	No
Features		-S Enhanced seal -Pro Glass piston	-	-	Sensitive level sensor,Self-closing connector	1L bottle optional, Switch manual and continuous aspiration
Fully autoclavable	The part where the liquid flows	Whole	-	-	The part where the liquid flows	The part where the liquid flows
Accessories	Screw adapter	Screw adapter	Spiral dispensing pipe	Spiral dispensing pipe	Handle adapter	Handle adapter
Page	P.21	P.20	P.19	P.18	P.22	P.24

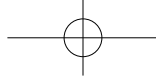

dPette+

Multi-functional 8-channel Electronic Pipette

DLAB multi-functional high performance 8-channel electronic pipette offers productive pipetting with its easy to understand operations. Its uniquely lightweight streamlined design ensures an effortless transfer of multiple samples with an increased throughput and data reproducibility.



Function Wheel

Switch different functions pipetting, dispensing and mixing.

Parameter Knob

Set and confirm all parameters.

Motor Driven Digital Control

360° Rotation

Rotatable for convenient handling

Ingenious Curved Ejector

The tips fit optimally without any extra force



• Easy Operations

Intuitive interface for setting functions and parameters.

• Ergonomic Design

Low operation forces for complete work, which is exceptionally fatigue-free.

• Convenient and Versatile

360° pipetting. Double knobs for simple and versatile control. Easy loading tip cones offers smooth and leak free operation.

• Dual charging mode

Use of USB charger or the charging stand to ensure uninterrupted use.

Electronic Pipette

Three easy steps to operate dPette+



Long press the Parameter Knob for 2 seconds to Start



Quickly turn the Function Wheel to Activate, Rotate to Switch Pipetting, Continuous Dispensing, and other Function Settings

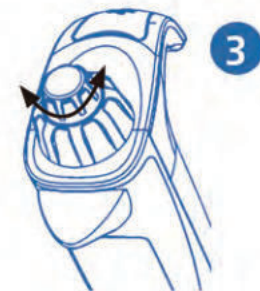

After quickly turning the Parameter Knob to Unlock, Turn to Adjust the Volume, Press to Pipette, Long press to Mix

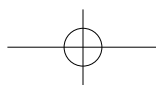

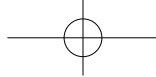

Pipetting function

Parameter Knob press → Pipetting,
Long press → Mixing

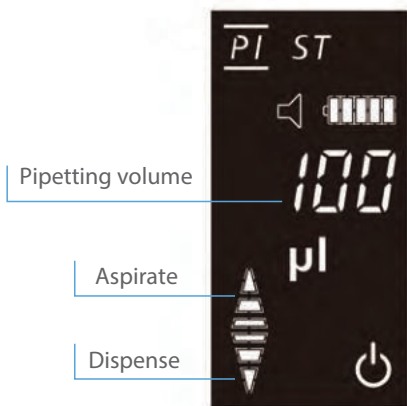

Dispensing function

Dispensing times = Pipette max volume /
Single sample volume



One-time dispensing volume

Sample numbers



100µl×3

Other function

Pipetting speed adjustment
Key tone adjustment



Three speed adjustable

Complimentary Pipette Holder

Supports dual charging mode



USB Charging



Contact Charging

Automatic Calibration Support

Connect it to the computer,
with the free software
provided for calibration

Specifications

Volume Range	Increment	Test Volume	Accuracy error		Precision error	
			µL	%	SD* µL	CV* %
0.5-10µL	0.01	10	±0.20	±2.00	0.1	1.0
		1	±0.08	±8.0	0.05	5.00
10-100µL	0.1	100	±0.80	±0.80	0.3	0.30
		10	±0.3	±3.00	0.2	2.00
30-300µL	1	300	±1.80	±0.60	0.9	0.3
		30	±0.90	±3.00	0.3	1.0

* SD=Standard Deviation * CV=Coefficient of Variation

* DLAB specifications are used as guidelines and the user calibration should refer to the industrial standard ISO 8655.

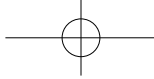

dPette+

Multifunction Electronic Pipette

dPette

Simple Electric Pipette

Features

- High accuracy, high performance stepper motor ensures accuracy and repeatability, eliminating manual pipetting errors
- A motor driven digital control pipette with multifunction
- 2 buttons handle all operational settings
- Light weight, ergonomic design, small body dimension for easy handling that guarantees fatigue free pipetting
- Pipetting, Mixing, Stepper and Dilution(Only dPette+)
- Pipetting, Mixing(dPette)
- Adjustable speeds for aspiration and dispensing
- Li-ion battery and dual charging modes enable longer operation time
- Self calibration



dPette+

dPette

Electronic Pipette

Specifications

Channels	Volume Range	Increment	Test Volume	Error limits in accordance to ISO8655-2			
				accuracy error		precision error	
				μL	%	s.d.* μL	CV%*
1	0.5-10	0.01	10	± 0.10	± 1.00	0.05	0.50
			1	± 0.035	± 3.50	0.03	3.00
1	5-50	0.1	50	± 0.40	± 0.80	0.15	0.30
			5	± 0.15	± 3.00	0.125	2.50
1	30-300	1	300	± 1.80	± 0.60	0.60	0.20
			30	± 0.90	± 3.00	0.21	0.70
1	100-1000	5	1000	± 6.00	± 0.60	2.00	0.20
			100	± 3.00	± 3.00	0.60	0.60

* s.d. = Standard Deviation
*CV = Coefficient of Variation

DLAB specifications are used as guidelines and the user calibration should refer to the industrial standard ISO 8655

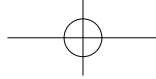

Electronic Pipette



dPette is an innovative electronic pipette developed by DLAB. It combines the feature of manual pipette as ergonomic and light weight with the feature of electronic pipette as labor-saving and high performance, it offers new pipetting experience to the users.

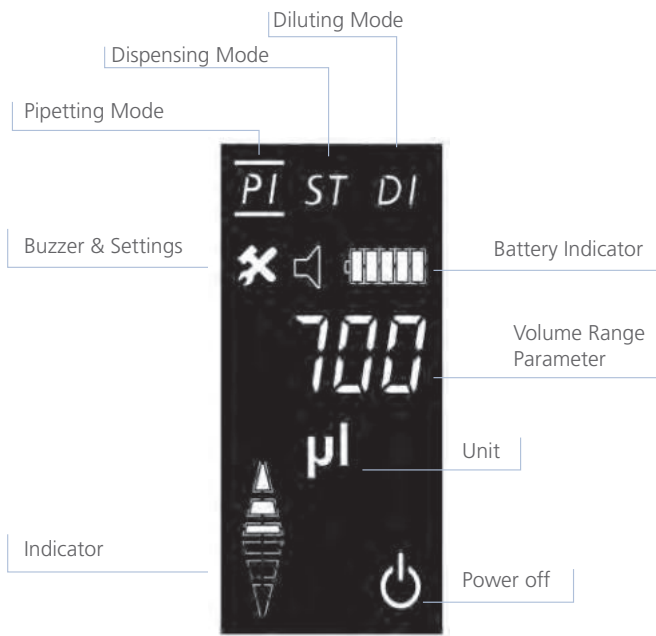

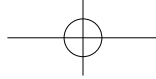

HiPette

Fully Autoclavable Mechanical Pipette

The DLAB new generation fully autoclavable manual pipette has the best ergonomic design and is ultralight weight. It has been designed keeping in mind the human form and human factors to offer smooth and effortless ergonomic pipetting experience. It is UV sterilisable and resistant to strong chemical corrosion. In addition, the volume lock helps protect from volume changing accidentally, and achieve reliable pipetting of smallest volume of liquids.

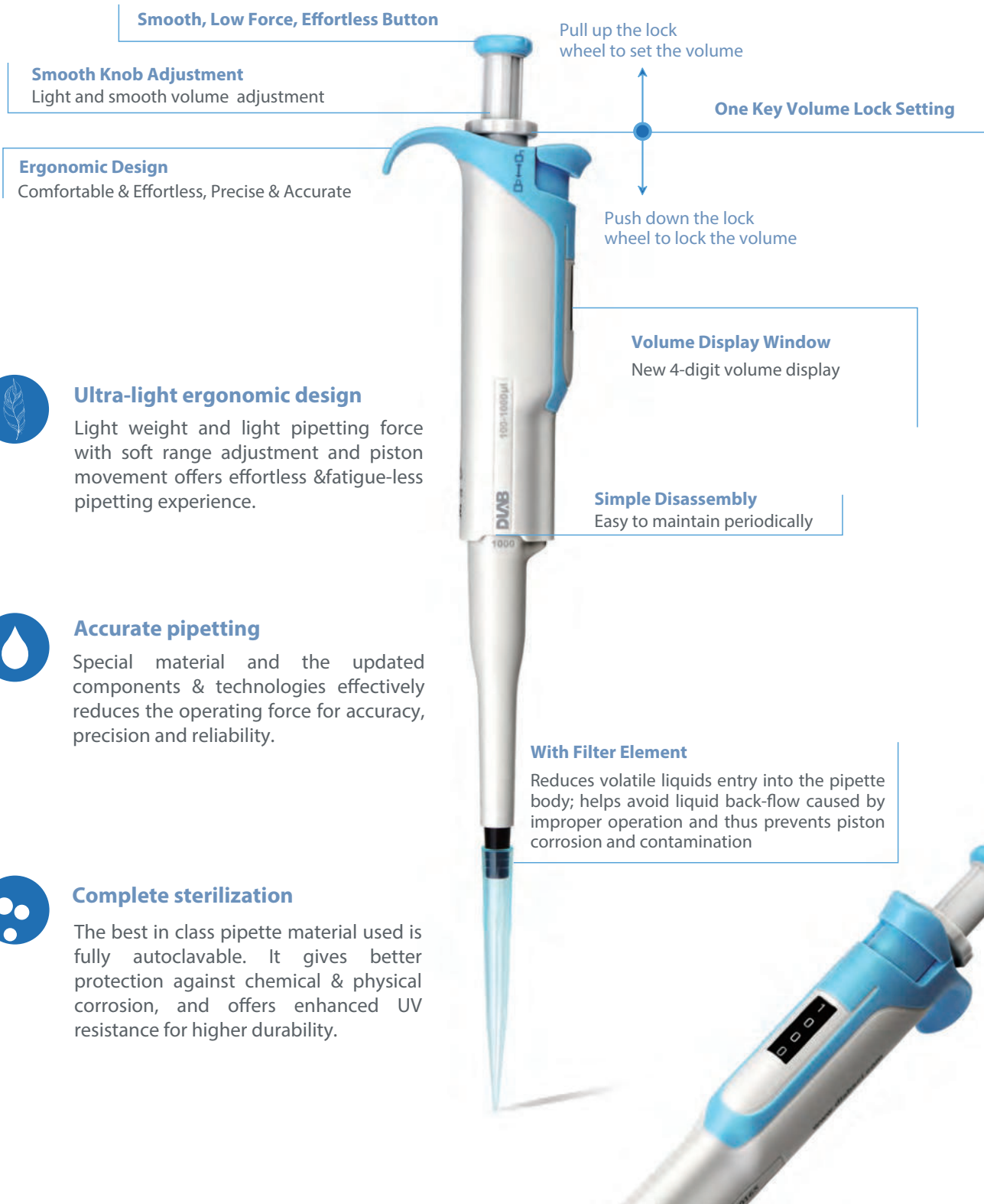

Mechanical Pipettes

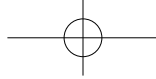

Mechanical Pipettes



Specifications

Single-channel Adjustable Volume Pipettes (9 volume ranges, covering 0.1µl~10ml)

Volume Range	Increment	Test Volume	Accuracy error		Precision error	
			%	µl	µl	µl
0.1-2.5µl	0.002µl	2.5µl	1.4%	0.04	0.7%	0.02
		1.25µl	2.5%	0.03	1.5%	0.02
		0.25µl	12.0%	0.03	6.0%	0.02
0.5-10µl	0.01µl	10µl	1.0%	0.10	0.4%	0.04
		5µl	1.5%	0.08	0.8%	0.04
		1µl	2.5%	0.03	1.8%	0.02
2-20µl	0.02µl	20µl	1.0%	0.20	0.3%	0.06
		10µl	1.2%	0.12	0.6%	0.06
		2µl	5.0%	0.10	1.5%	0.03
10-100µl	0.1µl	100µl	0.8%	0.80	0.2%	0.20
		50µl	1.0%	0.50	0.3%	0.15
		10µl	3.0%	0.30	1.0%	0.10
20-200µl	0.2µl	200µl	0.6%	1.20	0.2%	0.40
		100µl	1.0%	1.00	0.3%	0.30
		20µl	2.5%	0.50	0.7%	0.14
30-300µl	0.2µl	300µl	0.6%	1.80	0.2%	0.60
		150µl	1.0%	1.50	0.3%	0.45
		30µl	2.5%	0.75	0.7%	0.21
100-1000µl	1µl	1000µl	0.6%	6.00	0.2%	2.00
		500µl	1%	5.00	0.2%	1.00
		100µl	3%	3.00	0.6%	0.60
500-5000µl**	5µl	5000µl	0.6%	30.00	0.2%	10.00
		2500µl	0.6%	15.00	0.3%	7.50
		500µl	1.2%	12.00	0.3%	3.00
1000-10000µl**	10µl	10000µl	0.6%	60.00	0.2%	20.00
		5000µl	0.8%	40.00	0.2%	10.00
		1000µl	1.5%	30.00	0.3%	6.00

**** Coming soon**

User calibration should refer to the industrial standard ISO8655-2.

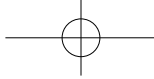

MicroPette plus

121°C
FULLY
Autoclavable

Features

- Fully autoclavable
- Ergonomic design provides excellent operating experience
- Easy-to-read volume display
- The pipettes cover the volume range from 0.1µL to 5mL
- Easy calibration and maintenance
- Manufactured from innovative materials
- Each MicroPette Plus supplied with an Individual calibration certificate according to ISO8655
- Online calibration is available



MicroPette plus multi-channel

121°C
FULLY
Autoclavable

Features

- Dispensing head rotates for effortless pipetting convenience
- Individual piston and tip cone assembly allow for easy repair and maintenance
- Compound material-made tip cone secures high sealing performance
- Compatible with most universal tip brands
- Online calibration is available



Mechanical Pipettes

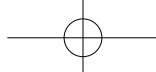

Fully autoclavable

The MicroPette Plus pipettes are fully autoclavable, enable easy cleaning and reduce the risk of contamination. Steam autoclaving can be performed at 121°C, 1 bar for 20 minutes. After autoclaving, the pipette must be cooled down and left to dry for 12 hours before use.

It is recommended to check the performance of the pipette after each autoclaving. Greasing and sealing of the pipette piston after every 10th autoclaving will secure an enhanced function.

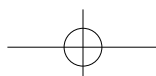

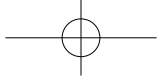

MicroPette

Features

- Pipettes cover a volume range from 0.1µL to 10mL
- Ergonomic design provides excellent operating experience
- Large display window allows for easy volume identification
- Easy calibration and maintenance
- Each MicroPette supplied with an individual calibration certificate according to ISO8655
- Online calibration is available

121°C
HALF
 Autoclavable



MicroPette multi-channel

Features

- 8 and 12 channel pipettes are appropriate for 96 well plates
- Dispensing head rotates for effortless pipetting convenience
- Individual piston and tip cone assemblies allowing easy repair and maintenance
- Compound material-made tip cone secures high sealing performance
- Compatible with most universal tip brands
- Online calibration is available

121°C
HALF
 Autoclavable



Mechanical Pipettes

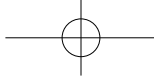

Mechanical Pipettes



Push button for volume adjustment

Comfortable Finger support

Low force tip ejector for easy operation

Spring loaded tip cones for easy cleaning and maintenance

High chemical-resistance materials to secure long lifetime

8 channels

Calibration

All DLAB pipettes have been quality tested according to ISO8655-2:2002 and are supplied with individual calibration certificates. The quality control includes gravimetric testing of each pipette with distilled water at 22°C. Our website www.dlabsci.com allows users to access DLAB online calibration software and achieve accurate and timely calibration.

Online calibration software is FREE to DLAB pipette users

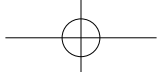

Specifications

This list is appropriate for MicroPette and MicroPette plus (Adjustable and Fixed volume)

Single-channel Adjustable Volume Pipettes

Volume Range	Increment	Test Volume	Error limits in accordance with ISO8655-2			
			(Accuracy error)		(Precision error)	
			%	μL	%	μL
0.1-2.5 μL	0.05 μL	2.5 μL	2.50%	0.0625	2.00%	0.05
		1.25 μL	3.00%	0.0375	3.00%	0.0375
		0.25 μL	12.00%	0.03	6.00%	0.015
0.5-10 μL	0.1 μL	10 μL	1.00%	0.1	0.80%	0.08
		5 μL	1.50%	0.075	1.50%	0.075
		1 μL	2.50%	0.025	1.50%	0.015
2-20 μL	0.5 μL	20 μL	0.90%	0.18	0.40%	0.08
		10 μL	1.20%	0.12	1.00%	0.1
		2 μL	3.00%	0.06	2.00%	0.04
5-50 μL	0.5 μL	50 μL	0.60%	0.3	0.30%	0.15
		25 μL	0.90%	0.225	0.60%	0.15
		5 μL	2.00%	0.1	2.00%	0.1
10-100 μL	1 μL	100 μL	0.80%	0.8	0.15%	0.15
		50 μL	1.00%	0.5	0.40%	0.2
		10 μL	3.00%	0.3	1.50%	0.15
20-200 μL	1 μL	200 μL	0.60%	1.2	0.15%	0.3
		100 μL	0.80%	0.8	0.30%	0.3
		20 μL	3.00%	0.6	1.00%	0.2
50-200 μL	1 μL	200 μL	0.60%	1.2	0.15%	0.3
		100 μL	0.80%	0.8	0.30%	0.3
		50 μL	1.00%	0.5	0.40%	0.2
100-1000 μL	5 μL	1000 μL	0.60%	6	0.20%	2
		500 μL	0.70%	3.5	0.25%	1.25
		100 μL	2.00%	2	0.70%	0.7
200-1000 μL	5 μL	1000 μL	0.60%	6	0.20%	2
		500 μL	0.70%	3.5	0.25%	1.25
		200 μL	0.90%	1.8	0.30%	0.6
1000-5000 μL	50 μL	5000 μL	0.50%	25	0.15%	7.5
		2500 μL	0.60%	15	0.30%	7.5
		1000 μL	0.70%	7	0.30%	3
2-10mL	0.1mL	10mL	0.60%	60	0.20%	20
		5mL	1.20%	60	0.30%	15
		2mL	3.00%	60	0.60%	12

DLAB specifications are used as guidelines and the user calibration should refer to the industrial standard ISO 8655

8-channel Adjustable Volume Pipettes

Volume Range	Increment	Test Volume	Error limits in accordance with ISO8655-2			
			(Accuracy error)		(Precision error)	
			%	μL	%	μL
0.5-10μL	0.1μL	10μL	1.50%	0.15	1.50%	0.15
		5μL	2.50%	0.125	2.50%	0.125
		1μL	4.00%	0.04	4.00%	0.04
5-50μL	0.5μL	50μL	1.00%	0.5	0.50%	0.25
		25μL	1.50%	0.375	1.00%	0.25
		5μL	3.00%	0.15	2.00%	0.1
50-300μL	5μL	300μL	0.70%	2.1	0.25%	0.75
		150μL	1.00%	1.5	0.50%	0.75
		50μL	1.50%	0.75	0.80%	0.4

12-channel Adjustable Volume Pipettes

Volume Range	Increment	Test Volume	Error limits in accordance with ISO8655-2			
			(Accuracy error)		(Precision error)	
			%	μL	%	μL
0.5-10μL	0.1μL	10μL	1.50%	0.15	1.50%	0.15
		5μL	2.50%	0.125	2.50%	0.125
		1μL	4.00%	0.04	4.00%	0.04
5-50μL	0.5μL	50μL	1.00%	0.5	0.50%	0.25
		25μL	1.50%	0.375	1.00%	0.25
		5μL	3.00%	0.15	2.00%	0.1
50-300μL	5μL	300μL	0.70%	2.1	0.25%	0.75
		150μL	1.00%	1.5	0.50%	0.75
		50μL	1.50%	0.75	0.80%	0.4

Fixed Volume Pipettes

Volume Range	Increment	Test Volume	Error limits in accordance with ISO8655-2			
			(Accuracy error)		(Precision error)	
			%	μL	%	μL
5μL	-	5μL	1.3%	0.065	1.2%	0.06
10μL	-	10μL	0.8%	0.08	0.8%	0.08
20μL	-	20μL	0.6%	0.12	0.5%	0.1
25μL	-	25μL	0.5%	0.125	0.3%	0.075
50μL	-	50μL	0.5%	0.25	0.3%	0.15
100μL	-	100μL	0.5%	0.5	0.3%	0.3
200μL	-	200μL	0.4%	0.8	0.2%	0.4
250μL	-	250μL	0.4%	1.0	0.2%	0.5
500μL	-	500μL	0.3%	1.5	0.2%	1.0
1000μL	-	1000μL	0.3%	3.0	0.2%	2.0
2000μL	-	2000μL	0.3%	6.0	0.15%	3.0
5000μL	-	5000μL	0.3%	15	0.15%	7.5

DLAB specifications are used as guidelines and the user calibration should refer to the industrial standard ISO 8655

Levo Plus Pipette Filler

Features

- Compatible with most of the plastic and glass pipettes from 0.1 -100mL
- Six different speed modes for aspiration and dispensing different liquids
- Large LCD display showing low battery warning and speed settings
- Enables single-handed operation with minimum effort
- Light and ergonomic design providing easy usability
- High capacity Li-ion battery enable long runtime of operation
- Powerful pump fills a 25mL pipette in <5 seconds
- 0.45µm replaceable hydrophobic filter
- Rechargeable during use

Large LCD display showing low battery warning and speed settings



Select the desired coarse speed by pressing the button +/-

Aspiration operation buttons

Operating button for motor and gravity dispensing

Hydrophobic filter 0.45µm

Silicone adapter for 0.1-100mL pipette tip, fully autoclavable

Specifications

Aspiration Speed	25mL<5s (6 shift)
Dispensing Speed	Motor (6 shift)/Gravity
Battery	Lithium-ion
Battery Service Life	More than 8 Hours of Intermittence Use
Charging Time	2-3 Hours
Pipette Types	Glass or Plastic Pipette (0.1-100mL), Pasteur Pipettes
Filter	0.45µm Hydrophobic
Weight	200g

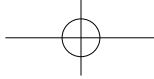

Levo ME Pipette Filler

Levo ME pipette filler has an excellent feature and ergonomic design, suitable for almost all commonly used glass or plastic pipettes.

Features

- Enables single-handed operation with minimum effort
- Compatible with most of the plastic and glass pipettes from 0.1-100mL
- Easily adjustable speed control
- 0.45µm replaceable hydrophobic filter
- Stable and reliable performance, elegant appearance
- High capacity Li-ion battery enable long operation time.



Specifications

Aspiration Speed	25ml<7s
Dispensing Speed	Motor/Gravity
Battery	Lithium-ion
Battery Service Life	More than 8 Hours of Intermittence Use
Charging Time	2-3 Hours
Pipette Types	Glass or Plastic Pipette (0.1-100mL), Pasteur Pipettes
Filter	0.45µm Hydrophobic
Weight	200g

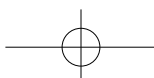

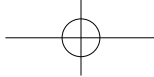

Levo Pipette Controller

Features

- Ease of use
- Precise pipetting control
- Robust and light weight
- Compatible with most of the plastic and glass pipettes from 0.1 -100mL
- 3µm replaceable hydrophobic filter
- Easy for cleaning and maintenance



Compress the suction bellows before attaching the pipette

Button to expel residual liquid when using blow-out pipette

Aspiration and dispensing comfortably achieved with a sensitive lever

Levo E Pipette Pump

Features

- Volume capacity 2mL, 10mL and 25mL
- Colour-coded by volume with green, blue and red
- Thumb wheel guarantees precise operation
- Resistant to acids and alkalis
- Easy for cleaning and maintenance



3µm replaceable Hydrophobic filter

Silicone adapter for 0.1-100mL pipette tip, fully autoclavable



Designed for single-handed operation, Pipette Pump identifies itself with a thumbwheel, allowing precise aspiration or dispensing. The feature of side lever enables complete liquid dispensing, without a droplet remaining.

Mini Pipette

Features

- Ergonomic design provides excellent operation experience;
- Smart body, ideal to combine with IVD reagents;
- Compatible with universal 200µl tips;
- Various volumes from 25ul to 200ul, different color for different volumes, easy to choose;
- Entire body by one-time molding, robust to use.



Volumes	Color
200ul	Gray
100ul	Blue
75ul	Red
50ul	Orange
30ul	Yellow
25ul	Dark Green
OEM	Optional

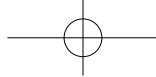

Based on the principle of positive displacement, StepMate Stepper is designed for trouble-free and reliable dispensing of liquids, especially for high viscosity, high density and high vapor pressure. The 48-step dispensing allows for enhanced accuracy and usability.

StepMate Stepper

Features

- Light and ergonomic solution provides easy usability
- Single-handed operation
- Volume range from 10µL to 5mL
- Up to 48 dispensing steps
- Maintenance free
- Equipped with durable tip insertion lever
- Fits seven sizes of disposable polypropylene syringes from 0.5mL to 50mL

Optimized for smooth dispensing of even the smallest volumes

Five easy-to-select settings control dispensing volume

By pushing the slide upwards, the syringe is filled up



The stop lever secures the syringe

How to select dispensing volume

Find the required dispensing volume in the table
Use the adjusting wheel to set the required volume
Select and insert a suitable tip
Follow the maximum dispensing steps

Tip volume

Dispensing Volume

Tips \ Sel.	1	2	3	4	5
0.50ml	10µl	20µl	30µl	40µl	50µl
1.25ml	25µl	50µl	75µl	100µl	125µl
2.50ml	50µl	100µl	150µl	200µl	250µl
5.00ml	100µl	200µl	300µl	400µl	500µl
12.50ml	250µl	500µl	750µl	1000µl	1250µl
25.00ml	500µl	1000µl	1500µl	2000µl	2500µl
50.00ml	1000µl	2000µl	3000µl	4000µl	5000µl
Steps	48	23	15	11	8

Steps



Stepper

DLAB
StepMate

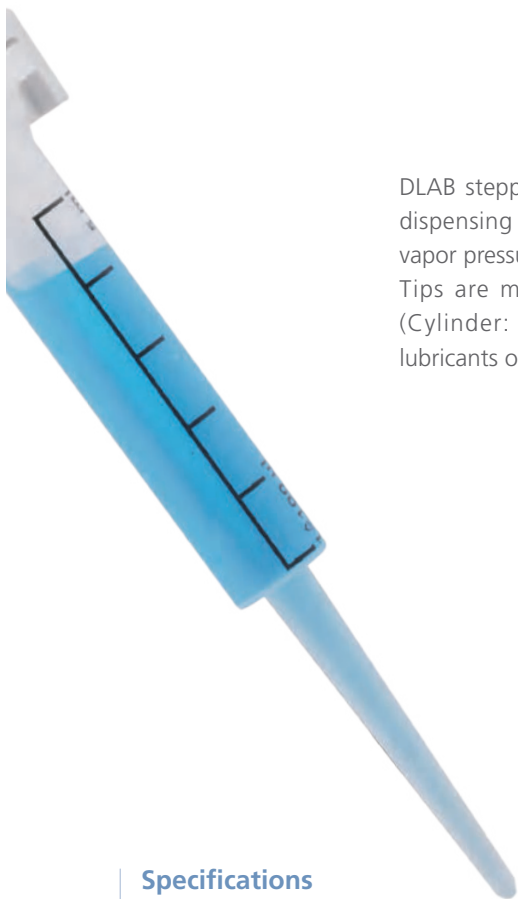

DLAB stepper tips are particularly suitable for dispensing of fluids with high viscosity, high vapor pressure etc.

Tips are made from high-quality materials (Cylinder: PP, Piston: PE-HD) without soft lubricants or other additives.



Specifications

Note: The first and last dispensing liquid should be discarded for precision.

Dial setting		1	2	3	4	5			
Number of steps		48	23	15	11	8			
Cat. No.	Syringe volume (mL)	Sample volume (μL)					A %	P %	Description
17900032	0.50	10	20	30	40	50	± 0.8	≤ 0.7	0.5mL, piston PE-HD, cylinder PP, 1 packing, 5 pcs/packing
17900033	1.25	25	50	75	100	125	± 0.8	≤ 0.5	1.25mL, piston PE-HD, cylinder PP, 1 packing, 5 pcs/packing
17900034	2.50	50	100	150	200	250	± 0.8	≤ 0.4	2.5mL, piston PE-HD, cylinder PP, 1 packing, 5 pcs/packing
17900035	5.00	100	200	300	400	500	± 0.4	≤ 0.3	5mL, piston PE-HD, cylinder PP, 1 packing, 5 pcs/packing
17900036	12.50	250	500	750	1000	1250	± 0.3	≤ 0.3	12.5ml, piston PE-HD, cylinder PP, 1 packing, 5 pcs/packing
17900037	25.00	500	1000	1500	2000	2500	± 0.2	≤ 0.3	25mL, piston PE-HD, cylinder PP, 1 packing, 2pcs/packing with 1 pc adapter
17900038	50.00	1000	2000	3000	4000	5000	± 0.2	≤ 0.2	50mL, piston PE-HD, cylinder PP, 1 packing, 2pcs/packing with 1 pc adapter

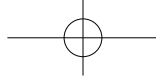

dTrite Electronic Titrator

The dTrite Digital Burette provides accurate, precise and convenient bottle-top titration, as well as optimum operator safety.

It combines both magnetic stirrer and titrator functions, making it easier for the operator to achieve satisfactory results in the field of analytical chemistry, food industry, water analysis etc.

Features

- High quality motor with excellent precision and accuracy
- Electronic control provides a fatigue-free operation
- Remote control panel prevents manual disturbance during operation
- Built-in magnetic stirrer for a complete and easy operation

Specifications

Volume Range	0.01mL-99.99mL, Max piston lift is 10mL, resolution is 10µL
Volume Accuracy	R=0.2% CV=0.07%
Velocity	16 stages
Operating Temperature Range	10°C-30°C
Quality Control	DIN EN ISO 8655
Control Type	External control, including the stirrer and the burette program

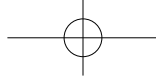

dFlow

Electronic Bottle-Top Dispenser

Features

- Digital operation
- Electronic control provides a fatigue-free operation
- Remote control panel prevents manual disturbance during operation
- Two operation modes:
 - Traditional Dispensing, the liquid is continuously dispensed
 - Stepper Function, for dispensing series



Electronic Bottle-Top Dispenser

Specifications

Volume Range	0.1-99.9mL, Max piston lift is 10mL, resolution is 100μL
Volume Accuracy	Dispenser: R = 10mL ±30μL; CV = 10ml ±10μL Stepper: R = 1mL ±6μL; CV = 1ML ±9μL
Operating Temperature Range	10°C-30°C
Quality Control	DIN EN ISO 8655
Contro Type	External control

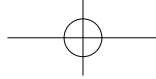

DispensMate-Pro DispensMate-S

New Premium Bottle-Top Dispenser

2 optional schemes offer high chemical resistance and robustness in the range of volumes up to 100 ml

DispensMate-Pro:

- Seamless glass piston and socket design, with strong chemical resistance, smooth and low resistance operation.

DispensMate-S:

- Anti-corrosion sealing ring with strong chemical resistance.



Reagent recovery function reduces reagent waste and prevents dripping when not in operation



Closure Cap Screw design easy to open/close and free of contact with reagents

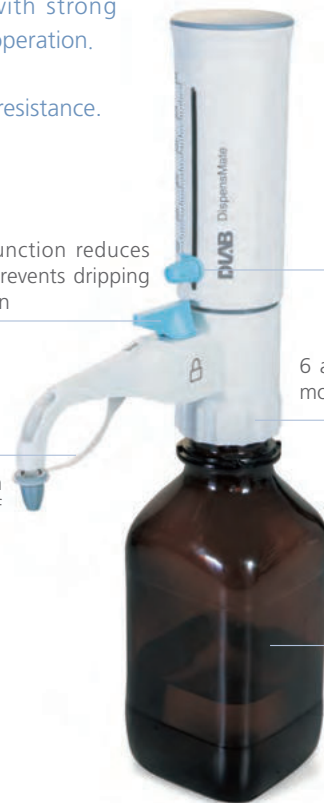

Fast, reliable and reproducible volume locking mechanism

6 adapters allow fitting to most common bottles

Adjustable aspirating tube for different height bottles



Features

- High chemical resistance of all dispensing components
- Fully autoclavable at 121°C
- Available in 5 sizes for dispensing volumes from 0.5mL to 100mL
- Reagent recovery function reduces waste and prevents dripping when not in operation
- Fast and reliable volume locking mechanism
- Easy to disassemble and clean, minimum maintenance
- For liquid with vapor pressure up to 500 mbar; viscosity up to 500 mm²/s; temperature up to 40°C; density up to 2.2 g/cm
- Adjustable aspirating tube for different height bottles
- Supplied with most common adapters (S40, GL32, GL38, GL25, GL28)

Specifications

Volume Range mL	Graduation mL	A \leq ±		CV \leq	
		%	μ L	%	μ L
0.5-5	0.1	0.5	25	0.2	10
1.0-10	0.2	0.5	50	0.2	20
2.5-25	0.5	0.5	125	0.2	50
5.0-50	1.0	0.5	250	0.2	100
10~100	2.0	0.5	500	0.2	200

Accessories

Cat. No.	Description
17400135	S40, Adapter, 45/40mm
17400131	GL32, Adapter, 45/32mm
17400132	GL38, Adapter, 45/38mm
17400133	GL25, Adapter, 32/25mm
17400134	GL28, Adapter, 32/28mm
17400037	Reagent Bottle (Brown, 1L ,Optional)
17900158	Filling tube
17000802	Discharge tube

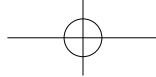

DispensMate Bottle-Top Dispenser

Easy-to-use volume adjustment

Smooth piston design provides effortless dispensing

Adapters allow fitting to most common bottles

closure cap protects against reagent contact, easy to open/close without taking gloves off.

Filling tube adjusts easily for different size bottles



Bottle-Top Dispensers

Features

- Excellent chemical resistance, high strength components made of PTFE, FEP, BSG, PP
- Fully autoclavable at 121°C (Liquid accessible parts)
- Available in 4 sizes for dispensing volumes from 0.5mL to 50mL
- Easy for cleaning and maintenance
- The optional variable discharge tube with safety handle allows a fast and precise dispensing
- Vapor pressure max: 500mbar; viscosity max; 500mm²/s; temperature max: 40°C; density max: 2.2g/cm³
- Supplied with most common adapters (S40, GL32, GL38, GL25, GL28)

Specifications

Cat. No.	Volume Range mL	Graduation mL	A _±		CV _≤	
			%	μL	%	μL
7032100001	0.5-5	0.1	0.5	25	0.2	10
7032100002	1.0-10	0.2	0.5	50	0.2	20
7032100003	2.5-25	0.5	0.5	125	0.2	50
7032100004	5.0-50	1.0	0.5	250	0.2	100

Accessories

Cat. No.	Description
17100553	GL45, Adapter, 45mm
17000069	S40, Adapter, 45/40mm
17400131	GL32, Adapter, 45/32mm
17400132	GL38, Adapter, 45/38mm
17400133	GL25, Adapter, 32/25mm
17400134	GL28, Adapter, 32/28mm
17400037	Reagent Bottle (Brown, 1L ,Optional)
17400021	Filling tube(m)
17100073	Discharge tube(m)

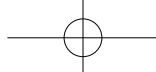

SafeVac is designed for laboratory waste recovery and separation of liquid and solid. It can be widely used in cell culture, DNA extraction, microplate waste removal, and any other liquid separation or recovery.

SAFEVAC Vacuum Aspiration Systems

Features

- Vacuum power with adjustable aspiration rate to achieve up to 15mL/S
- Sensitive level sensor to detect when the bottle is full preventing liquid overflow
- Fully autoclavable all system components that contact liquid
- Easy to disassemble and clean
- Wide range of adapters fit on the hand-operator for aspirating liquids from tubes, dishes, microplates, bottles, from single channel to 8-channel tip
- Hydrophobic filter for avoiding air contamination or liquid overflow (this feature is in the catalogue but it is not on website)

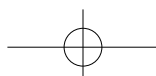

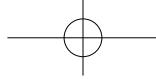

Specifications

Vacuum range	0-600mbar
Dimension[WxDxH]	180x240x450mm
Aspirating speed	1-15mL/S
Autoclave component	tube; waste bottle; operation handle;
Noise Level	≤55dB
Weight	3kg
Input voltage	100-240VAC, 50/60 Hz
Bottle Volume	4L



Sensitive level sensor to prevent liquid overflow

Wide range of adapters fit well with tube, microplate and disk plate for various of tasks, all of which can be fully autoclaved (At 121°C 1 bar for 20 minutes. After autoclaving the equipment must be cooled down before use).

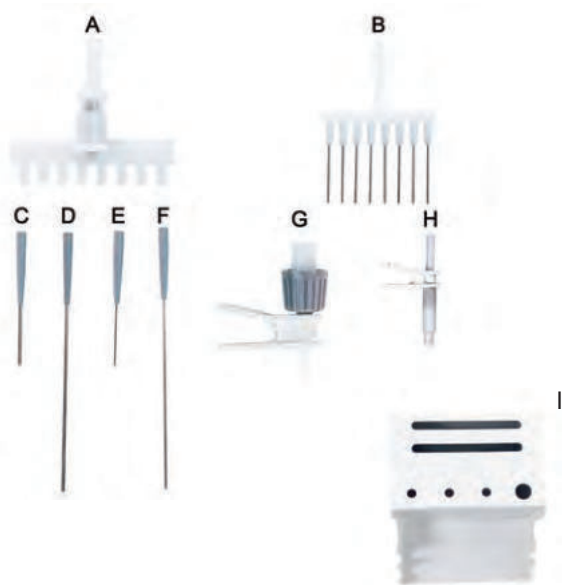

A	8-channel tip detrusion adapter 200ul tip
B	8 channel needle φ1.5mm
C	Single needle φ2.5mm, 40mm
D	Single needle φ2.5mm, 120mm
E	Single needle φ1.5mm, 40mm
F	Single needle φ1.5mm, 120mm
G	tip tip detrusion adapter 200ul tip
H	tip detrusion adapter 1ml tip
I	SAFEVAC Handle bracket



Self-closing connectors to avoid escape of drops or aerosols from disconnected bottle



Stand for transferring the bottle securely and holding the hand operator

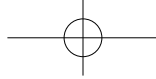

EcoVAC Economical Vacuum Aspirator

EcoVAC offers a compact & quiet, safe & efficient, and an affordable solution for the aspiration, collection and subsequent disposal of biological liquid waste, suitable for various applications. It is equipped with a 2L liquid bottle as standard, and an optional 1L liquid bottle.



Features

- Small and compact, it fits on cabinet, bench and ground.
- The handle operation is simple and flexible. It is easy to switch between manual aspiration and continuous aspiration mode, reducing hand fatigue and improving efficiency.
- The hydrophobic filter prevents aerosol and liquid contamination.
- Brushless motor offers low noise and long life.
- Different adapters are available to match a multitude of laboratory supplies.
- All parts that liquid flow can be autoclaved.
- Provides safe and efficient way to collect and contain biological liquid waste.



Level 1



Level 2

Easy to switch between manual aspiration and continuous aspiration: two levels adjustable.
 Level 1: Continuous aspiration mode.
 Level 2: Continuous liquid aspiration rate increased by 30%.



Hanging handles on both sides



1L bottle adaptor optional



Specifications

Vacuum range	0-500mbar
Aspirating speed	15L/min(air)
Flow rate [liquid]	17mL/s
Bottle	2L Standard, 1L Optional
Motor type	Brushless Motor
Input voltage	100-220VAC, 50/60Hz
Dimension [W×D×H]	180×240×340 mm
Weight	2.8kg

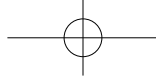

Wide range of applications

EcoVac is suitable for any application where the single liquid suction volume is less than 2L. The applicability includes use of various common consumables, which can be widely used in the collection and removal of liquids in experiments of microorganisms, molecules, proteins, cells, etc.

- Aspiration of supernatants to collect the bacteria
- Aspiration of eluent
- Removal of supernatants during nucleic acid extraction
- Removal of culture media



1.5/2ml ep tube



15/50ml centrifuge tube



Petri dish



96-well plate, microtiter plate

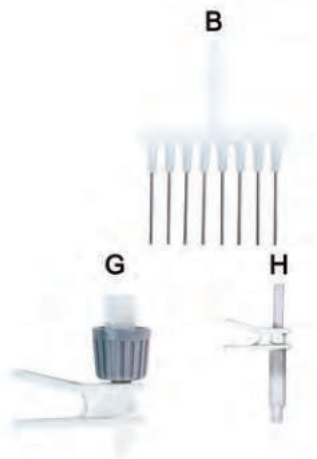
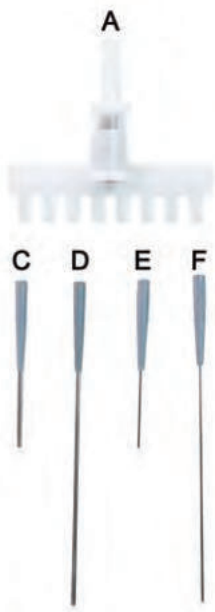

A
C
E
G
I

8-channel tip detrusion adapter 200ul tip

Single needle ϕ 2.5mm, 40mm

Single needle ϕ 1.5mm, 40mm

tiptip detrusion adapter 200ul tip

1L bottle adapter

B
D
F
H
J

8 channel needle ϕ 1.5mm

Single needle ϕ 2.5mm, 120mm

Single needle ϕ 1.5mm, 120mm

tip detrusion adapter 1ml tip

1L bottle

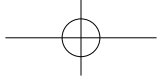

Thermal Control

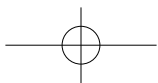

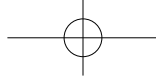

PCR technology is a molecular biology technique for amplifying DNA molecules in vitro. It is mainly used to amplify DNA segments located between two known sequences. PCR technology has been widely used gene cloning, pathogen detection, gene expression and other aspects of many fields such as scientific research, clinical testing, quality control, forensic identification and so on. Appropriate fluorescent dyes were added into the qPCR mixture, QPCR instrument can detect the fluorescence changes during the amplification process real time to qualitative and quantitative the original template.

List of DLAB models:



Product Name	Thermal Cycler Gradient	Thermal Cycler Standard	Real-Time PCR System	
Model	TC1000-G	TC1000-S	Accurate96-X4/X6	Accurate 16-T
Sample Capacity	96x0.2ml	96x0.2ml	96x0.1ml	16x0.2ml
Gradient Temp. Setting range	30-99°C	-	30-100°C	-
Channel	-	-	X4-4, X6-6	Standard-2
Page	P.29	P.29	P.31	P.32

Detection process

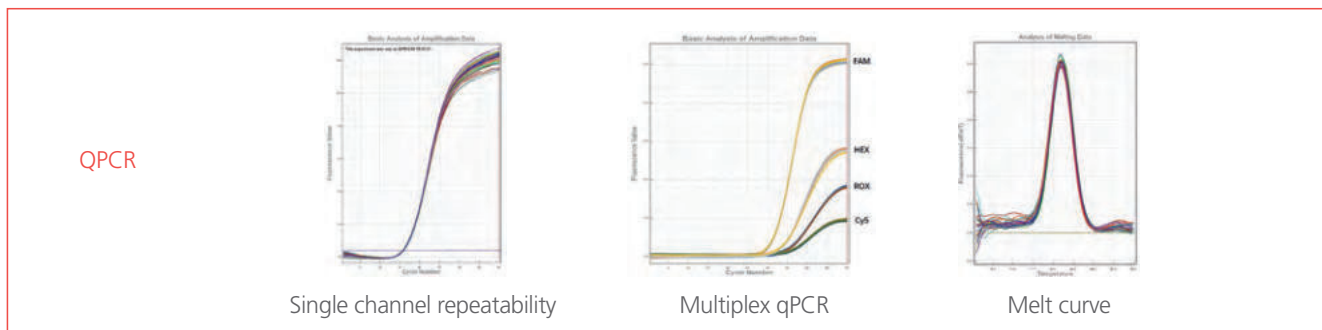
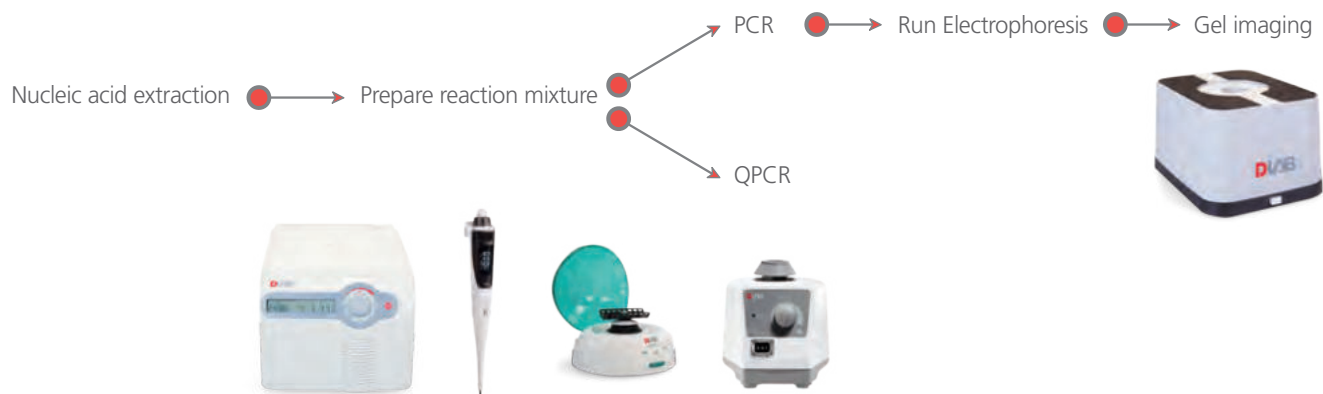

PCR Series

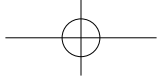

Dry bath provides precise temperature for various experiments. Thermo mix also has mixing function, and it widely used in various fields such as molecular biology and cell biology, including gene synthesis, gene purification, gene cloning, gene expression, protein expression analysis, enzyme reaction, bacterial growth and so on.

List of DLAB models:

Model	Image	Function	Temp. Setting Range	Mixing speed	Blocks	Page
HB60-S		Heating	25°C, 30°C, 37°C, 45°C, 60°C,	-	5ml×30+15ml×8	P.39
HB120-S		Heating	25°C-120°C	-	0.2ml×54 0.5ml×40 1.5/2ml×40 5/15ml×28 5ml blood collection tube×45 50ml×8 (0.2ml+0.5ml+1.5/2ml)×18 0.2ml×96 Microplate Bead/water bath	P.38
HB105-S1/ S2		Heating	25°C-105°C	-	0.2ml×30 0.5ml×20 1.5ml×20 2ml×20	P.40
HB150-S1/ S2		Heating	25°C-150°C	-	15ml×12 50ml×4 Bead/water bath	P.40
H100-Pro		Heating	25°C-100°C	-		P.43
HC110-Pro		Heating& Cooling	-5°C-110°C	-	0.5ml×24 1.5ml×24 2ml×24 5ml×5 15ml×8 50ml×4	P.42
HCM100-Pro		Heating& Cooling& Mixing	0°C-100°C	200-1500rpm	0.2ml×96 Microplate	P.43
HM100-Pro		Heating& Cooling	15°C-100°C	200-1500rpm		P.43
Mini H100		Heating	25°C-100°C	-	0.2ml×40 0.5ml×24 1.5ml×15	P.41
Mini HC100		Heating& Cooling	0°C-100°C	-	2ml×15 5ml×6 15ml×4 50ml×2	P.41
Mini HCL100		Heating& Cooling	0°C-100°C	-		P.41

TC1000-G Thermal Cycler Gradient

TC1000-S Thermal Cycler Standard

Thermal cycler is essential laboratory instrument in the field of molecular biology research such as sequencing, gene cloning, gene expression, mutagenesis applications and applied market like drug discovery, agriculture, food industry, etc.



Excellent temperature uniformity



Gradient function

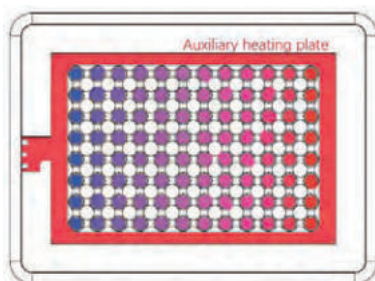

Features

- High performance long life Peltier and independent control circuits for different heating segments implement accurate temperature control
- Auxiliary heating mechanism diminishes the "edge effect" and enhance the temperature uniformity
- Wide touchdown PCR temperature range (-9.9°C~+9.9°C) and Long PCR time range (-9min59s~+9min59s)
- Gradient temperature setting supported, optimizing temperature easily in the single run
- User friendly interface on 7 inch color touch screen enable you edit the program very simple
- The PCR touch screen pen improves the operation experience and reduces the cross contamination risk

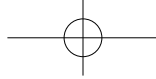

More features

- Wide options of consumables common PCR tubes, 8-well PCR strips and 96-well PCR plates can be used
- File customization, multi-file storage
- Power-off protection function, automatic program recovery
- Hot lid auto-off function: If the module temperature is lower than 30°C, the hot lid function will automatically turn off



LCD touch panel



Excellent temperature accuracy

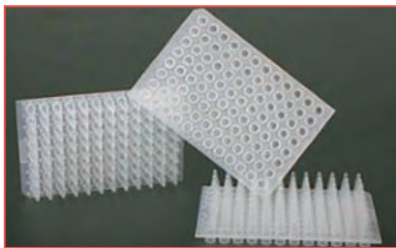

Specifications

	TC1000-G	TC1000-S
Sample Capacity	96X0.2mL PCR tube, 8X12 PCR plate or 96 well plate	96X0.2mL PCR tube, 8X12 PCR plate or 96 well plate
Heating Temperature Range /°C	4~105	4~105
Lid Temperature Range /°C	30~110	30~110
Temperature Display Accuracy /°C	±0.1	±0.1
Temperature Display Accuracy@55°C	±0.3	±0.3
Temperature uniformity@55°C	<0.3	<0.3
Max. Heating/Cooling Rate	5°C/Sec	5°C/Sec
Gradient Temperature Setting Range /°C	30~99°C	-
Gradient Range /°C	1~42°C	-
Adapter block material	Aluminum	Aluminum
Display	7" LCD 800x480	7" LCD 800x480
Input	Touch panel	Touch panel
User defined file system	Max. 30 segments 99 cycles max. 16 folder and 16 files each folder	Max. 30 segments 99 cycle max. 16 folder and 16 files each folder
Power off protection	Yes	Yes
Power Supply	100~120V/200~240V,50/60Hz	100~120V/200~240V,50/60Hz
Dimension[WxDxH]	280x370x250 mm	280x370x250 mm
Weight	11kg	11kg

As a necessary choice for quantitative analysis of molecular biology, real-time PCR system has been widely used in various fields such as scientific research, clinical detection and diagnosis, quality and safety testing, and forensic applications.

Accurate 96 Real-Time PCR System

Features

- Up to 6 fluorescence detection channels allowing multiplex PCR.
- Effectively reduce multi-color crosstalk and edge effect, no ROX correction required to reduce sample and reagent use
- Innovative scanning method and time-resolved signal separation technology to improve detection sensitivity
- Unique edge temperature compensation technology to minimize "edge effect"
- User-friendly software
- Innovative technology with long-lasting LED light provides reliability results



Channel 6	Channel 5	Channel 4
NED/Cy3/TAMRA 543±20/584±20	ROX/Texas Red 571±20/610±20	FAM/SYBR 480±10/518±10
VIC/HEX/TET/JOE 532±10/564±20	CY5/Quasar 670 640±20/692±40	FAM/SYBR 480±10/518±10
Channel 3	Channel 2	Channel 1

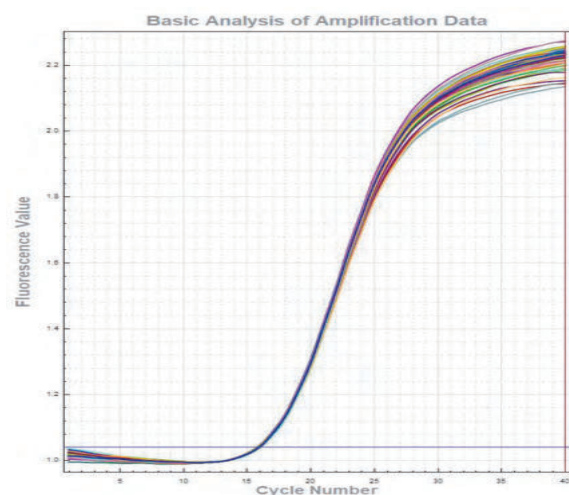

Technical Parameters

Temperature control system		Detection system	
Sample capacity	0.1ml PCR tubes×96, 8×12 PCR plate or 96 well plate ×1	Excitation light source	5/6 monochrome high efficiency LEDs
Reaction volume	10-50 μl	Detection device	PMT
Thermal cycle technology	Peltier	Detection mode	Time-resolved signal separating technology
Max. Heating/Cooling rate	6.0° C/s	Excitation/detection wavelength range	455-650nm/510-715nm
Heating temperature range	4 – 100 °C	Fluorescent channels	4/6 channels
Temperature accuracy	± 0.2°C	Supported dye	FAM/SYBR Green,VIC/HEX ROX,Cy5,Cy3(only for x6)
Temperature uniformity	±0.2°C @60°C , ±0.2°C @95°C	Sensitivity	Single copy gene
Temperature gradient setting range	30–100°C	Resolution	1.33 folds copy number difference can be distinguished in single-plex qPCR
Temperature gradient difference setting range	1 – 36°C	Dynamic range	10 orders of magnitude copies

* For research use only, not for use in diagnostic procedures.

Accurate 16 Fast Nucleic Acid Testing Platform

Designed for rapid nucleic acid testing needs in applied fields such as clinical, food, environmental and research. It is supported by highly-sensitive fluorescence measurements made in real-time. It can detect 16 samples at the same time, and the standard configuration is FAM/SYBR, VIC two-color fluorescence channels. ROX and Cy5 fluorescence channels are optional. It is light & compact and supports stand-alone operations, with 7-inch color touch screen display for results. The instrument adopts innovative liquid cycle refrigeration technology combined with peltier temperature control technology to achieve rapid heating and cooling. It offers CT value analysis, absolute quantitative analysis, supports isothermal amplification and end point analysis (customizable).

Coming soon

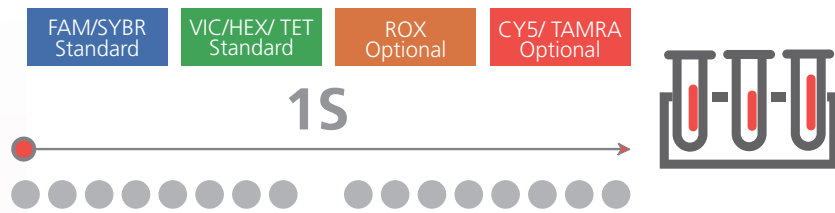

Features

- On board software with large screen panel for ease of use: 7-inch color touch screen shows all parameters, test results and real time testing curve.
- Portable and light : the weight is only 4kg. It can be used with vehicle power supply for immediate onsite detection.
- Ultra-fast temperature control system: unique liquid circulation refrigeration, Variable temperature rate up to 6°C/s.
- Sensitive and efficient optical signal detection system, multi-channel fluorescence without crosstalk: based on unique Fresnel lens, high-efficiency PMT and maintenance-free LED. 16-hole scanning takes only 1s.
- Compatible with 0.2mL PCR clear tubes or eight strips, can measure 16 samples at the same time.
- Software functions can be customized.
- 4G data memory. Testing results can be exported with USB or printed.

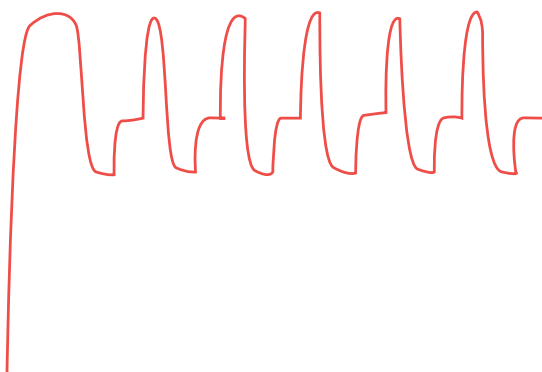

≤30min

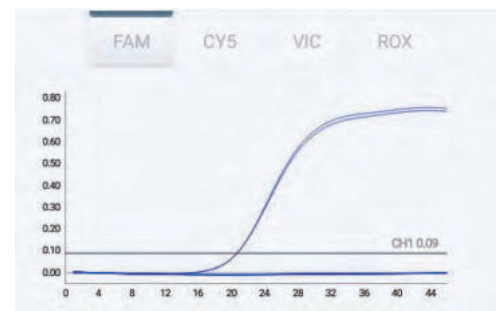

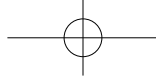

Clinical Disease



Animal Diseases, Pet Infectious Diseases



Food Safety



Environmental Monitoring



Three models for your choice:

Accurate96-T: Touch screen with ultra-fast temperature control system.

Accurate96-i: Touch screen with isothermal function, for customized needs of reagent manufacturer.

Accurate96-S: Controlled by external labtop and software, can be customized with dedicated test kits.

Technical Parameters

	Accurate16-T	Accurate16-i	Accurate16-S
Sample capacity	2×8 0.2ml tube/strips, clear		
Reaction volume	10-50μl		
Touch screen	YES	YES	NO
Thermal cycle technology	Peltier, liquid circulation refrigeration	Heating film	Peltier, liquid circulation refrigeration
Max. Heating/Cooling rate	6.0°C/s		6.0°C/s
Heating temperature range	4 – 100 °C	Room temperature-80°C	4 – 100 °C
Temperature accuracy	±0.2°C	±0.2°C	±0.2°C
Temperature uniformity	±0.2°C @60°C ±0.3°C @95°C	±0.2°C	±0.2°C @60°C ±0.3°C @95°C
Excitation light source	Monochrome high efficiency LED		
Detection device	PMT		
Detection mode	Fast hole-by-hole scanning		
Fluorescent channels	Standard: FAM/ SYBR, VIC/HEX/ TET		Optional: ROX, CY5/TAMRA
Sensitivity	Single copy gene		
Dynamic range	10 orders of magnitude copies		
Analysis mode	CT value analysis, absolute quantitative analysis		
Dimension [W×D×H]	220×275×100 mm		
Power Supply	100-240V or Optional 12V, 10A mobile power		
Weight	4kg		

* For research use only, not for use in diagnostic procedures.

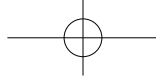

HB120-S Dry bath

Features

- A wide range of temperature control up to 120°C
- Timer control up to 99+ hours
- Various types of optional blocks are available
- Overheating protection
- Lid for protection and heat preservation

Specifications

Functions	HB120-S
Temperature range	Heating Room temp.-120°C
Temperature setting range	15°C~120°C
Temperature control accuracy [at 37°C]	± 0.5°C
Temperature uniformity	± 0.5°C
Max. heating rate	5.5°C/min
Overheating protection	140°C
Timer	0min-99h59min
Display	LED
Adapter block material	aluminum
Voltage, Frequency	100-120V/220-240V,50Hz/60Hz
Power	160W
Dimension[WxDxH]	175 x 290 x 85mm
Weight	3kg



Adapter block selection



Overheating protection



Timer



LED display



Cat.No.

Standard:18900218
Thin:18900274

Block types



0.2mLx54

Diameter Depth

6.4mm
15mm

Standard:
18900219
Thin:18900275

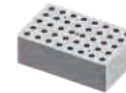

0.5mLx40

8.2mm
26.4mm

Standard:
18900253(1.5mL)
18900220(2mL)
Thin:
18900276(1.5mL)
18900277(2mL)



1.5mLx40
2mLx40

11mm
34.7mm

Standard:18900221



5/15mLx28

17mm
48mm

Standard:18900546



5mL blood collection
tube x 45

13.5mm
48mm

Standard:18900222



50mLx8

29.8mm
48mm

Standard:18900224
Thin:18900278



0.2mL+0.5mL+1.5/2mL
18+18+18

-

Standard:18900223
Thin:18900279



96 or 384 well plate

-

Thin:18900504



8 PCR strips and
96 PCR microplate

-

18900523



Two-in-one block, bead
bath/water bath

-

HB60-S Dry bath

Features

- Excellent temperature control accuracy and uniformity to protect samples and ensure precision result of tests
- Timer function and continuous function are available to meet different applications
- Fast heating rate to improve the efficient workflow
- Especially suitable for sample preparation of semiautomatic biochemistry analyzer
- 5ml and 10ml mixed heating block
- Overheating protection



Overheating protection



Timer



LED display

Specifications

	HB60-S
Heating temperature range	5 gears: 25°C, 30°C, 37°C, 45°C, 60°C
Temperature accuracy	± 0.5°C
Temperature uniformity	± 0.3°C
Max. heating rate	5.5°C /min
Safety temperature	80 °C
Time setting range	0min -99h59min
Operation type	Continuous/ timer operation
Capacity	5ml×30+10ml×8pcs
Display	LED
Voltage [VAC]	200~240
Frequency [Hz]	50/60
Power [W]	160
Dimensions[W×D×H]	175×290×85mm
Weight[kg]	2.5

Block types



Capacity

5/10mLx38

Diameter
Depth

Φ13m/15.25mm
33mm



Dry Bath

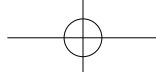

HB105-S1/HB105-S2 HB150-S1/HB150-S2 Dry bath

Features

- A wide range of temperature control up to 105°C/150°C.
- Overheating protection.
- Sound reminder function.
- External temperature sensor PT1000
- Block equipped with a lid for heat preservation and prevent pollution.
- Knob adjustment is easy to operate.

Cat.No.	Block types	Capacity	Diameter Depth
18900459		0.2mLx30	6.4x15mm
18900410		0.5mLx20	8.2x26.4mm
18900461		1.5mLx20	11x34.7mm
18900462		2mLx20	11x34.7mm
18900412		5/15mLx12	17x48mm
18900413		50mLx4	29.8x48mm
18900522		Two-in-one block, bead bath/water bath Adapt to S1	
18900523		Two-in-one block, bead bath/water bath Adapt to S2	
18900520	Aluminum beads		



Specifications	HB105-S1	HB105-S2	HB150-S1	HB150-S2
Temperature range[°C]	Room temp+5~105	Room temp+5~105	Room temp+5~150	Room temp+5~150
Temperature setting range [°C]	25~105	25~105	25~150	25~150
Temperature control accuracy[°C]	25-90: ±0.3 90-105: ±0.6	25-90: ±0.3 90-105: ±0.6	25-90: ±0.3 90-150: ±0.6	25-90: ±0.3 90-150: ±0.6
Temperature uniformity@37°C [°C]	±0.2	±0.2	±0.2	±0.2
Power [w]	100	200	100	200
Time setting range	0~99h59min	0~99h59min	0~99h59min	0~99h59min
External sensor	Yes	Yes	Yes	Yes
Display	LED	LED	LED	LED
Power supply	110/220V, 50/60Hz	110/220V, 50/60Hz	110/220V, 50/60Hz	110/220V, 50/60Hz
External dimension[mm]	290x210x120	290x210x120	290x210x120	290x210x120
Weight[kg]	3.2	3.2	3.2	3.2
Operating temperature[°C]	+10~40	+10~40	+10~40	+10~40
Operating humidity [% RH]	<80	<80	<80	<80

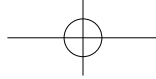

Mini Dry bath is portable, compact and convenient. It is useful for rapid and uniform heating of biological samples, in applications like preservation and denaturation of nucleic acids and proteins, etc.

Mini HCL100 Mini HC100 Mini H100 Dry Bath

Features

- Light in weight
- LCD display of both temperature and time.
- Rapid calibration support
- Overheating protection
- Optional blocks with different capacities are available
- Safe and stable
- USB interface to save the data
- Mini HCL100 with hot lid provided to preserve the generated heat

Cat.NO.	Block types	Capacity	Diameter x depth
18900414		0.2mlx40	6.4x20 mm
18900415		0.5mlx24	8.2x28.4mm
18900416		1.5mLx15	11.2x31mm
18900428		2mlx15	11x31mm
18900417		5mLx6	17x31mm
18900426		15mlx4	16.4x45mm
18900427		50mlx2	29x45mm

Specifications

	Mini HCL100	Mini HC100	Mini H100
Temperature setting range[°C]	0-100	0-100	25-100
Temperature range [°C]	Room temperature-23~100	Room temperature-23~100	Room temperature+5~100
Temperature control accuracy[°C]	±0.5	±0.5	±0.5
Temperature display accuracy[°C]	0.1	0.1	0.1
Minimum time taken for heating(25°C-100°C)	≤20min	≤20min	≤20min
Minimum time for cooling (20°C-0°C)	≤25min	≤25min	/
Max. Heating Rate	8°C/min	8°C/min	6.5°C/min
Max. Cooling Rate	3°C/min	3°C/min	/
Time setting range	0-999min/0-999sec	0-999min/0-999sec	0-999min/0-999sec
Display	LCD	LCD	LCD
No. of programs in memory	9(2steps for each)	9 (2steps for each)	9(2steps for each)
Rapid calibration	Support	Support	Support
USB interface	Support	Support	Support
Error code reminder	Support	Support	Support
External dimension [mm]	110x162x140	110x162x140	110x162x140
Overall weight [kg]	≤1	≤1	≤1
Power supply	DC12V,100-240V, 50/60Hz	DC12V,100-240V, 50/60Hz	DC12V,100-240V, 50/60Hz
Power[w]	60	60	60
Operating temperature[°C]	+10-40	+10-40	+10-40
Operating humidity [% RH]	≤80	≤80	≤80

Dry Bath

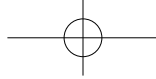

HC110-Pro Thermo control with cooling

Features

- Precise temperature control for heating and cooling
- Flexible adapter selection
- Programmable
- Compatible with various tubes
- Quick interchange of blocks with magnet adhesion technology without any tools
- Block equipped with a lid for heat preservation
- Three-point temperature calibration



Excellent temperature accuracy



Programmable



Block self recognition



Cat.No.	Blocks	Speed	Capacity	Diameter x Depth
18900401		1500rpm	24x0.5mL	8.1x26mm
18900402		1500rpm	24x1.5mL	10.9x30.8mm
18900403		1500rpm	24x2mL	10.9x30.8mm
18900404		1500rpm	8x5mL (round bottom)	13.6x42mm
18900405		1400rpm	8x5mL (cone bottom)	17x51.5mm
18900406		800rpm	8x15mL	16.9x80mm
18900407		600rpm	4x50mL	29.6x80mm
18900420		1500rpm	0.2mLx96 PCR plate	-
18900423		1500rpm	microplate	-

Specifications

Functions	HC110-Pro
Temperature range	Heating & cooling Heating: room temp. - 110°C Cooling: room temp. - below room temp. 25°C
Temperature setting range specifications	-5~110°C
Temperature control accuracy[@20-45°C]	± 0.5°C
Temperature uniformity[@20-45°C]	± 0.5°C
Max. heating rate	5.5°C/min
Max. cooling rate	2.5°C/min (100°C-room temp.) 0.5°C/min (below room temp.)
Time setting range	0~99h30min
Program	9
Overheating protection	150°C
Display	TFT
Adapter block material	aluminum
Voltage, Frequency	100-240V,50/60Hz
Power	200W
Dimension[WxDxH] (without the heating block)	200x235x120mm
Weight	7.3kg

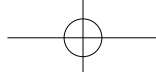

HCM100-Pro

Thermo Mix

HM100-Pro

Thermo Mix with heating

H100-Pro

Thermo control



Features

- Excellent mixing result
- Stable and wide range of speed adjustment
- Precise temperature control for heating and cooling
- Flexible adapter selection
- Programmable
- Compatible with various tubes
- Quick interchange of blocks with magnet adhesion technology without any tools
- Block equipped with a lid for heat preservation
- Three-point temperature calibration

Thermo Mix series allow for precise and efficient heating cooling and mixing, as well as excellent temperature accuracy and uniformity, compatible for a wide range of applications, such as gene synthesis, gene purification, gene and protein denaturation, enzymatic reaction, bacterial growth, etc.



Blocks self recognition



Thermo Mix

Specifications

	HCM100-Pro	HM100-Pro	H100-Pro
Functions	Heating, cooling & mixing	Heating & mixing	Heating
Temperature range	Heating: room temp. - 100°C Cooling: room temp. - below room temp. 15°C	Heating: room temp. - 100 °C	Heating: room temp+5 °C. - 100°C
Temperature setting range specifications	0.1~100°C	15~100°C	15~100 °C
Temperature control accuracy[@ 20~45°C]	± 0.5°C	± 0.5°C	± 0.5°C
Temperature uniformity[@ 20~45°C]	± 0.5°C	± 0.5°C	± 0.5°C
Max. heating rate	5.5°C/min	5.5°C/min	5.5°C/min
Max. cooling rate	5°C /min(100°C-room temp.) 0.5°C/min(below room temp.)	-	-
Mixing frequency	200-1500rpm	200-1500rpm	-
Mixing orbit	3mm	3mm	-
Time setting range	0~99h30min	0~99h30min	0~99h30min
Program	9	9	9
Overheating protection	150°C	150°C	150°C
Display	TFT	TFT	TFT
Adapter block material	aluminum	aluminum	aluminum
Voltage, Frequency	100-240V,50/60Hz	100-240V,50/60Hz	100-240V,50/60Hz
Power	200W	200W	200W
Dimension[WxDxH] (without the heating block)	200×235×120mm	200×235×120mm	200×235×120mm
Weight	7.3kg	7.3kg	7.3kg

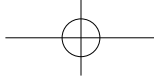

The water bath is widely used for the day to day bacteriological and laboratory applications requiring incubation as well as general tests and procedures in variety of research and testing laboratories. Water baths also have a variety of usages in tissue culture application, enzyme reaction studies, growth observation studies, Fermentation analysis and various other general and specialized application in various laboratories.



DWB20-S Water Bath

Features

- Rapid heating, the temperature remains constant after reaching the set temperature
- High temperature accuracy with overheating protection
- High temperature resistant and corrosion free lid made up of 304 stainless steel
- Electronic components are easy to disassemble. Safe and easy to maintain

Specifications

	DWB20-S
Display	LED
Temperature range [°C]	Room temp.+5-80
Temperature stability at 37°C[°C]	±0.5
Temperature accuracy at 37°C[°C]	±0.3
Bath volume [L]	20
Circulating pump	No
Overheating protection	yes
Temperature sensor	PT1000
Dimension[mm]	667x349x357
Housing	Q235 Plastic panel
Parts touch water (including lid)	Stainless steel
Weight[kg]	16.2
Voltage[V]	220V, 50/60Hz
Heating power[W]	1000
Ambient temperature[°C]	+10-40
Ambient humidity[% RH]	<80

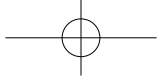

Distilling

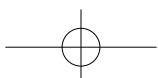

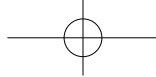

Rotary evaporator is mainly used for continuous distillation of volatile solvents under reduced pressure. It is widely used in chemical, pharmaceutical, research and food industries, etc.

List of DLAB models:

Series	Lab Scale Rotary Evaporator	Industrial Scale Rotary Evaporator	
			
Model	RE100-Pro	RE100-S	RE200-Pro
Evaporating Flask Volume	50-2000ml	50-2000ml	20L
Evaporation capacity (H₂O)	1.56L/h	1.56L/h	4.0L/h
Automatic lifting	YES	No (Manual lifting)	YES
Display	LCD	LED	LCD
Page	P.49	P.50	P.47

Distilling

Distillation System Connection (For RE100-Pro&RE100-S):

Model	Page
Vacuum Pump C410	P.55
Vacuum Controller VC100	P.56
Low Temperature Circulator CCP5-15/20	P.53

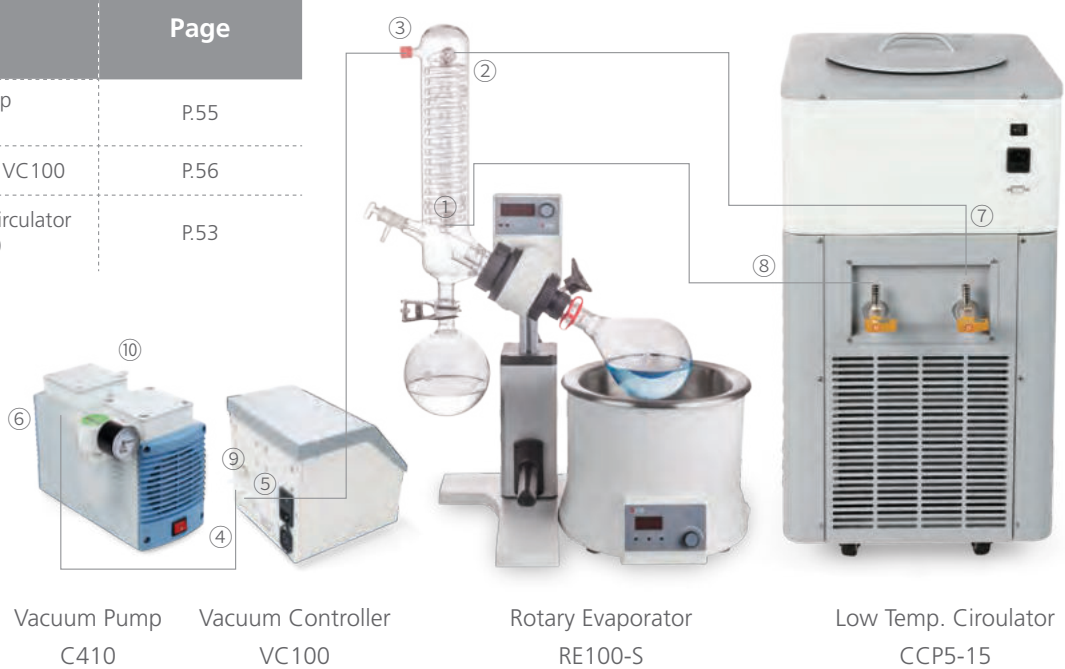

Vacuum Pump C410

Vacuum Controller VC100

Rotary Evaporator RE100-S

Low Temp. Circulator CCP5-15

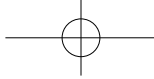

RE200-Pro 20L Industrial Digital Rotary Evaporator

Large Scale LCD Digital evaporator is mainly used for continuous distillation of a large number of volatile solvents under reduced pressure. It offers an excellent distilling solution in a wide range of applications.



Features

- Large LCD digital display with heating temperature, rotation speed, clockwise and Anti-clockwise, time information
- One-click automatic motor lifting (stroke 180mm), smooth and silent
- Water/oil heating bath with wide temperature range from room temp.to 180°C
- Speed range from 10 to 150rpm, and interval operation in clockwise and anti-clockwise directions for drying process
- Three-layer high-efficiency condensing tube with large condensation area and strong evaporation capacity, ensuring efficient sample recovery
- Patented connector for evaporating flask easy&quick installation
- PTFE double sealing ring with excellent sealing performance
- A switching valve for continuous collection without compromising the system vacuum and solvent distillation



Rotary Evaporator



Large LCD display



Overheating protection



Chemical resistance

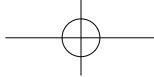

Double-layer high-efficiency condenser
large condensation area and strong evaporation capacity, ensuring efficient sample recovery.



Switching valve design
A switching valve for continuous collection without compromising the system vacuum and solvent distillation.



Heating bath

- Water&oil bath;
- Enhanced lifetime through exclusive use of corrosion-free stainless-steel;
- The heating bath adopts special heat insulation structure design, so that the surface temperature is far lower than the temperature in the bath, to avoid personnel burns.

Specifications

RE200-Pro		
performance	Temperature range	Room temp. ~180°C (both water and oil)
	Control Accuracy	Water: ±1°C Oil: ±3°C
	Rotation Speed	10~150rpm
	Evaporation capacity	Max.4.0L/h (water vapor volume)
	Ultimate vacuum	Less 2.6hpa
function	Temperature control method	Micro processor PID control
	Display	LCD (temperature/speed/clockwise and Anti-clockwise/time)
	Stroke Displacement	Automatic 180mm
constitute	Safety features	Motor over-current protection, Residual Current Device, lifting overload protection, Boil-dry protection, over-temperature protection
	Sample flask	Round flask 20L
	Receiving flask	Round flask 10L with drain valve
	Condenser	Two-section vertical triple serpentine condenser, cooling surface 1.2m ²
Specification	Heating bath size	φ450×240mm
	Takeover caliber	Cooling/suction nozzle outer diameter 16mm, vacuum pump nozzle outer diameter 16mm
Dimension[D×W×H]		1160mm×600mm×1860mm
Power supply		220V/4600W/50/60Hz

RE100-Pro

Digital Rotary Evaporator



LCD Digital Rotary Evaporator is an essential instrument in chemical laboratories for the efficient and gentle removal of solvents from samples by evaporation. It offers an excellent distilling solution in a wide range of applications.

Features

- Digital display of both rotation speed and heating temperature allows for optimal control of all distillation processes
- Automatic motor lift releases the evaporating flask to a safe position in case of power failure
- 5L heating bath with wide temperature range from room temp. to 180°C, Water/oil heating mode can be changed only through a switch
- Overheating protection temperature at 220°C
- Boil-dry protection, automatically power off if heating without water/oil in the heating bath
- Speed range from 20 to 280rpm, and interval operation in clockwise and anticlockwise directions for drying process
- Patented condenser (cooling surface 1700cm²) with excellent cooling effect
- Ejection mechanism ensures easy removal of evaporating flask
- Patented double spring sealing ring made of PTFE provides an excellent sealing performance
- Remote function provides PC control and data transmission
- Optional glassware with explosion proof film available.

Rotary Evaporator



Large LCD display

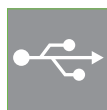

USB connector



Chemical resistance



Overheating protection



Compatible with all range of glassware

Specifications

	RE100-Pro
Motor Type	Brushless DC motor
Speed Range	20-280rpm
Display	LCD(speed, temperature, time)
Clockwise and Anti-clockwise	Yes
Heating Temperature Range	Room temp. to 180°C
Control Accuracy	water: ±1°C oil: ±3°C
Heating Power	1300W
Stroke Displacement	automatic 150mm
Timer	Yes
Time Setting Range	1-999min
Dimension[D×W×H]	465×457×583mm
Weight	15kg
Permissible Ambient Temperature	5-40°C
Permissible Relative Humidity	80%RH
Protection Class	IP20
USB Interface	Yes
Voltage/Frequency	100-120/200-240V 50/60 Hz
Power	1400 W

DLAB LED Digital Rotary Evaporator is a basic chemical laboratory instrument suitable for evaporation, distillation and separation of chemicals. It can be used as a multifunctional system in combination with vacuum pump, vacuum controller and circulating refrigerators to provide excellent distillation solutions in many laboratory applications.

Features

- 5L heating bath with a wide temperature range (room temp. to 180°C). Independent temperature control makes it can be used separately. Water/oil heating mode can be changed only through a switch
- Manual lift combined with auxiliary lift for precise positioning of the glassware
- PID control ensures high temperature accuracy at $\pm 1^\circ\text{C}$ (water)
- Overheating protection temperature at 220°C
- Boil-dry protection, automatically power off if heating without water/oil in the heating bath
- Speed range from 20 to 200rpm, timing interval operation in clockwise and anticlockwise directions for drying process
- Patented condenser (cooling surface 1200/1700cm² for selection), double helix condensing tube + center circular arc design to speed up the flow rate of liquid with excellent cooling effect
- Ejection mechanism ensures easy exchange of evaporating flask
- Adjustable immersion angle
- Patented double spring sealing ring which is made of PTFE provides an excellent sealing performance
- Remote function provides PC control and data transmission
- Compatible with the entire range of RE100-Pro glassware
- Optional glassware with explosion proof film available
- Overheating protection above 50°C



USB connector



Chemical resistance



Overheating protection



Compatible with all range of glassware

RE100-S LED Digital Rotary Evaporator



Specifications

	RE100-S
Motor Type	Brushless DC motor
Speed Range	20-200rpm
Display	LED (speed, temperature, time)
Clockwise and Anti-clockwise	Yes
Heating Temperature Range	Room temp. to 180°C
Control Accuracy	water: $\pm 1^\circ\text{C}$ oil: $\pm 3^\circ\text{C}$
Heating Power	1200 W
Stroke Displacement	Manual 110mm + auxiliary 100mm
Interval Time Setting Range	1~999s
Dimension [D×W×H]	Main Unit: 440×320×450mm Heating Bath: 300×300×240mm
Weight	Main Unit: 7kg Heating Bath: 3kg
Permissible Ambient Temperature	5~40°C
Permissible Relative Humidity	80%RH
Protection Class	IP20
USB Interface	Yes
Voltage/Frequency	100~120/200~240V 50/60 Hz
Power	1245 W

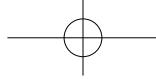

Vertical

Cat. No.	Glassware type	Volume	Cooling surface
18900165	Evaporating flask(NS29/32) Receiving flask(KS35/20)	1000mL	1700cm ²
18900173	Evaporating flask(NS24/40) Receiving flask(KS35/20)	1000mL	1700cm ²
18900166	(COATED)Evaporatingflask(NS29/32) Receiving flask (KS35/20)	1000mL	1700cm ²
18900174	(COATED)Evaporatingflask(NS24/40) Receiving flask (KS35/20)	1000mL	1700cm ²
18202410	evaporating flask (NS 29/32) Receiving flask (KS 35/20)	1000mL	1200cm ²

Diagonal

Cat. No.	Glassware type	Volume	Cooling surface
18900163	Evaporating flask(NS29/32)Receiving flask(KS35/20)	1000mL	1700cm ²
18900171	Evaporating flask(NS24/40)Receiving flask(KS35/20)	1000mL	1700cm ²
18900164	(COATED)Evaporatingflask(NS29/32) Receiving flask (KS 35/20)	1000mL	1700cm ²
18900172	(COATED)Evaporatingflask(NS24/40) Receiving flask (KS35/20)	1000mL	1700cm ²

Heating Bath

Cat. No.	Description	Volume
18900201	Rotary Evaporator, 220V	5L
18900202	Rotary Evaporator, 110V	5L
6033100210	LED heating bath, 100V-120/200-240V,50/60HZ	5L

New

Heating Bath Lid

Cat. No.	Description
18900547	heating Bath lid for RE100-S, improve distillation efficiency & ensure personal safety from liquid splash

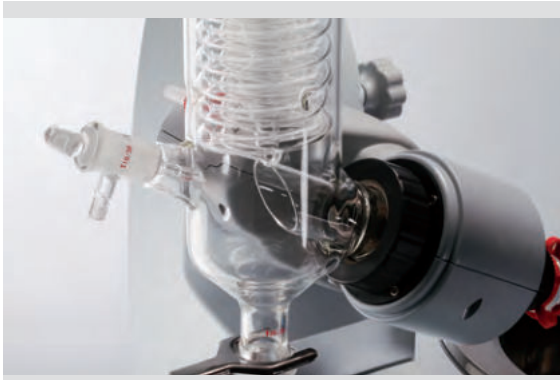

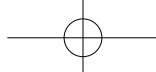

Glassware



Evaporating flask

Cat. No.	Volume	Size
18300116	50mL	NS 29/32
18300117	100mL	NS 29/32
18300118	250mL	NS 29/32
18300119	500mL	NS 29/32
18300120	1000mL	NS 29/32
18300121	2000mL	NS 29/32
18300655	50mL	NS24/40
18300201	100mL	NS 24/40
18300202	250mL	NS 24/40
18300203	500mL	NS 24/40
18300204	1000mL	NS 24/40
18300205	2000mL	NS 24/40



Receiving flask

Cat. No.	Volume	Size
18300107	100ml	KS 35/20
18300108	250ml	KS 35/20
18300109	500ml	KS 35/20
18300110	1000ml	KS 35/20
18300111	2000ml	KS 35/20



Distilling spider with 5 flasks(without flask)

Cat. No.	Volume	Size
18900194	/	NS 29/32, NS24/29
18900177	/	NS 29/42, NS24/40

Foam brake

Cat. No.	Volume	Size
18300093	250ml	NS 29/32
18300207	250ml	NS 24/40



Connector

Cat. No.	Volume	Size
18300094	/	NS 29/32, NS24/29
18300095	/	NS 29/32, NS19/26
18300096	/	NS 29/32, NS14/23
18300199	/	NS24/40, NS19/22
18300200	/	NS 24/40, NS14/20
18900193	/	NS 24/40, NS 29/42

Cat. No.	Volume	Size
18100998	/	NS 29/32
18300206	/	NS 24/40

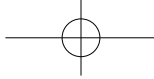

The low temperature circulator continuously offers chilled coolant to rotary evaporator and other instrument which working in a low temperature condition. It reduces the consumption of tap water and improve the cooling efficiency. With a compact structure and environment-friendly design, it is an ideal choice for academic, analytical and industrial laboratories.

CCP5-15 CCP5-20

Low Temperature Circulator

Features & Advantages

- PID temperature control with built-in PT1000 sensor provides high accuracy of temperature control
- LED display shows the set or actual temperature clearly
- Short circuit protection, over-current/overload protection, and delayed start protection
- Integrated design of drain outlet and coolant circulation outlet for convenient operation
- German-made pump that is environment-friendly, quiet and durable
- The compressor employs state-of-the-art R290 environment-friendly refrigerant to protect environment and human health
- CCP5-20 support connecting 2 units evaporators with excellent cooling performance (need order another hose 18203125 for this application)



- The part in contact with liquid is made of stainless steel or high-quality corrosion-resistant material;



- User-friendly operating panel configuration;



- A large-volume open reservoir allows easy filling and supports cold trap experiment;



- The caster design for free movement and fixing.



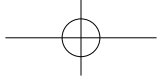

Specifications	CCP5-15	CCP5-20
Range of temperature control	-15°C-Room temperature	-20°C-Room temperature
Temperature adjustment accuracy	0.1°C	0.1°C
Temperature control accuracy	±1.0°C (-20°C ~0°C typical value) ±0.5°C (0°C ~20°C typical value)	±1.0°C (-20°C ~0°C typical value) ±0.5°C (0°C ~20°C typical value)
Reservoir capacity	5L	5L
Range of temperature adjustment	-30°C~30°C	-30°C~30°C
Temperature display	LED	LED
Type of temperature sensor	PT1000	PT1000
Compressor refrigerant	R290	R290
Circulating pump throughput	12L/min	12L/min
Pump pressure	0.6 bar	0.6 bar
Circulating pump head	6m	6m
In-out cycle interface	12mm pagoda-type interface	12mm pagoda-type interface
RS232 interface	Yes	Yes
Machine power	350W	700W
Maximum overall dimensions	370 x 420 x 730(mm) with caster	440 x 460 x 730(mm) with caster
Weight	46kg	50kg
Power supply	220V 50Hz/60Hz	220V 50Hz/60Hz, 110V 50Hz/60Hz
Operating environment	10~40°C, RH≤80%	10~40°C, RH≤80%

Cooling capacity

CCP5-15	°C	-15	-10	-6.7	-5	0	5	7.2
	W	381	460	520	553	661	786	847
CCP5-20	°C	-20	-13	-10	0	10	14	20
	W	607	668	694	785	883	924	989

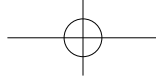

Additional

MZ 1C Chemistry-design diaphragm pump





Specification

Number of heads / stages:2 / 2
 Max. pumping speed:0.75 m³/h
 Ultimate vacuum (abs.):12mbar
 Nozzle Size:DN 8-10 mm
 Rated motor power:0.06kW
 Rated motor speed:1500/1800 rpm
 Noise level:45dB
 ATEX:II 3G IIC T3 X Internal Atm. only

Cat. No.	Voltage
18900231	Cn plug, 100V-120V/200-230V 50Hz/60Hz
18900232	Euro plug,100V-120V/200-230V 50Hz/60Hz
18900233	USA plug,100V-120V/200-230V 50Hz/60Hz
18900234	UK plug,100V-120V/200-230V 50Hz/60Hz



Seals and other accessories

Cat. No.	Description	
1820207	PTFE vacuum seal	
18900362	Ultra resistant FFKM seal for applications with highly abrasive solutions	
18900190	Evaporation flask clip(red) CS002440	
18900188	Evaporation flask clip(green) CS002942	

C410 Chemistry-design diaphragm pump

Specification

Maximum Vacuum:13mbar
 Work Mode: Continuous Operation
 Nozzle Size:8mm, Power: 95W
 Motor speed:1450rpm
 Flow Rate:
 mbar :1000 | 880 | 750 | 600 | 480 | 280
 L/min : 25 | 22 | 20 | 12 | 7.5 | 5



Vacuum regulator/moisture trap

Cat. No.	Description
18900186	In use of control small volume, installed in a vacuum between DVR480 and vacuum system. Material: PVDF, PTFE, ABS, Borosilicate Glass, Stainless Steel



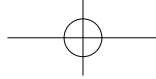

The vacuum controller serves as a device for labs to display, adjust and control the degree of vacuum in vacuum systems. It generally constitutes the vacuum control system of rotary evaporator along with vacuum pump, which enables repeatable distillation experiment and recovery of many kinds of solvents in an efficient and automatic manner.

VC100 Vacuum Controller

Features

- A wide range of measurement and control, 1-1,000mbar
- Two control modes of single-point control and programmed control available for choice as needed
- Can store up to 5 programs, each containing up to 5 segments of programming control
- A large-size TFT touch screen display control allows easy operation
- All parts in contact with vapor or liquid are made of PTFE, ceramics or other high-performance materials and can effectively resist corrosion caused by organic solvents, water, acid and alkali
- A built-in vent valve can feed inert gas into system equipment
- One-stroke decompression allows easy installation and dismantling of vacuum system
- Can be connected with pump power control for temporary shutdown of pump power supply after reaching stable degree of vacuum for energy conservation and environmental protection. Can also be operated in the normally open statue of pump



Specifications

VC100

Vacuum setting range	1-1000mbar
Vacuum measurement range	1-1000mbar
Control operation mode	Single-point control mode, Programmed control mode
Control program	Can store up to 5 programs, each containing 5-step control (capable to set the degree of vacuum and time)
Setting method	Touch screen setting
Display	5" TFT
Sensor overload pressure	1,500mbar
Connector diameter	8mm
Materials in contact with vapor	PTFE, PP, silicone and ceramics
Power	600W
Compatible conditions with vacuum pump	power of 50Hz vacuum pump $\leq 400W$ power of 60Hz vacuum pump $\leq 500W$
Overall dimensionsW×D×H	189×207×193mm
Weight	4.0kg
Power supply	110—240V,50Hz/60Hz
Operating environment	10°C~40°C, $\leq 80\%RH$



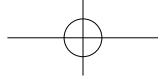

Mixing & Heating

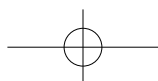

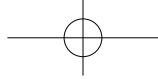

Magnetic hotplate stirrers are used for low viscosity liquids or solid mixing, widely used in chemical synthesis, physical and chemical analysis, bio-pharmaceuticals etc. DLAB provides different series, heating range covers from 120°C-550°C:

Magnetic Hotplate Stirrers:

Series	Model	Image	Stirring Position	Display	Work plate Size	Max. Heating Temp.	Max. stirring quantity[H ₂ O]	Page
550 series	MS7-H550-Pro		1	LCD	184x184mm	550°C	20L	P.62
	MS7-H550-S		1	LED	184x184mm	550°C	10L	P.62
380 series	MS-H380-Pro		1	LCD	140x140mm	380°C	20L	P.68
340 series	MS-H-Pro ^T (with timer)		1	LCD	φ135mm	340°C	20L	P.64
	MS-H-Pro ^A		1	LCD	φ135mm	340°C	20L	P.66
	MS-H-Pro ⁺		1	LCD	φ135mm	340°C	20L	P.64
	MS-H-S		1	Scale	φ135mm	340°C	20L	P.64
	MS-H340-S		4	LCD	φ135mm	340°C	10L for single position	P.69
280 series	MS-H280-Pro		1	LED	φ135mm	280°C	3L	P.67
120 series	MS-H-S10		10	Scale	180x450mm	120°C	0.4Lx10	P.70

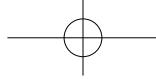

Magnetic Stirrers:

Image	Model	Stirring Position	Display	Work plate Size	Max. Stirring Quantity[H ₂ O]	Page
	MS7-S	1	Scale	184x184mm	10L	P.75
	MS-S	1	Scale	φ135mm	20L	P.75
	MS6-Pro	1	LCD	140x140mm	5L	P.75
	MS-PA	1	LED	φ135mm	3L	P.76
	MS-PB	1	Scale	φ135mm	3L	P.76
	EcoStir	1	Scale	120x115mm	1.5L	P.79
	EcoStir	1	Scale	φ120mm	1.5L	P.78
	FlatSpin	1	--	φ90mm	0.8L	P.78
	MS-M-S10	10	Scale	180x450mm	0.4Lx10	P.77

Hotplate:

Image	Model	Display	Work plate Size	Max. Heating Temp.	Page
	HP550-S	LED	184x184mm	550°C	P.74
	HP380-Pro	LCD	140x140mm	380°C	P.74

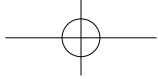



Application guidance:

Notice: MS-H380-Pro, HP380-Pro & MS-H280-Pro are not available for chemical fields.

Fields		MS7-H550-Pro/ MS7-H550-S/ HP550-S	MS-H-Pro ^A / MS-H-Pro ^T / MS-H-Pro ⁺ / MS-H-S/ MS-H340-S	MS-H380-Pro/ HP380-Pro	MS-H280-Pro	MS-H-S10	Magnetic Stirrers (none heating models)
Pharmaceutical	Chemical Synthesis	■	■				
	Biochemical Drugs	■	■				
	Medicine Testing	■	■				
	Drug Formulation	■	■				
Chemical Industry	Petrochemical Industry	■	■				
	Inorganic Chemical Synthesis	■	■				
	Organic Chemical Synthesis	■	■				
	Daily Use Chemical Industry	■	■				
	Painting/Rubber/Plastic	■	■				
Fertilizer/Pesticide	■	■					
Environmental	Water Quality Analysis					■	■
	Pesticide Residue Testing					■	■
	Chemical Pollution Analysis					■	■
Research & Education	Basic Chemical Experiments	■	■			■	■
	Material Analysis			■	■	■	■
	Liquid Mixing			■	■	■	■
	Chemical Synthesis	■	■				
Food Industry	Food Additive	■	■	■	■		
	Dairy Products	■	■	■	■		
	Nutrition Analysis	■	■	■	■		
Biological Engineering	Cell Culture						
	Biological Reagents		■	■	■	■	
	Biochemistry		■	■	■	■	

Overhead stirrers are used for middle or high viscosity samples mixing, widely used in chemical synthesis, pharmaceutical synthesis, physical and chemical analysis, petrochemical industries etc.

Overhead stirrers:

Image					
Models	OS20-Pro	OS20-S	OS40-Pro	OS40-S	OS70-Pro
Max. Stirring Quantity[H₂O]	20L	20L	40L	40L	70L
Constant Speed	YES	NO	YES	NO	YES
Display	LCD	LED	LCD	LED	LCD
Speed Range	50-2200rpm	50-2200rpm	50-2200rpm	50-2200rpm	50-1100rpm
Max. Torque	40N•cm	40N•cm	60N•cm	60N•cm	300N•cm
Viscosity Max.	10000mPa•s	10000mPa•s	50000mPa•s	50000mPa•s	100000mPa•s
Page	P.76	P.77	P.76	P.77	P.76

Overhead Stirrer

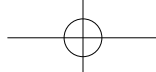

DLAB 550°C series magnetic stirrer is developed for demanding applications. It is widely used in chemical synthesis, physical and chemical analysis, bio-pharmaceuticals etc. Combining with glass ceramic work plate, brushless DC motor and external temperature sensor, the work plate temperature is optimized up to 550°C.



MS7-H550-Pro LCD Digital Magnetic Hotplate Stirrer

Features

- LCD display for precise monitoring of speed and temperature
- Built-in PID controller ensures safe heating of the medium with overheating protection
- Max. heating plate temperature 550°C
- Glass ceramic work plate provides excellent chemical resistant performance and most efficient heat transfer
- External temperature control is possible by connecting the temperature sensor(PT1000) with an accuracy at $\pm 0.2^{\circ}\text{C}$
- Digital speed controlling, max. speed at 1500rpm
- Outstanding brushless DC motor enables more stirring power
- Two rotating knobs enable easy adjustment of speed and temperature
- The "HOT" warning will flash when the work plate temperature is above 50°C even when the hotplate is turned off
- Remote function provides PC control and data transmission

MS7-H550-S LED Magnetic Hotplate Stirrer

Features

- LED display for precise monitoring of temperature
- A wide speed range of 0 to 1500rpm
- Max. Heating plate temperature 550°C
- External temperature control is possible by connecting the temperature sensor(PT1000) with accuracy at $\pm 0.2^{\circ}\text{C}$
- The "HOT" warning will flash if the work plate temperature is above 50°C





Overheating protection



External sensor



Wide range of accessories



Chemical resistance



Magnetic Hotplate Stirrers

Specifications

	MS7-H550-Pro	MS7-H550-S
Work plate Dimension [W x D]	184x184mm (7 inch)	184x184mm (7 inch)
Work plate material	Glass ceramic	Glass ceramic
Motor type	Brushless DC motor	Shaded pole motor
Stirring positions	1	1
Max. stirring quantity, [H ₂ O]	20L	10L
Max. magnetic bar[length]	80mm	80mm
Speed range	100-1500rpm resolution ±1rpm	0-1500rpm
Speed display	LCD	Scale
Temperature display	LCD	LED
Heating temperature range	Room Temp.-550°C, increment 1°C	Room temp.-550°C, increment 5°C
Temperature control accuracy	±1°C(<100°C) ±1%(>100°C)	±10°C
Overheating protection	580°C	580°C
Temperature display accuracy	±0.1°C	±1°C
External temperature sensor	PT1000 (accuracy ±0.2)	PT1000 (accuracy ±0.2)
"Hot" warning	50°C	50°C
Data connector	RS232	-
Protection class	IP21	IP21
Motor rating input	18W	15W
Motor rating output	10W	1.5W
Power	1050W	1030W
Heating output	1000W	1000W
Voltage	100-120/200-240V 50/60Hz	100-120/200-240V 50/60Hz
Dimension [WxDxH]	215x360x112mm	215x360x112mm
Weight	5.3kg	4.5kg
Permissible ambient temperature and humidity	5-40°C, 80%RH	5-40°C, 80%RH

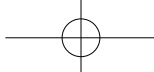

DLAB 340°C magnetic hotplate stirrers include all leading safety standards and features for superior ease of use and are cost-effective. They are widely used in chemical synthesis, physical and chemical analysis, bio-pharmaceuticals, etc.

MS-H-Pro^T LCD Digital Magnetic Hotplate Stirrer with Timer

MS-H-Pro⁺ LCD Digital Magnetic Hotplate Stirrer

Features

- Brushless DC motor is maintenance free and explosion-proof
- Digital temperature control with max. temperature at 340°C
- Digital speed control with max. speed up to 1500rpm
- Max. stirring quantity of H₂O at 20L
- Safety circuits provide overheating protection
- The "HOT" warning will flash if the plate temperature is above 50°C even when the hotplate is turned off
- Wide range timer function from 1min to 99h59min(MS-H-Pro^T only)
- High-resolution LCD display shows actual temperatures and speed (MS-H-Pro^T displays the time also)
- External temperature control is possible by connecting the temperature sensor(PT 1000) with accuracy at ±0.2°C
- Stainless steel work plate with ceramic coating provides good chemical-resistant performance
- Remote function provides PC control and data transmission
- A wide variety of accessories are available



External sensor

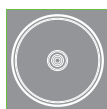

Brushless DC motor



Wide range of accessories



RS232 connector



Chemical resistance

MS-H-S Magnetic Hotplate Stirrer

Features

- Maintenance free brushless DC motor
- Max. temperature to 340°C
- Stirring speed up to 1500 rpm
- Stainless steel work plate with ceramic coating provides good chemical-resistant performance
- Safety circuits provide overheating protection
- A wide variety of accessories are available





Magnetic Hotplate Stirrers

Specifications

	MS-H-PRO ⁺	MS-H-PRO ^T	MS-H-S
Work plate dimension	φ135mm(5 inch)	φ135mm(5 inch)	φ135mm(5 inch)
Work plate material	stainless steel cover with ceramic	stainless steel cover with ceramic	stainless steel cover with ceramic
Motor type	Brushless DC motor	Brushless DC motor	Brushless DC motor
Stirring positions	1	1	1
Max. stirring quantity[H ₂ O]	20L	20L	20L
Max. magnetic bar[length]	80mm	80mm	80mm
Speed range	100-1500rpm resolution±1rpm	100-1500rpm resolution±1rpm	0-1500rpm resolution±1rpm
Speed display	LCD	LCD	Scale
Temperature display	LCD	LCD	Scale
Heating temperature range	Room temp.-340°C, increment 1°C	Room temp.-340°C, increment 1°C	Room temp.-340°C
Temperature control accuracy	±1°C(<100°C) ±1%(>100°C)	±1°C(<100°C) ±1%(>100°C)	-
Over temperature protection	420°C	420°C	420°C
Temperature display accuracy	±0.1°C	±0.1°C	±0.5°C
External temperature sensor	PT1000 (accuracy ±0.2)	PT1000 (accuracy ±0.2)	-
"Hot" warning	50°C	50°C	-
Timer function	-	1min to 99h 59min	-
Data connector	RS232	RS232	-
Protection class	IP42	IP42	IP42
Motor rating input	18W	18W	18W
Motor rating output	10W	10W	10W
Power	550W	550W	530W
Heating output	500W	500W	500W
Voltage	100-120/200-240V 50/60Hz	100-120/200-240V 50/60Hz	100-120/200-240V 50/60Hz
Dimension[WxDxH]	160x280x85mm	160x280x85mm	160x280x85mm
Weight	2.8kg	2.8kg	2.8kg
Permissible ambient temperature and humidity	5-40°C, 80%RH	5-40°C, 80%RH	5-40°C, 80%RH

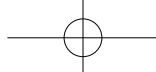

DLAB new heating magnetic stirrer with aluminum cover with ceramic coating work plate, is capable of rapid heating and stable heating as well as precise temperature control. Almost all leading safety standards and features are included for superior and are cost-effective. They are widely used in chemical synthesis, physical and chemical analysis, bio-pharmaceuticals, etc.

MS-H-Pro^A LCD Digital Magnetic Hotplate Stirrer

Features

- Digital control with max. temperature at 340°C, max. speed up to 1500rpm
- Aluminum cover with ceramic coating work plate provides fast heating performance, and strong compatibility with various heating containers and heating blocks
- High-resolution LCD display shows actual temperatures and speed
- PID controller ensures a precise and steady heating process
- External temperature control is possible by connecting the temperature sensor(PT 1000) with accuracy at $\pm 0.2^{\circ}\text{C}$
- Brushless DC motor enables more powerful speed control.
- Three heating modes for selected (fast heating, standard heating and stable heating)
- Remote control function through RS232 interface provides PC control and data transmission



Security

- International safety certification: obtained the CE, CTÜVus, FCC and other product safety certifications issued by TUV Rheinland
- Safety circuits provide overheating protection
- The “HOT” warning will flash if the plate temperature is above 50°C even when the hotplate is turned off
- Brushless DC motor is maintenance free and explosion-proof
- Fully enclosed aluminum alloy housing with good heat dissipation performance and reliable protection capability



Specifications

	MS-H-Pro ^A
Work plate dimension	φ135mm(5inch)
Work plate material	Aluminum cover with ceramic coating
Motor type	Brushless DC motor
Heating temperature range	Room temp.-340°C, increment 1°C
Temperature display accuracy	$\pm 0.1^{\circ}\text{C}$
Speed range	100-1500rpm resolution ± 1 rpm
Max. stirring quantity[H ₂ O]	20L
Speed display	LCD
Temperature display	LCD
Max. magnetic bar[length]	80mm
Temperature control accuracy	$\pm 1^{\circ}\text{C}$ ($<100^{\circ}\text{C}$) $\pm 1\%$ ($>100^{\circ}\text{C}$)
External temperature sensor	PT1000 (accuracy $\pm 0.2^{\circ}\text{C}$)
Over temperature protection	420°C
"Hot" warning	50°C
Data connector	RS232
Protection class	IP21
Voltage	100~120/200-240V 50/60Hz
Heating power	600w
Power	650w
Motor rating input	18w
Motor rating output	10w
Dimension[WxDxH]	280×160×100mm
Weight	2.8kg
Permissible ambient temperature and humidity	5-40°C; 80%RH

DLAB MS-H280-Pro is a perfect device for handling small volume task on daily application, as a low temperature magnetic stirrer with max. temperature at 280°C.

MS-H280-Pro LED Digital Magnetic Hotplate Stirrer

Features

- Digital temperature control with max. temperature up to 280°C
- Digital speed control with max. speed up to 1500rpm
- Stainless steel work plate with ceramic coating provides good chemical resistant performance
- External temperature control is possible by connecting the temperature sensor(PT1000) with an accuracy at $\pm 0.5^{\circ}\text{C}$
- LED display shows temperature and speed
- The "HOT" warning will flash when the work plate temperature is above 50°C even if the hotplate is turned off



External sensor



Wide range of accessories



Chemical resistance



LED display



Specifications

	MS-H280-Pro
Work plate Dimension	$\phi 135\text{mm}(5\text{ inch})$
Work plate material	stainless steel cover with ceramic
Motor type	Brushless DC motor
Stirring positions	1
Max. stirring quantity	3L
Max. magnetic bar[length]	50mm
Speed range	200-1500rpm
Speed display	LED
Temperature display	LED
Speed display resolution	$\pm 1\text{rpm}$
Heating temperature range	Room temp.-280, increment 1°C
Control accuracy of work plate	$\pm 1^{\circ}\text{C}(<100^{\circ}\text{C}) \pm 1\%(>100^{\circ}\text{C})$
Overheating protection	320°C
Temperature display accuracy	$\pm 1^{\circ}\text{C}$
External temperature sensor	PT1000 (accuracy $\pm 0.5^{\circ}\text{C}$)
"Hot" warning	50°C
Protection class	IP21
Motor rating input	5W
Motor rating output	3W
Power	515W
Heating output	500W
Voltage	100-120/200-240V 50/60Hz
Dimension[WxDxH]	150x260x100mm
Weight	1.8kg
Permissible ambient temperature and humidity	$5-40^{\circ}\text{C}$, 80%RH

Magnetic Hotplate Stirrers

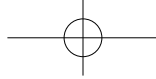

MS-H380-Pro

LCD Digital Magnetic Hotplate Stirrer

DLAB 380°C magnetic hotplate stirrers include all leading safety standards and is chemically-resistant with white ceramic work plate. They can be used in physical, chemical, analytical and biological laboratories.

Features

- Max. heating temperature is 380°C
- High resolution LCD displays actual temperature and speed.
- Brushless DC motor is maintenance free
- Aluminum cover with ceramic work plate, allows for immediate heat transfer
- External temperature control is possible with temperature sensor PT1000
- Digital temperature control with max. temperature at 380°C
- Digital speed control with max. speed up to 1500rpm
- Max. stirring quantity of H₂O at 5L



Specifications

MS-H380 Pro

Work plate Dimension	140x140mm
Work plate material	Aluminum cover with ceramic coating
Motor type	Brushless DC motor
Stirring positions	1
Max. stirring quantity[H ₂ O]	5L
Max. magnetic bar[length]	50mm
Speed range	200-1500rpm
Speed display	LCD
Temperature display	LCD
Heating temperature range	Room temp.+5°C - 380°C
Over heat Protection	420°C
Temperature display accuracy	±0.1°C
External temperature sensor	PT1000 (accuracy ±0.5°C)
Control accuracy of sensor	±20rpm
Protection class	IP21
Motor rating input	2.4W
Motor rating output	1.8W
Power	510W
Heating output	500W
Voltage	100-120/200-240V, 50/60Hz
Dimension [W x D x H]	320x180x108mm
Weight	2.2kg
Permissible ambient temperature and humidity	5-40°C 80%RH

MS-H340-S4

LCD 4-Channel Digital Magnetic Hotplate Stirrer



Magnetic Hotplate Stirrers

It is widely used in chemical synthesis, physical and chemical analysis, bio-pharmaceuticals etc.

Features

- Independent heating and stirring control
- LCD display shows actual temperatures and speed
- PID controller ensures a precise and steady heating process, Max. temperature up to 340°C
- Brushless DC motor enables more powerful speed control
- External temperature sensor(PT1000) with accuracy at 0.2°C
- Overheating protection temperature at 420°C
- Stainless steel work plate with ceramic coating provides good chemical-resistant performance
- A wide variety of accessories are available

Specifications

	MS-H340-S4
Work plate dimension	Φ135mm (5inch)
Plate material	Stainless steel with ceramic coating
Motor type	Brushless DC motor
Stirring positions	4
Max. stirring quantity of single position (H ₂ O)	10L
Max. magnetic bar	40mm
Speed range	200-1500rpm
Speed display	LCD
Temperature display	LCD
Control accuracy of sensor	±20rpm
Temperature range	25-340°C
Over temperature protection	420°C
Temperature display accuracy	±0.1°C
External temp. sensor	PT1000 (Accuracy±0.2°C)
IP Protection class	IP21
Motor rating input	1.8W×4
Power	515W×4
Heating Power	500W×4
Voltage	100-120V,60Hz; 200-240V,50 Hz
Dimensions[WxDxH]	698×270×128mm
Weight	9.5kg
Permissible ambient temperature	5~40°C
Permissible relative humidity	80%RH

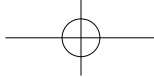

MS-H-S10

10-Position Magnetic Hotplate Stirrer

Features

- Maintenance-free brushless DC motor
- Max speed 1100rpm
- Max.temperature 120°C
- Stainless steel work plate, covered with silicone cushion, provides the excellent performance of heating uniformity and skid resistance



Skid resistance



Multiple position



Brushless DC motor

Specifications

	MS-H-S10
Work plate dimension[W x D]	180x450mm
Work plate material	Stainless steel with silicone
Motor type	Brushless DC motor
Stirring positions	10
Max. stirring quantity	0.4Lx10
Max. magnetic bar[length]	40mm
Speed range	0-1100rpm
Speed display	scale
Temperature display	scale
Heating temperature range	Room temp.-120°C
Overheating protection	140°C
Protection class	IP42
Motor rating input	12W
Motor rating output	4W
Power	490W
Heating output	470W
Voltage	100-120/200-240V 50/60Hz
Dimension[WxDxH]	182x622x65mm
Weight	3.2kg
Permissible ambient temperature and humidity	5-40°C, 80%RH

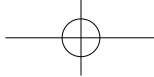

Alloy-Bead Heating Bath

Features

- High strength aluminum alloy bead with high thermal conductivity over wide temperature range
- Flexible, convenient, easy to operate and adaptable to reaction vessels with different shapes and sizes
- Accommodate the external temperature probe on the hotplate magnetic stirrer to achieve precise temperature control
- The alloy bead does not adhere to the container inside surface, while the silicone oil is difficult to clean in the oil bath application
- Eco-friendly, pollution free, poison free, fume free, highly safe and splash free heating
- PTFE shell can effectively retain the heat and ensure human safety from burning injuries
- The beads are easy to handle with. The contaminated portion can be cleaned and replaced separately



250ml water heated up to 80°C
(MS-H-ProA)

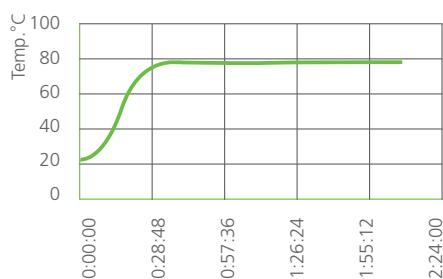

250ml silicone oil heated up to 120°C
(MS-H-ProA)

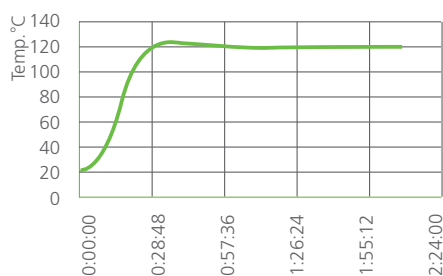

Tips for temperature control

- We recommend to use the beads with DLAB 340, 550 and 280 series hotplate magnetic stirrers
- Place the external temperature sensor in the hole on the heating bath and ensure that the probe is submerged within 1/2~1/3 of the depth of the bead bath for accurate sample temperature control.
- Keep the heating temperature below 260°C

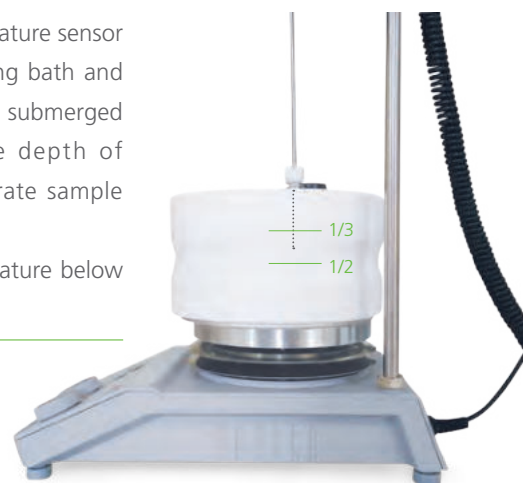



Cat. No.	Description	MS7-H550-Pro	MS7-H550-S	MS-H-Pro ⁺	MS-H-Pro ^T	MS-H-S	MS-H280-Pro
① 18900001	Blue carrying plate, use with color quarter pies			■	■	■	■
② 18900065	Blue Fixed ring, use with color quarter pies			■	■	■	■
③ 18900002	Red quarter pie, 11 holes, 4 mL reaction vessel, Ø15.2mm, 20mm depth	■	■	■	■	■	■
④ 18900003	Purple quarter pie, 4 holes, 20 mL reaction vessel, Ø28mm, 24mm depth	■	■	■	■	■	■
⑤ 18900004	Blue quarter pie, 4 holes, 30mL reaction vessel, Ø28mm, 30mm depth	■	■	■	■	■	■
⑥ 18900005	Black quarter pie, 4 holes, 40mL reaction vessel, Ø28mm, 43mm depth	■	■	■	■	■	■
⑦ 18900048	Green quarter pie, 6 holes, 8mL reaction vessel, Ø17.8mm, 26mm depth	■	■	■	■	■	■
⑧ 18900049	Golden quarter pie, 4 holes, 16mL reaction vessel, Ø21.6mm, 31.7mm depth	■	■	■	■	■	■
⑨ 18101006	Reaction block for 50mL round bottom flask (one flask capacity)			■	■	■	■
⑩ 18101007	Reaction block for 100mL round bottom flask (one flask capacity)			■	■	■	■
⑪ 18101008	Reaction block for 250mL round bottom flask (one flask capacity)			■	■	■	■
⑫ 18101009	Reaction block for 500mL round bottom flask (one flask capacity)			■	■	■	■
⑬ 18900019	F101 protective cover, temperature resistance of 135°C			■	■	■	■
⑭ 18900016	PT1000-A, length of 230mm	■	■	■	■		■
⑮ 18900136	PT1000-B, temperature sensor with glass coated, length of 230mm	■	■	■	■		■
⑯ 18900017	Support clamp of PT1000	■	■	■	■		
⑰ 18900148	Support clamp of PT1000						■

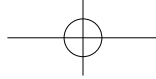

Stirrer bars

Stirrer bars and stirrer bar remover (PTFE), use below 150°C

Models

MS7-H550-Pro MS7-H550-S MS-H-Pro+ MS-H-Pro [†] MS-H-S MS-S	MS-H280-Pro MS-PA MS-PB	MS-H-S10 MS-M-S10 FlatSpin EcoStir
--	-------------------------------	---



Cat. No.	Size of stirrer bars (LxØ)[mm]	Suitable for max. stirrer bar 80mm	Suitable for max. stirrer bar 50mm	Suitable for max. stirrer bar 40mm
18900006	10mmx6mm	■	■	■
18900007	15mmx8mm	■	■	■
18900008	20mmx8mm	■	■	■
18900009	25mmx8mm	■	■	■
12500005	30mmx6mm	■	■	■
18900011	40mmx8mm	■	■	■
12500004	50mmx8mm	■	■	
18900013	65mmx8mm	■		
18900014	80mmx13mm	■		
18900015	Stirrer bar remover, length of 200mm	■	■	■

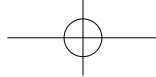

HP550-S LED Hotplate



Features

- LED screen shows temperature
- Max. temperature up to 550°C
- Separate safety circuits with fixed safety temperature of 580°C
- External temperature control is possible by connecting the temperature sensor(PT 1000) with an accuracy at $\pm 0.5^\circ\text{C}$
- Glass ceramic work plate provides excellent chemical-resistant performance and most efficient heat transfer
- The "HOT" warning will flash if the work plate temperature is above 50°C even when the hotplate is turned off

Specifications

	HP380-Pro
Work plate Dimension	140x140mm
Work plate material	Aluminum cover with ceramic coating
Motor type	-
Stirring positions	-
Max. stirring quantity[H ₂ O]	-
Max. magnetic bar[length]	-
Speed range	-
Speed display	-
Temperature display	LCD
Heating temperature range	Room temp.+5°C - 380°C
Over heat Protection	420°C
Temperature display accuracy	$\pm 0.1^\circ\text{C}$
External temperature sensor	PT1000 (accuracy $\pm 0.5^\circ\text{C}$)
Control accuracy of sensor	-
Protection class	IP21
Motor rating input	-
Motor rating output	-
Power	510W
Heating output	500W
Voltage	100-120/200-240V, 50/60Hz
Dimension [W x D x H]	320x180x108mm
Weight	2.2kg
Permissible ambient temperature and humidity	5-40°C 80%RH

Specifications

	HP550-S
Work plate dimension[WxD]	184x184mm(7 inch)
Work plate material	Glass ceramic
Heating position	1
Heating temperature range	Room temp.-550°C, increment 5°C
Control accuracy of work plate	$\pm 10^\circ\text{C}$
Safety temperature	580°C
Temperature display	LED
Temperature display accuracy	$\pm 1^\circ\text{C}$
External temperature sensor	PT1000($\pm 0.5^\circ\text{C}$)
Heating warning	50°C
Protection class	IP21
Power	1010W
Voltage Frequency	100-120/200-240V, 50/60Hz
Heating Power	1000W
Dimension[WxDxH]	215x360x112mm
Weight	4.5kg
Permissible ambient temperature and humidity	5-40°C, 80%RH



HP380-Pro LCD Digital Hotplate

DLAB 380°C magnetic hotplate stirrers include all leading safety standards and is chemically-resistant with white ceramic work plate. They can be used in physical, chemical, analytical and biological laboratories.

Features

- Max. heating temperature is 380°C
- High resolution LCD displays actual temperature
- Aluminum cover with ceramic work plate, allows for immediate heat transfer
- External temperature control is possible with temperature sensor PT1000
- Digital temperature control with max. temperature at 380°C
- Max. stirring quantity of H₂O at 5L

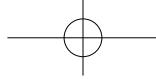

MS7-S 7" Square Magnetic Stirrer

Features

- Speed range of 0-1500rpm
- Max. stirring quantity of H₂O at 10L
- Ceramic work plate provides excellent chemical resistant performance



MS-S Magnetic Stirrer

Features

- Maintenance free brushless DC motor
- Speed range of 0-1500 rpm
- Max. stirring quantity of H₂O at 20L
- Stainless steel work plate cover with ceramic material provides good chemical resistance performance

F100 protective cover

for non-hotplate model,
use with MS-S



MS6-Pro LCD Digital Magnetic Stirrer

Features

- High resolution LCD displays actual speed
- Brushless DC motor is maintenance free
- Aluminum cover with ceramic work plate
- Digital speed control with max. speed up to 1500rpm
- Max. stirring quantity of H₂O at 5L



Specifications	MS7-S	MS-S	MS6-Pro
Work plate dimension[WXD]	184x184mm(7 inch)	φ135mm(5 inch)	140x140mm
Work plate material	Glass ceramic	Stainless steel cover with ceramic	Aluminum cover with ceramic coating
Motor type	Shaded pole motor	Brushless DC motor	Brushless DC motor
Stirring positions	1	1	1
Max. stirring quantity[H ₂ O]	10L	20L	5L
Max. magnetic bar[length]	80mm	80mm	40mm
Speed range	0-1500rpm	0-1500rpm	200-1500rpm
Speed display	Scale	Scale	LCD
Protection class	IP21	IP42	IP21
Motor input power	15W	18W	2.4W
Motor output power	1.5W	10W	1.8W
Power	30W	30W	10W
Voltage	100-120/200-240V,50/60Hz	100-240V,50/60Hz	100-240V, 50-60Hz
Dimension[WxDxH]	215x360x112mm	160x280x85mm	320x180x108mm
Weight	3.8kg	2.8kg	2.2kg
Permissible ambient temperature and humidity	5-40°C, 80%RH	5-40°C, 80%RH	5-40°C 80%RH

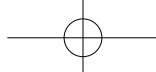

MS-PA LED Digital Magnetic Stirrer

Features

- Digital speed control within the range of 0-1500rpm
- Max. stirring quantity of H₂O at 3L
- LED display shows speed
- Nylon+GF housing provides a good performance of chemical resistance



MS-PB Magnetic Stirrer

Features

- A wide range of 0-1500rpm
- Max. stirring quantity of H₂O at 3L
- Nylon+GF housing provides a good performance of chemical resistance



Chemical resistance



Strong magnetism



LED display



Specifications

	MS-PA	MS-PB
Work plate dimension	φ135mm(5 inch)	φ135mm(5 inch)
Work plate material	Nylon+GF	Nylon+GF
Motor type	Brushless DC motor	Brushless DC motor
Stirring positions	1	1
Max. stirring quantity[H ₂ O]	3L	3L
Max. magnetic bar[length]	50mm	50mm
Speed range	0-1500rpm	0-1500rpm
Speed display	LED	Scale
Protection class	IP42	IP42
Motor input power	5W	5W
Motor output power	3W	3W
Power	15W	10W
Voltage	100-120/200-240V,50/60Hz	100-120/200-240V,50/60Hz
Dimension[WxDxH]	150×260×80mm	150×260×80 mm
Weight	1.8kg	1.8kg
Permissible ambient temperature and humidity	10-40°C, 80%RH	10-40°C, 80%RH

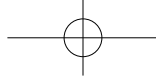

MS-M-S10 10-Position Magnetic Stirrer

Features

- Maintenance-free brushless DC motor
- Speed range of 0-1100rpm
- Stainless steel work plate covered with silicone cushion, provides excellent performance of skid resistance



Skid resistance



Multiple position



Specifications

Work plate Dimension[WxD]	
Work plate material	
Motor type	
Stirring positions	
Max. stirring quantity[H ₂ O]	
Max. magnetic bar[length]	
Speed range	
Speed display	
Protection class	
Motor input power	
Motor output power	
Power	
Voltage	
Dimension[WxDxH]	
Weight	
Permissible ambient temperature and humidity	

MS-M-S10	
Work plate Dimension[WxD]	180x450mm
Work plate material	Stainless steel with silicone coating
Motor type	Brushless DC motor
Stirring positions	10
Max. stirring quantity[H ₂ O]	0.4LX10
Max. magnetic bar[length]	40mm
Speed range	0-1100rpm
Speed display	Scale
Protection class	IP21
Motor input power	12W
Motor output power	4W
Power	20W
Voltage	100-120/200-240V,50/60Hz
Dimension[WxDxH]	622x205x65mm
Weight	3.2kg
Permissible ambient temperature and humidity	5-40°C, 80%RH



FlatSpin

Ultra-flat Compact Magnetic Stirrer

With excellent stirring functionality, the compact shape of FlatSpin takes less bench space and makes storage easier.

Features

- A wide range of speed from 15 to 1500rpm
- Automatic reverse rotation for excellent mixing
- Protection class (IP65)
- PET top provides excellent chemical resistance
- Ultra silence and vibration-free

EcoStir is a magnetic stirrer customized for liquid mixing, suitable for chemical analysis, biology reagent mixing, regular laboratory experiments and liquid handling.

EcoStir

Economical Magnetic Stirrer

Features

- Maintenance free brushless DC motor
- Rare earth magnets give powerful stirring
- Stepless speed regulation 300-2000rpm
- Ultra silence and vibration-free design.
- PET top provides excellent chemical resistance
- Shaft can be fitted with a PH sensor or sensors for other purposes



Specifications

	FlatSpin	EcoStir
Work plate Dimension	φ90mm	φ120mm
Work plate material	PET	PET
Motor type	Motorless	Brushless DC motor
Stirring positions	1	1
Max. stirring quantity[H ₂ O]	0.8L	1.5L
Max. magnetic bar[length]	40mm	40mm
Speed range	15-1500rpm	300-2000rpm
Speed setting	button	scale
Protection class	IP65	IP21
Motor output power	3W	1.2W
Power	5W	7.2W
Voltage	100-120/200-240V,50/60Hz	100-120/200-240V,50/60Hz
Dimension [W x D x H]	175x120x15mm	150x145x50mm
Weight	0.3kg	0.3kg
Permissible ambient temperature and humidity	5-40°C,80%RH	5-40°C,80%RH

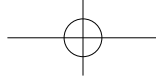

EcoStir

Square Plate Magnetic Stirrer

DLAB Square Plate Magnetic Stirrer with electrode holder has a reliable design and a powerful stirring ability. It is a basic and ideal tool for electrochemistry measurements or water & environment monitoring; drug or food analysis; liquid culture mixing, etc.

Features

- Compact design with small footprint, 12V voltage available for mobile labs.
- Square work plate supports 1.5L stirring capacity.
- Holder with clamp for pH electrode or other sensor.
- Default PET top provides excellent chemical resistance.
- Extra colorful stickers satisfy DIY design by yourself.
- Maintenance free brushless DC moto.
- An economical choice of a reliable & durable magnetic stirrer with an electrode holder for stable & powerful stirring ability.



Powerful stirring capacity



Specifications

	EcoStir
Work plate size	120x115mm
Work plate material	PET
Motor type	Brushless DC Motor
Stirring position	1
Max. stirring quantity (H ₂ O)	1.5L
Max. magnetic bar (length)	40mm
Speed range	300-2000rpm
Speed setting	Scale
Protection class	IP21
Motor output power	1.2W
Power	7.2W
Voltage	DC 12V, 100-240V,50/60Hz
Dimension [WxDxH]	150x144x54mm
Weight	0.3Kg
Permissible ambient temp.&humidity	5-40°C80%RH

Applications outside lab:

- Home brewing
- Wine aeration
- Yeast and bacteria ferment



Magnetic Stirrers

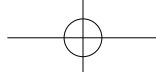

OS20-Pro OS40-Pro OS70-Pro LCD Digital Overhead Stirrer

DLAB Overhead Stirrers are competent for most demanding tasks with guaranteed safety and performance. They are widely used in chemical synthesis, pharmaceutical synthesis, physical and chemical analysis, petrochemical industries, etc.



Speed 50~1100rpm with control accuracy of ± 10 rpm



Brushless DC motor for long life, maintenance free



Constant speed despite viscosity change of the sample



Spillage and overload protection safety circuits



Remote PC control and data transmission



LCD display of set and actual speed, torque and time (for OS70)



Self - locking drill chuck, tools free



Stirring paddle "top-cross" design, easy to replace the container



Start/run smoothly, prevent sample splatter or overflow



Silicone cover protecting drill chuck from erosive vapor



Specifications

	OS20-Pro	OS40-Pro	OS70-Pro
Max. stirring quantity[H ₂ O]	20L	40L	70L
Speed range	50~2200rpm	50~2200rpm	50~1100rpm
Speed display accuracy	± 3 rpm	± 3 rpm	± 10 rpm
Time settings range	-	-	0-99h59min
Max. torque	40N•cm	60N•cm	300N•cm
Viscosity max.	10000mPa•s	50000mPa•s	100000mPa•s
Weight	2.8kg	2.8kg	3.2kg
Motor type		Brushless DC motor	
Voltage		100~240V, 50/60 Hz	
Speed display		LCD	
Torque display		LCD	
Overload protection display		LCD	
Chuck range diameter		0.5~10mm	
Motor input/output power	60W/50W	120W/100W	180W/160W
Power	70W	130W	200W
Dimension[WxHxD]		83 x 220 x 186mm	
Protection class		IP21	
Permissible ambient temperature and humidity		5~40°C, 80%RH	
Data interface		RS232	

OS20-S OS40-S LED Overhead Stirrer

Features

- High reliability and outstanding performance
- A wide range of speed from 50 to 2200rpm
- Brushless DC motor for long life, maintenance free and explosion proof
- LED screen for monitoring actual speed
- Safety circuits allow for safe stop function in anti-stall or overload conditions



Explosion-proof



Wide range of accessories

Stirring paddle "top-cross" design, easy to replace the container

Spillage and overload protection safety circuit

LED display of set and actual speed

Brushless DC Motor

- Maintenance free
- Explosion-proof
- Precision speed control

Self-locking drill chuck, tools free



Specifications

	OS20-S	OS40-S
Max. stirring quantity[H ₂ O]	20L	40L
Speed range	50~2200rpm	50~2200rpm
Max. torque	40N•cm	60N•cm
Viscosity max.	10000mPa•s	50000mPa•s
Weight	2.8kg	2.8kg
Motor type	Brushless DC motor	
Speed display	LED	
Overload protection display	LED	
Chuck range diameter	0.5~10mm	
Motor input power	60W	120W
Motor output power	50W	100W
Power	70W	130W
Voltage	100~240V, 50/60 Hz	
Dimension[WxHxD]	83 x 220 x 186mm	
Protection class	IP21	
Permissible ambient temperature and humidity	5~40°C, 80%RH	

Overhead Stirrers

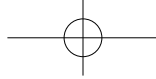

Plate Stands

Universal Plate Stand (for OS20/40/70)

Dimension [W x D x H] :
200x310x780mm
Material: stainless steel
Cat. No.
18900258



Grand Plate Stand (for OS70)

Dimension [W x D x H] :
335 x 463 x 780mm
Material: stainless steel
Cat. No.
18900497



Stirrer

Stainless Steel Series

Propeller stirrer

Shaft length 40cm
Stirrer diameter 50mm
Material: 304L stainless steel
Standard stirring applications
at medium and high speed

Cat No. 18900071



Paddle stirrer

Shaft length 40cm
Stirrer diameter 68mm
Material: 304L stainless steel
For gentle mixing at low and
medium speeds

Cat No. 18900073



Straight stirrer

Shaft length 40cm
Stirrer diameter 60mm
Material: 304L stainless steel
For low viscosity media at
medium and high speeds

Cat No. 18900072



Centrifugal stirrer

Shaft length 40cm
Stirrer diameter 90mm
Material: 304L stainless steel
Blades open while speeding.
For narrow neck vessels at
medium to high speed.

Cat No. 18900074



PTFE Coating Series

Propeller stirrer

Shaft length 40cm
Stirrer diameter 50mm
Material: PTFE coated
Standard stirring applications
at medium and high speed

Cat No. 18900075



Paddle stirrer

Shaft length 40cm
Stirrer diameter 68mm
Material: PTFE coated
For gentle mixing at low and
medium speeds

Cat No. 18900077



Straight stirrer

Shaft length 40cm
Stirrer diameter 60mm
Material: PTFE coated
For low viscosity media at
medium and high speeds

Cat No. 18900076



Centrifugal stirrer

Shaft length 40cm
Stirrer diameter 90mm
Material: PTFE coated
Blades open while speeding.
For narrow neck vessels at
medium to high speed.

Cat No. 18900078



Grand Series (for OS70)

Grand propeller stirrer

Shaft length 60cm
Stirrer diameter 100mm
Material: 316L stainless steel
Standard stirring

Cat No. 18900478



Grand paddle stirrer

Shaft length 60cm
Stirrer diameter 100mm
Material: 316L stainless steel
Gentle mixing for those stratify
easily or sensitive to shear

Cat No. 18900499



Grand anchor stirrer

Shaft length 60cm
Stirrer diameter 100mm
Material: 316L stainless steel
Standard stirring or for those
easily precipitate

Cat No. 18900498



Grand dissolving stirrer

Shaft length 60cm
Stirrer diameter 100mm
Material: 316L stainless steel
Breaking down granules in the
mixture with strong shear

Cat No. 18900500



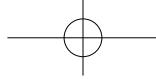

D-160 Handheld Homogenizer

Features

- Ideal for manual operation due to its light weight and ergonomic design
- Processing range: 0.1-50mL or 1-250mL
- 316L stainless steel shafts are fully autoclavable and inert for highly corrosive solutions
- All shafts are interchangeable for easy dismantling and cleaning.
- Speed from 8,000 to 32,000 rpm

D-500 Homogenizer

Features

- Viscosity up to 10,000 mPas
- 6 modes of motor speed from 10,000 to 30,000 rpm
- All-round safety guarantee for motor drive, overload protection and smooth operation
- 316L stainless steel shafts are fully autoclavable and inert for highly corrosive solutions
- Easy dismantling for fast preparation
- All shafts are interchangeable for easy dismantling and cleaning

D160

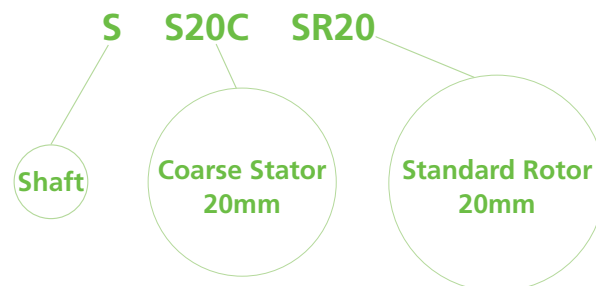

Specifications

	D-160	D-500
Power Supply	110-120V/60Hz 220-240V / 50-60 Hz	110-120V/60Hz 220-240V/50-60 Hz
Motor Type	Universal motor 160 W AC carbon brush motor	500 W AC carbon brush motor
Speed Range	8000-32000rpm	10000-30000rpm
Max. Circum. Speed	6.3-14m/sec	22.7-36m/sec
Speed Control	Dial knob 10 stage	6 stage
Working Volume [H ₂ O]	0.1-50mL (Dispersing shaft DS-160/5) 1-250mL (Dispersing shaft DS-160/10)	10-40000mL (Optional)
Max. Viscosity	5,000mPas	10,000 mPas
Material of Dispersing Shaft	SS 316L stainless steel, PTFE	SS 316L stainless steel, PTFE
Weight	0.54 kg	1.3 kg
Dimension [L x W x H]	45mm x 55mm x 190mm	70mm x 70mm x 255mm
Noise	72 dB(A)	79 dB(A)
Operating Environment	0-40°C, 85% rel. humidity	0-40°C, 85% rel. humidity
Protection Class	IP20	IP20

D500



Homogenizers

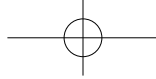

D-500 Homogenizer

DS-500/1

SS20CSR20

Volume 10-5000mL

Max. Circum. Speed 22.7m/sec

Material: 316L

Application: for solid/liquid media

Cat. No.

18201331



DS-500/2

SS20FER20

Volume 10-5000mL

Max. Circum. Speed 22.7m/sec

Material: 316L

Application: for water and oil mixing

Cat. No.

18201332



DS-500/5

SS5CSR5

Volume 10-5000mL

Max. Circum. Speed 5,8m/sec

Material: 316L

Application: Ideal for all homogenizing applications such as tissue homogenization, cell disruption, suspensions and clinical and medical diagnostics

Cat. No.

18900117



D-160 Handheld Homogenizer

DS-160/5

Volume 0.1-50ml

Max. Circum. Speed 6.3m/sec

Material: 316L

Application: small amounts of solid-liquid mixed

DS-160/10

Volume 1-250mL

Max. Circum. Speed 14m/sec

Material: 316L

Application: small amounts of solid-liquid mixed

Cat. No.

18900543



Cat. No.

18900544



Stator



S20C



S20F



S30C



S30F



S40C

Rotor



SR20



SR30



CR20



CR30



MR20



MR30



ER20



ER30



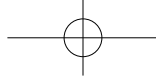

Combination

Cat. No.	Compatibility	Description of Shaft	Function	Applications	Treatable Volume (refer to water)
18900543	D-160		dispersing tool for solid/liquid media		0.1-50ml
18900544	D-160		dispersing tool for solid/liquid media		1-250ml
18900117	D-500	SS5CSR5	dispersing tool for solid/liquid media	Dispersing of tissue decomposition, clinical & medical diagnostics and suspensions	1-50ml
18900115	D-500	SS20CSR20	dispersing tools for solid/liquid media	Coarse crushing of hard solids in liquid	10-5000ml
18900116	D-500	SS20FER20	Dispersing tools for W/O or O/W emulsions	Emulsions, intensive mixing of w/o and o/w emulsions Dispersing of resins and pigments for paint and lacquer industry	10-5000ml
18900118/ 18900125	D-500	S20C CR20	dispersing tool with knives for fibrous/stringy materials	Fragmentation of vegetable, animal and human tissues	10-5000ml
18900118/ 18900127	D-500	S20C MR20	dispersing tool for solid/liquid media	Suspensions, intensive mixing	10-5000ml
18900119/ 18900125	D-500	S20F CR20	dispersing tool with knives for fibrous/stringy materials	Fragmentation of vegetable, animal and human tissues	10-5000ml
18900119/ 18900127	D-500	S20F MR20	dispersing tools for solid/liquid media	Emulsions, intensive mixing of w/o and o/w emulsions	10-5000ml
18900120/ 18900124	D-500	S30C SR30	dispersing tools for solid/liquid media	Coarse crushing of hard solids in liquid	100-8000ml
18900120/ 18900126	D-500	S30C CR30	dispersing tool with knives for fibrous/stringy materials	Fragmentation of vegetable, animal and human tissues	100-8000ml
18900120/ 18900128	D-500	S30C MR30	dispersing tools for solid/liquid media	Suspensions, intensive mixing	100-8000ml
18900121/ 18900124	D-500	S30F SR30	dispersing tools for solid/liquid media	Dispersing of resins and pigments for paint and lacquer industry	100-8000ml
18900121/ 18900130	D-500	S30F ER30	Dispersing tools for W/O or O/W emulsions	Emulsions, intensive mixing of w/o and o/w emulsions Dispersing of resins and pigments for paint and lacquer industry	100-8000ml
18900121/ 18900128	D-500	S30F MR30	dispersing tools for solid/liquid media	Emulsions, intensive mixing of w/o and o/w emulsions	100-8000ml
18900120/ 18900127	D-500	S30C MR20	Stirring Shaft	High speed mixing without crushing	250-20000ml
18900122/ 18900128	D-500	S40C MR30	Stirring Shaft	High speed mixing without crushing	1000-40000ml

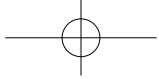

Centrifuges

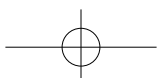

The centrifuge used to separate liquid and solid particles or components in a liquid mixture. The DLAB centrifuge series includes palm micro centrifuges, high-speed centrifuges (refrigerated and non-refrigerated), hematocrit centrifuges and low-speed centrifuges.

List of DLAB models:

Series	Image	Model	Display	Max. speed(RCF)	Rotor Capacity	Page
palm micro centrifuges		D1008	-	7000rpm (2680×g)	8×2ml 32×0.2ml	P.88
High speed Mini Centrifuge		D2012Plus	LCD	15000rpm 15100×g)	12×0.2/0.5 /1.5/2ml	P.91
High speed Micro Centrifuge		D3024	LCD	15000rpm (21380×g)	24×1.5/2ml, 36×0.5ml, 4×PCR eight strips, 12×5ml(cone), 18×5ml(round),	P.92
High-speed Refrigerated Micro Centrifuge		D1524R	LCD	15000rpm (21380×g)		P.94
hematocrit centrifuge		DM1424	LCD	12000 rpm (13680×g)	24×capillary tubes	P.98
		DM1224	LCD	12000 rpm (13680×g)	24×capillary tubes	P.98
DM0506 Series		DM0506	LCD	5000rpm (2600×g)	6×15ml/10ml /7ml/1.5-5ml	P.105
DM0412 Series		DM0412	LCD	4500rpm (2490×g)	8×15ml 12×10ml/7ml 1.5-5ml	P.101
		DM0412P (PRP/PRF/CGF)	LCD	4500rpm (2490×g)	8×15ml 12×10ml/7ml 1.5-5ml	P.104
DM0424 & DM0408 Series		DM0408	LED	4000rpm (2500×g)	8×15ml 12×10ml/7ml 1.5-5ml	P.106
		DM0424	LCD	4000rpm (2500×g)	4×50ml 24×15ml	P.106
DM0636 Series		DM0636	LCD	6000rpm (4020×g)	4×100ml 36×3-7ml	P.108

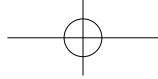

D1008 Series Palm Micro Centrifuge

Features

- Ideal for microfiltration and quick spin-down application
- Easy to operate. Lid close, it begin to rotate
- Max up to 7000rpm
- Compatible with 2mLx8 and PCR8x4 rotors
- Quiet running, noise level $\leq 45\text{dB}$
- Quick-change rotor without any tool
- Accelerates and brakes in seconds
- Available in two colors i.e., green, blue
- Safe, durable and robust rotor with clamp locking design.



Quiet operation



Vibration free



CE  FC

Specifications

	D1008
Max. Speed	7000rpm
Max. RCF	2680xg
Rotor Capacity	0.2/0.5/1.5/2.0mLx8; 0.2mLx32 PCR strips or 0.2mLx4 PCR 8 strips
Run Time	Continuous operation
Driving Motor	DC motor
Power	AC100-240V/50Hz/60Hz 20W
Noise Level	$\leq 45\text{dB}$
Dimension [DxWxH]	160x170x122mm
Weight	0.5kg
Certification	CE cTUVus FCC MCA



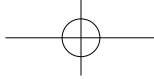

Available rotors



A8-2P

Cat. No. 19400015

Max. speed:7000rpm
Max. RCF:2680×g
Rotor capacity:2mL/1.5mL×8,0.2mL×8,0.5mL×8
Rotor material:High strength plastic
Available rotor adapters:SA02P2, SA05P2



A04-RCR8

Cat. No. 19200810

Max. speed:7000rpm
Max. RCF:2680×g
Rotor capacity: 0.2 ml×32 PCR strips, 0.2 ml×4 PCR 8 strips
Rotor material: High strength plastic

Available adapters



SA02P2

Cat. No. 19400029

0.2mL rotor adapter
Used with A08-2 rotor
8pcs/pk



SA05P2

Cat. No. 19400026

0.5mL rotor adapter
Used with A08-2 rotor
8pcs/pk

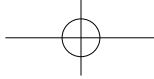

High speed micro centrifuges are widely used in physical and chemical analysis, biochemistry, cellular and molecular biology, clinical Labs ideal for high-end research applications

- Sedimentation of cells and viruses
- Separation of sub-cellular organelles
- Isolation of macromolecules such as DNA, RNA, proteins or lipids

Outstanding Feature

- Maintenance free and powerful driving brushless DC motor easily to reach the set speed
- Provide high accuracy speed control ± 20 rpm
- Timer starts only when the set speed is achieved, to provide an accurate separation time

Conforms to international safety standards and regulations

- DLAB centrifuges are certified with CE, cTÜVus and FCC from TUV. The centrifuge is in conformity with stand EN 61010-1, it has passed MCA test according to IEC/EN61010-2-20
- Quiet and reliable operation
- High strength metal casing ensures security during centrifugal process
- Dual door interlock design for max. operation safety
- Gentle braking at low speed provide efficient separation

Ergonomic design

- User-friendly large LCD display shows real-time information
- Both RPM or G-force can be set and displayed
- The parameters can be modified after the set speed is reached.
- The short spin function by pressing and holding PULSE key. The centrifuge speed can be accelerated and held at the target speed
- The lid will open automatically with prompt sound when the running finish
- Running Process display and error code prompt



D2012 Plus High Speed Mini Centrifuge



Features

- Speed up to 15000rpm (15100×g)
- Brushless DC motor drive quickly to the target speed
- Quiet working, Low noise ≤54dB
- D2012 Plus is proven by IEC/EN 61010-1
- D2012 Plus passed the rigorous explosion-proof test according to IEC/EN 61010-2-20. It is certified with CE, cTUVus, FCC



Brushless DC motor



LCD display



Specifications

D2012 plus

Max. Speed	15000rpm(500-15000rpm), increment: 100rpm
Max. RCF	15100×g, increment: 100×g
Speed Accuracy	±20rpm
Rotor Capacity	0.2mL/0.5mL/1.5mL/2mL×12
Run Time	30sec-99min/Continuous
Acceleration /Braking time	11s ↑ /9s ↓
Driving Motor	Brushless DC motor
Safety Devices	Door interlock, Over-speed detection, Over-temperature detection, Automatic internal diagnosis
Power	Single-phase, AC100V-240V, 50Hz/60Hz, 3A 100W
Noise level	≤54dB
Dimension[D×W×H]	255×245×140mm
Weight	6kg
Certification	EMC, CE, FCC, ICES, cTUVus, CB
Other functions	Speed/RCF switch, Short-time run function, sound-alert function

Available rotors



A12-2P for D2012plus only

Cat. No. 19400010

Max. speed: 15000rpm
Max. RCF: 15100×g
Rotor capacity: 2mL/1.5mL×12,0.2mL×12,0.5mL×12
Rotor material: High strength plastic
Available rotor adapters: A02P2,A05P2

Available adapters



A02P2

Cat. No. 19500001

0.2mL rotor adapter
Used with A12-2, A12-2P, AS24-2 and A24-2P rotors
24 pcs/pk

A05P2

Cat. No. 19500002

0.5mL rotor adapter
Used with A12-2,A12-2P, AS24-2 and A24-2P rotors
24 pcs/pk

High Speed Micro-Centrifuges

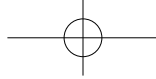

D3024 High Speed Micro Centrifuge

Unique Features

- Patent multi-flow air cooling design to provide air exchange to prevent chamber warming
- Three-layer seal ensure airtightness and biosafety
- High strength aluminum alloy rotor can be fully autoclaved for unlimited service life
- Four rotors are optional complete with 24 places 1.5/2.0mL tubes, bigger 5.0mL, smaller 0.2mL and 0.5mL tubes with adapters

Effective Ventilation System

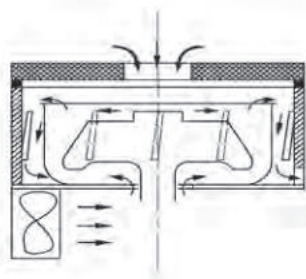

Proprietary design of dual path ventilation enforcing air cooling from both the upper and lower side for the rotor.

Conventional design

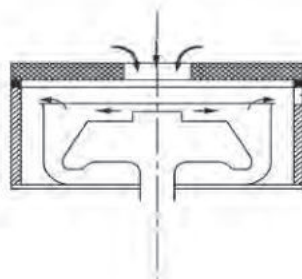

Limiting ventilation on the upper side of the rotor



Brushless DC motor



Wide range of rotors



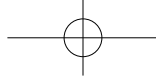

CE FC

High Speed Micro-Centrifuges

Specifications

	D3024
Max. Speed	15000rpm(200-15000rpm), increment:10rpm
Max. RCF	21380xg, increment:10xg
Speed Accuracy	±20 rpm
Rotor Capacity	5mLx18, 5mL culture tubex12 0.2mL/0.5mL/1.5mL/ 2mLx24, 0.5mLx36, PCR8x4
Run Time	30sec-99min/Continuous
Acceleration /Braking time [Sec]	25s ↑ 25s ↓
Motor	Brushless DC motor
Safety Devices	Dual door interlock, Over-speed detection, Automatic internal diagnosis
Power	Single-phase, AC200V-400V, 50Hz/60Hz, 5A, AC100V-120V, 50Hz/60Hz, 8A 200W
Noise Level	≤64dB
Dimension[WxDxH]	280x364x266mm
Weight	12kg
Certification	CE cTUVus FCC MCA
Other functions	Speed/RCF switch; Short-time run function; sound-alert function



D1524R High-speed Refrigerated Micro Centrifuge

Features

- Ergonomic electronic lock design, the centrifuge lid can be closed with single finger touch
- Precooling, the compressor will automatically start cooling as long as the set temperature is lower than the ambient temperature.
- Sound indicator to prompt that the upper cover is closed to maintain the temperature inside the chamber, after centrifugation.
- Advanced R290 fluorine free refrigerant, low carbon and environmental protection.
- Temp range: -20°C- 40°C, fast and powerful cooling capacity, 7 minutes cooling from room temp to 4°C. Temp can kept at max speed.
- Up to 9 program storage capacity according to experimental needs.
- Three-layer sealed rotors ensure airtightness and biosafety.
- High-strength aluminum alloy withstand numerous high temperature and high pressure sterilizations.
- Five rotors with 0.2mL, 0.5mL, 1.5mL, 2mL and 5mL centrifuge tubes/ PCR tubes capacity.
- An external condensation tank prevents water accumulation within the centrifuge chamber.
- Rotor imbalance detection alarm.



Specifications

	D1524R
Max. Speed	15,000rpm (200-15,000rpm) in 100rpm increments.
Max. RCF	21,380×g, step: 10×g
Capacity	1.5/2mL×24, 0.5mL×36, PCR8×4, 5mL×12, 5mL×18.
Temperature setting	-20°C- 40°C
Run Time	30s-99 min; HOLD (continuous running)
Acceleration and deceleration time	25s ↑ 25s ↓
Motor Type	DC brushless motor
Safety Performance	Dual door lock, over-speed detection, over-temperature detection with Internal diagnosis system.
Power Requirements	Single-phase, 200V-240V, 50Hz/60Hz, 500W 100V-120V, 50Hz/60Hz, 500W
Noise	≤56dB
Dimensions(mm)	332(Width) × 553(depth) × 283(height)
Weight	30kg
Other functions	Rotation speed/RCF switchover, inching operation, running process indicator, sound alert. Acceleration/ deceleration in 9 steps, program storage capacity.

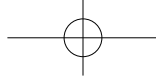

DLAB rotors are manufactured from military-industrial grade aluminum alloy with high mechanical strength for precise running and safety (excludes D2012 plus rotor)

- Every rotor can reach a max. speed of 15000rpm
- Rotors are seated on a tapered shaft, concentric and self-aligning, perfect to achieve running stability at high speeds
- D3024 & D1524R with three-layer sealed rotors/ anti- sample overflow prevents accidental leakage and risk free centrifugal process
- microbial contamination. D3024 & D3024R rotors have passed MCA test according to IEC/EN61010-2-20, including mechanical safety and bio-safety tests
- High strength aluminum alloy rotors are fully autoclavable and provide unlimited service life (D2012 plus rotor not included)
- Powerful cooling system minimizes rotor heating. D3024 rotors heat up to > 10°C and D2012 rotors less than 8°C after running an hour

Seals within the aluminum alloy rotor

Rotor Features

Fully autoclavable

High strength aluminum alloy rotors are fully autoclavable, withstanding steam sterilizing at 121°C for 20 minutes, with unlimited service life.

Three-layer seal

Aspired to be the top-of-the-line model, D3024 & D3024R rotors are designed to prevent sample leakage. Each and every rotor is hermetically sealed by three rubber seals.

Mechanical safety

DLAB centrifuges are constructed under MCA conditions according to IEC/EN61010-2-20, causing disruption by partially cutting and overloading rotor assembly, and guarantee that no part shall be detached to cause danger to person or the environment.

Three rubber seals fitted to achieve bio-safe condition

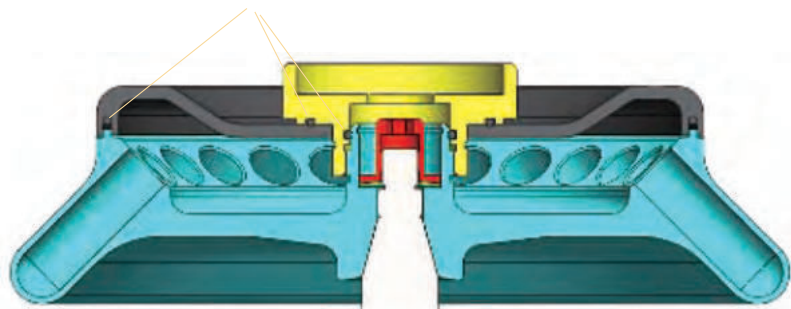



Available rotors

Cat. No. 19400069

AS24-2
for D3024 & D1524R

Max. speed: 15000rpm
 Max. RCF: 21380×g
 Rotor capacity: 2mL/1.5mL×24/0.2mL×24/0.5mL×24
 Rotor material: Aluminum alloy
 Bio-safe(Bio sealing): Yes
 Available rotor adapters: A02P2,A05P2



Cat. No. 19400070

AS12-5V (cone bottom)
for D3024 & D1524R

Max. speed: 15000rpm
 Max. RCF: 21380×g
 Rotor capacity: 5mL×12(Cone bottom)
 Rotor material: Aluminum alloy
 Bio-safe(Bio sealing): Yes



Cat. No. 19400071

AS36-05
for D3024 & D1524R

Max. speed: 15000rpm
 Max. RCF: 21380×g
 Rotor capacity: 0.5mL×36,0.2mL×36
 Rotor material: Aluminum alloy
 Bio-safe(Bio sealing): Yes
 Available rotor adapters: A02P05



Cat. No. 19400072

AS4-PCR8
for D3024 & D1524R

Max. speed: 15000rpm
 Max. RCF: 21380×g
 Rotor capacity:0.2mL/PCR8×4
 Rotor material: Aluminum alloy
 Bio-safe(Bio sealing): Yes

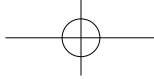

Cat. No. 19400073

AS18-5 (round bottom) for D3024 & D1524R

Max. speed :15000rpm
Max. RCF:21380×g
Rotor capacity:5mL×18 (Round bottom)
Rotor material:Aluminum alloy
Bio-safe(Bio sealing):Yes

Available adapters



Cat. No. 19500001

A02P2

0.2mL rotor adapter
Used with A12-2, A12-2P, AS24-2 and A24-2P rotors
24pcs/pk



Cat. No. 19500002

A05P2

0.5mL rotor adapter
Used with A12-2, A12-2P, AS24-2 and A24-2P rotors
24pcs/pk



Cat. No. 19500003

A02P05

0.2mL rotor adapter
Used with AS36-05 rotor
36pcs/pk

Model	Rotor model	Capacity	Hole diameter(mm)	Hole depth (mm)	Max. tube length (mm)
D2012plus	A12-2P	2×12	11.2	39	47
	AS24-2	2×24	11.2	40.5	54.2
	AS36-05	0.5×36	8.2	29.3	36
D3024 D1524R	AS4-PCR8	0.2×32	6.5	20.4	36
	AS18-5	5×18	13.7	39	56.5
	AS12-5V	5×12	17.5	44	56.5

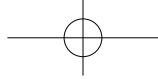

DLAB hematocrit centrifuge with AC24P hematocrit rotor is used for determination of volume fractions of erythrocytes in blood for diagnostic purposes and doping tests. Also it is used for the photometric determination of bilirubin content in neonate blood samples. Hematocrit centrifuge with A24-2P tube rotor, can be used for extraction of DNA and RNA.



CE FC



DM1424 Hematocrit Centrifuge

Features

- Speed range of 200-12000rpm, max. RCF 13680×g
- Precise control of speed and time separately
- Easy operation with intuitive menu and easy-to-read display
- Maintenance-free brushless DC motors
- Pulse operation for quick spins
- Rotor capacity: Hematocrit rotor
- Hematocrit rotor:24 capillary max. speed:12000rpm

DM1224 Economical Hematocrit Centrifuge

Features

- Max.speed is 12000rpm, max. RCF 13680×g
- Precise control of speed and time separately
- Rotor capacity: Hematocrit rotor: 24 capillary



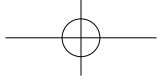

Specifications	DM1424	DM1224
Speed Range	200-12000rpm, increment: 10rpm	500-12000rpm, increment: 100rpm
Max. RCF	13680×g	13680×g
Speed Accuracy	±20	±100
Run Time	30sec-99min/Continuous	10sec-99min/Continuous
Motor	Brushless DC motor	Brushless DC motor
Display	LCD	LCD
Safety Devices	Door interlock, Overspeed detector; Automatic internal diagnosis, Automatic rotor identification	Door interlock
Acceleration/Braking time	30s ↑ 30s ↓	40s ↑ 40s ↓
Power	Single-phase, 200V-240V, 50Hz/60Hz, 5A; 100V-120V, 50Hz/60Hz, 5A 160W	Single-phase, 200V-240V, 50Hz/60Hz, 5A; 380W
Dimension[WxDxH]	280×364×274mm	280×364×213mm
Weight	10kg	10kg
Certification	CE cTÜVus FCC MCA IVD	-
Advanced features	Speed/RCF switch; Short-time run function; sound-alert function	Speed/RCF switch; Short-time run function; sound-alert function



Hematocrit Centrifuge



Available rotors

Cat. No. 19400047

AC24
DM1424 & DM1224

Max. speed: 12000rpm
Max. RCF: 13680×g
Rotor capacity: capillary tubes x24
Rotor material: High strength aluminum

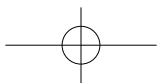

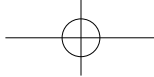

DLAB Low-speed centrifuges are widely used for the separation of serum, plasma, urine, blood samples and other routine practices in hospital and research laboratories.

Conforms to international safety standards and regulations

- DLAB Low-speed centrifuges are marked with CE, cTUVus and FCC, and passed explosion-proof test / MCA test according to IEC/EN61010-2-20
- Passed EN61010-2-101:2002 particular requirements for In-vitro diagnostic (IVD) medical equipment
- High strength plastic rotor gives excellent balance to guarantee stable working
- Dual protection housing particularly benefit for safe running
- Brushless DC motor precisely accelerates to the set speed

Precise control

- Powerful CPU for easy operation of speed, time and all other parameters
- High accuracy of speed
- Digital timer adjustable from 30 sec. to 99 min or set for continuous running
- Gentle braking at low speed for efficient separation

Ergonomic design

- Easy operation thanks to intuitive menu and easy-to-read display
- RPM or G-force can be set and displayed
- Parameters can be modified after the set speed is reached
- Pressing and holding PULSE key for quick spin function
- Automatic lid-lock release
- Easy-to-read processing display and sound alert



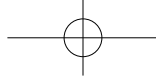

DLAB DM0412 Low-speed centrifuges support small volumes applications . The centrifuges are supplied with an built-in angle rotor that can hold up to 50mLx6 & 15mLx6 (A6-50P),15mLx8, or 10mL/7mL/5mLx12 (A12-10P) vacuum tubes. They are widely used in medical and veterinary practices for the separation of blood and urine samples or for water and soil samples for. These centrifuges are also used in universities and other research institutes



Low-speed Centrifuges

DM0412 Clinical Centrifuge

Features

- Easy programming to achieve high accuracy of speed control
- Easy operation with intuitive menu and easy-to-read display
- Rotor speed can be set and displayed by RPM or G-force
- Maintenance-free brushless DC motor
- Quick spin function with press and hold pulse key
- Lid with electric lock and automatic release function saves processing time
- Automatic self-diagnosis on startup showing accumulative running time and last running parameters
- Braking time 2 steps adjustable(for A6-50P rotor)

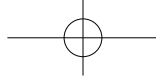

CE FC

Specifications

DM0412

Speed Range	300-4500rpm, increment: 100rpm
Max. RCF	2490×g
Speed accuracy	±20rpm
Rotor type	A12-10P, A6-50P
Run Time	30sec-99min HOLD(Continuous operation)
Motor	Brushless DC motor
Display	LCD
Safety Devices	Door interlock, Overspeed detector; Automatic internal diagnosis
Acceleration/Braking time	A12-10P: 20s ↑ 13s ↓ A6-50P: 20s ↑ 20 s /90 s ↓
Power	Single-phase, 100V-240V,50Hz/60Hz, 3A 70W
Dimension[WxDxH]	354×304×215mm
Weight	6kg
Certification	CE, cTUVus, IVD
Advanced features	Speed/RCF switch; Short-time run function; sound-alert function



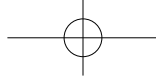

Available rotors



Cat. No. 19200348

A12-10P (round bottom)

for DM0412 & DM0412s & DM0424 & DM0408

Max. speed: 4500rpm
Max. RCF: 2490×g
Rotor capacity: 8x15mL, 12x10mL
Rotor material: High strength plastic













Cat. No. 19100197

A6-50P (round bottom)

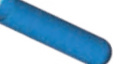
For DM0412(A6-50P)

Max. speed: 4000rpm
Max. RCF: 1800×g
Rotor capacity: 50ml×6 or 15ml×6
Rotor material: High strength plastic

A12-10P and A6-50P are not interchangeable

Available tubes	Tube quantity	Dimension (ΦLxmm)	Adapters	Maximum speed(rpm)	Radius (cm)	Maximum RCF (×g)
15mL con 	8	17×120		4500	11	2490
1.5-5mL vacu 	12	13×75	A10P15 & Plug 	4500	9.8	2218
4-7 mL vacu 	12	13×100	A10P15 	4500	11	2490
8.5-10 mL vacu 	12	16×75		4500	11	2218
8.5-10 mL vacu 	12	16×107		4500	11	2490
2.7-3 mL(EU) collection tube 	12	11×66	A10P15 & Plug 	4500	9.8	2218
7.5-8.2 mL(EU) collection tube 	12	15×92	A10P15 	4500	11	2490

Note: Made of plastic, A12-10P rotor cannot be autoclaved or applied with UV irradiation. Regular sterilization is recommended.

DM0412P centrifuge

DLAB DM0412P centrifuge is supplied with an angle rotor that can hold up to 15mLx8 or 10mL/7mL/5mLx12 (A12-10P) vacuum tubes. It is ideal for sample preparation in constimatology and dental field, like orthopedic, aesthetic surgery, oral surgery, etc.

Features

- Max. speed 4500rpm;
- Rotor speed can be set in RPM/RCF;
- 3 preloaded programs for fast operation;
- 9 programs for customization can be stored in memory;
- Powerful CPU for easy operation of speed, time and all other parameters;
- Easy-to-read processing display and sound alert;
- Automatic lid-lock release after running;
- Conforms to international safety standards and regulations marked with CE, cTUVus and FCC, and passed the explosion-proof test / MCA test according to IEC/EN61010-2-20;
- Passed EN61010-2-101: 2 0 0 2 particular requirements for In-Vitro diagnostic (IVD) medical equipment;
- Maintenance-free brushless DC motor.



Specifications

	DM0412P
Speed Range	300-4500rpm, increment:10rpm
Max. RCF	2490xg, increment: 10g
Speed accuracy	±10rpm
Rotor capacity	8x15ml,12x10mL/7mL/5mL
Run Time	30sec-99min
Motor	Brushless DC motor
Display	LCD
Preloaded Program	PRP PRF CGF
Custom Programs Memory	9 programs (6 steps for each program)
Safety Devices	Door interlock, Overspeed detector, Automatic internal diagnosis
Noise	≤56dB
Power	Single-phase, 100V-240V,50Hz/60Hz, 3A,70W
Dimension[WxDxH]	301X354X217mm
Weight	6kg
Certification	CE, cTUVus, IVD
Advanced features	Speed/RCF switch; sound-alert function

Rotor(A12-10P)&Adapters:

Holes Number	Rotor Diameter (mm)	Hole diameter (mm)	Hole Depth (mm)	Max. tube height(mm)
12	229	18.6	83.4	130



A10P15 & Plug



DLAB DM0506 low-speed centrifuge, supplied with built in fixed angle rotor A6-15P which can hold up to 15mL/10mL/7mL/5mL×6 tubes. It is widely used for blood or urine separation in medical routine practice in hospitals, clinics or research institutes.

DM0506 Low-speed Centrifuge

New

Features

- Speed range from 300-5000rpm;
- Rotor speed can be set and displayed by RPM or G-force;
- Defined program by knob will be stored and activated when power on;
- Two programs P1/P2, easy to start the procedure by one key;
- Two deceleration speeds setting to meet different requirements;
- Easy-to-read processing display and sound alert;
- Automatic lid-lock release after running;
- Maintenance-free brushless DC motor.



Specifications

	DM0506
Speed Range	300-5000rpm, increment:10rpm
Max. RCF	2350xg, increment: 10g
Speed accuracy	±20rpm
Rotor capacity	6x15mL/10mL/7mL/1.5-5ml
Run Time	30sec-99min, HD(continuous running)
Display	LCD
Programs Memory	2
Acceleration/Deceleration	1 ↑ 2 ↓
Safety Devices	Door interlock, Overspeed detector, Automatic internal diagnosis
Motor	Brushless DC motor
Power	Single-phase, 100V-240V,50Hz/60Hz, 70W
Dimension(WxDxH)	300X240X180mm
Weight	5.2kg

Advanced features

Speed/RCF switch; sound-alert function

Available adapters



A5P17 Cat. No.19500022

5ml adapter, Adapted to 13×75mm blood collection tube



A2P17 Cat. No.19500023

1.5/2ml Cryogenic Vials/ centrifuge tube adapter

Low-speed Centrifuges

DLAB low speed clinical centrifuges are widely used in the medical industry. Ideal for separation of serum, plasma, urine, fecal samples in biochemical & medical laboratories. It is an essential equipment of every clinical laboratory, blood bank, medical college and medical research institute.

DM0424 low Speed Centrifuge

Features

- Max. speed 4000rpm.
- Rotor speed can be set in RPM/RCF, with 3 programs storage capacity for routine applications.
- Max. capacity 50ml×4, Accomo dating different sizes of blood collection tubes and centrifuge tubes suitable for swing out rotor and angle rotor.
- Automatic internal diagnosis and self-detection.
- Maintenance-free brushless DC motor.



Specifications

	DM0424	DM0408
Speed range	500-4000rpm increment: 100rpm	300-4000rpm increment: 100rpm
Max. RCF	2500×g	1900×g
Speed accuracy	±100rpm	±100rpm
Rotor	Swing6×15ml Swing4×50ml Angle 24×15 ml, Angle 12×10ml/8×15ml	Angel 8×15ml(Default), Angel 10ml×12
Run time	1-99min, HOLD	1-99min, HOLD
Motor	Brushless DC motor	Brushless DC motor
Display	LCD	LED
Program	Blood: 3200rpm,10min. Urine: 1800rpm,5min. Faecal: 1300rpm,10min.	Blood: 3200rpm, 10min Urine: 1800rpm,5min Faecal: 1300rpm, 10min
Safety Device	Automatic internal diagnosis	Automatic internal diagnosis
Acceleration/deceleration	3 ↑ 4 ↓ steps	25s ↑ 35s ↓
Power	Single phase, 100V-240V, 50Hz/60Hz	Single phase, 100V-240V, 50Hz/60Hz
Dimension(W×D×H)	364×440×268mm	286×367×227mm
Weight	14.5kg	9.2kg
Noise	≤62dB(A)	≤60dB(A)

New



DM0408 Clinical Centrifuge

Features

- Speed range of 300-4000rpm.
- 3 programs storage capacity for routine applications.
- Automatic internal diagnosis.
- Maintenance free brushless DC motor.

New



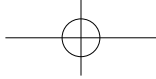

Available rotors



S6-15 **Cat. No.**19400082 for DM0424

Max. speed: 4000rpm
Rotor capacity: 15ml×6
Rotor material: Aluminum alloy
Default adaptor: A15P22, A5P17



S4-50 **Cat. No.**19400100 for DM0424

Max. Speed: 4000rpm
Rotor capacity: 50ml×4
Rotor material: Aluminum alloy
Default adaptor: A15P30, A5P17



A24-15P **Cat. No.**19400101 for DM0424

Max. speed: 4000rpm
Rotor capacity: 15ml×24
Rotor material: High strength plastic
Default adaptor: A15P22, A5P17



A8-15P **Cat. No.**19400084 for DM0424/DM0408

Max. Speed: 4000rpm
Rotor capacity: 15ml×8
Rotor material: High strength plastic
Default adaptor: A15P22



A12-10P **Cat. No.**19200348 for DM0424/DM0408 DM0412/DM0412S

Cat.No. 19200348
Rotor capacity: 15ml×8, 10ml×12
Rotor material: High strength plastic

Available adapters

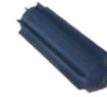

A15P30 **Cat. No.**19500024

50ml change 15ml adapter,
Adapted to 17×120mm centrifuge
tube, 13/16×100mm blood
collection tube 4pcs/pk,
for S4-50



A15P22 **Cat. No.**19500021

15ml adapter for 17×120mm
centrifuge tube, 13/16×100mm
blood collection tube 24 pcs/pk,
for S6-15, A24-15P, A8-15P



A5P17 **Cat. No.**19500022

5ml adapter, Adapted to 13×75mm
blood collection tube 24 pcs/pk,
for S4-50, S6-15, A24-15P



A2P17 **Cat. No.**19500023 (Optional)

1.5/2ml Cryogenic Vials/ centrifuge
tube adapter, 24 pcs/pk, for S4-50,
S6-15, A24-15P, A12-10P, A6-50P

Low-speed Centrifuges

Centrifuge Model	Rotor	Capacity	Hole Diameter (mm)	Hole Depth (mm)	Max. Tube Height (mm)	Max. Speed (rpm)
DM0424	S6-15	15mlx6	22	97.7	120.6	4000
	S4-50	50mlx4	29.4	87.8	125	4000
	A24-15P	15mlx24	22	97.7	120.6	4000
DM0424&DM0408	A8-15P	15mlx8	22.6	90.8	120.3	4000
	A12-10P	15mlx8/10mlx12	18.6	83.4	123	4000



DLAB DM0636 Multi-Purpose Low-speed Centrifuge is ideal for the centrifugation of samples in clinical chemistry, cytology, research laboratories, industrial laboratories, etc. This centrifuge is suitable for tubes with caps, blood collection or urine tubes. Swing-out bucket rotors and adapters can be compatible with standard tubes up to 100mL at low speed.

DM0636 Multi-Purpose Low-speed Centrifuge

Features

- Speed can be set from 300- 6000rpm
- Maximum capacity of the centrifuge: 100 mLx4
- 9 Acceleration/10 Brake speed settings to ensure optimal separation
- A wide range of rotors optional(fixed angle and swing-out bucket rotors)
- Automatic rotor identification
- Timers can be set up to 99 min or HD for continuous running
- Pulse Key for quick spin function
- 9 procedures stored in memory makes the operation much simplified
- Maintenance-free brushless DC motors



Specifications

	DM0636
Speed range	300-6000rpm increment:10rpm
Max. RCF	4020xg
Speed accuracy	±20rpm
Max. Capacity	100mLx4
Run Time	30sec-99mins/continuous
Motor	Brushless DC
Display	LCD
Program Memory	9
Safety Devices	Door Imbalance protection Over speed & Over temperature detection
Acceleration/Deceleration	9 ↑ /10 ↓ steps
Power	660W; Single-phase AC220V-240V, 50Hz/60Hz, 6.3A; AC110V-120V,50Hz/60Hz, 10A
Dimension[WxDxH]	445x579x269mm
Weight	36kg
Certification	CE
Advanced features	speed/rcf switch; Rotor identification

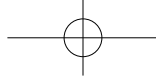

Uncapping block

for S4-100 rotor

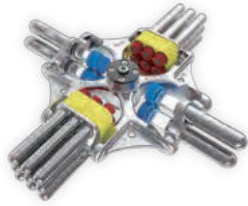

SE4-100(Standard accessory) for DM0636

Cat. No. 19400041

Max. speed: 4000rpm
Max. RCF: 2950xg
Rotor material: stainless steel body and adapter



A15V

Cat. No. 19500025

15ml conical tube adapter, MOQ 8 Pcs (optional)



19400045



19400044



19400043



19400042

bucket	x 4										
tube	x 36		x 16			x 8	x 4	x 4	x 4	x 8	x 20
Nominal volume	3-7mL		10mL	12mL	15mL	50mL	100mL	85mL	50mL	15mL	3-7mL
φ×L mm	13×75	13×100	16×100	17×105	17×120	29.5×100	38×108	38×104	29.5×100	17×120 13×100 13×75	13×100 13×75
tube											
adapter	with plug										
Package	36					8	4	4	4	8	4
Tubes per rotor	36	36	16	16	16	8	4	4	4	8	20
Radius(cm)	14	16.5	15.9	15.9	15.9	15.9	15.9	15.9	15.9	15.1	14.7
Max RCF (g-force)	2500	2950	2840	2840	2840	2840	2840	2840	2840	2700	2630

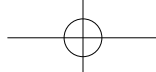

Available rotors

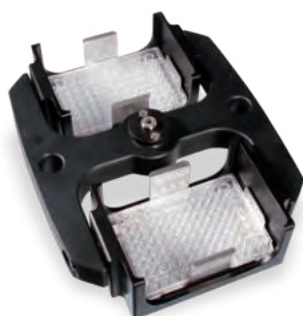

Cat. No. 19400062

S2-MP

DM0636

Max. speed: 4000rpm
Max. RCF: 2200×g
Rotor capacity: Micro-plates 384-PCR/96-PCR/Elisa plates×8pcs; Deep well plates×4pcs
Rotor material: stainless steel body and aluminum buckets



Cat. No. 19400036

AS12-PCR8

DM0636

Max. speed: 6000rpm
Max. RCF: 4020×g
Rotor capacity: PCR 8 trips×12
Rotor material: aluminum
Biosealing: Yes



Cat. No. 19400034

AS30-2

DM0636

Max. speed: 6000rpm
Max. RCF: 4020×g
Rotor capacity: 2mL×30
Rotor material: aluminum
Biosealing: Yes



Cat. No. 19400037

AS60-2

DM0636

Max. speed: 6000rpm
Max. RCF: 4020×g
Rotor capacity: 2mL×60
Rotor material: aluminum
Biosealing: Yes

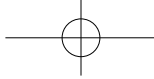

Available rotors

Cat. No. 19400038

AS6-50V (cone bottom) DM0636

Max. speed: 6000rpm
Max. RCF: 4020×g
Rotor capacity: 50mL×6 or 15mL×6
Rotor material: aluminum
Biosealing: Yes



AS18-5V (cone bottom) Cat. No. 19400035 DM0636

Max. speed: 6000rpm
Max. RCF: 4020×g
Rotor capacity: 5mL×18
Rotor material: stainless steel body and aluminum buckets
Biosealing: Yes



A8-50 (round bottom) Cat. No. 19400039 DM0636

Max. speed: 5000rpm
Max. RCF: 3960×g
Rotor capacity: 50mL×8 or 15mL×16
Rotor material: aluminum body and stainless steel adapter
Default adapters: SE100P31×8, SE100P17×6



A30-15 (round bottom) Cat. No. 19400040 DM0636

Max. speed: 4500rpm
Max. RCF: 3210×g
Rotor capacity: 15mL×30
Rotor material: aluminum body and stainless steel adapter Bio-safe(Biosealing): Yes
Default adapters: SE100P17×30

Rotor	Capacity	Hole Diameter (mm)	Hole Depth (mm)	Max. Tube Height (mm)	Max. Speed (rpm)
AS30-2	2mlx30	11.2	39	43	6000
AS60-2	2mlx60	11.2	39	43	6000
AS6-50V	50mlx6	31	87.8	118	6000
AS18-5V	5mlx18	17.5	51	56	6000
A8-50	50mlx8 15mlx16	35 17.5	85.8 98	118 123	5000
A30-15	15mlx30	17.5	98	123	4500
S2-MP	Micro platex8/ Deep well platex4	-	-	-	4000

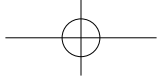

Miscellaneous

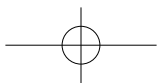
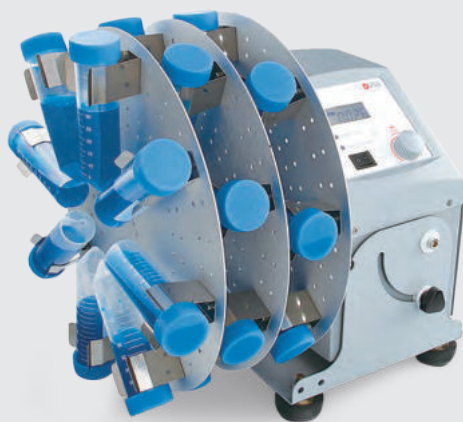

DLAB mixers range can be divided into different series as per mixing speed, working mode, load capacity etc:

Series	Image	Model	Speed Range	Working mode	Capacity	Page
Vortex Mixer		MX-S	0~2500rpm	Orbital (touch + continuous modes)	-	P.115
		MX-F	2500rpm (fixed)	Orbital (touch + continuous modes)	-	P.115
		MX-E	3000rpm (fixed)	Orbital (touch mode)	-	P.116
Cell disruptor		MX-C	0~2500rpm	Orbital (touch + continuous modes)	8x2ml	P.118
Microplate Mixer		MX-M	0~1500rpm	Orbital (continuous mode)	0.5Kg	P.122
Roller Mixer		MX-T6-Pro	0~70rpm	360° rocking&rolling (timer + continuous)	4Kg	P.127
		MX-T6-S	0~70rpm	360° rocking&rolling (continuous)	4Kg	P.127
Rocking Rotator		SK-R30S-E	0~30rpm	30±3° rocking (continuous)	10x10ml, 4x50ml	P.126
		SK-R30L-E	0~30rpm	30±3° rocking (continuous)	16x10ml 6x50ml	P.126
		SK-R30D-E	0~30rpm	40±3° rocking (continuous)	32x10ml, 12x50ml	P.126
Disk Rotator		MX-RD-Pro	10~70rpm	360° rolling (timer + continuous)	60x1.5ml, 16x15ml, 8x50ml, (available for 3 layers)	P.123
		MX-RD-E	0~80rpm	360° rolling (continuous)	48x2ml, 16x15ml, 8x50ml	P.123
Rotisserie Rotator		MX-RL-Pro	10~70rpm	360° rolling (timer + continuous)	48x1.5ml, 24x15ml, 24x50ml	P.124
		MX-RL-E	0~80rpm	360° rolling (continuous)	32x2ml, 20x15ml, 16x50ml	P.124

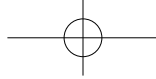

DLAB shaker series can be divided to different types as per different motion models:

Series	Image	Model	Plate Size	Display	Speed Range	Max. Load Capacity	Page
Orbital Shaker		SK-O330-Pro	32x32cm	LCD	100-500rpm	7.5Kg	P.128
		SK-O180-Pro	25x24.5cm	LCD	100-800rpm	2.5Kg	P.128
		SK-O180-S	24x21.5cm	LED	40-200rpm	3Kg	P.128
		SK-O330-M	33.5x33.5cm	LCD	70-400rpm	3Kg	P.130
Linear Shaker		SK-L330-Pro	32x32cm	LCD	100-350rpm	7.5Kg	P.131
		SK-L180-Pro	25x24.5cm	LCD	100-350rpm	2.5Kg	P.131
		SK-L180-S	24x21.5cm	LED	40-200rpm	3Kg	P.131
Rocking Shaker		SK-R330-Pro	30x28.5cm	LCD	10-70rpm	10Kg	P.133
		SK-R1807-S	24x21.5cm	LED	10-80rpm	3Kg	P.133
3D Shaker		SK-D3309-Pro	30x28.5cm	LCD	10-70rpm	5Kg	P.135
		SK-D1807-S	24x21.5cm	LED	10-80rpm	3Kg	P.135

DLAB Vortex Mixers are ideal instruments for mixing liquid components in tubes, resuspension of cells, using an eccentric mechanism. They are widely used in biological and chemical analysis applications.

MX-S Vortex Mixer

MX-F Vortex Mixer

Features

- Touch operation or continuous mode
- Variable speed control from 0 to 2500rpm (MX-S)
- Fixed Speed 2500rpm (MX-F)
- Used for various mixing applications with optional adapters (MX-S)
- Specially designed vacuum suction feet for body stability
- Robust aluminum-cast construction



Wide range of accessories

Specifications	MX-S (Adjustable speed)	MX-F (Fixed speed)
Voltage	100-120V/200-240V,50/60Hz	100-120V/200-240V,50/60Hz
Power	60W	60W
Mixing motion	Orbital	Orbital
Orbital diameter	4mm	4mm
Motor type	Shaded pole motor	Shaded pole motor
Motor rating input	58W	58W
Motor rating output	10W	10W
Speed range	0-2500rpm	2500rpm
Speed display	Scale	-
Run type	Touch operation/ Continuous	Touch operation/ Continuous
Dimension[W×H×D]	127×130×160mm	127×130×160mm
Weight	3.5kg	3.5kg
Permissible ambient temperature	5-40°C	5-40°C
Permissible relative humidity	80%RH	80%RH
Protection class	IP21	IP21



VT1.1 Standard top (Default)

for \varnothing30mm tubes and small vessels

Cat. No.18900034



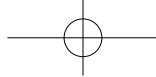

MX-E Economic Vortex Mixer

Features

- For small amount of sample mix
- Touch operation
- Fixed speed: 3000rpm
- Small and beautiful
- DC brushless motor, stable performance



Specifications

	MX-E
Power supply [VAC]	100-240
Frequency [Hz]	50/60
Power [W]	12
Mixing motion	Orbital
Revolving diameter [mm]	4.8
Motor rating output[W]	10
Rotational speed [rpm]	3000
Operating mode	Inching
External dimension [mm]	133×133×80
Dimension of packing box [mm]	250×185×130
Weight [kg]	0.6
Allowable environment temperature [°C]	5-40
Permissible Ambient Temperature	≤80%RH
Protection class	IP21



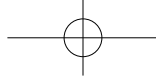

VT1.2 Tube holding rod

used with tube adapters

Cat. No. 18900044

VT1.3 Universal top plate

Ø 100mm

Cat. No.18900505



VT1.3.1 tube adapter

for 48 holes test tubes, Ø6mm (1ml)

Cat. No.18900020



VT1.3.2 tube adapter

for 15 holes test tubes, Ø10mm (1.5ml-2ml)

Cat. No.18900021



VT1.3.3 tube adapter

for 16 holes test tubes, Ø12mm (5ml)

Cat. No.18900022



VT1.3.4 tube adapter

for 8 holes test tubes, Ø16mm (10ml)

Cat. No.18900023



VT1.3.5 tube adapter

for 8 holes test tubes, Ø20mm (10ml-15ml)

Cat. No.18900024



VT1.3.6 Platform pad

for <Ø99mm tubes and small vessels

Cat. No.18900043



Application of accessories

Accessories	Adjustable speed model (0-2500rpm)	
	Touch mode (High speed area)	Continuous mode (Low speed area)
VT1.1	Y	Y
VT1.2 + VT1.3.1	Y	
VT1.2 + VT1.3.2	Y	
VT1.2 + VT1.3.3	Y	
VT1.2 + VT1.3.4	Y	
VT1.2 + VT1.3.5	Y	
VT1.3 + VT1.3.6	Y	
VT1.3 + VT1.3.1		Y
VT1.3 + VT1.3.2		Y
VT1.3 + VT1.3.3		Y
VT1.3 + VT1.3.4		Y
VT1.3 + VT1.3.5		Y



VT1.3.7 vacuum chuck

made of rubber

Cat. No.18900158



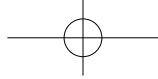

MX-C Cell Disruptor

Cell disruption is the method or process for releasing biological molecules from inside a cell. The cell suspension and the microbeads are fully mixed under controlled rapid oscillation. The microbeads and the cells shear and collide with each other effectively breaking the cell wall and releasing its contents. Best suited for research work in laboratories ideal for accurate, reproducible, repeatable results.

Features

- Easy to operate Rapid hands-free disruption
- Processes at a Constant, Controlled Shear Rate
- Simultaneous processing of multiple samples
- Maintains genome integrity of the biological samples
- Facilitates subsequent purification



Key Applications

Suitable for all sample types; Lysing highly contagious samples; Lysis of yeast and fungi; Used for Isolation of PCRReady Genomic DNA from Fecal Samples; Used for Isolation of PCR-Ready Genomic DNA from Fungi and Bacteria Samples; Used for Isolation of PCR-Ready Genomic DNA from Soil Samples; DNA & RNA Purification; Lysis of bacteria; Lysis of soft tissues; Isolation of genomic DNA; Purification of DNA; Cell Lysis; Used to lyse cell wall of yeast; Break hard/brittle samples.

The Cell Disruptor effectively solves the cell disruption difficulties caused by cell wall structure and cell number.

1. The cell wall of Gram-positive bacteria is mainly composed of peptidoglycan and acid polysaccharide. The cell walls of various yeasts and fungi are mainly composed of polysaccharides and proteins, and their dense network structure is not easy to break.
2. Some samples are more rare and precious and limited in number or volume.
3. Inappropriate crushing methods may cause genome breakage and affect subsequent experiments.

Specifications	MX-C
Functions	Disrupts cells, yeast, bacteria, algae, fungi, etc. to prepare cell lysates for further processing
Mixing motion	High-speed circumferential vortex and oscillation function
Orbital diameter [mm]	4
Speed range [rpm]	0-2500 (Adjustable)
Speed display	Scale
Capacity	8x2mL
Voltage [VAC]	200-240V/ 100-120V, 50/60 Hz, 60W
Dimension [mm]	127x130x160
Weight [kg]	3.5

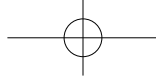

For most research of microorganism and algae, the cell wall lysis is the first step, no matter what the subsequent process is such as sequencing, identification and cloning, or intracellular substances research such as various proteins and other biomolecules. The existing common cell disruption methods has its own disadvantages which are explained below:

Common methods	Disadvantage
Enzymatic method	It is not versatile. Different microorganism need different enzymes, and their effects are different. Enzymes cause product inhibition, and its price is high.
Chemical method	The addition of chemical reagents will form new pollution, adding trouble to further separation and purification.
Ultrasonic method	It is easy to generate heat during the ultrasonic process, which may cause protein denaturation and destroy molecular activity.
Liquid nitrogen grinding	The operation is required fast, and it is easy to be frostbite if the operation is careless. Only one sample can be processed one time.
Repeated freeze-thaw	This method can be used for bacteria with weak cell walls, but the process takes longer time. The freeze-thawing time and frequency need to be optimized to preserve cell lysate.
High-pressure homogenization	It is suitable for large number of samples. Gram-positive bacterial and fungal hyphae may cause blockage and damage to the instrument, and its cost is high too.

Application Examples

1 Yeast cells

1ml yeast solution (OD600=1) is diluted 10 times and counted using microscope (magnification $\times 400/\times 1000$). Add 0.5g 1mm/0.2mm mixed microbeads and 300ul yeast solution to the 2ml centrifuge tube. Set maximum rotation to disrupt for 5 minutes. Then count again using microscope quantification.



Microscopic verification

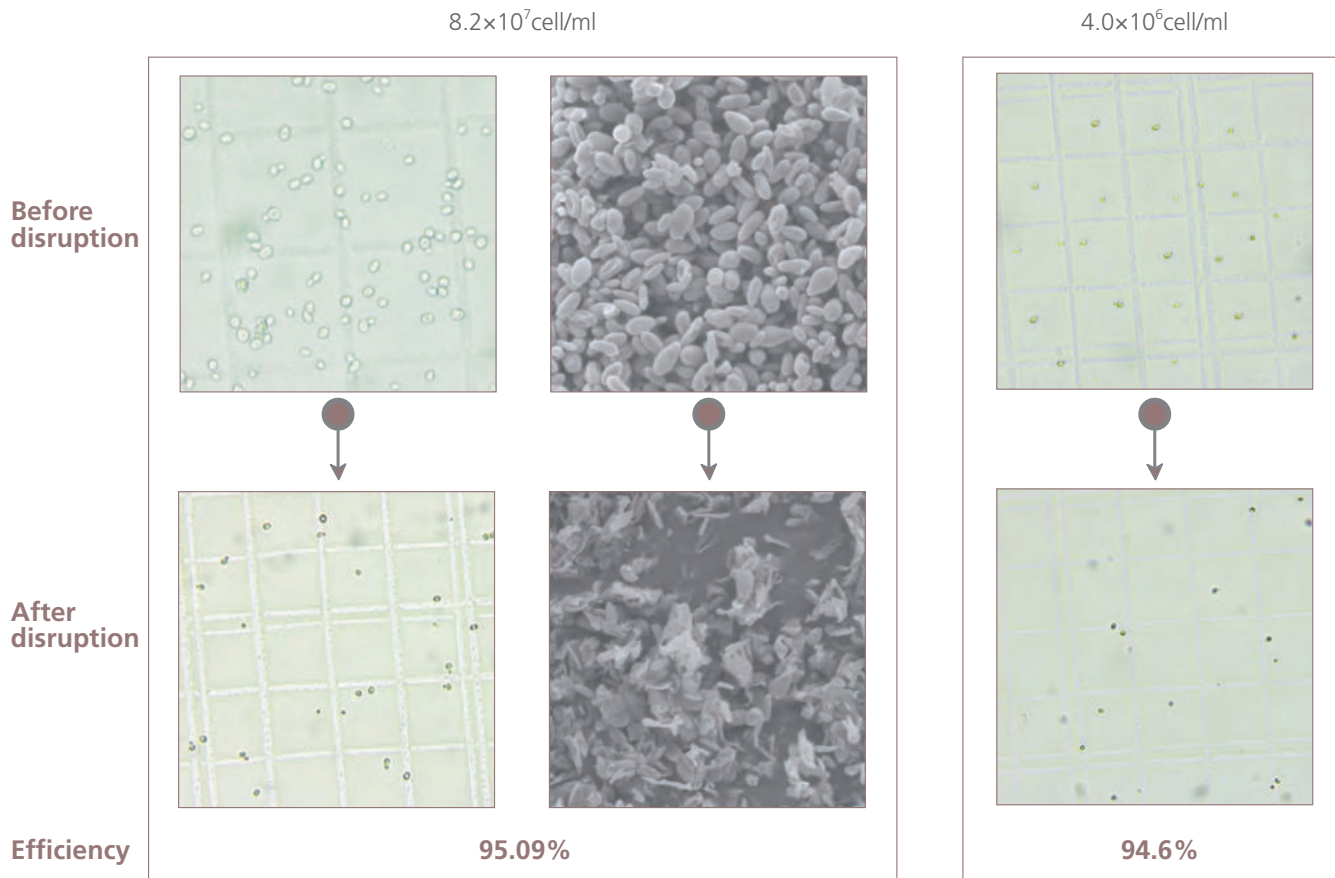

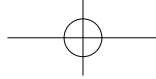

QPCR verification

Extract the genomes of 10^6 cell for QPCR verification.

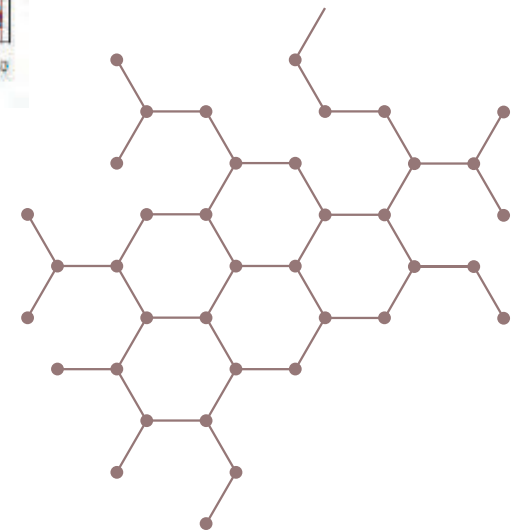
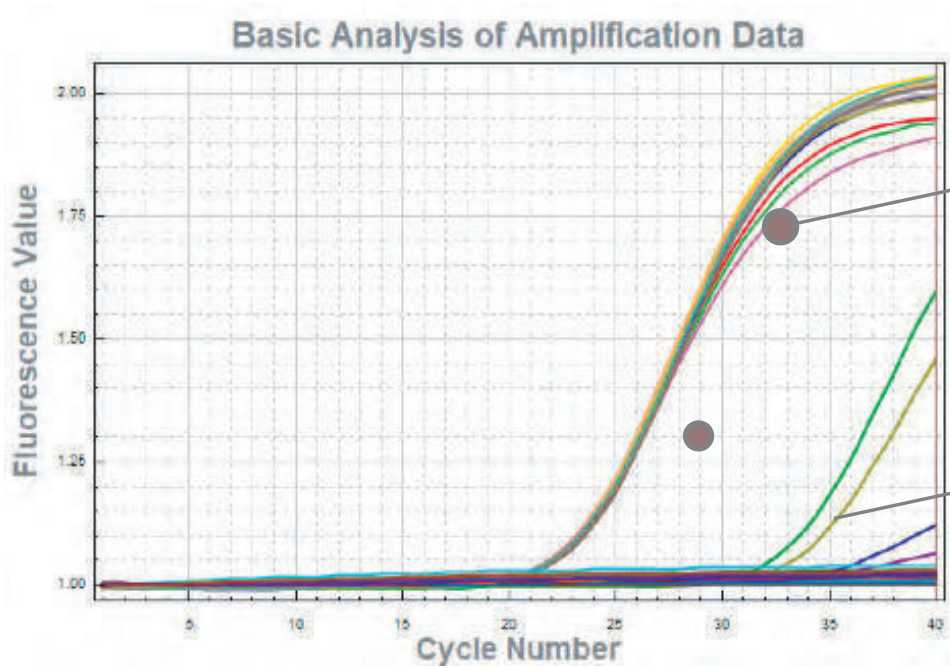

A total of 10^6 yeast cells were serially diluted to 10^5 , 10^4 , and 10^3 . Genome was extracted after cell disruption, and then verified by QPCR.

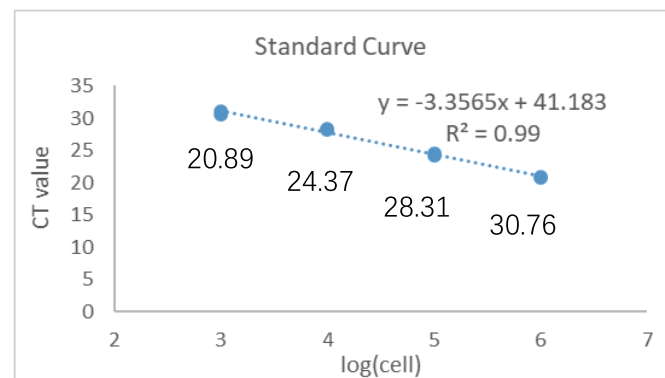
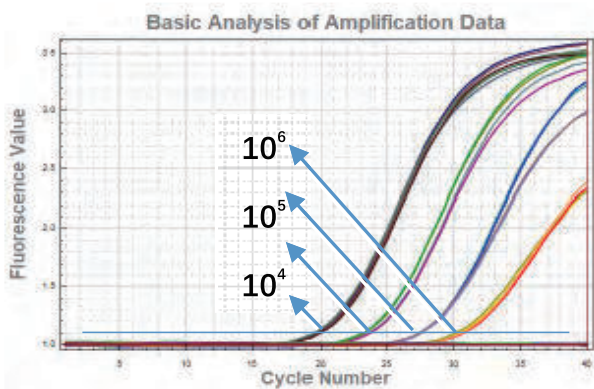

$R^2 = 0.99$. It indicates that the cell disruption efficiency is basically the same when cell numbers are in the range of 10^3 - 10^6 . This method is very suitable for rare-cell analysis.

2 / Chlorella cells

Use the same method to disrupt Chlorella cells.

Microscopic verification

Untreated Solution

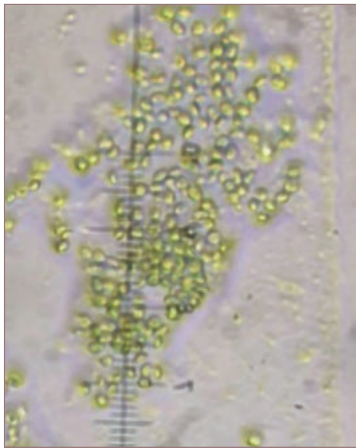

The cell structure can be clearly observed

Disruption Time: 3min

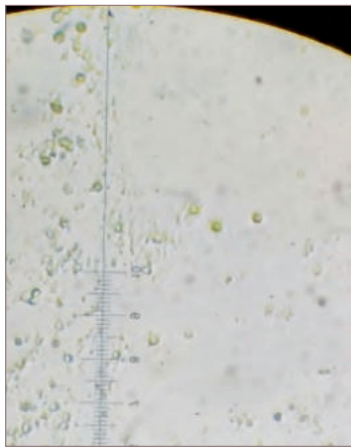

Large amount of cell debris and a small amount of unbroken cell structure can be observed.

DisruptionTime:10min

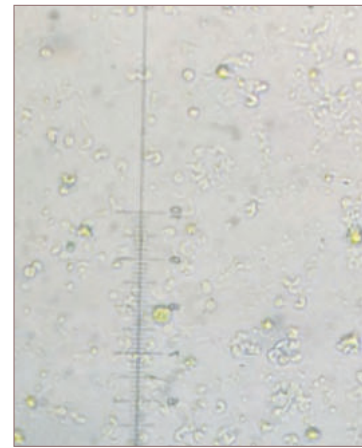

A large amount of cell debris is observed.

Spectrophotometer verification

The broken cells were filtered with 0.45 μ m filter membrane. The spectral absorbance was measured with spectrophotometer. There was an obvious absorption at 260 nm and 280 nm after 3min disruption, but the difference of absorbance at 10 min and at 3 min was small.

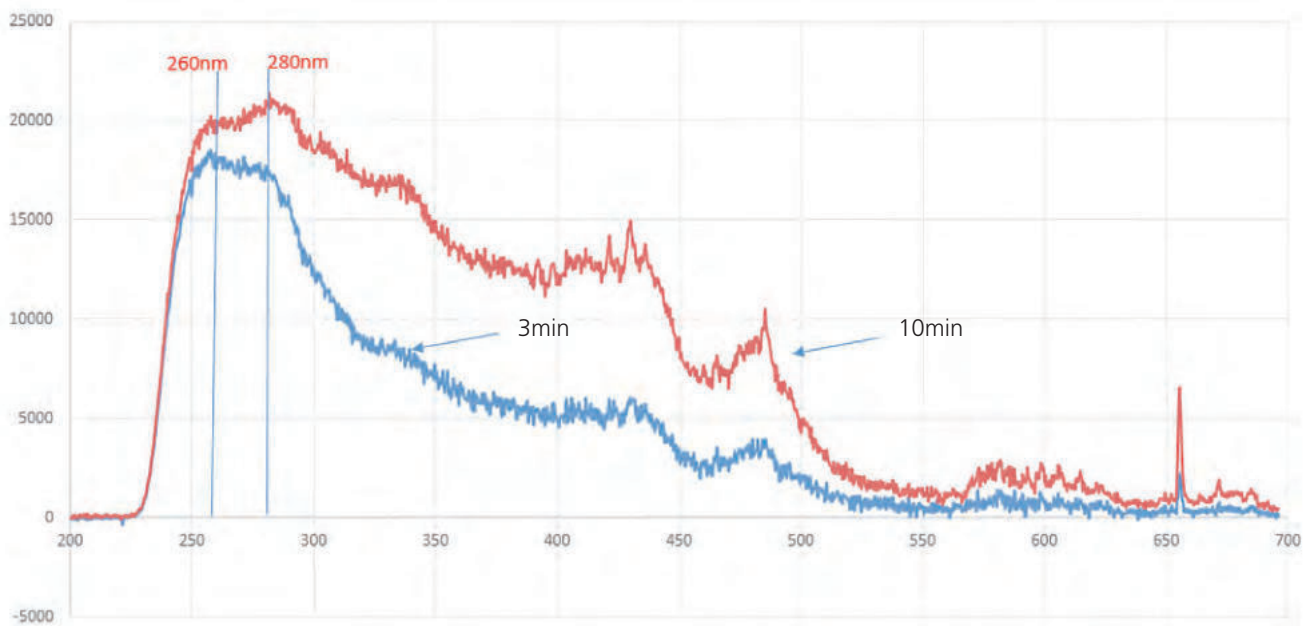

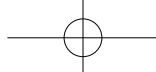

D LAB Microplate Mixer is used for holding single or double microplates. The compact shape of MX-M Microplate Mixer occupies less bench space and makes the storage easier. It is widely used in life sciences including microbiology, cell and molecular biology, immunology and biotechnology.

MX-M Microplate Mixers

Features

- A wide range of speed from 0 to 1500rpm
- Used for various mixing applications with optional adapters
- Maintenance-free brushless DC motor



Brushless DC motor



Wide range of accessories

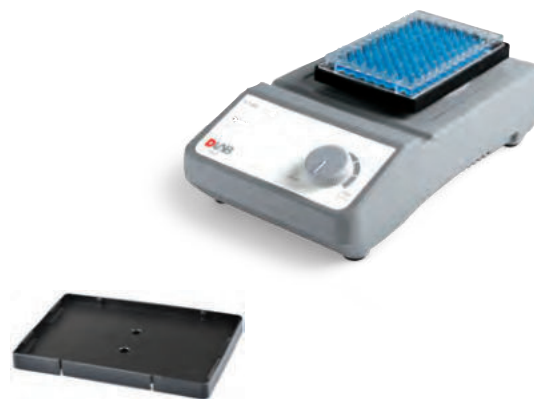

PS1.2 Microplate clamp(Default)

Cat. No.18900042



PS1.1 Universal top plate

Used with tube adapters

Cat. No.18900067



VT1.3.1 tube adapter

for 48 holes test tubes, Ø6mm

Cat. No.18900020



VT1.3.2 tube adapter

for 15 holes test tubes, Ø10mm

Cat. No.18900021



VT1.3.3 tube adapter

for 12 holes test tubes, Ø12mm

Cat. No.18900022



VT1.3.4 tube adapter

for 8 holes test tubes, Ø16mm

Cat. No.18900023



VT1.3.5 tube adapter

for 8 holes test tubes, Ø20mm

Cat. No.18900024



MXM-116

Double microplate clamps

Cat. No.18900079



Specifications

Shaking movement
Orbital diameter
Max. shaking weight (with accessory)
Motor type
Motor rating input
Motor rating output
Speed range
Speed display
Voltage
Power
Dimension
Weight
Permissible ambient temperature and humidity
Protection class

MX-M

Orbital
4.5mm
0.5kg
Brushless DC motor
18W
10W
Single microplate: 0-1500rpm
Double microplate: 0-1000rpm
Scale
100-240V,50/60Hz
20W
260×150×80mm
3kg
5-40°C,80%RH
IP21

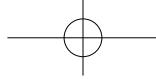

DLAB rotators give gentle but effective mixing of biological samples held in 1.5mL to 50mL tubes, and are used in a variety of applications including immune precipitations, prevention of blood coagulation, latex diagnostics, etc.

MX-RD-Pro LCD Digital Rotator

Features

- Electronic adjustment of speed and time
- LCD display of speed and time
- Speed range from 10 to 70rpm
- Rolling action, gives gentle but effective mixing
- Adjustable mixing angle from 0 to 90°
- A wide variety of accessories are available

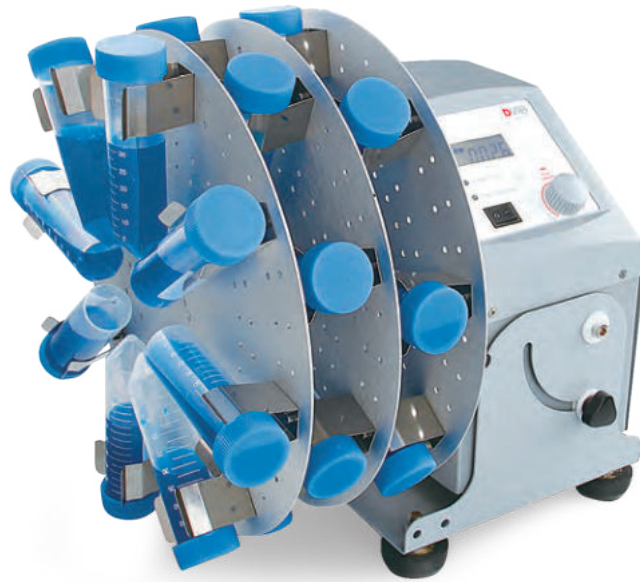

MX-RD-E Economical Rotator

Features

- Provides gentle and effective mixing of biological samples
- Adjustable speed range from 0 to 80rpm
- A wide variety of accessories are available



LCD display



Adjustable angle



Wide range of accessories



Specifications

	MX-RD-Pro	MX-RD-E
Motor type	DC motor	DC motor
Tilt angle	0-90°	-
Speed range	10-70rpm	0-80rpm
Speed display	LCD	Scale
Timer display	LCD	Scale
Timer	1-1199min	-
Operation mode	Continuous / timer	Continuous
Voltage	100-240V, 50/60Hz	100-240V, 50/60Hz
Power	40W	20W
Dimension [D×W×H]	280×210×300mm	300×220×310mm
Permissible ambient temperature and humidity	5-40°C, 80%RH	5-40°C, 80%RH
Protection class	IP21	IP21

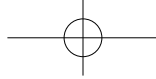

MX-RL-Pro LCD Digital Rotator

Features

- Electronic adjustment of speed and time
- LCD display speed and time
- Speed range from 10 to 70rpm
- Provides gentle but effective rolling
- A wide variety of accessories are available



MX-RL-E Economical Rotator

Features

- Provides gentle but effective rolling
- Adjustable speed range from 0 to 80 rpm
- A wide variety of accessories are available



LCD display



Wide range of accessories



Specifications

	MX-RL-Pro	MX-RL-E
Motor type	DC motor	DC motor
Speed range	10-70rpm	0-80rpm
Speed display	LCD	Scale
Timer display	LCD	Scale
Timer	1-1199min	-
Operation mode	Continuous/timer	Continuous
Voltage	100-240V, 50/60Hz	100-240V, 50/60Hz
Power	40W	20W
Dimension[D×W×H]	220×510×260mm	150×530×190mm
Permissible ambient temperature and humidity	5-40°C, 80%RH	5-40°C, 80%RH
Protection class	IP21	IP21

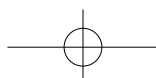

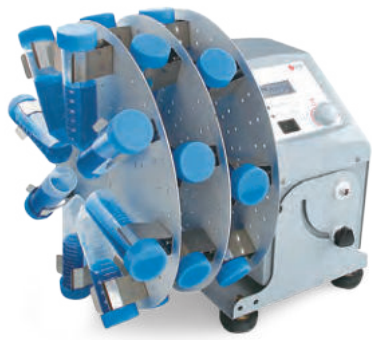
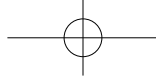

Disk Accessories Type-1

Used for MX-RD-Pro
for 1.5mLx60 centrifuge tubes holder

Cat. No.

18900160



Disk Accessories Type-2

Used for MX-RD-Pro
for 15mLx16 centrifuge tubes holder

Cat. No.

18900161

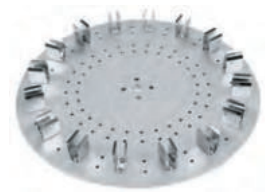

Disk Accessories Type-3

Used for MX-RD-Pro
for 50mLx8 centrifuge tubes holder

Cat. No.

18900162

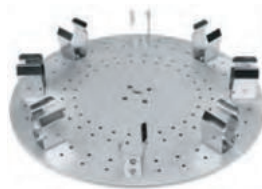

Disk support rods

4pcs in a group
use with disk accessories

Cat. No.

18900140



Rotisserie Accessory Type-1

Used for MX-RL-Pro, for 1.5mLx48
centrifuge tubes held horizontally

Cat. No.

18900142



Rotisserie Accessory Type-2

Used for MX-RL-Pro, for 15mLx24
centrifuge tubes held horizontally

Cat. No.

18900143

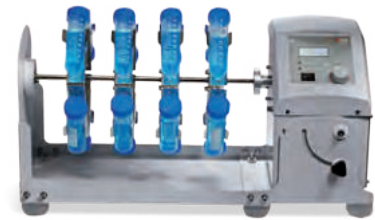

Rotisserie Accessory Type-3

Used for MX-RL-Pro, for 50mLx24
centrifuge tubes held horizontally

Cat. No.

18900144



Rotisserie Accessory Type-4

Used for MX-RL-Pro, for 1.5mLx32
centrifuge tubes held vertically

Cat. No.

18900145



Rotisserie Accessory Type-5

Used for MX-RL-Pro, for 15mLx16
centrifuge tubes held vertically

Cat. No.

18900146



Rotisserie Accessory Type-6

Used for MX-RL-Pro, for 50mLx16
centrifuge tubes held vertically

Cat. No.

18900147



Plastic Clips

Used with MX-RL-E/MX-RD-E
Disk/Rotisserie accessory, for
50mL, 15mL and 1.5mL
centrifuge tubes



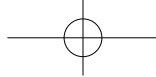

The rocking rotators combine the advantages of the long axis rotator and the rocking shaker. Compared with the rocking shaker, it can provide a greater tilt angle, for better performance in some clinical laboratory applications (such as the mixing of blood samples in vacuum blood vessels). At the same time, the series minimizes redundant functional settings for straighter and simpler user operation under clinical conditions.

SK-R30S-E Short Deck Rocking Rotator

Features

- It can accommodate up to 10 × 5~10ml blood vessels, or 4 × 50ml tubes, with different silicon mattress accessories.



New

SK-R30L-E Long Deck Rocking Rotator

Features

- It can accommodate up to 16 × 5~10ml blood vessels, or 6 × 50ml tubes, with different silicon mattress accessories.

SK-R30D-E Long Deck Double Layer Rocking Rotator

Features

- It can accommodate up to 16 × 5~10ml blood vessels, or 6 × 50ml tubes on each of the two layers with different silicon mattress accessories.
- Tilt angle up to 40°.



Specifications	SK-R30S-E	SK-R30L-E	SK-R30D-E
Tilt angle	30±3°	30±3°	40±3°
Load capacity	1kg	1kg	1kg
Motor type	Brushless DC motor	Brushless DC motor	Brushless DC motor
Speed range[rpm]	0~30	0~30	0~30
Operation mode	Continuous	Continuous	Continuous
Dimension (W×D ×H)	295×160×120mm	405×160×120mm	405×160×160mm
Voltage	100~240V, 50/60Hz	100~240V, 50/60Hz	100~240V, 50/60Hz
Power	15W	15W	15W
Weight	1.8kg	2kg	2.2kg
Permissible ambient temperature and humidity	5~40°C, 80%RH	5~40°C, 80%RH	5~40°C, 80%RH

Accessories Information



Cat. No.18202835

Silicone mattress for 16× 5~10ml blood collection tubes on long decks (SK-R30L-E&SK-R30D-E)



Cat. No.18202852

Silicone mattress for 10× 5~10ml blood collection tubes on short decks (SK-R30S-E)



Cat. No.18202846

Silicone mattress for 6× 50ml test tubes on long decks (SK-R30L-E&SK-R30D-E)



Cat. No.18202853

Silicone mattress for 4× 50ml test tubes on short decks (SK-R30S-E)

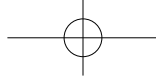

MX-T6-Pro LCD Digital Tube Roller

Features

- LCD displays the speed and time
- Speed range of 10-70rpm
- Six roller design for gentle rolling and easy to clean
- Continuous or timer operation



MX-T6-S Tube Roller

Features

- Speed range of 0-70rpm
- Six roller design for gentle rolling and easy to clean

DLAB tube rollers provide a gentle and highly efficient rolling motions, ideal for mixing blood samples, viscous substances and liquid-solid suspensions. Used in a variety of applications, such as the prevention of blood coagulation, immune precipitation, etc.



LCD display



Timer

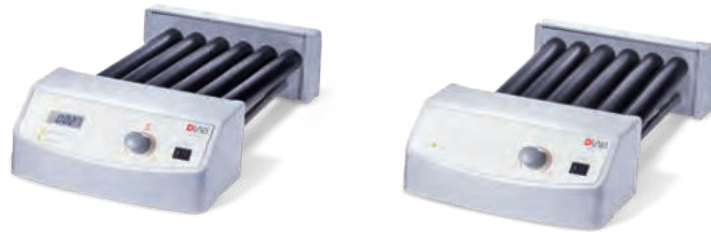

Specifications

	MX-T6-Pro	MX-T6-S
Amplitude	24mm	24mm
Motor type	DC motor	DC motor
Rocking motion	Rocking and rolling	Rocking and rolling
Max. load capacity	4kg	4kg
Number of rollers	6	6
Roller size[length]	280mm	280mm
Speed range	10 -70rpm	0-70rpm
Speed display	LCD	Scale
Timer	Yes	-
Timer display	LCD	-
Time setting range	1-1199min	-
Operation mode	Continuous/timer	Continuous
Voltage	100-240V,50/60Hz	100-240V,50/60Hz
Power	30W	25W
Dimension [D×W×H]	450×260×120mm	450×260×120mm
Weight	5.1kg	4.5kg
Permissible ambient temperature and humidity	5-40°C,80%RH	5-40°C,80%RH
Protection class	IP21	IP21

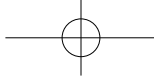

D LAB orbital and linear shakers are ideal for almost any vessel from microcentrifuge tubes through petri dishes and microtitre plates to conical flasks.

SK-O330-Pro **SK-O180-Pro** LCD Digital Orbital Shaker



Features

- Max. load capacity is 7.5kg(O330) and 2.5kg(O180) with platform
- Double LCDs for independent display of time and speed
- Used with a wide variety of accessories
- Maintenance- free brushless DC motor
- Over speed detection and protection
- Remote function provides PC control and data transmission



Timer



Wide range of accessories

SK-O180-S LED Digital Orbital Shaker



Features

- Max. load capacity is 3kg with platform
- Double LEDs for independent display of time and speed
- Speed range of 40-200rpm
- Wide range of platforms for use with a variety of vessels



Specifications

	SK-O330-Pro	SK-O180-Pro	SK-O180-S
Orbital diameter	10mm	4mm	20mm
Max. load capacity (with platform)	7.5kg	2.5kg	3kg
Motor type	Brushless DC motor	Brushless DC motor	DC motor
Motor input power	28W	28W	16W
Motor output power	15W	15W	10W
Speed range	100-500rpm	100-800rpm	40-200rpm
Speed display	LCD	LCD	LED
Timer display	LCD	LCD	LED
Time settings range	1min-19h59min	1min-19h59min	1min-19h59min
Voltage	100-240V,50/60Hz	100-240V,50/60Hz	100-240V,50/60Hz
Power	30W	30W	20W
Weight	13.5kg	8.1kg	3.1kg
Permissible ambient temperature and humidity	5-40°C, 80%RH	5-40°C, 80%RH	5-40°C,80%RH
Dimension[W×D×H]	370×420×100mm	300×340×100mm	270×330×110mm
Protection class	IP21	IP21	IP21
Data connector	RS232	RS232	-



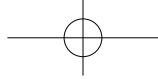

SK-O330-M Fixed Top LCD Digital Orbital Shaker



Features

- Max. load capacity 3kg;
- Independent LCD display for speed and time;
- Speed and time value can be altered during running;
- Maintenance-free brushless DC motor;
- Foot screws height can be adjusted to make sure stable running;
- Continuous or timing mode optional.



Specifications

SK-O330-M

Orbital Diameter	10mm
Max. Load capacity	3kg
Motor type	Brushless DC Motor
Motor Input Power	20W
Motor Output Power	15W
Speed Range	70~400rpm
Speed Display	LCD
Timer Display	LCD
Time Setting Range	1~1199min
Voltage	100-240V, 50/60Hz
Power	25W
Weight	9.8kg
Permissible Ambient temperature and humidity	5~40°C, 80%RH
Dimension(WxDxH)	420x370x100mm
Protection class	IP21



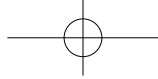

SK-L330-Pro SK-L180-Pro LCD Digital Linear Shaker

Features

- Max. load capacity is 7.5kg(L330) and 2.5kg(L180) with platform
- Double LCDs for independent display of time and speed
- Wide range of platforms for use with a variety of vessels
- Maintenance- free brushless DC motor
- Over speed detection and protection



Timer



Wide range of accessories

SK-L180-S LED Digital Linear Shaker

Features

- Max. load capacity is 3kg with platform
- Double LEDs for independent display of time and speed
- Speed range of 40-200 rpm
- Wide range of platforms for use with a variety of vessels



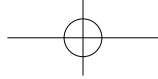

Specifications	SK-L330-Pro	SK-L180-Pro	SK-L180-S
Amplitude	10mm	4mm	20mm
Max. load capacity (with platform)	7.5kg	2.5kg	3kg
Motor type	Brushless DC motor	Brushless DC motor	DC motor
Motor input power	28W	28W	16W
Motor output power	15W	15W	10W
Speed range	100-350rpm	100-350rpm	40-200rpm
Speed display	LCD	LCD	LED
Timer display	LCD	LCD	LED
Time settings range	1min-19h59min	1min-19h59min	1min-19h59min
Voltage	100-240V, 50/60Hz	100-240V, 50/60Hz	100-240V, 50/60Hz
Power	30W	30W	20W
Weight	13.5kg	8.1kg	3.1kg
Permissible ambient temperature and humidity	5-40°C, 80%RH	5-40°C, 80%RH	5-40°C, 80%RH
Dimension[WxDxH]	370x420x100mm	300x340x100mm	270x330x110mm
Protection class	IP21	IP21	IP21
Data connector	RS232	RS232	-

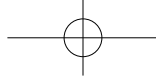

D/LAB rocking and 3D shakers provide perfect solution in electrophoresis gel dyeing/dicoloration, sample washing, molecular hybridization, immunoprecipitation, Western blot and cell culture.

SK-R330-Pro LCD Digital Rocking Shaker

Features

- Rocking motion angle 9°
- Max. load capacity is 10kg with platform
- Speed range of 10-70rpm
- Double LCDs for independent display of time and speed
- Wide range of platforms for use with a variety of vessels



Timer



Wide range of accessories

SK-R1807-S LED Digital Rocking shaker

Features

- Rocking motion angle 7°
- Max. load capacity is 3kg with platform
- Speed range of 10-80rpm
- Double LEDs for independent display of time and speed
- Wide range of platforms for use with a variety of vessels





Specifications

	SK-R330-Pro	SK-R1807-S
Tilt angle	9°	7°
Max. load capacity (with platform)	10kg	3kg
Motor type	DC motor	DC motor
Motor input power	40W	16W
Motor output power	24W	10W
Speed range	10-70rpm	10-80rpm
Speed display	LCD	LED
Timer display	LCD	LED
Time settings range	1min-19h59min	1min-19h59min
Voltage	100-240V, 50/60Hz	100-240V, 50/60Hz
Power	50W	20W
Weight	9kg	3.2kg
Permissible ambient temperature and humidity	5-40°C, 80%RH	5-40°C, 80%RH
Dimension[WxDxH]	360x410x200mm	270x330x130mm
Protection class	IP21	IP21



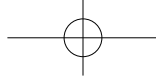

SK-D3309-Pro LCD Digital 3D Shaker

Features

- Three-dimensional rocking motion with an angle of 9°
- Max. load capacity is 5kg with platform
- Speed range of 10-70rpm
- Double LCDs for independent display of time and speed
- Various of platform accessories



Timer



Wide range of accessories

SK-D1807-S LED Digital 3D Shaker

Features

- Three-dimensional rocking motion with the angle of 7°
- Max. load capacity is 3kg with platform
- Speed range of 10-80rpm
- Double LEDs for independent display of time and speed
- Various of platform accessories





Specifications

	SK-D3309-Pro	SK-D1807-S
Tilt angle	9°	7°
Max. load capacity (with platform)	5kg	3kg
Motor type	DC motor	DC motor
Motor input power	40W	16W
Motor output power	24W	10W
Speed range	10-70rpm	10-80rpm
Speed display	LCD	LED
Timer display	LCD	LED
Time settings range	1min-19h59min	1min-19h59min
Voltage	100-240V, 50/60Hz	100-240V, 50/60Hz
Power	50W	20W
Weight	9kg	2.7kg
Permissible ambient temperature and humidity	5-40°C, 80%RH	5-40°C, 80%RH
Dimension[WxDxH]	360x430x106mm	270x330x130mm
Protection class	IP21	IP21
Data connector	-	-

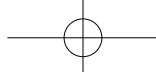

SK330.5



SK180.4



SK180.5



SK180.6



SK330.1



SK330.3



SK180.1



SK180.3



Cat. No.

Description

SK-O330-Pro
SK-L330-Pro
SK-R330-Pro
SK-D3309-Pro

SK-O180-Pro/S
SK-L180-Pro/S
SK-R1807-S
SK-D1807-S

18900155

Dish platform with non-slip mat and fixed string (8pcs)
Dimension[WxD]: 30x28.5cm

■

18202835

Silicone mattress for 16x 5~15ml tubes, use with SK330.5

■

18202846

Silicone mattress for 6x 50ml tubes, use with SK330.5

■

18900185

Dish attachment with non-slip mat
Dimension[WxD]: 24x21.5cm

■

18900200

Large size dish attachment with non-slip mat
Dimension[WxD]: 30x23cm

■

18900326

Dish attachment with non-slip mat
Dimension[WxD]: 28x28cm

■

18202852

Silicone mattress for 10x 5~10ml tubes

■

18202853

Silicone mattress for 4x 50ml tubes

■

18900027

Universal attachment with 4 bars
Size: 32x32cm
Capacity for flask: 25mlx21pcs,
50mlx15pcs, 100mlx12pcs,
250mlx6pcs, 500x4pcs

■

18900040

Lengthways roller attachment
Size: 32x32cm
Capacity for flask: 25mlx21pcs,
50mlx15pcs, 100mlx12pcs,
250mlx6pcs, 500x4pcs

■

18900025

Universal attachment with 3 bars
Size: 25x24.5cm
Capacity for flask: 25mlx10pcs,
50mlx8pcs, 100mlx6pcs,
250mlx4pcs, 500x2pcs

■

18900038

Lengthways roller attachment
Size: 25x24.5cm
Capacity for flask: 25mlx10pcs,
50mlx8pcs, 100mlx6pcs,
250mlx4pcs, 500x2pcs

■

18900036

Bar for SK330.1 universal attachment

■

18900037

Bar for SK180.1 universal attachment

■

18900280

Connect sticks for double dishes shaker

■

■

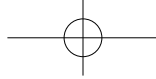

SK330.2

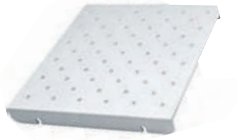

SK180.2



Cat. No.	Description	SK-O330-Pro SK-L330-Pro SK-R330-Pro SK-D3309-Pro	SK-O180-Pro/S SK-L180-Pro/S SK-R1807-S SK-D1807-S
18900028	Fixing clip attachment Size: 32 x 32cm	■	
18900026	Fixing clip attachment Size: 25 x 24cm		■
18900029	Fixing clip for flask volume 25mL, used with SK330.2[56pcs] SK180.2[36pcs]	■	■
18900030	Fixing clip for flask volume 50mL, used with SK330.2[28pcs] SK180.2[18pcs]	■	■
18900031	Fixing clip for flask volume 100mL, used with SK330.2[28pcs] SK180.2 [18pcs]	■	■
18900032	Fixing clip for flask volume 200/250 mL, used with SK330.2[13pcs] SK180.2[8pcs]	■	■
18900033	Fixing clip for flask volume 500mL, used with SK330.2[9pcs] SK180.2[8pcs]	■	■

Spectrophotometer

SP-V1000/SP-UV1000/SP-V1100/ SP-UV1100

The spectrophotometer is an indispensable instrument routinely used in colleges, universities and research institutes for quantitative analysis in fields including biotechnology and quality control of new material developed. V-Series provide high resolution, high performance and excellent stability.



Spectrophotometer

Features

- **User Friendly Operation and Information Rich LCD Display:** The large 128 x 64 dots, backlit LCD screen with adjustable brightness control displays a large array of data also in graphical format
- **On-Board Data Storage:** The System can save the test results, up to 200 group datas and 200 standard curves in the RAM memory
- Data can be restored after a sudden power failure
- **Auto setting wavelength:** Setting wavelength automatically to calibrate the system through arrow keys to avoid operation errors
- **Automatic Switching:** Tungsten & Deuterium lamps switching is automatic. Wavelength range are selectable from 190 to 1100nm
- **PC control through application software:** The spectrophotometer is fully equipped and capable of executing all functions in stand-alone mode. The optional application software '**Wave Professional**' provides computer control through the built-in USB port, apart from other functions such as spectrum scan, time scan(kinetics), multiwavelength scanning & Nucleic Acid / Protein measurement. (SP-V1100/SP-UV1100)
- **Large sample compartment:** To accommodate 5–100mm path length cuvettes with optional holders. A variety of optional accessories are available

Basic Mode

546.0nm			0.001A
No.	WL.	Abs.	
1	230.0	0.001	
2	340.0	0.000	
3	450.0	0.002	
4	540.0	0.000	
5	620.0	0.003	

Quantitative

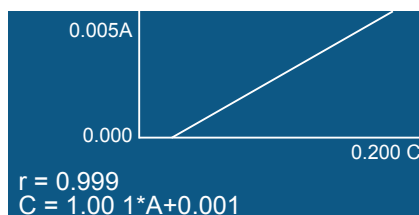

Kinetics

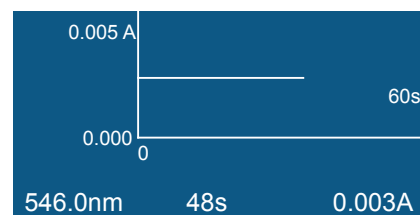



Model	SP-V1000	SP-UV1000	SP-V1100	SP-UV1100
Optical System	Single Beam	Single Beam	Single Beam	Single Beam
Light Source	Tungsten lamp	Tungsten lamp & Deuterium lamp	Tungsten lamp	Tungsten lamp & Deuterium lamp
Spectral Bandwidth	4.0nm	4.0nm	2.0nm	2.0nm
Wavelength Range	325-1000nm	200-1000nm	320-1100nm	190-1100nm
Wavelength Accuracy	±2nm	±2nm	±0.5nm	±0.5nm
Wavelength Repeatability	≤1nm	≤1nm	≤0.3nm	≤0.3nm
Photometric Range	-0.3 - 3.0 A, 0 - 200%T	-0.3 - 3.0 A, 0 - 200%T	-0.3 - 3.0 A, 0 - 200%T	-0.3 - 3.0 A, 0 - 200%T
Photometric Accuracy	±0.003 A @ 0.5 A, ±0.006 A @ 1.0 A, ±0.5%T @ 100%T	±0.003 A @ 0.5 A, ±0.006 A @ 1.0 A, ±0.5%T @ 100%T	±0.002 A @ 0.5 A, ±0.004 A @ 1.0 A, ±0.3%T @ 100%T	±0.002 A @ 0.5 A, ±0.004 A @ 1.0 A, ±0.3%T @ 100%T
Photometric Repeatability	≤0.0015 A @ 0.5 A, ≤0.003 A @ 1.0 A, ≤0.25%T @ 100%T	≤0.0015 A @ 0.5 A, ≤0.003 A @ 1.0 A, ≤0.25%T @ 100%T	≤0.001 A @ 0.5 A, ≤0.002 A @ 1.0 A, ≤0.15%T @ 100%T	≤0.001 A @ 0.5 A, ≤0.002 A @ 1.0 A, ≤0.15%T @ 100%T
Stability	≤0.002 A/h @ 500 nm (after preheat 2 hours)	≤0.002 A/h @ 500 nm (after preheat 2 hours)	≤0.002 A/h @ 500 nm (after preheat 2 hours)	≤0.002 A/h @ 500 nm (after preheat 2 hours)
Stray Light	≤0.2%T @ 360nm	≤0.2%T @ 220&360nm	≤0.05%T @ 360nm	≤0.05%T @ 220 & 360nm
Sample Compartment	4-position, 10mm pathlength cuvette	4-position, 10mm pathlength cuvette	4-position, 10mm pathlength cuvette	4-position, 10mm pathlength cuvette
Display	LCD	LCD	LCD	LCD
Output	USB Port & Parallel Port (Printer)	USB Port & Parallel Port (Printer)	USB Port & Parallel Port (Printer)	USB Port & Parallel Port (Printer)
Power	110/220VAC, 50/60Hz, 80W	110/220VAC, 50/60Hz, 120W	110/220VAC, 50/60Hz, 80W	110/220VAC, 50/60Hz, 120W
Dimension(LxWxH)	490x360x210mm	490x360x210mm	490x360x210mm	490x360x210mm
Weight	12kg	14kg	12kg	14kg

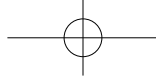

Cat. No. 18900337
Micro Cell holder



Cat. No. 18900340
8-position auto cell changer
(for SP-V1100&SP-UV1100)



Cat. No. 18900331
4-cell holder for 10mm sq. cuvette



Cat. No. 18900332
4-cell holder for 10mm
to 50mm sq. cuvette



Cat. No. 18900333
4-cell holder for up to
100mm sq. cuvette



Cat. No. 18900338
Test tube holder($\phi 8$ - $\phi 22$ mm)



Cat. No. 18900334
cylindrical cell holder($\phi 16$ mm)



Cat. No. 18900339
solid sample holder
($\phi 1.5$ - 3 mm $\phi 1$ position)



Cat. No. 18900335
10mm water-jacketed 1 cell holder
(for SP-V1100 & SP-UV1100)



Cat. No. 18900336
10mm water-jacketed 4-cell holder
(for SP-V1100 & SP-UV1100)



Square cuvettes glass/quartz
1-5mm/10-100mm



Cat. No. 18900341
12V20W halogen lamp



Cat. No. 18900342
Milas deuterium lamp, 10V, 300mA, 30W
(for SP-UV1000&SP-UV1100)

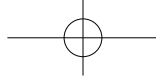

GelSMART

The GelSMART gel imaging system can be used for qualitative analysis of nucleic acid and protein in purification and /or separation application, or colony counting application.

Functions & Applications

GelSMART facilitates fast access to acquire high-quality images of electrophoresis gel or transfer membrane for analysis using smartphone/ tablet. With epi-blue instead of ultraviolet light source, GelSMART is able to safely and efficiently visualize stained DNA signals after gel electrophoresis. In addition, Coomassie blue stained SDS-PAGE and colony dishes can be observed with the light plate mounted on the GelSMART. Optionally you can control the complete imaging system via an app on your smartphone or tablet.

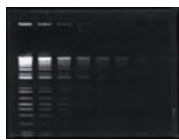

ECO Safe staining

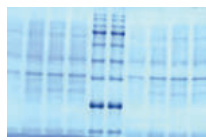

Coomassie blue stained SDS-PAGE



colony dish image

Features

- Compact foot print with a field of 10×10cm
- Simple operation of experiments and quick acquisition of results
- Epi-blue light diminishes UV exposure to lab personnel and DNA damage in the sample
- Adjustable epi-blue light source emits light with high intensity and minimum heat for better light control
- Filter holders can accommodate most popular smartphones/tablets
- Optional light-weight app

Simple assemble

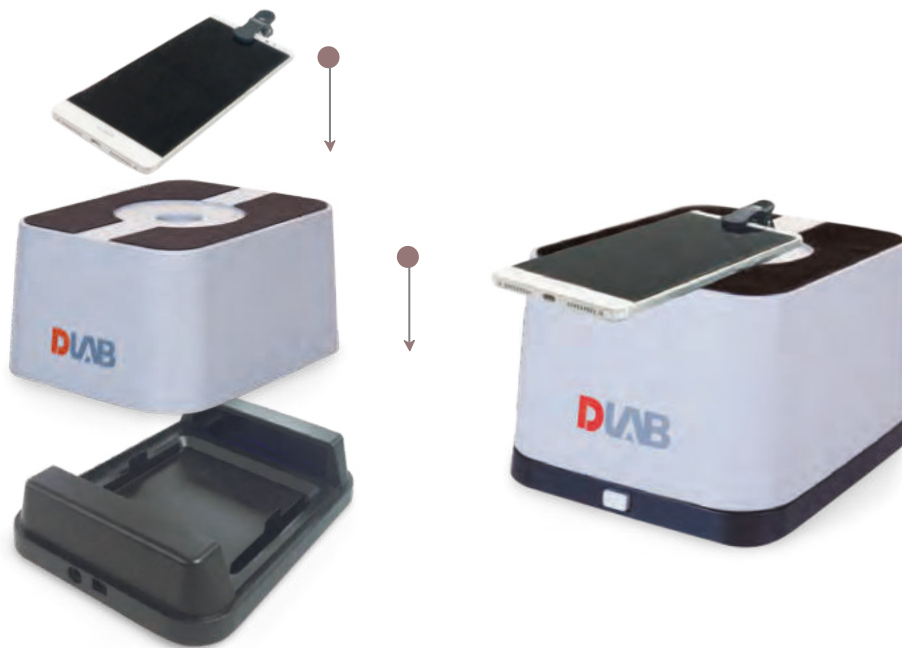

Applications:

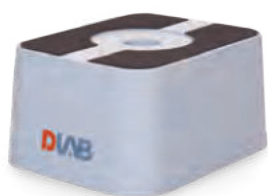

Light source cover



Light source



Smartphone

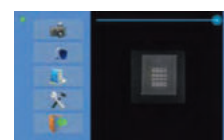

App

Observe and cut gels safe and sound with the amber filter shield



Specifications

Specifications	GeSMART
Light Source	470nm epi blue light
White Light Plate	Yes
Filter Protective Shield	Amber, using when observing or cutting gels
Viewing Area	10 x 10cm
Compatible Dye	DNA: ECO Safe, SYBR Safe, GelGreen Protein: Lightning Red, Silver/ Coomassie blue, SYPRO Ruby
Light Source (L x W x H)	216 x 168 x 54 mm
Light Source Cover (L x W x H)	211 x 161 x 108 mm
Total Size (L x W x H)	216 x 168 x 128 mm
Weight	1.2 Kg
Power Supply	12V / 1.5A AC power adapter
Optional app	for Android 4.4 and above or iOS9.0 and above

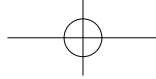
**ST800-SA****ST800-EA**

DLAB Infrared sterilizers are designed for short time sterilization of laboratory equipments like inoculating loop, inoculated needles, tweezers and other small items with high temperature. These can also be used for the low temperatures with long time sterilization to prevent contamination.

ST800-SA / ST800-EA Infrared Sterilizer

Features

- DLAB sterilizers are heating fast, convenient and can replace alcohol lamps and bunsen burners
- Sterilization is completed within 5-7 seconds
- Very safe to operate with no visual fire. It is only ashing the organic matter in the depths of ceramic heating body and preventing cross contamination
- LED display actual temperature with temp. control accuracy is 10°C
- These can be used in biology safety cabinets and clean bench space
- Precise temperature control precision and adjustable from 300 - 830°C
- Heating zone angle adjustable(ST800-SA/EA)
- Optional bracket support for inoculate loop or needle instead of holding them by hand

Specifications

	ST800-SA	ST800-EA
Display	LED	/
Temperature range [°C]	300~830	830
Central zone max temperature [°C]	825±50	825±50
The heating zone adjustable angle	0-40°	0-40°
Max. outer diameter of sterilized items [mm]	15	15
The total length of heating area [mm]	140	140
Heating tube	Ceramic	Ceramic
Shell	ABS	ABS
Dimensions [LxWxH] (mm)	180x120x186	180x120x186
Weight[kg]	1.5	1.5
Voltage[V]	220V, 50/60Hz	220V, 50/60Hz
Power[W]	190	190
Working temperature [°C]	-10~40	-10~40
Working humidity [% RH]	<80	<80
Storage temperature [°C]	-40~60	-40~60
Storage humidity [% RH]	10~90	10~90