

ScopiX IV
OX 9062
OX 9102
OX 9104
OX 9304
OX9302-BUS



DIGITAL OSCILLOSCOPES

- 60MHz, 2 isolated channels
- 100MHz, 2 isolated channels
- 100MHz, 4 isolated channels
- 300MHz, 4 isolated channels
- 300MHz, 2 isolated channels

Thank you for purchasing a **ScopiX IV digital oscilloscope with isolated channels**.

For best results from your device:

- **Read** this user manual attentively,
- **Observe** the precautions for its use.

	WARNING, risk of DANGER! The operator must refer to these instructions whenever this danger symbol appears.		In the European Union, this product is subject to selective collection and recycling at end-of-life as waste electric and electronic equipment under directive 2002/96/EC (WEEE): this equipment must not be treated as an ordinary household waste. Spent batteries must not be treated as ordinary household waste. Take them to the appropriate collection point for recycling.
	Indoor use		
	Instrument entirely protected by double insulation		Earth terminal
	Chauvin Arnoux has adopted an Eco-Design approach in order to design this appliance. Analysis of the complete lifecycle has enabled us to control and optimize the effects of the product on the environment. In particular this appliance exceeds regulation requirements with respect to recycling and reuse.		Risk of electric shocks: instructions for connecting and disconnecting the inputs. Always connect the probes or adapters to the instrument before connecting them to the measurement points. Always disconnect the probes or leads from the measurement points before disconnecting them from the instrument. These instructions apply before cleaning the instrument and before opening the cover on the battery compartment and the probe calibration outputs.
	The product is declared recyclable following an analysis of the life cycle in accordance with standard ISO 14040.		
	The CE marking indicates conformity with European directives, in particular LVD and EMC.		Application or withdrawal not authorized on conductors carrying dangerous voltages. Type B current sensor as per EN 61010-2-032.

Definition of measurement categories:

Measurement category IV corresponds to measurements taken at the source of low-voltage installations.

☞ Example: power feeders, counters and protection devices.

Measurement category III corresponds to measurements on building installations.

☞ Example: distribution panel, circuit-breakers, machines or fixed industrial devices.

Measurement category II corresponds to measurements taken on circuits directly connected to low-voltage installations.

☞ Example: power supply to electro-domestic devices and portable tools.

PRECAUTIONS FOR USE

This instrument and its accessories comply with safety standards EN61010-1, EN61010-031, and EN61010-2-032, at voltages that depend on the accessories (600V CAT III with respect to earth whatever the accessory) at an altitude of less than 2,000m, indoors, with a degree of pollution ≤2.

Failure to observe the safety instructions may result in electric shock, fire, explosion, and destruction of the instrument and of the installations.

- The operator and/or the responsible authority must carefully read and clearly understand the various precautions to be taken in use. Sound knowledge and a keen awareness of electrical hazards are essential when using this instrument.
- If you use this instrument other than as specified, the protection it provides may be compromised, thereby endangering you.
- Do not use your instrument on networks of which the voltage or category exceeds those stated.
- Do not use the instrument if it seems to be damaged, incomplete, or poorly close.
- Before each use, check the condition of the insulation on the leads, housing, and accessories. Any item of which the insulation is deteriorated (even partially) must be set aside for repair or scrapping.
- Use only the leads and accessories supplied. The use of leads (or accessories) of a lower voltage rating or category limits the use of the combined instrument + leads (or accessories) to the lowest category and service voltage.
- Use personal protection equipment systematically.
- When handling the leads, test probes, and crocodile clips, keep your fingers behind the physical guard.
- All troubleshooting and metrological checks must be done by competent, accredited personnel.

CONTENTS

1. GENERAL	5	4.6.1. Active keys in the BUS Analysis mode.....	46
1.1. Introduction	5	4.6.2. Active keys of the keypad:.....	46
1.2. Delivery condition	5	4.6.3. Screen icons of the bus analysis mode	47
1.2.1. Unpacking, re-packing	5	4.7. Communication	49
1.2.2. Supply	5	4.7.1. General parameters.....	50
1.3. Accessories	6	4.8. Memories	52
1.3.1. Measurement accessories (current, voltage, temperature).....	6	4.9 Update of the firmware of embedded programs 53	
1.3.2. Other accessories.....	7	4.10. ScopeNet IV	54
1.4. Battery and power supply	7	5. HOW ARE WAVEFORMS DISPLAYED?	56
1.4.1. LITHIUM-ION technology	8	5.1 "Manual" display	56
1.4.2. Charging the battery	8	5.1.1. Using the keypad	56
1.5. Isolation of the channels	9	5.1.2. Using the touch screen.....	57
1.6. Probix accessories	10	5.2 Autose	57
1.6.1. Probix concept.....	10	5.3 Calibrating the probes	58
1.6.2. Rapid, error-free measurements.....	10	5.4 Auto/Cursors/Zoom measurement	60
1.6.3. Auto scale.....	11	5.4.1. Auto	60
1.6.4. Safety message.....	11	5.4.2. The cursors.....	61
1.6.5. Power supply to the accessories	11	5.4.3. Zoom	61
2. DESCRIPTION OF THE INSTRUMENT	12	5.5 Adjusting the Trigger	62
2.1. Front panel	12	5.6 Mathematical/FFT/XY measurement	63
2.2. Rear panel	12	6. HOW IS A QUANTITY MEASURED BY MULTIMETER?	64
2.3. Touch screen and stylus	13	6.1 Differentiating the channels	64
2.4. Accessories	14	6.2 Type of measurement	64
2.5. Communication interfaces	16	6.3 Power measurement	65
3. GETTING STARTED	17	6.4 LOGGER mode	66
3.1 General principles	17	7. HOW ARE HARMONICS ANALYZED ?	67
3.2 "ON/ OFF" key	17	8. TECHNICAL CHARACTERISTICS	68
3.3 "Screenshot" key	17	8.1. "Oscilloscope" function	68
3.4 "Full Screen" key	17	8.2 "Multimeter" and "LOGGER" function	74
3.5 "HOME" key and icon	18	8.3 "VIEWER" function	77
3.6 Brightness key	18	8.4 "HARMONIC ANALYSIS" function	78
4. FUNCTIONAL DESCRIPTION OF OX 9304	19	8.5. "Communication"	79
4.1 SCOPE mode	19	8.5.1. Communication port and peripherals.....	79
4.1.1. Keys/ active keypad.....	19	8.5.2. Applications	79
4.1.2. Adjustment of the "Reference Memory" from the keypad.....	19	9. GENERAL CHARACTERISTICS	80
4.1.3. Adjusting the AUTOSET from the keypad → "Magic Wand" key	19	9.1. Nominal range of use	80
4.1.4. Display of the measurement principles ("MEASURE") from the keypad	20	9.1.1. Environmental conditions	80
4.1.5. Adjusting the "HORIZONTAL" time base.....	20	9.1.2. Variations in the nominal range of use	80
4.1.6. Adjustment of the amplitude of the "VERTICAL" signal.....	25	9.1.3. Power supply	80
4.1.7. Adjustment of the triggering level, "TRIGGER".....	27	9.2. Mechanical characteristics	81
4.1.8. MATHEMATICAL function, from the screen	32	9.2.1. Hard enclosure covered with elastomer	81
4.1.9. AUTOMATIC measurements, from the screen ..	33	9.2.2. Mechanical conditions	81
4.1.10. Backup	34	9.3. Electrical characteristics	82
4.2 Multimeter mode	35	9.3.1. Battery power supply	82
4.2.1. Keys/keyboard active in Multimeter mode	35	9.3.2. Line power.....	82
4.2.2. Icon/screen of the Multimeter mode	36	9.4. CEM and safety	83
4.2.3. Adjustments of the VERTICAL menu	37	9.4.1. Electromagnetic compatibility	83
4.2.4. Power measurement.....	38	9.4.2. Electrical safety	83
4.3 LOGGER mode	40	9.4.3. Temperature	84
4.3.1. Keys/keyboard active in LOGGER mode	40	10. MAINTENANCE	85
4.3.2. Icons/screen in LOGGER mode	40	10.1. Warranty	85
4.3.3. Principles.....	41	10.2. Cleaning	85
4.4 VIEWER mode	42	10.3. Repair and metrological verification	85
4.5 HARMONIC mode	44	11. REMOTE PROGRAMMING	86
4.5.1. Keys/keyboard active in Harmonic mode	44	11.1. Introduction	86
4.5.2. Principle	44	11.2. Commands specific to the instrument	89
4.5.3. Icons/screen in Harmonic mode	45	11.3. IEEE 488.2 common commands	106
4.6 BUS Analysis Mode	46		

12. APPENDIX	111
12.1 « ARINC 429 » Bus	111
12.1.1. Overview	111
12.1.2. Getting started	111
12.1.3. Measurements (ARINC 429).....	112
12.2 « AS-I » Bus	113
12.2.1. Overview	113
12.2.2. Getting started	113
12.2.3. Measurements (AS-I).....	114
12.3 « CAN High-Speed » Bus	115
12.3.1. Overview	115
12.3.2. Getting started	115
12.3.3. Measurements (CAN High-Speed)	116
12.4 « CAN Low-Speed » Bus	117
12.4.1. Overview	117
12.4.2. Getting started	117
12.4.3. Measurements (CAN Low-Speed)	118
12.5 « DALI » Bus	119
12.5.1. Overview	119
12.5.2. Getting started	119
12.5.3. Measurements (DALI).....	120
12.6 « Ethernet 10Base-2 » Bus	121
12.6.1. Overview	121
12.6.2. Getting started	121
12.6.3. Measurements (Ethernet 10Base-2)	122
12.7 « Ethernet 10Base-T » Bus	123
12.7.1. Overview	123
12.7.2. Getting started	123
12.7.3. Measurements (Ethernet 10Base-T).....	124
12.8 « FlexRay » Bus	125
12.8.1. Overview	125
12.8.2. Getting started	125
12.8.3. Measurements (FlexRay).....	126
12.9 « KNX » Bus	127
12.9.1. Overview	127
12.9.2. Getting started	127
12.9.3. Measurements (KNX)	128
12.10 « LIN » Bus	129
12.10.1. Overview	129
12.10.2. Getting started	129
12.10.3. Measurements (LIN)	130
12.11 « MIL-STD-1553 » Bus	131
12.11.1. Overview	131
12.11.2. Getting started	131
12.11.3. Measurements (MIL-STD-1553)	132
12.12 « Profibus DP » Bus	133
12.12.1. Overview	133
12.12.2. Getting started	133
12.12.3. Measurements (Profibus DP).....	134
12.13 « Profibus PA » Bus	135
12.13.1. Overview	135
12.13.2. Getting started	135
12.13.3. Measurements (Profibus PA).....	136
12.14 « RS232 » Bus	137
12.14.1. Overview	137
12.14.2. Getting started	137
12.14.3. Measurements (RS232).....	138
12.15 « RS485 » Bus	139
12.15.1. Overview	139
12.15.2. Getting started	139
12.15.3. Measurements (RS485).....	140
12.16 « USB » Bus	141
12.16.1. Overview	141
12.16.2. Getting started	141
12.16.3. Measurements (USB)	142

1. GENERAL

1.1. Introduction

Your oscilloscope belongs to the **ScopiX** line of instruments; **this data sheet describes the operation of an OX 9304:**

OX 9062	digital	colour	2 isolated channels	60MHz	scale 2.5GS/s
OX 9102	digital	colour	2 isolated channels	100MHz	scale 2.5GS/s
OX 9104	digital	colour	4 isolated channels	100MHz	scale 2.5GS/s
OX 9304	digital	colour	4 isolated channels	300MHz	scale 2.5GS/s
OX 9302-Bus	digital	colour	2 isolated channels	300MHz	scale 2.5GS/s

These instruments provide the following powerful functional modes:

- **oscilloscope**
- **multimeter**
- **logger**
- **harmonic analyzer**

The interface is user-friendly: **simple, compact, and practical**. The **ProbiX** accessories ensure **safety** and **speed**, because they are recognized automatically when connected. The means of **communication** and **storage** are optimized.

1.2. Delivery condition

1.2.1. Unpacking, re-packing









The mechanical and electrical condition of all of the equipment was checked before dispatching. When you receive it, carry out a quick check for damage that may have occurred in transit. Should there be any, contact our sales department immediately and declare your reservations to the carrier. For reshipping, it is best to use the original packaging.

1.2.2. Supply

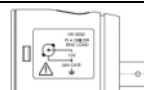
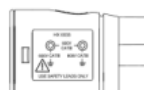
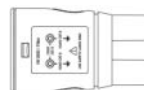
Reference	Designation	OX 2 channels	OX 4 channels 100/300MHz z	OX 9062 2x60MHz	OX 9102 2x100MHz	OX 9104 4x100MHz	OX 9304 4x300MHz	OX 9302- Bus 2x300MHz
	Leads 4mm in diameter	1	1	1	1	1	1	1
	Probe tips 4mm in diameter	1	1	1	1	1	1	1
	Straight RJ45-RJ45 cord, 2m	1	1	1	1	1	1	1
	USB cord	1	1	1	1	1	1	1
HX0179	µSD memory card, HC, 8GB + SD	1	1	1	1	1	1	1
HX0080	USB-µsd adapter	1	1	1	1	1	1	1
HX0033	BAN ProbiX adapter	1	1	1	1	1	1	1
HX0130	1/10 500MHz probe, 300V CAT III		4 (300MHz)				4	2
HX0030C	1/10 250MHz probe 600V CAT III	2	4 (100MHz)	2	2	4		
HX0120	METRIX carrying case	1	1	1	1	1	1	1
HX0121	Stylus	1	1	1	1	1	1	1
HX0122	Carrying strap	1	1	1	1	1	1	1
P01296051	LI-ION 6.9 Ah battery pack	1	1	1	1	1	1	1
P01102155	PA40W-2 mains adapter	1	1	1	1	1	1	1
P01295174	2P EURO power cords	1	1	1	1	1	1	1
HX0190	Connection cards DB9, RJ45							1
HX0191	Connection cards : M12, generics							1

1.3. Accessories

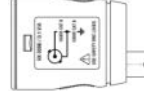
1.3.1. Measurement accessories (current, voltage, temperature)

		Terminations								Range of use	Types of measurement
		Probe	BNC adapter	Banana adapter	Clamp	Amp FLEX clip	Mini Amp FLEX SK1-20	SK1-19 sensors (1)	SP10-13 sensors (2)		
HX0130		✓								300V CAT III 500MHz	Voltage
HX0030C		✓								600V CAT III 250MHz	Voltage
HX0031			✓							300V CAT III 250MHz	Voltage
HX0032	 50Ω		✓							30V 250MHz	Voltage
HX0033				✓						300V CAT III	Voltage Resistance Capacitance Diode tester
HX0093				✓						600V CAT III Filter 300Hz	Voltage
HX0034					✓					0,2-60Arms 1MHz AC/DC	Current
HX0072						✓				5-300Arms 200kHz AC	Current
HX0073							✓			1-300Arms 3MHz AC	Current
HX0094				✓						4-20mA	%
HX0096			✓							100mV/A	Courant
HX0035B								✓		from -10°C to +1250°C	Temp. K thermocouple
HX0036									✓	from 100°C to +500°C	Temp. Probe PT-100

(1) and (2) List of temperature sensors: see chauvin-arnoux.com site

1.3.2. Other accessories

	Specifications	Accessories for <i>Probix</i>	<i>Probix</i>	Adapater
Banana adapter		<i>HX0064</i>	<i>HX0033</i>	
Industrial accessories kit		<i>HX0071</i>	<i>HX0030B</i>	
µSD HC memory card 8GB + SD				<i>HX0179</i>
USB-µSD adapter				<i>HX0080</i>
Demonstration test circuit				<i>HX0074</i>
BNC M-F4 Adapter		<i>HX0106</i>	<i>HX0031</i>	
Ext. Li-Ion charger				<i>P01102130</i>
100mV clamps	45 AAC	<i>MA200</i>	<i>HX0096</i>	
	60 AAC	<i>MN60</i>	<i>HX0096</i>	
	200 AAC	<i>C160</i>	<i>HX0096</i>	
	20 AAC/DC	<i>HX0102</i>	<i>HX0096</i>	

1.4. Battery and power supply

The instrument is powered by a rechargeable 10.8V, Lithium-Ion battery pack.
 Before the first use, start by fully charging the battery. The charging must be done between 0 and 45°C.

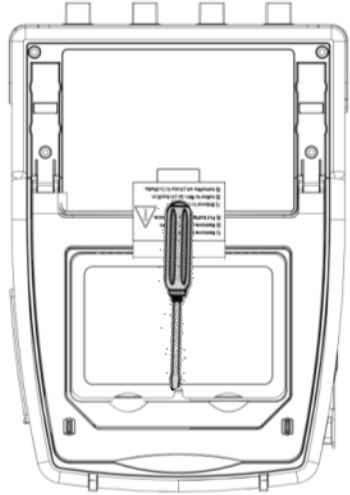
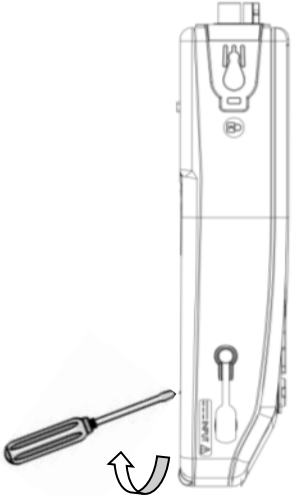
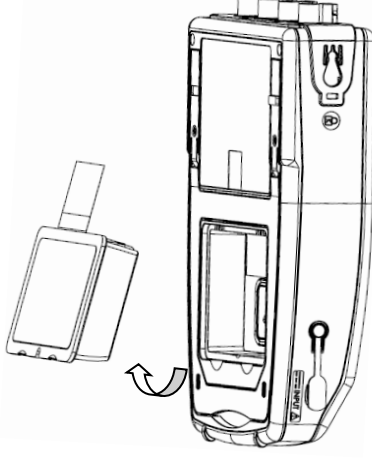
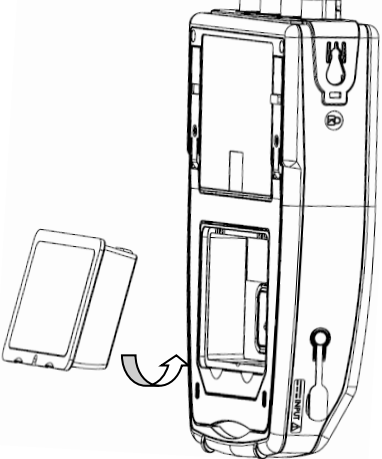
<p>Mains supply Battery +</p>	<p>1. Using a screwdriver:</p> 	<p>2. Withdraw the battery pack:</p> 
	<p>3. In the compartment, remove the protective plastic film before the first use:</p> 	<p>4. Put the battery pack back in place.</p> 

<p>Replacing the battery</p>	<p>The battery of this instrument is specific: it includes suitable protection and safety elements. Replacement of the battery by a model other than the one specified may cause material damage and bodily injury by explosion or fire.</p>
<p>Replacement procedure</p>	<ol style="list-style-type: none"> 1. Disconnect everything connected to the instrument and switch it off. 2. Turn the instrument over and insert a screwdriver in the slot in the battery pack. 3. Push the screwdriver towards the rear → the battery is driven out of its compartment. In the absence of the battery, the internal clock of the instrument continues to operate for at least 60 minutes. 4. Put the new pack in the compartment and press until it is firmly in place.
	<p>To ensure uninterrupted safety, replace the battery only by the original model. Do not use a battery with a damaged jacket.</p>

1.4.1. LITHIUM-ION technology

<p>The Li-ion technology has many advantages</p>	<ul style="list-style-type: none"> ▪ long life between charges with limited bulk and weight ▪ no memory effect: you can recharge the battery even if it is not fully discharged without reducing its capacity ▪ a very low self-discharge ▪ the possibility of recharging the battery rapidly ▪ protection of the environment, ensured by the absence of polluting materials such as lead and cadmium.
---	---

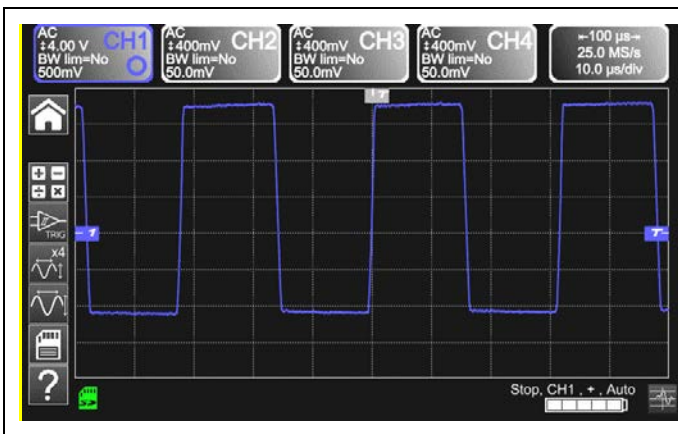

1.4.2. Charging the battery



Before the first use, start by fully charging the battery. It must be charged between 0 and 45°C. The instrument is designed so that it can operate with the charger connected.

The charger unit of the instrument comprises two elements: a power supply and a charger. The charger simultaneously manages the charging current, the battery voltage, and the battery's internal temperature. This optimizes charging while ensuring long battery life.

Display, in each mode, of the **5 charge levels** of the battery

<p>Before using your instrument, check its charge level: there is an indicator on the screen</p> 	<ul style="list-style-type: none"> ▪ If the LED of the charger is orange and it blinks → no battery or battery being charged. The LED lights green at the end of charging. ▪ If the battery level indicator displays fewer than three bars, start charging the instrument. Charging takes about five hours. After prolonged storage, the battery may be completely discharged. In this case, the first charge may take longer. If the instrument is likely not to be used for more than two months, remove the battery. To maintain its capacity, recharge it every 4 to 6 months.
<p>In order to extend the life of the battery</p>	<ul style="list-style-type: none"> ▪ Use only the charger provided with your instrument. Using another charger may be dangerous! ▪ Charge your instrument only between 0 and 45°C. ▪ Observe the conditions of use and of storage stated in this data sheet. ▪ If a prolonged period of non-use of the oscilloscope is anticipated, remove the battery and store it at close to room temperature.
<p>Battery dock External Li-Ion charging support P01102130 + label</p>	<ul style="list-style-type: none"> ▪ The charger is common to several Chauvin Arnoux group measuring instruments; the label of the PA40W-2 power supply bears the CHAUVIN ARNOUX logo. ▪ This PA40W-2 charger is compatible with the ScopiX. A set of labels is provided, should you wish to "personalize" the accessories of the ScopiX.
	<p>The spent batteries must not be treated as household wastes. Take them to the appropriate collection point for recycling.</p>

1.5. Isolation of the channels

ScopiX has 2 or 4 channels that are isolated not only with respect to each other but also with respect to earth (600V CAT III):

Diagram of the electronic structure of the **ScopiX**:

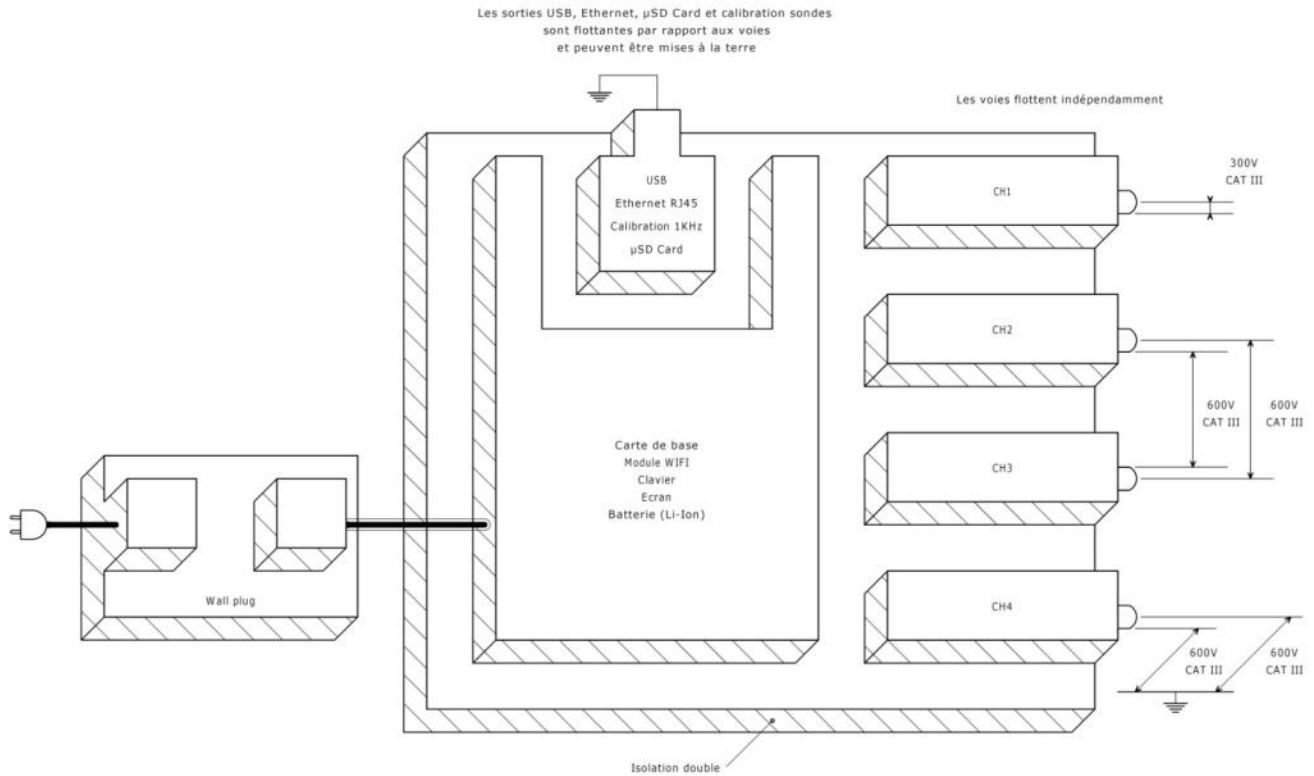

<p>Isolation of the frame grounds</p>	<ul style="list-style-type: none"> ■ Making measurements in systems where the circuits are sometimes at different potentials can be very dangerous. The danger comes either from undesirable short-circuits via the instrument or from the potentials themselves. ■ The process of digital isolation of the grounds uses the same input terminals and acquisition systems for the oscilloscope and multimeter modes, making it possible, in particular, to change from one instrument to the other without changing the measurement connection. ■ With the ScopiX with isolated channels, it is possible to observe the command signals of each phase of a three-phase chopper, and the output current, without recourse to artifices or complicated or even dangerous set-ups. ■ Thanks to the Probix accessories, the operator is informed at all times of the limits of the instrument (insulation voltage, rated maximum voltage): this is active safety.
--	--

1.6. Probix accessories

1.6.1. Probix concept



ScopiX uses **Probix** intelligent probes and sensors, which are recognized automatically when connected, giving the user active safety.

At the time of connection to an input of the oscilloscope, a safety message (in English) concerning the probe or sensor used indicates:

- its maximum input voltage as a function of the category
- its maximum voltage with respect to earth as a function of the category
- its maximum voltage between channels as a function of the category
- its type
- its elementary specifications
- the use of suitable safety leads.

For the safety of both the user and the instrument, this information must be heeded.

The trace colour of the signal measured with a given accessory is parameterized in the menu: "Green" → "chX" → "Probix". An interchangeable elastic or plastic ring is used to associate the colour of the probe and the colour of the curve. Scaling and units are managed automatically by the **Probix** system, allowing rapid measurements with no risk of error.

1.6.2. Rapid, error-free measurements

The **Probix** system ensures rapid and error-free setting up of the instrument, which is essential for instruments used for trouble-shooting. Standard BNC accessories and banana cords can always be connected using the safety adapters provided. An interchangeable plastic ring is used to match the colour of the accessory to the colour of its channel. The power supply, like the calibration of the sensors, is directly via the oscilloscope.

	(1)	(2)	(3)
Input:	Floating:	Between channels:	
CH1 HX34 - AC/DC Current 80 Apeak 1.5 % -3 dB@1 MHz 8 Amax@500 kHz	600 V CAT III 600 V CAT III	600 V CAT III	
CH2 HX31 - BNC Adapter >30 V CAT I, Use isolated rated BNC leads	300 V CAT III	600 V CAT III 600 V CAT III	600 V CAT III
CH3 HX31 - BNC Adapter >30 V CAT I, Use isolated rated BNC leads	300 V CAT III	600 V CAT III 600 V CAT III	600 V CAT III
CH4 HX30 - 1/10 Probe 250 MHz Bandwidth, +/- 1%(DCV)	300 V CAT III	600 V CAT III 600 V CAT III	600 V CAT III

Display of the:

- **max. input voltage (1) with respect to earth,**
- **floating voltage (2)**
- **voltage between channels (3)**

according to the installation category, the type or reference of the sensor, and a designation of the main characteristics.

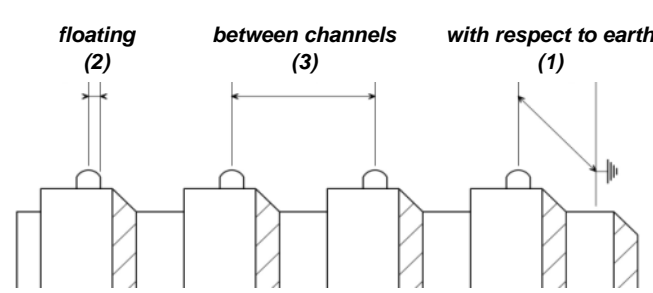

1.6.3. Auto scale

Some **Probix** probes have buttons, the assignments of which can be programmed:

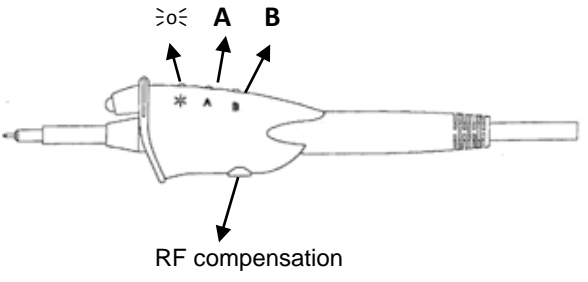
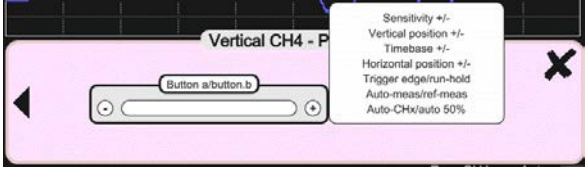
 <p>The diagram shows a probe with three buttons labeled A, B, and RF compensation. Arrows point from the labels to the respective buttons on the probe's body.</p>	<p>The HX0030 probe has three directly accessible control buttons:</p> <ul style="list-style-type: none"> ■ Button A (programmable): modification of the settings of the channel to which it is connected ■ Button B (programmable): modification of the settings of the channel to which it is connected ■ Button controlling the backlighting of the measurement zone.
 <p>The screenshot shows a menu for 'Vertical CH4 - P' with a list of settings: Sensitivity +/-, Vertical position +/-, Timebase +/-, Horizontal position +/-, Trigger edge/run-hold, Auto-meas/ref-meas, and Auto-CHx/auto 50%. A 'Button a/button b' option is also visible.</p>	<p>At the time of connection, all preferred settings stored in the accessories (assignments of buttons A and B + colour) are automatically reactivated. They can be modified by pressing the zone shown opposite.</p> <p><u>Configuring the channels and managing the sensors</u> The coefficients, scales, and units of the sensors and the configurations of the channels are managed automatically.</p>

1.6.4. Safety message

<p>Identification of the accessories and management of safety</p>	<p>In a kind of "plug and play" in measurement, the probes and sensors are immediately recognized once connected. The instrument does not just identify them; it provides information about their characteristics.</p> <p>Active safety is built in, in particular, in the form of safety information and recommendations concerning the accessory used.</p>
--	--

1.6.5. Power supply to the accessories

The oscilloscope supplies power to the **Probix** accessories.

2. DESCRIPTION OF THE INSTRUMENT

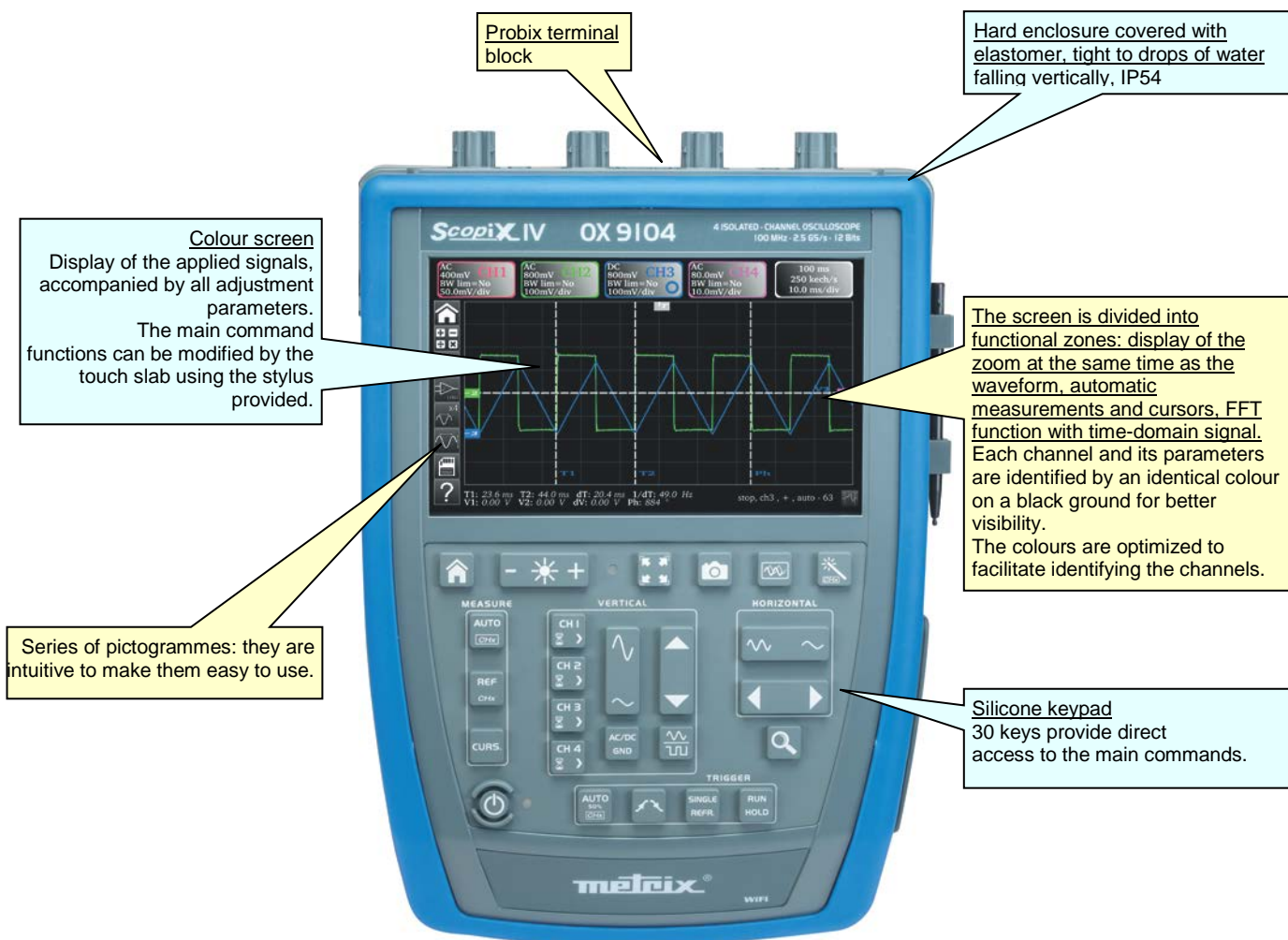

2.1. Front panel

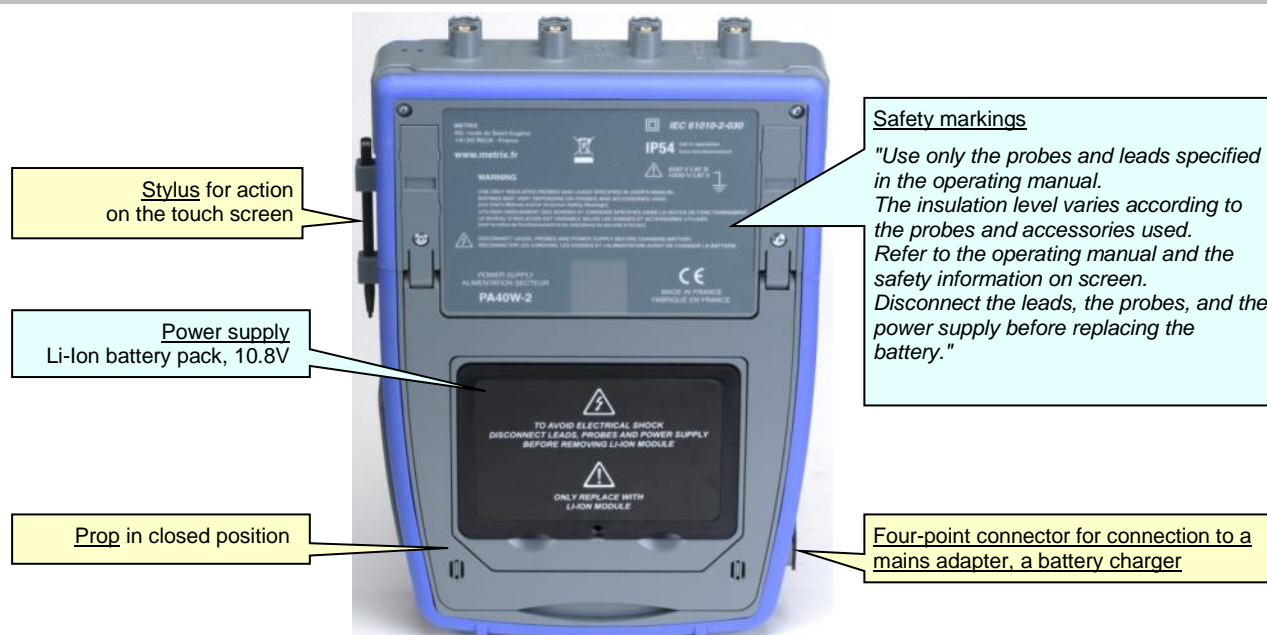

2.2. Rear panel



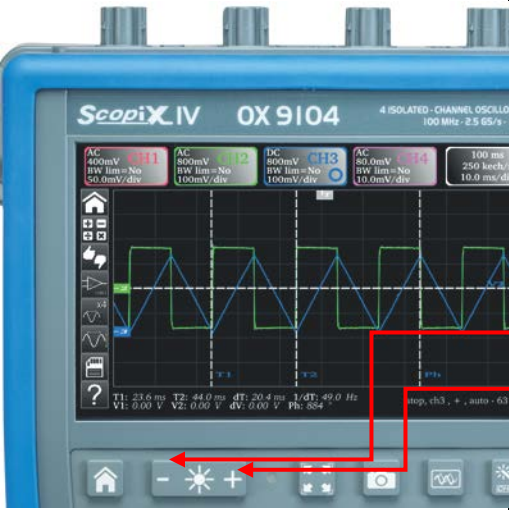



2.3. Touch screen and stylus

<p>Display</p>		<p>Colour screen:</p> <ul style="list-style-type: none"> ■ LCD WVGA ■ (800x480) ■ 7 inch ■ TFT ■ resistive, colour, touch operated (can be used with protective gloves) ■ Backlighting by LEDs ■ <u>Brightness</u> adjustable by the key on the keypad and <u>Lux sensor</u>: automatically adjusts the brightness to suit the environment of use
<p>Calibrating the touch screen</p> 	<p>The touch screen can be calibrated from the home window by pressing the key on the keypad shown opposite.</p>	

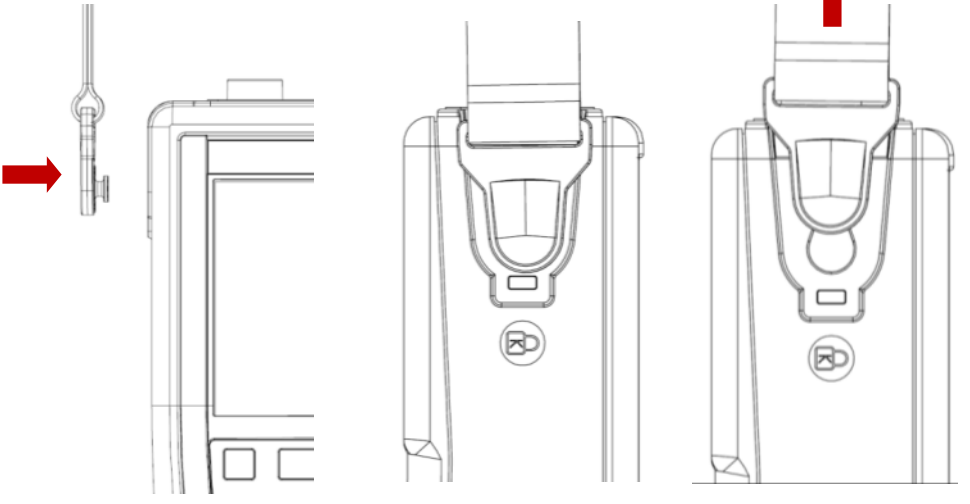
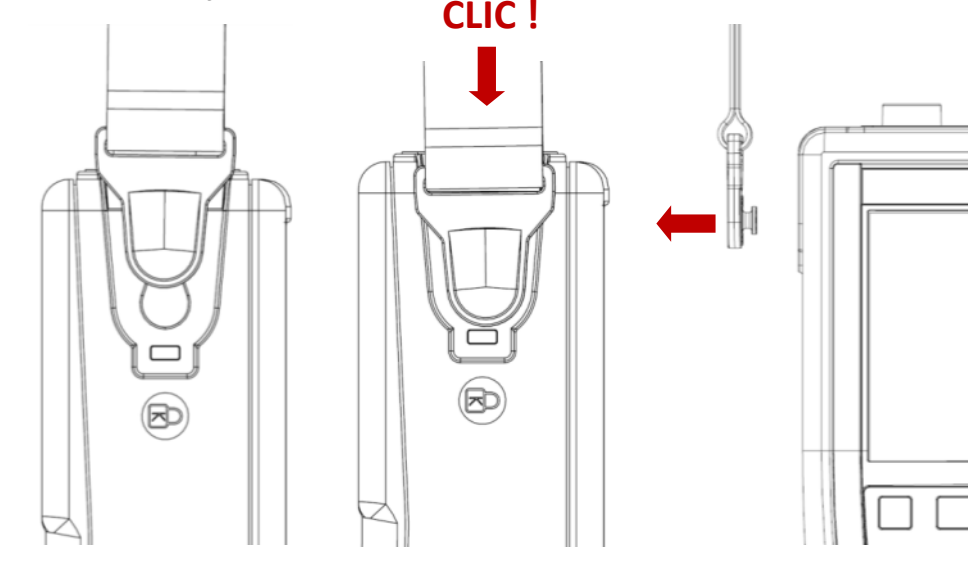

- The screen:
 - touch-operated
 - colour
 - water- and dust-resistant
 - responds positively to any form of pressure by any pointing resource, such as a stylus, a nail, a bare or gloved hand.
- Intuitive pictograms have been created to make it easy to use.
- Each channel and its parameters are identified by an identical colour on a black ground for better legibility.
- The colours are optimized to facilitate identifying the channels.
- The screen is partitioned according to the functions selected:
 - display of the zoom at the same time as the waveform,
 - automatic measurements and cursors,
 - FFT function and time-domain signal

2.4. Accessories

<p><i>HX0122 strap with self-sticking tape, to carry in your hand or on your shoulder</i></p>	<p>Attaching the strap (length adjustable from 42 to 60cm) to the instrument:</p> <p>1. Fitting the strap:</p> 
	<p>2. Removing the strap:</p> 
<p><i>Stand providing an angle of 40°</i></p>	

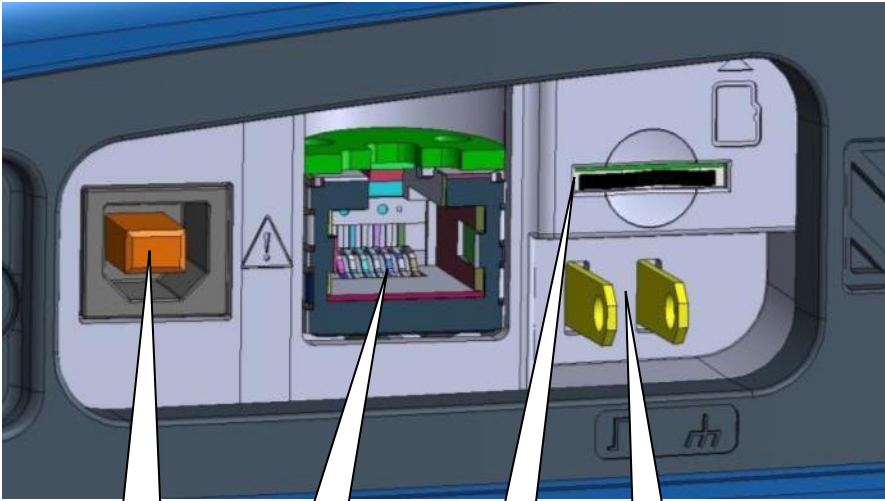

<p>HX0120 carrying case</p>	<p>The carrying/protection case includes:</p> <ul style="list-style-type: none"> ■ 1 waterproof all-terrain bottom ■ 2 handles ■ 1 shoulder strap ■ 1 removable interior compartment with 3 stowage areas: <ul style="list-style-type: none"> - 1 central compartment with a plasticized pouch for the ScopiX, - 2 side pockets with 2 modulable self-adhesive separators for stowing the accessories. 	
<p>HX0121 stylus</p>		<p>The stylus is stowed in the stylus holder on the side of the instrument.</p>
		<p>The stylus has an eyelet. A nylon thread can be passed through it to secure the stylus to the terminal block: 2 holes, with a thread guide between them, are provided for this purpose.</p>

2.5. Communication interfaces

<p>Communication interfaces</p>		<p>These are grouped in a specialized space on the right side of the oscilloscope and protected by a plug that must be lifted off to reach them.</p>
	 <div style="display: flex; justify-content: space-around; margin-top: 10px;"> <div data-bbox="555 1016 721 1144"> <p>USB connector (USB Type B, 12Mb/s)</p> </div> <div data-bbox="746 1016 906 1144"> <p>RJ45 Ethernet connector (10/100 BASE-T)</p> </div> <div data-bbox="954 1016 1091 1144"> <p>MicroSD card (SD, SDHC, SDXC)</p> </div> <div data-bbox="1145 1016 1283 1144"> <p>Probe calibration lugs</p> </div> </div>	
	<ul style="list-style-type: none"> ▪ Type B USB (peripheral) for communication with a PC ▪ RJ45 Ethernet wired peripheral ▪ WiFi (default state is inactive) for communication with a PC or with a network printer ▪ High-capacity μSD for data storage <p>On the screen, an icon in three colours  refreshed every 5 minutes, indicates the presence and occupation rate of the SDcard or of the internal memory.</p> <p><i>The general configuration of the communication interfaces appears under the icon shown opposite; as default, the WiFi link is inactive.</i></p>	
<p>Type of communication</p>	<ul style="list-style-type: none"> ▪ Hard-wired ETHERNET LAN network (manual/automatic configuration) ▪ Possibility of activating the radio WiFi link to communicate with a PC or, in an Android environment, with a tablet or a smartphone ▪ Type B USB to connect a PC and exchange files or control the instrument 	

3. GETTING STARTED

3.1 General principles

- The dialogue boxes are displayed at the bottom of the screen. They do not overlap the space set aside for the curves, and so leave an unobstructed view of the user's action on the channel. Only the adjustments that concern this curve remain displayed. However, in some rare cases, a virtual keypad must be used: this keypad appears in the centre of the screen and so covers the space of the curves.
- The dialogue box opened is erased by clicking the  button at top right in the dialogue window.
- A change made to a parameter of a dialogue window takes effect immediately and modifies the curves, with no prior confirmation.
- The multilingual online help (common to all modes) can be accessed using the  icon of the screen. It explains the keys of the keypad: *pressing any key of the keypad displays the help menu of the key pressed, without starting the function associated with the key.* The name and icon of the key are displayed above the explanation. To exit from the online help function, point the stylus to the help window.
- The operating mode is multilingual, but the screen shots illustrating this data sheet are in English.

3.2 "ON/ OFF" key

	<ul style="list-style-type: none"> ▪ Pressing this key switches the instrument on → the orange LED lights. ▪ A short press switches the instrument to standby → the orange LED blinks. ▪ A long press saves the configuration and switches the instrument off.
---	---



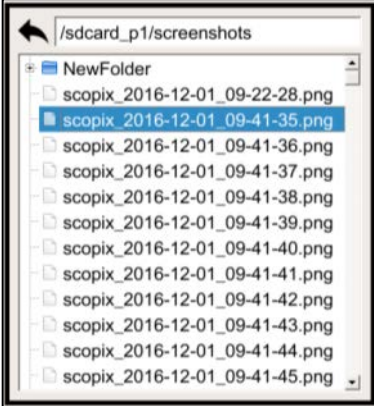



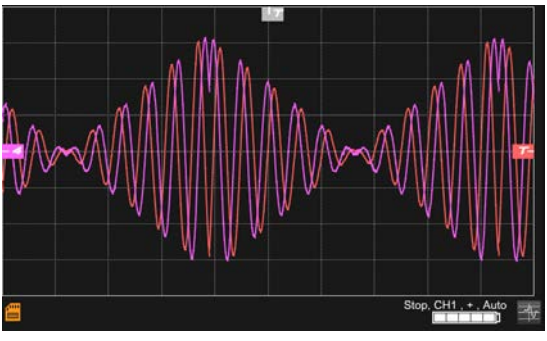

3.3 "Screenshot" key

	<p>Producing screen shots in the "Screenshot" folder.</p> <p>It is accessible in the following modes:</p> <ul style="list-style-type: none"> - oscilloscope - multimeter - logger - harmonic analyzer <p>The files are named: SCOPIX_date_hour-minute-second.png in the internal memory or on the connected µSD.</p>	
---	--	---



3.4 "Full Screen" key

	<p>This key toggles the display mode between normal and "full screen".</p> <p>The screen is organized for leave the optimal area for the traces of the curves.</p> <p>Blanking:</p> <ul style="list-style-type: none"> ▪ of the menu bar ▪ of the parameters of the time base traces ▪ of the bargraph <p>from the home screen, this key allows calibration of the touch screen.</p>	
---	---	--

3.5 "HOME" key and icon

If ↗	Then ↗	(on the screen) ↗
you press the "HOME" key of the keypad 	<ul style="list-style-type: none"> you return to the home screen from your measurement session 	
	<ul style="list-style-type: none"> you directly access the instrument's various operating modes: <ul style="list-style-type: none"> - oscilloscope → - multimeter → - LOGGER → - harmonic analyzer → - Bus → 	
	<ul style="list-style-type: none"> you access the internal file management system and the SDCard (a file contains a saved object). 	 → <ul style="list-style-type: none"> functions harmonic logger NewFolder screenshots sdcard_p1 setups traces
	<ul style="list-style-type: none"> you access the system parameters: <ul style="list-style-type: none"> - setting of the time and language - WiFi, - network, - printing 	 → 
	<ul style="list-style-type: none"> you access the following information: <ul style="list-style-type: none"> - serial number of the instrument - hardware version - software version - texts of the licences of the various embedded software modules (GPL, GPL2, LGPL) 	
you click the "HOME" icon on the screen 	<ul style="list-style-type: none"> you go straight back to the home screen, at any time during your browsing. 	

3.6 Brightness key

	<p>This key adjusts the brightness of the screen (LED backlighting):</p> <ul style="list-style-type: none"> min. level → 0% max. level → 100% <p>It is possible to adjust the brightness according to your exposure:</p> <ul style="list-style-type: none"> lower → press "-" higher → press "+" <p>The available steps are 25%, 37%, 50%, 62%, 75%, 87%, 100%.</p> <p>Note : Brightness adjusted automatically until the key is pressed </p>
---	---

4. FUNCTIONAL DESCRIPTION OF OX 9304

4.1 SCOPE mode

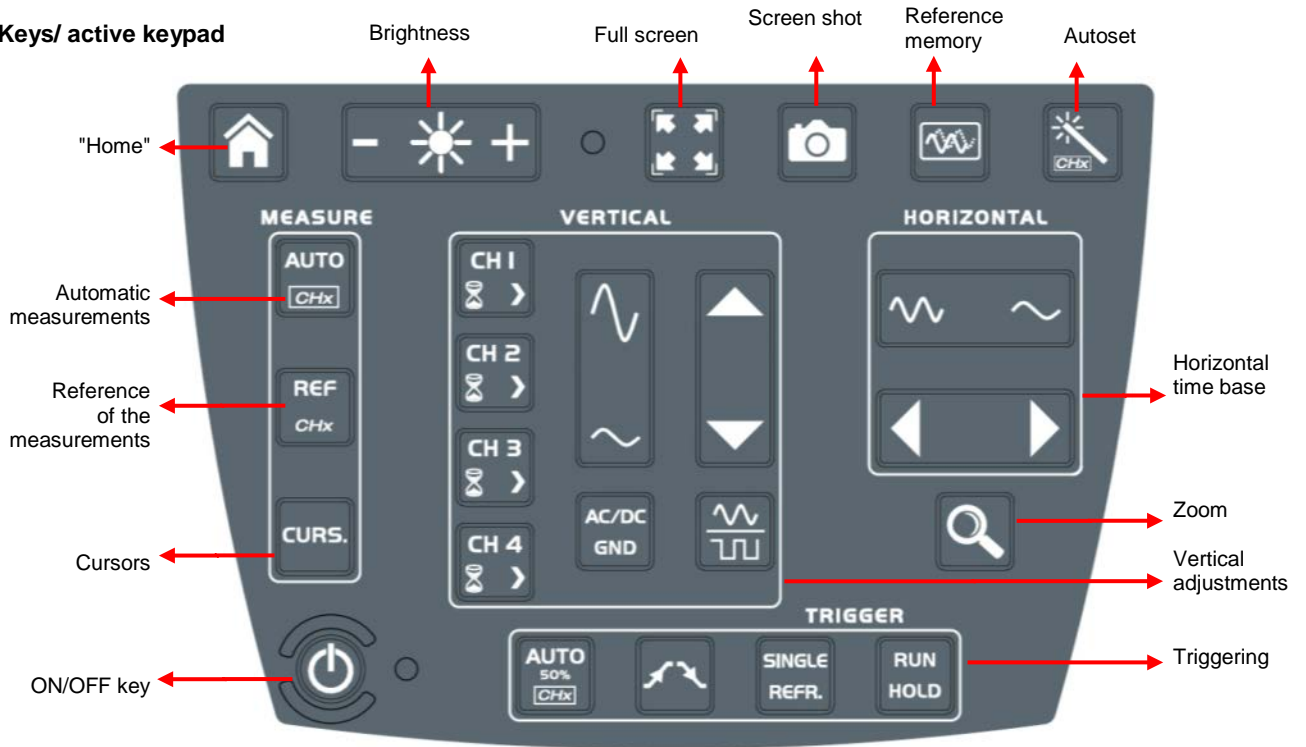

4.1.1 Keys/ active keypad



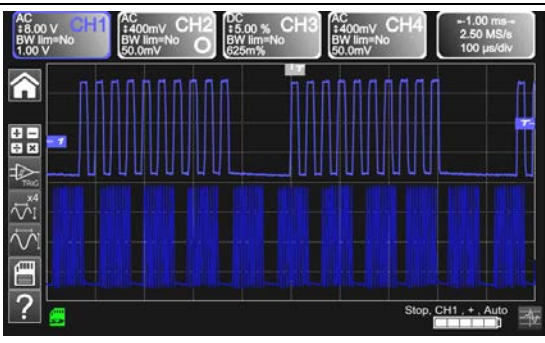



4.1.2 Adjustment of the "Reference Memory" from the keypad

	<p>In oscilloscope mode, pressing this key freezes the traces on the screen; the curve is displayed in the channel colour, but darker, as reference to be compared to a new acquisition. The reference memories are accompanied by their reference numbers. Pressing again erases them: they are lost.</p> <p>This memory is not saved and will be lost when you exit the Oscilloscope mode.</p>	
---	---	--

4.1.3 Adjusting the AUTOSET from the keypad → "Magic Wand" key

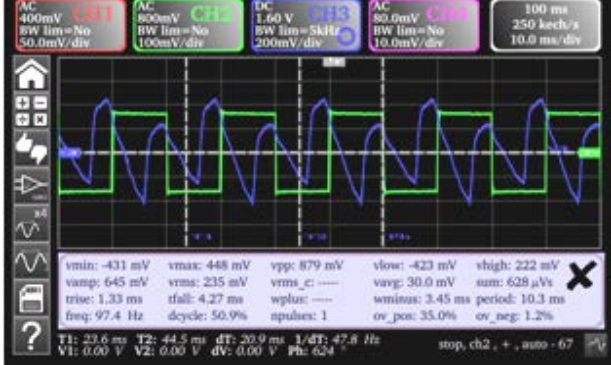

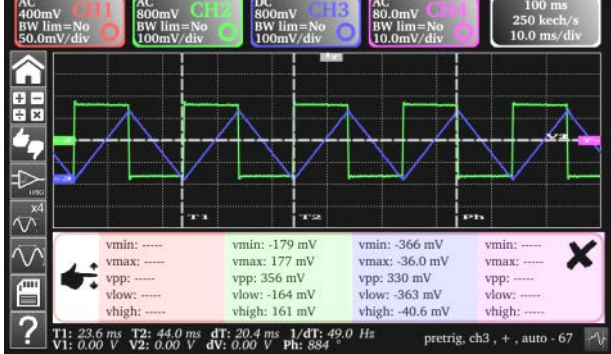
	<p>Automatic optimum adjustment of the AUTOSET of the channels to which a signal is applied. The adjustments concerned are:</p> <ul style="list-style-type: none"> ▪ the coupling ▪ the vertical sensitivity ▪ the time base ▪ the slope ▪ the positions ▪ the triggering. <p>The signal having the lowest frequency is used as triggering source. If no trace is detected on the inputs, autaset is aborted.</p> <p>A simultaneous press on  +  assigns the corresponding channel as triggering source.</p>
---	--

4.1.4 Display of the measurement principles ("MEASURE") from the keypad



	<p>Activates or deactivates display of the window of the 20 automatic measurements of the reference trace.</p>	
	<p>Activates the 20 automatic measurements of the 4 traces with displacement by "scrolling".</p> <p><i>As default, the cursors are activated with the automatic measurements.</i></p>	
	<p>Selects, from among the traces displayed, the reference trace for the automatic and manual measurements; the reference channel is identified by a circle in the colour of the channel in the CHx or Fx zone.</p>	
	<p>Activates or deactivates display of the cursors of the manual measurements.</p> <p><i>In automatic measurement, the cursors cannot be deactivated.</i></p> <p>The vertical and horizontal cursors can be moved on the touch pad using the stylus.</p> <p>The measurements made in position T (period), "dt" (time difference between the two cursors), 1/dt (difference as a frequency, in Hz) and "dv" (voltage difference between the 2 cursors) are reported in the status area. A phase cursor Ph (in °) proposes a value for the angle between T and the reference.</p>	

4.1.5 Adjusting the "HORIZONTAL" time base

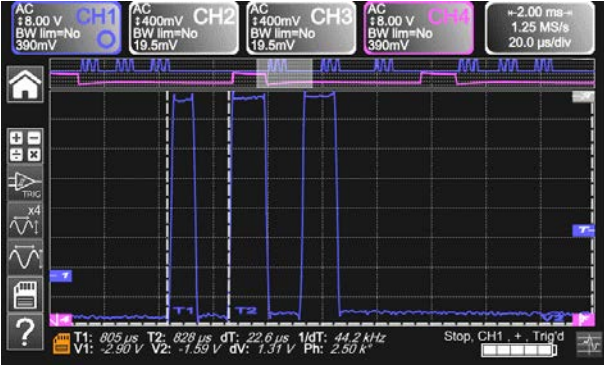
a) from the keypad

	<p>Increases/ decreases the coefficient of the time base by successive presses (T/DIV).</p>	
	<p>After a Zoom, the "Z-Pos." adjustment modifies the position of the screen in the acquisition memory (upper part of the screen).</p>	
	<p>Activates or deactivates the horizontal "Zoom" function</p> <p>A waveform screen is displayed at the top of the screen, with the zoomed portion in the main zone.</p> <p>As default, the zoom is around samples at the centre of the screen, but the zone can be moved.</p> <p>A zone can be zoomed by tracing a rectangle around the zone to be enlarged using the stylus on the touch pad.</p> <p>The sensitivity values, time base, and horizontal and vertical positions are recalculated automatically.</p>	

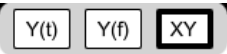
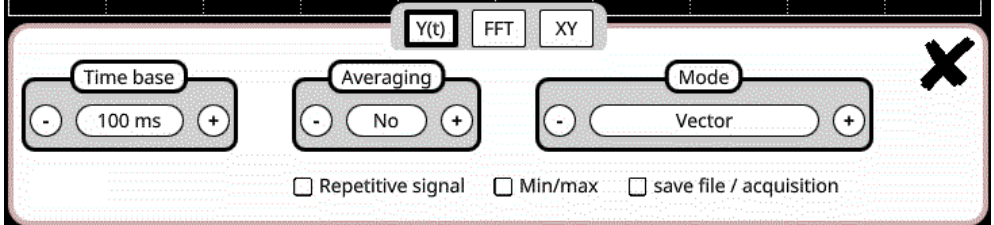
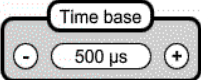
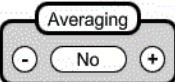
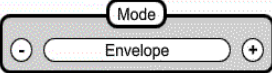
b) from the screen

	<p>Click at top right in the screen, on the Time Base zone (see opposite).</p>	
	<p>Description below of the Y(t) - Y(f) - XY display modes</p>	
<p>1. Y(t): temporal view of a waveform</p>		
	<p>Settings from 1ns to 200s</p>	
	<p>No averaging Averaging coeff. 2 Averaging coeff. 4 Averaging coeff. 16 Averaging coeff. 64</p>	<p>Selection of a coefficient in order to calculate an average on the samples displayed: this can be used for example to attenuate the random noise observed in a signal. For the averaging coefficient to be taken into account in the representation of the signal, the "Repetitive signal" option must be selected. The calculation is done using the following formula: $\text{Pixel N} = \frac{\text{Sample} * 1}{\text{Averaging rate}} + \text{Pixel N-1}$ (1-1/Averaging rate): Sample Value of the new sample acquired at abscissa t Pixel N Ordinate of the pixel at abscissa t on the screen, at instant N Pixel N-1 Ordinate of the pixel at abscissa t on the screen, at instant N-1</p>
	<p>Vector Envelope The entire acquisition</p>	<p>A vector is plotted between samples. The minimum and maximum observed at each horizontal position on the screen are displayed. Use this mode to display a variation in time or of amplitude, or a modulation. The whole of the acquisition (100,000 samples) is displayed on the screen and a vector is plotted between samples. Use this mode to display all details of the acquisition. This function can be used on a memory or on a curve already acquired.</p>
	<p>Increased time resolution of a trace for a periodic signal. If this option is checked, the signal can be averaged.</p> <ul style="list-style-type: none"> For time bases finer than 100μs/div. (without active zoom mode), the signal displayed is reconstituted from several acquisitions. The time resolution can be as fine as 40ps. If the signal is not repetitive, do use not this option. The time resolution will then be ±1ns. <p>If this choice is checked, reconstruction of the signal can take a rather long time. The following parameters influence this time:</p> <ul style="list-style-type: none"> the time base the frequency of recurrence of the trigger the activity of the Averaging mode <p>During this reconstruction, the signal must be stable (amplitude, frequency, waveform). To speed up the reconstruction following a change in the signal, stop the acquisition, then restart: Stop/Run.</p>	

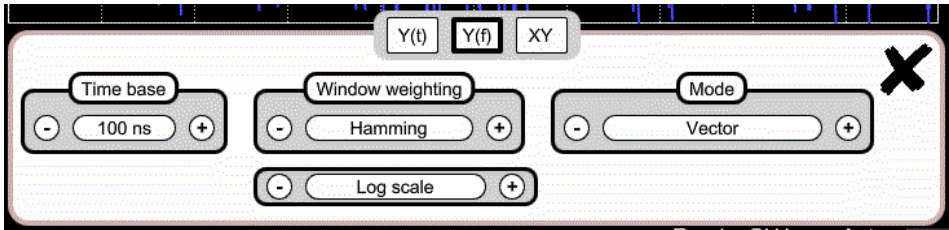

<input type="checkbox"/> Min/max	<p>Use this mode to display extreme values of the signal, acquired between two samples of the acquisition memory.</p> <p>This mode is used:</p> <ul style="list-style-type: none"> to detect a false representation due to undersampling to display events having a short duration (Glitch, $\leq 2\text{ns}$). <p>Whatever time base is used, with its corresponding sampling rate, events having a short duration (Glitch, $\leq 2\text{ns}$) are displayed.</p>
	<p>ROLL : Automatic on time base $> 100\text{ms}$, single</p> <p>In single-shot mode, if the time base exceeds 100ms/div, the new samples are displayed as soon as they are acquired and the ROLL mode is activated when the acquisition memory is full (scrolling of the trace from right to left on the screen).</p>
<input type="checkbox"/> save file / acquisition	<p>In triggered mode, save/retrieve can be used to record acquisitions in .trc format. to the "Traces" directory</p> <p>This lets you store several rare events in the file system and analyse them later.</p>

<p>2. $Y(f) = \text{FFT}$ (Fast Fourier Transform)</p>	 <p>The Fast Fourier Transform (FFT) is used to calculate the discrete representation of a signal in the frequency domain from its discrete representation in the time domain. It is calculated on 2500 points. It can be used in the following applications:</p> <ul style="list-style-type: none"> measurement of the various harmonics and of the distortion of a signal, analysis of a pulse response, the search for a noise source in logical circuits.
<p>The Fast Fourier Transform is calculated using the formula</p>	$X(k) = \frac{1}{N} * \sum_{n=-\frac{N}{2}}^{\frac{N}{2}-1} x(n) * \exp\left(-j \frac{2\pi nk}{N}\right) \text{ for } k \in [0 (N-1)]$ <p> $x(n)$: a sample in the time domain $X(k)$: a sample in the frequency domain N: resolution of the FFT n: time-domain index k: frequency index </p>

Fenêtre de pondération
-
+
Hamming

- Rectangle
- Hamming
- Hanning
- Blackman
- Flat top

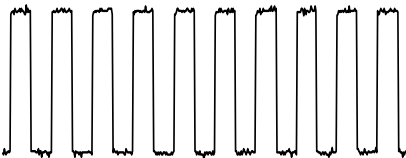
Before calculating the FFT, the oscilloscope weights the signal to be analyzed by a window that acts as a bandpass filter. The choice of type of window is essential to distinguish the different spikes of a signal and make accurate measurements.

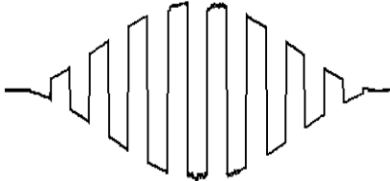
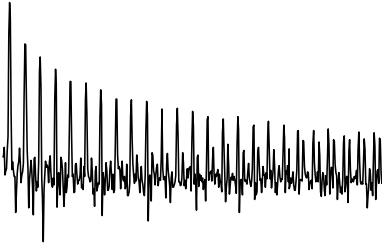



<i>Time representation of the signal to be analyzed</i>	
<i>Weighting window</i>	
<i>Weighted signal</i>	
<i>Frequency representation of the signal calculated by FFT</i>	

The total duration of the study interval results in a convolution in the frequency domain of the signal with a function sinc/x . This convolution modifies the graphic representation of the FFT because of the characteristic lateral lobes of the sinc/x function (unless the study interval contains an integral number of periods). Five weighting windows are proposed: the menus appear directly upon selection of the FFT menu.

Type of window	Width of the main lobe at 3dB down (bin)	Max. amplitude of the secondary lobe (dB)
rectangular	0.88	-13
Hamming	1.30	-31
Hanning	1.44	-43
Blackman	1.64	-58
Flat top	3.72	-93

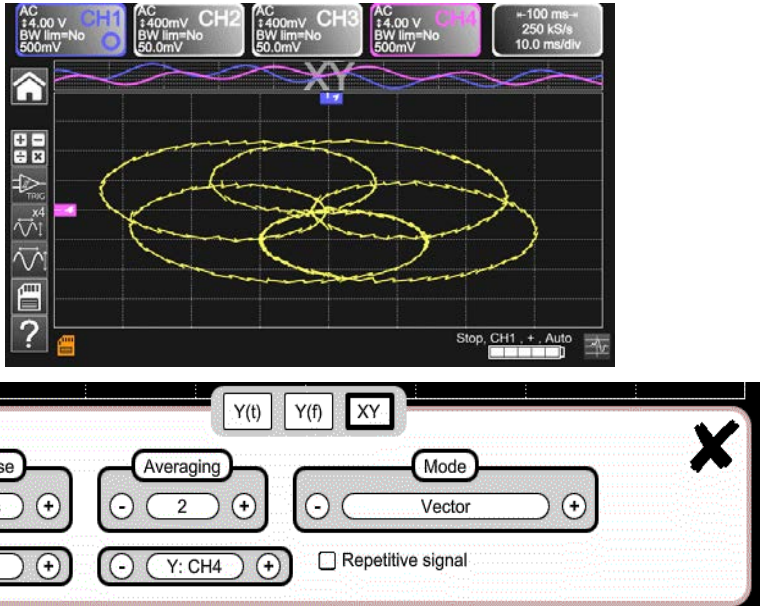
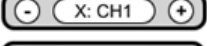

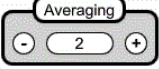
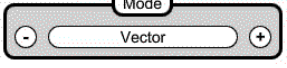
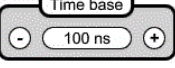

Effects of undersampling on the frequency representation:
 If the sampling frequency is too low (less than the twice the cutoff frequency of the signal to be measured), the high-frequency components are undersampled and are aliased (frequency-shifted) in the graphic representation of the FFT.
 The "Autoset" function is active. It serves to avoid the above phenomenon and adapt the horizontal scale: the representation is easier to read.
 The "Zoom" function is active. The zoom affects the graphic representation of the FFT but does not change the conditions of acquisition (TB + depth).

	<p>Horizontal unit: This is indicated in place of the time base and is calculated from the sweep coefficient:</p> $\text{Unit in } \left(\frac{\text{Hz}}{\text{div}}\right) = \frac{12.5}{\text{Sweep coefficient}}$ <p>Vertical unit: The sub-menus propose two possibilities:</p> <p>a) Linear scale: by selecting the FFT menu, then linear scale in (V/div) = $\frac{\text{unit of the signal in its time-domain representation (V/div)}}{2}$</p> <p>b) Log scale: by selecting the FFT menu, then log (logarithmic) scale dB/div. = by assigning 0dB to a signal of 1 RMS amplitude division in the time representation</p> <p><i>The vertical position indicator of the representation is at -40dB.</i></p>
---	---

<p>3. XY</p>	
 	<p>Assignment of the signals to the horizontal (X) axis and vertical (Y) axis. Selection by "+/-". Each axis is graduated in 8 divisions.</p>
	<p>No, 2, 4, 16, 64</p>
	<p>Vector, Envelope, Entire acquisition</p>
	<p>Settings from 1ns to 200s</p>
	<p>Increases the time resolution of a trace for a periodic signal</p>





4.1.6 Adjustment of the amplitude of the "VERTICAL" signal

a) from the keypad

	<ul style="list-style-type: none"> ▪ Selection of the channel ▪ Activation of the channel ▪ De-activation of the channel
	<p>Adjustment of the vertical sensitivity of the last channel selected:</p> <ul style="list-style-type: none"> ▪ Increases the vertical sensitivity ▪ Decreases the vertical sensitivity <p><i>The sensitivity is indicated in the zone displaying the parameters of the channel. It takes account of the parameters of the "Vertical scale" menu.</i></p>
	<p>Adjustment of the position of the selected curve on the screen:</p> <ul style="list-style-type: none"> ▪ Move up ▪ Move down
	<p>Selection by successive presses on the input coupling, "AC", "DC" or "GND", of the last channel selected</p> <p><u>Modification of the coupling AC - DC - GND:</u></p> <ul style="list-style-type: none"> ▪ AC → blocks the DC component of the input signal, attenuates signals below 10Hz. ▪ DC → transmits the DC and AC components of the input signal. ▪ GND → the instrument internally connects the input of the selected channel to a reference level of 0V.
	<p>activates or deactivates the horizontal division by 4 of the display zone.</p> <p>Activation of the "Full Trace" function is indicated by:</p> <ul style="list-style-type: none"> ▪ the presence of a continuous horizontal line between the display zones ▪ horizontal division of the graticule by 2. <p>After activation of the function, the traces can be moved vertically in their zones.</p>

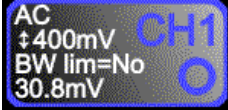
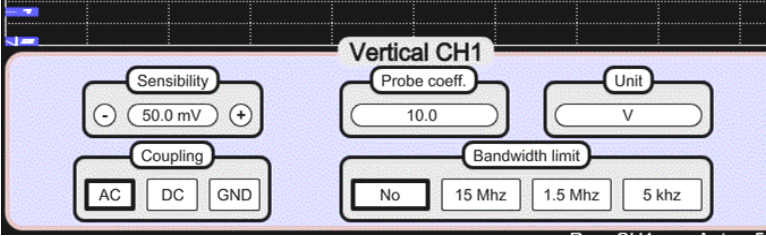
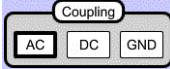

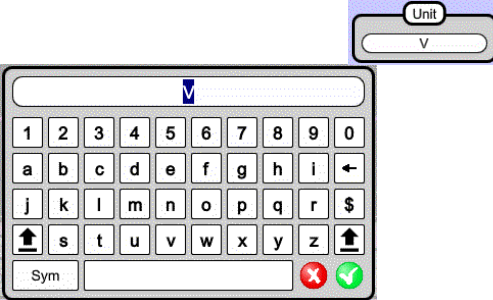

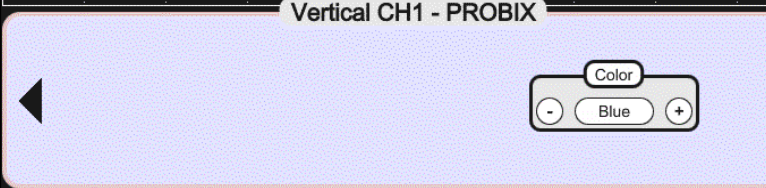

b) from the screen











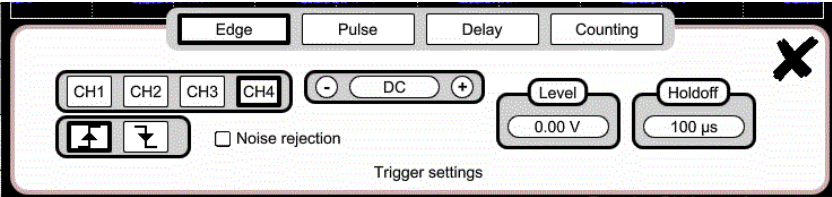
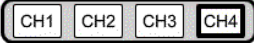



 <p><i>Example:</i></p>	<p>defines the vertical scale of the channel selected from the current settings.</p> <p>This yields a reading of the direct measurements of the quantity analyzed and of its unit.</p>
	
	<p>Coupling: AC → AC DC → DC GND → GND</p>
	<p>Coefficient: Assignment of a multiplier coefficient to the sensitivity of the selected channel using the stylus, on the digital keypad of the "Coefficient" zone.</p> <p>Validation by .</p> <p>The sensitivity indicated in the display of the parameters of the channel will be modified as a function of this coefficient.</p>
	<p>Unit of measurement: Modification of the unit of the vertical scale of the selected channel using the stylus in the table of usable characters (not more than 3) after the "measurement unit" zone has been chosen.</p> <p>The unit of the vertical scale will be indicated in the display of the parameters of the modified channel.</p>
	<p>Bandwidth limit, 3 filters can be selected: 15MHz, 1.5MHz and 5kHz</p> <p><i><u>BX limit is adjusted only from the adjustment menu of the channel, by clicking it with the stylus</u></i></p> <p>Limitation of the bandwidth of the channel and of its triggering circuit, to moderate display noise and spurious triggerings.</p> <p>The bandwidth of each channel can be limited to 5kHz, 1.5MHz, or 15MHz.</p> <p>The limitation of the bandwidth of a channel is indicated in the command zone by the parameter BW limit.</p>
<p><u>Selection of the colour:</u></p> <ul style="list-style-type: none"> - <u>red</u> - <u>green</u> - <u>magenta</u> - <u>blue</u> 	

4.1.7. Adjustment of the triggering level, "TRIGGER",

a) from the keypad

	<p>Adjustment of the triggering level on the mean value of the signal (50%) without modifying the coupling of the trigger. A press combined with a CHx key starts the same function, but first selects the corresponding channel as triggering source</p>
	<p>Selection, by successive presses, of the triggering slope (positive or negative). The slope is indicated in the status zone.</p>
	<p>Selection, by successive presses, of one of the following acquisition modes:</p> <ul style="list-style-type: none"> ▪ Single-shot = SINGLE (sgl)" on the screen, ▪ Triggered (trig'd) ▪ Automatic (Auto) = REFRESH
	<ul style="list-style-type: none"> ▪ "SINGLE-SHOT" mode: A single acquisition triggered by the trigger by pressing the RUN HOLD key is allowed. For another acquisition, the triggering circuit must be reset by pressing the RUN HOLD key. <i>The ROLL mode is automatically activated.</i> ▪ "TRIGGERED" mode: The content of the screen is updated only in the presence of a triggering event linked to the signals present on the inputs of the oscilloscope (CH1, CH2, CH3, CH4). <i>In the absence of any triggering event linked to the signals present on the inputs (or in the absence of signals on the inputs), the trace is not updated.</i> ▪ "AUTOMATIC" mode: The content of the screen is updated even if the triggering level is not detected in the signals on the inputs. <i>In the presence of a triggering event, the refreshing of the screen is managed as in the "Triggered" mode.</i> ▪ Acquisitions in the "TRIGGERED" and "AUTOMATIC" modes are enabled or stopped. ▪ The triggering circuit in the "SINGLE-SHOT" mode is reset. ▪ Acquisition is started according to the conditions defined by the acquisition mode (SINGLE REFR). ▪ The status of the acquisition is indicated in the status zone: <ul style="list-style-type: none"> ▪ RUNNING → started ▪ STOP → stopped ▪ PRETRIG → acquisition

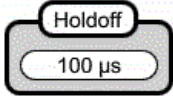
b) from the screen





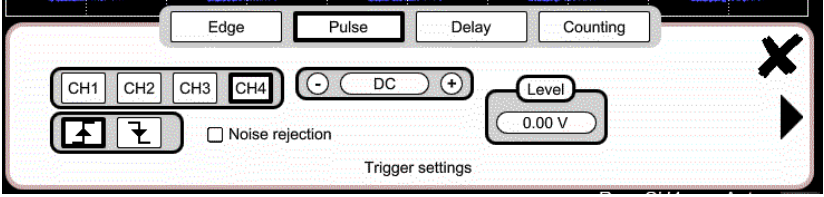

<p>1. Edge </p>	
	<p>Selection of a channel as triggering source  E.g. CH4 → Triggering source</p>
	<p>Selection of the filter of the main triggering source:</p> <p>AC AC coupling (10Hz to 300MHz): blocks the DC component of the signal.</p> <p>DC DC coupling (0 to 300MHz): passes the whole signal.</p> <p>LF Reject Rejection of source signal frequencies < 10kHz: facilitates the observation of signals having a DC component or an undesirable low frequency.</p> <p>HF Reject Rejection of source signal frequencies >10kHz: facilitates the observation of signals containing high-frequency noise.</p> <p>The symbol used to indicate the triggering level on the curve also indicates the coupling:</p> <p> DC</p> <p> AC</p> <p> LF Reject</p> <p> HF Reject</p>
	<p>Selection of the triggering slope:</p> <ul style="list-style-type: none"> ▪ positive-going triggering slope Rise edge +  ▪ negative-going triggering slope Fall edge -  <p>The triggering slope selected is indicated in the status zone.</p>
	<p> 0.00V Adjustment of the triggering level</p> <p><i>The triggering level is indicated in the zone displaying the current value, after modification. It can be adjusted finely.</i></p>
	<p>No Hysteresis ≈ 0.5 div.</p> <p>Yes Hysteresis ≈ 1.5 div.</p>
	<p> 100 µs:</p> <ul style="list-style-type: none"> ▪ disables triggering for a preset duration ▪ stabilizes triggering on pulse trains. <p>Pointing to this field opens on screen a virtual digital keypad for direct entry of the value.</p>

2. Pulse Pulse

Selection of triggering on pulse width:



The edge is selected either in the "Trigger" tab or from the keypad and defines the limits of the analysis:

 edge defines a pulse between  and 
 edge defines a pulse between  and 

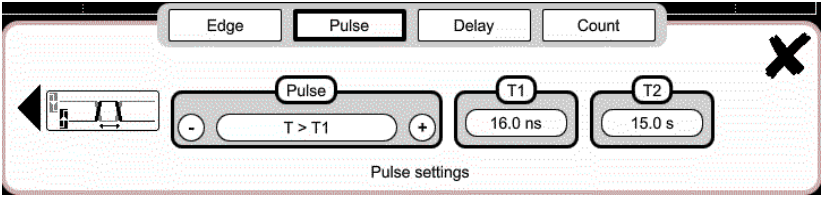

In all cases, the actual triggering is on the end-of-pulse edge:

$t > T1$	triggers on a pulse, if its duration is greater than setpoint T1
$t < T1$	triggers on a pulse, if its duration is less than setpoint T1
$t > T1$ and $t < T2$	triggers on a pulse, if its duration is between T1 and T2
$t < T1$ or $t > T2$	triggers on a pulse, if its duration is outside the limits defined by T1 and T2

3. Delay Delay

Qualifier

Adjustments on the qualification source:

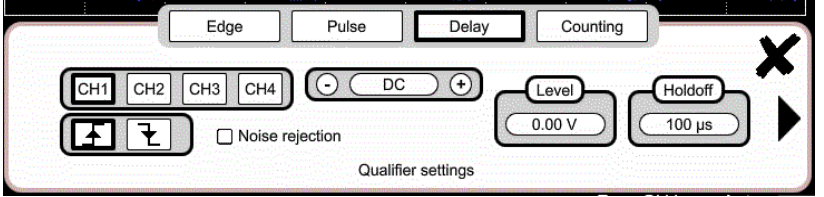



Level
0.00 V 0.00 V Triggering level

Holdoff
100 µs 100 µs Adjustment: used to disable triggering for a preset duration and, among other things, stabilize triggering on pulse trains.

Pointing to this field opens on the screen a virtual **digital keypad** for direct entry of the value →

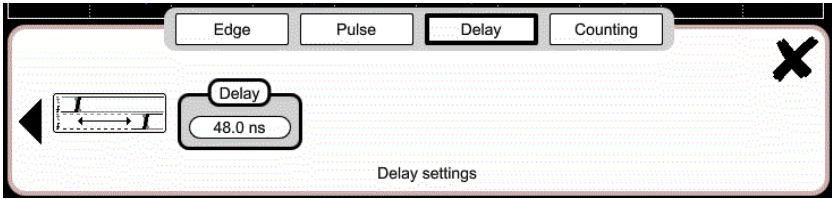
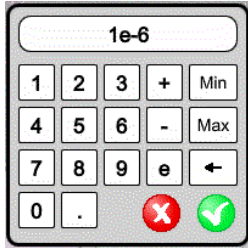
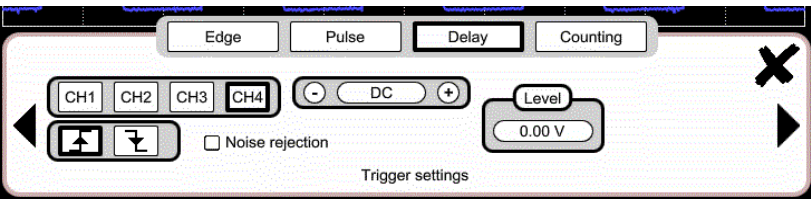



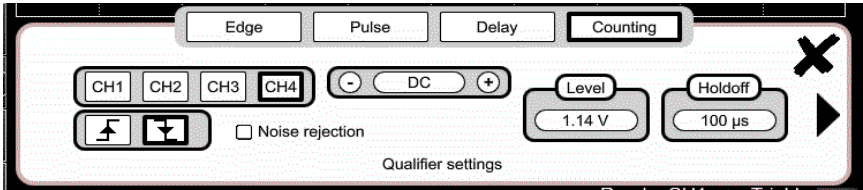
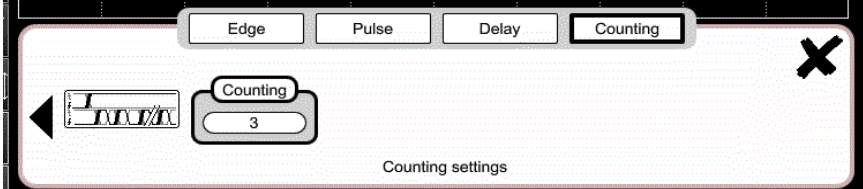
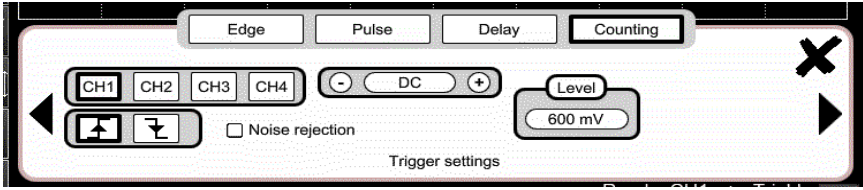

<p><u>Triggering delay</u></p>	<p>Selection of the desired delay:</p>  <p>Pointing to this field opens on the screen a virtual digital keypad for direct entry of the value →</p> 
<p><u>Trigger</u> Adjustments on the triggering source</p>	<p>Selection of triggering on edges with delay:</p>  <p>The delay is triggered by the auxiliary source. Actual triggering occurs on the next event in the main source after the end of the delay.</p> <p>Selection of the filter of the auxiliary triggering source:</p> <p>AC AC coupling (10Hz to 300MHz): blocks the DC component of the signal.</p> <p>DC DC coupling (0 to 300MHz): passes the whole signal.</p> <p>LF Reject Rejection of source signal frequencies < 10kHz: facilitates the observation of signals having a DC component or an undesirable low frequency.</p> <p>HF Reject Rejection of source signal frequencies >10kHz: facilitates the observation of signals containing high-frequency noise.</p> <p>Positive-going triggering slope of the auxiliary source </p> <p>Negative-going triggering slope of the auxiliary source </p> <p><input type="checkbox"/> Noise rejection No Hysteresis ≈ 0.5 div. Yes Hysteresis ≈ 1.5 div.</p>

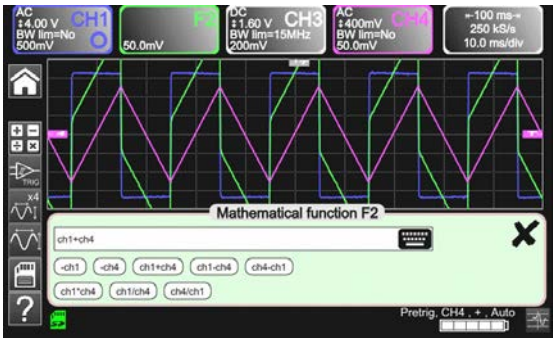
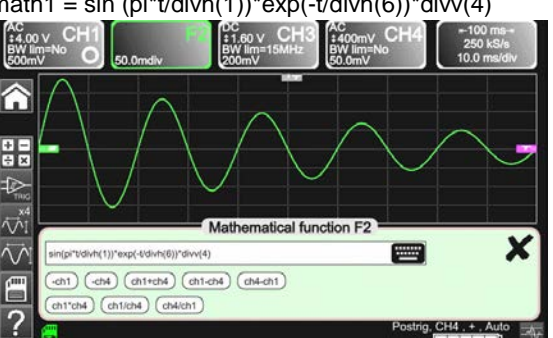
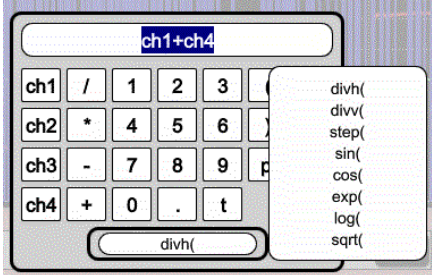
<p>4.Counting Counting</p> <p><i>Qualifier</i></p> <p>Holdoff 100 μs</p>	<p>Selection of triggering on edge with counting of events.</p> <p>Selection of adjustments on the qualification source:</p>  <p>100 μs Disabling of triggering for a preset duration and, among other things, stabilization of triggering on pulse trains.</p> <p>Pointing to this field opens on the screen a virtual digital keypad for direct entry of the value.</p>
<p><i>Counting settings</i></p> <p>Counting 3</p>	<p>The counting is triggered by the auxiliary source; the main source serves as counting clock. Actual triggering occurs on the next trigger event in the main source after the end of the count:</p>  <p>3 Choice of desired number of events.</p> <p>Pointing to this field opens on the screen a virtual digital keypad for direct entry of the value.</p>
<p><i>Trigger</i></p> <p>- DC +</p> <p>Level 600 mV</p> <p><input type="checkbox"/> Noise rejection</p> <p>↗ ↘</p>	<p>Selection of adjustments on the triggering source:</p>  <p>Selection of the filter of the auxiliary triggering source:</p> <p>AC AC coupling (10Hz to 300MHz): blocks the DC component of the signal.</p> <p>DC DC coupling (0 to 300MHz): passes the whole signal.</p> <p>LF Reject Rejection of source signal frequencies < 10kHz: facilitates the observation of signals having a DC component or an undesirable low frequency.</p> <p>HF Reject Rejection of source signal frequencies >10kHz: facilitates the observation of signals containing high-frequency noise.</p> <p>↗ positive-going triggering slope ↘ negative-going triggering slope</p> <p>The triggering slope selected is indicated in the status zone.</p> <p>600mV Triggering level</p> <p><input type="checkbox"/> Noise rejection No Hysteresis \approx 0.5 div. <input checked="" type="checkbox"/> Noise rejection Yes Hysteresis \approx 1.5 div.</p>

4.1.8. MATHEMATICAL function, from the screen

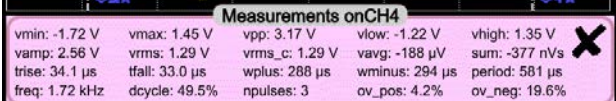
	<p>Definition, for each trace, of a mathematical function and of the vertical scale</p> <p>Equation editor (functions, in the channels or simulated, programmable as F1, F2, F3, F4):</p> <ul style="list-style-type: none"> ▪ Addition ▪ Subtraction ▪ Multiplication ▪ Division ▪ Complex functions between channels 	
<p>Simple functions</p>	<p><i>Example:</i> Addition between channels</p>	
<p>Complex functions</p>	<p><i>Example:</i> Production of a damped sinusoidal trace from predefined functions</p>	<p>math1 = sin(pi*t/divh(1))*exp(-t/divh(6))*divv(4)</p>  <p>"sin(pi*t/divh(1))" changes the number of periods. "exp(-t/divh(6))" changes the damping level.</p>
<p>Definition of a complex function from the parameters of the digital keypad and a field that can be parameterized</p>		<p>8 predefined mathematical functions can be used:</p> <ul style="list-style-type: none"> ▪ Divh (→ "horizontal division") ▪ Divv (→ "vertical division") ▪ Step (→ "on" using "t" (*)) ▪ Sin (→ "sine") ▪ Cos (→ "cosine") ▪ Exp (→ "exponential") ▪ Log (→ "logarithmic") ▪ Sqrt (→ "square root") <p>(*) t = abscissa of the sample in the acquisition memory <i>divh(1)</i> is equivalent to 10,000 samples (points) = 1 horizontal div.</p>

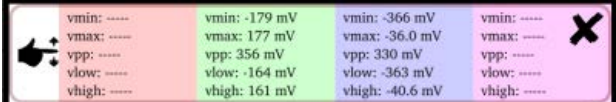
4.1.9. AUTOMATIC measurements, from the screen

	<p>Opening of the "Automatic measurements" Menu window of the channel</p>	
	<p>Opening of the "Automatic measurements" Menu window of the 4 channels</p>	
<ul style="list-style-type: none"> ▪ The measurements are made and refreshed on the selected reference trace. All measurements that can be made on this trace are displayed. (- . -) is displayed for measurements that cannot be made. ▪ The window is closed by pointing to  with the stylus. ▪ All 20 measurements selected will be displayed in the status zone at the bottom of the screen, on a ground the colour of the channel: 		

vmin	minimum peak voltage	trise	rise time
vmax	maximum peak voltage	tfall	fall time
vpp	peak-to-peak voltage	wplus	positive pulse width (at 50% of Vamp)
vlow	stabilized low voltage	wlow	negative pulse width (at 50% of Vamp)
vhigh	stabilized high voltage	period	period
vamp	amplitude	freq	frequency
vrms	RMS voltage determined in the measurement interval	dcycle	duty cycle
vrms_c	RMS voltage determined on a whole number of cycles	npulses	number of pulses
vavg	mean voltage	over_pos	positive overshoot
sum	summation of the instantaneous values of the signal	over_neg	negative overshoot

<p> Measurement conditions</p>	<ul style="list-style-type: none"> ▪ The measurements are made on the part of the trace displayed on screen between cursors T1 and T2. ▪ Any modification of the signal entails an update of the measurements. They are refreshed as the acquisition proceeds. ▪ The accuracy of the measurements is optimum when at least two complete periods of the signal are displayed.
--	--

Presentation of the automatic measurements

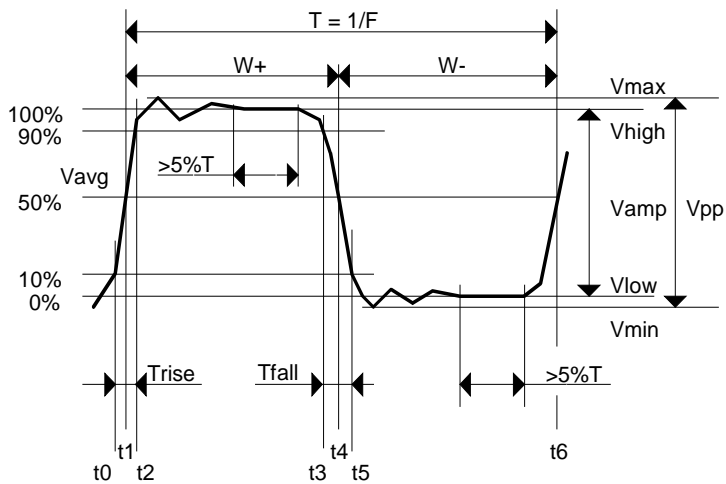

- Positive overshoot = $[100 * (V_{max} - V_{high})] / V_{amp}$
- Negative overshoot = $[100 * (V_{min} - V_{low})] / V_{amp}$

$$V_{rms} = \left[\frac{1}{n} \sum_{i=0}^{i=n} (y_i - y_{GND})^2 \right]^{1/2}$$

$$V_{avg} = \frac{1}{n} \sum_{i=0}^{i=n} (y_i - y_{GND})$$

$$V_{sum} = \sum_{i=0}^{i=n} (y_i \times \delta t)$$

YGND = value of the point representing zero volts

4.1.10. Backup



Pressing this key displays the screen shown below:

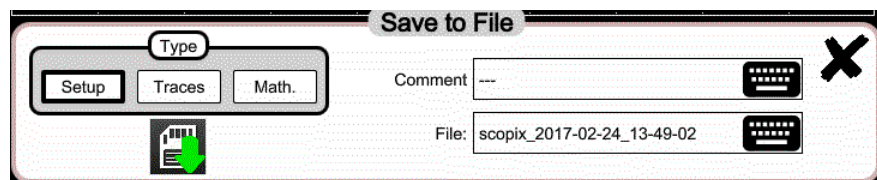

Use this function to record, in local memory or on a μ SD Card:

- the traces displayed
- the mathematical functions
- the configuration of the instrument.

These files can be restored from the file manager

4.2 Multimeter mode

4.2.1 Keys/keyboard active in Multimeter mode

The **ScopiX** has a "Multimeter" function with 8000 display points. It has as many independent multimeters as there are channels in the "Oscilloscope" mode (2 or 4), with the same function as in the Oscilloscope mode: **Probix**.









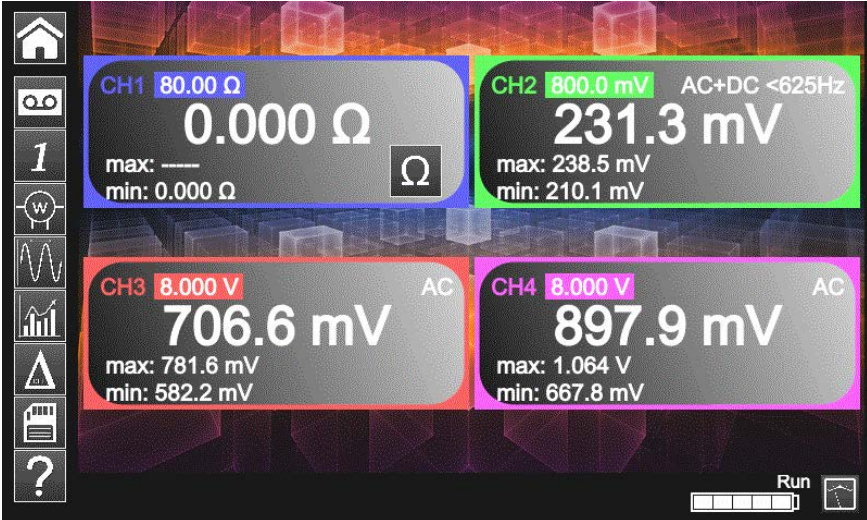

<p>AC/DC GND</p>	<p>Coupling:</p> <p>If a channel is activated and selected, pressing this key changes the input coupling of the channel. With successive presses, the coupling runs through: AC → AC <5kHz → AC <625 → AC+DC → AC+DC <5kHz → AC+DC <625Hz → DC.</p> <p><u>Display of the input coupling</u> Adjustment of the coupling is impossible in some modes: Ohmmeter, Capacitance meter, Continuity, Test of component, Wattmeter.</p> <p><u>Modification of the coupling (AC, DC, AC + DC) in amplitude measurement</u></p> <ul style="list-style-type: none"> • AC: AC voltage measurement • DC: DC voltage measurement • AC + DC: AC voltage measurement with a DC component <p><u>Limitation of bandwidth</u> If the channel measures an AC or AC + DC voltage, it is possible to filter the signal with a low-pass analog filter having a cutoff frequency of 5kHz. The other filter proposed is a digital filter at 625Hz; if this filter is chosen, the 5kHz analog filter is also activated.</p> <p><u>Characteristics of the digital filter</u></p> <ul style="list-style-type: none"> • Low-pass filter • Cutoff frequency 625Hz • Order..... 94 • Bandwidth ripple..... 0.5dB • Transition band 0.02 • Stopband attenuation 50.0dB
	<p>Manual change of measurement range. De-activation of Autorange and change to manual mode. The Autorange function is active as default; the change to manual range is effected by pressing this key.</p>

4.2.2 Icon/screen of the Multimeter mode



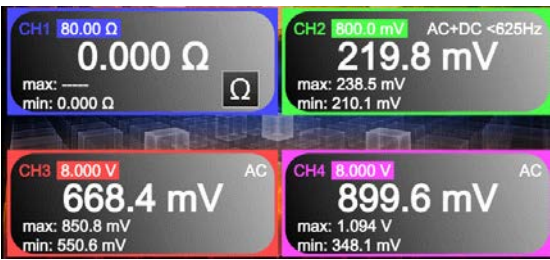

The channel is displayed in the colour defined in the "Oscilloscope" mode. The inactive channels are displayed in white.

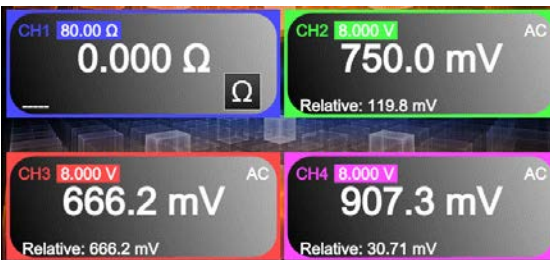
<p><i>Display of the screen:</i></p> <p>4 measurements 4 channels</p>	
--	--







<p>1 Channel 1</p> 	<p>Several types of measurement are possible on CH1; the other channels are voltmeter channels only. A display zone is reserved for each of the channels of the instrument. Each of them displays the following information:</p> <ul style="list-style-type: none"> → CH1, CH2, CH3, or CH4 as Voltmeter → Ohmmeter and audible safety beep → Continuity → Capacitance meter → Test of component <p>Volt: no display of the symbol (lower part of the CH zone)</p> <p> <i>The display of the measurement automatically takes account of the characteristics of Probix (in particular for temperature measurements by PT100/TK).</i></p>
<p>Autorange</p>	<p>A long press on channel CH validates or invalidates autorange of the channel concerned.</p> <p>If Autorange is active, the range is displayed in white in a coloured square.</p>
<p>Main measurement</p>	<p>If the channel is activated, the measurement result is displayed. Otherwise the message "- X -" occupies the unused space. If "-----" is displayed, measurement is impossible: it is outside the authorized range, and "OL" is displayed.</p>
<p>Unit</p>	<p>Contains the measurement unit associated with the current measurement range according to the Probix used and the type of measurement.</p> <p>The unit cannot be parameterized in the multimeter mode.</p>

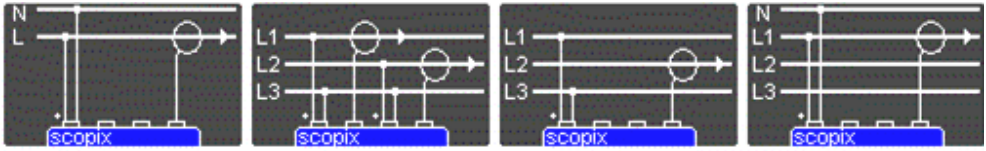

<p>3 secondary measurements that can be selected by the icons below:</p>	<p> If no display is selected, or if no display is possible (e.g. frequency measurement of a DC signal, etc.), the string '-----' is displayed.</p> <p>If the channel is not selected, the string '-X-' is displayed. If the signal is outside of the range: "OL" for overload is displayed.</p>
<p>Frequency</p> 	<p>In the case of an AC amplitude measurement, display of the frequency of the signal measured (if possible and coherent) in each channel.</p> 
<p>Statistics</p> 	<p>Display of the Min and Max values of the measurements made in each channel</p> 
<p>Relative mode</p> 	<p>Display of the difference in each channel.</p> <p>This is the difference between the measured value and the value displayed when this key was pressed.</p> 

4.2.3 Adjustments of the VERTICAL menu

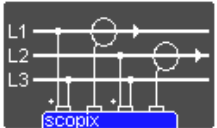
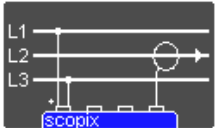
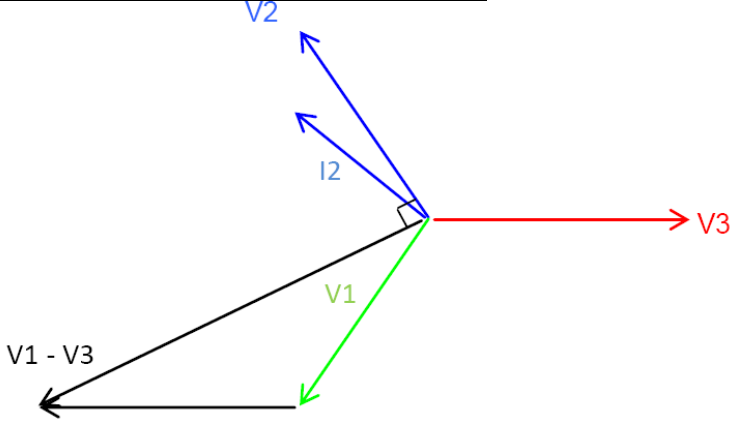
	<ul style="list-style-type: none"> ▪ Activation or de-activation of the parameters of channels CH1, CH2, CH3, CH4 independently of one another ▪ Types of parameter according to the Probitx connected (adjustment in oscilloscope mode) ▪ Quantity displayed. This depends: <ul style="list-style-type: none"> - on the type of measurement selected: <ul style="list-style-type: none"> · amplitude (available on all channels) · ohmmeter · continuity · capacitance meter - on the Probitx PT100/TK temperature probe (available on all channels) - on the Probitx probe connected to the input - on the parameters defined in the vertical parameter zone (if they have been modified since the connection of the Probitx probe). <p> For the ranges available according to the type of measurement, refer to the technical specifications, "Multimeter" function.</p>
	<p>The change of range in manual range is effected by pressing this key.</p>
	<ul style="list-style-type: none"> ▪ RUN → Start of measurements ▪ HOLD → Freeze of the measurement

4.2.4. Power measurement

<p>Display</p> 		<p>The following secondary measurements:</p> <ul style="list-style-type: none"> • MIN/MAX • relative • frequency <p>are available in this quantity.</p>
<p>Choice of set-up with type of power and direct display of the 4 power parameters</p>		
	<p><u>Single-phase</u></p> $P_A = \frac{1}{N} * \sum_N V(n) * I(n)$	
	<p><u>Three-phase without neutral (two-wattmeter method)</u></p> <p>Available only if your instrument has 4 channels</p> $P_A = \frac{1}{N} * \sum_N (U_{12}(n) * I_1(n) + U_{32}(n) * I_3(n))$ $P_R = \frac{\sqrt{3}}{N} * \sum_N (U_{12}(n) * I_1(n) - U_{32}(n) * I_3(n))$	
	<p><u>Balanced three-phase without neutral (3 wires)</u></p>  <p>Measurement of voltage V3-V1 and measurement of the current on I2</p> $P_A = \sqrt{3 * (\hat{U} * \hat{I})^2 - P_R}$ $P_R = \frac{\sqrt{3}}{N} * \sum_N (U_{13}(n) * I_2(n))$	
	<p><u>Balanced three-phase with neutral</u></p> $P_A = \frac{3}{N} * \sum_N V(n) * I(n)$	

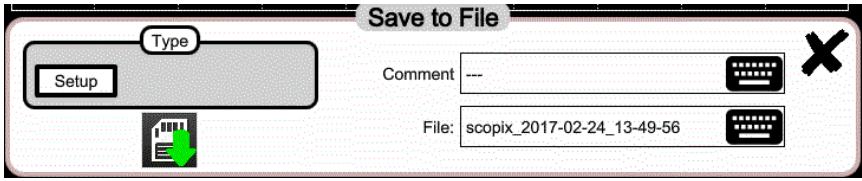
	Exit from the Power mode by selection of the icons opposite.
	<p>Backup of the configuration</p> 

4.3 LOGGER mode





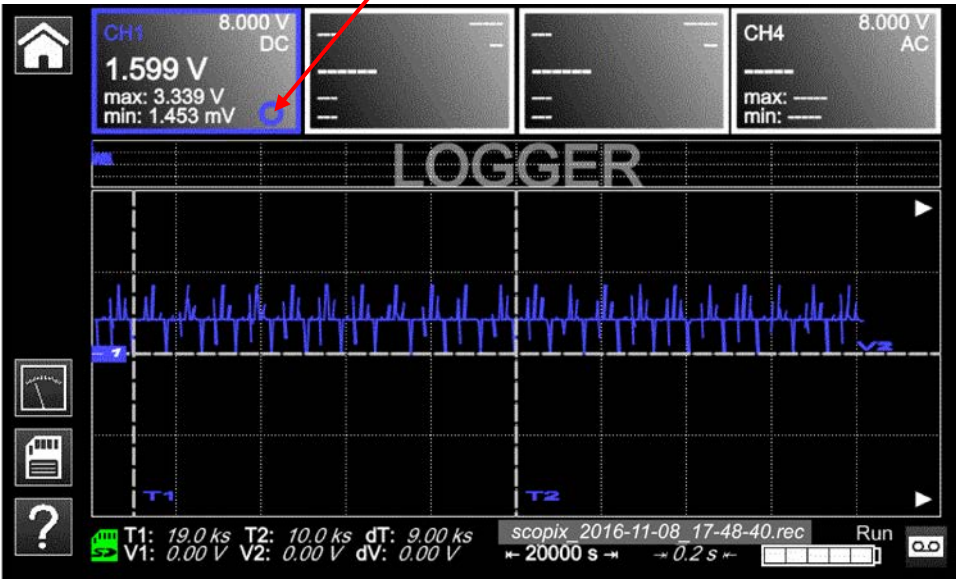

4.3.1 Keys/keyboard active in LOGGER mode

	<p>Upon entry into the LOGGER mode, a file is automatically generated. This file records 10,000 measurements in all active channels: duration of the record 20,000s, resolution 0.2s.</p>
--	---

4.3.2 Icons/screen in LOGGER mode











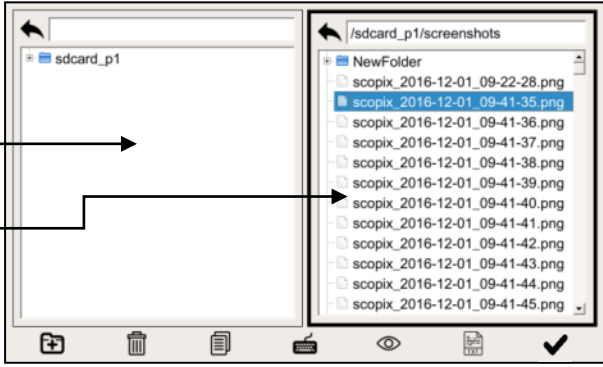
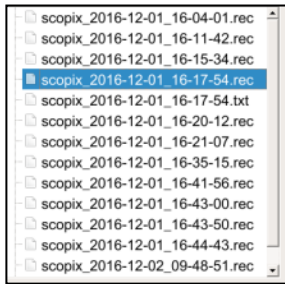

	<p>The LOGGER mode records the measurements of the multimeter mode.</p> <p>Display of the graphic time window, time course of the measurements. The most recent measurement points are those on the right side of the screen.</p> <p>The measurement cursors can be used.</p> <p>This <u>indicator</u> displays the reference channel:</p>
	<p>The time reference of the measurements is the right-hand edge of the screen (indicated by the two white triangles).</p> <p>The file name blinks to indicate that recording is in progress.</p>







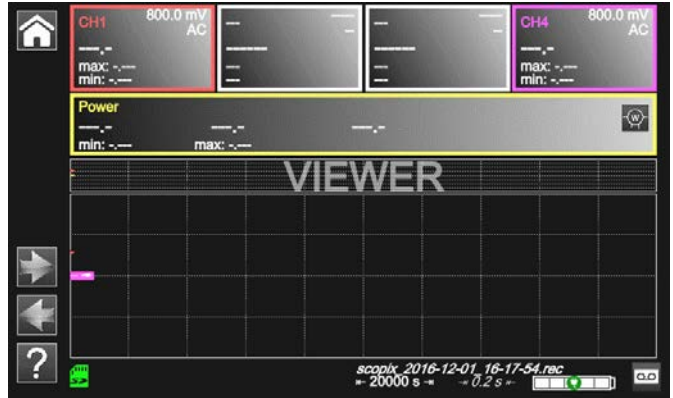

4.3.3 Principles

<p>Automatic sequential recording</p>	<p>(N files of 100,000 measurements) in the memory of the LOGGER directory. Leave enough space for the recording.</p>
	<p><i>In the even of a power outage, the oscilloscope is self-contained thanks to its battery and the files being recorded are kept in memory.</i></p>
 	<p>To exit from the LOGGER mode, click twice of the icons opposite.</p>
	<p>Help file of the keypad keys</p>
	<p>Backup of the configuration</p> 

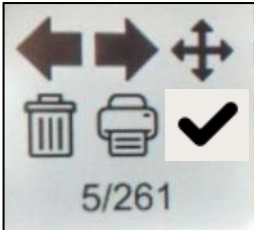
Note : In this mode and in the VIEWER mode, it is possible to display cursors.

4.4 VIEWER mode

<p>File manager</p>		
<p><i>Look-up of files in internal memory and on SD Card</i></p>		
<div style="display: flex; flex-direction: column; gap: 10px;"> <div data-bbox="422 712 502 772"></div> <div data-bbox="422 784 502 844"></div> <div data-bbox="422 855 502 916"></div> <div data-bbox="422 927 502 987"></div> <div data-bbox="422 999 502 1059"></div> <div data-bbox="395 1126 502 1216"></div> <div data-bbox="422 1581 502 1641"></div> </div>	<p>creates a new directory.</p> <p>erases a directory or a file after confirmation.</p> <p>duplicates a file.</p> <p>renames a file from the alphanumeric keypad.</p> <p>displays an analysis file, which opens in the mode recorded, except for .png screen shot files, which are opened in a specific viewer with file processing tools: erasure, printing, displacement of windows.</p> <p>converts .rec and .trc files into .txt files to allow use of the points in an Excel type spreadsheet. After the conversion, the file appears in the tree, renamed and recorded with the same name as the original file:</p>	 <p> <i>Example opposite: .rec file converted to .txt. file</i></p> <p> ScopiX cannot read the.txt file.</p> <p> Edition .txt can take some time. Wait for the end-of-conversion symbol  to go off.</p>
<p><i>The usual directories in chronological order</i></p> <div data-bbox="263 1749 502 2040"> <ul style="list-style-type: none">  functions  harmonic  logger  NewFolder  screenshots  sdcard_p1  setups  traces </div>	<ul style="list-style-type: none"> ▪ functions → mathematical formulas of the recorded functions ▪ harmonic → .txt files of points of the trace in harmonic mode ▪ logger → .rec TRACE or .cfg configuration files acquired in LOGGER mode to be displayed, printed, exported, etc. ▪ screenshots → .png screen shot of each mode ▪ sdcard_p1 → content of the SD Card (partition 1) ▪ setups → configuration files stored in Multimeter, Logger, Harmonic ▪ traces → .trcf files of the Oscilloscope mode <p>It is possible to select several files simultaneously (for deletion or copy).</p>	

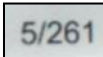
<p>VIEWER</p> <p><i>Recall of a .rec</i></p>	<p>"VIEWER" file appears in the screen background and the LOGGER mode is identified by the icon at bottom right of the screen; see opposite.</p>	
	<p>Arrows for browsing from one file to another in the same directory</p>	
<p><i>Recall of a .png file</i></p>		<p>A window (which can be moved by cursor) appears at the top of the screen:</p> <ul style="list-style-type: none"> ▪  → to go from one file to another ▪  → to move the window on screen ▪  → to erase the file, after confirmation ▪  → to print the file on the network printer pre-programmed in "Tools" ▪  → to close the .png viewer window ▪  → Number of files in the directory

4.5 HARMONIC mode



4.5.1. Keys/keyboard active in Harmonic mode



4.5.2. Principle

<p>The Harmonic mode</p>	<p>is used to display the breakdown into harmonics of a voltage or a current of which the signal is steady-state or quasi-steady-state. It establishes a first diagnostic of the harmonic pollution of an installation.</p> <p>The principle of this mode is to display a graph of the fundamental frequency of order 1 and 63 harmonic orders.</p> <p>The time base is adaptive; it is not adjusted manually.</p> <p>This analysis is only for signals having a fundamental frequency between 40Hz and 450Hz.</p> <p>Only channels CHx (not the functions or the memories) can undergo a harmonic analysis.</p> <p>The harmonic analyses of 2 (OX 2 channels) or 4 (OX 4 channels) signals can be displayed simultaneously.</p>
---------------------------------	--

4.5.3. Icons/screen in Harmonic mode

<p>Display of the result of the harmonic analysis of the selected traces.</p> <p>The harmonic analysis of traces ch1 and ch4 is represented in the form of solid-colour bar charts (in the colour of the trace).</p> <p>As default, the fundamental is selected automatically, but the fundamental frequencies of 50Hz/60Hz and 400Hz can be programmed manually.</p>	
<p>The measurement parameters displayed:</p> <p><u>Measurement on the signal</u></p> <ul style="list-style-type: none"> - the RMS voltage of the signal in V - the total harmonic distortion (THD) in %, per standard EN50160 $THD = \frac{1}{V_{RMS}(Fund)} \times \sqrt{\sum_{Harm=2}^{40} V_{RMS}^2(Harm)}$ <p><u>Measurement on a harmonic</u></p> <ul style="list-style-type: none"> - the value in %, ratio - the phase in ° with respect to the fundamental - its frequency in Hz - its RMS voltage in V 	<p><i>Example: Harmonic of order 1, incrementing of display of the harmonic order by + and decrementing by -</i></p>
	<p>To exit from the Harmonic mode, click the icon opposite.</p>
	<p>Access to the help file of the keypad keys.</p>
	

4.6 BUS Analysis Mode

4.6.1. Active keys in the BUS Analysis mode



4.6.2. Active keys of the keypad:

- HOME
- LUMINOSITE
- SCREENSHOT
- ON/OFF/VEILLE

In the bus analysis mode, the "vertical", "horizontal", "measurement", and "trigger" menus are not available.

4.6.3 Screen icons of the bus analysis mode



Selection of the configuration and display of the connections necessary for the analysis of the selected bus.

SCOPIX IV proposes a set of bus configurations and connection diagrams. These files cannot be deleted or modified, but can be copied and then modified. The .bus* file extension identifies configurations that have been modified by the user. The user must select one of these files to be able to start an analysis:

configurations disponibles

- AS-I.bus
- CanHS_1Mbps.bus
- CanHS_400kbps.bus
- CanHS_500kbps.bus
- CanLS_125Kbps.bus
- DALI.bus
- Ethernet_100baseT.bus
- Ethernet_10base2.bus
- Ethernet_10baseT.bus
- FlexRay_10Mbps.bus
- KNX.bus
- LIN_19200bps.bus
- mil-std-1553_direct.bus
- mil-std-1553_direct_inf4V.bus
- mil-std-1553_transfo.bus
- mil-std-1553_transfo_inf4V.bus
- ProfibusDP_12Mbps.bus
- ProfibusDP_inf4V_12Mbps.bus
- ProfibusPA.bus
- ProfibusPA_Noise.bus
- RS232_115200bps.bus
- RS232_9600bps.bus
- RS485_10Mbps.bus
- RS485_19200bps.bus
- RS485_9600bps.bus
- RS485_inf4V_10Mbps.bus
- RS485_inf4V_19200bps.bus
- RS485_inf4V_9600bps.bus
- scopix_2017-12-05_12-18-08.bus*
- scopix_2017-12-05_12-19-28.bus*
- USB_FullSpeed.bus
- USB_LowSpeed.bus

When a configuration file has been selected, the standard (or directive) and the probe connections diagram are displayed.

Bus à analyser

configuration actuelle

DALI 1200bps
IEC-62386-101

DALI

connexions

configurations disponibles

- CanHS_400kbps.bus
- CanHS_500kbps.bus
- CanLS_125Kbps.bus
- DALI.bus
- Ethernet_100baseT.bus



Measurement tolerances

Display of the tolerances applied according to the standard or directive in force. You can change these tolerances by clicking the value to be modified. The modifications are automatically recorded in the .bus* file copied in the folder named "bus-limits". The measurements "tolerances" menu contains: the min and max intervals of each measurement and the interval "of acceptability" outside the interval of tolerances (as a percentage of the interval defined by the min and max values).

Tolérances de mesure

Arinc429 100kbps receiver

High AB	9.00 V	11.0 V	10.0 %	Low AB	-11.0 V	-9.00 V	10.0 %
Null AB	-500 mV	500 mV	10.0 %	Time Rise	1.00 µs	2.00 µs	10.0 %
Time Fall	1.00 µs	2.00 µs	10.0 %	Bit Time	9.75 µs	10.2 µs	10.0 %
1/2 Bit Time	4.75 µs	5.25 µs	10.0 %				

Modifications enregistrées dans le fichier: scopix_2017-12-05_16-02-50



Analysis

Start of analysis of the selected bus, in steps.

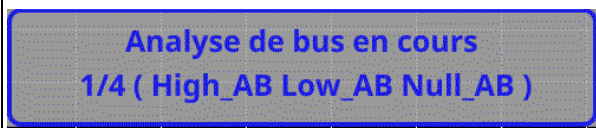

Results of the analysis

Display of the results of the last analysis performed.

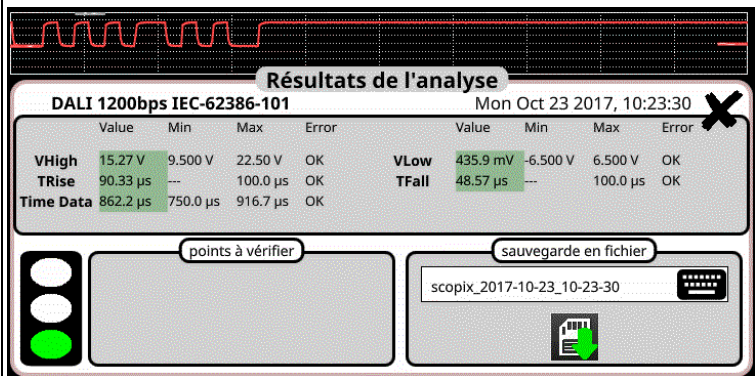

If the measurement lies within the specified interval, it is displayed in green.
 If the measurement lies within the interval of acceptability, it is displayed in yellow.
 If the measurement is outside both of these intervals, it is displayed in red.
 A trouble-shooting help (menu???) is displayed if one or more measurements are outside tolerances.
 These results can be saved to a file having the ".htm" extension in internal memory, on the micro SD card.

USB low speed

Fri Sep 29 2017, 09:52:20

Bus quality: 100%

	Min value allowed	Max value allowed	Measurement	Error
VHigh	1.000 V	3.600 V	3.090 V	OK
VLow	-3.600 V	-1.000 V	-3.308 V	OK
Time Rise	75.00 ns	300.0 ns	110.5 ns	OK
Time Fall	75.00 ns	300.0 ns	102.8 ns	OK
TRise-TFall	---	---	9.900 ns	---
Time Data	---	---	679.6 ns	---
Jitter	---	24.0%	0.3%	OK



A global bus integrity estimate is generated; it reflects all of the elementary measurements.
 A 100% integrity measurement indicates that all of the elementary measurements are located around their nominal values.
 A 0% integrity measurement indicates that one or more measurements are outside tolerances.









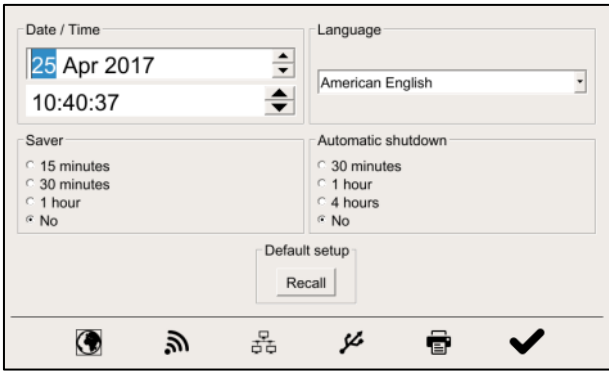

Help

Interactive help with front-panel keys

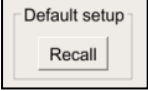
4.7. Communication

	<p>The communication interfaces are grouped in a specialized space on the side of the ScopiX, protected by a cover.</p> <p>You can communicate on several interfaces:</p> <ul style="list-style-type: none"> ■ USB type B for communication with a PC The cord supplied is used to connect to the USB type A port of a PC: transfer of file, programming using SCPI commands ■ Ethernet via RJ45 cords or via WiFi for communication with a PC or printing to a network printer or, in an ANDROID environment, communication with a tablet or smartphone ■ High-capacity μSD for storing data or loading configurations, available capacity depending on the type of card ■ internal disc: 512MB data storage capacity available 	
	<ul style="list-style-type: none"> ■ As default, the files are recorded on the internal memory. 	<ul style="list-style-type: none"> ■ colour green \rightarrow memory occupied from 0 to 50% ■ colour orange \rightarrow memory occupied from 50 to 80%
	<ul style="list-style-type: none"> ■ The files are recorded on the μSD, if it is connected. 	<ul style="list-style-type: none"> ■ colour red \rightarrow memory occupied from 80 to 100%





4.7.1 General parameters

<p><i>Can be accessed from the home screen by</i></p> 		
 <p>Date/Time</p>	<p>Update of the date (day, month, year) and time (hour, minute, second). The selection is made by the stylus, using the scroll bars on either side of the parameters to be adjusted. The clock starts when the menu is closed.</p>	
<p>Language</p>	<p>Selection of the language used in the menus. Possible options: French, English, German, Italian, Spanish, etc. (get in touch with us to learn about any additions).</p>	
<p>Screen saver</p>	<p>The screen saver is activated after a specified time, in order to save power and extend the life of the screen. There are 4 options: 15min, 30min, 1h, no saver mode. The screen is reactivated by pressing any key on the front panel.</p>	
<p>Auto off</p>	<p>The instrument is switched off after a specified time, in order to save power. In this case, the configuration of the instrument is saved before it is switched off. There are 4 options: 30min, 1h, 4h, no auto off.</p>	
	<p>Default setup: restores the factory configuration parameters. The instrument starts up in the configuration in which it was switched off; if the user presses "Recall", it starts up in the default (factory) configuration.</p>	
<p>Keys</p>		<p>Programming the WiFi radio network Pressing this key gives access to a list of WiFi networks available by polling. You can:</p> <ul style="list-style-type: none"> ■ scan the network at any time, then select the additional page of settings as soon as the network has been chosen ■ enter the fields: IP address, subnetwork mask, gateway, then validate by "Connect". The network is then stored and WiFi communication is active.
	<p>Ethernet programming: Automatic (DHCP) or manual setting of IP parameters (Address, Subnet Mask and Gateway). Assigning a link-local address in case of DHCP failure (point-to-point link).</p>	
	<p>USB: Manual setting of IP parameters (Address, Subnet Mask and Gateway). Programming: cf. installation guide, RNDIS driver for Windows 7</p>	
	<p>Programming of the network printer Enter the IP address of the printer and/or its name if there are several printers in the network (contact your network administrator to make sure of the presence of this type of server). An alphanumeric keypad appears.</p>	
	<p>Exit from the setup menu</p>	

<p>IP address</p>	<p>An IP address is coded in 4 bytes, displayed in decimal form (🌐: 132.147.250.10).</p> <p>Each field can be coded between 0 and 255; the fields are separated by decimal points. Unlike the physical address, the IP address can be modified manually by the user or automatically by DHCP.</p> <p>You must make sure that the IP address is unique on your network; if <i>an address is duplicated, the operation of the network becomes problematical.</i></p>
<p>Subnetwork mask and Gateway</p>	<p>If the result of the "LOGICAL AND" between the IP address of the addressee of the message and the value of the subnetwork mask (SUBNET MASK) is different from the address of the addressee of the message, the message is sent to the gateway (GATEWAY), which takes charge of getting it to its destination.</p> <p>The mask and the address of the gateway can be programmed on the instrument.</p>
<p>DHC protocol</p>	<p>This protocol is used to parameterize network access automatically.</p> <p>A DHCP (Dynamic Host Configuration Protocol) server must be accessible in this network (contact your network administrator to make sure of the presence of this type of server).</p>
	<p>Each ScopiX instrument has a unique factory-configured MAC address. There is one wire network MAC address and one WiFi address.</p>
<p>Selecting the WiFi network</p>	<div data-bbox="518 757 973 1317" data-label="Image"> </div> <p>To connect to the WiFi network:</p> <ol style="list-style-type: none"> 1. "Scan" to manually scan the available networks; done automatically when the WiFi menu is opened. 2. Select the SSID network. 3. Enter the network's security key. 4. Fill in the fields specific to the network, if the manual mode is selected; otherwise DHCP in the automatic mode. 5. "Connect" to validate the parameters.
<p>Selection of the wire network</p>	<div data-bbox="518 1339 973 1608" data-label="Image"> </div> <ol style="list-style-type: none"> 1. Fill in the fields specific to the network, if the manual mode is selected; otherwise DHCP in the automatic mode. 2. "Connect" to validate the parameters.
	<div data-bbox="518 1630 973 1910" data-label="Image"> </div> <p>"About" - (cf. p.17)</p>

4.8. Memories



Backup memories	The files are stored in a specific partition. File system: 1. on an SD Card; the partitions of the SD Card are accessible in the sdcard_pX directory, 2. in the local file system.		
Available memory size	<ul style="list-style-type: none"> ▪ Internal memory of the instrument: 1GB for the file system ▪ "Micro SD" memory card, type: SC ($\leq 2\text{GB}$) HC ($> 2\text{Go} \leq 32\text{Go}$) XC ($> 32\text{Go} \leq 2\text{To}$) of which the partition(s) are formatted to FAT32.		
Optimization of the memory space according to the volume	▪ Files of traces acquired in SCOPE mode	.trc	Size: 400kB per trace stored (max.: 1.6MB)
	▪ Files of traces acquired in LOGGER mode, Binary format	.rec	Size: 400kB per trace stored (max.: 1.6MB)
	▪ Configuration files, Binary format	.cfg	Size: 1ko
	▪ Printing	.png	Size: <200ko
	▪ Files of mathematical functions, Text format	.fct	Size: <1ko
	▪ Files in text format containing a trace acquired in HARMONIC mode	.txt	Size: <10ko
	▪ Text format files resulting from the conversion of binary files (.rec or .trc)	.txt	Size : variable

Summary table of the storage possibilities by mode					
	Icon 	Icon 	Icon 	Icon 	Keypad 
Type of file	Setup.(cfg)	Traces.(trc)	Math.(fct)	Measurement.(txt)	Screen shot.(png)
Oscilloscope mode	✓	✓	✓		✓
Multimeter mode	✓				✓
Logger mode	✓				✓
Harmonic mode	✓			✓	✓
Directory	setups	traces	functions	harmonic	screenshots

Note: all files in "SCOPIX" including NF are viewable on a PC via the USB port as an external disk.

Ethernet communication is reserved for remote control of the instrument. The SCOPENET application, running on a PC, uses the files in memory in SCOPIX.

4.9 Update of the firmware of embedded programs

<p>Firmware</p>	<p>Periodically, an "update available" message may appear on the home screen, if the ScopiX is connected to Ethernet or WiFi:</p>  <p>This message means that update files have been downloaded transparently to the ScopiX: they are available for an update, which is recommended in order to obtain new functions, bug fixes; etc.</p> <ul style="list-style-type: none"> ▪ Select OK and the update automatically installs the files in the ScopiX. ▪ The duration of the update varies, but is less than 15 minutes ▪ Follow the directions (see below). ▪ Do not switch off ScopiX during the update. ▪ The files of the internal memory (measurements, screen shots, setups, etc.) are not destroyed during the update. ▪ For more complete information, go to the support space of our Web site: a manual update procedure is available.
<p>Update installation procedure</p>	<ol style="list-style-type: none"> 1. Connect the ScopiX, preferably to line power. 2. Check "Do you want to install it". 3. ScopiX switches off, then back on, automatically. 4. A screen (yellow-white) of which the colour varies to represent an action in progress, with an "update running" message, remains on screen for approximately 8 minutes. 5. ScopiX switches itself off and back on. 6. A touch slab calibration procedure screen is displayed: follow the steps by checking the 4 corners, then the centre. 7. The home screen is displayed again: you can view the new system information (date, version, etc.) → the update is done. <p> <i>The operating instructions in .pdf format, or any other updated document, can be downloaded and placed in the file manager in this way.</i></p>

4.10. ScopeNet IV



When you have obtained the IP address of the **Scopix** (DHCP or manual) using a browser, type 14.3.250.51/scopenet.html (for example) on your computer → this opens the screen shown opposite.

☞ *JAVA application PC is used to display the **ScopeNet IV** page.*

*Carefully check the installation of **ScopeNet** to forestall any difficulties.*

To check the instruments connected, follow the procedure:

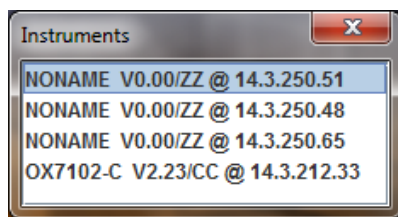

- Press the network icon, in the centre of the screen: the search for instruments in the network (Ethernet and WiFi) is effected by a specific function. A series of compatible instruments connected is displayed: see opposite.
- The PC environment uses icons in an HMI identical to the **Scopix IV** product, with the same access to the functions and adjustments.

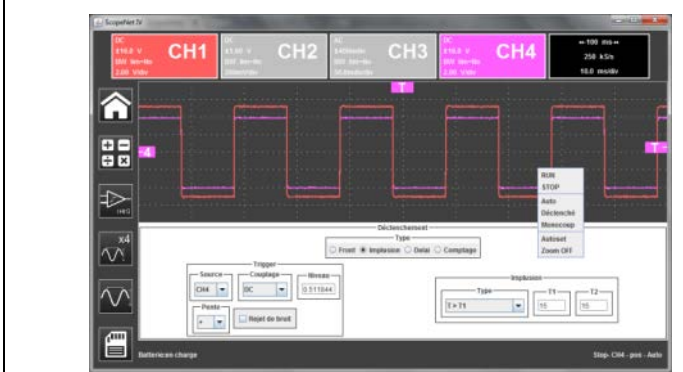

In "Oscilloscope" mode, **ScopeNet IV** proposes adjustments by a right click on the waveform: RUN/STOP, AUTO/TRIG/SINGLE/AUTOSET and ZOOM are easy-to-configure parameters.

☞ *Example: 2 active channels: CH1 and CH4
2 greyed-out inactive channels: CH2 and CH3*

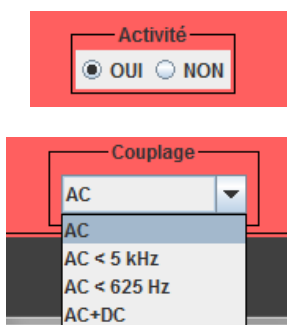

In MULTIMETER mode, the vertical configuration can be accessed by a click in the window shown opposite:

- activation of the channel
- the AUTO RANGE mode, as default: manual adjustment from among a set of ranges (white zone around the quantity)
- the coupling (shown opposite)

☞ *Example: - channel 1 active, AUTO
- channels 2 and 3 inactive, AUTO
- channel 4 inactive, but adjustment of the voltage ranges is possible.*



File and backup management are active on the PC, but it is possible, via USB, to store in **Scopix**.

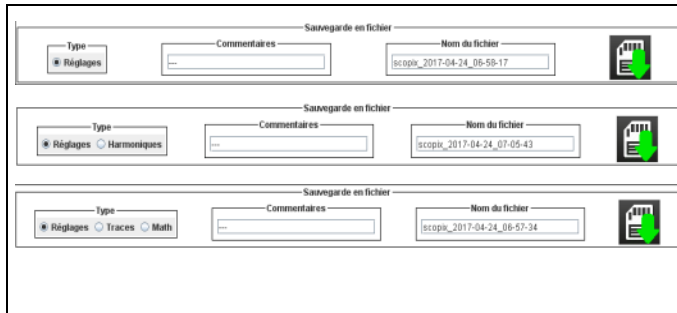

Backup in the various modes (Oscilloscope, Multimeter, Logger, Harmonic) is possible from the PC, configuration files:

- "adjustments" for all modes
- "harmonics"
- "traces and math" for the oscilloscope mode.

The backup is recorded in the file system of **ScopiX** (internal or SD Card).

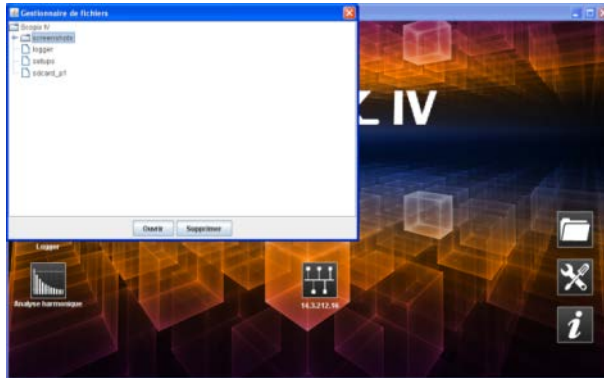

The files stored in **ScopiX** can be looked up from **ScopeNet**.

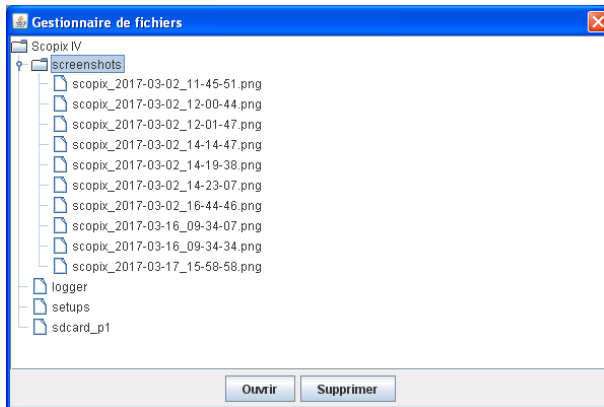

The files are recorded in the directory defined by the type of record.

5. HOW ARE WAVEFORMS DISPLAYED?

5.1 "Manual" display

To view the signal and project it on the screen, you must know (or imagine), as prerequisites, the following characteristics:

- the **coupling** → whether the signal is pure AC or has a DC component,
- the **amplitude** in Volts → to define its amplitude on screen,
- the **frequency** or period of the signal → if it is repetitive,
- the **bandwidth** → the frequency entails.



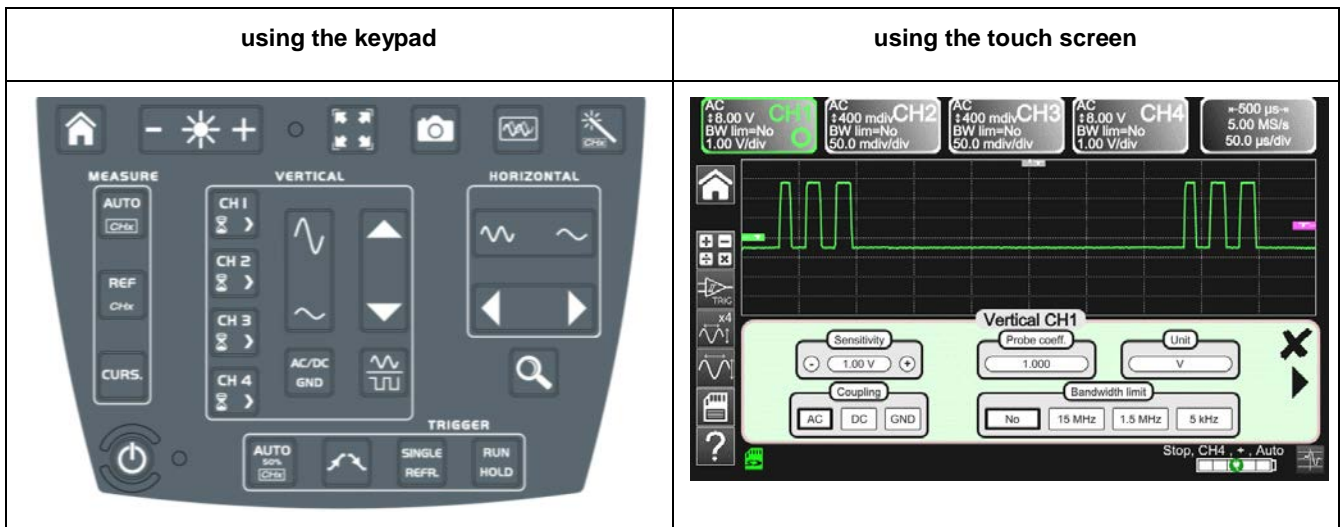







Once these data are known, the parameterizing of the channel to display the signal can begin. There are two ways to parameterize the channel:

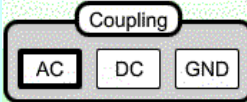
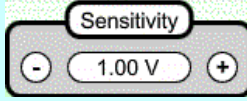

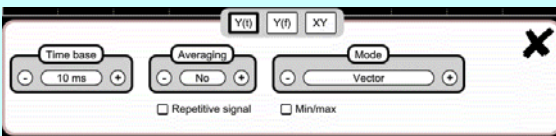

5.1.1. Using the keypad

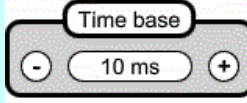
Key ↗	Action ↗
	1. Connect the Probitx probe to the input of a channel.
	2. Press the key of the channel to refresh it and access parameterizing.
	3. Pressing this key selects the desired coupling.
	4. This key selects the desired vertical sensitivity of the channel or its maximum amplitude visible on screen.
	5. This key selects the desired time base of the channel or the maximum period visible on screen.
	6. Press the key opposite.
	7. The signal appears.
Note	It is not possible to parameterize the bandwidth of the signal from the keypad.









5.1.2. Using the touch screen

Icon 	Action 
	<ol style="list-style-type: none"> 1. Connect the Probix probe to the input of the channel.
	<ol style="list-style-type: none"> 2. Click the channel  to refresh it ("channel activated") and access parameterizing.
	<ol style="list-style-type: none"> 3. Press the type of coupling to select the desired coupling.
	<ol style="list-style-type: none"> 4. Press + or - to select the desired sensitivity of the channel or its maximum amplitude visible on screen.
	<ol style="list-style-type: none"> 5. Press the type of bandwidth to obtain the desired limitation.
	<ol style="list-style-type: none"> 6. Press " ".
	<ol style="list-style-type: none"> 7. Click the time base to access the adjustments
	<ol style="list-style-type: none"> 8. Click " ".
	<ol style="list-style-type: none"> 9. Check that only "roll" is checked.
	<ol style="list-style-type: none"> 10. Select the duration of the time base with + or -.
	<ol style="list-style-type: none"> 11. Press " ".
	<ol style="list-style-type: none"> 12. The signal appears.

5.2 Autoset

	<p>The "Autoset" key projects on the screen the signal you want to display, along with its characteristics (refer to "manual" display, §4.1.3.). Thus, in one click, the signal appears optimally.</p>
<p> <i>Example</i></p>	<ol style="list-style-type: none"> 1. Connect the Probix probe to the channel. 2. Press the key above. 3. A message appears on screen to indicate that the ScopiX is doing the necessary parameterizing. This optimizes the display of the signal.

5.3 Calibrating the probes

Step	Action 	
1.	Connect the Probix adapter of an HX0030 probe having a 1/10 ratio to the CH1 input.	
2.	Connect the probe (with its ground) to the calibrator output (Probe Adjust: $\approx 3V$, $\approx 1kHz$) on the side of the instrument. Connect the cold of the probe to the cold of the calibration output of the probes.	
4.	Check that the 1/10 coefficient of the probe has in fact been taken into account.	<ul style="list-style-type: none"> Menu CH1 Click the right arrow, Measurement of probe, select Coefficient: 10, Validate by clicking "  » <p><i>Note: The sensitivity and the measurements take the coefficient of the probe into account.</i></p>
5.	Set the sensitivity of CH1.	<ul style="list-style-type: none"> Menu CH1, Sensitivity/coupling: 500mV/div or using buttons A and B of the HX0030 probe  <ul style="list-style-type: none"> or using the  keys.
6.	Set the coupling of CH1.	<ul style="list-style-type: none"> Menu CH1, coupling: AC  <ul style="list-style-type: none"> or using the key.
7.	Set the sweep rate.	<ul style="list-style-type: none"> Time base menu: 500μs/div. or using the  <ul style="list-style-type: none"> keys.
8.	Set the triggering parameters	<ul style="list-style-type: none"> Trigg menu: Source: CH1, Coupling: AC, + Edge + 
9.	Set the triggering mode.	<ul style="list-style-type: none"> Trigg Menu by the SGLE REFR. key using the RUN HOLD key, start the acquisitions ("RUN" mode).

If necessary:

- Modify the triggering level with the stylus by moving the T (Trigger) symbol on the screen. The triggering level is indicated at bottom right on the screen.
- Modify the vertical position of the curve by using the stylus to move the 1 symbol, to the left of the screen.



The  key can be used to perform these adjustments automatically.

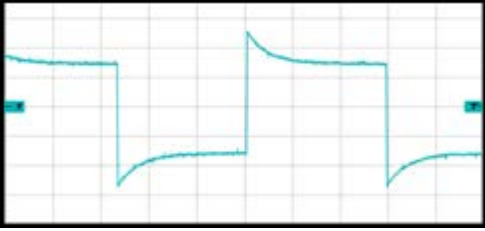
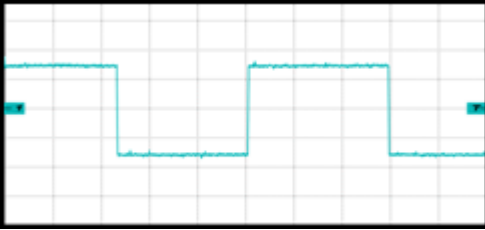
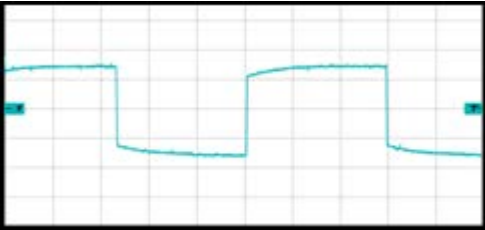

<p>Compensation of the HX0030 probe</p>	<p>Act on the screw on the <i>Probix</i> HX0030 probe to adjust the compensation.</p> <p>For an optimum response, adjust the low-frequency compensation of the probe so that the plateau of the signal is horizontal.</p>
<p><i>Probe overcompensated</i></p>	
<p><i>Probe correctly compensated</i></p>	
<p><i>Probe under-compensated</i></p>	

5.4 Auto/Cursors/Zoom measurement

5.4.1. Auto

For optimum measurement accuracy, we recommend displaying two complete periods of one or more signals. To do this, modify the time base in a logical way using the "horizontal" keys.

- There are two ways to start **Auto** measurements in a channel:

In this way, you display the list of signals in this window:

- using the keypad: by pressing the key of the channel concerned at the same time.
- using the touch screen: by pressing the icon shown opposite.

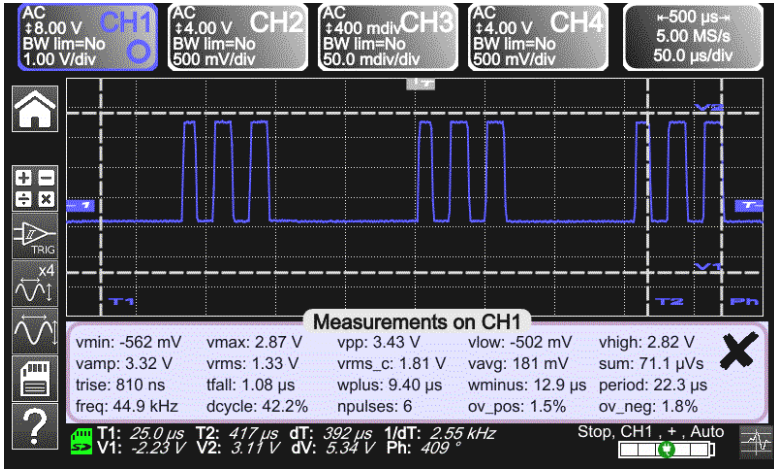

vmin: -562 mV	vmax: 2.87 V	vpp: 3.43 V	vlow: -502 mV	vhigh: 2.82 V
vamp: 3.32 V	vrms: 1.33 V	vrms_c: 1.81 V	vavg: 181 mV	sum: 71.1 μVs
trise: 810 ns	tfall: 1.08 μs	wplus: 9.40 μs	wminus: 12.9 μs	period: 22.3 μs
freq: 44.9 kHz	dcycle: 42.2%	npulses: 6	ov_pos: 1.5%	ov_neg: 1.8%

- There is one way to start **Auto** measurements in the 4 channels:



In this way, you display the list of signals in this window:

- using the touch screen: by pressing the icon shown opposite.

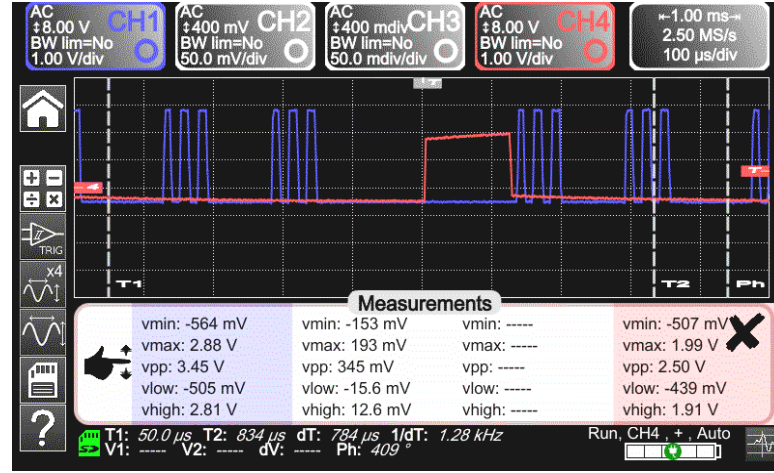

vmin: -564 mV	vmin: -153 mV	vmin: ----	vmin: -507 mV
vmax: 2.88 V	vmax: 193 mV	vmax: ----	vmax: 1.99 V
vpp: 3.45 V	vpp: 345 mV	vpp: ----	vpp: 2.50 V
vlow: -505 mV	vlow: -15.6 mV	vlow: ----	vlow: -439 mV
vhigh: 2.81 V	vhigh: 12.6 mV	vhigh: ----	vhigh: 1.91 V

List of the different values in Auto measurements	Time measurements	Level measurements
	rise time	DC voltage
	fall time	RMS voltage
	positive pulse	peak-to-peak voltage
	negative pulse	amplitude
	duty cycle	max. voltage
	period	min. voltage
	frequency	upper plateau
	phase	lower plateau
	counting	overshoot
integral		

5.4.2. The cursors

<p>There are three categories of cursors (use the stylus to move them).</p>	<ul style="list-style-type: none"> Time cursors (T1 and T2), to measure certain time values and deduce a delta and its frequency. Amplitude cursors (V1 and V2), to measure amplitude values and deduce a delta. A phase cursor to measure the phase of the signal according to the positioning of T1 and T2 and of a reference signal.
--	--

Measurements on CH1

vmin: -562 mV	vmax: 2.87 V	vpp: 3.43 V	vlow: -502 mV	vhigh: 2.82 V
vamp: 3.32 V	vrms: 1.33 V	vrms_c: 1.81 V	vavg: 181 mV	sum: 71.1 μ Vs
trise: 810 ns	tfall: 1.08 μ s	wplus: 9.40 μ s	wminus: 12.9 μ s	period: 22.3 μ s
freq: 44.9 kHz	dcycle: 42.2%	npulses: 6	ov_pos: 1.5%	ov_neg: 1.8%

The phase cursor is inactive if you are in Auto measurement mode in all channels.

5.4.3. Zoom



	<p>For more accurate measurements with the cursors, press the key to use the Zoom function. As default, the zoom is applied to the centre of the current acquisition of the ScopiX. You can use the stylus to mark out a different zone.</p> <p> The time base is corrected according to the zoom applied.</p>
--	--

<p>Zoomed screen</p>	
-----------------------------	--

	<p>Press the key again to exit from the Zoom function.</p>
--	--

5.5 Adjusting the Trigger

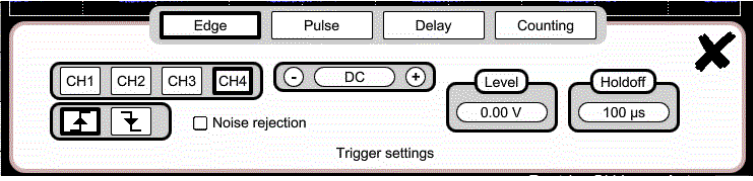
- Choose the triggering mode that corresponds to your application.
- Set the values of all triggering parameters.

<p> <i>Example:</i> Triggering on edge</p>	
<p></p>	<p>Exit from the window by clicking the cross.</p>

5.6 Mathematical/FFT/XY measurement

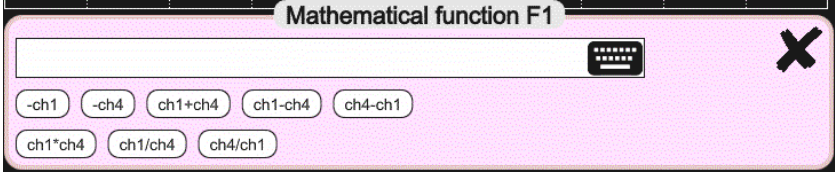
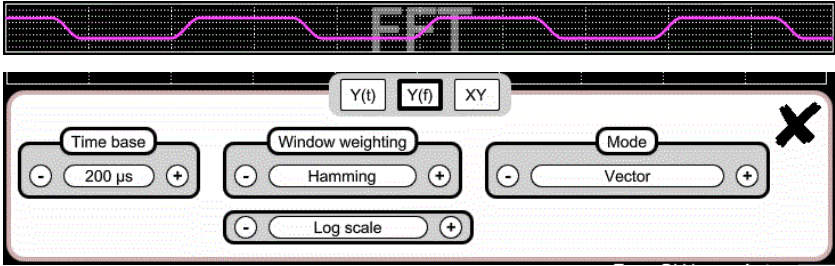
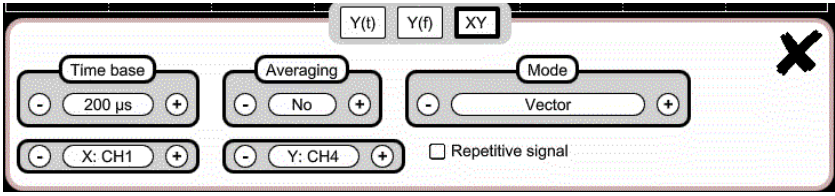
<p>Mathematical functions</p>	<p>These serve to process your readings as a function of the parameterizings you implement on one of the channels of the instrument.</p> <p>These functions can be accessed using the key on the screen to specify the channel you want.</p> <p>A window appears that can be used to configure the mathematical function of this channel using the keypad or the predefined functions.</p> 
<p>FFT</p>	<p>The FFT (Fast Fourier Transform) function is activated via the time base menu by clicking it and selecting "Y(f)".</p>  <p>Parameters:</p> <ul style="list-style-type: none"> ▪ Time base in seconds ▪ Weighting window: rectangular, hamming, hanning, blackman, flat top ▪ Type of scale: logarithmic or linear ▪ Mode: vector, envelope, whole acquisition, total
<p>XY</p>	<p>This function is used to display one channel as a function of another.</p>  <p>Parameters:</p> <ul style="list-style-type: none"> ▪ Time base in seconds for channels X and Y ▪ Channel X or Channel Y ▪ Averaging: no, 2, 4, 16, 64 ▪ Mode: vector, envelope, whole acquisition, total <p>This function activates the repetitivity of the signal.</p>

6. HOW IS A QUANTITY MEASURED BY MULTIMETER?



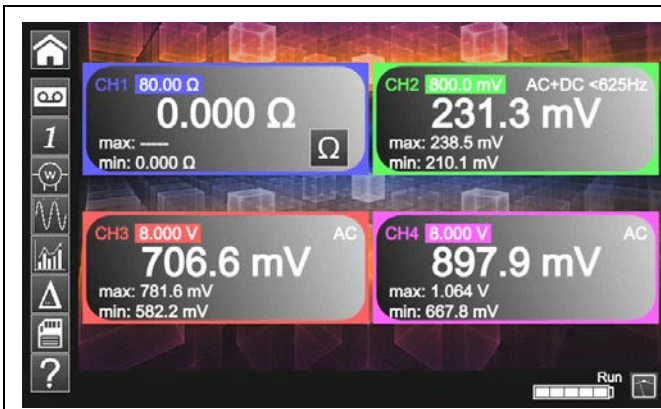



6.1 Differentiating the channels







Channel 1 of the **Scopix** is named CH1. It is used to measure various physical quantities in addition to the signal amplitude measurements, using the appropriate **Probix** accessories. The other channels are voltmeter channels only (or current channels, when used with a **Probix** clamp).

6.2 Type of measurement

Measurements	CH1	CH2	CH3	CH4
Voltage	✓	✓	✓	✓
Current	✓	✓	✓	✓
Resistance	✓			
Capacitance	✓			
Diode test	✓			
Continuity	✓			
Power	✓	✓	✓	✓
Temperature by Pt100	✓	✓	✓	✓

By clicking 	You can 
	<ul style="list-style-type: none"> display the frequency, in the case of an AC amplitude measurement, as a secondary measurement performed on each channel.
	<ul style="list-style-type: none"> display the Min and Max values of the measurements made, as a secondary measurement on each channel.
	<ul style="list-style-type: none"> display the relative values of the measurements made, as a secondary measurement on each channel.
	<ul style="list-style-type: none"> save your configurations, by entering their properties.

 Remarks	
	The channels of the measurement ranges are automatic. To define the measurement range in manual mode, press the key opposite.
	A long press on the key of the channel is used to return to automatic mode. In addition:
	<ul style="list-style-type: none"> in automatic mode, the measurement range on the screen is highlighted in the colour of the channel in manual mode, it is not.
	The coupling of the channels can be modified using the key opposite: $\boxed{DC} \rightarrow \boxed{AC} \rightarrow \boxed{AC <5kHz} \rightarrow \boxed{AC <625kHz} \rightarrow \boxed{AC+DC} \rightarrow \boxed{AC+DC} < \boxed{5kHz} \rightarrow \boxed{AC+DC <625kHz}$

6.3 Power measurement

To measure power, you must have the right **Probix** accessories:



- current measurements are made using **HX0034**, **HX0072**, and **HX0073** clamps
- voltage measurements are made using the **HX0033** banana adapter and leads.

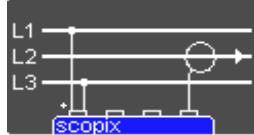
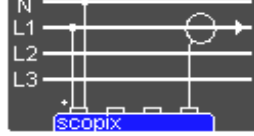
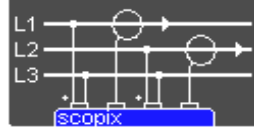

A power measurement is made in the Multimeter mode, by clicking the  icon. Then, select the type of set-up you want to measure:

	Single-phase power	Display of the result of calculation of the active power, measured using CH1 for the voltage measurement and CH4 for the current measurement.
	Three-phase power on balanced network without neutral	The value displayed is the active three-phase power calculated from the wiring proposed at the time of selection.
	Three-phase power on balanced network with neutral	The value displayed is equal to 3 times the active power measured on one phase.
	Three-phase power, 3 wires	Display of the result of calculation of the active three-phase power measured by the two-wattmeter method on a installation without neutral.

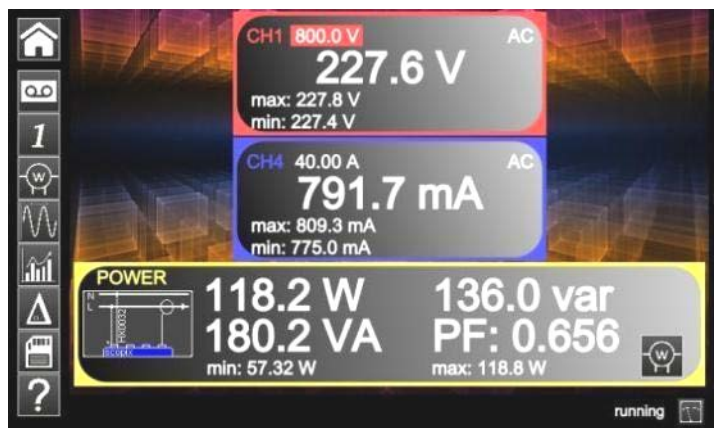
When the values are read in this mode, the following screen is displayed:  *Example:* Single-phase power

	<p>← Channel 1 indicates the voltage measured directly with its min and max values</p> <p>← Channel 4 indicates the current measured directly with its min and max values.</p> <p>← The various power values calculated from channels 1 and 4 are displayed, along with their power factor.</p> <p> <i>The type of wiring is indicated next to the values.</i></p>
---	---



6.4 LOGGER mode

This utility of the Multimeter mode is used to record the values read on the various channels of the **ScopiX**, whatever the type of measurement.

 **The records may be long. It is therefore preferable to connect ScopiX to line power so as to avoid a sudden stoppage of the measurement when the battery is depleted.**

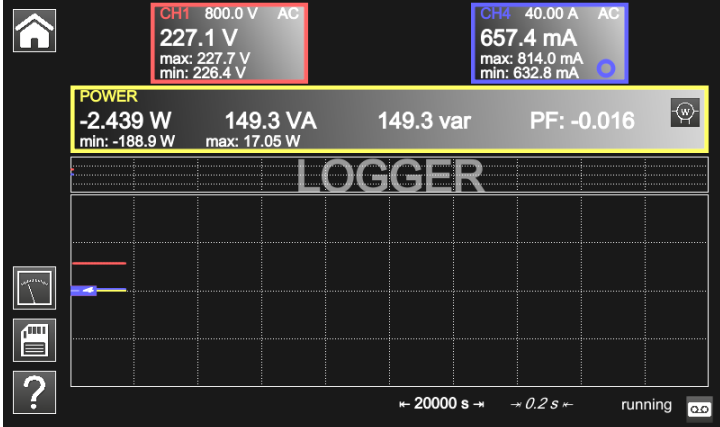

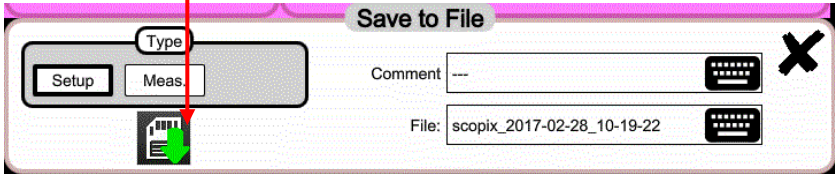

When you click , the screen below is displayed and recording starts:

	<p>Each recording file contains 100,000 measurements per channel, at a rate of one measurement every 0.2 sec for 20,000 sec (approx. 5h30').</p> <ul style="list-style-type: none"> ■ If a recording exceeds 100,000 measurements, ScopiX automatically generates a second measurements file that continues where the preceding file ended. ■ If the second measurement file reaches 100,000 measurements, a third file is created, and so on until you decide to stop the acquisition or the memory available for the files is full.
---	--

	<p>Backup of the current configuration. The window below is displayed:</p>
	<p>You can enter:</p> <ul style="list-style-type: none"> ■ a configuration name ■ remarks ■ save it in .cfg format <p>by clicking the <u>green</u> arrow.</p>  <p> The max. internal memory is 1GB.</p>

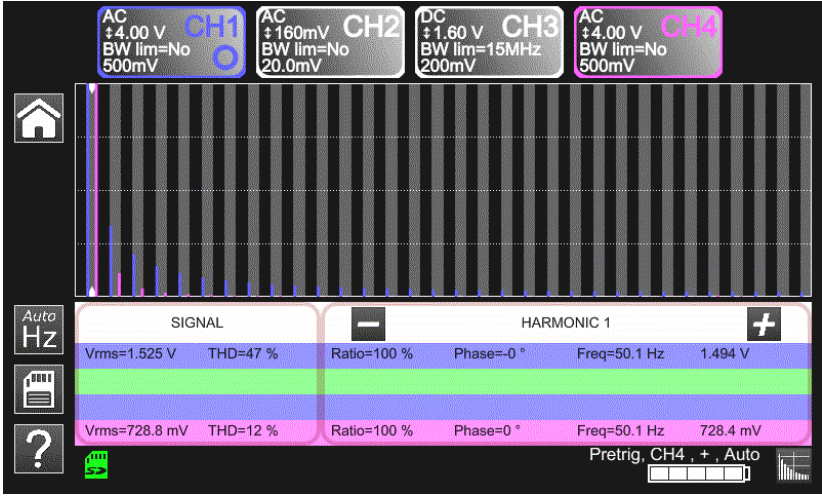
 **To return to the Multimeter mode, click .**

7. HOW ARE HARMONICS ANALYZED ?

	
	<p>It is possible to go from harmonic to harmonic using the + and - keys.</p> <p>These numerical characteristics are obtained:</p> <ul style="list-style-type: none"> ▪ value in % of the harmonic of greatest amplitude ▪ phase in ° with respect to the fundamental ▪ frequency in Hz ▪ RMS voltage in V
	<p>You use this key to save these settings:</p> <ul style="list-style-type: none"> ▪ Click setup. ▪ Then,  , default file name.
	<p>You use this key to save these settings:</p> <ul style="list-style-type: none"> ▪ Click meas. <div style="border: 1px solid black; padding: 5px; margin: 10px auto; width: fit-content;"> <div style="text-align: center; border-bottom: 1px solid black; margin-bottom: 5px;">Type</div> <div style="display: flex; justify-content: space-around;"> Setup Meas. </div> </div>

8. TECHNICAL CHARACTERISTICS

8.1. "Oscilloscope" function

Only the assigned tolerance or limit values are guaranteed values (after a half-hour warm-up period). The values without tolerances are given as an indication

Vertical deflection

Characteristics	OX 9062	OX 9102 OX 9104	OX 9304	
Number of channels ¹	2	OX 9xx2: 2, OX 9xx4: 4		
Vertical ranges	2.5mV to 200V/div. Variation in steps (no continuously variable coefficient)			
BW to 3dB down	60MHz	100MHz	300MHz	
	Measured into a 50Ω load with a signal having an amplitude of 6 div.			
Max. input voltage ²	1400 VDC, 1kVrms with the Probix HX0030 probe			
Types of input	Probix safety connector: class 2, isolated inputs			
Dynamic of the vertical offset	±10 divisions in all ranges			
Input coupling	AC DC GND	10Hz to 60MHz 0 to 60MHz reference	10Hz to 100MHz 0 to 100MHz reference	10Hz to 300MHz 0 to 300MHz reference
Bandwidth limiters	at ≈15MHz, 1.5MHz, 5kHz			
Rise time in all vertical ranges. 2.5mV to 200V/div.	≈5.85ns	≈3.5ns	≈1.17ns	
Cross-talk between channels	>70dB (Same sensitivity in both channels)			
Response to rectangular signals at 1kHz and 1MHz	Positive or negative overshoot Overshoot ≤ 4%			
Vertical resolution of the display	±0.4% of full scale (without ZOOM) 0.025% in ZOOM mode (12 bits)			
Accuracy of the peak-to-peak gains	±2% with averaging from 4 to 1kHz			
Accuracy of the vertical measurements in DC with offset and averaging over 16	±[2.2% (reading) + 11% (sensitivity) + 400 μV] applies to the following measurements: Vmin, Vmax, Vlow, Vhigh, Vavg, curs(1), curs(2)			
Accuracy of the vertical measurements in AC without offset at 1kHz with averaging over 16	±[2% (reading) + 1% (sensitivity)] applies to the following measurements: Vamp, Veff, Dep+, Dep-			
Resolution of the measurements	12 bits			
Accuracy of the vertical offset	±[0,2% (reading) + 10% (sensitivity) + 400 μV]			
Vertical ZOOM function on an acquired or saved curve	ZOOM factors: 16 max.			
Input impedance	1 MΩ ±0.5% approx. 12 pF			

¹ Instruments with two channels: CH1 and CH4, instruments with four channels: CH1, CH2, CH3, CH4

² Refer to the figure (§ 9.4.3.): max. input voltage as a function of frequency

Horizontal deflection (time base)

Characteristics	OX 9062 - OX 9102 - OX 9104 - OX 9304
Time base ranges	35 ranges, from 1ns to 200s/div.
Accuracy of the time base	$\pm[0.0005\% + \max(500\text{ps}, 1 \text{ sample})]$
Sampling frequency	2.5GS/sec. in real time 100GS/sec. on repetitive signal
Accuracy of the time measurements	$\pm[(0.02 \text{ div.}) \times (\text{time/div.}) + 0.01 \times \text{reading} + 1\text{ns}]$
Horizontal ZOOM	Zoom coefficient: x1 to x100 The oscilloscope has a memory capacity of 100,000 pts per channel.
	in ZOOM mode, the sequence of time base ranges is the same as in the normal mode. <i>The horizontal resolution of the screen is 2500 points for 10 divisions.</i>
XY mode	The bandwidths are the same in X and in Y (see § vertical deflection). <i>As in the standard mode, the sampling frequency depends on the time base.</i>
Phase error	$<3^\circ$
Representation Fast Fourier Transform	in time or frequency domain (FFT) <ul style="list-style-type: none"> ▪ calculation on the traces present in the screen zone ▪ dynamic refresh according to the signal observed in RUN mode ▪ windowing: rectangle, hamming, Hanning, Blackman ▪ scales: logarithmic or linear ▪ automatic adjustment thanks to the autose

Triggering circuit

Characteristics		OX 9062	OX 9102 OX 9104	OX 9304
Triggering sources		CH1, CH4	CH1, CH2, CH3, CH4 (OX 9xx4) CH1, CH4 (OX 9102)	
Triggering mode		Automatic Triggered Single-shot Auto Level 50%		
BW on triggering without band limitation	AC	10Hz to 100MHz	10Hz to 200MHz	≥10Hz
	DC	0Hz to 100MHz	0Hz to 200MHz	0Hz to BW max ³
	HF reject	0Hz to 10kHz	0 to 10kHz	0 to 10kHz
	BF reject	10kHz to 100MHz	10kHz to 200MHz	≥10kHz
		<i>If bandwidth limitation is activated, the BW of the triggering is also reduced.</i>		
Triggering slope		Negative- or positive-going edge		
Triggering sensitivity		0.6 div. (0Hz to 50MHz) 1.2 div. (50MHz to 100MHz)	0.6 div. (0Hz to 50MHz) 1.2 div. (50MHz to 200MHz)	0.6 div. (0Hz to 50MHz) 1.2 div. (50MHz to 200 max.) 1.5 div. (200MHz to BW max.)
Noise rejection		≈ ±1.5 div.		
Triggering level Range of variation		±10 div.		
Type of triggering		on edge	- Triggering source: CH1 (CH2) (CH3) CH4	
		on pulse width	<T1; >T2; ∈ [T1, T2]; ∉ [T1, T2] with T1 and T2 ∈ [16ns, 20 s]	
		triggering after delay	- from 48ns to 20s - Source of qualifier: CH1 (CH2) (CH3) CH4 - Triggering source: CH1 (CH2) (CH3) CH4	
		triggering after counting	- from 3 to 16,384 events - Source of qualifier: CH1 (CH2) (CH3) CH4 - Counting source: CH1 (CH2) (CH3) CH4 - Triggering source: source of the qualifier or of the counting	
Holdoff		Adjustable from 64ns to 15 sec.		

³ BW max: maximum bandwidth determined by the vertical sensitivity of the channel

Acquisition system

Characteristics	OX 9062 - OX 9102 - OX 9104 - OX 9304
Resolution of the ADC	12 bits
Maximum sampling frequency	2.5GS/s in real time 100GS/s with repetitive signal (ETS) according to time base 1 converter per channel
Capture of transients MIN/MAX mode	Minimum width of Glitches that can be detected: ≥ 2 ns In the range [1ns 5ms]: 1250 MIN/MAX couples stored in 100,000-pt acquisition memory. In the range [20ms 200s]: 50,000 MIN/MAX couples
Depth of acquisition memory reconstituted	100,000 pts per channel
PRETRIG	0-9.5 div. 0-950 div. (zoom)
POSTRIG	0-20 div. 0-2000 div. (zoom)

Format of the various files

Characteristics	OX 9062 - OX 9102 - OX 9104 - OX 9304
Backup memories	Local file system. The user's files are stored in a specific partition. System of files on SD Card. The partitions of the SD Card can be accessed in the sdcard_pX directory of the local file system.
Size of memory available for the file system	<ul style="list-style-type: none"> ▪ Internal memory of the instrument: 1GB ▪ with "Micro SD" card of type SC (≤ 2GB), HC (> 2GB ≤ 32Go) or XC (> 32GB ≤ 2TB) with its partition(s) formatted in FAT32
The files of traces acquired in SCOPE mode Extension: .trc	Binary format Size: ≈ 400 kb per trace stored (max: 1.6MB)
The files of traces acquired in LOGGER mode Extension: .rec	Binary format Size: ≈ 400 ko per trace stored (max: 1.6Mo)
Configuration files Extension: .cfg	Binary format Size: ≈ 1 ko
Printing files Extension: .png	Size: < 200 ko
Files of mathematical functions Extension: .fct	Text format Size: < 1 ko
Files containing text Extension: .txt	Text format Files with the .TXT extension can contain measurements made in the instrument's various acquisition modes.
.txt file containing measurements made in HARMONIC mode	Size: < 10 ko

Processing of measurements

Mathematical functions	Equation editor (functions on the channels or simulated functions): Addition, subtraction, multiplication, division, and complex functions between channels.	
Automatic measurements	<p style="text-align: center;">Time measurements</p> <ul style="list-style-type: none"> rise time fall time positive pulse negative pulse duty cycle period frequency phase counting integral 	<p style="text-align: center;">Level measurements</p> <ul style="list-style-type: none"> DC voltage RMS voltage peak-to-peak voltage amplitude max. voltage min. voltage upper sup. lower plateau. overshoot
Resolution of the measurements	12 bits/display on 4 digits	
<p>Measurements by cursors or automatic measurements</p> <p style="margin-left: 40px;"><i>Accuracy of vertical measurements in DC</i></p> <p style="margin-left: 40px;"><i>Accuracy of time measurements with 2 cursors</i></p>	<p>$\pm[1\% \times (\text{reading} - \text{offset}) + \text{accuracy of the vertical offset} + (0.05 \text{ div.}) + (V/\text{div.})]$</p> <p>$\pm[0.02 \times (t/\text{div.}) + 0,01\% (\text{reading}) + 1\text{ns}]$</p> <p>In XY mode, the cursors are not attached to the curve.</p>	

Display

Characteristics	OX 9062 - OX 9102 - OX 9104 - OX 9304	
Display screen	LCD 7" TFT (colour display)	
	Backlighting by LEDs	
Brightness	Continuous adjustment	
Resolution	WVGA, or 800 pixels horizontally x 480 pixels vertically	
Screen saver	Choice of delays: 15', 30', 1h, or none	
Display without Zoom	Complete memory: 100,000	
Horizontal ZOOM	2500 pts out of the 100,000 of the complete memory	
Display modes	<i>Vector</i>	Points acquired, points interpolated, average Linear interpolation between 2 acquired pts.
	<i>Envelope</i>	Display of the min. and of the max., on each abscissa, acquired on several bursts.
	<i>Average</i>	Over: no averaging, 2, 4, 16, 64
	<i>The entire acquisition</i>	Display of all samples acquired in a burst with linear interpolation between 2 acquired pts
Indications on the screen	<i>Triggering</i>	Position of the triggering level (with coupling and overshoot indicator) Position of the Trigger point on the bargraph and on the top edge of the screen (with overshoot indicators) Identifiers of traces, activation of the traces Position, Sensitivity Ground reference
	<i>Traces</i>	High and low overshoot indicators, if traces outside screen

Various

Signal for calibration of the 1/10 probes	Form: rectangular Amplitude: $\approx 0-3V$ Frequency: $\approx 1kHz$ <i>Connect the cold of the probe to the cold of the calibration output of the probes.</i>
Autoset	<i>Search time</i> <5s <i>Frequency range</i> >30Hz <i>Amplitude range</i> 15mVpp to 400 Vpp <i>Limits of duty cycle</i> from 20 to 80%

8.2 "Multimeter" and "LOGGER" function

Only the assigned tolerance or limit values are guaranteed values (after a half-hour warm-up period). The values without tolerances are given as an indication.

Display	8,000 points as voltmeter				
Input impedance	1MΩ				
Max. input voltage	600 Vrms sine and 800 VDC without probe 1000 Vrms and 1400 VDC with HX0030 probe				
DC measurement					<u>HX0030</u>
<i>Ranges</i>	0.8V	8V	80V	800V	8kV
<i>Resolution</i>	0.1mV	1mV	10mV	0.1V	1V
<i>Accuracy</i>	± (0.5 % + 25 D) in DC from 10% to 100% of the scale				
<i>Common mode rejection</i>	>70dB at 50 or 60 or 400Hz				
AC and AC+DC measurements					<u>HX0030</u>
<i>Ranges</i>	0.6V 0.8V	6V 8V	60V 80V	600 Vrms sine 800 Vpeak	6kVrms 8kVdc
<i>Resolution</i>	0.1mV	1mV	10mV	0.1V	1V
<i>Accuracy in coupling</i> <i>AC + DC</i> <i>Filters inactive</i>	± (1% + 25 D) from DC to 1kHz		from 10% to 100% of the scale (peak)		
	± (2% + 25 D) from >1kHz to 10kHz		id.		
	± (3% + 25 D) from >10kHz to 200kHz		id.		
<i>AC</i> <i>Filters inactive</i>	± (1% + 25 D) from 40Hz to 1kHz		id.		
	± (2% + 25 D) from >1kHz to 10kHz		id.		
	± (3% + 25 D) from >10kHz to 200kHz		id.		
<i>Common Mode Rejection</i>	>70dB at 50, 60 or 400Hz				
<i>Digital filter</i>	<ul style="list-style-type: none"> - Low-pass filter - Cutoff frequency 625Hz - Order 94 - Bandwidth ripple 0.5dB - Transition band 0.02 - Stopband attenuation 50dB 				

Resistance measurement	<i>In Channel 1</i>		
<i>Ranges (full scale)</i>	Ohmmeter	Resolution	Measurement current
	80Ω	0.01Ω	500μA
	800Ω	0,1Ω	50μA
	8kΩ	1Ω	50μA
	80kΩ	10Ω	2μA
	800kΩ	100Ω	2μA
	8MΩ	1000Ω	50nA
	32MΩ	10kΩ	50nA
<i>Accuracy</i>	±(0.5% + 25 D) from 10% to 100% of the scale		
<i>Open-circuit voltage</i>	≈3V		
Continuity measurement	<i>In Channel 1</i>		
<i>Beeper</i>	<30Ω ±5Ω		
<i>Measurement current</i>	≈0,5mA		
<i>Beeper response</i>	<10ms		
Diode test	<i>In Channel 1</i>		
<i>Voltage</i>	Open-circuit: ≈ + 3.3V		
<i>Accuracy</i>	±(0.5% + 5 D)		
<i>Measurement current</i>	≈ 0.6mA		
Capacitance measurement	<i>In Channel 1</i>		
<i>Ranges</i>	Capacitance meter	Resolution	Measurement current
	5mF	1μF	500μA
	500μF	0,1μF	500μA
	50μF	0,01μF	500μA
	5μF	1nF	50μA
	500nF	100 pF	50μA
	50nF	10 pF	2μA
	5nF	1 pF	2μA
<i>Accuracy</i>	- in the 5nF range (measurement with a shielded lead): from 500 pF to 1nF: ±(6% +10 D) from >1nF to 2nF: ±(4% +10 D) >2nF: ±(2% +10 D) - in the other ranges: ±(2% +10 D) from 10% to 100% of full scale		
<i>Cancellation of series and parallel R</i>	parallel R >10 k Use the shortest possible leads.		
Frequency measurement	from 20Hz to 200kHz on a square- and sine-wave signal from 20Hz to 20kHz on a triangular signal Accuracy: 0.2%		
Power measurement			
<i>active</i>	± (2% +25 D) from 40 to 1kHz		
<i>reactive</i>	± (4% +25 D) from 1 to 10kHz		
<i>apparent</i>	± (6% +25 D) from 10 to 200kHz		

Operating modes

<i>Relative mode</i>	Display with respect to a base measurement	The Relative, Surveillance, and Frequency modes are mutually exclusive.
<i>Surveillance (statistical)</i>	on all measurements in MAX MIN value	
<i>Frequency</i>	The frequency can be displayed in AC mode	
<i>Interval of time between 2 measurements</i>	0.2s	
<i>Duration of the records (LOGGER mode)</i>	Each file contains 100,000 measurements, or an acquisition time of 20,000 seconds. Automatic sequential recording (N files of 100,000 measurements)	
<i>RUN (MULTIMETER mode)</i>	Measurements started	
<i>HOLD (MULTIMETER mode)</i>	Measurement frozen	

Display

<i>In digital form</i>	- of the main measurement → large display - of a secondary measurement → small display The type of secondary measurement can be selected in the menu.
<i>Graphic plot (LOGGER mode)</i>	History of measurements over time
<i>Number of measurements represented on a trace</i>	100,000

8.3 "VIEWER" function

The "VIEWER" function is used to read a file acquired in "LOGGER" mode.

Horizontal zoom	Zoom coefficient: x1 to x100 The oscilloscope has a memory capacity of 100,000 pts per channel.
Vertical zoom	ZOOM factors: maximum 16
Accuracy of measurements by cursors, vertical	$\pm [1\% \times (\text{reading} - \text{offset}) + \text{accuracy of the vertical offset} + (0.05 \text{ div.}) + (V/\text{div.})]$
Accuracy of measurements by cursors, time	$\pm [0.02 \times (t/\text{div.}) + 0.01\% (\text{reading}) + 1\text{ns}]$

8.4 "HARMONIC ANALYSIS" function

- Presentation of the harmonics in bargraph form
- Crosshair with vertical axis graduated in %
- Horizontal axis graduated in orders of harmonic
- Display of 63 orders
- The harmonic analysis function can be implemented on the 4 channels
- Display of the measurements made:
 - RMS level of the signal
 - total harmonic distortion with respect to the RMS value of the fundamental (THD).
 - RMS level of the harmonic selected
 - ratio in % of the RMS value of the selected harmonic to the RMS value of the fundamental
 - frequency of the selected harmonic
 - phase of the selected harmonic/fundamental

Harmonic analysis

Frequency of the fundamental of the signal analyzed	from 40 to 450Hz	Condition
Accuracy of the measurements	In the domain of reference: 18°C to 28°C, at 50Hz and 60Hz	
<i>Level of the Fundamental</i>	$\pm(2\% + 10 D)$	ratio >4%
<i>Level of the Harmonics</i>	$\pm(3\% + 10 D)$, ratio $\pm 2\%$	
<i>Harmonic distortion (THD)</i>	$\pm 4\%$	
<i>Phase</i>	$\pm 5\%$	ratio >4%
Variations in the nominal range of use	0°C to 40°C, at 50Hz and 60Hz	
<i>Level of the Fundamental</i>	$\pm(5\%/10^\circ\text{C})$	ratio >4%
<i>Level of the Harmonics</i>	$\pm(5\%/10^\circ\text{C})$, ratio $\pm(1\%/10^\circ\text{C})$	
<i>Harmonic distortion (THD)</i>	$\pm(5\%/10^\circ\text{C})$	
<i>Phase</i>	$\pm(10^\circ/10^\circ\text{C})$	ratio >4%

8.5. "Communication"

8.5.1. Communication port and peripherals

ETHERNET	100Base-T, electrically isolated (peripheral) The 600V, CAT III isolation is implemented inside the instrument. ETHERNET isolation by transformer USB isolation by logical isolator
WIFI	WEP, WPA
USB	Electrically isolated CDC (Communication Device Class) ACM (Abstract Control Model) protocol to submit SCPI queries MS (Mass Storage) protocol to manipulate the file system of SCOPIX IV (and its SDCARD). RNDIS (Remote Network Driver Interface Specification) to communicate via USB using the TCP/IP protocol
SDCARD	Transfer of files between the scope and a PC type computer by memory card, Micro SD format (type SC, HC, or XC). The file system supported is FAT32.

8.5.2. Applications

SCOPENET	Accessible via ETHERNET, WIFI, or USB using a browser. To access it, type the following line in the navigation bar of: FIREFOX/CHROME/EXPLORER: http://<IP address>  Example: http://192.168.1.1 This application uses IP ports 50 000 and 50 010 (it may be necessary to so inform the Firewall installed on the PC).
Access to the file system from a PC	via USB: using the RNDIS protocol (and the corresponding driver)
SCPI	via USB: using the CDC ACM protocol (and the corresponding driver) via ETHERNET: on port 23 via WIFI: on port 23

9. GENERAL CHARACTERISTICS

9.1. Nominal range of use

9.1.1. Environmental conditions

Reference temperature	: + 18°C to + 28°C
Temperature of use	: °C to + 40°C
Temperature of storage	: - 20°C to + 70°C
Relative humidity	: <80% RH → + 35°C; <70% from 35°C to 40°C (limited to 70% in the 8MΩ and 32MΩ ranges)
Altitude	: <2000m

9.1.2. Variations in the nominal range of use

Quantities of influence	Range of influence	Quantity influenced	Error	
			Typical	Max.
Battery voltage	9.4V to 12.6V	All	-	-
Temperature	0°C to 40°C	<u>Oscilloscope</u> Accuracy of the vertical gain Accuracy of the position Accuracy of the triggering level Accuracy of the automatic measurements	±0.5% per 10°C	±1% per 10°C
		Accuracy of the time base		
	0°C to 40°C	Bandwidth, overshoot	±2.5% per 10°C	±5% per 10°C
	0°C to 40°C	<u>Multimeter</u> Accuracy of DC measurements	±0.5% per 10°C	±1% per 10°C
		Accuracy in AC+DC	±0.5% per 10°C	±1% per 10°C
		Accuracy of measurement of resistance of diodes of capacitance	±0.5% per 10°C	±1% per 10°C
		Accuracy of the frequency counter	±0.1% per 10°C	±0.2% per 10°C
	0°C to 40°C	<u>Measurements of harmonics of the network</u> Accuracy of the fundamental Accuracy of the harmonics Accuracy of the distortion	±3% per 10°C	±5% per 10°C
		Accuracy of the phase		
Electromagnetic field	10V/m	<u>Oscilloscope</u> Vertical noise	5mV _{pp}	7.5mV _{pp}
		<u>Ohmmeter</u> Accuracy of measurements	0 - 2%	5% of full scale
Humidity	0% to 70%	<u>All measurements</u>	-	-
Temperature	70% to 80%	<u>All measurements from 0°C to 35°C except 8 MΩ and 32 MΩ ranges</u>	-	-

9.1.3. Power supply

Battery voltage	: >9.5V; 10.8V nominal
or mains supply	: connected to network at 230V ± 15% 50Hz or 110V ± 15%, 60Hz (therefore operates from 98V to 264V).

9.2. Mechanical characteristics

9.2.1. Hard enclosure covered with elastomer

Comprising :

- a lower housing,
- a central belt holding all terminations,
- an upper housing,
- a battery compartment cover.

- Dimensions: 292.5x210.6x66.2mm
- Weight: approximately 2.4 kg with the battery
- Carrying strap: snaps onto the top of the instrument

9.2.2. Mechanical conditions

- **Tightness**

Tight to drops of water falling vertically and penetration of objects ≥ 1 mm: IP 54 (instrument not in operation)

Instrument alone, without accessories or mains power supply, upright, tilted 40° on its prop or flat with LCD up.



Remarks:

1. ***Do use not the instrument in a atmosphere laden with carbon dust, metallic dust, or other conducting dust.***
2. ***Wipe the instrument, in particular the measurement terminals, before using again.***

- **Shocks and impacts**

Per the test standards of IEC 62262: IK03 (LCD screen) and IK06 (any other part of the instrument)

3 impacts with an energy of 1 Joule (IK06) or 0.35 Joule (IK03), applied to each component part of the instrument, without deterioration that might create a risk for the safety of the user.

- **Free fall, without packaging.**

Instrument alone, without accessories, on 3 sides.

Per the test standards of IEC 61010-1-2010.

9.3. Electrical characteristics

9.3.1. Battery power supply

- Li-Ion technology
- Nominal voltage: 10.8V
- Operating voltage: 10V to 12V
- Capacity:
 - 5800mAh/62 Wh (model 695065A00)
 - 6900mAh/74 Wh (model 695066A00)
- Battery protected from short circuits by resettable fuse
- Life between charges (model 695065A00):
 - ≈ 5h30' for the two-channel models
 - ≈ 4h for the four-channel models
- Charging time: ≤ 7 hours depending on charger type

9.3.2. Line power

- DC supply, approximately 15V, 30W for the operation of the instrument
- DC supply, approximately 11V, 15W to charge the battery
- Primary circuit characteristics: 98V < Input voltage < 264V
- Therefore operates on the following networks:
 - 230V, ±15%, 50Hz
 - 115V, ±15%, 60Hz

9.4. CEM and safety

9.4.1. Electromagnetic compatibility

The products are compliant with the standards and any respective amendments, in their industrial classification:

 IEC 61326-1 with a quantity of influence in the presence of a magnetic field of 10V/m

9.4.2. Electrical safety

 IEC 61010-1 (2010 + amendment 1)

 IEC 61000-2-030 (2017)

Electrical safety without accessories	600V CAT III, double isolation
Max. input voltage without accessories	300 V _{dc} , 300 V _{rms} , 414 V _{pk} (DC + peak AC at 1kHz)

Derating values

a) Electrical safety:

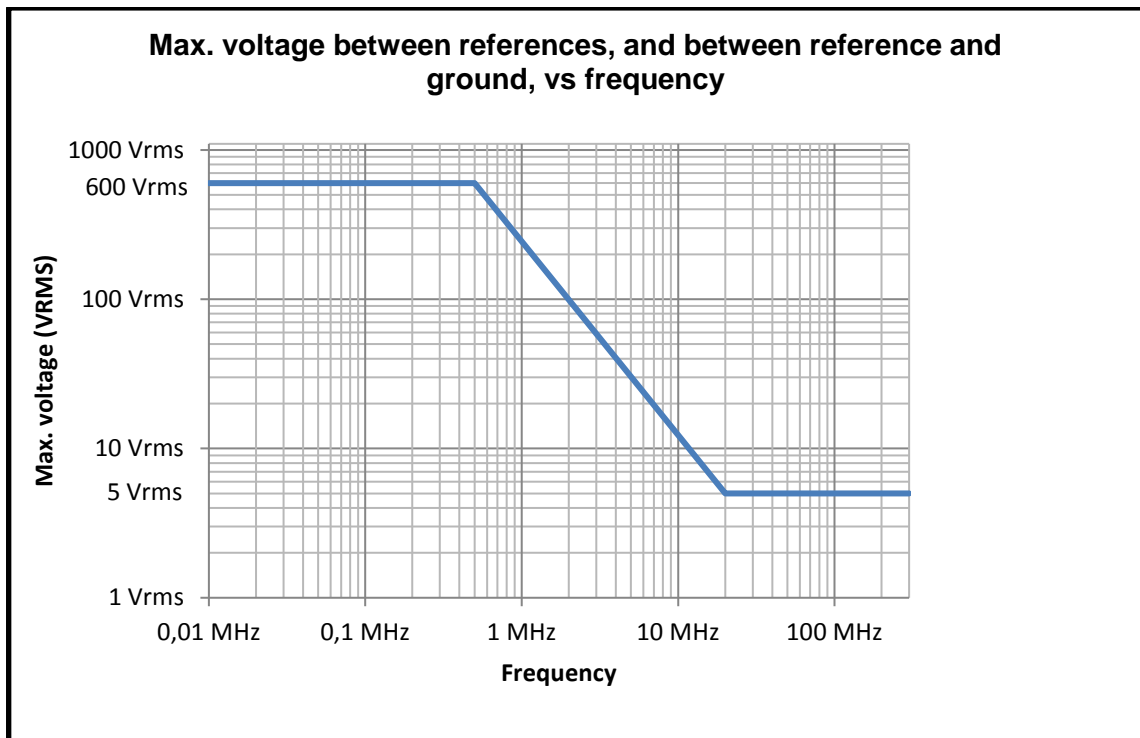

b) Input voltage:

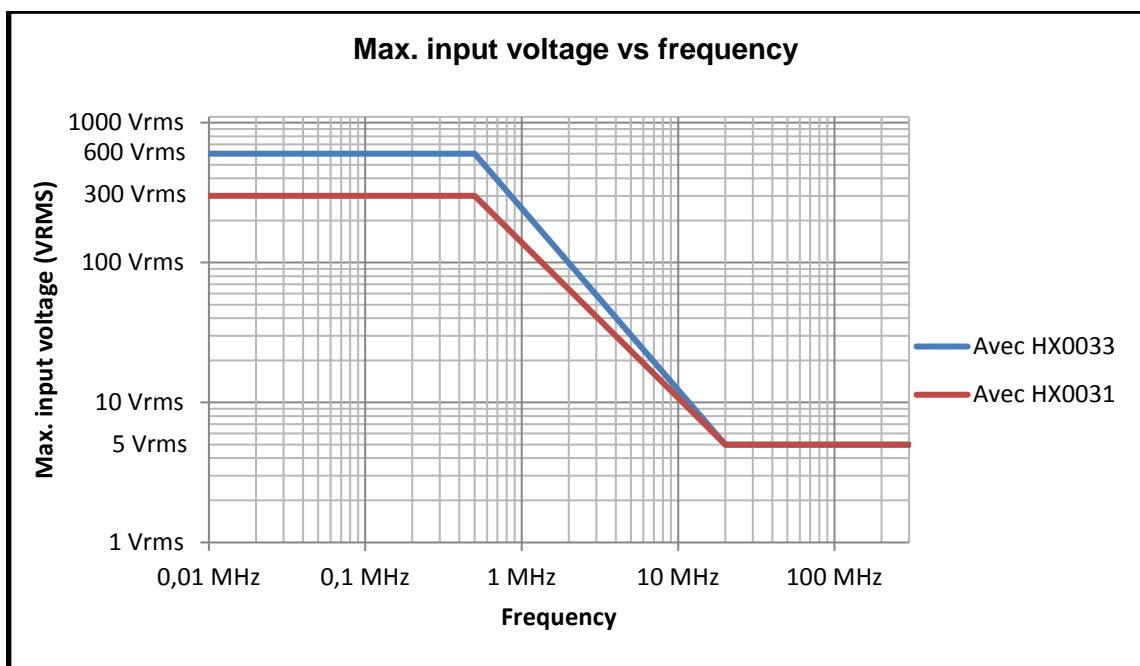

9.4.3. Temperature

Max. internal temperature: 85°C when the max. ambient temperature is 40°C.

10. MAINTENANCE

10.1. Warranty

	<p>This oscilloscope is guaranteed for three 3 years against defects of materials or workmanship, in accordance with the general terms of sale.</p> <p>During this period, the instrument must be repaired only by the manufacturer, which reserves the right either to repair the instrument or to replace all or part of it. If the equipment is sent back to the manufacturer, the customer pays for shipping to the manufacturer.</p> <p>The warranty does not apply in the following cases:</p> <ul style="list-style-type: none">▪ Inappropriate use of the equipment or use with incompatible equipment;▪ Modifications made to the equipment without the explicit permission of the manufacturer's technical staff;▪ Work done on the device by a person not approved by the manufacturer;▪ Adaptation to a particular application not anticipated in the definition of the equipment or not indicated in the user's manual;▪ Damage caused by shocks, falls, or floods.
---	---

10.2. Cleaning

	<ul style="list-style-type: none">▪ Power down the instrument.▪ Clean it with a damp cloth and soap.▪ Never use abrasive substances, solvents, alcohol, or hydrocarbons.▪ Let dry before using again.
---	--

10.3. Repair and metrological verification

See attached safety data sheet.

Warning!	<p><i>In all cases, if you find a defect (screen broken, Probix socket broken, housing defective, etc.) do not use your Scopix, since its insulation may be impaired. Return it without delay to customer service for repair.</i></p>
-----------------	---

11. REMOTE PROGRAMMING

11.1. Introduction

Programming convention

Tree concept The SCPI commands have a branching structure. A command must end with a terminator, <NL> or <;>. If commands are separated by the character <;> and are located in the same directory, there is no need to repeat the whole tree. Otherwise, use the <:> character followed by the full name of the command.

Example `DISP:TRAC:STAT1 1<NL>`
`DISP:TRAC:STAT2 1<NL>`
 equivalent to:
`DISP:TRAC:STAT1 1; STAT2 1<NL>`
 equivalent to:
`DISP:TRAC:STAT1 1; DISP:TRAC:STAT2 1<NL>`

Command syntax

Common commands →

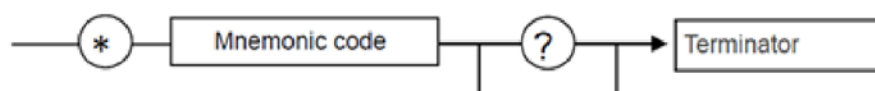

Specific commands →

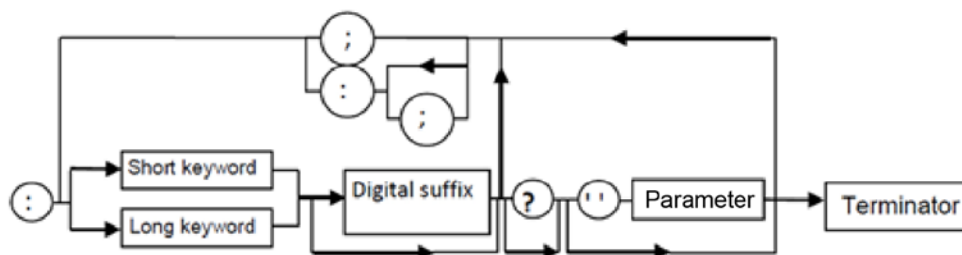

Key words Square brackets ([]) enclose a key word that is optional in the programming. Upper-case and lower-case are used to differentiate the short form of a key word (upper-case letters) from the long form (whole word).

The instrument accepts upper-case and lower-case letters without distinction.

Example `DISP:TRAC:STAT 1` is equivalent to `DISPLAY:WINDOW:TRACE:STATE 1`

Separators

": "	goes down to the next directory or returns to under the root, if preceded by a ":"
"; "	separates 2 commands in the same directory
" "	(space) separates the key word from the next parameter
","	separates one parameter from the next

Parameters

<>	The parameters of a specified type are noted by the characters shown opposite.
[]	The square brackets mean that the parameter(s) are optional.
{ }	The braces define the list of allowed parameters.
	The vertical bar can be read as "or". It is used to separate the various possible parameters.

Format of the parameters The parameters can be key words, digital values, character strings, or digital expressions.
The interpreter is case-insensitive.

Key words The key words can take two forms, like the instructions:
the abbreviated form (in upper-case)
The complete form (abbreviated form plus lower-case complement).
Thus, for some commands, we will find the parameters:
ON, OFF corresponding to the Boolean values (1,0)
EDGE, PULse, DELay, EVENT or **TV** for the triggering modes.

Digital values These are numbers having several possible formats:

NR1 The parameter is a signed integer.

✎ *Example:* 10

NR2 The parameter is a signed real without exponent.

✎ *Example:* 10.1

NR3 The parameter is a signed real expressed with a mantissa and a signed exponent.

✎ *Example:* 10.1e-3

NRf (flexible Numeric Representation).

In the case of a physical quantity, these numbers can be followed by a multiple and its unit.

Units

V	Volt (Voltage)
S	Second (Time)
PCT	Percent (Percentage)
Hz	Hertz (Frequency)
MHz	Mega-Hertz (Frequency)
F	Farad (Capacitance)
OHM	Ohm (Resistance)
DEG	Degree Celsius

Multiples

MA	Mega: 10^{+6}
K	Kilo: 10^{+3}
M	Milli: 10^{-3}
U	Micro: 10^{-6}
N	Nano: 10^{-9}
P	Pico: 10^{-12}

✎ *Example:* to enter a duration of 1 microsecond in NRf format,
it will be possible to write, at will: 1µs, 0.000001, 1e-6s, 1E-3ms, etc.

Special values

MAXimum, **MINimum** are used to obtain the extreme values of the parameter.
UP, **DOWN** are used to go to the value following or preceding the current state of the parameter.

Character strings

These are series of letters and/or digits enclosed in quotation marks " ".

Terminator

<NL> We use **<NL>** as the general term designating a terminator.

NL is the CR character (ASCII code 13 or 0x0D).

A command line must not be more than 80 characters long; it is terminated by a terminator.

Syntax of replies

The reply can comprise several elements separated by a comma ",". The last element is followed by the terminator **<NL>**.

The data are of several kinds:

Key words

These are the same as those used as parameters, but here only the abbreviated form is returned.

Digital values

Three formats are possible: NR1, NR2, and NR3.

Character string

There is no difference with respect to the parameters. If the string contains a key word, it is returned in abbreviated form.

11.2. Commands specific to the instrument

ABORt (Command)

The **ABOR** command aborts the acquisition in progress.

If the instrument is set in the single mode, the acquisition is stopped. The instrument stays in the starting status.

If the instrument is in continuous mode, the acquisition in progress is stopped and the following starts.

Note : if no acquisition is running, this command has no effect.

ARM[:SEQuence{[3][4]}
:COUPling (Command/Query)

The **ARM:COUP <AC|DC>** command determines the coupling associated to the trigger auxiliary source.

To the question **ARM:COUP?**, the instrument returns the coupling associated to the trigger auxiliary source.

ARM[:SEQuence{[3][4]}
:FILTer:HPASs[:STATe] (Command/Query)

The **ARM:FILT:HPAS <1|0|ON|OFF>** command validates or devalidates the reject of the low frequencies associated to the trigger auxiliary source.

- 1|ON: activates the reject of the low frequencies (LF Reject coupling)
- 0|OFF: deactivates the reject of the low frequencies; the coupling DC is then activated.

To the question **ARM:FILT:HPAS?**, the instrument returns the activation status of the low frequencies reject associated to the trigger auxiliary source.

ARM[:SEQuence{[3][4]}
:FILTer:LPASs[:STATe] (Command/Query)

The **ARM:FILT:LPAS <1|0|ON|OFF>** command validates or devalidates the high frequencies reject associated to the trigger auxiliary source.

- 1|ON: activates the high frequencies reject (HF Reject coupling)
- 0|OFF: deactivates the high frequencies reject ; the DC coupling is then activated.

To the question **ARM:FILT:LPAS?**, the instrument returns the activation status of the high frequencies reject associated to the trigger auxiliary source.

ARM[:SEQuence{[3][4]}
:HYSTeresis (Command/Query)

The **ARM:HYST<hysteresis>** command sets the amplitude of the hysteresis which rejects the noise associated to the trigger auxiliary source.

<hysteresis> is a value in format NR1 with following values :

- 0: no noise rejection, hysteresis is about 0.5 div.
- 3: activated noise rejection, hysteresis is about 3 div.

To the question **ARM:HYST?**, the instrument returns the amplitude of the hysteresis used for the noise rejection associated to the trigger auxiliary source.

ARM[:SEQuence{[3][4]}
:LEVel (Command/Query)

The **ARM:LEV <level|MAX|MIN|UP|DOWN>** command sets the trigger level of the auxiliary source.

<level> is a value in format <NRf>, it may be followed or not by a multiple and by the unit.

By default, the value is expressed in volt.

To the question **ARM:LEV?**, the instrument returns the trigger level of the auxiliary source.

Response format: <measured value><NL>

value in format <NR3> expressed in volt.

ARM[:SEQuence{[3][4]}
:SLOPe (Command/Query)

The **ARM:SLOP <POSitive|NEGative>** command determines the trigger front of the auxiliary source.

POSitive: rising front 

NEGative: falling front 

To the question **ARM:SLOP?**, the instrument returns the polarity of the trigger front of the auxiliary source.

ARM[:SEQuence{[3][4]} :SOURce	(Command/Query) The ARM:SOUR <INTERNAL{1 2 3 4}> command determines the auxiliary trigger source of the instrument. INTERNAL{1 2 3 4} corresponds to the trigger source (1, 2, 3, 4 channels) of the instrument on SCOPIX and SCOPIX BUS. To the question ARM:SOUR? , the instrument returns the used trigger auxiliary source.
AUTOSet:EXEcute	(Command) The AUTOS:EXE command starts an autoset on each active channel.
CALCulate:MATH {[1] [2 3 4]}[:EXPRession] [:DEFine]	(Command/Query) The CALC:MATH{[1][2 3 4]} <(function)> command defines and activates the mathematical function of the selected signal. <function> is the definition of the mathematical function. (ch1-ch2) subtracts the channel 1 from channel 2. To the question CALC:MATH{[1][2 3 4]}? , the instrument returns the mathematical function of the selected signal.
CALCulate:MATH {[1] [2 3 4]}[:EXPRession] :DELete	(Command) The CALC:MATH{[1][2 3 4]}:DEL command deletes the mathematical function of the selected signal.
CALCulate:TRANsform :FREQuency[:STATe]	(Command/Query) The CALC:TRAN:FREQ <1 0 ON OFF> command activates the FFT calculation. To the question CALC:TRAN:FREQ? , the instrument returns the activation status of the FFT calculation.
CALCulate:TRANsform :FREQuency:WINDow	(Command/Query) CALC:TRAN:FREQ:WIND <RECTangular HAMMING HANNing BLACKman FLATtop> window used for the FFT calculation. To the question CALC:TRAN:FREQ:WIND? , the instrument returns the type of window used for the FFT calculation.
DEVice:MODE	(Command/Query) The DEV:MOD <SCOPE ANALYSer LOGger MULTimeter> command selects the principal mode of the instrument. To the question DEV:MOD? , the instrument returns the mode in which it has been configured.
DISPlay: BRIGhtness	(Command/Query) The DISP:BRIG <brightness> command sets the backlight intensity of the screen. <backlight> is a value in format <NRf> without unit, in the range [0.0 1.0] To the question DISP:BRIG? , the instrument returns the backlight level of the screen.
DISPlay[:WINDow]:CURSor :REFerence	(Command/Query) The DISP:CURS:REF <INT{1 2 3 4}> command selects the reference for the automatic and manual measurements. To the question DISP:CURS:REF? , the instrument returns the signal used as reference.

- DISPlay[:WINDow]:CURSor (Command/Query)
 :STATe The **DISP:CURS:STAT <1|0|ON|OFF>** command activates or inhibits the manual measurements.
- 1|ON: activates the manual measurements
 - 0|OFF: inhibits the manual measurements
- To the question **DISP:CURS:STAT?**, the instrument returns the activation status of the manual measurements.
- DISPlay[:WINDow]:CURSor (Command/Query)
 :TIME{[1]|2|3}:POSition The **DISP:CURS:TIME{[1]|2|3}:POS <position|MAX|MIN>** command sets the horizontal position of the selected manual cursor.
- <position> is a value in format NRf, it may be followed or not by a multiple and the unit. By default the value is expressed in second.
- This command acts on the manual cursors represented on the screen by the X-symbol accompanied by an index (1, 2 or ϕ).
- To the question **DISP:CURS:TIME{[1]|2|3}:POS?**, the instrument returns the horizontal position of the selected manual cursor.
- Response format: <measured value><NL>
 value in format <NR3> expressed in second.
- DISPlay[:WINDow]:CURSor (Query)
 :VOLT{[1]|2}:POSition To the question **DISP:CURS:VOLT{[1]|2}:POS?**, the instrument returns the horizontal position of the selected manual cursor.
- This command acts on the manual cursors represented on the screen by the X-symbol accompanied by an index (1, 2).
- Response format: <measured value><NL>
 value in format <NR3> expressed in volt.
- DISPlay[:WINDow]:TRACe (Command/Query)
 :FORMat The **DISP:TRAC:FORM <A|XY>** command selects the display mode of the instrument.
- A validates the Oscilloscope display mode : $Y = f(t)$
 - XY validates the XY display mode : $Y = f(x)$
- To the question **DISP:TRAC:FORM?**, the instrument returns the active display mode.
- DISPlay[:WINDow]:TRACe (Command/Query)
 :MODE The **DISP:TRAC:MODE <NORMal|ENVELOpe>** command selects the display mode.
- NORMal validates the Vector display mode.
 - ENVELOpe validates the Envelope display mode.
- To the question **DISP:TRAC:MODE?**, the instrument returns the active display mode.
- DISPlay[:WINDow] (Command/Query)
 :TRACe:STATe{[1]|2|3|4} The **DISP:TRAC:STAT{[1]|2|3|4} <1|0|ON|OFF>** command validates or devalidates the selected signal.
- To the question **DISP:TRAC:STAT{[1]|2|3|4}?**, the instrument returns the validation status of the selected signal.
- DISPlay[:WINDow] (Command/Query)
 :TRACe:X[:SCALE] The **DISP:TRAC:X:PDIV <scale|MAX|MIN|UP|DOWN>** command sets the value of the time base.
- <scale> is a value in format <NRf> , it may be followed or not by a multiple and by the unit. By default, the value is expressed in second.
- Example: to get a time base of 1 μ s, following values can be entered: 1E-3ms or 1E-6 or 0.000001s or 0.000001 or else 1us.
- To the question **DISP:TRAC:X:PDIV?**, the instrument returns the value of the time base.
- Response format: <measured value><NL>
 value in format <NR3> expressed in second.

-
- DISPlay[:WINDow]:TRACe
:XY:XDEFine *(Command/Query)*
The **DISP:TRAC:XY:XDEF <INT{1|2|3|4}>** command selects the signal positioned on the X-basis.
To the question **DISP:TRAC:XY:XDEF?**, the instrument returns the signal used on the X-basis.
- DISPlay[:WINDow]:TRACe
:XY:YDEFine *(Command/Query)*
The **DISP:TRAC:XY:YDEF <INT{1|2|3|4}>** command selects the signal positioned on the Y-basis.
To the question **DISP:TRAC:XY:YDEF?**, the instrument returns the signal used on the Y-basis.
- DISPlay[:WINDow]
:TRACe:Y:LABel{[1]|2|3|4} *(Command/Query)*
The **DISP:TRAC:Y:LAB{[1]|2|3|4} <"label">** command determines the unit of the selected signal.
The unit is selected among the upper-case letters of the alphabet (A to Z), and is composed of a name up to 3 letters.
To the question **DISP:TRAC:Y:LAB{[1]|2|3|4}?**, the instrument returns the unit of the selected signal.
- DISPlay[:WINDow]
:TRACe:Y[:SCALE]
:PDIVision{[1]|2|3|4} *(Command/Query)*
The command **DISP:TRAC:Y:PDIV{[1]|2|3|4}<scale|MAX|MIN>** command sets the value of the probe coefficient for the selected signal.
<scale> is a value at NRf format.
To the question **DISP:TRAC:Y:PDIV{[1]|2|3|4}?**, the instrument returns the value of the probe coefficient for the selected signal.
- DISPlay[:WINDow]
:TRACe :Y:SPACing *(Command/Query)*
The **DISP:TRAC:Y:SPAC <LOGarithmic|LINEar>** command specifies the type of scale applied to the Y-axis.
To the question **DISP:TRAC:Y:SPAC?**, the instrument returns the type of scale applied to the Y-axis.

FORMat[:DATA] (Command/Query)

The **FORM** <INTEger|ASCIi|HEXAdecimal|BINary> command selects the data format of the trace transfer.

INTEger: The data transmitted consists in whole numbers, unsigned with a length of 32 bits, preceded by the heading #an. n represents the number of data items to transmit.
a gives the number of figures making up n.

The transmission for 4 data items (74, 70, 71, 76) is #14JFGL

ASCIi: The data is transferred using ASCII characters according to <NR1> numbering from 0 to 255. Each number is separated by a comma.

The transmission for 4 data items (74, 70, 71, 76) is 74,70,71,76

HEXAdecimal: The data is transferred using ASCII characters according to a numbering in base 16 on 8 bits. Each number is preceded by #H and separated by a comma.

The transmission for 4 data items (74, 70, 71, 76) is #H4A,#H46,#H47,#H4C

BINary: The data is transferred using ASCII characters according to a numbering in base 2 on 8 bits. Each number is preceded by #B and separated by a comma.

The transmission for 4 data items (74, 70, 71, 76) is

B1001010,#B1000110,#B1000111,

B1001100

To the question **FORM?**, the device returns the format selected for the trace transfer.

FORMat:DINTerchange (Command/Query)

The **FORM:DINT** <1|0|ON|OFF> command activates or inhibits the trace transfer in DIF format.

- ON|1 activates the trace transfer in DIF format.
- OFF|0 the trace transfer data is raw.

To the question **FORM:DINT?**, the device returns the activation status of the DIF format.

Response format: DIF format:
(DIF (VERsion <year.version>)

DIMension=X (TYPE IMPLicit
SCALE <sample interval>
SIZE <sample no>
U N I T s "S")

DIMension=Y (TYPE EXPLIcit
SCALE <ADC step> SIZE 262144
OFFSet 393216
U N I T s "V")
DATA(CURVe (<data block>))<NL>

<year.version> is a number in <NR2> format giving the year of the SCPI standard used and the software version.

: 1999.1 means that SCPI version 1999 is used. This is the first software version of the remote control management programme.

<sample interval > is a number in <NR3> format.

It represents the time difference between two samples.

<sample no> is a number in <NR1> format.

It represents the number of samples to be transferred. It can vary from 1 to 100 000.

<ADC step> is a number in <NR3> format.

It represents the difference in volt between two consecutive values of the analogue digital converter.

<data block> is a block containing the samples. This data comprises only the values resulting from the analogue digital converter. This block is in the format specified by the **FORMat[:DATA]** command.

HCOPy:SDUMp[:IMMediate] (Command)

The **HCOP:SDUM** command starts a hard copy.

HELP[?] (Query)

To the question **HELP?** [« directory entry »] the instrument answers helping in the SCPI commands available.

« directory entry » is a key word (short or long form) of first level in the tree of the command. No distinction is made between small and capital letters.

In absence of parameter, the list of the key words accepted by the function is given. When a key word is introduced, the list and the syntax of all the commands starting with this word is returned by the function.

INITiate:CONTinuous:NAME	<p><i>(Command)</i></p> <p>INIT:CONT:NAME <EDGE PULse DELay EVENT>,<1 0 ON OFF> starts or stops the acquisition in repetitive mode in the indicated trigger mode.</p> <p>In the CAPTure mode, the capture of faults in (Recorder) files is used.</p>
INITiate[:IMMediate]:NAME	<p><i>(Command)</i></p> <p>INIT:NAME <EDGE PULse DELay EVENT> runs an acquisition in single mode.</p>
INPut{[1] 2 3 4}:COUPLing	<p><i>(Command/Query)</i></p> <p>The INP{[1] 2 3 4}:COUP <AC DC GROund> command selects the coupling of the selected channel.</p> <p>To the question INP{[1] 2 3 4}:COUP?, the instrument returns the coupling of the selected channel.</p>
INPut{[1] 2 3 4}:DMM :COUPLing	<p><i>(Command/Query)</i></p> <p>The INP{[1] 2 3 4}:DMM:COUP <AC DC GROund> command affects the coupling of the selected channel.</p> <p>To the question INP{[1] 2 3 4}:DMM:COUP? the instrument returns the current coupling of the selected channel.</p>
INPUT:DMM :BANDwidth:RESolution	<p><i>(Command/Query)</i></p> <p>The INP{[1] 2 3 4}:DMM:BAND:RES <bandwidth> command limits the channel bandwidth to a value among : 625 Hz, 5 kHz, 0 (no limit), directly higher or equal to the required value.</p> <p>To the question INP{[1] 2 3 4}:DMM:BAND:RES? the instrument shows the cutoff frequency of the low-pass filter in use (625 Hz, 5 kHz or 0).</p>
MEASure:AC?	<p><i>(Query)</i></p> <p>To the question MEAS:AC? <INT{1 2 3 4}>,<CYCLe INTerval> the instrument returns the RMS voltage over an integer number of periods (CYCLe) or over the measurement interval (INTerval).</p> <p>Response format: <measured value><NL></p> <p>value in format <NR3> expressed in volt.</p>
MEASure:AMPLitude?	<p><i>(Query)</i></p> <p>To the question MEAS: AMPLitude? <INT{1 2 3 4}> the instrument returns the amplitude of the selected signal.</p>
MEASure:CURSor:DTIME?	<p><i>(Query)</i></p> <p>To the question MEAS:CURS:DTIME?, the instrument returns the time delay between cursors 1 and 2.</p> <p>Response format: <measured value><NL></p> <p>value in format <NR3> expressed in second.</p>
MEASure:CURSor:DVOLT?	<p><i>(Query)</i></p> <p>To the question MEAS:CURS:DVOLT?, the instrument returns the difference between cursors 1 and 2.</p> <p>Response format: <measured value><NL></p> <p>value in format <NR3> expressed in volt.</p>

MEASure:DMM? (Query)

To the question **MEAS:DMM? <INT1|2|3|4>** the instrument returns the value of the main measurement for the selected channel.

INT1 to INT4 index are associated with channels 1 to 4. Use the index to find INT5 power measurement.

Before using the command **MEAS: DMM? INT5**, the instrument must be configured to measure the power measurement (see [SENSe]: Function).

Response format : <measure> <NL>

value format <nrf>

MEASure:FALL:OVERshoot? (Query)

To the question **MEAS:FALL:OVER? <INT{1|2|3|4}>** the instrument returns the negative overshoot of the selected signal.

Response format: <measured value><NL>

value in format <NR2> expressed in percent.

MEASure:FALL:TIME? (Query)

or
MEASure:FTIME?

To the question **MEAS:FALL:TIME? <INT{1|2|3|4}>** the instrument returns the fall time of the selected signal.

Response format: <measured value><NL>

value in format <NR3> expressed in second.

MEASure:FREQuency? (Query)

To the question **MEAS:FREQ? <INT{1|2|3|4}>** the instrument returns the frequency of the selected signal.

Response format: <measured value><NL>

value in format <NR3> expressed in hertz.

MEASure:HIGH? (Query)

To the question **MEAS:HIGH? <INT{1|2|3|4}>** the instrument returns the value of the high level level of the selected signal.

Response format: <measured value><NL>

value in format <NR3> expressed in volt.

MEASure:LOW? (Query)

To the question **MEAS:LOW? <INT{1|2|3|4}>** the instrument returns the low level value of the selected signal.

Response format: <measured value><NL>

value in format <NR3> expressed in volt.

MEASure:MANual:PHASe? (Query)

To the question **MEAS: MAN:PHAS?**, the instrument returns the phase of ϕ -cursor in relation to cursors 1 and 2. The difference between the cursor 1 and 2 represents 360°. The cursor 1 equal to 0° and the cursor 2, 360°.

Response format: <measured value><NL>

value in format <NR2> expressed in degree.

MEASure:MAXimum? (Query)

To the question **MEAS:MAX? <INT{1|2|3|4}>** the instrument returns the maximum value of the selected signal.

Response format: <measured value><NL>

value in format <NR3> expressed in volt.

MEASure:MINimum? (Query)

To the question **MEAS:MIN? <INT{1|2|3|4}>** the instrument returns the value minimum of the selected signal.

Response format: <measured value><NL>

value in format <NR3> expressed in volt.

MEASure:NWIDth?	<i>(Query)</i> To the question MEAS:NWID? <INT{1 2 3 4}> the instrument returns the negative pulse width of the selected signal. Response format: <measured value><NL> value in format <NR3> expressed in second.
MEASure:PDUTycycle?	<i>(Query)</i> To the question MEAS:PDUT? <INT{1 2 3 4}> the instrument returns the duty cycle of the selected signal. Response format: <measured value><NL> value in format <NR2> expressed in percent.
MEASure:PERiod?	<i>(Query)</i> To the question MEAS:PERiod? <INT{1 2 3 4}> the instrument returns the period of the selected signal. Response format: <measured value><NL> value in format <NR3> expressed in second.
MEASure:PTPeak?	<i>(Query)</i> To the question MEAS:PTP? <INT{1 2 3 4}> the instrument returns the peak-to-peak value of the selected signal. Response format: <measured value><NL> value in format <NR3> expressed in volt.
MEASure:PULse:COUNt?	<i>(Query)</i> To the question MEAS:PUL:COUN? <INT{1 2 3 4}> the instrument returns the pulse count on screen of the selected signal. Response format: <measured value><NL> value in format <NR2>.
MEASure:PWIDth?	<i>(Query)</i> To the question MEAS:PWID? <INT{1 2 3 4}> the instrument returns the positive pulse width of the selected signal. Response format: <measured value><NL> value in format <NR3> expressed in second.
MEASure:RISE:OVERshoot?	<i>(Query)</i> To the question MEAS:RISE:OVER? <INT{1 2 3 4}> the instrument returns the positive overshoot of the selected signal. Response format: <measured value><NL> value in format <NR2> expressed in percent.
MEASure:RISE:TIME? or MEASure:RTIME?	<i>(Query)</i> To the question MEAS:RISE:TIME? <INT{1 2 3 4}> the instrument returns the rise time of the selected signal. Response format: <measured value><NL> value in format <NR3> expressed in second.
MEASure:SUM?	<i>(Query)</i> To the question MEAS:SUM? <INT{1 2 3 4}> the instrument returns the integral measurement of the selected signal. Response format: <measured value><NL> value in format <NR3>.
MEASure:VOLT[:DC]?	<i>(Query)</i> To the question MEAS:VOLT? <INT{1 2 3 4}> the instrument returns the average value of the selected signal. Response format: <measured value><NL> value in format <NR3> expressed in volt.

MMEMory:CATalog? (Query)
 To the question **MMEM:CAT?** [**<LOCAL|SDCARD>**] the device returns the list of files present in the local memory.
 If the file system is not specified, the default file system is used (see command **MMEM:MSIS**).
 Response format: **<file number>**, 0[,**<file list>**]
<file number> is in NR1 format.
<file list> = **<"file">**,**<type>**,0
<"file"> consists in a name of 20 letters maximum, followed by a period and the 3-letter extension.
<type> is

- **STAT** for the extension files **.CFG**
- **TRAC** for the extension files **.TRC** and **.REC**
- **ASC** for the extension files **.TXT** and **.FCT**
- **MAC** for the extension files **.MAC**
- **BIN** for all other files

MMEMory:CDIR? (Command/Query)
 The **MMEM:CDIR <"directory">** command determines the working directory on the default device.
 To the question **MMEM:CDIR?** the instrument returns the working directory.

MMEMory:DATA (Command/Query)
 The **MMEM:DATA <"file">**,**<block>** command transfers a file from the PC to the device.
<"file"> consists in a name of 20 letters maximum, followed by a period and the 3-letter extension. If the file already exists, it will be overwritten by the new file.
<block> is all of the data in the file preceded by the heading **#an**, **n** being the data number and **a**, a figure indicating the number of figures making up **n**.
 To the question **MMEM:DATA? <"file">**, the device transfers the file named to the PC.
 Response format: **<block>** **<NL>**

MMEMory:DElete (Command)
 The **MMEM:DEL <"file">**[,**<LOCAL|SDCARD>**] command deletes a file.
 If the file system is not specified, the default file system is used (see command **MMEM:MSIS** and **MMEM:CDIR**).

MMEMory:LOAD:MACRo (Command)
 The **MMEM:STOR:MACR,<"file">**,**<LOCAL|SDCARD>** command reads a mathematical function from a ".FCT" file and assigns it to the indicated signal.
 If the file system is not specified, the default file system is used (see **MMEM:MSIS** and **MMEM:CDIR**).
<"file"> consists in a name of 20 letters maximum, followed by a period and the FCT extension.

MMEMory:LOAD:STATe (Command)
 The **MMEM:LOAD:STAT <"file">**[,**<LOCAL|SDCARD|FTP>**] command reads an instrument configuration from a ".cfg" file.
 If the file system is not specified, the default file system is used (see command **MMEM:MSIS** and **MMEM:CDIR**).
<"file"> consists in a name of 20 letters max., followed by a period and the CFG extension.

MMEMory:LOAD:TRACe (Command)
MMEM:LOAD:TRAC<TRACE>,**<"file.trc">**[,**<LOCAL|SDCARD>**] command reads traces defined in a ".trc" file.
 If the file system is not specified, the default file system is used (see command **MMEM:MSIS** and **MMEM:CDIR**).
<"file"> consists in a name of 20 letters maximum, followed by a period and the TRC extension.

MMEMory:MSIS (Command/Query)
 The **MMEM:MSIS<LOCAL|SDCARD>** is used to select the default mass storage support.
 To the question **MMEM:MSIS?** The instrument returns the default mass storage support.

- MMEMory:STORe:MACRo** *(Command)*
 The **MMEM:STOR:MACR** ,<"file">,<LOCAL|SDCARD> command generates a file ".FCT" from the specified mathematical function in the chosen file system.
 If the file system is not specified, the default file system is used (see **MMEM:MSIS** and **MMEM:CDIR** command).
 <"file"> consists in a name of 20 letters maximum, followed by a period and the fct extension.
- MMEMory:STORe:STATe** *(Command)*
 The **MMEM:STOR:STAT** <"file">[,<LOCAL|SDCARD|FTP>] command generates a ".CFG" file from the instrument configuration, in the selected file system.
 If the file system is not specified, the default file system is used (see command **MMEM:MSIS** and **MMEM:CDIR**).
 <"file"> consists in a name of 20 letters maximum, followed by a period and the CFG extension.
- MMEMory:STORe:TRACe** *(Command)*
 The **MMEM:STOR:TRAC** <"file.trc">[,<LOCAL|SDCARD>] command generates a ".trc" file from displayed signals, in the selected file system.
 If the file system is not specified, the default file system is used (see commands **MMEM:MSIS** and **MMEM:CDIR**).
 <"file"> consists in a name of 20 letters maximum, followed by a period and the TRC extension.
- [SENSe]:AVERAge:COUNT** *(Command/Query)*
 The **AVER:COUNT** <acquisition number|MAX|MIN|UP|DOWN> command determines the number of acquisition bursts necessary to obtain a displayed trace by averaging.
 <acquisition number> is a value in format NR1, from values 2, 4, 16 to 64.
 To the question **AVER:COUNT?**, the instrument returns the number of acquisition bursts necessary to obtain a displayed trace by averaging.
- [SENSe]:AVERAge[:STATe]** *(Command/Query)*
 The **AVER** <1|0|ON|OFF> command validates or devalidates the 'REPETITIVE SIGNAL' function.
 ■ 1|ON: signal repetitive validated
 ■ 0|OFF: signal repetitive not validated
 To the question **AVER?**, the instrument returns the activation status of averaging.
 The averaging is only active when the option 'repetitive signal' is validated.
- [SENSe]:AVERAge:TYPE** *(Command/Query)*
 The **AVER:TYPE** <NORMAL|ENVELOPE> command validates or devalidates the mode of min/max acquisition.
 NORMAl devalidates the mode of min/max acquisition.
 ENVELOPE validates the mode of min/max acquisition.
 To the question **AVER:TYPE?**, the instrument returns the activation status of the mode of min/max acquisition.
- [SENSe]:BANDwidth** *(Command/Query)*
{[1]|2|3|4}:RESolution
 The **BAND**{[1]|2|3|4} <Bandwidth> command limits the channel bandwidth to the value of the parameter [5 kHz ; 1,5 MHz ; 15 MHz ; 0 (no bandwidth limit)].
 To the question **BAND**{[1]|2|3|4}?, the instrument returns the value of the filter cut-off frequency [5 kHz ; 1,5 MHz ; 15 MHz ; 0 (no bandwidth limit)].
- [SENSe]:FUNCTion** *(Command/Query)*
FUNC<VOLTage|RESistance|CONTInuity|CAPAcitor|DIODE|POWER|POW3a|POW3b|POW3c> selects the measurement function on channel 1.
 To the question **FUNC?**, the instrument returns the measure function to channel 1.
 POW3a : Three-phase power with two wattmeter method.
 POW3b : Three-phase power on a balanced network with neutral.
 POW3b : Three-phase power on a balanced network without neutral.

[SENSe]:RANGe (Command/Query)

{[1]|2|3|4}:AUTO

The **RANG{[1]|2|3|4}:AUTO <1|0|ON|OFF>** command authorizes or prohibits the autoranging of the selected channel.

- ON|1 activates the autoranging.
- OFF|0 deactivates this function.

To the question **RANG{[1]|2|3|4}:AUTO?** the instrument returns the autoranging status for the selected channel.

[SENSe]:RANGe[1]:CAPA (Command/Query)

The **RANG:CAPA <range|MAX|MIN|UP|DOWN>** command selects the range of measurement to be used in capacitance mode.

<range> is a value in format NRf, it may be followed or not by a multiple and by the unit.

By default, the value is expressed in Farad.

To the question **RANG:CAPA?** the instrument returns the range value of the capacitance.

Response format: <range><NL>

value in format <NR3>

[SENSe]:RANGe[1]:OHM (Command/Query)

The **RANG:OHM <range|MAX|MIN|UP|DOWN>** command selects the measurement range to be used in ohmmeter mode.

<range> is a value in format NRf, it may be followed or not by a multiple and by the unit.

By default, it is expressed in Ohm (Ω).

To the question **RANG:OHM?** the instrument returns the value of the measurement range of the ohmmeter.

Response format: <range><NL>

value in format <NR3>

[SENSe]:RANGe (Command/Query)

{[1]|2|3|4}:VOLT

The **RANG{[1]|2|3|4}:VOLT <range|MAX|MIN|UP|DOWN>** command selects the measurement range to be used in voltmeter mode for the selected channel.

<range> is a value in NRf format, it may be followed or not by a multiple and by the unit.

By default, it is expressed in volt.

To the question **RANG{[1]|2|3|4}:VOLT?** the instrument returns the value of the measurement range of the voltmeter for the selected channel.

Response format: <range><NL>

value in format <NR3>

[SENSE]SWEep:OFFSet (Command/Query)

:TIME

The **SWE:OFFS:TIME <time|MAX|MIN|UP|DOWN>** command sets the horizontal offset of the trace (run-after-delay or postrig).

<time> is a signed value in format <NRf> ; it may be followed or not by a multiple and by the unit.

By default, it is expressed in second.

To the question **SWE:OFFS:TIME?**, the instrument returns the current run-after-delay.

Response format: <measured value><NL>

value in format <NR3> expressed in second.

[SENSe]:VOLTage (Command/Query)

{[1]|2|3|4}[:DC]

:RANGe:OFFSet

The **VOLT{[1]|2|3|4}:RANG:OFFS <offset|MAX|MIN|UP|DOWN>** command sets the vertical offset of the time representation of the selected signal.

<offset> is a value in NRf format, it may be followed or not by a multiple and the unit.

By default the value is expressed in volt.

To the question **V{[1]|2|3|4}:RANG:OFFS?**, the instrument returns the vertical offset of the selected signal.

Response format: <measured value><NL>

value in format <NR3> expressed in volt.

<p>[SENSe]:VOLTage {[1] 2 3 4}:DC:RANGe :PTPeak</p>	<p><i>(Command)</i></p> <p>The VOLT{[1] 2 3 4}:RANG:PTP <sensitivity MAX MIN UP DOWN> command sets the full screen vertical sensitivity of the selected channel.</p> <p><sensitivity> is a value in NRf format, it may be followed or not by a multiple and the unit.</p> <p>By default the value is expressed in volt.</p> <p>To the question VOLT{[1] 2 3 4}:RANG:PTP?, the instrument returns the full screen vertical sensitivity of the selected channel.</p> <p><u>Response format:</u> <measured value><NL></p> <p>value in format <NR3> expressed in volt.</p> <p>If 10mV/div is the sensitivity displayed in the channel parameters, then the <sensitivity> parameter = 8 x 10 mV/div.</p>
<p>SYSTem:COMMunicate :SOCKet:{[1] 2}:ADDRess</p>	<p><i>(Command/Query)</i></p> <p>The SYST:COMM:SOCK:{[1] 2}:ADDR "<IPaddress>" command defines the IP address of the instrument.</p> <p>Use index 1 to set ETHERNET and index 2 to set WIFI.</p> <p><IPaddress> is a chain of characters as: ip1.ip2.ip3.ip4, each of the ipX values must be included between 0 & 255.</p> <p>To the question SYST:COMM:SOCK:ADDR? the instrument returns the value of the current IP address.</p> <p>Response format: <ip1.ip2.ip3.ip4><NL></p>
<p>SYSTem:COMMunicate :SOCKet:{[2]}:WIFI</p>	<p><i>(Command)</i></p> <p>SYST:COMM:SOCK <"ssid">, <wep wpa-psk open>, <"password"> is used to set WIFI : the 3 parameters necessary to connect to the WIFI network.</p>
<p>SYSTem:DATE</p>	<p><i>(Command/Query)</i></p> <p>The SYST:DATE <NR1>,<NR1>,<NR1> command sets the date of the instrument.</p> <p>The possible values are:</p> <p>0 to 9999 for the year range (1st range).</p> <p>1 to 12 for the month range (2nd range).</p> <p>1 to 31 for the day range (3rd range).</p> <p>To the question SYST:DATE?, the instrument returns the date.</p> <p>Response format: < YYYY,MM,DD ><NL></p> <p>with Y = year, M = month, D = day.</p>
<p>SYSTem:ERRor[:NEXT]?</p>	<p><i>(Query)</i></p> <p>To the question SYST:ERR?, the instrument returns the number of error positioned at the top of the queue. The queue has a stack of 20 numbers and is managed as follows : first in, first out.</p> <p>As the SYST:ERR? questions arrive, the instrument returns the number of errors in order of arrival, until the queue is empty. Every more SYST:ERR? question involves a negative answer: character "0" (ASCII 48code). If the queue is full, the case at the top of the queue takes the value -350 (saturated queue).</p> <p>The queue is empty:</p> <ul style="list-style-type: none"> - when the instrument is getting started. - at the receipt of a *CLS. - at the reading of the last error. <p>Response format: <error><NL></p> <p>with error = negative or 0, no error.</p>

* **Command error:** They indicate that a syntax error has been detected by the syntax analyzer and causes event register bit 5, called CME, CoMmand Error to be set to 1.
(-199 to -100)

- 101: Invalid character
- 103: Invalid separator
- 104: Data type error
- 108: Parameter not allowed
- 109: Missing parameter
- 111: Header separator error
- 112: Program mnemonic too long
- 113: Undefined header
- 114: Header suffix out of range
- 121: Invalid character in number
- 128: Numeric data not allowed
- 131: Invalid suffix
- 138: Suffix not allowed
- 141: Invalid character data
- 148: Character data not allowed
- 151: Invalid string data
- 154: String data too long
- 171: Invalid expression

* **Execution errors:** They indicate that an error has been detected at the moment of command execution and causes event register bit 4, called EXE, Execution Error, to be set to 1.
(-299 to -200)

- 200: Execution error
- 213: Init ignored
- 221: Sandtings conflict
- 222: Data out of range
- 232: Invalid format
- 256: File name not found
- 257: File name error

* **Specific instrument errors:** They indicate that an abnormal error has been detected during execution of a task, and causes event register bit 3, called DDE, Device Dependent Error to be set to 1.
(-399 to -300)

- 300: Device-specific error
- 321: Out of memory
- 350: Queue overflow
- 360: Communication error

* **Query errors:** They indicate that an abnormal error has been detected during execution of a task, and cause event register bit 2, called QYE, QuerY Error, to be set to 1.
(-499 to -400)

- 400: Query error

SYSTem:KLOCK (*Command/Query*)

The **SYST:KLOCK <0|1|ON|OFF>** command locks the front face.

To the question **SYST:KLOCK?**, the instrument returns the lock status of the front face.

SYSTem:SET (Command/Query)

The **SYST:SET** <block> command transfers the configuration from the computer to the device. <block> is a finite data number preceded by the heading #an with n, the data number and a, a figure indicating the number of figures making up n.

To the question **SYST:SET?**, the device transfers the current configuration to the computer.

Response format: <block> <NL>

SYSTem:TIME (Command/Query)

The **SYST:TIME** <NR1>,<NR1>,<NR1> command sets the time of the instrument.

The possible values are:

0 to 23 for the hour range (1st range).

0 to 59 for the minute range (2nd range).

0 to 59 for the second range (3rd range).

To the question **SYST:TIME?**, the instrument returns the hour.

Response format: < HH,MM,SS ><NL>

avec H = hour, M = minute, S = second.

TRACe:CATalog (Query)

To the question **TRAC:CAT?**, the device returns the list of active signals.

TRAC:CAT?

reply <NL> when no signal is active.

reply INT1 <NL> when only signal 1 is active.

reply INT1,INT3<NL> when signals 1 and 3 are active.

TRACe[:DATA] (Query)

To the question **TRAC? <INT{1|2|3|4}>**, the device transfers the selected trace to the computer.

Response format: <block><NL>

<block> is a data block, the format of which is set by the **FORMat:DINTerchange** and **FORMat[:DATA]** commands.

It contains the value of the 2500 samples encoded on 4 bytes, as follows (bit 31 = MSB):

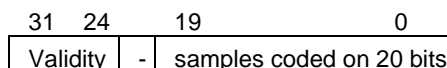

The validity byte contains 3 data bits:

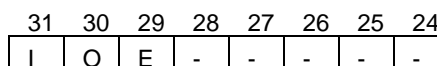

with :

I : Invalidity, the sample is invalid if equal to 1

A : Age, used in slow mode, this sample is validated

E : Extrapolated, the sample is the result of an extrapolation if equal to 1.

TRACe:LIMit (Command/Query)

The **TRAC:LIM** <abscissa1>,<abscissa2>,<step> command sets the left and right limits and the step of the data to be transferred.

<abscissa1>,<abscissa2>,<step> are parameters using format NR1.

Their default value is 0, 2499 and 1.

To the question **TRAC:LIM?**, the device returns the left and right limits and the step of the data to be transferred.

TRIGger[:SEQUence (Command/Query)

{[1]|2|3|4]} :**ATRIGger[:STATE]**

The **TRIG:ATRIG** <1|0|ON|OFF> command validates or devalidates the automatic trigger mode.

- ON|1 activates the automatic trigger mode.

- OFF|0 activates the trigger mode.

To the question **TRIG:ATRIG?**, the instrument returns the activation status of the automatic trigger mode.

TRIGger[:SEquence {[1][2][3][4]}:COUPling	(Command/Query) The TRIG:COUP <AC DC> command determines the coupling associated to the main trigger source. To the question TRIG:COUP? , the instrument returns the coupling associated to the main trigger source.
TRIGger[:SEquence {[1][2][3][4]}:DEFine?	(Command/Query) Returns the description of the indicated sequence : SEQUence1: EDGE SEQUence2: PULse SEQUence3: DELay SEQUence4: EVENT
TRIGger:SEquence{2 3} :DELay	(Command/Query) The TRIG:SEQ{2 3}:DEL <time MAX MIN UP DOWN> command ▪ in sequence 2 (Pulse) sets T1, the pulse time in following cases : « t > T1 », « t > T1 and t < T2 », « t < T1 or t > T2 » ▪ in sequence 3 (trig-after-delay): sets the trigger delay on main source <time> is a value in format <NRf>, it may be followed or not by a multiple and by the unit. By default the value is expressed in second. To the question TRIG:SEQ{2 3}:DEL? , the instrument returns the trigger delay of the main source or the T1 pulse time according to the selected sequence. Response format: <measured value><NL> value in format <NR3> expressed in second.
TRIGger[:SEquence2] :DELDpulse	(Command/Query) The TRIG: DELD<time MAX MIN UP DOWN> is used to set T2 in the following cases : « t > T1 and t < T2 », « t < T1 or t > T2 »
TRIGger[:SEquence[4]] :ECOunt	(Command/Query) The TRIG:ECO <count MAX MIN UP DOWN> command sets the number of events used in the trigger mode delayed by count. <count> is a value in format NR1 from 3 to 16384. To the question TRIG:ECO? , the instrument returns the number of events to be counted before the trigger.
TRIGger[:SEquence {[1][2][3][4]} :FILTer:HPASs[:STATe]	(Command/Query) The TRIG:FILT:HPAS <1 0 ON OFF> command validates or devalidates the reject of the low frequencies associated to the main trigger source. ▪ 1 ON: activates the reject of the low frequencies (LF Reject coupling) ▪ 0 OFF: deactivates the reject of the low frequencies; the DC coupling is then activated. To the question TRIG:FILT:HPAS? , the instrument returns the activation status of the low frequencies reject associated to the trigger source.
TRIGger[:SEquence {[1][2][3][4]} :FILTer:LPASs[:STATe]	(Command/Query) To the question TRIG:FILT:LPAS? , the instrument returns the activation status the reject of the high frequencies associated to the trigger source. ▪ 1 ON: activates the high frequencies reject (HF Reject coupling) ▪ 0 OFF: deactivates the high frequencies reject; the DC coupling is then activated. To the question TRIG:FILT:LPAS? , the instrument returns the activation status the reject of the high frequencies associated to the trigger source.

TRIGger[:SEQuence

{[1]|2|3|4}:HYSTeresis
[:STATe]

(Command/Query)

The **TRIG:HYST <hysteresis>** command sets the amplitude of the hysteresis which rejects the noise associated to the trigger main source.

<hysteresis> is a value at NR1 format taking following values :

- 0: no noise reject, hysteresis is about 0.5 div.
- 3: activated noise reject, hysteresis is about 3 div.

To the question **TRIG:HYST?**, the instrument returns the amplitude of the hysteresis which rejects the noise associated to the trigger main source.

TRIGger[:SEQuence[1]|3|4]

:HOLDoff

(Command/Query)

The **TRIG:HOLD <time|MAX|MIN|UP|DOWN>** command sets the inhibition time of the trigger (Holdoff).

<time> is a value in format <NRf>, it may be followed or not by a multiple and by the unit.

By default the value is expressed in second.

To the question **TRIG:HOLD?**, the instrument returns the trigger Holdoff time.

Response format: <measured value><NL>

value in format <NR3> expressed in second.

TRIGger[:SEQuence

{[1]|2|3|4}:LEVel

(Command/Query)

Used in the Seq. 1 to 4, the **TRIG:LEV <level|MAX|MIN|UP|DOWN>** command sets the trigger level of the main source.

<level> is a value in format NRf, it may be followed or not by a multiple and by the unit.

By default, the value is expressed in volt.

To the question **TRIG:LEV?**, the instrument returns the trigger level of the main source in SEQUENCE1.

Response format: <measured value><NL>

value in format <NR3> expressed in volt.

TRIGger[:SEQuence

{[1]|2|3|4}:RUN:STATe

(Command/Query)

The **TRIG:RUN:STAT <1|0|ON|OFF>** command starts or stops the acquisition.

- ON|1 acquisition starts.
- OFF|0 acquisition is stopped.

To the question **TRIG:RUN:STAT?**, the instrument returns the trigger status.



TRIGger[:SEQuence

{[1]|2|3|4}:SLOPe

(Command/Query)



TRIG:SEQ{[1]|2|3|4}:SLOP <POSitive|NEGative> determines :

in SEQUENCE2 : determines the polarity of the pulse

- POSitive: positive pulse 
- NEGative: negative pulse 

To the question **TRIG:SEQ{[1]|2|3|4}:SLOP?**, the instrument returns the polarity trigger front or pulse according to the selected SEQUENCE.

In the other sequences: used to measure the triggering edge of the main source:

- POSitive: rising front 
- NEGative: falling front 

TRIGger[:SEQuence

{[1]|2|3|4]:SOURce

(Command/Query)

The **TRIG:SOUR <INTernal{1|2|3|4}>** command determines the main trigger source of the instrument.

INTernal{1|2|3|4} corresponds to the trigger source (1, 2, 3, 4 channels) of the instrument on SCOPIX and SCOPIX BUS.

To the question **TRIG:SOUR?**, the instrument returns the main trigger source used in.

TRIGger[:SEQuence[2]]

:TYPe

(Command/Query)

The **TRIG:TYP <INFerior|SUPerior|INT|OUT>** command determines the trigger type on pulse width :

trigger on pulses of durations which are inferior (INF) or superior (SUP) to the specified duration, or which are situated inside (INT) or outside (OUT) of the specified temporal range, with :

- INF : triggers on a pulse if its duration is less than t1
- SUP : triggers on a pulse if its duration is more than t1
- INT : triggers on a pulse if its duration is between t1 and t1 + d
- OUT : triggers on a pulse if its duration is situated over t1 and t1 + d

To the question **TRIG:TYP?**, the instrument returns the trigger type on pulse width.

Response format: <INF|SUP|INT|OUT ><NL>

11.3. IEEE 488.2 common commands

Introduction

The common commands are defined by the IEEE 488.2 standard. They are operational on all instruments which are specified IEEE 488.2. They command basic functions such as:

identification,
 reset,
 configuration reading,
 reading of event and status register,
 reset of event and status register.

If a command containing one or several directories has been received, and if a common command has been stacked up, then the instrument stays in this directory and execute normally the commands.

Events and status management

Registers

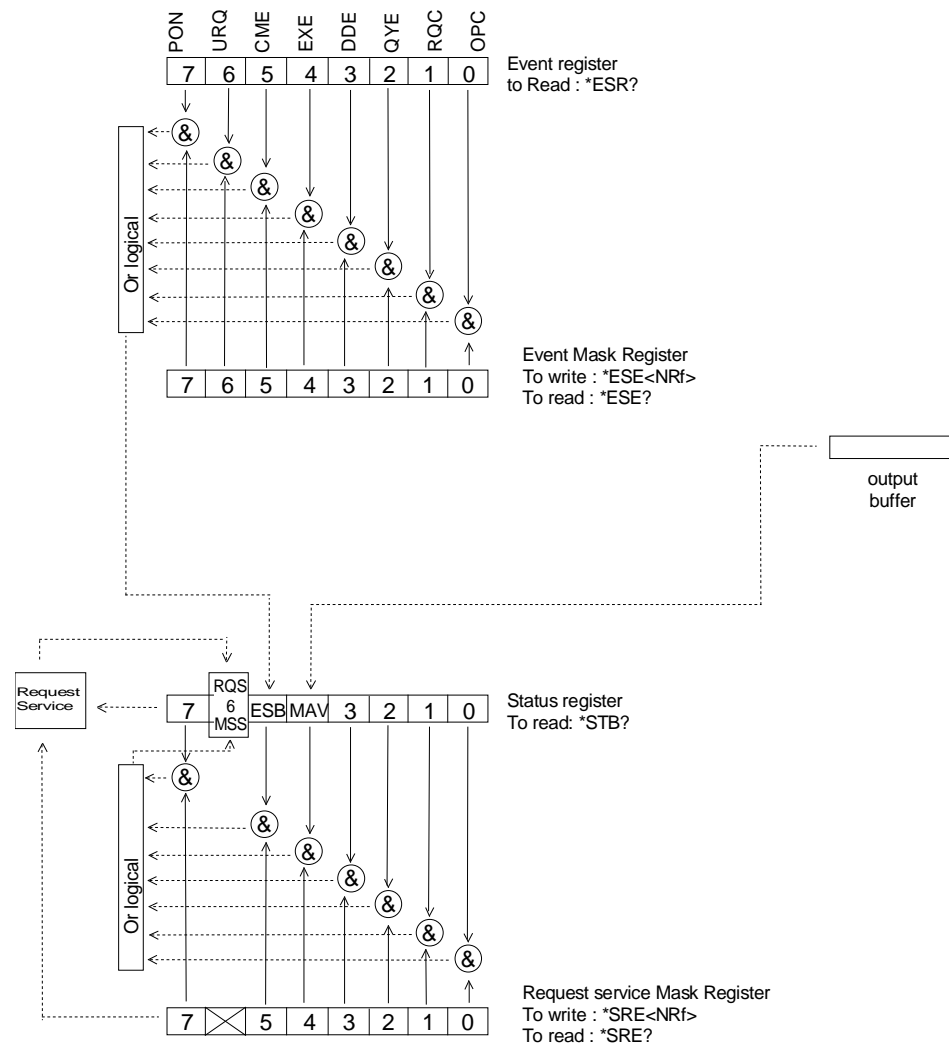

Status registers

Reading only → *STB? common command.
 In this case, the (MSS) 6 Bit is returned and remain in the status it was before reading [see §. *STB (Status Byte)]
 The *CLS common command is reset to zero.

Detailed description

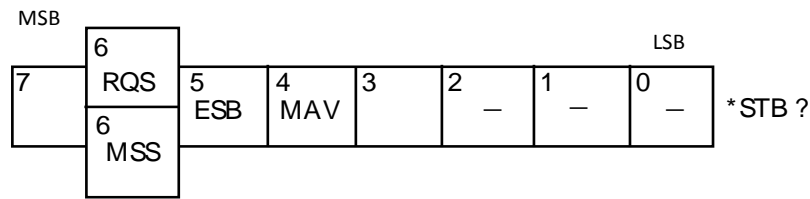

- RQS Request Service (6 bit)**
 Indicates if the instrument requests a service. The type of COMM used on the instrument does not generate a request, but the byte is accessible in reading. It is reset to 0 after reading and can switch to zero only if the event register is reset to zero (by reading or *CLS).
- MSS Master Summary Status (6 bit)**
 Indicates if the instrument has a reason to request a service. This information is accessible only in reading the status register. (*STB? command) and stays as it is after the reading.
- ESB Event Satus Bit (5 bit)**
 Indicates if at least one of the conditions of the event register is satisfied and not masked.
- MAV Message Available (4 bit)**
 Indicates if at least one response is in the output spooler.

Service request mask register

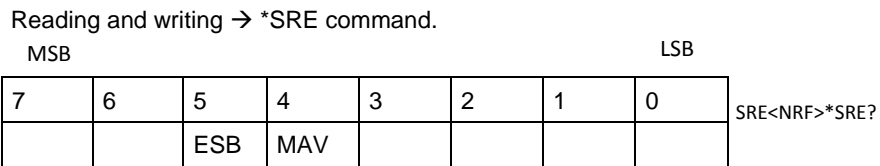

Event register

Reading → *ESR command. Its reading resets to zero.

Detailed description

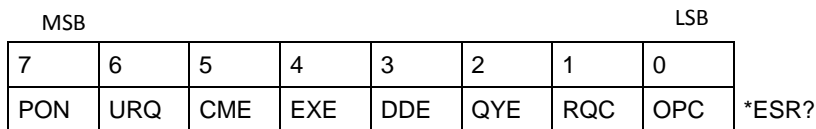

- PON Power On (7 bit)**
Not used
- URQ User request (6 bit)**
Not used
- CME Command Error (5 bit)**
A command error has been detected.
- EXE Execution Error (4 bit)**
An error execution has been detected.
- DDE Device Dependant Error (3 bit)**
An error specific to the instrument has been detected.
- QYE Query Error (2 bit)**
A query error has been detected.
- RQC Request Control (1 bit)**
Always at zero.
- OPC Operation Complete (0 bit)**
All operations running are ended.

Event mask register Reading and writing → *ESE command.

MSB							LSB	
7	6	5	4	3	2	1	0	*ESE<NRF>*ESE?
PON	URQ	CME	EXE	DDE	QYE	RQC	OPC	

IEEE 488.2 Commands

***CLS** (Command)
(Clear Status) The common command ***CLS** reset the status and event register.

***ESE** (Command/Query)
(Event Status Enable) The ***ESE <mask>** common command positions the status of the event mask. **<mask>** is a value in format **<NR1>**, from 0 to 255. A **1** authorises the corresponding bit of the event register to generate an event, while a **0** masks it. To the question ***ESE?**, the instrument returns the current content of the event mask register.
Response format: <value><NL>
value in format <NR1> from 0 to 255.

Event mask register :

MSB							LSB
7	6	5	4	3	2	1	0
PON	URQ	CME	EXE	DDE	QYE	RQC	OPC

***ESR?** (Query)
(Event Status Register) To the question ***ESR?**, the instrument returns the content of the event register. Once the register has been read, the content value is reset to zero.
Response format: <value><NL>
value in format <NR1> from 0 to 255.

Event register

MSB							LSB
7	6	5	4	3	2	1	0
PON	URQ	CME	EXE	DDE	QYE	RQC	OPC

***IDN?** (Query)
(Identification Number) To the question ***IDN?**, the instrument returns the type of instrument and the software version.
Response format:
<instrument>,<firmware version>/<hardware version><NL>
<instrument> Instrument reference
<firmware version> Software version
<hardware version> PCB version

***OPC** (Command/Query)
(Operation Complete) The command ***OPC** authorises the setting to 1 of the OPC bit in the event register as soon as the current operation is completed. To the question ***OPC?**, the instrument returns the character ASCII "1" as soon as the current operation is terminated.

***RST** (Command)
(Reset) The command ***RST** reconfigures the instrument with the factory settings.

***SRE** (Command/Query)

(Service Request Enable) The command *SRE <mask> positions the service request mask register.
 <mask> is a value in format <NR1>, from 0 to 255.

A value of bit at 1 enables the same-rank bit of the status register to request a service (bit of the status register contains 1). A bit value at 0 neutralizes it.

To the question *SRE?, the instrument returns the value of the service demand mask register.

Response format: <value><NL>

value in format <NR1> from 0 to 255.

Service demand mask register :

MSB				LSB			
7	6	5	4	3	2	1	0
0	0	ESB	MAV	0	0	0	0

***STB?** (Query)

(Status Byte) To the question *STB? the instrument returns the content of its status register (Status Byte Register).

The bit 6 returned indicates the MSS value (Master Summary Status) (at 1 if the instrument has a reason for requesting a service).

Contrary to RQS, it is not reset to zero after reading the status register (RQS is accessible only by series recognition, and falls to 0 at its end).

Status register

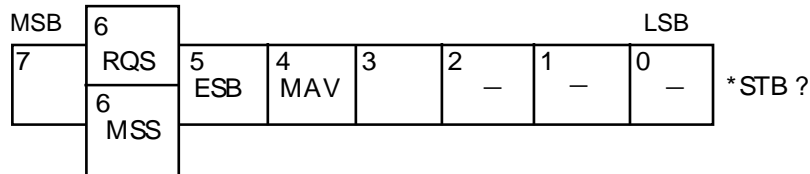

***TRG** (Command)

The command *TRG starts an acquisition in the current mode "single" or "continuous".

***TST?** (Query)

(Test) To the question *TST?, the instrument returns the status of the autotest procedure.

Response format: <0|1><NL>

- responds 0 when the autotest is successful.
- responds 1 when a problem has been detected.

***WAI** (Command)

(Wait) The command *WAI prevents the instrument from performing further commands as long as the current command has not been terminated. This enables to synchronize the instrument with the application program in progress on the controller.

Tree structure

**IEEE 488.2 Common
commands**

Commands	Functions
*CLS	<i>Resets the status and event registers</i>
*ESE	<i>Writes event mask</i>
*ESE?	<i>Reads event mask</i>
*ESR?	<i>Reads event register</i>
*IDN?	<i>Reads identifier</i>
*OPC	<i>Validates bit OPC</i>
*OPC?	<i>Waits till end of execution</i>
*RST	<i>Resets</i>
*SRE	<i>Writes service request mask</i>
*SRE?	<i>Reads service request mask</i>
*STB?	<i>Reads status register</i>
*TRG	<i>Starts an acquisition in the current mode</i>
*TST?	<i>Returns the status of the autoset procedure</i>
*WAI	<i>Commands synchronization</i>

12.APPENDIX

12.1 « ARINC 429 » Bus

12.1.1. Overview

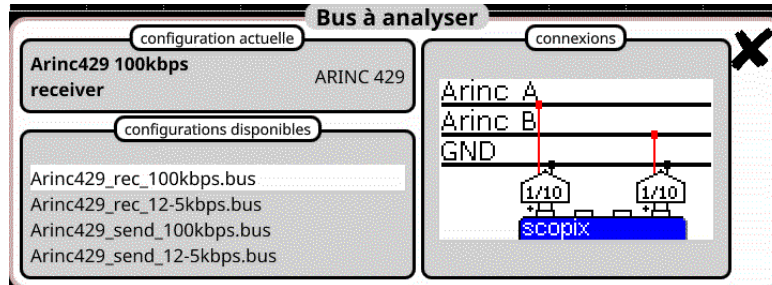

Configuration

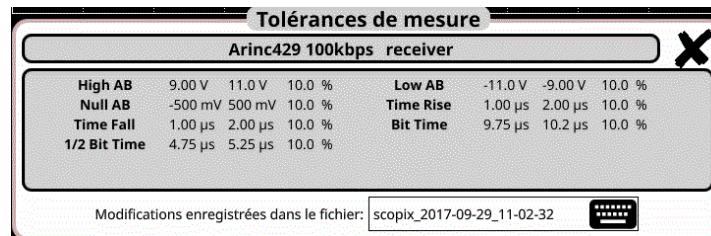

Measurement specification

12.1.2. Getting started

Equipment	<ul style="list-style-type: none"> two HX0130 or HX0030 sensors an HX091 M12 connection board (optional)
Configuration files	<ul style="list-style-type: none"> " Arinc429_rec_100kbps ", " Arinc429_rec_12-5kbps " " Arinc429_send_100kbps ", " Arinc429_send_12-5kbps "
Connections	

12.1.3. Measurements (ARINC 429)

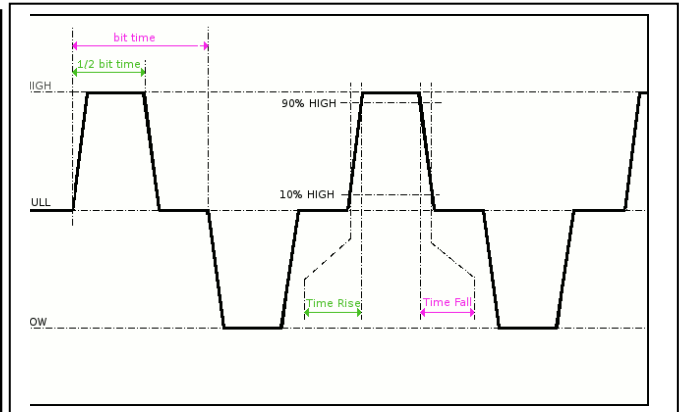
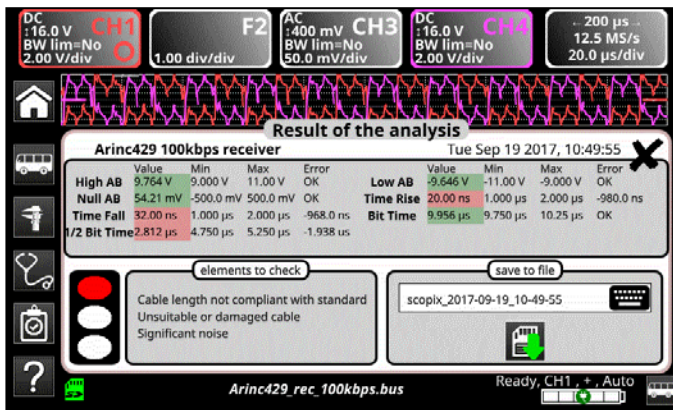

Diagnosis		Use this table to troubleshoot problems on a measurement:
Measurement	Description	Diagnosis
High AB	Measurement of the signal high level	<ul style="list-style-type: none"> Termination problem Cable length not compliant with standard Faulty junction connection (oxidation, bad contact, etc.) Significant noise (check the cable route, ground braid not connected, faulty chassis-ground, etc.) ...
Low AB	Measurement of the signal low level	
Null AB	Measurement of the signal in idle level	<ul style="list-style-type: none"> Unsuitable or damaged cable (load too light) Cable length not compliant with standard Faulty junction connection (oxidation, bad contact, etc.) Significant noise (check the cable route, ground braid not connected, faulty chassis-ground, etc.)
Time Rise	Rise time	<ul style="list-style-type: none"> Cable length not compliant with standard Unsuitable or damaged cable (the rise and fall times increase with the cable impedance) ...
Time Fall	Fall time	
Bit Time	Bit duration	<ul style="list-style-type: none"> Cable length not compliant with standard Unsuitable or damaged cable Significant noise (check the cable route, ground braid not connected, faulty chassis-ground, etc.) ...
1/2 Bit Time	Half a bit duration	

12.2 « AS-I » Bus

12.2.1. Overview

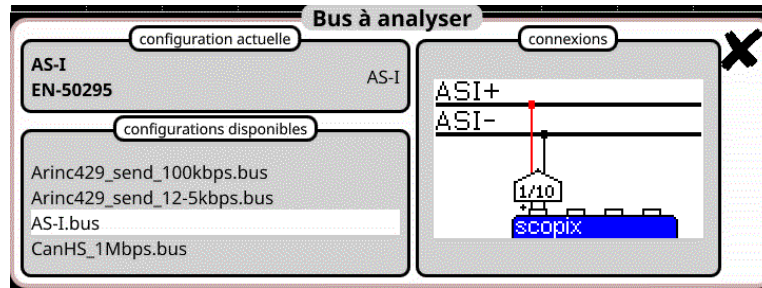

Configuration

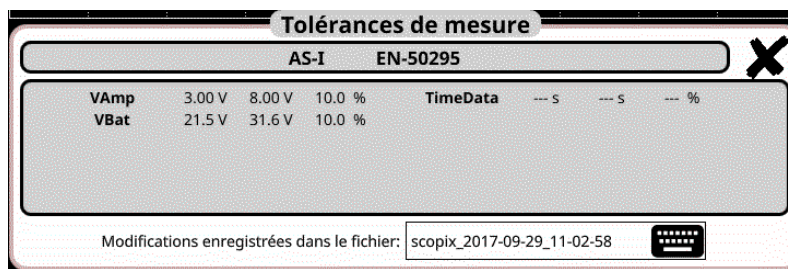

Measurement specification

12.2.2. Getting started

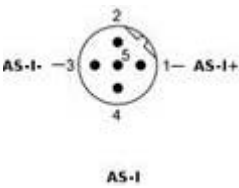
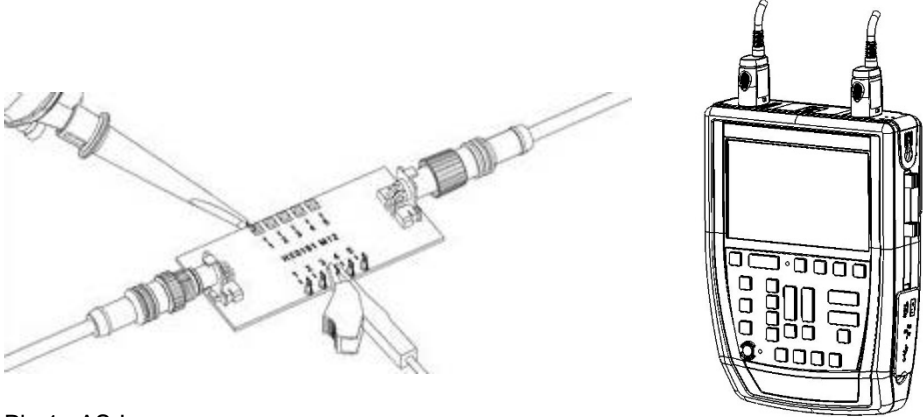
<p>Equipment</p>	<ul style="list-style-type: none"> ▪ an HX0130 or HX0030 sensor ▪ an HX0191 M12 connection board (optional).
<p>Configuration files</p>	<ul style="list-style-type: none"> ▪ « AS-I » <p>☞, The configuration file parameters are compliant with the EN-50295 standard, on the receiver side.</p>
<p>Connections</p> 	 <p>Pin 1 : AS-I+ Pin 3 : AS-I-</p>

12.2.3. Measurements (AS-I)

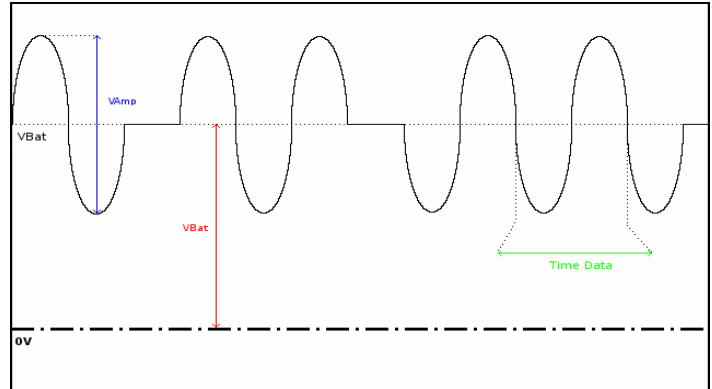
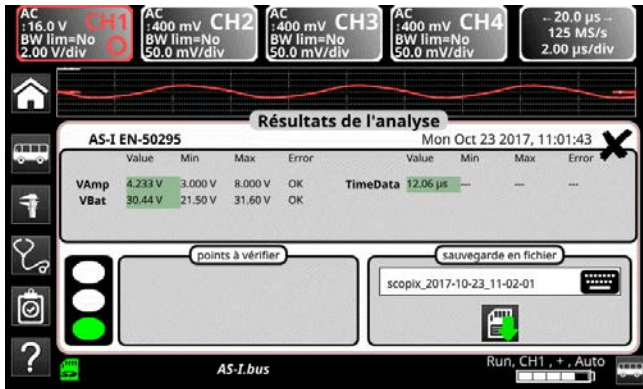

Diagnosis		Use this table to troubleshoot problems on a measurement :
Measurement	Description	Diagnosis
Vamp	Measurement of the amplitude of the signal's AC component	<ul style="list-style-type: none"> ▪ Termination problem (load too light) ▪ Cable length not compliant with standard ▪ Faulty junction connection (oxidation, bad contact, etc.) ▪ Significant noise (check the cable route, ground braid not connected, faulty chassis-ground, etc.) ▪ ...
Time Data	Measurement made using the bit time total. The bit time is measured over one period, because the AS-I bus uses Manchester coding.	
VBat	Measurement of the offset of the DC part of the signal. This corresponds to the AS-I bus power supply.	<ul style="list-style-type: none"> ▪ Unsuitable or damaged cable (load too light) ▪ Cable length not compliant with standard ▪ Faulty junction connection (oxidation, bad contact, etc.) ▪ Significant noise (check the cable route, ground braid not connected, faulty chassis-ground, etc.) ▪ ...

12.3 « CAN High-Speed » Bus

12.3.1. Overview

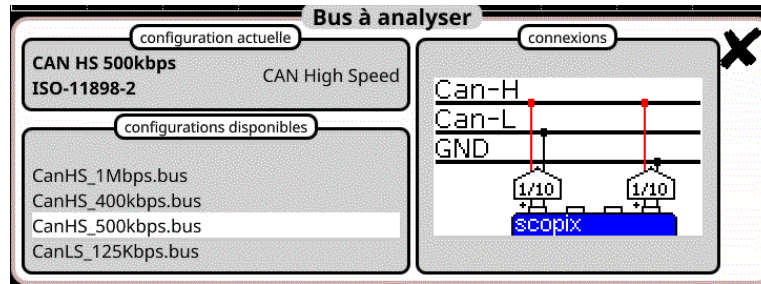

Configuration

Tolérances de mesure						
CAN HS 500kbps ISO-11898-2						
Vdiff Dom	1.20 V	3.00 V	10.0 %	Vdiff Rec	-120 mV	50.0 mV 10.0 %
VCanH Dom	-800 mV	7.00 V	10.0 %	VCanH Rec	-2.12 V	7.00 V 10.0 %
Time Rise	---	s	312 ns	10.0 %	Time Fall	---
Time Data	---	s	---	%	Jitter	---
Over+	---	%	---	%	Over-	---

Modifications enregistrées dans le fichier: scopix_2017-09-29_11-03-32

Measurement specification

12.3.2. Getting started

Equipment	<ul style="list-style-type: none"> two HX0130 or HX0030 sensors an HX0910 SUBD9 connection board (optional)
Configuration files	<ul style="list-style-type: none"> « CANHighSpeed_1Mbps » for a High Speed CAN Bus speed of 1 Mbps. <p>👉, The configuration file parameters are compliant with the ISO 11898-2 standard, on the receiver side.</p>
<p>Connections</p>	<p>Pin 7 : CAN H Pin 2 : CAN L Pin 3 : GND</p>

12.3.3. Measurements (CAN High-Speed)

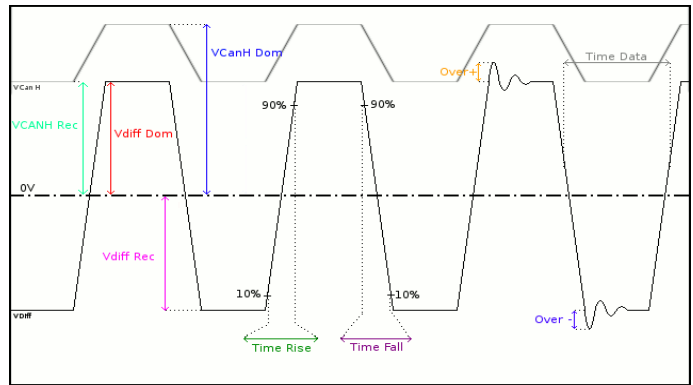
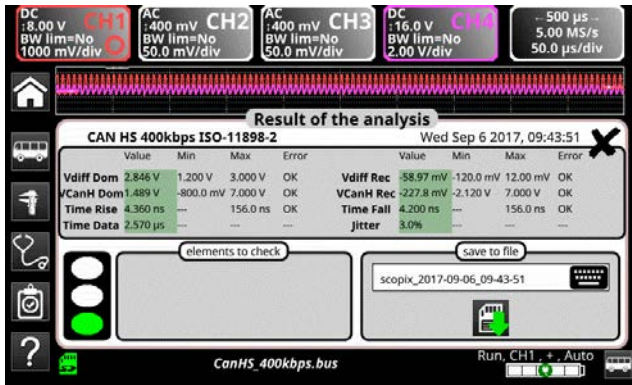

Diagnosis		Use this table to troubleshoot problems on a measurement :
Measurement	Description	Diagnosis
Vdiff Dom	Measurement of the Vdiff dominant state	<ul style="list-style-type: none"> Termination problem (load too light) Junction connection (oxidation, bad contact, etc.) Cable length not compliant with standard
Vdiff Rec	Measurement of the Vdiff recessive state	<ul style="list-style-type: none"> Significant noise (check the cable route, ground braid not connected, faulty chassis-ground, etc.) ...
VCanH Dom	Measurement of the Vcan dominant state	<ul style="list-style-type: none"> Chassis-ground disturbance problem Common mode problem Cable length not compliant with standard Significant noise (check the cable route, ground braid not connected, faulty chassis-ground, etc.)
VCanH Rec	Measurement of the Vcan recessive state	<ul style="list-style-type: none"> Junction connection (oxidation, bad contact, etc.) ...
Time Rise	Rise time between 10% and 90% of the VDiff signal amplitude	<ul style="list-style-type: none"> Unsuitable or damaged cable (the rise and fall times increase with the cable impedance) Termination impedance positioned incorrectly ...
Time Fall	Fall time between 90% and 10% of the VDiff signal amplitude	<ul style="list-style-type: none"> ...
Time Data	Measurement made using the bit time total	<ul style="list-style-type: none"> Unsuitable or damaged cable Termination impedance positioned incorrectly Significant noise (check the cable route, ground braid not connected, faulty chassis-ground, etc.) ...
Jitter	Measurement made using the bit time total	<ul style="list-style-type: none"> Significant noise (check the cable route, ground braid not connected, faulty chassis-ground, etc.) ...
Over +	Measurement of the positive overshoot compared to the Vdiff signal amplitude	<ul style="list-style-type: none"> Unsuitable cable impedance Bus termination problem (termination absent, major overshoot)
Over -	Measurement of the negative overshoot compared to the Vdiff signal amplitude	<ul style="list-style-type: none"> Significant noise (check the cable route, ground braid not connected, faulty chassis-ground, etc.) ...

12.4 « CAN Low-Speed » Bus

12.4.1. Overview

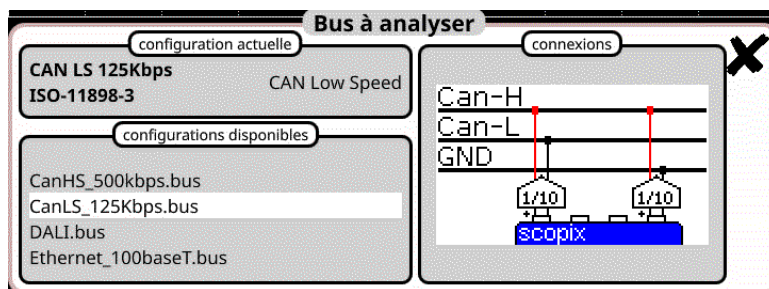

Configuration

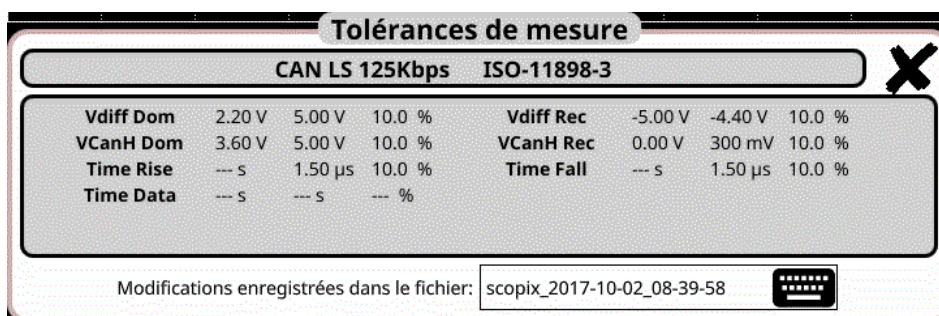

Measurement specification

12.4.2. Getting started

<p>Equipment</p>	<ul style="list-style-type: none"> two HX0130 or HX0030 sensors an HX0190 SUBD9 connection board (optional).
<p>Configuration files</p>	<ul style="list-style-type: none"> « CANLowSpeed_125Kbps » for a Low-Speed 125 Kbps CAN Bus. <p>👉, The configuration file parameters are compliant with the ISO 11898-32 standards, on the receiver side.</p>
<p>Connections</p> <p>CAN Low Speed</p>	<p>Pin 7 : CAN H Pin 2 : CAN L Pin 3 : GND</p>

12.4.3. Measurements (CAN Low-Speed)

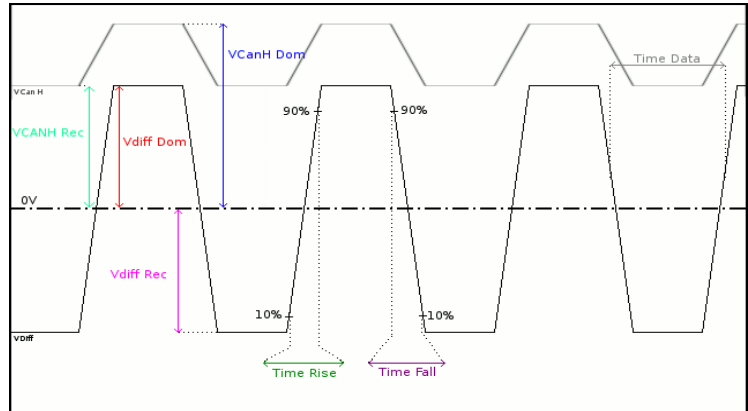
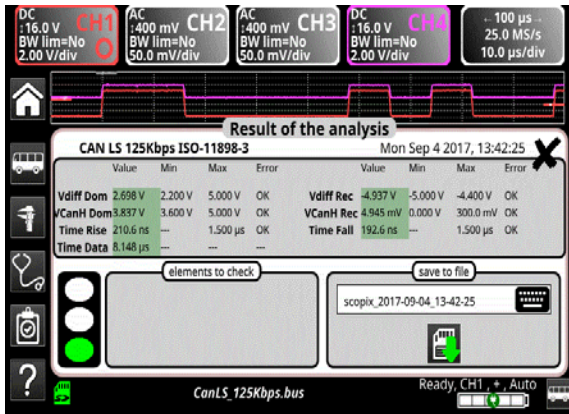

Diagnosis		Use this table to troubleshoot problems on a measurement :
Measurement	Description	Diagnosis
Vdiff Dom	Measurement of the Vdiff dominant state	<ul style="list-style-type: none"> Termination problem Junction connection (oxidation, bad contact, etc.) Cable length not compliant with standard
Vdiff Rec	Measurement of the Vdiff recessive state	<ul style="list-style-type: none"> Significant noise (check the cable route, ground braid not connected, faulty chassis-ground, etc.) ...
VCanH Dom	Measurement of the VcanH dominant state	<ul style="list-style-type: none"> Chassis-ground disturbance problem Common mode problem Cable length not compliant with standard Significant noise (check the cable route, ground braid not connected, faulty chassis-ground, etc.) Junction connection (oxidation, bad contact, etc.) ...
VCanH Rec	Measurement of the VcanH recessive state	
Time Rise	Rise time between 10% and 90% of the Vdiff signal amplitude	<ul style="list-style-type: none"> Unsuitable or damaged cable (the rise and fall times increase with the cable impedance) ...
Time Fall	Fall time between 90% and 10% of the Vdiff signal amplitude	
Time Data	Measurement made using the bit time total	<ul style="list-style-type: none"> Unsuitable or damaged cable Significant noise (check the cable route, ground braid not connected, faulty chassis-ground, etc.) ...

12.5 « DALI » Bus

12.5.1. Overview

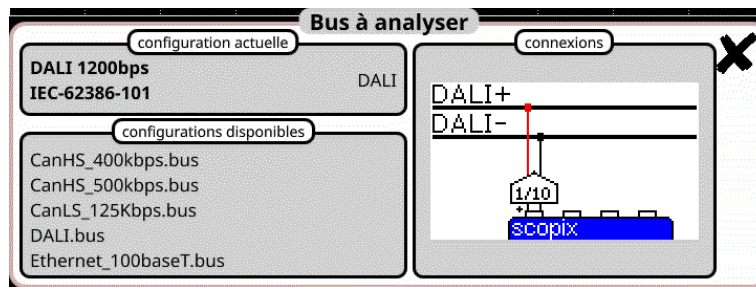

Configuration

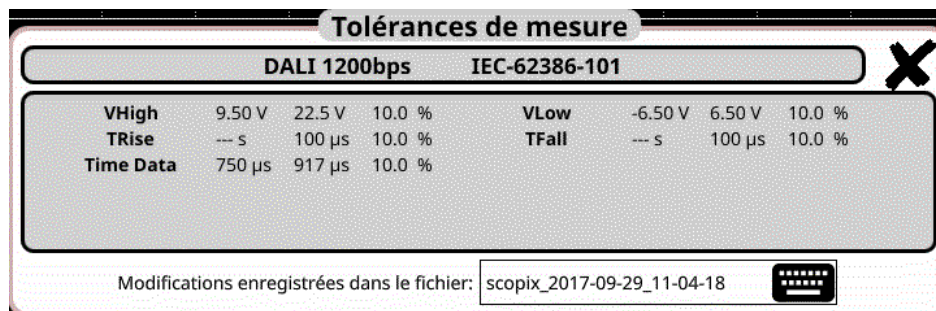

Measurement specification

12.5.2. Getting started

<p>Equipment</p>	<ul style="list-style-type: none"> ▪ an HX0130 or HX0030 sensor ▪ an HX0191 connection board (optional).
<p>Configuration files</p>	<ul style="list-style-type: none"> ▪ « DALI » for a speed of 1200 bds. ☞, The configuration file parameters are compliant with the IEC 62386-101 standard, on the receiver side.
<p>Connections</p>	<p>Pin 6 : DALI+ Pin 5 : DALI-</p>

12.5.3. Measurements (DALI)

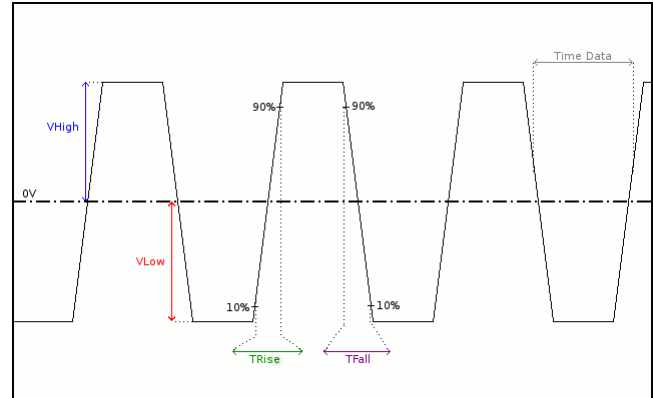
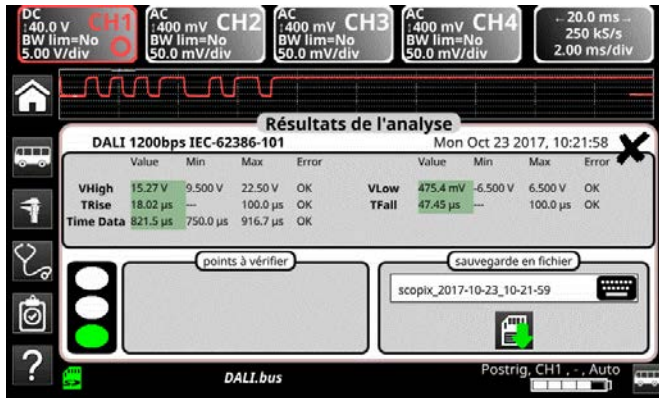

Diagnosis		Use this table to troubleshoot problems on a measurement :
Measurement	Description	Diagnosis
VHigh	Measurement of the signal high level	<ul style="list-style-type: none"> ▪ Termination problem ▪ Cable length not compliant with standard ▪ Chassis-ground disturbance problem ▪ Significant noise (check the cable route, ground braid not connected, faulty chassis-ground, etc.) ▪ ...
VLow	Measurement of the signal low level	
TRise	Rise time between 10% and 90% of the signal amplitude	<ul style="list-style-type: none"> ▪ Cable length not compliant with standard ▪ Unsuitable or damaged cable (the rise and fall times increase with the cable impedance) ▪ ...
TFall	Fall time between 90% and 10% of the signal amplitude	
Time Data	Measurement made using the bit time total	<ul style="list-style-type: none"> ▪ Cable length not compliant with standard ▪ Unsuitable or damaged cable ▪ Significant noise (check the cable route, ground braid not connected, faulty chassis-ground, etc.) ▪ ...

12.6 « Ethernet 10Base-2 » Bus

12.6.1. Overview

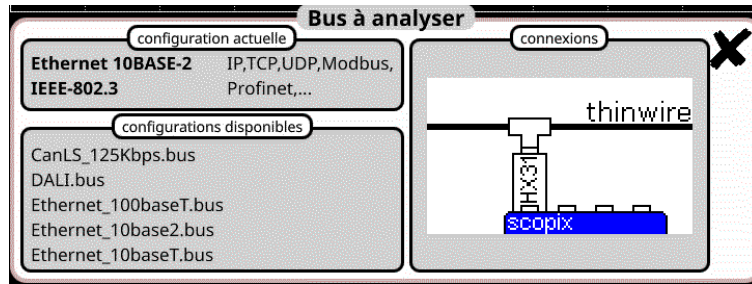

Configuration

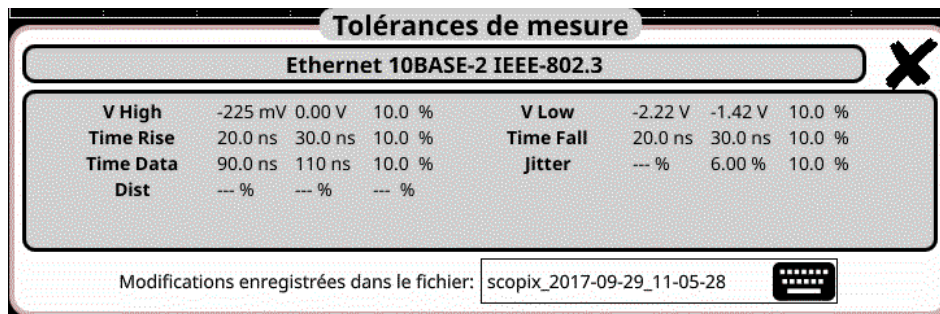

Measurement specification

12.6.2. Getting started

Equipment	<ul style="list-style-type: none"> ▪ a Probitx HX0131 probe ▪ a Tee with a male BNC and a female BNC
Configuration files	<ul style="list-style-type: none"> ▪ « Ethernet_10base2 » at 10 Mbps. <p>☞, The configuration file parameters are compliant with the IEEE 802.3 standard, on the receiver side.</p>
Connections	

12.6.3. Measurements (Ethernet 10Base-2)

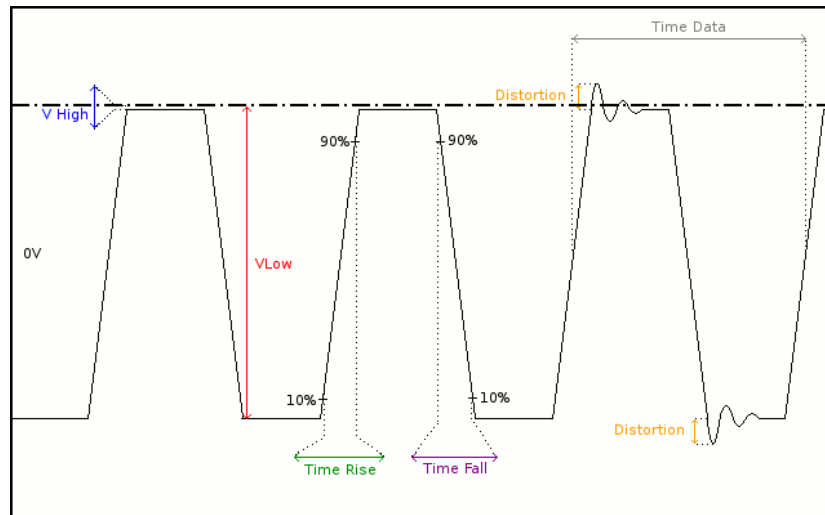

Diagnosis		Use this table to troubleshoot problems on a measurement :
Measurement	Description	Diagnosis
VHigh	Measurement of the high level	<ul style="list-style-type: none"> ▪ Termination problem ▪ Junction connection (oxidation, bad contact, etc.) ▪ Cable length not compliant with standard ▪ Significant noise (check the cable route, ground braid not connected, faulty chassis-ground, etc.) ▪ ...
VLow	Measurement of the low level	
Time Rise	Rise time between 10% and 90% of the signal amplitude	<ul style="list-style-type: none"> ▪ Unsuitable or damaged cable (the rise and fall times increase with the cable impedance) ▪ ...
Time Fall	Fall time between 90% and 10% of the signal amplitude	
Time Data	Measurement taken using total bit times Bit time is measured over one period (Manchester coding).	<ul style="list-style-type: none"> ▪ Unsuitable or damaged cable ▪ Significant noise (check the cable route, ground braid not connected, faulty chassis-ground, etc.) ▪ ...
Jitter	Measurement made using the bit time total	<ul style="list-style-type: none"> ▪ Significant noise (check the cable route, ground braid not connected, faulty chassis-ground, etc.) ▪ ...
Dist	Measurement of the amplitude distortion. The max overshoot level is compared to the signal peak-to-peak value.	<ul style="list-style-type: none"> ▪ Unsuitable cable impedance ▪ Termination problem (if there is no termination, major overshoot and the opposite if the bus impedance is too high) ▪ Significant noise (check the cable route, ground braid not connected, faulty chassis-ground, etc.) ▪ ...

12.7 « Ethernet 10Base-T » Bus

12.7.1. Overview

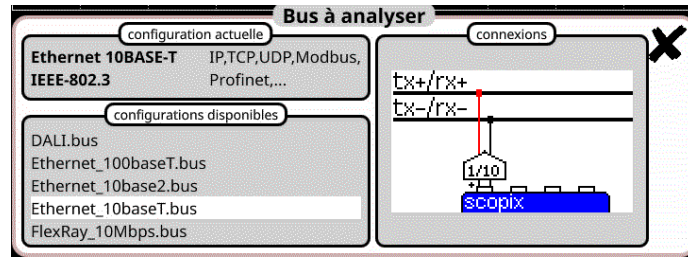

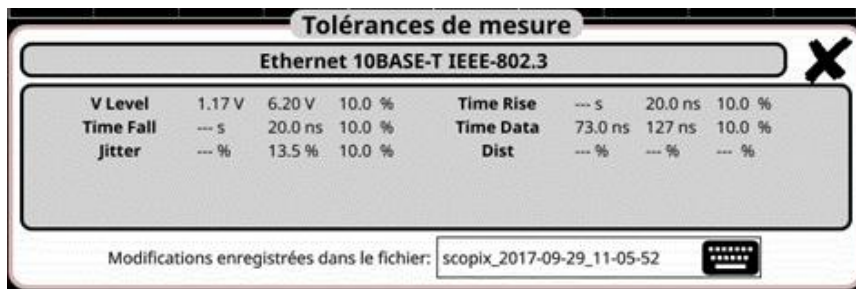

Configuration

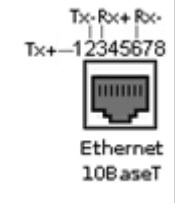
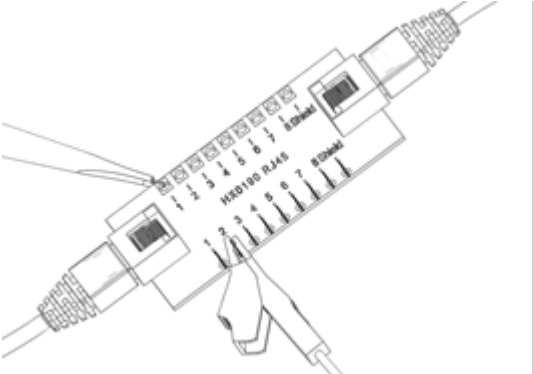

Measurement specification

12.7.2. Getting started

<p>Equipment</p>	<ul style="list-style-type: none"> an HX0130 or HX0030 sensor an HX0190 RJ45 connection board (optional)
<p>Configuration files</p>	<ul style="list-style-type: none"> « Ethernet_10baseT » at 10 Mbps. <p>☞, The configuration file parameters are compliant with the IEEE 802.3 standard, on the receiver side.</p>
<p>Connections</p>  <p>Ethernet 10BaseT</p>	  <p>Pin 3 : Rx+ Pin 2 Tx- Pin 6 : Rx-</p>

12.7.3. Measurements (Ethernet 10Base-T)

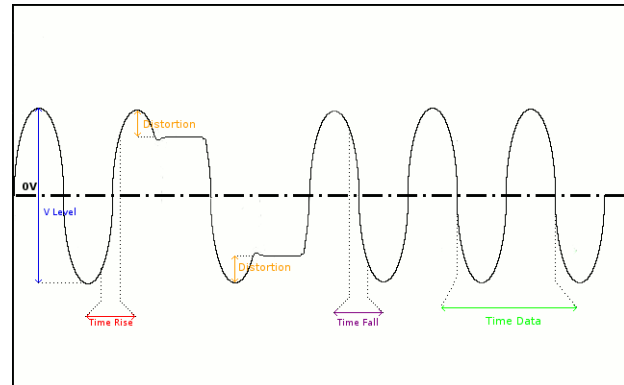
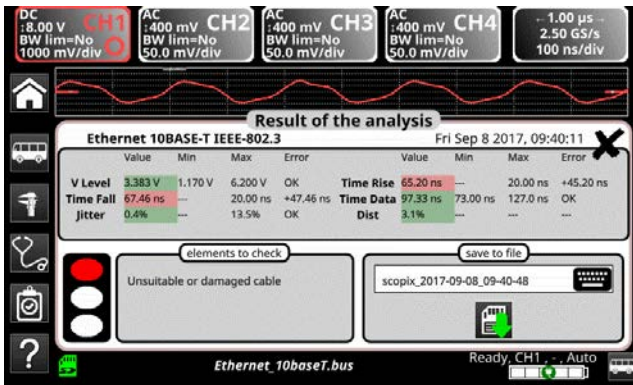

<i>Diagnosis</i>		Use this table to troubleshoot problems on a measurement :
Measurement	Description	Diagnosis
VLevel	Measurement of the amplitude on the signal's thin pulses	<ul style="list-style-type: none"> Termination problem Junction connection (oxidation, bad contact, etc.) Cable length not compliant with standard Significant noise (check the cable route, ground braid not connected, faulty chassis-ground, etc.) ...
Time Rise	Rise time between 10% and 90% of the signal amplitude	<ul style="list-style-type: none"> Unsuitable or damaged cable (the rise and fall times increase with the cable impedance) Termination impedance incorrectly positioned ...
Time Fall	Fall time between 90% and 10% of the signal amplitude	
Time Data	Measurement made using the bit time total. The bit time is measured on one period (Manchester coding). The measurement is only made on thin pulses.	<ul style="list-style-type: none"> Unsuitable or damaged cable Significant noise (check the cable route, ground braid not connected, faulty chassis-ground, etc.) ...
Jitter	Measurement made using the bit time total	<ul style="list-style-type: none"> Significant noise (check the cable route, ground braid not connected, faulty chassis-ground, etc.) ...
Dist	Measurement of the amplitude distortion. The max overshoot level is compared to the signal peak-to-peak value. The measurement is only made on thick pulses.	<ul style="list-style-type: none"> Unsuitable cable impedance Termination problem (if there is no termination, major overshoot and the opposite if the bus impedance is too high) Significant noise (check the cable route, ground braid not connected, faulty chassis-ground, etc.) ...

12.8 « FlexRay » Bus

12.8.1. Overview

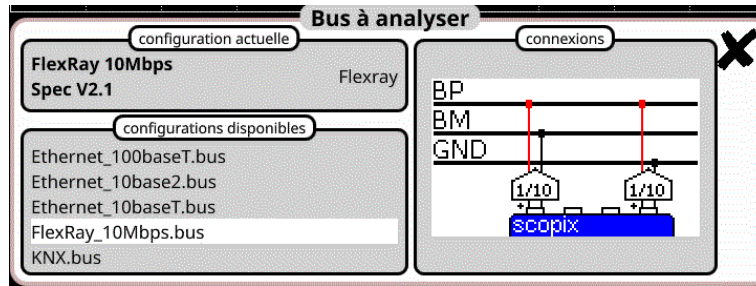



Configuration

Tolérances de mesure						
FlexRay 10Mbps Spec V2.1						
UBus High	400 mV	2.00 V	10.0 %	UBus Low	-2.00 V	-400 mV 10.0 %
Time Data	80.0 ns	120 ns	10.0 %	TRise	--- s	22.5 ns 10.0 %
TFall	--- s	22.5 ns	10.0 %	UCm	-10.0 V	15.0 V 10.0 %

Modifications enregistrées dans le fichier: scopix_2017-09-29_11-06-16

Measurement specification

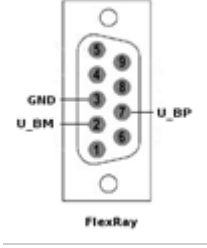
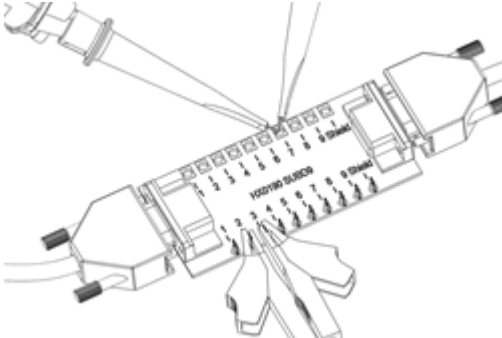
12.8.2. Getting started

Equipment	<ul style="list-style-type: none"> two HX0130 or HX0030 sensors an HX0190 SUBD9 connection board (optional)
Configuration files	<ul style="list-style-type: none"> « FlexRay_10Mbps » for a FlexRayat 10 Mbps. 👉, The configuration file parameters are compliant with Spec V2.1. 👉, To analyse the FlexRay bus at other speeds you must create a new « BUS » configuration file using the PC SxBus software.
<p>Connections</p> 	  <p>Pin 7 : U_BP Pin 2 : U_BM Pin 3 : GND</p>

12.8.3. Measurements (FlexRay)

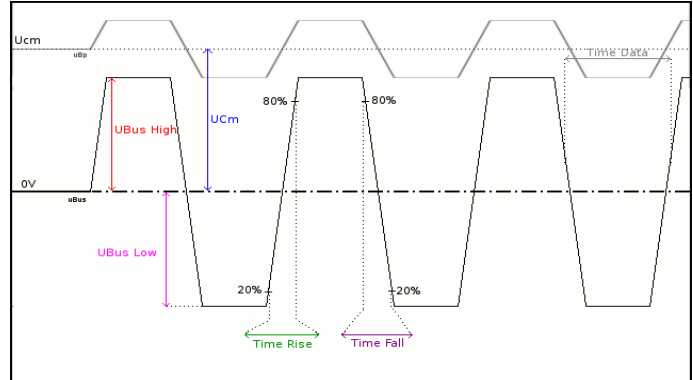
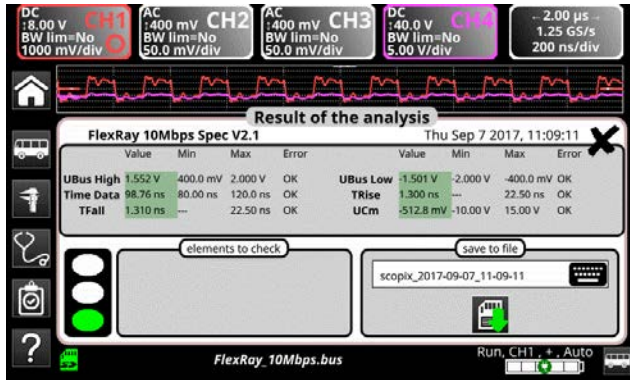

$$UBus = U_BP - U_BM$$

<i>Diagnosis</i>		Use this table to troubleshoot problems on a measurement :
Measurement	Description	Diagnosis
UBus High	Measurement of the high level on the Ubus signal	<ul style="list-style-type: none"> ▪ Termination problem ▪ Junction connection (oxidation, bad contact, ...) ▪ Cable length not compliant with standard ▪ Significant noise (check the cable route, ground braid not connected, faulty chassis-ground, etc.) ▪ ...
UBus Low	Measurement of the low level on the UBus signal	
Time Data	Measurement made using the bit time total.	<ul style="list-style-type: none"> ▪ Unsuitable or damaged cable ▪ Termination impedance incorrectly positioned ▪ Significant noise (check the cable route, ground braid not connected, faulty chassis-ground, etc.) ▪ ...
TRise	Rise time between 20% and 80% of the UBus signal amplitude	<ul style="list-style-type: none"> ▪ Unsuitable or damaged cable (the rise and fall times increase with the cable impedance) ▪ Termination impedance incorrectly positioned ▪ ...
TFall	Fall time between 80% and 20% of the UBus signal amplitude	
UCm	Offset measurement on the U_BP signal	<ul style="list-style-type: none"> ▪ Chassis-ground disturbance problem ▪ Common mode problem ▪ Cable length not compliant with standard ▪ ...

12.9 « KNX » Bus

12.9.1. Overview



To be analyzed, the signal must meet the following conditions :
VLow Active < -1.2 V
VMax equalisation > 1.2 V

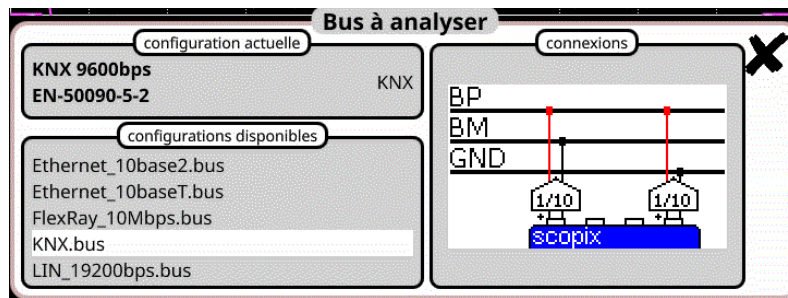

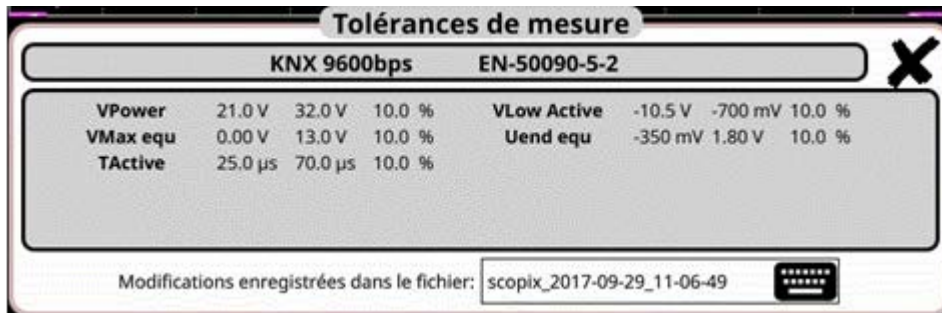

Configuration

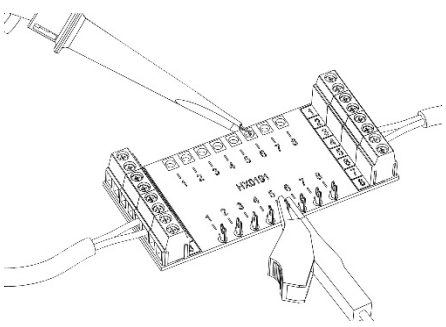

Measurement specification

12.9.2. Getting started

Equipment	<ul style="list-style-type: none"> an HX0130 or HX0030 sensor an HX0191 generic connection board (optional)
Configuration files	<ul style="list-style-type: none"> « KNX » for a speed of 9600 bps. <p>☞, The configuration file parameters are compliant with the EN 50090-5-2 standard, on the receiver side.</p>
Connections	 <p>Pin 6 : KNX+ Pin 5 : KNX-</p> 

12.9.3. Measurements (KNX)

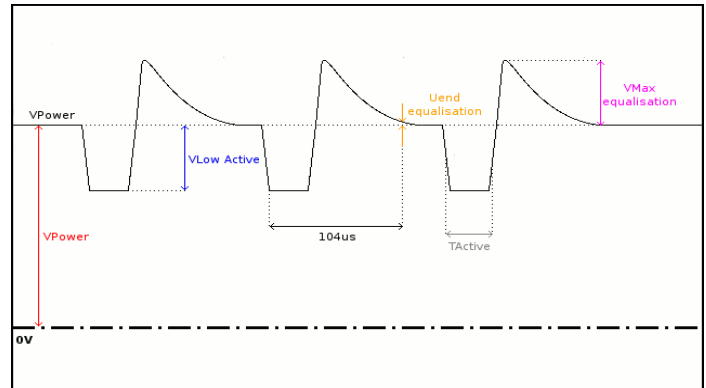
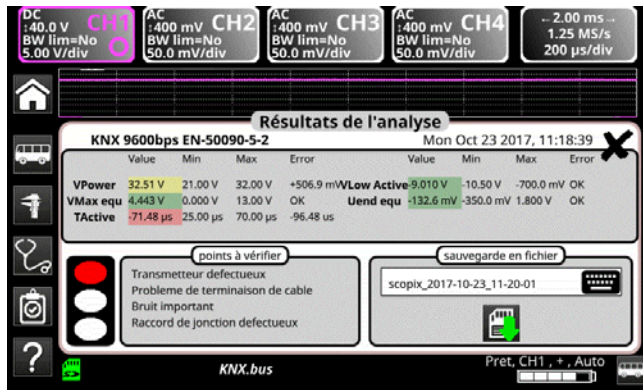
**Diagnosis**

Use this table to troubleshoot problems on a measurement :

Measurement	Description	Diagnosis
VPower	Measurement of the KNX signal offset (power supply)	<ul style="list-style-type: none"> ▪ Too many devices on the bus ▪ Cable length not compliant with standard ▪ Faulty power supply ▪ ...
VLow Active	Negative pulse low-level measurement	<ul style="list-style-type: none"> ▪ Faulty transmitter ▪ Cable length not compliant with standard ▪ Termination problem ▪ Significant noise (check the cable route, ground braid not connected, faulty chassis-ground, etc.) ▪ Faulty junction connection (oxidation, bad contact, etc.) ▪ ...
VMax equalisation	Measurement of the signal high level	<ul style="list-style-type: none"> ▪ Significant noise (check the cable route, ground braid not connected, faulty chassis-ground, etc.) ▪ Faulty transmitter ▪ ...
Uend equalisation	Voltage level compared to VPower after 104 μ s. The 104 μ s are measured from the falling edge of the low pulse.	<ul style="list-style-type: none"> ▪ Faulty transmitter ▪ Cable length not compliant with standard ▪ Termination problem ▪ Significant noise (check the cable route, ground braid not connected, faulty chassis-ground, etc.) ▪ Faulty junction connection (oxidation, bad contact, etc.) ▪ ...
TActive	Measurement made using the bit time total. Bit time measured only on low pulses.	<ul style="list-style-type: none"> ▪ Faulty transmitter ▪ Cable length not compliant with standard ▪ Termination problem ▪ Significant noise (check the cable route, ground braid not connected, faulty chassis-ground, etc.) ▪ Faulty junction connection (oxidation, bad contact, etc.) ▪ ...

12.10 « LIN » Bus

12.10.1. Overview

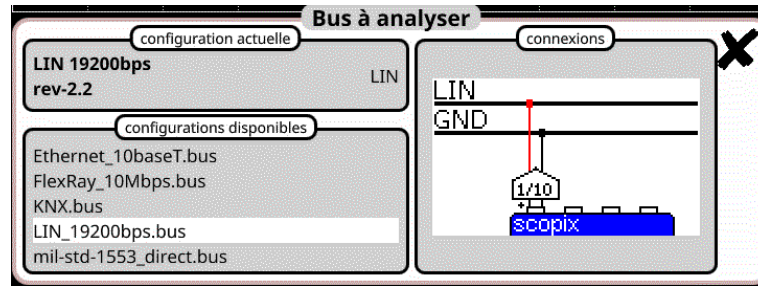



Configuration

Tolérances de mesure						
LIN 19200bps rev-2.2						
VBat	8.00 V	18.0 V	10.0 %	Time Data	51.3 µs	52.9 µs 10.0 %
Time Rise	750 kV/s	3.00 MV/µs	±0.0 %	Time Fall	750 kV/s	3.00 MV/µs ±0.0 %
Delta Tr Tf	-2.00 µs	2.00 µs	10.0 %			

Modifications enregistrées dans le fichier: scopix_2017-09-29_11-08-11

Measurement specification

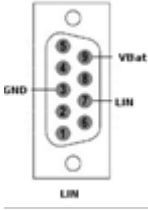
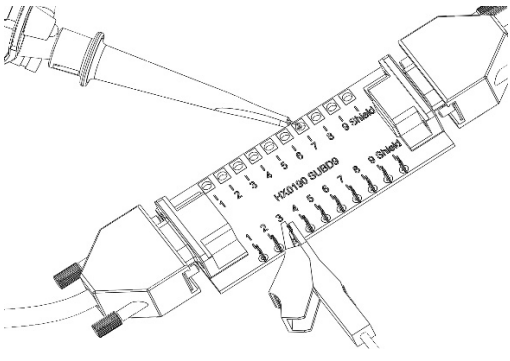
12.10.2. Getting started

Equipment	<ul style="list-style-type: none"> an HX0130 or HX0030 sensor an HX0190 SBD9 connection board (optional)
Configuration files	<ul style="list-style-type: none"> « LIN_19200bps » for a LIN bus at 19200 bds. ☞, The configuration file parameters are compliant with rev-2.2. ☞, To analyse the LIN bus at other speeds you must create a new « BUS » configuration file using the PC SxBus software.
Connections 	 <p>Pin 7 : LIN Pin 5 : GND</p> 

12.10.3. Measurements (LIN)

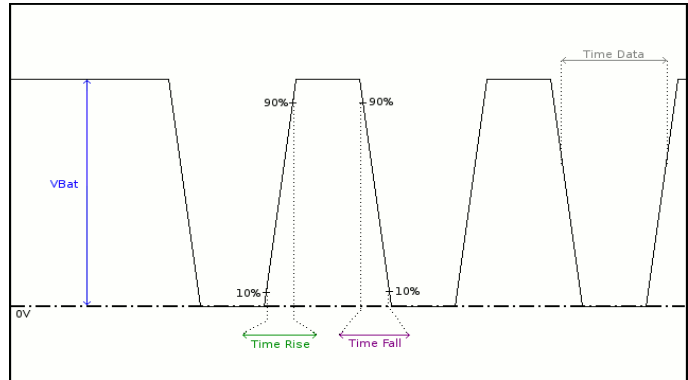
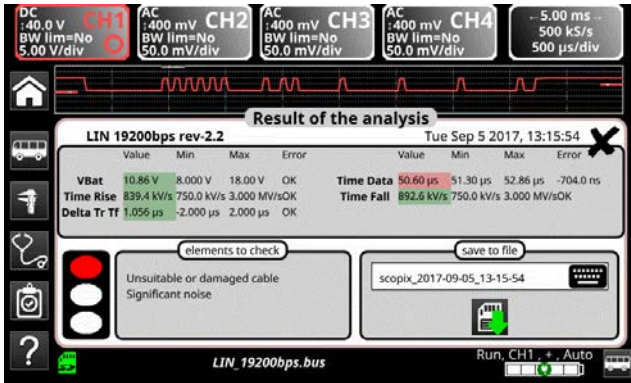

Diagnosis		Use this table to troubleshoot problems on a measurement :
Measurement	Description	Diagnosis
VBat	Measurement of the signal high level	<ul style="list-style-type: none"> Too many devices on the bus Cable length not compliant with standard Faulty power supply Faulty chassis-ground Incorrectly connected chassis-ground Termination problem Junction connection (oxidation, bad contact) Significant noise (check the cable route, ground braid not connected, faulty chassis-ground, etc.) ...
Time Data	Measurement made using the bit time total	<ul style="list-style-type: none"> Unsuitable or damaged cable Significant noise (check the cable route, ground braid not connected, faulty chassis-ground, etc.) ...
Time Rise	Rise time between 10% and 90% of the signal amplitude expressed in Volt/second	<ul style="list-style-type: none"> Unsuitable or damaged cable (the rise and fall times increase with the cable impedance) ...
Time Fall	Fall time between 90% and 10% of the signal amplitude expressed in Volt/second	
Delta TRise TFall	Difference between the rise time at 10% 90% and the fall time at 90% 10%	<ul style="list-style-type: none"> Unsuitable or damaged cable (the rise and fall times increase with the cable impedance) Significant noise (check the cable route, ground braid not connected, faulty chassis-ground, etc.) ...

12.11 « MIL-STD-1553 » Bus

12.11.1. Overview

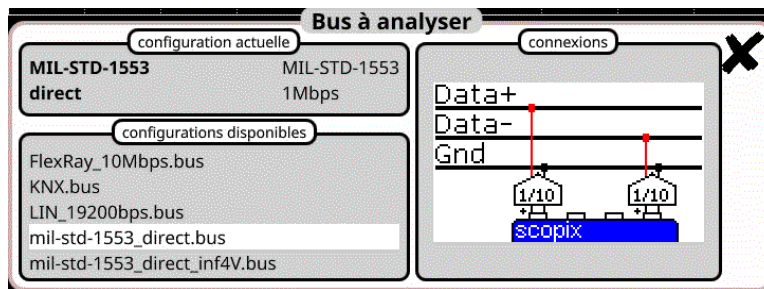

Configuration

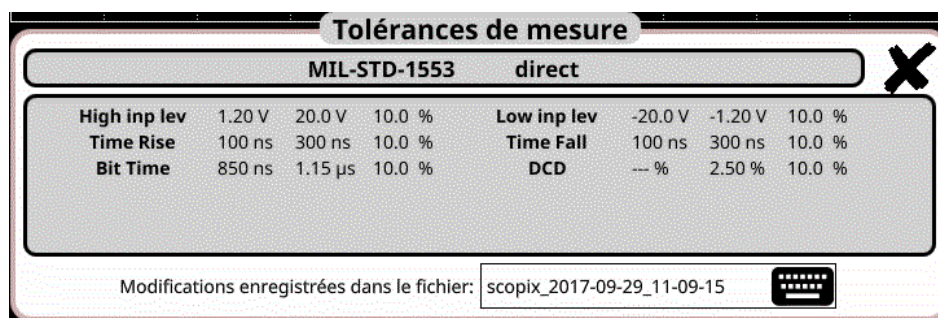

Measurement specification

12.11.2. Getting started

Equipment	<ul style="list-style-type: none"> two HX0130 or HX0030 sensors an HX0191 generic connection card (optionnelle)
Configuration files	<ul style="list-style-type: none"> « mil-std-1553_direct », « mil-std-1553_transfo » <p>☞, The configuration file parameters are compliant with the MIL-STD-1553 standard, on the receiver side.</p>
Connections	

12.11.3. Measurements (MIL-STD-1553)

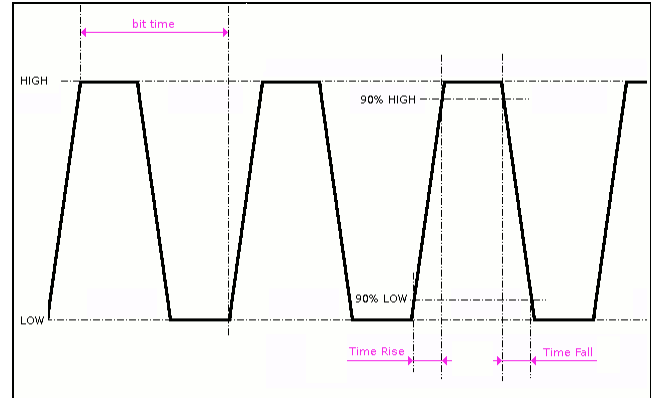
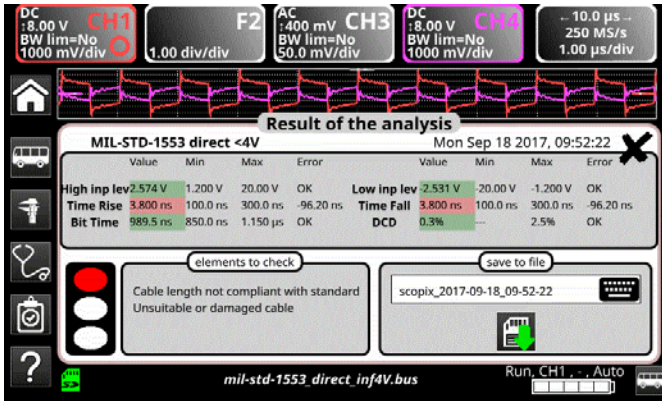

Diagnosis		Use this table to troubleshoot problems on a measurement :
Measurement	Description	Diagnosis
High Input Level	Measurement of the signal high level	<ul style="list-style-type: none"> ▪ Termination problem (load too light) ▪ Cable length not compliant with standard ▪ Faulty junction connection (oxidation, bad contact, etc.) ▪ Significant noise (check the cable route, ground braid not connected, faulty chassis-ground, etc.) ▪ ...
Low Input Level	Measurement of the signal low level	
Time Rise	Rise time	<ul style="list-style-type: none"> ▪ Cable length not compliant with standard ▪ Unsuitable or damaged cable (the rise and fall times increase with the cable impedance) ▪ ...
Time Fall	Fall time	
Bit Time	Time of a bit	<ul style="list-style-type: none"> ▪ Cable length not compliant with standard ▪ Unsuitable or damaged cable ▪ Significant noise (check the cable route, ground braid not connected, faulty chassis-ground, etc.) ▪ ...
DCD	Measuring duty cycle between positive and negative pulses Measurements made from a combination of positive and negative pulses	<ul style="list-style-type: none"> ▪ Unsuitable or damaged cable ▪ Significant noise (check the cable route, ground braid not connected, faulty chassis-ground, etc.) ▪ Cable length not compliant with standard ▪ ...

12.12 « Profibus DP » Bus

 **To be analyzed, the signal amplitude must be greater than 700 mV.**

12.12.1. Overview

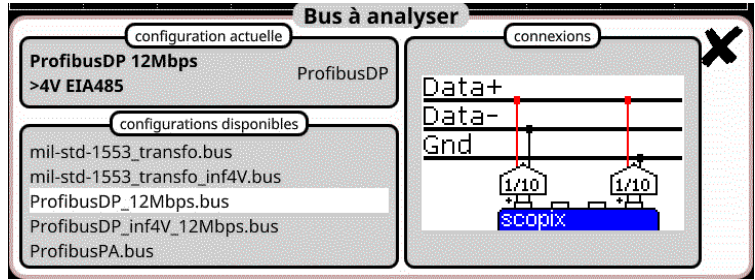

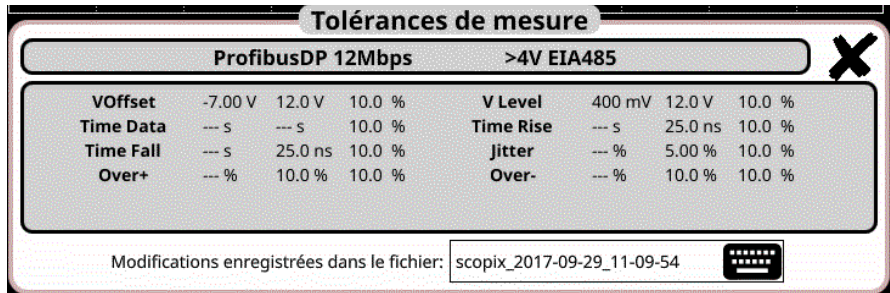

Configuration

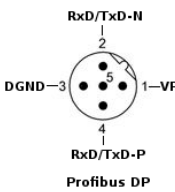
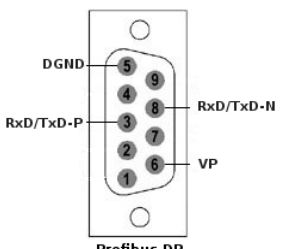
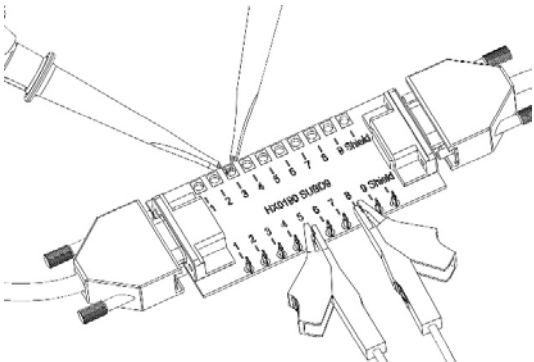

Measurement specification

12.12.2. Getting started

<p>Equipment</p>	<ul style="list-style-type: none"> two HX0130 or HX0030 sensors an HX0190 SUBD9 connection board (optional) or an HX0191 M12 connection board (optional)
<p>Configuration files</p>	<ul style="list-style-type: none"> " ProfibusDP_12Mbps " for a Profibus DP bus, 12 Mbps speed, amplitude > 4 V " ProfibusDP_inf4V_12Mbps " for a Profibus DP bus, 12 Mbps speed, amplitude < 4 V " RS485_10Mbps " for a RS485 bus, 10 Mbps speed, amplitude > 4 V " RS485_inf4V_10Mbps " for a RS485 bus, 10 Mbps speed, amplitude < 4 V " RS485_19200bps " for a RS485 bus, 19200 bps speed, amplitude > 4 V " RS485_inf4V_19200bps " for a RS485 bus, 19200 bps speed, amplitude < 4 V <p>☞, The configuration file parameters are compliant with the EIA-485 standard.</p> <p>- To analyse the Profibus bus at other speeds you must create a new « .BUS » configuration file using the PC SxBus software.</p>
<p>Connections</p>  <p>OU</p> 	<p>HX0190 SUBD9</p>   <p>Pin 3 : RxD/TxD-P Pin 8 : RxD/TxD-N Pin 5 : RxD/TxD-N</p>

12.12.3. Measurements (Profibus DP)

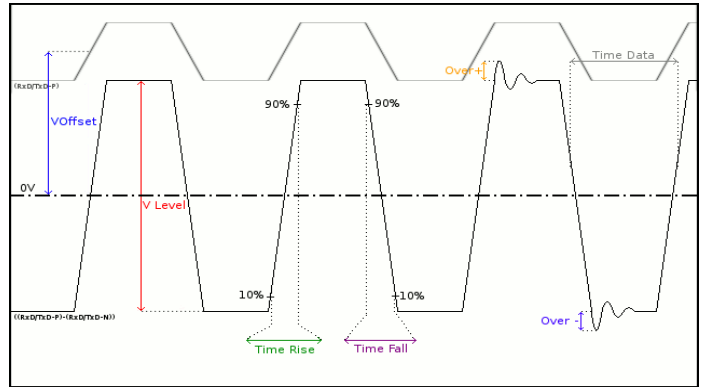
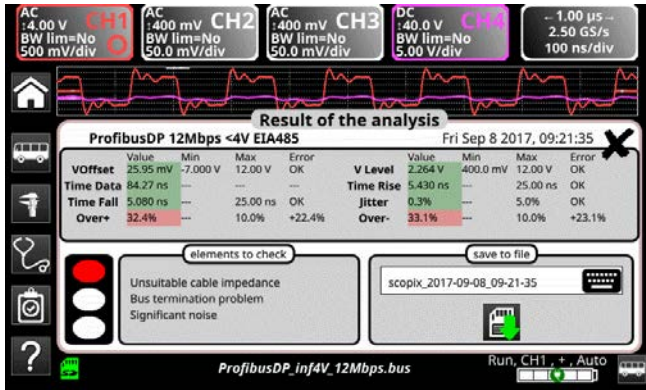

Diagnosis		Use this table to troubleshoot problems on a measurement :
Measurement	Description	Diagnosis
VOffset	Offset measurement on the RxD-P or TxD-P signal	<ul style="list-style-type: none"> Chassis-ground disturbance problem Common mode problem Cable length not compliant with standard
VLevel	Signal amplitude measurement ((RxD-P/TxD-P) -(RxD-N/TxDN))	<ul style="list-style-type: none"> Termination problem Junction connection (oxidation, bad contact, etc.) Cable length not compliant with standard Significant noise (check the cable route, ground braid not connected, faulty chassis-ground, etc.) ...
Time Data	Measurement made using the bit time total.	<ul style="list-style-type: none"> Unsuitable or damaged cable Termination impedance incorrectly positioned Significant noise (check the cable route, ground braid not connected, faulty chassis-ground, etc.) ...
Time Rise	Rise time between 10% and 90% of the signal amplitude	<ul style="list-style-type: none"> Unsuitable or damaged cable (the rise and fall times increase with the cable impedance) Termination impedance incorrectly positioned ...
Time Fall	Fall time between 90% and 10% of the signal amplitude	<ul style="list-style-type: none"> ...
Jitter	Measurement made using the bit time total	<ul style="list-style-type: none"> Significant noise (check the cable route, ground braid not connected, faulty chassis-ground, etc.) ...
Over+	Measurement of the positive overshoot compared to the signal amplitude	<ul style="list-style-type: none"> Unsuitable cable impedance Termination problem (if there is no termination, major overshoot and the opposite if the bus impedance is too high)
Over-	Measurement of the negative overshoot compared to the signal amplitude	<ul style="list-style-type: none"> Significant noise (check the cable route, ground braid not connected, faulty chassis-ground, etc.) ...

12.13 « Profibus PA » Bus

 *To be analyzed, the signal amplitude must be greater than 300 mV.*

12.13.1. Overview

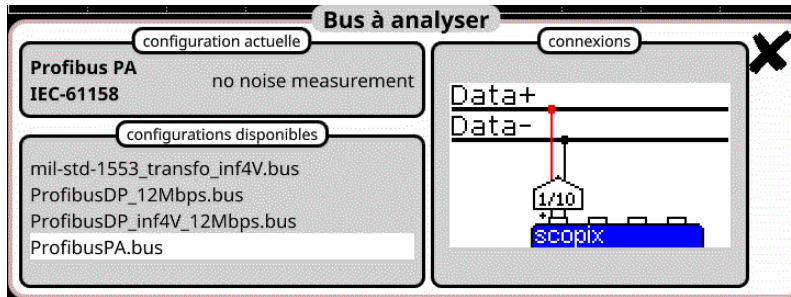

Configuration

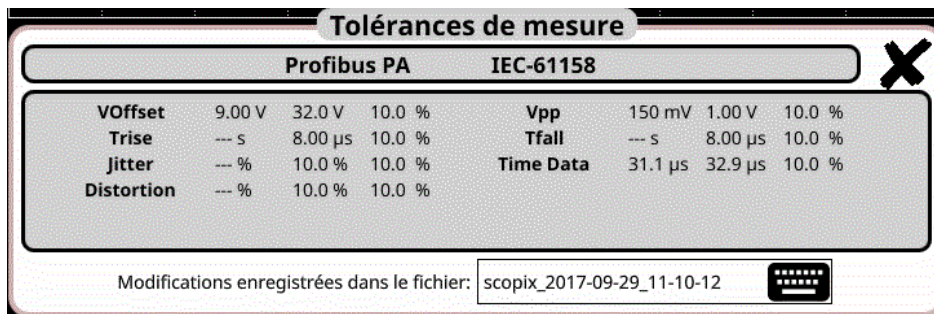

Measurement specification

12.13.2. Getting started

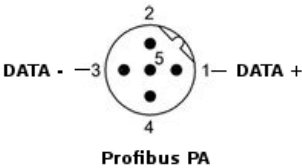
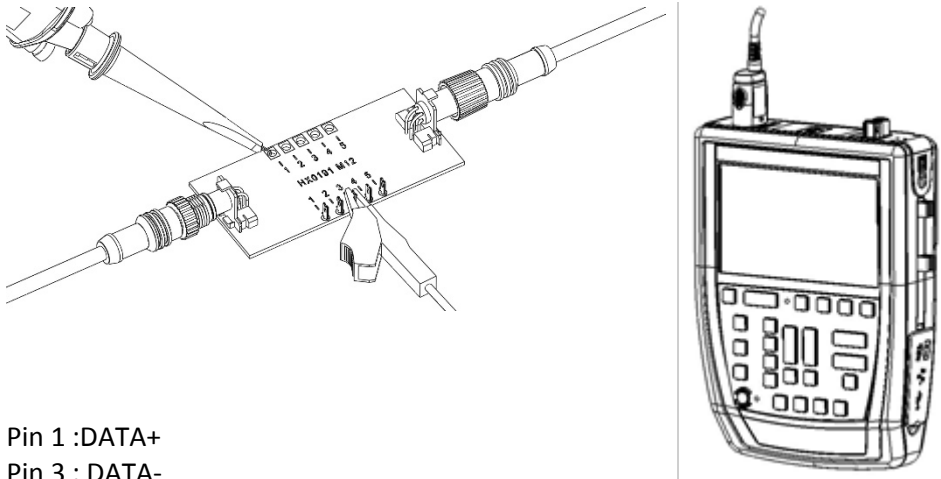
<p>Equipment</p>	<ul style="list-style-type: none"> an HX0130 or HX0030 sensor an HX0191 M12 connection board (optional)
<p>Configuration files</p>	<ul style="list-style-type: none"> " ProfibusPA_Noise " for a Profibus PA bus at 31.25 kbps with a noise measurement " Profibus_PA " for a Profibus PA bus at 31.25 kbps without a noise measurement <p>☞, The configuration file parameters are compliant with the IEC 61158 standard.</p> <p>☞, To analyse the Profibus bus at other speeds you must create a new « .BUS » configuration file using the PC SxBus software.</p>
<p>Connections</p>  <p>Profibus PA</p>	 <p>Pin 1 :DATA+ Pin 3 : DATA-</p>

12.13.3. Measurements (Profibus PA)

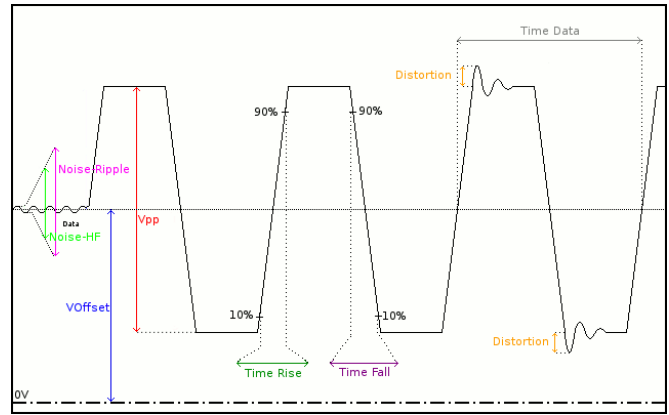
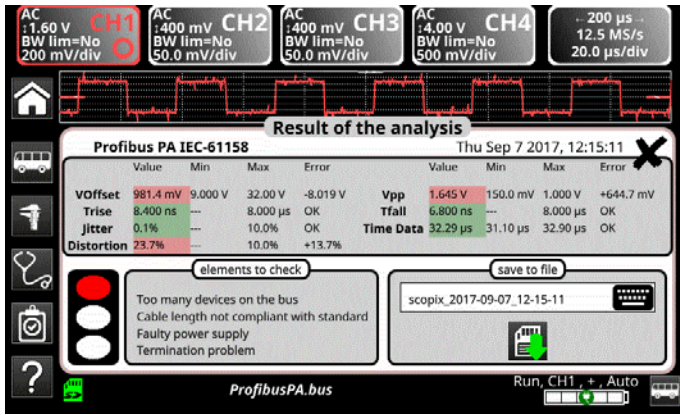

Diagnosis		Use this table to troubleshoot problems on a measurement :
Measurement	Description	Diagnosis
VOffset	Offset measurement on the Data signal	<ul style="list-style-type: none"> Too many devices on the bus Cable length not compliant with standard Faulty power supply ...
Vpp	Peak-to-peak measurement on the Data signal	<ul style="list-style-type: none"> Termination problem Cable length not compliant with standard Faulty junction connection (oxidation, bad contact, etc.) Significant noise (check the cable route, ground braid not connected, faulty chassis-ground, etc.) ...
TRise	Rise time between 10% and 90% of the Data signal amplitude	<ul style="list-style-type: none"> Cable length not compliant with standard Unsuitable or damaged cable (the rise and fall times increase with the cable impedance) Termination impedance incorrectly positioned ...
TFall	Fall time between 90% and 10% of the Data signal amplitude	
Jitter	Measurement made using the bit time total.	<ul style="list-style-type: none"> Significant noise (check the cable route, ground braid not connected, faulty chassis-ground, etc.) ...
Time Data	Measurement made using the bit time total. The bit time is measured on one period (Manchester coding).	<ul style="list-style-type: none"> Significant noise (check the cable route, ground braid not connected, faulty chassis-ground, etc.) The cable length is not compliant with the standard Unsuitable or damaged cable Termination impedance incorrectly positioned
Distortion	Measurement of amplitude distortion as defined in the IEC-61152 standard. The max overshoot level is compared to the signal peak-to-peak value.	<ul style="list-style-type: none"> Unsuitable cable impedance Termination problem (if there is no termination, major overshoot and the opposite if the bus impedance is too high) Significant noise (check the cable route, ground braid not connected, faulty chassis-ground, etc.) ...
Noise-Ripple	Search for the max. peak-to-peak value for signals between 7.8kHz and 39.1kHz on the dead time part of the bus, i.e. its power supply	<ul style="list-style-type: none"> Excessive noise between 7.8kHz and 39.1kHz on the power supply (check whether the power supply is faulty, check the cable route, ground braid nit connected, faulty chassis-ground, etc.) ...
Noise-HF	Search for the max. peak-to-peak value for signals between 3.91MHz and 25MHz on the dead time part of the bus, i.e. its power supply	<ul style="list-style-type: none"> Excessive noise between 3.91MHz and 25MHz on the power supply (check whether the power supply is faulty, check the cable route, ground braid not connected, faulty chassis-ground, etc.) ...

12.14 « RS232 » Bus

12.14.1. Overview

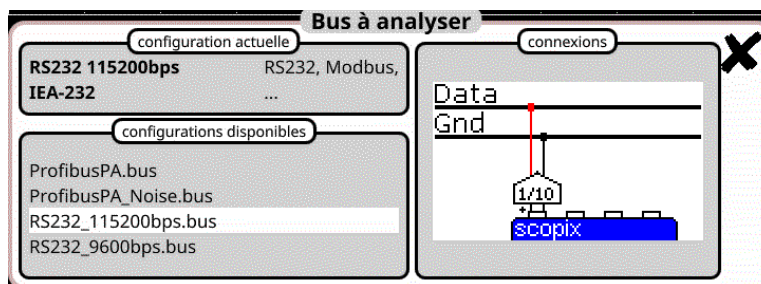

Configuration

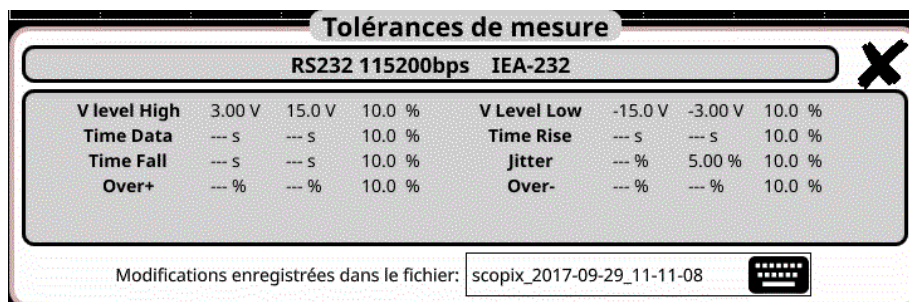

Measurement specification

12.14.2. Getting started

Equipment	<ul style="list-style-type: none"> an HX0130 or HX0030 sensor an HX0190 SUBD9 connection board (optional)
Configuration files	<ul style="list-style-type: none"> " RS232_9600bps " to analyse a RS232 bus at 9600 bps " RS232_115200bps " to analyse a RS232 bus at 115200 bps <p>👉, The configuration file parameters are compliant with the EIA-232 standard, on the receiver side.</p> <p>👉, To analyse the RS232 bus at other speeds you must create a new « .BUS » configuration file using the PC SxBus software.</p>
Connections	<p>Pin 2 : Rx Data Pin 3 : Tx Data Pin 5 : masse Measurement between 2 (or 3) and 5</p>

12.14.3. Measurements (RS232)

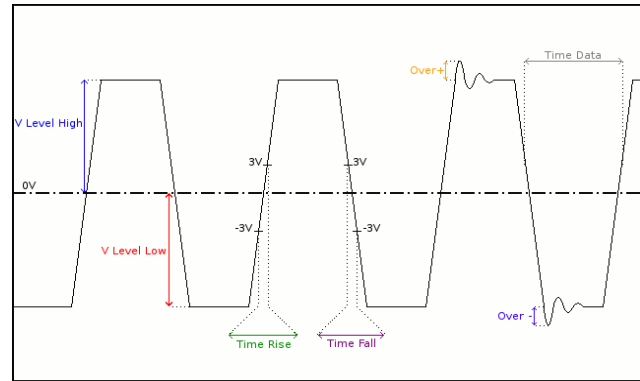
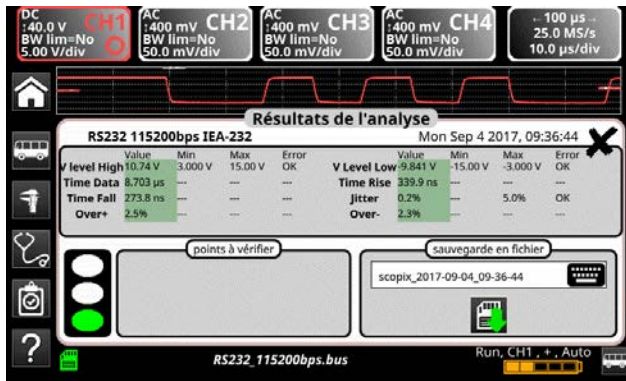

Diagnosis		Use this table to troubleshoot problems on a measurement :
Measurement	Description	Diagnosis
VLevel High	Measurement of the signal high level	<ul style="list-style-type: none"> Termination problem Cable length not compliant with standard Chassis-ground disturbance problem
VLevel Low	Measurement of the signal low level	<ul style="list-style-type: none"> Significant noise (check the cable route, ground braid not connected, faulty chassis-ground, etc.) ...
Time Data	Measurement made using the bit time total	<ul style="list-style-type: none"> Significant noise (check the cable route, ground braid not connected, faulty chassis-ground, etc.) Cable length not compliant with standard Unsuitable or damaged cable ...
Time Rise	Rise time between -3V and 3V	<ul style="list-style-type: none"> Cable length not compliant with standard Unsuitable or damaged cable (the rise and fall times increase with the cable impedance) ...
Time Fall	Fall time between 3V and -3V	
Jitter	Measurement made using the bit time total	<ul style="list-style-type: none"> Significant noise (check the cable route, ground braid not connected, faulty chassis-ground, etc.) ...
Over+	Positive overshoot measurement	<ul style="list-style-type: none"> Unsuitable cable impedance Bus termination problem (termination absent, major overshoot) Significant noise (check the cable route, ground braid not connected, faulty chassis-ground, etc.) ...
Over-	Negative overshoot measurement	

12.15 « RS485 » Bus

 **To be analyzed, the signal amplitude must be greater than 700 mV.**

12.15.1. Overview

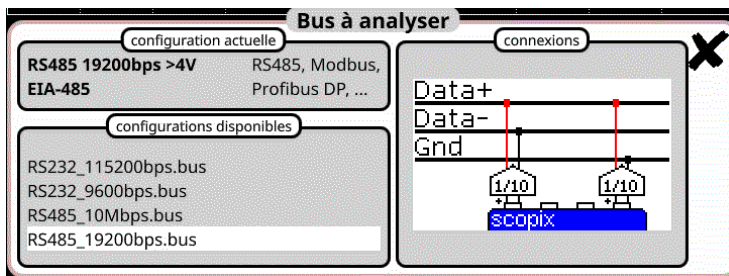



Configuration

Tolérances de mesure						
RS485 19200bps >4V				EIA-485		
VOffset	-7.00 V	12.0 V	10.0 %	V Level	400 mV	12.0 V 10.0 %
Time Data	--- s	--- s	10.0 %	Time Rise	--- s	15.6 µs 10.0 %
Time Fall	--- s	15.6 µs	10.0 %	Jitter	--- %	5.00 % 10.0 %
Over+	--- %	10.0 %	10.0 %	Over-	--- %	10.0 % 10.0 %

Modifications enregistrées dans le fichier: scopix_2017-09-29_11-11-31

Measurement specification

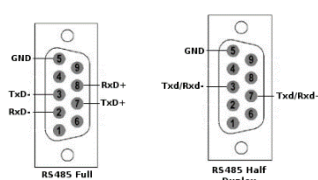
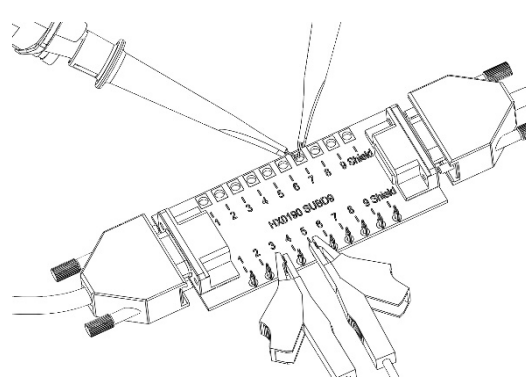
12.15.2. Getting started

<p>Equipment</p>	<ul style="list-style-type: none"> two HX0130 or HX0030 sensors an HX0190 SUBD9 connection board (optional)
<p>Configuration files</p>	<ul style="list-style-type: none"> " RS485_10Mbps " for a RS485 bus, 10 Mbps speed, amplitude > 4 V " RS485_inf4V_10Mbps " for a RS485 bus, 10 Mbps speed, amplitude < 4 V " RS485_19200bps " for a RS485 bus, 19200 bps speed, amplitude > 4 V " RS485_inf4V_19200bps " for a RS485 bus, 19200 bps speed, amplitude < 4 V <p>👉, The configuration file parameters are compliant with the EIA-485 standard, on the receiver side.</p> <p>👉, To analyse the RS485 bus at other speeds you must create a new « .BUS » configuration file using the PC SxBus software.</p>
<p>Connections</p> 	 <p>Pin 7 : Tx+</p> <p>Pin 3 : Tx-</p> <p>Pin 5 : chassis-ground</p> 

12.15.3. Measurements (RS485)

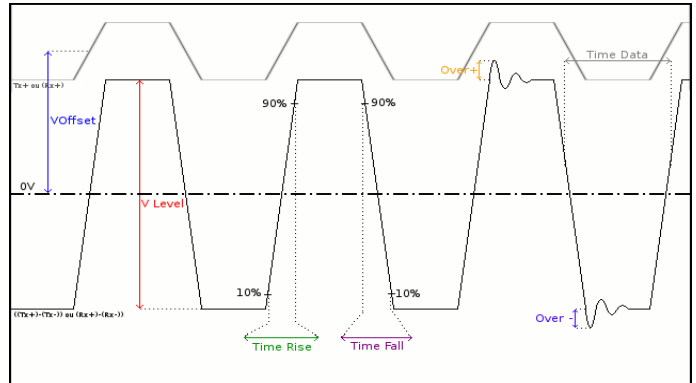
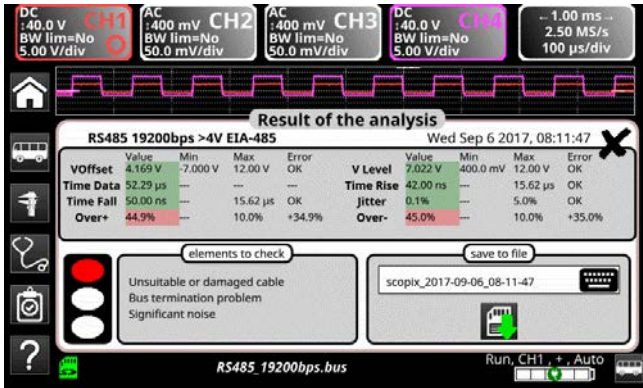

Diagnosis		Use this table to troubleshoot problems on a measurement :
Measurement	Description	Diagnosis
VOffset	Offset measurement on the Tx+ or (Rx+) signal (signal present on channel 4)	<ul style="list-style-type: none"> Chassis-ground disturbance problem Common mode problem Cable length not compliant with standard
VLevel	Amplitude measurement on the ((Tx+)-Tx-) or ((Rx+)-(Rx-)) signal (signal present on channel 1)	<ul style="list-style-type: none"> Termination problem Junction connection (oxidation, bad contact, etc.) Cable length not compliant with standard Significant noise (check the cable route, ground braid not connected, faulty chassis-ground, etc.) ...
Time Data	Measurement made using the bit time total	<ul style="list-style-type: none"> Unsuitable or damaged cable Termination impedance incorrectly positioned Significant noise (check the cable route, ground braid not connected, faulty chassis-ground, etc.) ...
Time Rise	Rise time between 10% and 90% of the signal amplitude	<ul style="list-style-type: none"> Unsuitable or damaged cable (the rise and fall times increase with the cable impedance) Termination impedance incorrectly positioned ...
Time Fall	Fall time between 90% and 10% of the signal amplitude	
Jitter	Measurement made using the bit time total	<ul style="list-style-type: none"> Significant noise (check the cable route, ground braid not connected, faulty chassis-ground, etc.) ...
Over+	Measurement of the positive overshoot of the signal amplitude	<ul style="list-style-type: none"> Unsuitable cable impedance Termination problem (if there is no termination, major overshoot and the opposite if the bus impedance is too high) Significant noise (check the cable route, ground braid not connected, faulty chassis-ground, etc.) ...
Over-	Measurement of the negative overshoot of the signal amplitude	

12.16 « USB » Bus

12.16.1. Overview

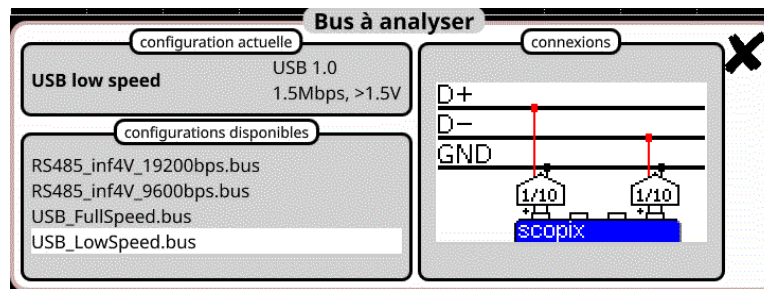

Configuration

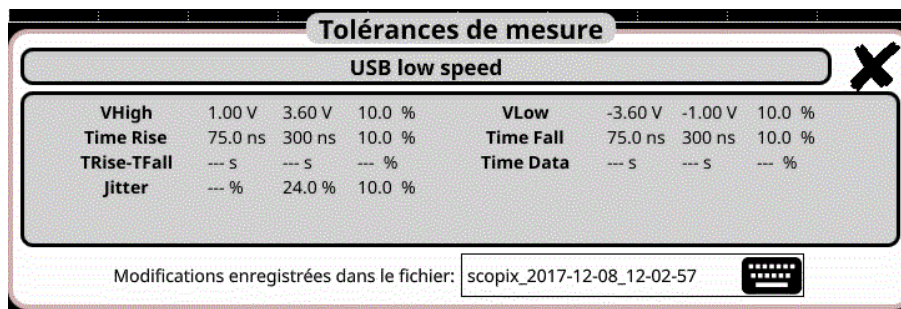

Measurement specification

12.16.2. Getting started

Equipment	<ul style="list-style-type: none"> two HX0130 or HX0030 sensors an HX0191 generic connection card (optional) 																		
Configuration files	<ul style="list-style-type: none"> " USB_Fullspeed.bus " for USB 1.1 bus, 12 Mbps speed, amplitude >1.5V " USB_LowSpeed.bus " for USB 1.0 bus, 1.5 Mbps speed, amplitude >1.5V 																		
Connections	<table border="1"> <thead> <tr> <th>Contact number</th> <th>Signal Name</th> <th>Typical Wiring Assignment</th> </tr> </thead> <tbody> <tr> <td>1</td> <td>VBus</td> <td>Red</td> </tr> <tr> <td>2</td> <td>D-</td> <td>White</td> </tr> <tr> <td>3</td> <td>D+</td> <td>Green</td> </tr> <tr> <td>4</td> <td>GND</td> <td>Black</td> </tr> <tr> <td>Shell</td> <td>Shield</td> <td>Drain Wire</td> </tr> </tbody> </table> 	Contact number	Signal Name	Typical Wiring Assignment	1	VBus	Red	2	D-	White	3	D+	Green	4	GND	Black	Shell	Shield	Drain Wire
Contact number	Signal Name	Typical Wiring Assignment																	
1	VBus	Red																	
2	D-	White																	
3	D+	Green																	
4	GND	Black																	
Shell	Shield	Drain Wire																	

12.16.3. Measurements (USB)

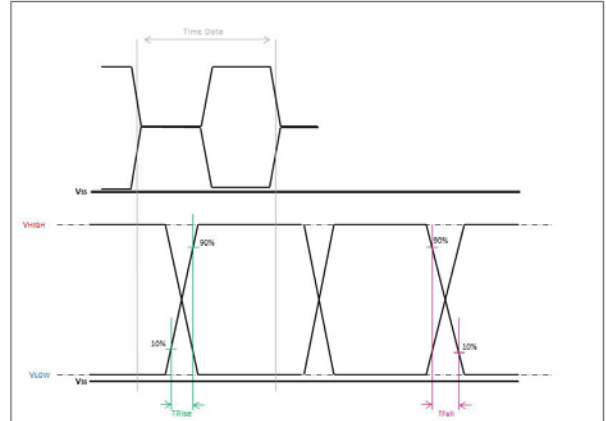
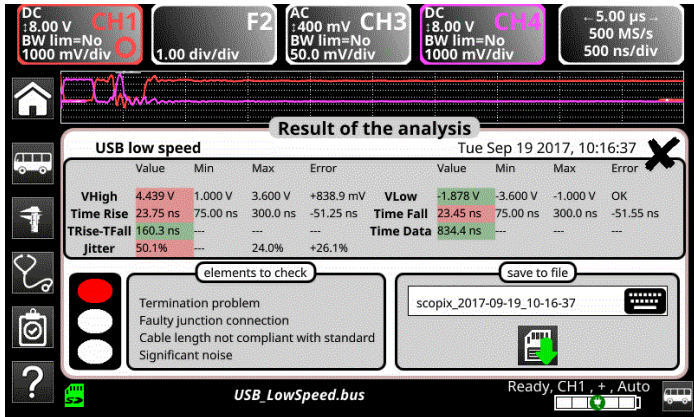

Diagnosis		Use this table to troubleshoot problems on a measurement :
Measurement	Description	Diagnosis
VHIGH	Measurement of the high level	<ul style="list-style-type: none"> Termination problem Junction connection (oxidation, bad contact, etc.) Cable length not compliant with standard Significant noise (check the cable route, ground braid not connected, faulty chassis-ground, etc.) ...
VLOW	Measurement of the low level	
Time Rise	Rise time between 10% and 90% of the signal amplitude	<ul style="list-style-type: none"> Unsuitable or damaged cable Termination impedance incorrectly positioned Significant noise (check the cable route, ground braid not connected, faulty chassis-ground, etc.) ...
Time Fall	Fall time between 90% and 10% of the signal amplitude	
TRise-TFall	Difference between the rise time at 10% 90% and the fall time at 90% 10%	<ul style="list-style-type: none"> Unsuitable or damaged cable (the rise and fall times increase with the cable impedance) Significant noise (check the cable route, ground braid not connected, faulty chassis-ground, etc.) ...
Time Data	Measurement made using the bit time total	
Jitter	Measurement made using the bit time total	<ul style="list-style-type: none"> Significant noise (check the cable route, ground braid not connected, faulty chassis-ground, etc.) ...

metrix®

FRANCE

Chauvin Arnoux Group

190, rue Championnet
75876 PARIS Cedex 18
Tél : +33 1 44 85 44 85
Fax : +33 1 46 27 73 89
info@chauvin-arnoux.com
www.chauvin-arnoux.com

INTERNATIONAL

Chauvin Arnoux Group

Tél : +33 1 44 85 44 38
Fax : +33 1 46 27 95 69

Our international contacts

www.chauvin-arnoux.com/contacts

