

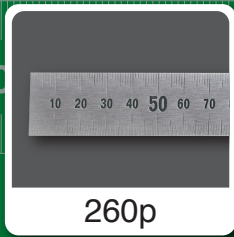

260p

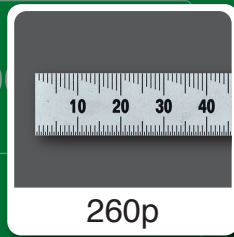

260p



260p



261p



261p

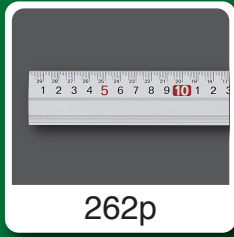

262p

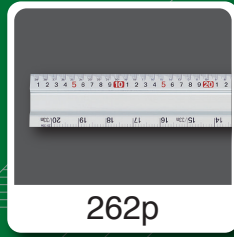

262p

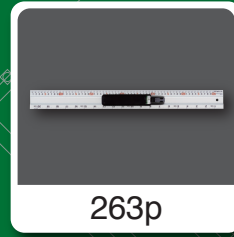

263p

SCALE

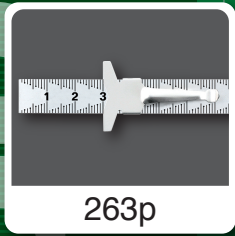

263p

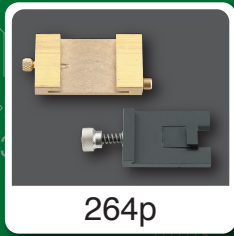

264p

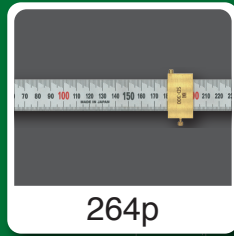

264p

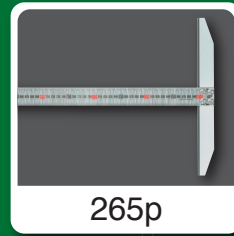

265p

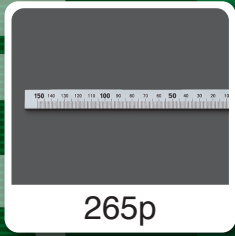

265p



265p



266p

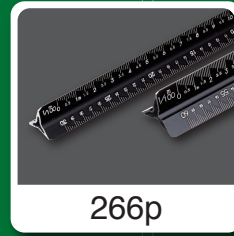

266p



267p



267p



268p



268p

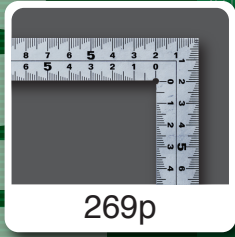

269p



269p



270p

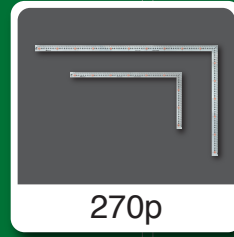

270p

- SCALES
- TRIANGLE SCALES
- TAPE MEASURE
- CARPENTERS SQUARE



METAL SCALE KAIDAN(SATIN/POLISHED)

NEW!



HOW TO MOVE

New stepped millimeter graduations prevents misreading

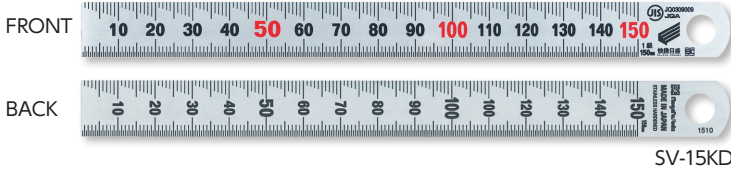

SV-15KD

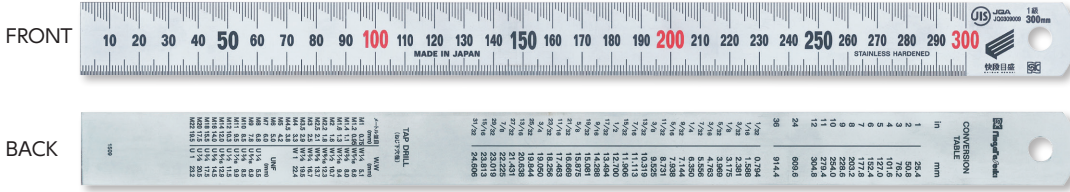

SV-30KD



ST-300KD

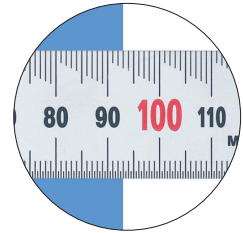
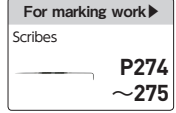
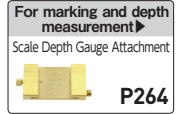

USE

- For measuring dimensions, drawing a straight line and/or scribing

MATERIAL

- Stainless steel (SUS420J2)

FEATURES

- Increasing height of each mark make it easier for eye to distinguish 1mm steps
- Sequential numbers style can be read directly without checking the surrounding numbers
- JIS B7516

Order No.	Model No.	Nominal Size (mm)	Finish	Accuracy (mm)	Length (mm)	Width (mm)	Thickness (mm)	Weight
NEW! 111287	SV-150KD	150	Satin	± 0.15	175	15	0.5	10g
NEW! 111288	SV-300KD	300			335	25	1	65g
NEW! 111289	SV-600KD	600			640	30	1.2	180g
NEW! 111290	SV-1000KD	1000			1050	35	1.5	425g
NEW! 111291	SV-1500KD	1500			1565	40	2	950g
NEW! 111292	SV-2000KD	2000		± 0.30	2065			1250g
NEW! 111281	ST-150KD	150	Polished	± 0.15	175	15	0.5	10g
NEW! 111282	ST-300KD	300			335	25	1	65g
NEW! 111283	ST-600KD	600			640	30	1.2	180g
NEW! 111284	ST-1000KD	1000			1050	35	1.5	425g
NEW! 111285	ST-1500KD	1500			1565	40	2	950g
NEW! 111286	ST-2000KD	2000			2065			1250g

SCALES

TRIANGLE SCALES

TAPE MEASURE

CARPENTERS SQUARE



METAL SCALE KAIDAN NARROW TYPE

NEW!



HOW TO MOVE

New stepped millimeter graduations prevents misreading

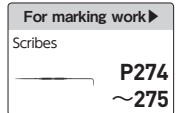

USE

- For measuring dimensions, drawing a straight line and/or scribing

MATERIAL

- Stainless steel (SUS420J2)

FEATURES

- Increasing height of each mark makes it easier for eye to distinguish 1mm steps
- Repeating number style
- Thin, Narrow type, can also be mounted on machine

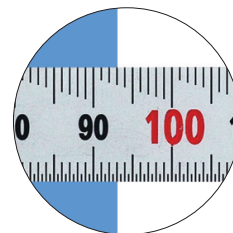

Order No.	Model No.	Nominal Size (mm)	Finish	Accuracy (mm)	Length (mm)	Width (mm)	Thickness (mm)	Weight
NEW! 111295	HS-300KD	300	Satin	± 0.15	325	15	0.5	18g



CATCH UP SCALE KAIDAN/ CATCH UP SCALE KAIDAN FINE

NEW!
CU-60KD, CU-100KD



HOW TO MOVE

Easy to pick up with on hand.
New stepped millimeter graduations prevents misreading.



CU-15KD



CU-30KD

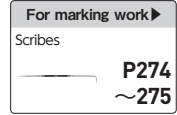
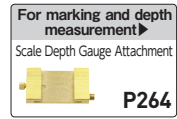

USE

- For measuring dimensions, drawing a straight line and/or scribing

MATERIAL

- Stainless steel (SUS420J2)

FEATURES

- Increasing height of each mark makes it easier for eye to distinguish 1mm steps
- Sequential number style can be read directly without checking the surrounding numbers
- 0.5mm graduations are available (CU-15KDF)
- Bent up edge makes scale easy to pick up with one hand
- Edges are finished smooth to prevent marring surfaces
- JIS B7516
- Satin finish

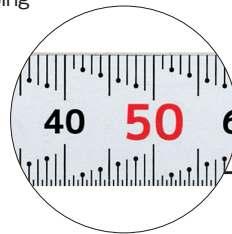

0.5mm graduations are available
CU-15KDF

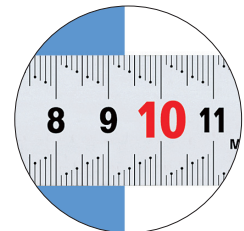

Order No.	Model No.	Nominal Size (cm)	Finish	Accuracy (mm)	Length (mm)	Width (mm)	Thickness (mm)	Weight
111158	CU-15KD	15	Satin	± 0.15	175	15	0.5	10g
111159	CU-30KD	30			335	25	1	65g
NEW! 111293	CU-60KD	60		± 0.20	640	30	1.2	180g
NEW! 111294	CU-100KD	100		± 0.20	1050	35	1.5	425g
111261	CU-15KDF	15		± 0.15	175	15	0.5	10g



HOOK SCALE KAIDAN



HOW TO MOVE

Multi use scale with hook



● DIMENSIONS Units: mm

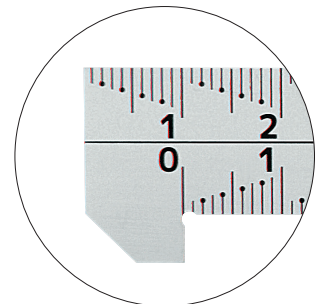
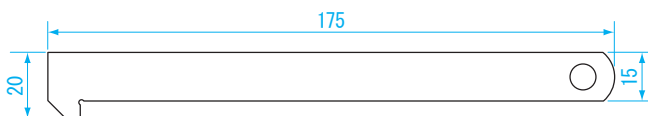

USE

- Dimensional measurement from the end side and simplified measurement of C chamfering

MATERIAL

- Stainless steel (SUS420J2)

FEATURES

- Scale with hook on the end of scale
- Increasing height of each mark makes it easier for eye to distinguish 1mm steps
- Sequential number style can be read directly without checking the surrounding numbers. 2mm point markings.
- Edges are finished smooth to prevent marring surfaces

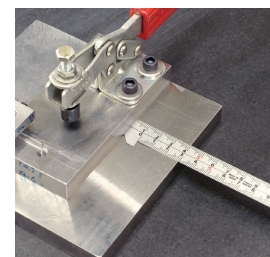

Order No.	Model No.	Nominal Size (cm)	Finish	Accuracy (mm)	Length (mm)	Width (mm)	Thickness (mm)	Weight
111105	FS-15KD	15	Satin	± 0.15	175	20	0.5	10g





ALUMINUM SCALE KAIDAN



HOW TO MOVE

Increasing height of each mark makes it easier for eye to distinguish 1mm steps

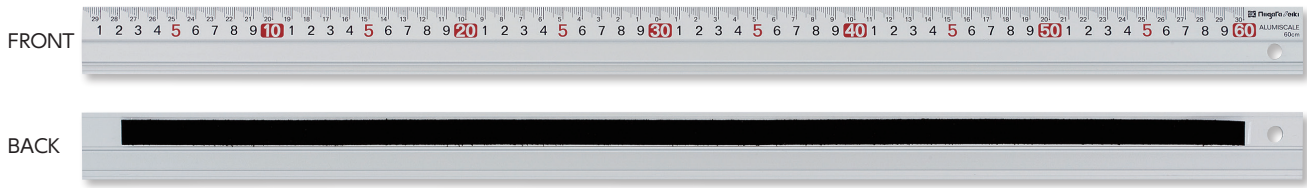

With anti-slip sheet (except AS-15), and grip groove

AS-60

USE

- For measuring distance, cutting and/or scribing

MATERIAL

- Aluminum

FEATURES

- Increasing height of each mark makes it easier for eye to distinguish 1mm steps
- Two color printing (Navy & Red), easy to distinguish the lines and graduations when drawing
- Centered-zero secondary markings on some models (AS-30·AS-60·AS-100)
- With anti-slip sheet (except AS-15), and grip groove



Order No.	Model No.	Nominal Size (cm)	Center-zero secondary marking (Yes/No)	Accuracy (mm)	Length (mm)	Width (mm)	Thickness (mm)	Weight
111165	AS-15	15	None	± 0.16	180	35	5	36g
111166	AS-30	30	Yes	± 0.20	330			65g
111167	AS-45	45	None	± 0.25	480			95g
111168	AS-60	60	Yes	± 0.28	630			124g
111169	AS-100	100		± 0.40	1030			203g



ALUMINUM CUTTING SCALE KAIDAN



HOW TO MOVE

Optimal for cutting with no-slip backing and Stainless plate

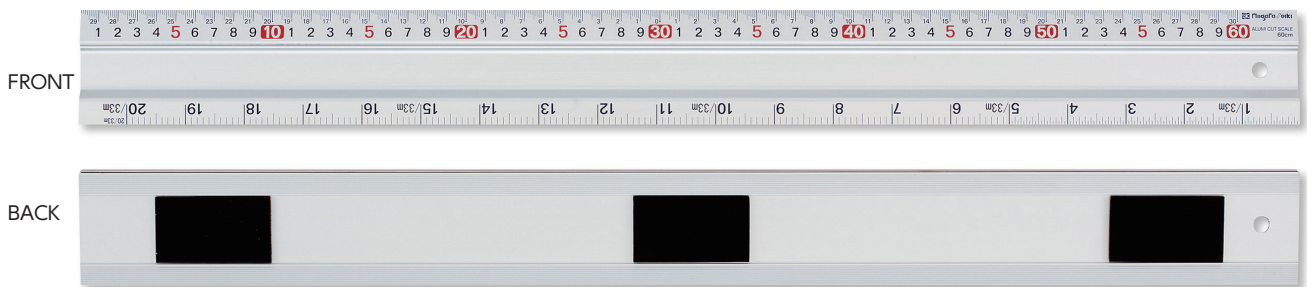

Anti-slip back sheet and Stainless steel back plate

ACS-60



With Stainless steel plate to protect blade when used as cutting guide

USE

- For measuring dimensions, drawing a straight line, cutting and/or scribing

MATERIAL

- Aluminum

FEATURES

- Increasing height of each mark makes it easier for eye to distinguish 1mm steps
- Two color printing (Navy & Red), easy to distinguish the lines and graduations when drawing
- Centered-zero secondary markings
- Anti-slip back sheet and Stainless steel back plate

Order No.	Model No.	Nominal Size (cm)	Center-zero secondary marking (Yes/No)	Accuracy (mm)	Length (mm)	Width (mm)	Thickness (mm)	Weight
006851	ACS-60	60	Yes	± 0.28	630	61	9	330g
006852	ACS-100	100		± 0.40	1030			530g
006853	ACS-150	150		± 0.55	1530			770g
006854	ACS-200	200		± 0.70	2030			1020g

Optimal for cutting with no-slip backing and Stainless plate. Handle to help stabilize work.



Anti-slip back sheet and Stainless steel back plate

ACS-60H

USE

- For measuring dimensions, drawing a straight line, cutting and/or scribing

MATERIAL

- Aluminum

FEATURES

- Increasing height of each mark makes it easier for eye to distinguish 1mm steps
- Handle to help stabilize work while cutting
- Slot in handle for snapping off utility knife blade
- Two color printing (Navy & Red), easy to distinguish the lines and graduations when drawing
- Centered-zero secondary markings
- Anti-slip back sheet and Stainless steel back plate



Handle has slot for blade removal

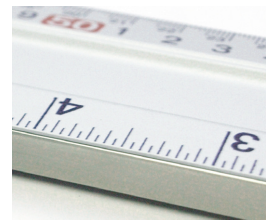

With Stainless steel plate to protect blade when used as cutting guide

Order No.	Model No.	Size (cm)	Center-zero secondary marking (Yes/No)	Accuracy (mm)	Length (mm)	Width (mm)	Thickness (mm)	Weight
006855	ACS-60H	60	Yes	±0.28	630	61	58	500g
006856	ACS-100H	100		±0.40	1030			700g
006857	ACS-150H	150		±0.55	1530			940g
006858	ACS-200H	200		±0.70	2030			1190g

SCALES

TRIANGLE SCALES

TAPE MEASURE

CARPENTERS SQUARE

New stepped millimeter graduations prevents misreading



USE

- For measuring dimensions, drawing and marking work

MATERIAL

- Stainless steel (SUS420J2)

FEATURES

- Increasing height of each mark makes it easier for eye to distinguish 1mm steps
- Sequential number style can be read directly without checking the surrounding numbers. 2mm point markings.
- Can be used as depth gauge by sliding clip along scale
- With clip for easy carrying
- Edges are finished smooth to prevent marring surfaces
- Satin finish

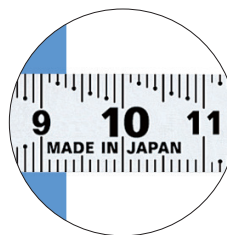

With clip for easy carrying

Order No.	Model No.	Size (cm)	Finish	Length (mm)	Width (mm)	Thickness (mm)	Weight
009903	SVC-15KD	15	Satin	160	12	0.5	8g

SCALE DEPTH GAUGE ATTACHMENT



HOW TO MOVE

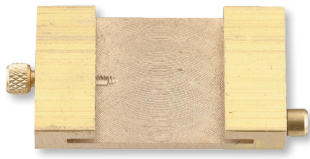

SD-300

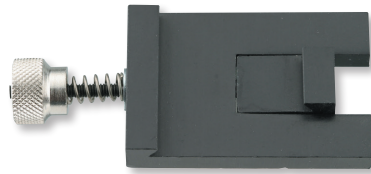

SD-6010

USE

- For accurate marking and measurement for width, height and depth

MATERIAL

- Brass (SD-150·SD-300)
- Aluminum (SD-6010)

FEATURES

- Slide to any position on scale. Screw tightens for setting.
- Convenient size for metal and woodworking use
- Attachable to JIS rules

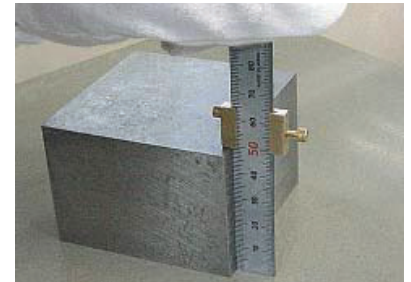
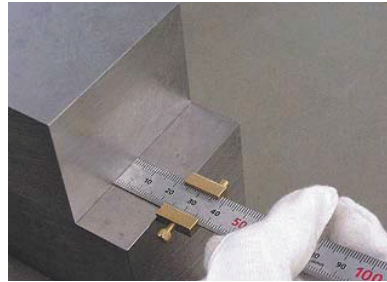

Order No.	Model No.	Type	Length (mm)	Thickness (mm)	Weight
006843	SD-150	150mm Scale	15	5	20g
006844	SD-300	300mm Scale	20	6	90g
006845	SD-6010	600 · 1000mm Scale	30	13	26g

DEPTH SCALE KAIDAN **NEW!**



HOW TO MOVE

Scale with depth gauge attachment. Repeated marking with efficiency.

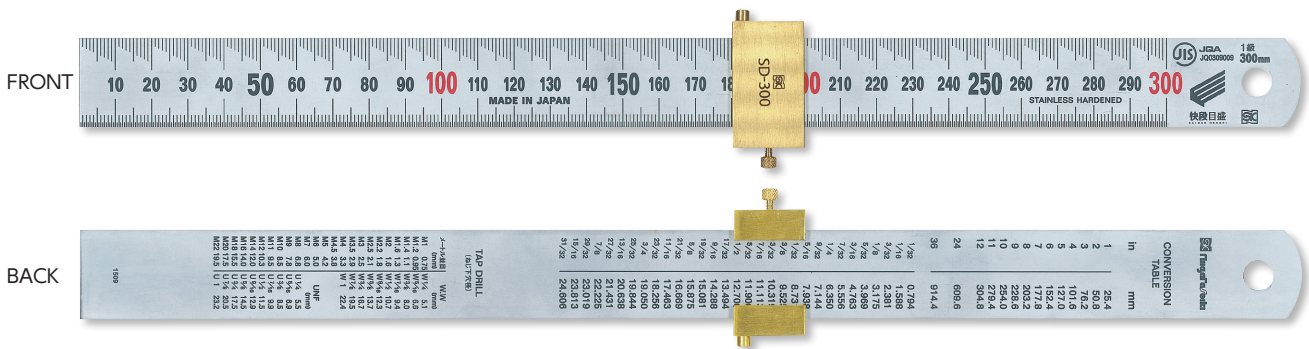

SV-300DKD

USE

- Accurate marking, and measuring of component depth, height, width

MATERIAL

- Scale: Stainless steel (SUS420J2)
- Depth attachment: Brass

FEATURES

- Scale with depth gauge attachment
- Edges are finished smooth to prevent marring surfaces

Order No.	Model No.	Nominal Size (mm)	Length (mm)	Width (mm)	Thickness (mm)	Weight
NEW! 111298	SV-150DKD	150	175	32	5	20g
NEW! 111299	SV-300DKD	300	335	45	6	86g



T-TYPE SCALE KAIDAN **NEW!**

Measurement and marking dimensions relative to and end face



USE

- Measurement and marking dimensions relative to and end face

MATERIAL

- Base: Aluminum
- Scale: Stainless steel (SUS420J2)

FEATURES

- Make measurements or markings relative to an end face

TT-1000KD

Order No.	Model No.	Nominal Size (mm)	Accuracy (mm)	Length (mm)	Base Width (mm)	Thickness (mm)	Weight
NEW! 111300	TT-1000KD	1000mm	± 0.20	1300	300	16	640g
NEW! 111301	TT-2000KD	2000mm	± 0.30	2400			1530g

MACHINE SCALE



Center '0' scale



Standard scale

USE

- Size measurement
- For attaching to fixtures and machines

MATERIAL

- Stainless steel (SUS420J2)

FEATURES

- Satin finish

SPECIFICATIONS

Units: mm

Size	50	100	150	200	300	600	1000	1500	2000
Width	15								
Thickness	0.5								
Width	20								
Thickness	0.5 (1.0) ※Thickness: 0.5 or 1.0								

※ Scales are available with "0" on end, or "0" at center

※ Sample of custom design

MTO production

Custom Designs
for Fast Delivery

Please contact us
with request

Custom size can be provided in addition to the standard size listed



SCALE TAPE

0

Affixable scale to be placed on work table, machinery or anywhere



With adhesive tape on back side



Can be cut



USE

- Stick the scale tape to the work table for measuring lengths

MATERIAL

- SK steel nylon coated

FEATURES

- Friction resistant nylon coating
- With 2mm hole for mounting with fasteners
- Adhesive backing tape ready-to-use

※ Include adhesive backing tape

Order No.	Model No.	Maximum Measurement Length (m)	Tape Width (mm)	Tape Thickness ※ (mm)	Weight
111195	PM-1320KD	2.0	13	0.3	32g



TRIANGLE SCALE K Aidan (ARCHITECTURE USE)



New stepped millimeter graduations prevents misreading



TSB-30KD

TSB-15KD



1/50 · 1/200m



1/100 · 1/200m



1/300 · 1/250m

USE

- Drafting, for reading scaled drawing

MATERIAL

- ABS

FEATURES

- Increasing height of each mark makes it easier for eye to read
- All number reading type
- Laser marked graduation

SCALE SPECIFICATIONS

- Scale: 1/20·1/50, 1/100·1/200, 1/250·1/300

Order No.	Model No.	Length (mm)	Width (mm)	Thickness (mm)	Weight
111148	TSB-15KD	170	15	14	11g
111149	TSB-30KD	325	25	22	54g



ALUMINUM TRIANGLE SCALE K Aidan (ARCHITECTURE USE)

New stepped millimeter graduations prevents misreading



TSBA-15KD

TSBA-30KD

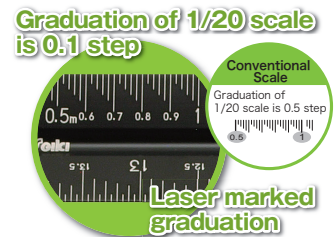

1/20 · 1/50m



1/100 · 1/200m



1/250 · 1/300m

USE

- Drafting, for reading scaled drawing

MATERIAL

- Aluminum

FEATURES

- Increasing height of each mark makes it easier for eye to read
- All number reading type
- Laser marked graduation

SCALE SPECIFICATIONS

- Scale: 1/20·1/50, 1/100·1/200, 1/250·1/300

Order No.	Model No.	Length (mm)	Width (mm)	Thickness (mm)	Weight
111250	TSBA-15KD	170	15	14	18g
111251	TSBA-30KD	325	25	22	60g



ALUMINUM TRIANGLE SCALE K Aidan (GENERAL USE)

New stepped millimeter graduations prevents misreading

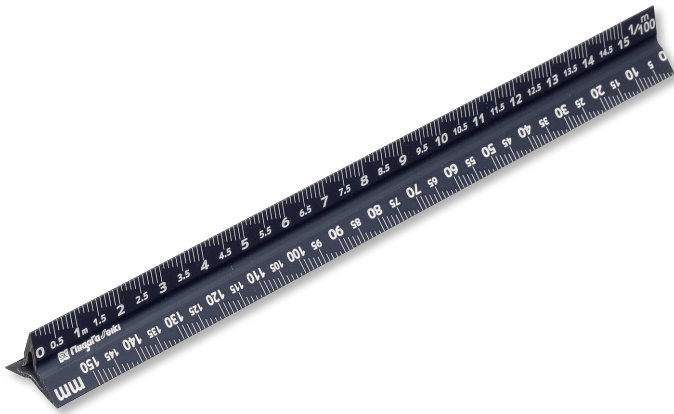

Enlarged view



1/1 • 1/100m



1/150 • 1/200m



1/250 • 1/300m

USE

- Drafting, for reading scaled drawing

MATERIAL

- Aluminum

FEATURES

- Increasing height of each mark makes it easier for eye to read
- All number reading type
- Laser marked graduation

SCALE SPECIFICATIONS

- Scale: 1/1 • 1/100, 1/150 • 1/200, 1/250 • 1/300

Order No.	Model No.	Length (mm)	Width (mm)	Thickness (mm)	Weight
111254	TSGA-15KD	160	15	14	18g



ALUMINUM TRIANGLE SCALE K Aidan (REAL-ESTATE SURVEYORS USE)

New stepped millimeter graduations prevents misreading

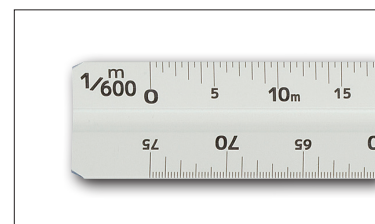
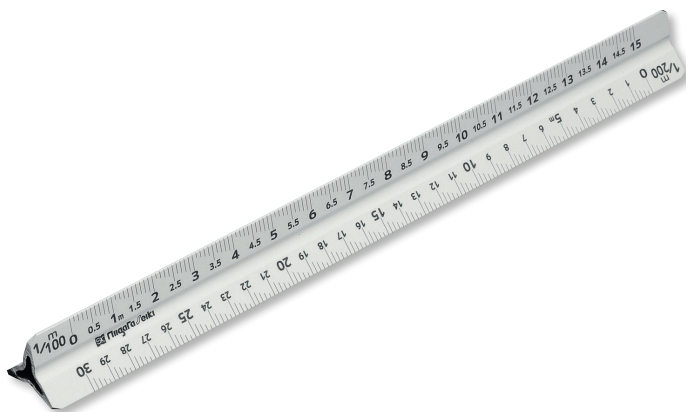

Enlarged view (scale: 1/500 • 1/600m)



1/100 • 1/200m

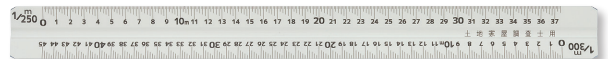

1/250 • 1/300m

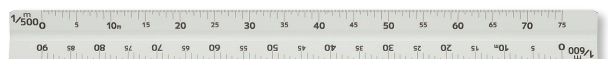

1/500 • 1/600m

USE

- Drafting, for reading scaled drawing

MATERIAL

- Aluminum

FEATURES

- Increasing height of each mark makes it easier for eye to read
- All number reading type
- Laser marked graduation

SCALE SPECIFICATIONS

- Scale: 1/100 • 1/200, 1/250 • 1/300, 1/500 • 1/600

Order No.	Model No.	Length (mm)	Width (mm)	Thickness (mm)	Weight
111255	TSIA-15KD	170	15	14	18g

SCALES

TRIANGLE
SCALES

TAPE
MEASURE

CARPENTERS
SQUARE



TAPE MEASURE (AUTO LOCK PRO K Aidan)

0

New stepped millimeter graduations prevents misreading



ALCP-2555KD



With belt clip and strap for easy carrying

USE

- Measure dimensions

MATERIAL

- Body: ABS, Rubber
- Tape: SK4 tool steel (Nylon coated)

FEATURES

- Increasing height of each mark makes it easier for eye to distinguish 1mm steps
- Repeating digit type for large, easy to read numbers
- Auto-lock engages when tape is pulled to prevent retraction
- Water resistant Nylon-coated tape
- Tape standard: JIS class 1
- Non-slip rubber grip



Increasing height of each mark makes it easier for eye to distinguish 1mm steps

Order No.	Model No.	Max measuring length (m)	Tape width (mm)	Weight
111196	ALCP-1620KD	2.0	16	110g
111197	ALCP-1635KD	3.5	16	140g
111198	ALCP-1955KD	5.5	19	270g
111199	ALCP-2555KD		25	340g



TAPER MEASURE (K Aidan LOCK GUARD) **NEW!**

0

Strong rigidity tape resists to folding and deflection



LCG-1950KD

LCG-2550KD



With belt clip and strap for easy carrying

USE

- Measure dimensions

MATERIAL

- Body: ABS, Rubber
- Tape: SK4 tool steel (Nylon coated)

FEATURES

- Strong rigidity tape resists to folding and deflection
- Repeating digit type for large, easy to read numbers
- Three color printing (black, red and blue), easy to distinguish the graduations
- Water resistant Nylon-coated tape
- Tape standard: JIS class 1
- Non-slip rubber grip



FRONT



BACK

- Three color printing (black, red and blue), easy to distinguish the graduations
- Back side is vertical scale

Order No.	Model No.	Max measuring length (m)	Tape Width (mm)	Weight
NEW! 111256	LCG-1950KD		19	270g
NEW! 111257	LCG-2550KD	5.0	25	320g

New stepped millimeter graduations prevents misreading

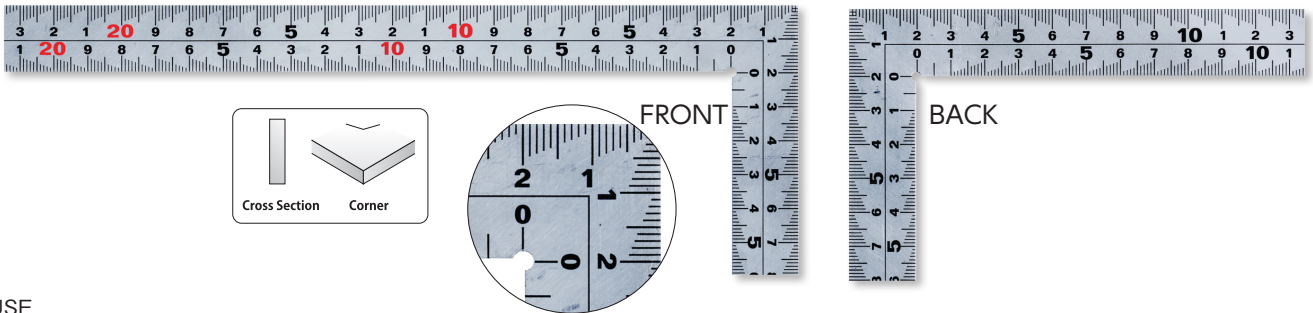

USE

- Measure dimensions and marking for stone or metal work

MATERIAL

- Stainless steel

FEATURES

- Increasing height of each mark makes it easier for eye to distinguish 1mm steps
- Repeating digit type for large, easy to read numbers
- Wide, scale type for inner and outer measurements (MT-30KD·MT-50KD)
- Thin type square fits the object (TH-30KD·TH50KD)

Order No.	Model No.	Size	Type	Graduations	Blade Length (mm)	Tongue Length (mm)	Width (mm)	Thickness (mm)	Weight
111190	MT-30KD	30cm	Wide	Four edges, both sides	320	160	20	2.0	145g
111191	MT-50KD	50cm			520	260			235g
NEW! 111303	TH-30KD	30cm	Wide, thin		320	160		1.0	75g
NEW! 111302	TH-50KD	50cm			520	260			120g

MANHOLE DEPTH MEASURING ADAPTER

Measure the step between manhole and road surface when attached to steel square

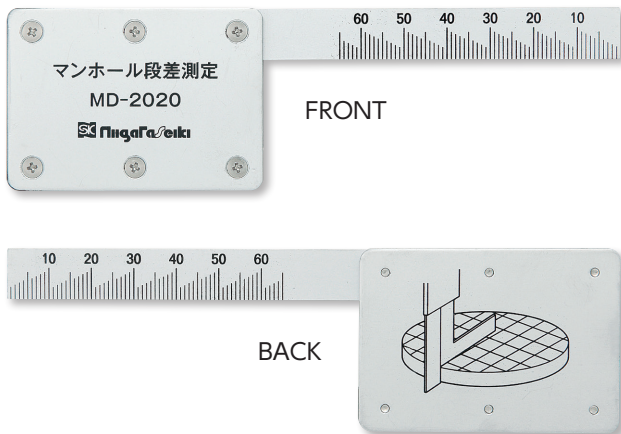

Mount on steel square

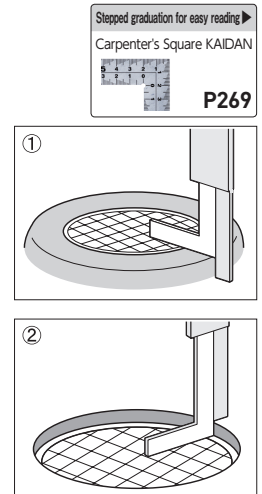

Step measurement between manhole and road surface

DIMENSIONS

Units: mm

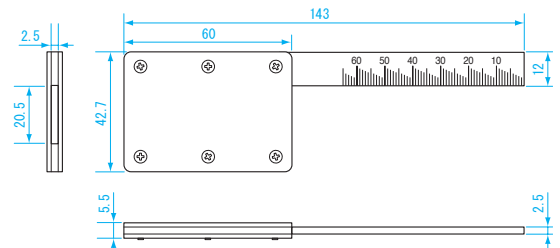

USE

- For measuring gaps between manhole and road surface
- Applicable steel square: MT-30KD, MT-50KD

MATERIAL

- Stainless steel

FEATURES

- Measuring range: ①65mm ②Horizontal length: 143mm

Order No.	Model No.	Accuracy (mm)	Applicable square size (mm)	Weight
006991	MD-2020	± 0.2	Width 20 × Thickness 2.0	100g



CARPENTER'S SQUARE K Aidan - SINGLE MARKING



New stepped millimeter graduations prevents misreading

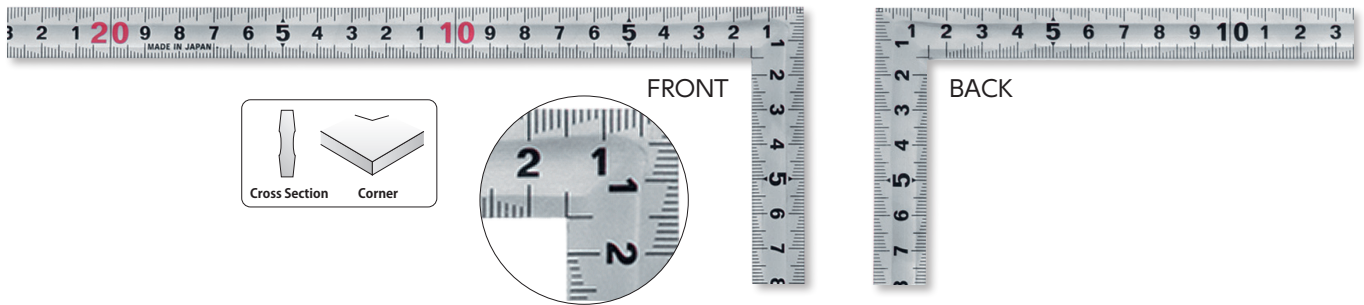

USE

- Measure dimensions and marking for stone or metal work

MATERIAL

- Stainless (SUS420J1)

FEATURES

- Increasing height of each mark makes it easier for eye to distinguish 1mm steps
- Repeating digit type for large, easy to read numbers
- Same graduations on both edges for easy marking



Reverse side scale can measure depth

Order No.	Model No.	Size	Type	Graduations	Length (mm)	Length (mm)	Width (mm)	Thickness (mm)	Weight
111188	SDD-30CKD	30cm	Constant thickness	Four edges, both sides	320	160	15	1.3	50g
111189	SDD-50CKD	50cm			520	260			90g



MEDIUM / LARGE CARPENTER'S SQUARE K Aidan **NEW!**



Sheet metal workshop essential. Measure dimensions, check right angles, and marking work.

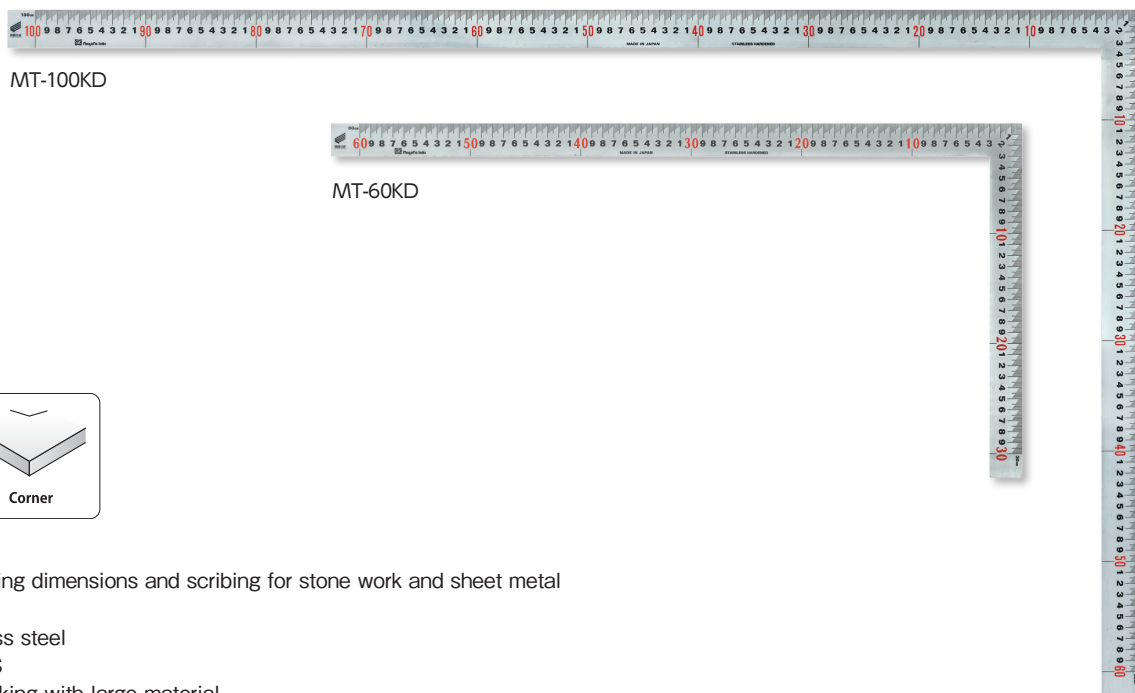

USE

- Measuring dimensions and scribing for stone work and sheet metal

MATERIAL

- Stainless steel

FEATURES

- For working with large material

Order No.	Model No.	Size	Type	Graduations	Blade Length (mm)	Tongue Length (mm)	Width (mm)	Thickness (mm)	Weight
NEW! 111296	MT-60KD	60cm	Medium	Two edges, both side	631	325	30	2.0	420g
NEW! 111297	MT-100KD	100cm	Large		1026	629	35	2.5	1080g