

01. VACUUM OVEN



Vacuum Drying Oven	8
450°C Vacuum Drying Oven	11
Precision Temp Control Vacuum Drying Oven	13
Precision Temp Control Vacuum Drying Oven Package	14
Cold Trap Bath	15
Vacuum Oven Package	17
Vacuum Pump	19
Options	25

VACUUM OVEN

We offer

- Vacuum Drying Oven
- 450°C Vacuum Drying Oven
- Precision Temp Control Vacuum Drying Oven
- Precision Temp Control Vacuum Drying Oven Package
- Vacuum Drying Oven Package
- Vacuum Product Accessories

Selection guide

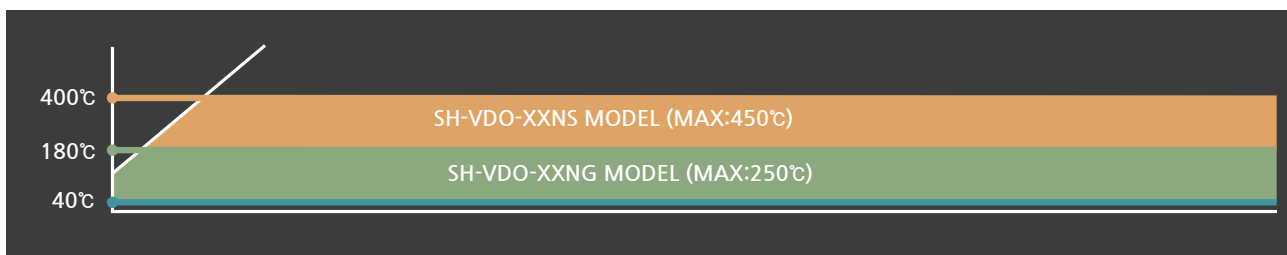

Ambient temperature is below 25°C, relative humidity is lower than 80%

Shelves' detail

Catalog No.	Dimensions(WxDxH)	Weight	Material	Applicable Model
VDPS08G	185x183x3mm 7.28x7.20x0.12"	0.3 Kg	Aluminum	SH-VDO-08NG
VDPS30G	285x283x3mm 11.22x11.14x0.12"	0.7 Kg		SH-VDO-30NG
VDPS70G	385x383x3mm 15.16x15.08x0.12"	1.3 Kg		SH-VDO-70NG
VDPS125G	485x483x3mm 19.09x19.02x0.12"	2 Kg		SH-VDO-125NG
VDPS216G	585x583x3mm 23.03x22.95"	2.5 Kg		SH-VDO-216NG
VDPS30S	286x267x13mm 11.25x10.51x0.51"	3.0 kg	Stainless Steel	SH-VDO-30NS
VDPS70S	386x367x13mm 15.19x14.44x0.51"	5.6 kg		SH-VDO-70NS
VDPS125S	486x467x13mm 19.13x18.38x0.51"	9.0 kg		SH-VDO-125NS
VDPS175G	486x667x11mm 19.13x26.25x0.43"	2.8 kg	Aluminum	SH-VDO-175NG
VDPS252G	586x667x11mm 23.07x26.25x0.43"	3.4 kg		SH-VDO-252NG

Vacuum Drying Oven -Feature

A Vacuum Drying Oven is used for drying at low temperatures by lowering the pressure. In addition, this unit dries samples without causing residues, scaling, or oxidation. Thus, this equipment widely used in laboratories and other related industries.

Uniformity sheet

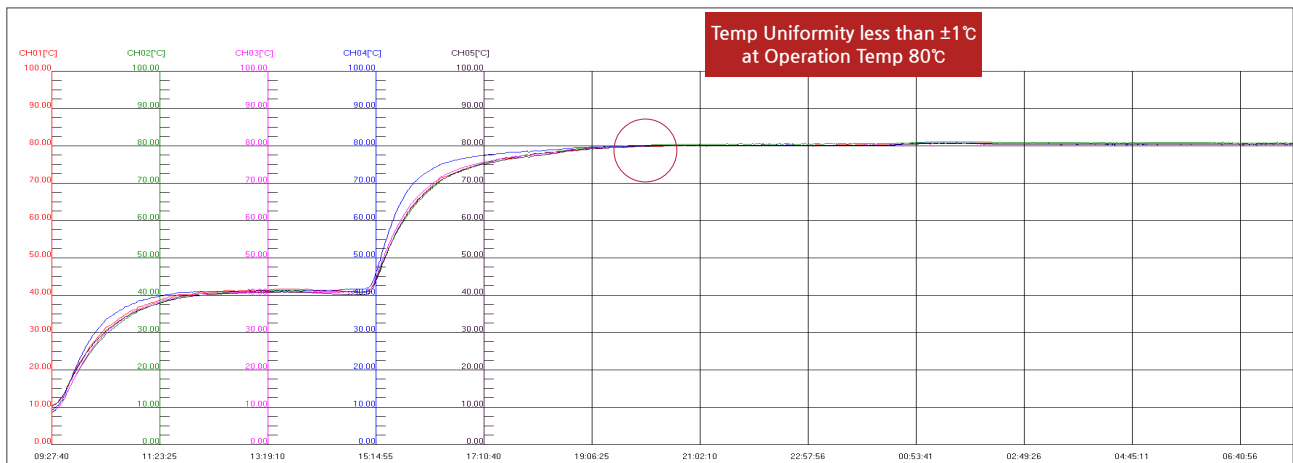

Feature

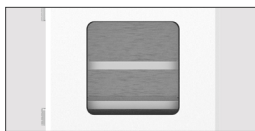

View window with spring mounted shatter proof safety glass panel

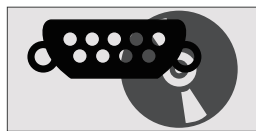

RS-485 or RS-232C interface



Digital PID controller

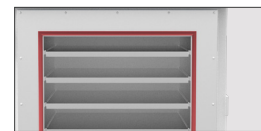

Stainless steel & Door sealing gasket



Steel plate with powder heating coated

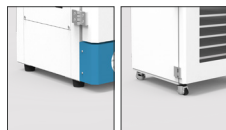

Leveling feet / caster



Safety devices

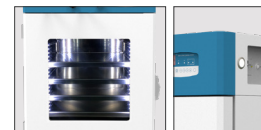

LED Lamp & Switch

Water vapor pressure

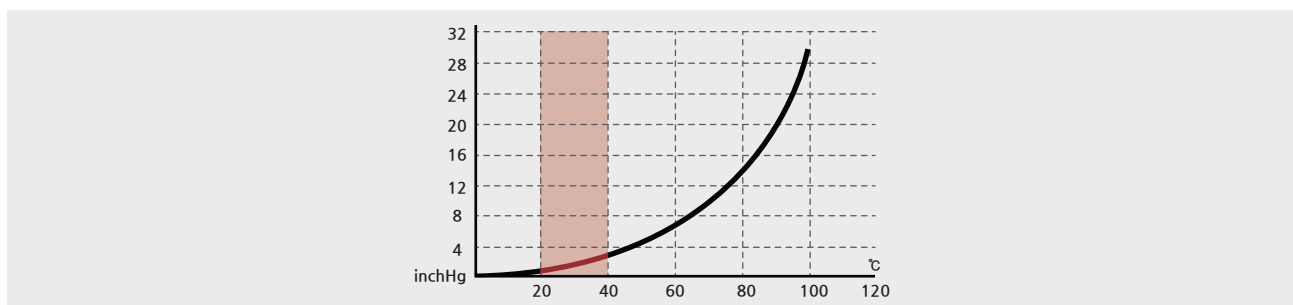

Vacuum Drying Oven



*LED Lamp

Model	SH-VDO-08NG	SH-VDO-30NG	SH-VDO-70NG
Temp Range	Ambient +5°C to 250°C (Ambient + 9°F to 482°F)		
Time Range	00.00 to 99HR 59MIN (MIN SEC) Selectable Digital Counter Timer		
Vacuum Resistance	0 to 76 cmHg (0 to 0.1MPa)		
Heating Type	Hot Air Jacketed		
Temp & Time controller	Microprocess PID Membrane Touch Digital controller		
LED Lamp	N/A	DC 24V, 1.2W, LED bar, Waterproof, Cool White	
Heater Capa	800 W	990 W	1350 W
Dimension Internal (WxDxH)	200x200x200mm	300x300x300mm	400x400x400mm
	7.87x7.87x7.87"	11.81x11.81x11.81"	15.75x15.75x15.75"
Dimension External (WxDxH)	385x315x555mm	605x550x770mm	705x620x870mm
	15.15x12.40x21.85"	23.81x21.65x30.31"	27.75x24.80x34.25"
Weight	29 Kg	69 Kg	100 Kg
Capa	8 L	27 L	64 L
Material Internal	Stainless Steel		
Material External	Steel Plate With Powder Heating Coated		
Material Packing	Silicon Rubber Packing		
View Window	Tempered Glass		
Aluminum Shelves	2 Supplied (2 Maximum)	2 Supplied (4 Maximum)	3 Supplied (5 Maximum)
Electrical Requirements 120V, 50/60Hz, 1Φ	6.6 A	8.3 A	11.3 A
Cat. No.	VDO08NG120	VDO30NG120	VDO70NG120
Electrical Requirements 230V, 50/60Hz, 1Φ	3.5 A	4.3 A	6 A
Cat. No.	VDO08NG230	VDO30NG230	VDO70NG230

• **Option**

- Programmable Controller (30NG, 70NG)
- RS-485 interface (30NG, 70NG)
- RS-232C interface (30NG, 70NG)

• **Safety Device**

- Over temp controller
- Automatic reset function incoming power cut
- Buzzer on when set Time arrived
- Electric leakage circuit breaker

Vacuum Drying Oven



*LED Lamp



Model	SH-VDO-125NG	SH-VDO-216NG
Temp Range	Ambient +5°C to 250°C (Ambient + 9°F to 482°F)	
Time Range	00.00 to 99HR 59MIN (MIN SEC) Selectable Digital Counter Timer	
Vacuum Resistance	0 to 76 cmHg (0 to 0.1MPa)	
Heating Type	Hot Air Jacketed	
Temp & Time controller	Microprocess PID Membrane Touch Digital controller	
LED Lamp	DC 24V, 1.2W, LED bar, Waterproof, Cool White	
Heater Capa	3000 W	4500 W
Dimension Internal (W×D×H)	500×500×500mm	600×600×600mm
	19.69×19.69×19.69"	23.62×23.62×23.62"
Dimension External (W×D×H)	815×765×1050mm	915×880×1150mm
	32.08×30.11×41.33"	36.02×34.64×45.27"
Weight	200 Kg	281 Kg
Capa	125 L	216 L
Material Internal	Stainless Steel	
Material External	Steel Plate With Powder Heating Coated	
Material Packing	Silicon Rubber Packing	
View Window	Tempered Glass	
Aluminum Shelves	4 Supplied (6 Maximum)	5 Supplied (7 Maximum)
Electrical Requirements 120V, 50/60Hz, 1Φ	25.0 A	37.5 A
Cat. No.	VDO125NG120	VDO216NG120
Electrical Requirements 230V, 50/60Hz, 1Φ	13.0 A	19.6 A
Cat. No.	VDO125NG230	VDO216NG230

. Option

- Programmable Controller
- RS-485 interface
- RS-232C interface

. Safety Device

- Over temp controller
- Automatic reset function incoming power cut
- Buzzer on when set Time arrived
- Electric leakage circuit breaker

450°C Vacuum Drying Oven -Feature

Nowadays, the usage of high temperatures in testing and other industries is increasing. Thus, we produce this version of the Vacuum Drying Oven. This unit is suitable for samples that need to operate on a temperature as high as 450°C. This unit can also be used in case of drying samples without causing residues, scaling or oxidation.

Feature

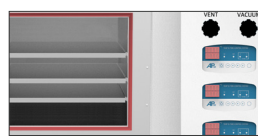

Each shelves heating control function

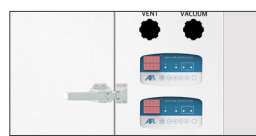

Digital PID controller



Stainless steel

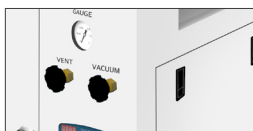

Steel plate with powder heating coated



Leveling caster

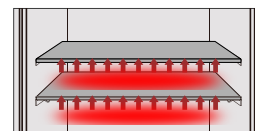

Individual direct heating shelves



Door sealing gasket

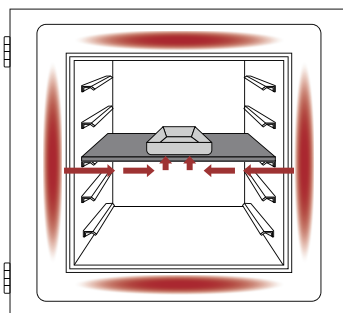

<General Type>

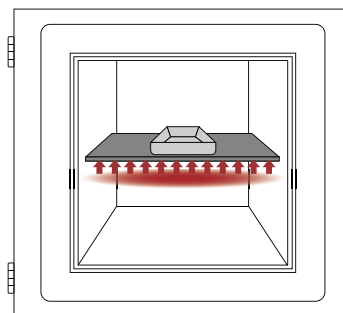

<New Technology Type>

Water vapor pressure

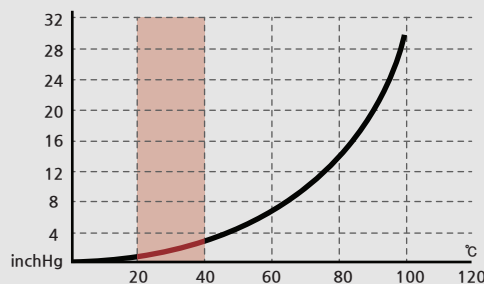

450°C Vacuum Drying Oven



Model	SH-VDO-30NS	SH-VDO-70NS	SH-VDO-125NS
Temp Range	Ambient +5°C to 450°C (Ambient + 9°F to 842°F)		
Time Range	00.00 to 99HR 59MIN (MIN SEC) Selectable Digital Counter Timer		
Heating Type	Shelf Individual Direct Heating		
Vacuum Resistance	0 to 76 cmHg (0 to 0.1MPa)		
Temp & Time controller	Microprocess PID Membrane Touch Digital controller		
Controller	2 EA	3 EA	4 EA
Heater Capa	1.6 KW	3.0 KW	5.0 KW
Dimension Internal (W×D×H)	300×300×300mm	400×400×400 mm	500×500×500mm
	11.81x11.81x11.81"	15.75x15.75x15.75"	19.68x19.68x19.68"
Dimension External (W×D×H)	800×580×565mm	900×680×665mm	1000×790×805mm
	31.49x22.83x22.24"	35.43x26.77x26.18"	39.37x31.10x31.69"
Weight	87 Kg	105 Kg	230 Kg
Material Internal	Stainless Steel		
Material External	Steel Plate With Powder Heating Coated		
Material Packing	Silicon Rubber Packing		
View Window	None		
Heating Shelves	2 Supplied	3 Supplied	4 Supplied
Electrical Requirements 120V, 50/60Hz, 1φ	13.3 A	25.0 A	N/A
Cat. No.	VDO30NS120	VDO70NS120	N/A
Electrical Requirements 230V, 50/60Hz, 1φ	7.0 A	13.0 A	21.7 A
Cat. No.	VDO30NS230	VDO70NS230	VDO125NS230

. Option

-One to multi programmable controller

. Safety Device

- Over temp controller
- Automatic reset function incoming power cut
- Buzzer on when set Time arrived
- Electric leakage circuit breaker

Precision Temp Control Vacuum Drying Oven



Specialized in food industry



*Stackable type

Model	SH-VDO-175NG	SH-VDO-252NG
Temp Range	Ambient +5°C to 150°C (Ambient + 9°F to 302°F)	
Temp Uniformity	±0.5°C at 38°C(100°F)	
Heating Type	Shelf Individual Direct Heating	
Vacuum Resistance	0 to 76 cmHg (0 to 0.1MPa)	
Temp Controller	Microprocess PID Digital controller	
Controller	4 EA	5 EA
LED Lamp	DC 24V, 1.2W, LED bar, Waterproof, Cool White	
Heater Capa	0.3 KW x 4EA=1.2KW	0.3 KW x 5EA=1.5 KW
Dimension Internal (WxDxH)	500x700x500mm	600x700x600 mm
	19.7x27.6x19.7"	23.6x27.6x23.6"
Dimension External (WxDxH)	865x955x715mm	965x953x825mm
	34.05x37.60x28.15"	38x37.52x32.5"
Weight	160 Kg	250 Kg
Material Internal	Stainless Steel	
Material External	Steel Plate With Powder Heating Coated	
Material Packing	Silicon Rubber Packing	
View Window	Yes (with LED light)	
Heating Shelves	4 Supplied	5 Supplied
Electrical Requirements 120V ,50/60Hz, 1φ	10 A	12.5 A
Cat. No.	VDO175NG120	VDO252NG120
Electrical Requirements 230V,50/60Hz, 1φ	5.2 A	6.5 A
Cat. No.	VDO175NG230	VDO252NG230

• Safety Device

- Electricity leakage circuit breaker
- Over temp. controller

Precision Temp Control Vacuum Drying Oven Package



<VDO-PK-175G>



<VDO-PK-252G>

Package Model	VDO-PK-175G	VDO-PK-252G
Vacuum Dry Oven	SH-VDO-175NG	SH-VDO-252NG
Chiller	SH-WB-12CDR	
Vacuum Pump	MP 901 Z	MP 1801 Z
Dimension(WxDxH)	1315x955x1610mm	1415x953x1720mm
	51.77x37.60x63.38	55.70x37.52x67.71"

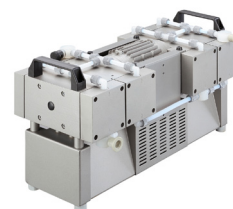

Model	Bath Capacity
SH-WB-12CDR	12.5 L
Temp Range	Ambient -60°C to Ambient (Low limit -40°C) Ambient -28°F to Ambient

Model	Pump Speed
MP 901 Z	125 L/min
Ultimate Pressure	< 8 torr

Model	Pump Speed
MP 1801 Z	221.7 L/min
Ultimate Pressure	< 8 torr

Cold Trap Bath -Feature

In vacuum applications, a cold trap is a device that condenses all vapors(except the permanent gases) into a liquid or solid. The main purpose is to prevent vapors being produced by an experiment from entering the vacuum pump where they would condense and contaminate it. Cold traps can also cool surfaces or baffles to prevent oil vapors flowing from a pump into a chamber. In such a case, a baffle or section of pipe containing a number of cooled vanes, will be attached to the inlet of an existing pumping system.

Uniformity sheet

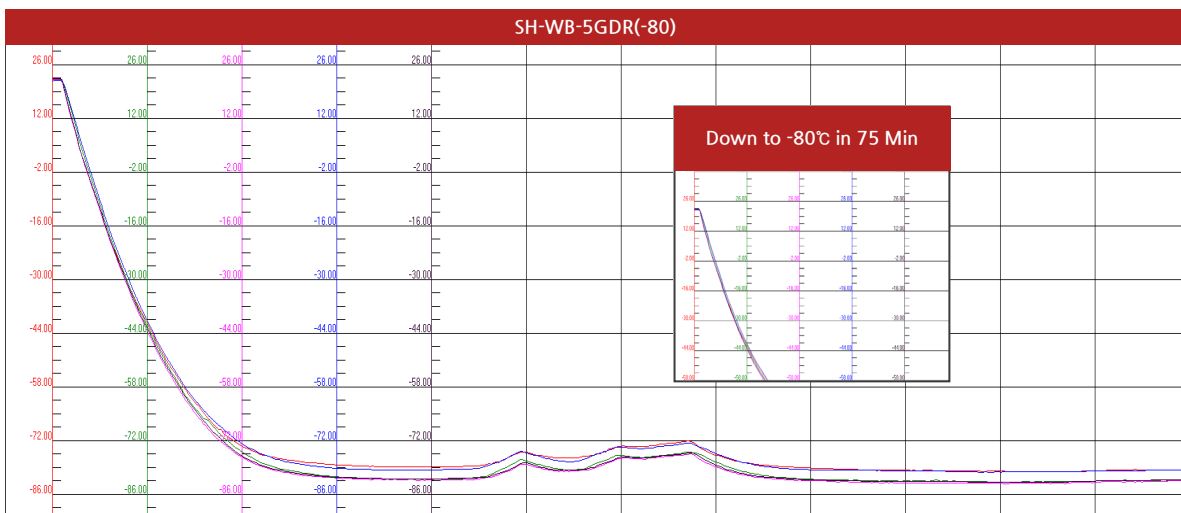
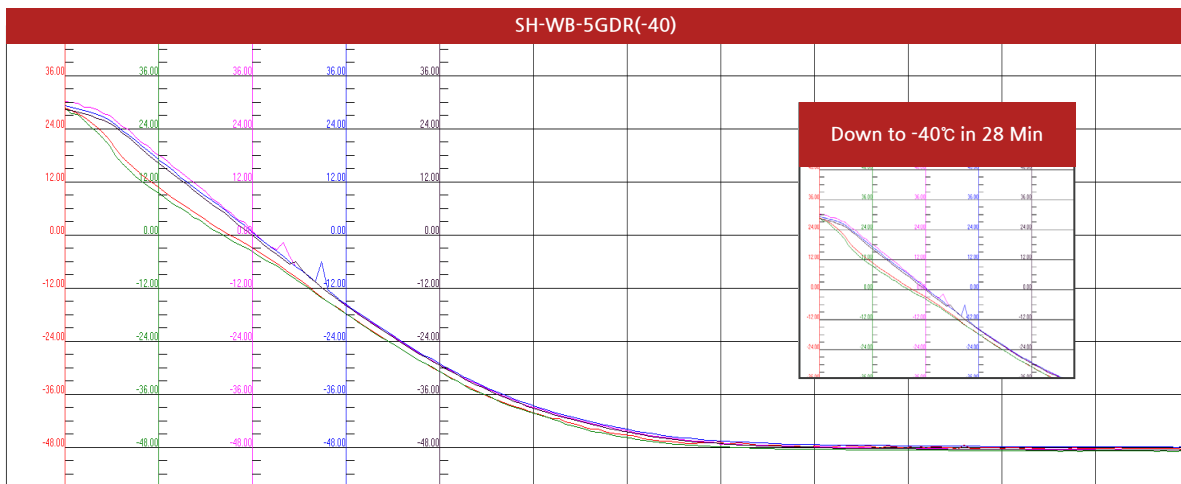

Feature



- Digital controller



- Openable 3 glass trap



- Rust-free stainless coil

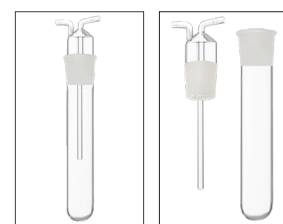

- Openable glass trap

Cold Trap Bath

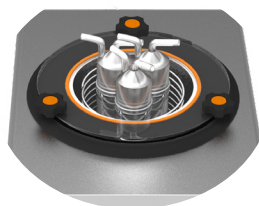

Model	SH-WB-5GDR	
Order Number	SH-WB-5GDR(-40)	SH-WB-5GDR(-80)
Temp Controller	Microprocessor digital controller	
Temp Control Range	Ambient -60°C ~ -20°C (-108°F ~ -40°F) (Low limit -40°C)	Ambient -100°C ~ -60°C (-180°F ~ -76°F) (Low limit -80°C)
Dimension Internal (Φ×H)	180Φ×210Hmm	180Φ×210Hmm
	7.09Φ×8.27H"	7.09Φ×8.27H"
Dimension External (W×D×H)	465×560×710mm	505×620×750mm
	18.18×22.04×27.95"	19.88×24.41×29.52"
Weight	48 Kg	75 Kg
Material Internal	Stainless Steel	
Material External	Steel Plate With Powder Heating Coated	
Trap	Openable glass trap×3EA	
Power	120V, 60Hz, 1Φ	120V, 60Hz, 1Φ
Cat. No.	WB5GDN-40120-60	WB5GDN-80120-60
Power	230V, 60Hz, 1Φ	230V, 60Hz, 1Φ
Cat. No.	WB5GDN-40230-60	WB5GDN-80230-60

• Safety Device

- Automatic reset function incoming power cut
- Electric leakage circuit breaker

Vacuum Oven Package



<VDO-PK-G Series>

Package Model	VDO-PK-G1	VDO-PK-G2	VDO-PK-G3	VDO-PK-G4
Vacuum Dry Oven	SH-VDO-30NG	SH-VDO-70NG	SH-VDO-125NG	SH-VDO-216NG
Cold Trap	SH-WB-5GDR(-40)	SH-WB-5GDR(-40)	SH-WB-5GDR(-40)	SH-WB-5GDR(-40)
Vacuum Pump	V10	V10	V20	V20
Dimension(WxDxH)	1195x685x1560mm	1295x735x1660mm	1355x855x1765mm	1455x955x1865mm
	47.04x26.96x61.41"	50.98x28.93x65.35"	53.34x33.66x69.49"	57.28x37.59x73.42"



<VDO-PK-S Series>

Package Model	VDO-PK-S1	VDO-PK-S2	VDO-PK-S3
Vacuum Dry Oven	SH-VDO-30NS	SH-VDO-70NS	SH-VDO-125NS
Cold Trap	SH-WB-5GDR(-40)	SH-WB-5GDR(-40)	SH-WB-5GDR(-40)
Vacuum Pump	V10	V10	V20
Dimension(WxDxH)	1380x685x1280mm	1465x765x1450mm	1565x895x1535mm
	54.331x26.97x30.39"	57.68x30.11x57.09"	61.61x35.24x60.43"

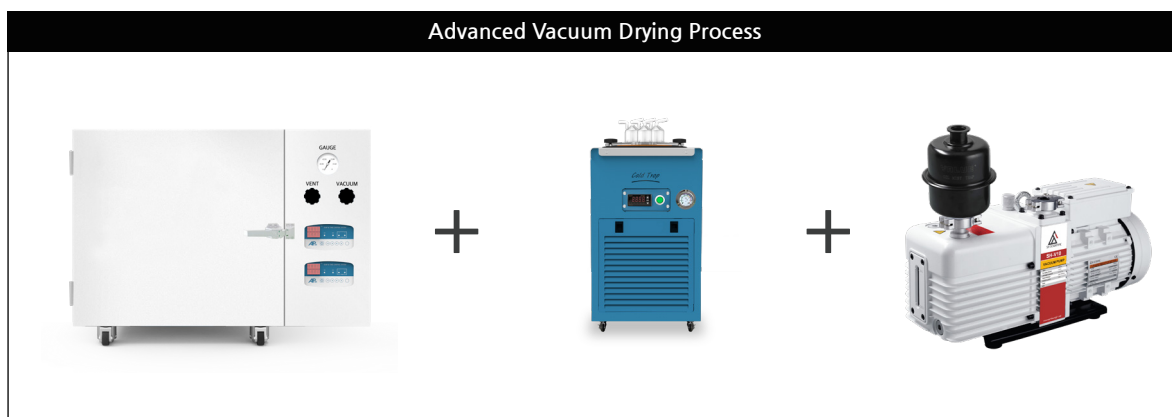
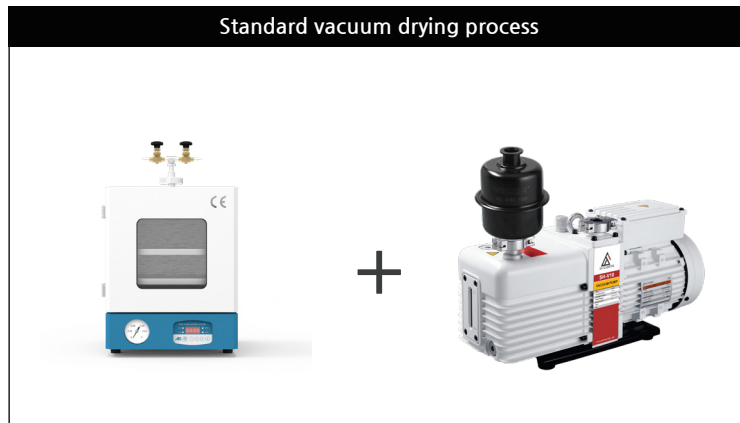

-40°C
For
Water

-80°C
For
Solvent

Model	Bath Capacity
SH-WB-7CDR	7 L
SH-WB-13CDR	13 L
SH-WB-22CDR	22 L
SH-WB-48CDR	48 L

Model	Pump Speed
V10	78 L/min
V20	156 L/min
V40	312 L/min
V60	474 L/min

Model	Temp Range
SH-WB-5GDR(-40)	-40°C(-40°F) ~ -20°C(-4°F)
SH-WB-5GDR(-80)	-80°C(-112°F) ~ -60°C (-76°F)

Vacuum Pump

SH-V Series Perfect design and performance

Constantly pursuing on highest technology norms, SH Scientific V series vacuum pump reached new highest level: cylinder structure and innovative oil circulation system results in super stability; auto anti-sucking back valve and two shifts gas ballast makes best reliability; Perfect combination of technology and aesthetics helps to become classic.



- Two-Shift adjustable gas ballast valve satisfies different requirements of condensable vapor (such as water vapor) to be exhausted out of pump in different processes.
- Dual protection of oil anti-sucking back ensures vacuum system from oil pollution when pump stops running and needs to be easily restarted.
- Forced oil circulation system consisted of oil pump and constant pressure oil supply mechanism ensures stable running of the pump.
- Less components are used, easy to maintain and repair.

Model	SH-V10	SH-V20	SH-V40	SH-V60
Pumping Speed(50/60Hz)	78L/min	156L/min	312L/min	474L/min
Ultimate total pressure gas ballast close	5×10^{-2} Pa (3.7×10^{-4} torr)	5×10^{-2} Pa (3.7×10^{-4} torr)	4×10^{-2} Pa (3.0×10^{-2} torr)	4×10^{-2} Pa (3.0×10^{-2} torr)
Ultimate total pressure gas ballast open	3 Pa (2.2×10^{-2} torr)	3 Pa (2.2×10^{-2} torr)	8×10^{-1} Pa (6×10^{-3} torr)	8×10^{-1} Pa (6×10^{-3} torr)
Power supply	220V,50/60Hz or 110V,50/60Hz			
Power rating(kw)	0.4(1 Phase)	0.4(1 Phase)	0.75(1 Phase)	1.1(1 Phase)
Inlet/Exhaust Flange	KF 16/25	KF 16/25	KF 25	KF 25/40
Oil capacity(L)	0.6~1.0	0.6~1.0	0.9~1.5	1.3~2.0
Ambient temperature(°C)	5~40			
Noise level(dB)	≤56	≤56	≤58	≤58
Weight(kg)	19	21	30	43
Recommended for	Vacuum Drying Ovens (SH-VDO-08NG, SH-VDO-30NG, SH-VDO-70NG, SH-VDO-30NS, SH-VDO-70NS) Tube Furnace All Packages	Vacuum Drying Ovens (SH-VDO-70NG, SH-VDO-125NG, SH-VDO-216NG, SH-VDO-30NS, SH-VDO-70NS, SH-VDO-125NS) Tube Furnace All Packages	Vacuum Drying Ovens (SH-VDO-125NG, SH-VDO-216NG, SH-VDO-125NS)	Vacuum Drying Ovens (SH-VDO-216NG)



Option: Oil Mist Trap

VOT-1020 : V10, V20
VOT-4080 : V40, V60

Flow Rate Characteristic

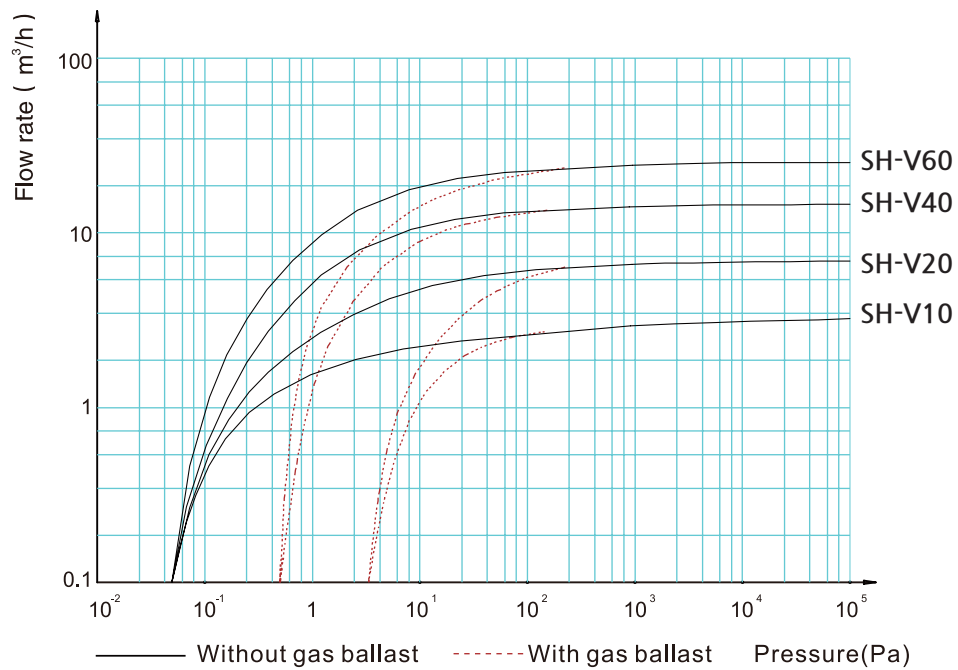

Dimension

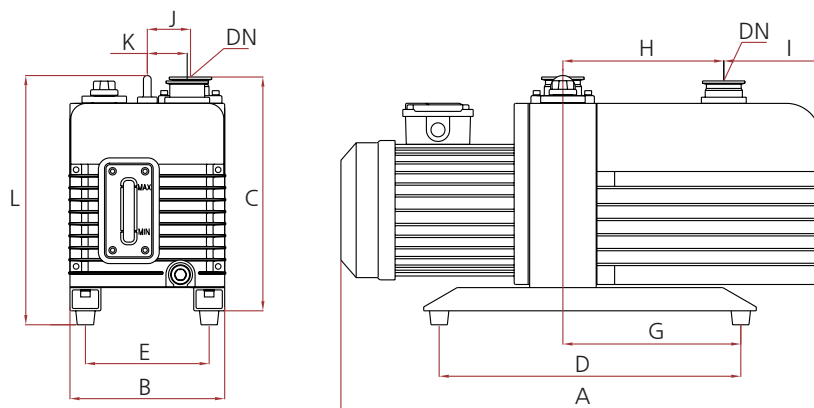

Dimensions												
Model	A	B	C	D	E	G	H	I	J	K	L	DN
SH-V10	460	144	207	210	110	126	154	45	45	34	/	KF16/25
SH-V20	460	144	207	210	110	126	154	45	45	34	/	KF16/25
SH-V40	520	188	272	320	148	160	165	69	59	38	295	KF25
SH-V60	520	188	272	320	148	160	165	69	59	38	295	KF25

SH-VDC (Low noise) Series

Dual stage low noise rotary vacuum pump

Constantly pursuing on innovative technology and high standards.

The pump is absolutely energy-saving with small motor power design.

The feature of low noise level is an ideal choice for high requirements of quite operation, especially for analytical applications.



- Low noise level allows for an installation close to the work space.
- Low power consumption for cost saving.
- Low and easy maintenance.
- Easy installation and small footprint.

Model	SH-VDC7	SH-VDC10	SH-VDC20
Pumping Speed(50/60Hz)	66L/min	96L/min	183L/min
Ultimate total pressure gas ballast close	5x10 ⁻² Pa (3.7x10 ⁻⁴ torr)	5x10 ⁻² Pa (3.7x10 ⁻⁴ torr)	5x10 ⁻² Pa (3.7x10 ⁻⁴ torr)
Ultimate total pressure gas ballast open	10 Pa (7.5x10 ⁻² torr)	10 Pa (7.5x10 ⁻² torr)	10 Pa (7.5x10 ⁻² torr)
Power supply	220V,50/60Hz or 110V,50/60Hz		
Power rating(kw)	0.37(1 Phase)	0.37(1 Phase)	0.37(1 Phase)
Inlet/Exhaust Flange	KF 16/25	KF 16/25	KF 16/25
Oil capacity(L)	0.6~1	0.6~1	0.6~1
Ambient temperature(°C)	5~40		
Noise level(dB)	≤48	≤48	≤50
Weight(kg)	14.5	14.5	15.5
Recommended for	Vacuum Drying Ovens (SH-VDO-08NG, SH-VDO-30NG, SH-VDO-30NS) Tube Furnace All Packages	Vacuum Drying Ovens (SH-VDO-08NG, SH-VDO-30NG, SH-VDO-70NG, SH-VDO-30NS, SH-VDO-70NS) Tube Furnace All Packages	Vacuum Drying Ovens (SH-VDO-70NG, SH-VDO-125NG, SH-VDO-216NG, SH-VDO-70NS, SH-VDO-125NS) Tube Furnace All Packages



Option: Oil Mist Trap
VOT-1020 : VDC7, VDC10
VOT-4080 : VDC20

Flow Rate Characteristic

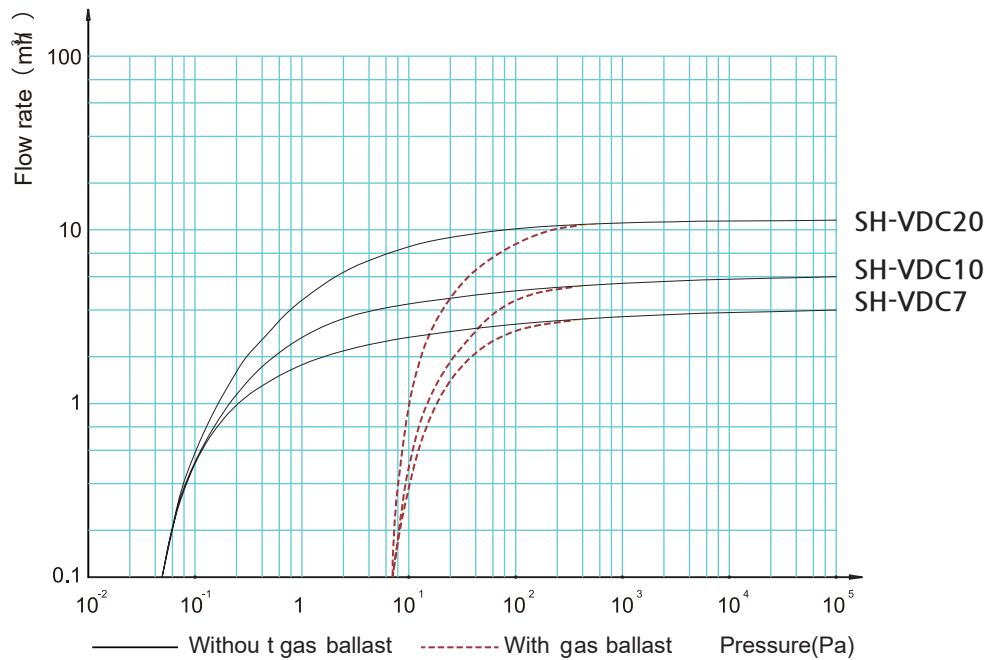

Dimension

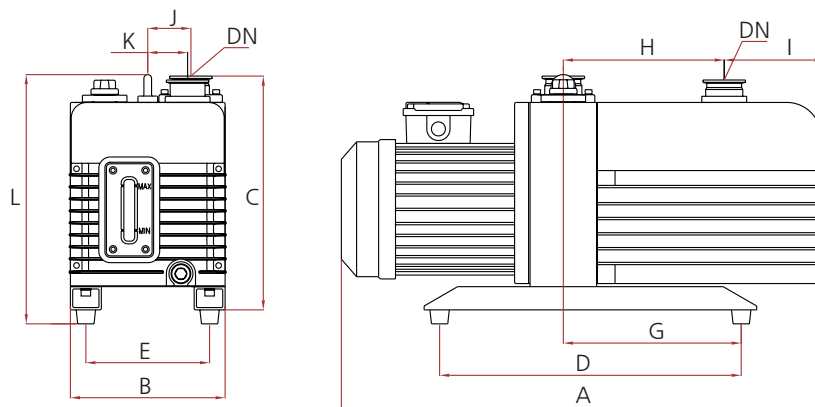

Dimensions												
Model	A	B	C	D	E	G	H	I	J	K	L	DN
SH-VDC7	420	144	207	210	110	126	154	45	45	34	/	KF16/25
SH-VDC10	420	144	207	210	110	126	154	45	45	34	/	KF16/25
SH-VDC20	420	144	207	210	110	126	154	45	45	34	/	KF16/25

SH-DV (Oil free) Series

Introduction of Oil free Scroll Vacuum Pump



- Wide product line up.
- No oil back diffusion or exhaust.
- Can be repeatedly continuous operated between atmospheric and vacuum.
- Low vibration, low noise and high efficiency.
- Ease of maintenance.

Model		SH-DV75	SH-DV150	SH-DV300	SH-DV600
Pumping Speed(50/60Hz)		72L/min	143L/min	305L/min	623L/min
Ultimate Pressure		7.9 Pa ($\leq 6.0 \times 10^{-2}$ torr)	5.3 Pa ($\leq 4.0 \times 10^{-2}$ torr)	2.5 Pa ($\leq 1.9 \times 10^{-2}$ torr)	0.9 Pa ($\leq 7.5 \times 10^{-3}$ torr)
Inlet/Exhaust Flange		KF 25/16	KF 25/16	KF 25/16	KF 40/16
Motor 1 phase	Motor Power(kW)	0.25	0.25	0.75	0.75
	Voltage (VAC)	220V,50/60Hz or 110V,50/60Hz			
	Speed (rpm)	50Hz /1425; 60Hz /1725			
Motor 3 phase	Motor Power(kW)	-	0.25	0.55	0.75
	Voltage (VAC)	-	50 Hz/200~230 or 380~415; 60 Hz/200~230 or 460		
	Speed (rpm)	-	50Hz/1425; 60Hz/1725		
Ambient temperature(°C)		5~40			
Noise Level (dB)		≤ 52	≤ 57	≤ 60	≤ 61
Net Weight	1phase(kg)	15	18	27	31
	3phase(kg)	-	20	31	38
Others		With air flush			
Recommended for		Vacuum Drying Ovens (SH-VDO-08NG, SH-VDO-30NG, SH-VDO-30NS) Tube Furnace All Packages	Vacuum Drying Ovens (SH-VDO-30NG, SH-VDO-70NG, SH-VDO-125NG, SH-VDO- 216NG,SH-VDO-30NS, SH-VDO-70NS,SH-VDO- 125NS) Tube Furnace All Packages	Vacuum Drying Ovens (SH-VDO-125NG, SH-VDO- 216NG, SH-VDO-175NG, SH-VDO-252NG, SH-VDO- 125NS)	Vacuum Drying Ovens (SH-VDO-125NG,SH-VDO- 216NG, SH-VDO-175NG, SH-VDO-252NG, SH-VDO-125NS)

Performance curves

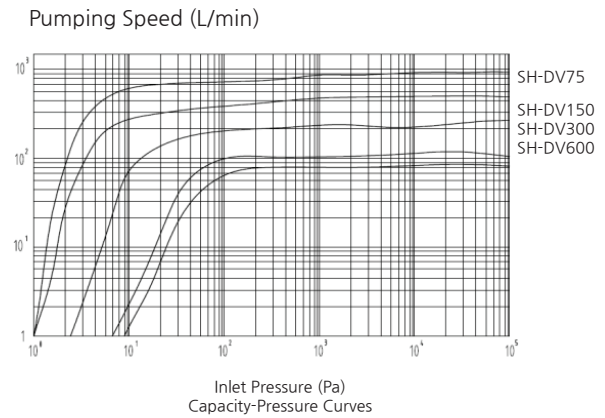
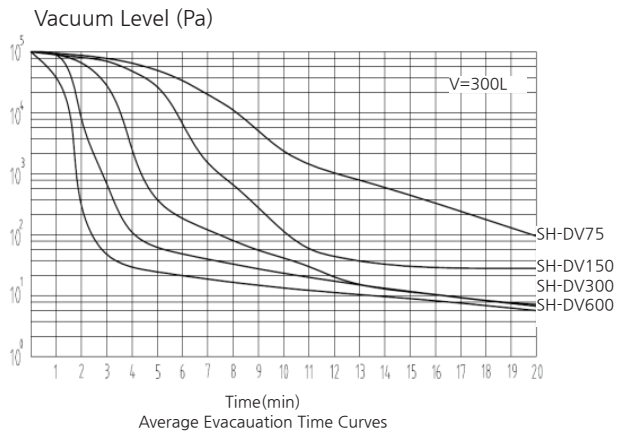

Dimension

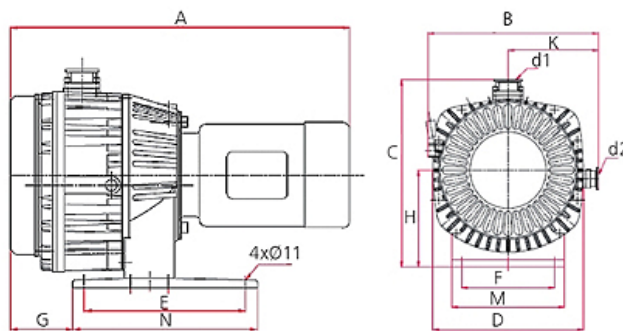

Dimensions													
Model	A	B	C	D	E	F	G	H	M	N	K	d1	d2
SH-DV75	405	225	260	200	192	114	72	131	146	225	125	KF25	KF16
SH-DV150	430	250	280	220	214	129	86	130	155	250	135	KF25	KF16
SH-DV300	492	268	324	226	252	163	87	174	192	288	140	KF25	KF16
SH-DV600	530	312	343	275	252	170	115	178	206	288	165	KF40	KF16

Programmable Controller Options



- High Accuracy($\pm 0.1\%$) with excellent Function
- Multi Input : TC, RTD, DCV
- Simultaneous and Multi output available in Max 4 Points
- Easy parameter and value setting
- Function to protect over shoot
- RUN/STOP Function in the external Input contact point
- Display of Running status in Auxiliary Output
- Large Program Capacity : 2 Patterns / 30 Segments
- Variety of Auxiliary Output available (ex IS, TS, PEND etc)
- Input Piece Bias Function(Max 4 zone)
- Automatic PID Parameter Calculation
- Variety of communication Protocols
- Reliable quality(CE, CUL, ISO applied)

Display	Size(WxHxL)	96x96x100mm / 3.8x3.8x3.9"
	PV/SP Display	4 Digit
Operation Mode		Program / Reset, 2 Zone PID
Control Mode		1CH Control
Max Channel		-
Pattern & Segments		2 Pattern / Max 30 segments
Input	TC	K, J, E, T, R, B, S, L, N, U, W, C, Platinel II
	RTD	Pt100 Ω , JPt100 Ω
	Analog Voltage Input	-10~20mV, 0~100mV, 0.4~2.0V DC, 1~5V DC, 0~10V DC
Output	Control Output	RELAY, SSR(Voltage Pulse)
	Current Output	4 ~ 20mA DC
	Voltage Output	-
	Transmission Output	4 ~ 20mA (PV, SP, MV)
Digital Input	Contact Type	2 Points / 4 Types(RUN, HOLD, STEP, RESET)
	Contact capacity	-
Digital Output	Relay	Normal Open 30V DC A, 250V AC 1A Normal Close 30V DC3A 250V AC 3A
	Open Collector	ON voltage across contacts at less than 2V, the leakage current less than 100 μ A
Sampling Time		250ms
Accuracy		$\pm 0.1\%$ $\pm 1\%$ digit of Full Scale
Event	Alarm	1 Point / Max 3 Points(20 Types)
	Inner Signal	2 Points (PV, SP, TSP)
	Time Signal	1 Point
	Other	1 Point (RUN, Pattern END, UP, DOWN, SOAK)
Communication	Interface	RS485
	Protocol	PC-Link, MODBUS(ASCII, RTU), SYNC(Master, Slave)
	Speed	Max 19,200 bps
Power	Power	100 ~ 240V AC, 50 ~ 60Hz
	Power Consumption	Max 6W
Operating environment		-
Weight		-