

OPERATION MANUAL

TH1941

4¹/₂ Digit Multimeter

Changzhou Tonghui Electronic Co., Ltd.

www.tonghui.com.cn

Manual Printing History

The manual printing data and part number indicate its current edition. The printing date changes when a new edition is printed. The manual part number changes when extensive technical changes are incorporated.

October 2008.....First Edition

Notice

The information contained in this document is subject to change without notice.

Safety notice supplement

As described in the International Electrotechnical Commission (IEC) Standard IEC 664, digital multimeter measuring circuits (e.g., Tonghui Models 1951, 1961, 1941, and 1942) are Installation Category II. All other instruments' signal terminals are Installation Category I and must not be connected to mains.

This equipment is POLLUTION DEGREE 2, INDOOR USE product.

Safety Precautions

Users of this product must be protected from electric shock at all times. The responsible body must ensure that users are prevented access and/or insulated from every connection point. In some cases, connections must be exposed to potential human contact. Product users in these circumstances must be trained to protect themselves from the risk of electric shock. If the circuit is capable of operating at or above 1000 volts, no conductive part of the circuit may be exposed.

Before operating an instrument, make sure the line cord is connected to a properly grounded power receptacle. Inspect the connecting cables, test leads, and jumpers for possible wear, cracks, or breaks before each use.

For maximum safety, do not touch the product, test cables, or any other instruments while power is applied to the circuit under test. ALWAYS remove power from the entire test system and discharge any capacitors before: connecting or disconnecting cables or jumpers, or making internal changes, such as installing or removing jumpers.

Do not touch any object that could provide a current path to the common side of the circuit under test or power line (earth) ground. Always make measurements with dry hands while standing on a dry, insulated surface capable of withstanding the voltage being measured.

The instrument and accessories must be used in accordance with its specifications and operating instructions or the safety of the equipment may be impaired.

Do not exceed the maximum signal levels of the instruments and accessories, as defined in the specifications and operating information, and as shown on the instrument or test fixture panels.

When fuses are used in a product, replace with the same type and rating for continued protection against fire hazard.

Chassis connections must only be used as shield connections for measuring circuits, NOT as safety earth ground connections.

If you are using a test fixture, keep the lid closed while power is applied to the device under test.

Contents

Chapter 1 General Information	7
1.1 Feature Overview	7
1.2 Operating Environment	7
1.3 Dimensions and Weight	7
1.4 Safety symbols and Precautions	8
1.5 Incoming Inspection	8
1.6 Warranty.....	9
1.7 Limitation of Warranty	9
Chapter 2 TH1941 Overview.....	10
2.1 Front Panel Summary	10
2.2 Annunciators on Screen	11
2.3 Front Panel Menu Reference	12
2.4 Front Panel Menu Overview.....	13
2.5 Rear Panel Summary	14
2.6 Power up.....	15
2.6.1 Power Line Connection	15
2.6.2 Input Terminals	15
2.6.3 Power-up Sequence	16
2.6.4 High Energy Circuit Safety Precautions	16
2.6.5 Power-on Defaults.....	17
2.6.6 Warm-up time	17
2.7 Display.....	17
Chapter 3 Basic Measurements	18
3.1 Preparation.....	18
3.2 Measuring Voltage	18
3.2.1 Connections	18
3.3 Measuring Current	19
3.3.1 Connections	19
3.3.2 Front Panel Fuse Replacement.....	21
3.4 Measuring Resistance	22
3.4.1 Connections	22
3.4.2 Shielding.....	22
3.5 Measuring Frequency and Period	23
3.5.1 Trigger Level and Measurement Errors	23
3.5.2 Gate Time	23
3.5.3 Connections	23
3.6 Measuring Continuity	24
3.6.1 Connections	24
3.7 Testing Diode.....	25
3.7.1 Connections	25
3.8 Measuring True RMS AC+DC	26
3.8.1 Connections	26

3.8.2 Using the 2 nd parameter display	27
3.9 Math Functions	27
3.9.1 Percent	27
3.9.2 dB Calculation.....	28
3.9.3 dBm Calculation	29
Chapter 4 Measurement Options	31
4.1 Measurement configuration	31
4.1.1 Range	31
4.1.2 Relative.....	32
4.1.3 Rate.....	32
4.2 Trigger Operations	33
4.2.1 Trigger procedure.....	33
4.2.2 Reading Hold	34
4.3 MAX / MIN	34
4.4 Limit Operations	35
4.4.1 Enabling limits.....	35
4.4.2 Setting Limit Values	35
4.5 System Operations	36
4.5.1 Beeper Control	36
4.5.2 Baud rate	36
4.5.3 Selecting the Terminal Character.....	37
4.5.4 Key Sound.....	37
Chapter 5 Remote Operation	39
5.1 RS-232	39
5.2 RS-232 Interface Operation	39
5.2.1 RS-232 Connection	39
5.2.2 Sending and receiving data	40
5.2.3 Selecting Baud Rate	41
5.2.4 Software Protocol.....	41
5.3 Data Format	42
Chapter 6 SCPI Command Reference	43
6.1 Command structure.....	43
6.2 Command Syntax.....	43
6.2.1 Commands and command parameters	43
6.2.2 Short-form Rules	45
6.2.3 Basic Rules of Command Structure	45
6.2.4 Multiple Command Rules.....	46
6.2.5 Command Path Rules	46
6.3 Command Reference	46
6.3.1 DISPlay subsystem.....	46
6.3.2 FUNction subsystem.....	48
6.3.3 VOLTage subsystem.....	49
6.3.4 CURRent subsystem	53
6.3.5 RESlister subsystem	57

6.3.6 FREQuency and PERiod subsystem	60
6.3.7 HOLD subsystem	62
6.3.8 TRIGger subsystem	64
6.3.9 FETCH Subsystem	64
6.3.10 Common Commands	65
Chapter 7 Specifications	66
Chapter 8 Program Examples.....	71

Chapter 1 General Information

Thanks very much for choosing and using our product. If you have any questions after reviewing this manual, please contact your local representative or call directly to our application engineers for further consultation.

1.1 Feature Overview

TH1941 is a 4½ digital multimeter with high accuracy, stability and speed. The digital multimeter provides a maximum measurement speed of 25 readings/sec. TH1941 has a 0.01% DC voltage basic accuracy, 0.03% basic resistance accuracy and other high performance. TH1941 has broad measurement ranges:

- DC voltage from 10μV to 1000V
- AC (RMS) voltage from 10μV to 750V, 1000V Peak
- DC current from 100nA to 20A
- AC (RMS) current from 100nA to 20A
- Two -wire resistance from 10mΩ to 20MΩ
- Frequency from 5Hz to 1MHz

Some additional capabilities of Model TH1941:

- Full range of functions: In addition to those listed above, The TH1941 functions include period, dB, dBm, continuity, diode testing, max, min and percent.
- Programming languages and remote control interfaces: The TH1941 provides the SCPI programming language and the remote control interface port: RS-232C.
- Closed-cover calibration: The multimeter can be calibrated either from the front panel or through the remote control interface.

1.2 Operating Environment

Power supply: 110V/220V ±10%

Line frequency: 50Hz / 60Hz ±5%

Power consumption: <10VA

Operating temperature: 0°C to 40°C

Humidity: ≤ 90%RH

1.3 Dimensions and Weight

Dimensions (W×H×D): 225mm×100mm×318mm

Net weight: Around 2.2Kg

1.4 Safety symbols and Precautions

The  symbol on the instrument indicates that user should refer to the operating instructions located in the manual before performing.

The  symbol on the instrument shows that high voltage may be present on the terminal(s). Be careful to avoid personal contact with these voltages.

The symbol  on the instruments means earth grounding.

The **WARNING** heading used in the manual explains high voltage danger that might result in personal injury or death. Always read the associated information very carefully before performing the indicated procedure.

The **CAUTION** heading in the manual reminds user that hazards could damage the instruments if not according to operating instructions. Such damage may invalidate the warranty.

1.5 Incoming Inspection

The TH1941 was carefully inspected mechanically and electrically before shipment. After unpacking all items from the shipping carton, please check for any obvious signs of physical damage that may have occurred during transportation. Report any damage to the shipping agent immediately. Save the original packing carton for possible future reshipment. The following items are included with every Model TH1941 order:

- Model TH1941 4¹/₂ Digital Multimeter
- Test leads (Model TH26036)
- Power cord
- Two 500mA fuses
- Two 1A fuses
- Operation Manual
- Quality and warranty certificate
- Test report
- Other optional accessories if ordered

Verify that you have received all the items above when you get multimeter. If anything is missing, please contact our representative or our sales office.

1.6 Warranty

Tonghui warrants this product to be free from defects in material and workmanship for a period of 2 years from the date of shipment. During the warranty period, we will, at our option, either repair or replace any product that proves to be defective.

1.7 Limitation of Warranty

This warranty does not apply to defects resulting from product modification without our express written consent, or misuse of any product or part. This warranty also does not apply to fuses, software, or problems arising from normal wear or failure to follow instructions.

THIS WARRANTY IS IN LIEU OF ALL OTHER WARRANTIES, EXPRESSED OR IMPLIED, INCLUDING ANY IMPLIED WARRANTY OF MERCHANTABILITY OR FITNESS FOR A PARTICULAR USE. THE REMEDIES PROVIDED HEREIN ARE BUYER'S SOLE AND EXCLUSIVE REMEDIES.

NEITHER TONGHUI ELECTRONICS NOR ANY OF ITS EMPLOYEES SHALL BE LIABLE FOR ANY DIRECT, INDIRECT, SPECIAL, INCIDENTAL OR CONSEQUENTIAL DAMAGES ARISING OUT OF THE USE OF ITS INSTRUMENTS AND SOFTWARE EVEN IF TONGHUI ELECTRONICS HAS BEEN ADVISED IN ADVANCE OF THE POSSIBILITY OF SUCH DAMAGES. SUCH EXCLUDED DAMAGES SHALL INCLUDE, BUT ARE NOT LIMITED TO: COSTS OF REMOVAL AND INSTALLATION, LOSSES SUSTAINED AS THE RESULT OF INJURY TO ANY PERSON, OR DAMAGE TO PROPERTY.

Chapter 2 TH1941 Overview

2.1 Front Panel Summary

The front panel of the TH1941 is shown in Figure 2-1. This figure includes some important abbreviated information that should be reviewed before operating the instrument.

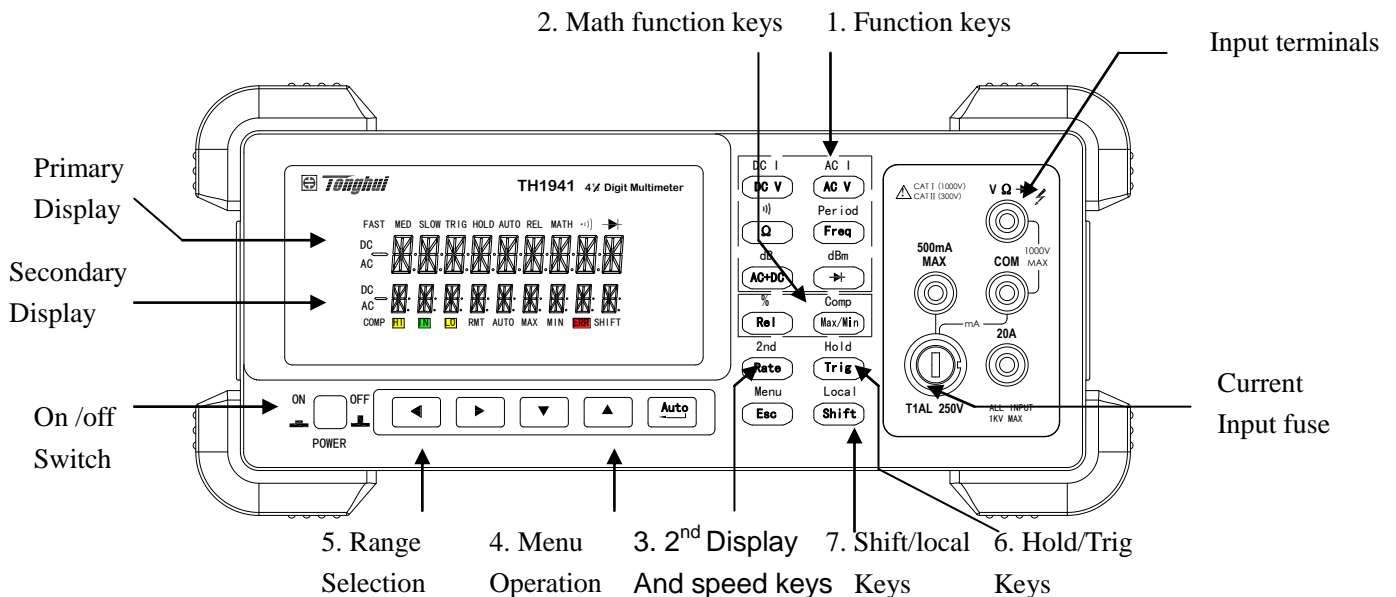
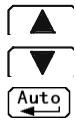

Figure 2-1 TH1941 Front Panel

1. Measurement Function keys (shifted and unshifted)
 Select measurement function: DC voltage and current, AC voltage and current, resistance, continuity, frequency, period, dB, dBm, AC+DC and diode test.
2. Math function keys
 Select the math function: Rel, %, Max/Min, Comp and Hold.
3. 2nd Display and speed key
 [Rate] Changes reading rate: Fast, Medium and Slow.
 [Shift] → [Rate] turns on/ off the 2nd parameter display.
4. Menu operation keys
 [Shift] → [Esc] Open/Close menu
 [Left Arrow] Move through selections within menu level, command level or parameter level
 [Right Arrow] Move through selections within menu level, command level or parameter level.
 [Up Arrow] Move up a level.
 [Down Arrow] Move down a level.
 [Auto] (ENTER) Save the change made on “parameter” level, and return to the “command” level.
 [Esc] Cancel the change made on “parameter” level, and return to the “command” level.
5. Range and Combination function selecting keys
 [Left Arrow] Select a 2nd display parameter
 [Right Arrow] Select a 2nd display parameter



Select a higher range and disable auto ranging.
 Select a lower range and disable auto ranging.
 Toggle between auto ranging and manual ranging.

6. Trig/Hold Key

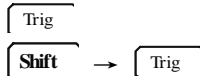

Trigger a measurement from the front panel.
 Hold a stable reading on the display when selected numbers of samples are within the selected tolerance.

7. Shift/Local keys

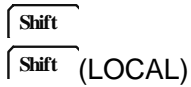

Used to access shifted keys.
 Cancel RS232C remote control mode and back to the LOCAL mode.

2.2 Annunciators on Screen

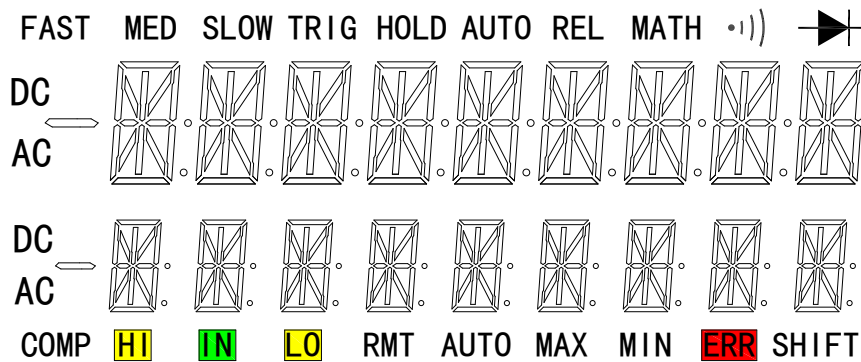

Figure 2-2 Display Annunciators

- FAST Fast reading rate
- MED Medium reading rate
- SLOW Slow reading rate
- TRIG Indicates external trigger (front panel, bus) selected.
- HOLD Reading HOLD function is enabled
- REL Relative reading displayed
- MATH A math operation is enabled (% , dB, dBm).
-) (Speaker) Beeper on for continuity testing function
- ➔ (Diode) Instrument is in diode testing function
- DC DC operation is enabled
- AC AC operation is enabled
- COMP Limit testing function is enabled
- HI/IN/LO Indicates the limit testing results
- RMT Multimeter is in remote control mode
- AUTO Auto ranging enabled
- Max/Min MAX / MIN operation is enabled
- ERR Hardware or remote control error detected
- SHIFT Accessing shifted keys

2.3 Front Panel Menu Reference

A: MATH MENU

1: HI LIMIT → 2: LO LIMIT → 3: PERC REF → 4: dB REF → 5: dBm REF

1. HI LIMIT Set the high limit for limit testing.
2. LO LIMIT Set the low limit for limit testing.
3. PERC REF Set the reference value for PERCENT function
4. dB REF Set the dB reference voltage value.
5. dBm REF Set the dBm reference impedance value.

B: TRIGger MENU

1: TRIG MOD → 2: HOLD WIN → 3: HOLD CNT

1. TRIG MOD Select IMMEDIATE, Manual or Bus trigger source mode.
2. HOLD WIN Set the reading hold sensitivity band.
3. HOLD CNT COUNT of readings for reading hold.

C: SYStem MENU

1: BEEP STA → 2: BAUD RAT → 3: TX TERM → 4: KEY SONG

1. BEEP STA Enable or disable the beeper function
2. BAUD RAT Select the baud rate for RS232C operation.
3. TX TERM Set the terminal character for RS232 operation, which identifies the end of a command string
4. KEY SONG Enable or disable the key sound when you press a key.

2.4 Front Panel Menu Overview

The menu is organized in a top-down tree structure with three levels (menus, commands and parameters) as shown in Figure 2-3. You can use down (\blacktriangledown) or up (\blacktriangle) to move menu tree from one level to another. Each of the three levels has several horizontal choices which you can view by using left (\blacktriangleleft) or right (\blacktriangleright).

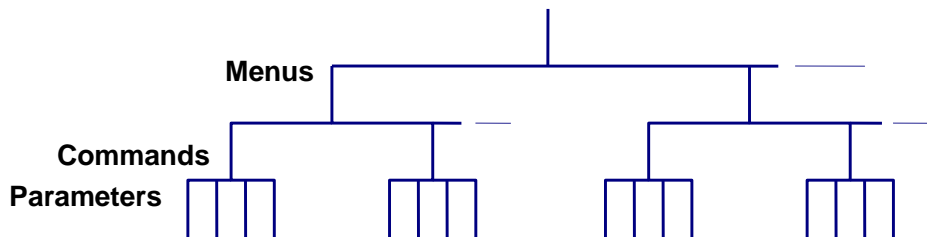

Figure 2-3 Menu Tree

- To turn on the menu, press $\text{Shift} \rightarrow \text{Esc}$ (Menu).
- To turn off the menu, press $\text{Shift} \rightarrow \text{Esc}$ (Menu), or press any of the function or math keys on the front panel.
- To confirm a change on the “parameter” level, press $\text{Auto} \leftarrow$ (ENTER).
- To cancel a change on the “parameter” level, press Esc (Menu).

Note: If you press \blacktriangle on the “menu” level, this is the top level of the menu and you can not go any higher; similarly if you press \blacktriangledown on the “parameter” level, this is the bottom level of the menu and you can not go any lower.

2.5 Rear Panel Summary

The rear panel of TH1941 is shown in Figure 2-4. This section includes important information that should be reviewed before operating the instrument.

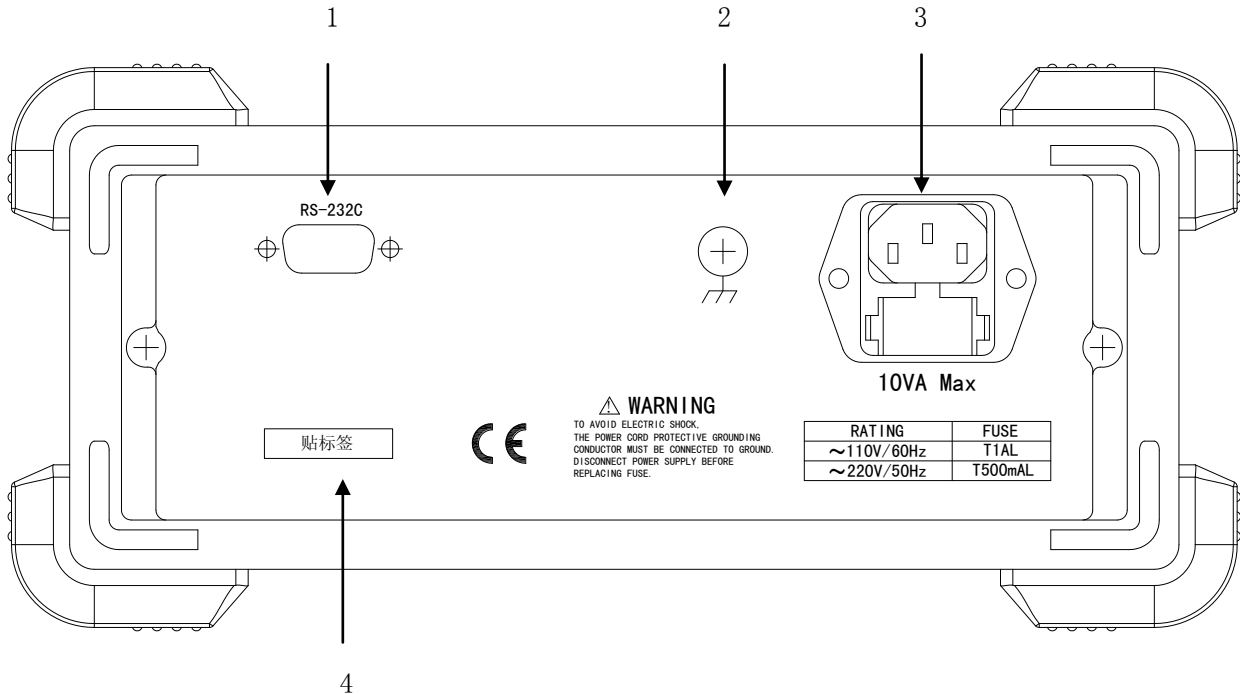

Figure 2-4 TH1941 Rear Panel

1. RS-232C Connector
Connector for RS-232 operation. Use a standard DB-9 cable.
2. Grounding
Chassis Grounding terminal
3. Power-Line Fuse-Holder Assembly
TH1941 can be configured for line voltage of 110/220V \pm 10% AC at line frequency of 50/60Hz \pm 5%. Power-line fuse is used for instrument protection. (220V/500mA or 110V/1A)
Note: Please use the same-type fuse or contact your nearest Tonghui sales and service office.
To verify and replace the fuse, remove the power cable and pull out the fuse holder.
4. Label
Serial number for this instrument

2.6 Power up

2.6.1 Power Line Connection

Follow the procedure below to connect the TH1941 to line power and turn on the instrument.

1. Check to make sure that the line voltage is in the range of 198V to 242V (or $110V \pm 10\%$) and line frequency is in the range of 47.5 to 52.5Hz (or $60Hz \pm 5\%$) before connecting the power cord.

CAUTION: Operating the instrument on an incorrect voltage may cause damage to the instrument, possibly voiding the warranty.

2. Before plugging in the power cord, make sure that the front panel power switch is in the off position.
3. Connect the female end of the supplied power cord to the AC receptacle on the rear panel. Connect the other end of the power cord to a grounded AC outlet.

WARNING: The power cord supplied with the Model TH1941 contains a separate ground wire for use with grounded outlets. When proper connections are made, instrument chassis is connected to power line ground through the ground wire in the power cord. Failure to use a grounded outlet may result in personal injury or death due to electric shock.

4. Turn on the instrument by pressing the front panel power switch and get ready for measuring.

2.6.2 Input Terminals

The input terminals are shown in Figure 2-5. The multimeter is protected against overloads up to the limits as shown in table 2-1. Exceeding these limits may result in a hazard to both the multimeter and operator.

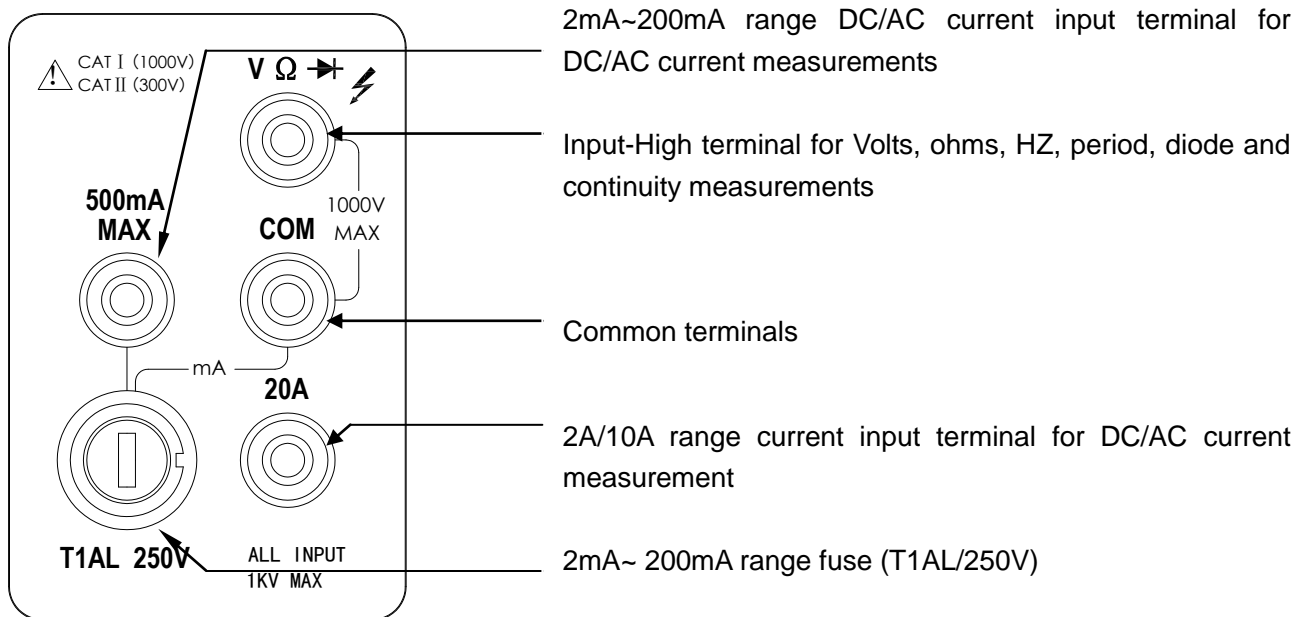

Figure 2-5 Input terminals

Table 2-1 Input protection Limits

Function	Input Terminals	Maximum Allowable Input
DCV	V Ω \rightarrow to COM	1010V DC
ACV,HZ	V Ω \rightarrow to COM	757.5V AC RMS,1000V Peak
mA, HZ	500mA to COM	200mA DC or AC RMS
20A,HZ	20A to COM	20A DC or AC RMS
Ω	V Ω \rightarrow to COM	500V DC or AC RMS
\rightarrow , \rightarrow , \rightarrow)	V Ω \rightarrow to COM	500V DC or AC RMS
All functions	Any terminals to earth	1000V DC or 1000V peak AC

2.6.3 Power-up Sequence

On power-up, Model TH1941 performs self-tests on its EPROM and RAM and lights all segments and annunciators for about 1 second. If a failure is detected, the instrument momentarily displays an error message and the ERR annunciator turns on.

If the instrument passes self-tests, the firmware revision will be displayed.

2.6.4 High Energy Circuit Safety Precautions

To optimize safety when measuring voltage in high energy distribution circuits, read and use the directions in the following warning.

When making measurements in high energy circuits, use test leads and accessories that meet the following requirements:

- Test leads and accessories must be fully insulated.
- Only use test leads that can be connected to the circuit (e.g., alligator clips, spade lugs, etc.) for hands-off measurements.
- Do not use test leads or accessories that decrease voltage spacing. This diminishes arc protection and creates a hazardous condition.

Use the following sequence when measuring high energy circuits:

1. De-energize the circuit using the regular installed connect-disconnect device, such as a circuit breaker, main switch, etc.
2. Attach the test leads to the circuit under test. Use appropriate safety rated test leads for this application.
3. Set the multimeter to the proper measurement function and range.
4. Energize the circuit using the installed connect-disconnect device and make measurements without disconnecting the multimeter.
5. De-energize the circuit using the installed connect-disconnect device.
6. Disconnect the test leads from the circuit under test.

WARNING: *The maximum common-mode voltage (voltage between COM and the chassis ground) is 500V peak. Exceeding this value may cause a breakdown in insulation, creating a shock hazard.*

2.6.5 Power-on Defaults

Model TH1941 uses the factory default settings for the power-on settings.

Since the basic measurement procedures in this manual assume the factory defaults, reset the instrument to the factory settings when following step-by-step procedures. Table 2-2 lists the factory default settings.

Table 2-2 Factory Default Settings

Setting	Factory Default
Function	DCV
Range	AUTO
Rate	Medium
Remote/Local	Local
Trigger Mode	Immediate
Relative Mode	OFF
Compare Mode	OFF
HI Limit	+1
Lo Limit	-1
Percent Mode	OFF
Reference	+1
Max/Min Mode	OFF
Reading Hold	OFF
Secondary Display Mode	OFF
Cal Mode	OFF

2.6.6 Warm-up time

Model TH1941 is ready for use as soon as the power-up sequence has completed. However, to achieve rated accuracy and stability, allow the instrument to warm up for half an hour. If the instrument has been subjected to extreme temperatures, allow additional time for internal temperatures to stabilize.

2.7 Display

The display of Model TH1941 is primarily used to display readings, along with the units and type of measurement. Annunciators located on the left, right and bottom indicate various states of operation. See section 2.2 for a complete listing of annunciators.

Chapter 3 Basic Measurements

3.1 Preparation

One of the first things you would like to do with your multimeter is to become acquainted with its front panel. We have provided some exercises in foregoing chapters about preparations for use and operations of front panel.

The front panel has six rows of keys to select various functions and operations. Most keys have a shifted function printed in blue above the key. To perform a shifted function, press $\overline{\text{Shift}}$ (the **Shift** annunciator will turn on). Then, press the key that has the desired label above it. For example, to select the AC current function, press $\overline{\text{Shift}}$ then press $\overline{\text{ACV}}$ (ACI).

If you accidentally press $\overline{\text{Shift}}$, just press it again to turn off the **Shift** annunciator.

3.2 Measuring Voltage

Voltage ranges: 200 mV, 2 V, 20 V, 200 V, 1000 V (750 VAC)

Maximum resolution: 10 μ V (on 200mV range)

AC technique: true RMS, ac-coupled, 1000V Peak AC

3.2.1 Connections

Assuming Model TH1941 is under factory default conditions, the basic procedure is as follows:

1. Connect test leads to $V\Omega\rightarrow$ and COM terminals.
2. Select DC or AC voltage measurement by pressing $\overline{\text{DCV}}$ or $\overline{\text{ACV}}$.
3. Press $\overline{\text{Auto}}$ toggles auto ranging. Notice that the **AUTO** annunciator is displayed with auto ranging. If you want manual ranging, use the RANGE $\overline{\blacktriangle}$ and $\overline{\blacktriangledown}$ keys to select a measurement range consistent with expected voltage.
4. Connect test leads to the sources as shown in Figure 3-1.

CAUTION: Do not apply more than 1000V peak to the input or instrument damages may occur.

5. If the "**OVL.D**" message is displayed, press the up $\overline{\blacktriangle}$ key to select a higher range until a normal reading is displayed (or press $\overline{\text{Auto}}$ key for auto ranging). Use the lowest possible range for the best resolution.
6. press $\overline{\text{Shift}}+\overline{\text{Rate}}$ to turn on the secondary display, Use $\overline{\blacktriangleleft}$ or $\overline{\blacktriangleright}$ key to move across to select the combination functions
7. Take readings from the display.

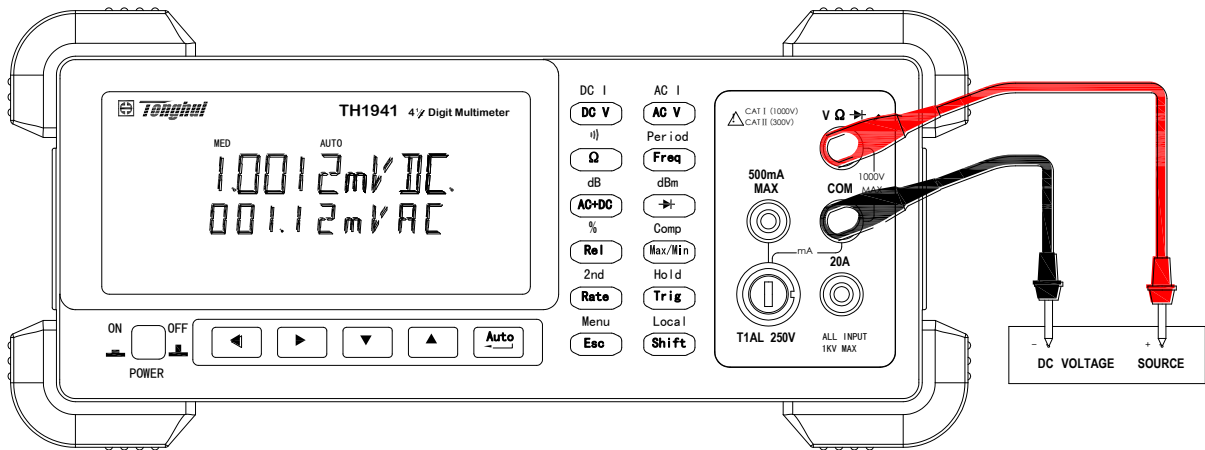

Input Resistance = 10MΩ

CAUTION: Maximum Input=1010V peak

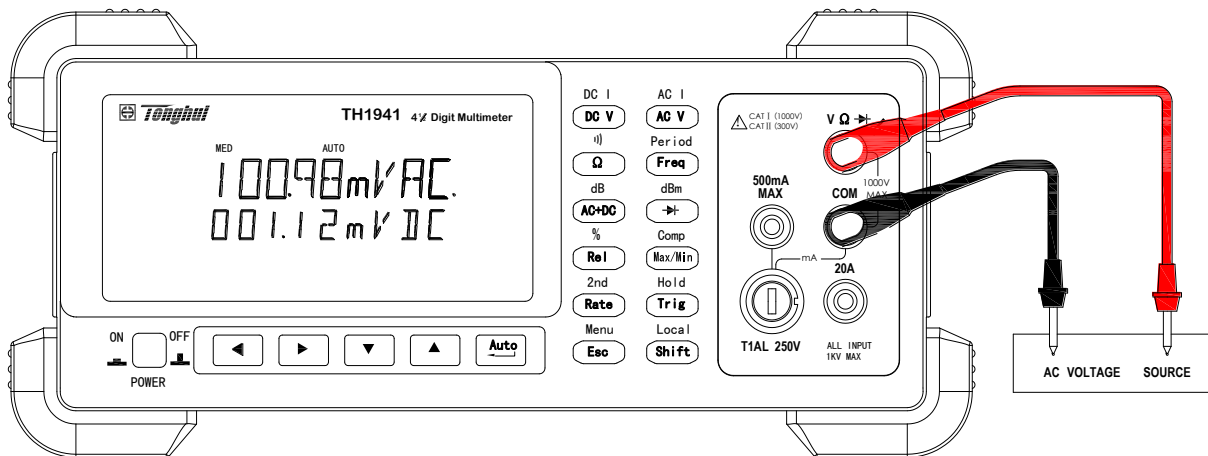

Input Impedance = 1.1MΩ and 100pF

CAUTION: Maximum Input = 750V RMS or 1000V peak, 3×10^7 V-Hz

Figure 3-1 DC and AC Voltage Measurement Connections

3.3 Measuring Current

Model TH1941 current measurement range: 2mA, 20mA, 200mA (DC only), 2A, 20A

Maximum resolution: 100nA (on 2mA range)

3.3.1 Connections

Assuming Model TH1941 is under factory default conditions, the basic procedure is as follows:

1. Connect test leads between 500mA terminal and COM or between 20A terminal and COM.
2. Select DCI or ACI measurement function by pressing $\left[\text{Shift} \rightarrow \text{DCV} \right]$ or $\left[\text{Shift} \rightarrow \text{ACV} \right]$
3. Press $\left[\text{Auto} \right]$ toggles auto ranging. Notice the **AUTO** annunciator is displayed with auto ranging. If you want manual ranging, use the RANGE $\left[\blacktriangle \right]$ and $\left[\blacktriangledown \right]$ keys to select a measurement range consistent with expected current.
4. Connect test leads to the source as shown in Figure 3-2:

CAUTION: Do not apply more than 1A, 250V to the 500mA input terminal or the fuse will be open-circuit.

5. If the "OVL.D" message is displayed, press up \uparrow key to select a higher range until a normal reading is displayed (or press \leftarrow key for auto ranging). Use the lowest possible range for the best resolution.
6. press \leftarrow + \rightarrow to turn on the 2nd parameter display , Use \leftarrow or \rightarrow key to move across 2nd display parameters
7. Take readings from the display.

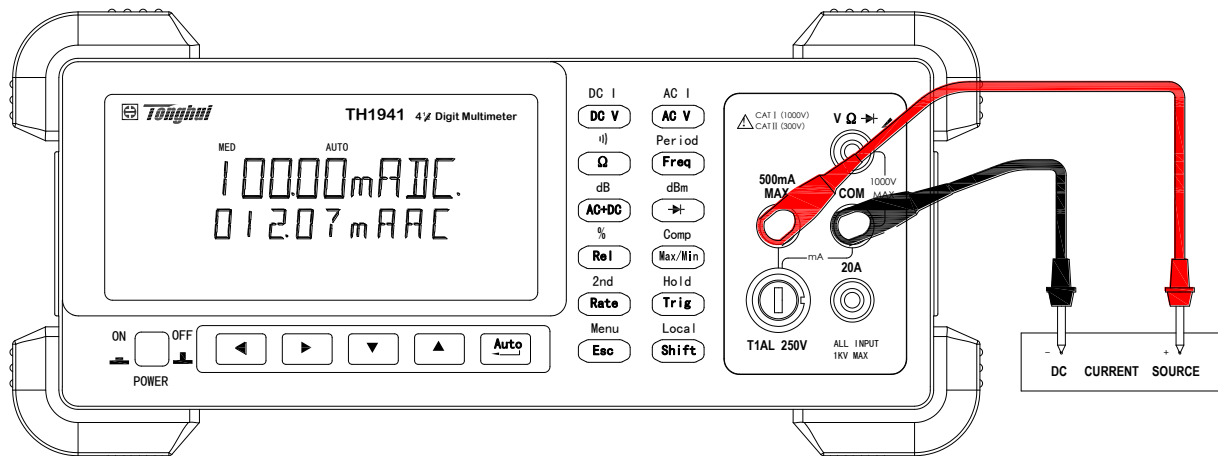

DC Current measurement on Range: 2mA, 20mA, 200mA

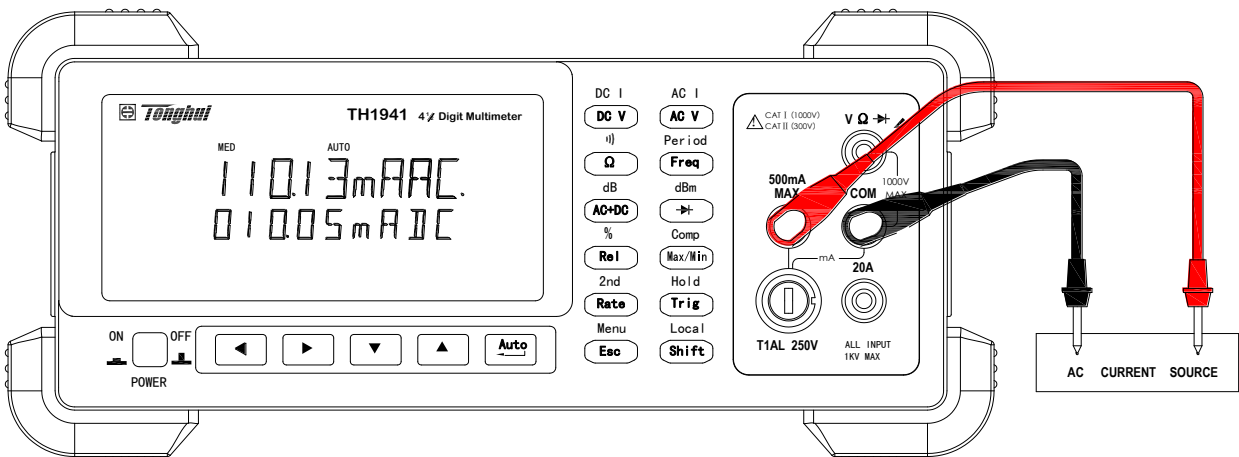

AC Current measurement on Range: 2mA, 20mA, 200mA

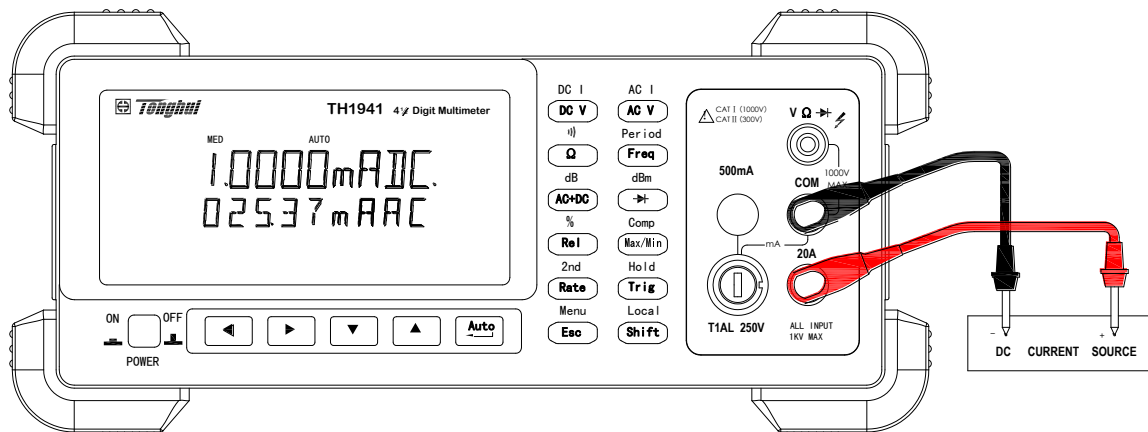

DC Current measurement on Range: 2A, 20A

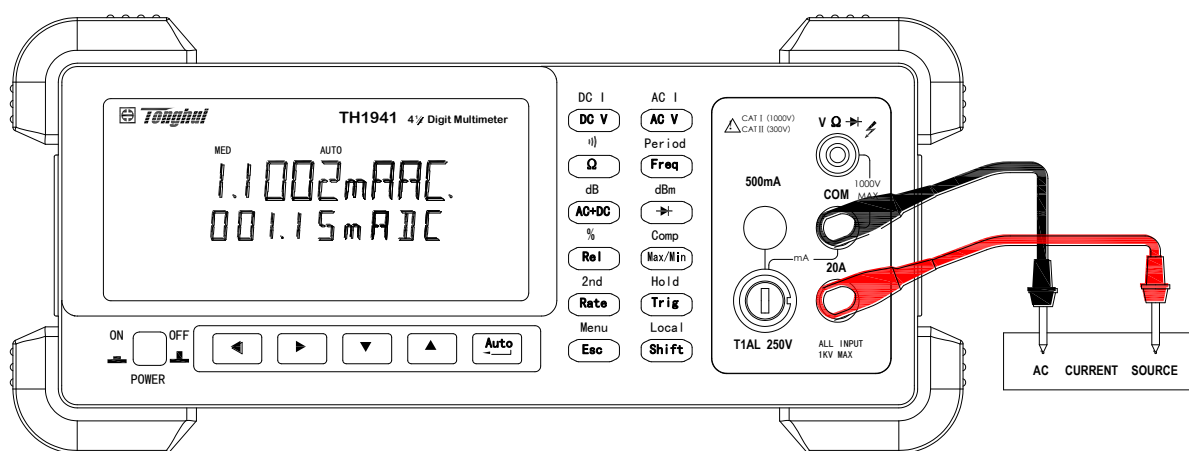

AC Current measurement on Range: 2A, 20A

CAUTION: Maximum Input = 20A DC or RMS Maximum test times : < 20s

Figure 3-2 DC and AC Current Measurements

3.3.2 Front Panel Fuse Replacement

WARNING: Make sure the instrument is disconnected from the power line and other equipment before replacing the AMPS fuse.

1. Turn off the power and disconnect the power line and test leads.
2. From the front panel, use a screwdriver to rotate the fuse carrier several turns counter-clockwise. Take the fuse carrier out of the socket.
3. Remove the fuse and replace it with the same type (T1AL, 250V, 5x20mm) .

CAUTION: Do not use a fuse with a higher current rating than specified or instrument damage may occur. If the instrument repeatedly blows fuses, try to find out the reason before replacing the fuse.

4. Install the new fuse by reversing the procedure above.

3.4 Measuring Resistance

Model TH1941 Resistance measurement range: 200 Ω , 2k Ω , 20k Ω , 200k Ω , 2M Ω , 20M Ω ; Maximum resolution: 10m Ω (on 200 Ω range)

3.4.1 Connections

Assuming Model TH1941 is under factory default conditions, the basic procedure is as follows:

1. Connect the test leads between V Ω and COM.
2. Select resistance measurement function by pressing Ω .
3. Press **Auto** toggles auto ranging. Notice the **AUTO** annunciator is displayed with auto ranging. If you want manual ranging, use the RANGE \blacktriangle and \blacktriangledown keys to select a measurement range consistent with expected resistance.
4. Connect test leads to the resistance as shown in Figure 3-3:

CAUTION: Do not apply more than 1000V peak between V Ω and COM or instrument damage may occur.

5. If the “OVL.D” message is displayed, press up \blacktriangle key to select a higher range until a normal reading is displayed (or press **Auto** key for auto ranging). Use the lowest possible range for the best resolution.
6. Take readings from the display.

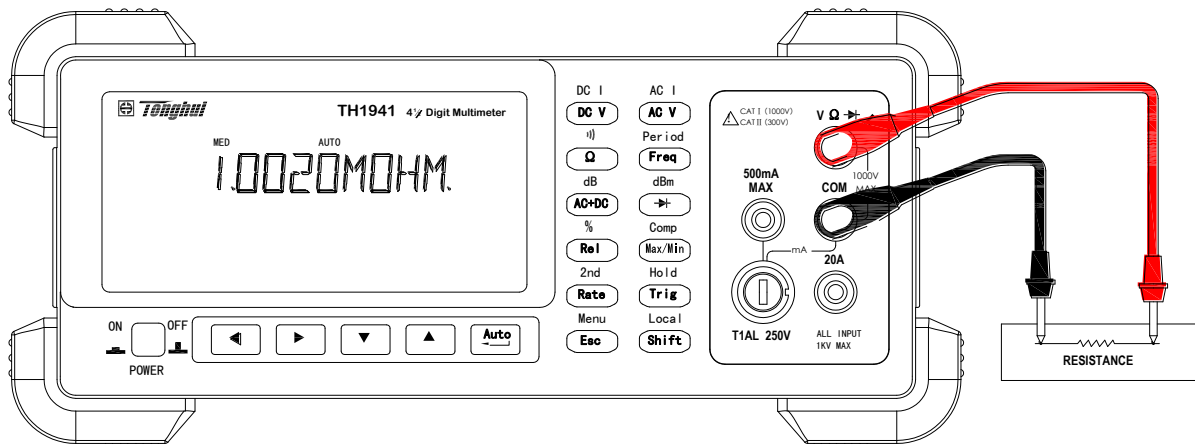

Note: Source current flows from the V Ω to COM terminals

Figure 3-3 Resistance Measurements

3.4.2 Shielding

To achieve a stable reading, it helps to shield resistances greater than 100k Ω . Place the resistance in a shielded enclosure and connect the shield to the COM terminal of the instrument electrically.

3.5 Measuring Frequency and Period

Model TH1941 frequency measurement range: 5 Hz to more than 1MHz.

Model TH1941 period measurement range: 0.2s to less than 1 μ s.

Input signal range: 200 mV AC to 750V AC.

The instrument uses the volts input terminals to measure frequency. The AC voltage range can be changed with the RANGE $\left[\blacktriangle \right]$ and $\left[\blacktriangledown \right]$ keys. However, the signal voltage must be greater than 10% of the full-scale range.

3.5.1 Trigger Level and Measurement Errors

Model TH1941 uses a technique which maintains a constant resolution for any input frequency to measure frequency and period. The gate time is always a multiple of the measured signal period rather than a fixed time. The error will be no more than ± 1 from the total gate counts, this assures an equivalent accuracy over the whole frequency range.

3.5.2 Gate Time

Gate time is the amount of time TH1941 uses to sample frequency or period readings. The measurement speed rate and the measuring frequency change the gate time.

3.5.3 Connections

Assuming Model TH1941 is under factory default conditions, the basic procedure is as follows:

1. Connect test leads to V Ω \rightarrow and COM terminals.
2. Select frequency or period measurement functions by pressing $\left[\text{Freq} \right]$ or $\left[\text{Shift} \right] \rightarrow \left[\text{Freq} \right]$
3. Connect test leads to the source as shown in Figure 3-4:

CAUTION: Do not exceed 1000V peak between V Ω \rightarrow and COM, or instrument damage may occur.

4. Taking a reading from the display

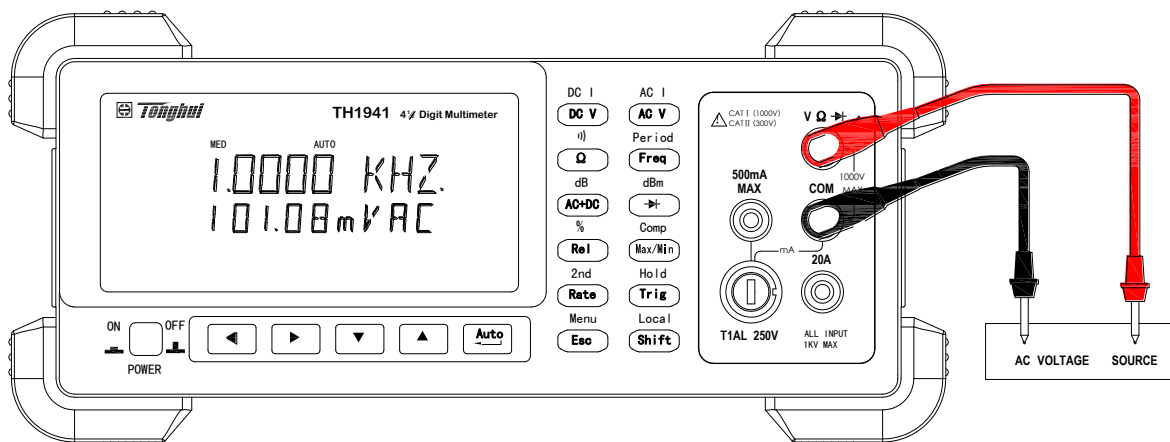

Frequency Measurement

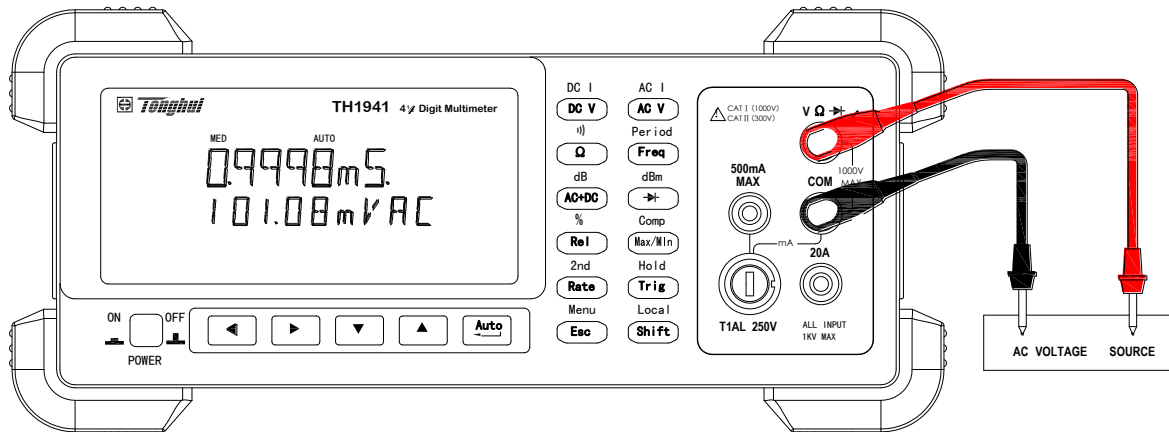

Period Measurement

Input Impedance = 1.1MΩ in parallel with 100pF

CAUTION: Maximum Input = 750V RMS or 1000V peak, 3×10^7 V-Hz

Figure 3-4 Frequency and Period Measurements

3.6 Measuring Continuity

Under continuity test, when 200Ω range is selected, the multimeter alerts you with a beep when a reading is below a threshold resistance level of 10Ω. For other ranges, the beeper will sound if a reading is below a threshold resistance level listed in table 3-1.

Table 3-1 Threshold resistance levels in Continuity Test

Measuring range	Beeper on
200.00Ω	<10Ω
2.0000KΩ	<100Ω
20.000KΩ	<1kΩ
200.00KΩ	<10kΩ
2.0000MΩ	<100kΩ
20.000MΩ	<1MΩ

3.6.1 Connections

Assuming Model TH1941 is under factory default conditions, the basic procedure is as follows:

1. Connect test leads to VΩ and COM terminals.
2. Select Continuity measurement function by pressing **Shift** → **Ω**.
3. Connect test leads to the resistance under test as shown in Figure 3-5.
4. Take a reading from the display

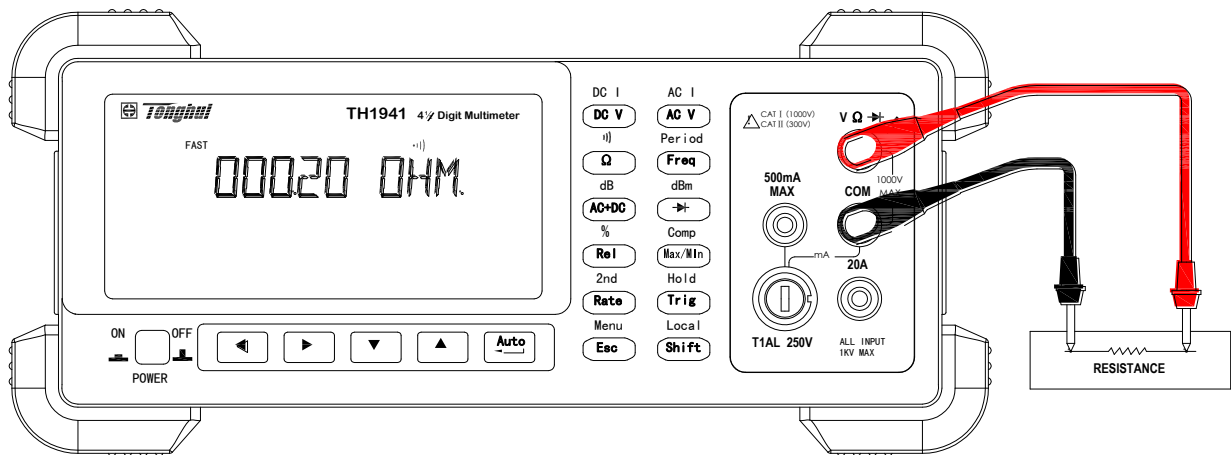

Note: Source current flows from the VΩ to COM terminals.

Figure 3-5 Continuity Measurement

3.7 Testing Diode

Model TH1941 can also be used to measure the forward voltage drop of general-purpose diodes and the zener voltage of zener diodes. A current range of 0.5mA will be selected for diode measurement.

Note: Diode test has a non-selectable reading rate of Medium

3.7.1 Connections

Assuming Model TH1941 is under factory default conditions, the basic procedure is as follows:

1. Connect test leads to VΩ and COM terminals.
2. Press for diode measurement function.
3. Connect test leads to the diode under test as shown in Figure 3-6.
4. Take a reading from the display.

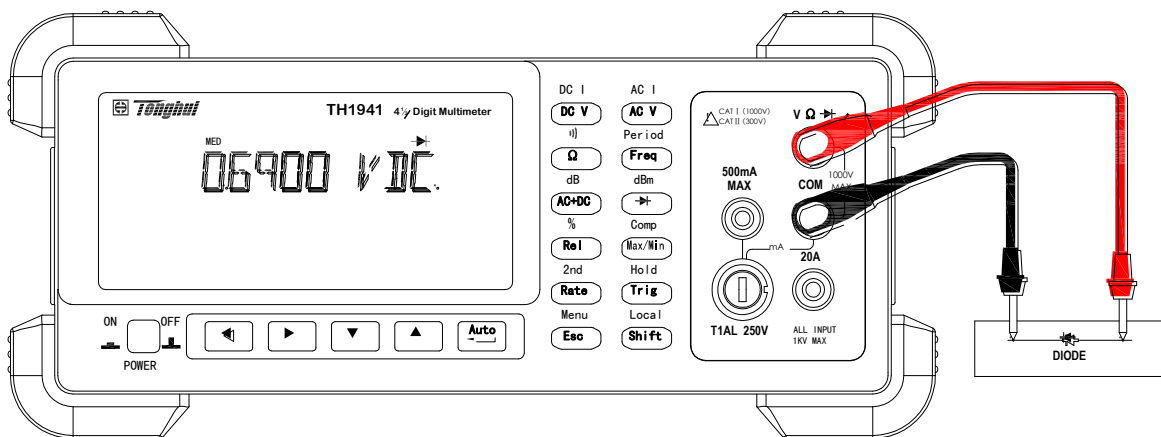

Note: Source current flows from the VΩ to COM terminals

Figure 3-6 Diode Measurement

3.8 Measuring True RMS AC+DC

Model TH1941 can measure the True RMS value of AC+DC voltages or currents.

When **AC+DC** is pressed, the multimeter will measure the dc and ac signals respectively then calculate and display the AC+DC RMS value by using the following formula:

$$(AC + DC)RMS = \sqrt{dc^2 + ac^2}$$

3.8.1 Connections

Assuming Model TH1941 is under factory default conditions, the basic procedure is as follows:

1. Connect test leads to **V Ω** and **COM** terminals, as shown in Figure 3-7.
2. Press **DCV**, **ACV**, **Shift** → **DCV** or **Shift** → **ACV** to select a voltage or current measurement
3. Press **AC+DC** for true RMS measurement function.
4. Press **Shift** + **Rate** to turn on a 2nd display
5. Press **Left** or **Right** to select a 2nd parameter available.
6. Take a reading from the display.

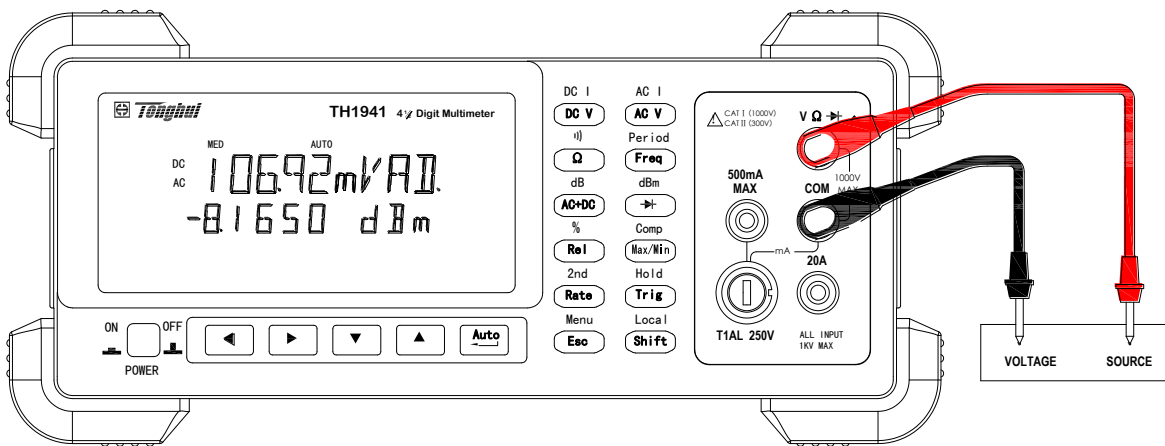

DC+AC RMS volt measurement

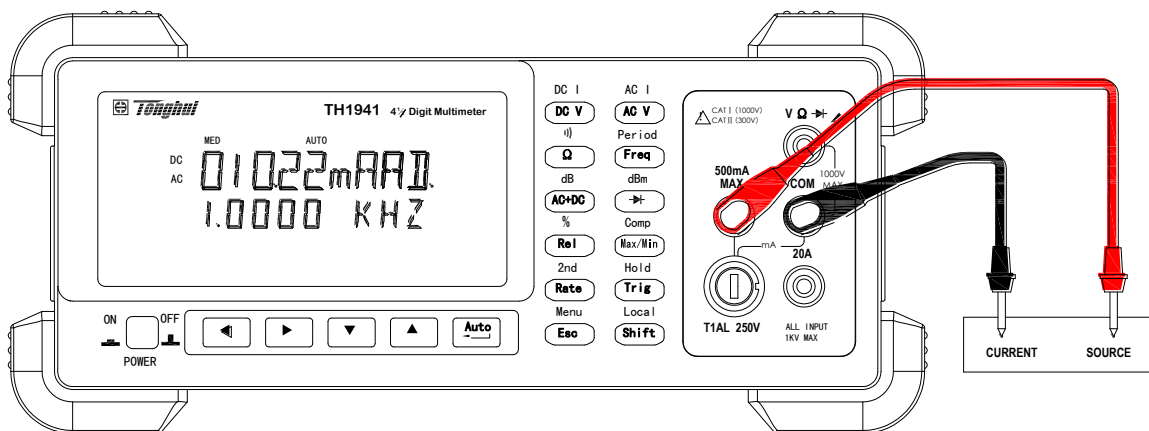

DC+AC RMS current measurement

Figure 3-7 True RMS value of AC+DC voltages and currents Measurement

3.8.2 Using the 2nd parameter display

The 2nd display is one of the useful features provided with the multimeter. User may read two different parameters at the same time..

The available 2nd display parameters under different main measurement functions are listed in Table 3-2.

Table 3-2 Available 2nd display parameters for different measurement functions

Primary Display	Secondary Display				
	▶ ◀				
DC V	AC V	dBm	dB	Hz	
AC V	DC V	dBm	dB	Hz	
DC V+AC V	dBm	dB	Hz	AC V	DC V
DC I	AC I	Hz			
AC I	DC I	Hz			
DC I+AC I	Hz	AC I	DC I		
Hz	AC V/AC I	AC I/AC V			
Percentage (%) (Measuring value)	%				
Comp (Measuring value)	HI, IN, LO, PASS, FAIL				
Max/Min (Measuring value)	Max		Min		

Note: The measurement range is determined by main measurement function when a 2nd parameter is displayed..

3.9 Math Functions

Model TH1941 math operations are divided into three categories:

- percent
- dB and dBm calculations
- Limit testing

The first two categories are discussed here; reading limit testing will be described in the next chapter – Measurement Options

3.9.1 Percent

If the percent calculation is selected, a reference value must be specified. The displayed reading will be expressed as percent deviation from the reference value. The percentage calculation is performed as follows:

$$\text{Percent} = \frac{\text{Input} - \text{reference}}{\text{reference}}$$

Where: Input is the normal display reading
Reference is the user-entered constant
Percent is the displayed result

To configure the percent calculation, perform the following steps:

1. Press $\boxed{\text{Shift}} \rightarrow \boxed{\text{Rel}}$ for percent math operation and the present reference value displays:
+1.00000 \wedge
2. Use $\boxed{\blacktriangleleft}$ and $\boxed{\blacktriangleright}$ keys to choose a numerical place and use $\boxed{\blacktriangleup}$ and $\boxed{\blacktriangledown}$ keys to increment or decrement the digits. Enter a value and units prefix.
3. Press $\boxed{\text{Auto}} \rightarrow \boxed{\text{Enter}}$ (ENTER) to confirm the reference value. The message "SAVED" will be displayed for a moment.
4. TH1941 will display the result of the percent calculation.

If you want to change the parameter values when the percent math function is enabled, besides the foregoing method you can take actions as below:

1. Press $\boxed{\text{Shift}} \rightarrow \boxed{\text{Esc}}$ to enter the menu on the menu level, "A: MATH MEU" will be displayed.
2. Press $\boxed{\blacktriangledown}$ to move down to the command level within the MATH MEU, "3: PERC REF" will be displayed.
3. Press $\boxed{\blacktriangledown}$ to enter the parameter level, and the present reference value will be displayed:
+1.00000 \wedge .
4. Use $\boxed{\blacktriangleleft}$ and $\boxed{\blacktriangleright}$ keys to choose a numerical place and use $\boxed{\blacktriangleup}$ and $\boxed{\blacktriangledown}$ keys to increment or decrement the digits. Enter a value and units prefix.
5. Press $\boxed{\text{Auto}} \rightarrow \boxed{\text{Enter}}$ (ENTER) to confirm the reference value, "SAVED" will be displayed for a moment, and TH1941 will return to the command level. Press $\boxed{\text{Esc}}$ to cancel the reference value input, TH1941 returns back to the command level without changing the reference value.
6. Press $\boxed{\text{Shift}} \rightarrow \boxed{\text{Esc}}$ key to exit the menu and return to the percent math operation status.

Model TH1941 will display measurement result of calculation. If the value of "Input" is larger than that of "Reference", displayed result will be positive; contrarily, it will be negative if the value of "Input" is smaller than that of "Reference".

3.9.2 dB Calculation

Expressing DC and AC voltage in dB makes it possible to compress a large range of measurements into a much smaller scope. The relationship between dB and voltage is defined by the following equation:

$$\text{dB} = 20 \log \frac{V_{IN}}{V_{REF}}$$

Where: V_{IN} is the DC or AC input signal.

V_{REF} is the specified voltage reference level

The instrument will read 0dB when the reference voltage level is applied to the input.

If a relative value is in effect when dB is selected, the value is converted to dB then REL is applied to dB. If REL is applied after dB has been selected, dB has REL applied to it.

To set the reference voltage, perform the following steps:

1. Press $\left[\text{Shift} \right] + \left[\text{AC+DC} \right]$ for dB math operation and the present reference value is displayed:
R.F: +0.00000
2. Use $\left[\blacktriangleleft \right]$ and $\left[\blacktriangleright \right]$ keys to choose a numerical place and use $\left[\blacktriangle \right]$ and $\left[\blacktriangledown \right]$ keys to increment or decrement the digits. Enter a value and units prefix.
3. Press $\left[\text{Auto} \right]$ (ENTER) to confirm the reference voltage, the message “**SAVED**” will be displayed for a moment. TH1941 returns back to the measurement status.
4. TH1941 will display the result of the dB calculation.

If you want to change the parameter values when dB function is in effect, you can take actions as below:

1. Press $\left[\text{Shift} \right] \rightarrow \left[\text{Esc} \right]$ to enter the menu on the menu level, “**A: MATH MEU**” will be displayed.
2. Press $\left[\blacktriangledown \right]$ to move down to the command level within the MATH MEU, “**4: dB REF**” will be displayed.
3. Press $\left[\blacktriangledown \right]$ to enter the parameter level, and the present reference value will be displayed:
R.F: +1.00000 λ .
4. Use $\left[\blacktriangleleft \right]$ and $\left[\blacktriangleright \right]$ keys to choose a numerical place and use $\left[\blacktriangle \right]$ and $\left[\blacktriangledown \right]$ keys to increment or decrement the digits. Enter a value and units prefix.
5. Press $\left[\text{Auto} \right]$ (ENTER) to confirm the reference value, the message “**SAVED**” will be displayed for a moment, and TH1941 will return to the command level. Press $\left[\text{Esc} \right]$ to cancel the reference value input, TH1941 returns back to the command level without changing the reference value.
6. Press $\left[\text{Shift} \right] \rightarrow \left[\text{Esc} \right]$ key to exit the menu and return to the dB math operation status.

Notes: *The dB calculation takes the absolute value of the ratio V_{IN}/V_{REF} . The largest negative value of dB is -160dB. This will accommodate a ratio of $V_{IN} = 1\mu V$, $V_{REF} = 1000V$.*

3.9.3 dBm Calculation

dBm is defined as decibels above or below a 1mW reference. With user-programmable reference impedance, Model TH1941 reads 0dBm when the voltage needed to dissipate 1mW through the reference impedance is applied. The relationship between dBm, reference impedance, and the voltage is defined by the following equation:

$$dBm = 10 \log \frac{(V_{IN}^2 / Z_{REF})}{1mW}$$

Where: V_{IN} is the DC or AC input signal.

Z_{REF} is the specified reference impedance.

If a relative value is in effect when dBm is selected, the value is converted to dBm then REL is applied to dBm. If REL is applied after dBm has been selected, dBm has REL applied to it.

To set the reference impedance, perform the following steps:

1. Press $\left[\text{Shift} \right] \rightarrow \left[\text{F} \right]$ for dBm math operation and the present reference value is displayed:
REF: 0000
2. Use $\left[\text{Left} \right]$ and $\left[\text{Right} \right]$ keys to choose a numerical place and use $\left[\text{Up} \right]$ and $\left[\text{Down} \right]$ keys to increment or decrement the digits. Enter a value from 1Ω to 9999Ω .
3. Press $\left[\text{Auto} \right]$ (ENTER) to confirm the reference impedance, the message “**SAVED**” will be displayed for a moment. TH1941 returns back to the measurement status.
4. TH1941 will display the result of the dBm calculation.

If you want to change the impedance reference value after the dBm function is enabled, you can take actions as below:

1. Press $\left[\text{Shift} \right] \rightarrow \left[\text{Esc} \right]$ to enter the menu on the menu level, “**A: MATH MEU**” will be displayed.
2. Press $\left[\text{Down} \right]$ to move down to the command level within the MATH MEU, “**5: dBm REF**” will be displayed.
3. Press $\left[\text{Down} \right]$ to enter the parameter level and the present impedance reference value will be displayed: REF: 0000.
4. Use $\left[\text{Left} \right]$ and $\left[\text{Right} \right]$ keys to choose a numerical place and use $\left[\text{Up} \right]$ and $\left[\text{Down} \right]$ keys to increment or decrement the digits. Enter a value from 1Ω to 9999Ω .
5. Press $\left[\text{Auto} \right]$ (ENTER) to confirm the reference value, the message “**SAVED**” will be displayed for a moment, and TH1941 will return to the command level. Press $\left[\text{Esc} \right]$ to cancel the reference value input, TH1941 returns back to the command level without changing the reference value.
6. Press $\left[\text{Shift} \right] \rightarrow \left[\text{Esc} \right]$ key to exit the menu and return to the dB math operation status.

NOTES: *The reference impedance and input impedance mentioned in this chapter are totally different. Input impedance is inherent in the instrument and could not be changed via foregoing methods.*

dBm is valid for both positive and negative DC voltage.

The percent math operations are applied after the dBm or dB math.

Chapter 4 Measurement Options

This chapter provides description of the front panel features of TH1941. For those measurement options accessible only by a remote interface, refer to Chapter 5 and 6. This chapter is organized as follows:

- **Measurement Configuration** – Describes Ranging, Relative readings, Digits of Resolution and Measurement rate
- **Triggering operations** – Explains trigger sources
- **MAX and MIN operations** – Records the minimum and the maximum input signals
- **Limit operations** – Defines how to set reading limits
- **System Operations** – Provides details on Beep setup, Baud rate setup, Terminal character setup and key sound setup up

4.1 Measurement configuration

The following paragraphs discuss configuring multimeter for making measurement.



4.1.1 Range

You can let the multimeter automatically select the range using auto ranging or you can select a fixed range using manual ranging. Auto ranging is convenient because the multimeter automatically selects the appropriate range for each measurement. However, you can use manual ranging for faster measurements since the multimeter doesn't have to determine which ranging to use for each measurement. The multimeter returns back to auto ranging when power has been off or after a remote interface reset.

Maximum readings

The full scale readings for every range on each function are 5% over range except for the 1000VDC, 750VAC and diode test ranges.

Manual ranging





To select a range, simply press  or  key. The instrument changes one range per key press. The selected range is displayed for a moment.

If the instrument displays the “OVL.D” message on a particular range, select a higher range until an on-range reading is displayed. Use the lowest range possible without causing an overflow to ensure best accuracy and resolution.

Auto ranging

To enable auto ranging, press  key. The **AUTO** annunciator turns on when auto ranging is selected. While auto ranging is selected, the instrument automatically chooses the best range to measure the applied signal. However, auto ranging should not be used when optimum speed is required.

Note that up-ranging occurs at 105% of normal range and down-ranging occurs at 5% of normal range.

To cancel auto ranging, press  or  or  key. Pressing  to cancel auto ranging leaves the instrument on the present range.

The  key has no effect on the continuity and diode test functions.

4.1.2 Relative



The relative operation could be used to null offsets or subtract a baseline reading from present and future readings. When relative function is enabled, Model TH1941 uses the present reading as a relative value. Subsequent readings will be the difference between the actual input value and the relative value.

You can define a relative value for each function. Once a relative value is set for a measurement function, the value is the same for all ranges. For example, if 2V is set as a relative value on the 20V range, the relative is also 2V on the 1000V, 100V, 1V or 100mV ranges.

Additionally, when you perform a zero correction for DCV, Ω measurements by enabling REL, the displayed offset becomes the reference value. Subtracting the offset from the actual input zeroes the display, as follows:

$$\text{Displayed reading} = \text{Actual Input} - \text{Reference}$$

Select a range that cannot accommodate the relative value does not cause an overflow condition, but it also does not increase the maximum allowable input for that range. For example: on the 2V range, Model TH1941 still overflows for a 2.1V input.

To set a REL value, press  when the display shows the value you want as the relative value. The REL annunciator turns on. Press  a second time to disable REL.

4.1.3 Rate

The RATE operation sets the integration time of the A/D converter, the period of time the input signal is measured. The integration time affects the usable digits, the amount of reading noise, as well as the ultimate reading rate of the instrument.

In general, the fastest integration time (FAST set from the front panel or remote interface) results in increased reading noise and fewer usable digits, while the slowest integration time provides the best common-mode and normal-mode rejection. In-between settings are a compromise between speed and noise.

The RATE parameters are explained as follows:

Fast

FAST sets speed to 25 readings per second. Use FAST, if speed is of primary importance, however it is at the expense of increased reading noise and fewer usable digits.

Medium

Medium sets speed to 10 readings per second. Use Medium when a compromise between noise

performance and speed is acceptable.

Slow

Slow sets speed to 5 readings per second. SLOW provides better noise performance at the expense of speed.

Note: *The integration time can be set for any measurement function except frequency, period, continuity (FAST) and diode test (Medium). For frequency and period, this value is little excess a gate time.*

4.2 Trigger Operations

The multimeter's triggering system allows you to generate triggers either manually or automatically or externally and take multiple readings per trigger. The following paragraphs discuss front panel triggering, and the reading hold feature.

4.2.1 Trigger procedure

Wait for Trigger



The control source holds up operation until the programmable event occurs and is detected. See description below for trigger sources:

- Immediate











With this trigger source, event detection is immediately satisfied allowing operation to continue.

- External

Event detection is satisfied for both kinds of triggers as below:

1. A bus trigger (*TRG) command is received.
2. The front panel  key is pressed (TH1941 must be taken out of remote before it will respond to  key).

Take steps below for trigger settings:

1. Press  →  to enter the menu on the menu level, "A: MATH MEU" will be displayed.
2. Use  or  key to move across to the TRIG MEU on the menu level, "B: TRIG MEU" will be displayed.
3. Press  to move down to the command level within the TRIG MEU.
4. Use  or  key to move across to the TRIG MODE command on the command level, "1: TRIG MOD" will be displayed.
5. Press  to move down a level to select a trigger source.
6. Using  or  to select IMM, MAN or BUS trigger source.
7. Press  (ENTER) to confirm the choice. The message "SAVED" will be displayed to show that the change is now in effect. TH1941 automatically exits the parameter level and moves up a level to the command level.

Measurement Sample

The primary measurement sample action is a measurement. However, the measurement sample action block could include the following additional actions:

Hold — with hold enabled, the first processed reading becomes the "Seed" reading and operation loops back within the measurement sample block. After the next reading is processed, it is checked to see if it

is within the selected window (0.01%, 0.1%, 1% and 10%) of the “seed” reading. If the reading is within the window, operation again loops back within the measurement sample block. This looping continues until the specified number (2 – 100) consecutive readings are within the window. If one of the readings is not within the window, the instrument acquires a new “seed” reading and the hold process continues.

4.2.2 Reading Hold

When a hold reading is acquired as described in “Measurement Sample”, an audible beep is sounded (if enabled) and the reading is considered a “true measurement”. The reading is held on the display until an “out of window” reading occurs to restart the hold process. The reading hold feature allows you to capture and hold a stable reading on the display.

Take steps below to enable and set reading hold function.

1. Press **[Shift]** + **[Trig]** to enable reading hold function
2. Press **[Shift]** → **[Esc]** to enter the menu on the menu level, “**A: MATH MEU**” will be displayed.
3. Use **[◀]** or **[▶]** key to move across to the TRIG MEU on the menu level, “**B: TRIG MEU**” will be displayed.
4. Press **[▼]** to move down to the command level within the TRIG MEU, “**1: TRIG MOD**” will be displayed.
5. Use **[◀]** or **[▶]** to select “**2: HOLD WIN**”.
6. Press **[▼]** to move down to the command level within the **HOLD WIN**”.
7. Use **[◀]** or **[▶]** key to select a window percentage (0.01%, 0.1%, 1%, 10%).
8. Press **[Auto]** (ENTER) to confirm the selection. The message “**SAVED**” will be displayed to show that the change is now in effect. TH1941 automatically exits the parameter level and moves up a level to the command level.
9. Use **[▶]** to move across to the **TRIG MOD** command on the command level, “**3: HOLD CNT**” will be displayed.
10. Press **[▼]** to move down a level to enter a count value. (Default count is 5)
11. Use **[◀]** and **[▶]** keys to choose a numerical place and use **[▲]** and **[▼]** keys to increment or decrement the digits. Enter a value of count (from 2 to 100).
12. Press **[Auto]** (ENTER) to confirm the count. The message “**SAVED**” will be displayed to show that the change is now in effect. TH1941 will exit the parameter level and move up a level to the command level.
13. Press **[Shift]** → **[Esc]** key to exit from the menu and return to the measurement status.

4.3 MAX / MIN

“**MAX / MIN**” function enables TH1941 to record the minimum and the maximum readings .If “**MAX / MIN**” function is enabled, the 2nd parameter indicates the latest maximum or minimum reading .

Use the following procedure to turn on the turn on the **MAX / MIN** operation:

1. Press **[Max/Min]** to enable the **MAX / MIN** function
2. Use **[◀]** or **[▶]** key to switch between MAX and MIN.
3. Press **[Max/Min]** key again to disable the MAX/MIN function.

4.4 Limit Operations

Limit operations set and control the values that determine the HI / IN / LO status of subsequent measurements. Limits can be applied to all measurement functions except continuity. The limit test is performed after percent math operations. Unit prefixes are applied before the limit test, for example:

Low Limit = -1.0, High Limit = 1.0
A 150mV reading equals 0.15V (IN).

Low Limit = -1.0, High Limit = 1.0
A 0.6k Ω reading equals 600 Ω (HI)

You can configure the multimeter to beep or not when readings are outside of the limit range.

4.4.1 Enabling limits

Use the following procedure to turn on the limit operation:

1. Press **[Shift]** → **[Max/Min]** to enable or disable LIMIT TEST function.

4.4.2 Setting Limit Values

Use the following steps to enter high and low limit values:

1. Press **[Shift]** → **[Esc]** to enter the menu on the menu level.
2. Use **[Left]** or **[Right]** key to move across to the MATH MEU on the menu level, "**A: MATH MEU**" will be displayed.
3. Press **[Down]** to move down to the command level within the MATH MEU.
4. Use **[Left]** or **[Right]** key to move across to the HIGH LIMIT command, "**1: HI LIMIT**" will be displayed.
5. Press **[Down]** to move down a level to input the high limit value. The present high limit value will be displayed:

HI: +1.00000 Δ

6. Use **[Left]** and **[Right]** keys to choose a numerical place and use **[Up]** and **[Down]** keys to increment or decrement the digits. Enter an expected value for high limit.
7. Press **[Auto]** (ENTER) to confirm the value of high limit. The message "**SAVED**" will be displayed to show that the change is now in effect. TH1941 will exit the parameter level and move up a level to the command level.
8. Use **[Left]** or **[Right]** key to move across to the LOW LIMIT command, "**2: LO LIMIT**" will be displayed.
9. Press **[Down]** to move down a level to input the low limit value. The present low limit value will be displayed:

LO: -1.00000 Δ

10. Use **[Left]** and **[Right]** keys to choose a numerical place and use **[Up]** and **[Down]** keys to increment or decrement the digits. Enter an expected value for low limit.
11. Press **[Auto]** (ENTER) to confirm the value of low limit. The message "**SAVED**" will be displayed to show that the change is now in effect. TH1941 will exit the parameter level and move up a level to the command level.
12. Press **[Shift]** → **[Esc]** key to exit from the menu and return to the measurement status.

4.5 System Operations

Model TH1941 has some other operations: Beeper control, key sound control, Baud rate control and Terminal character setup. The information is not directly related to making measurements but is an important part of operating the multimeter.

4.5.1 Beeper Control

Normally, the multimeter will emit a tone whenever certain conditions are met. For example: the multimeter will beep when a stable reading is captured in reading hold. You may want to disable the beeper for certain applications.

- When you disable the beeper, the multimeter will not emit a tone when:
 1. A limit is exceeded in a limit test
 2. A stable reading is captured in reading hold.
- Disabling the beeper has no effect on the tone generated when:
 1. An internal error is generated.
 2. The continuity threshold is exceeded.
 3. A front panel key is pressed.
- The beeper state is stored in non-volatile memory and does not change when power has been off or after a reset. The beeper is enabled when the multimeter is shipped from the factory.

Use the following steps to change the beeper's state:

1. Press **[Shift]** → **[Esc]** to enter the menu on the menu level, "**A: MATH MEU**" will be displayed.
2. Use **[Left]** or **[Right]** key to move across to the SYS MEU on the menu level, "**C: SYS MEU**" will be displayed.
3. Press **[Down]** to move down to the command level within the SYS MEU.
4. Use **[Left]** or **[Right]** key to move across to the BEEP command, "**1: BEEP STR**" will be displayed.
5. Press **[Down]** to move down a level to set the beeper control.
6. Use **[Left]** or **[Right]** key to select ON or OFF.
7. Press **[Auto]** (ENTER) to confirm the beeper control. The message "SAVED" will be displayed to show that the change is now in effect. TH1941 will exit the parameter level and move up a level to the command level.
8. Press **[Shift]** → **[Esc]** key to exit from the menu and return to the measurement status.

4.5.2 Baud rate

The baud rate is the rate at which Model TH1941 digital multimeter and the computer communicate. Choose one of these available rates:

- 38.4k
- 19.2k
- 9600
- 4800
- 2400
- 1200
- 600

Note: *Factory default baud rate is 9600.*

Before you choose a baud rate, make sure the programming terminal that you are connecting to the TH1941 can support the baud rate you selected. Both the digital multimeter and the other device must be configured for the same baud rate.

Perform the following steps to select a baud rate

1. Press **Shift** → **Esc** to enter the menu on the menu level, "**A: MATH MEU**" will be displayed.
2. Use **Left** or **Right** key to move across to the SYS MEU on the menu level, "**C: SYS MEU**" will be displayed.
3. Press **Down** to move down to the command level within the SYS MEU, "**1: BEEP STR**" will be displayed.
4. Use **Left** or **Right** key to move across to the baud rate command, "**2: BAUD RAT**" will be displayed.
5. Press **Down** to move down a level to set the baud rate.
6. Use **Left** or **Right** key to select a baud rate.
7. Press **Auto** (ENTER) to confirm the selection. The message "**SAVED**" will be displayed to show that the change is now in effect. TH1941 will exit the parameter level and move up a level to the command level.
8. Press **Shift** → **Esc** key to exit from the menu and return to the measurement status.

4.5.3 Selecting the Terminal Character

The instrument has two kinds of terminal characters: <LF> and <CR>.

Perform the following steps to select the terminal characters:

1. Press **Shift** → **Left** to enter the menu on the menu level, "**A: MATH MEU**" will be displayed.
2. Use **Left** or **Right** key to move across to the SYS MENU on the menu level, "**C: SYS MEU**" will be displayed.
3. Press **Down** to move down to the command level within the SYS MEU, "**1: BEEP STR**" will be displayed.
4. Use **Left** or **Right** key to move across to the terminal character command, "**3: TX TERM**" will be displayed.
5. Press **Down** to move down a level to set the terminal character.
6. Use **Left** or **Right** key to select a terminal character.
7. Press **Auto** (ENTER) to confirm the selection. The message "**SAVED**" will be displayed to show that the change is now in effect. TH1941 will exit the parameter level and move up a level to the command level.
8. Press **Shift** → **Esc** key to exit from the menu and return to the measurement status.









4.5.4 Key Sound

To avoid mis-operation, Model TH1941 has key sound function and you can enable or disable it. Factory default setting is enabled. The key sound state is stored in non-volatile memory and does not change when power has been off of after a reset.

Use following steps for key sound setting:

1. Press **Shift** → **Esc** to enter the menu on the menu level, "**A: MATH MEU**" will be displayed.
2. Use **Left** or **Right** key to move across to the SYS MEU on the menu level, "**C: SYS MEU**" will be

displayed.

3. Press  to move down to the command level within the SYS MEU, “1: BEEP STR” will be displayed.
4. Use  or  key to move across to the KEY SONG command, “4: KEY SONG” will be displayed.
5. Press  to move down a level to enable or disable the key sound.
6. Use  or  key to turn ON or turn OFF the key sound.
7. Press  (ENTER) to confirm the selection. The message “**SAVED**” will be displayed to show that the change is now in effect. TH1941 will exit the parameter level and move up a level to the command level.
8. Press  →  key to exit from the menu and return to the measurement status.

Chapter 5 Remote Operation

Besides the front panel control, TH1941 supports RS-232 serial interface for remote control. Standard Commands for Programmable Instruments (SCPI) is fully supported to communicate with computer via the RS-232 interfaces, with a certain communication protocols.

5.1 RS-232

You can connect RS-232 interface with a computer. Some considerations will draw your attention:

- You must define the baud rate
- You must use the SCPI programming language

5.2 RS-232 Interface Operation

The instrument provides various remote commands. All operations from the front panel can be performed by a computer via the RS-232 interface.

5.2.1 RS-232 Connection

RS232C standard now is widely used as the serial communication standard. RS232 stands for Recommend Standard number 232 and C is the latest revision of the standard.

The serial ports on most instruments use a subset of the RS232C standard. The full RS232C standard specifies a 25-pin “D” connector of which 22 pins are used. Most of these pins are not needed for normal serial communications, and the common RS232 signals are listed in Table 5-1:

Table 5-1 Signal Definition for 9 Pin Connector

Function	Code	9 Pin Connector Pin Number
Request To Send	RTS	7
Clear To Send	CTS	8
Data Set Ready	DSR	6
Data Carrier Detect	DCD	1
Data Terminal Ready	DTR	4
Transmitted Data	TXD	3
Received Data	RXD	2
Signal Ground Common	GND	5

TH1941's serial port uses the transmit (TXD), receive (RXD), and signal ground (GND) lines of the RS232 standard. It does not use the hardware handshaking lines CTS and RTS. TH1941 only uses the smallest subset of the RS232C standard, the signals are listed in Table 5-2.

Table 5-2 Signal Definition for 9 Pin Connector

Function	Code	9 Pin Connector Pin Number
Transmitted Data	TXD	3
Received Data	RXD	2
Signal Ground Common	GND	5

Figure 5-1 shows the rear panel connector for the RS232 interface.



Figure 5-1 Rear Panel RS232 Interface

Connection between TH1941 and a computer shown as Figure 5-2:

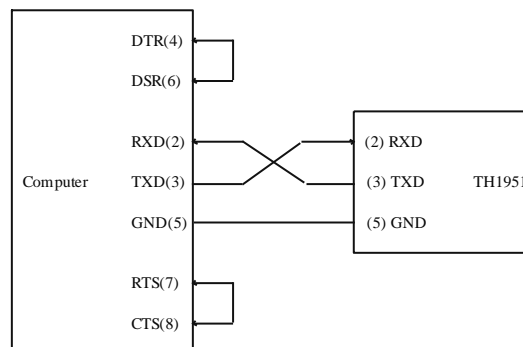

Figure 5-2 RS-232 Connection Sketch

There may be some difference between TH1941 RS232 interface and a standard RS232C interface. You can make the connection cable by yourself according to the diagram or order one from our company.

Note: Pin 4 and 6, pin 7 and 8 are shorted respectively at the end of controller.

5.2.2 Sending and receiving data

Model TH1941 transfers data using 8 data bits, 1 stop bit, and no parity. Each program message that is transmitted to the controller is terminated with <LF> or <CR>.

5.2.3 Selecting Baud Rate

The baud rate is the rate at which Model TH1941 multimeter and the computer communicate. Choose one of these available rates:

- 38.4k
- 19.2k
- 9600
- 4800
- 2400
- 1200
- 600

Note: *Factory default baud rate is 9600.*

Before you choose a baud rate, make sure the programming terminal that you are connecting to the TH1941 can support the baud rate you selected. Both the multimeter and the other device must be configured for the same baud rate.

Perform the following steps to select a baud rate:

1. Press **Shift** → **Esc** to enter the menu on the menu level, "**A: MATH MEU**" will be displayed.
2. Use **Left** or **Right** key to move across to the SYS MEU on the menu level, "**C: SYS MEU**" will be displayed.
3. Press **Down** to move down to the command level within the SYS MEU, "**1: BEEP STR**" will be displayed.
4. Use **Left** or **Right** key to move across to the BAUD RATE command, "**2: BAUD RAT**" will be displayed.
5. Press **Down** to move down a level to set the baud rate.
6. Use **Left** or **Right** key to select a baud rate.
7. Press **Auto** (ENTER) to confirm the selection. The message "**SAVED**" will be displayed to show that the change is now in effect. TH1941 will exit the parameter level and move up a level to the command level.
8. Press **Shift** → **Esc** key to exit from the menu and return to the measurement status.

5.2.4 Software Protocol

Since the hardware handshaking lines CTS and RTS are not used by TH1941, the multimeter uses the character return method to decrease the data losses and errors during communication. Please refer to the content below before programming communication software.

1. For command syntax and format, refer to Chapter 6 Command Reference.
2. The controller transmits the command using the ASCII code with <LF> or <CR> as the terminal character. TH1941 executes the command after the terminal character is received.
3. The character received by TH1941 will be sent back to the controller again. The controller will not send the next character until the last returned character is received correctly from TH1941. If the controller fails to receive the character sent back from TH1941, the possible reasons are listed as follows:

- The serial interface is not connected correctly.
 - Check if the same baud rate is selected for both TH1941 and the controller.
 - When TH1941 is busy with executing a bus command, TH1941 will not accept any character from the serial interface at the same time. So the character sent by controller will be ignored. In order to make sure the whole command is sent and received correctly, the character without a return character should be sent again by the controller.
4. TH1941 only sends information under following two conditions. The first is when a character is received normally; TH1941 will send the character back as a handshake. The second is when a query command is received; TH1941 will send the query response information.
 5. Once a query command is received, TH1941 will send the query response information immediately even if the rest commands have not been finished. So if the command includes two queries, the controller should read the query responses twice. One query is recommended to be included in a single command.
 6. A query response is sent out in ASCII codes with the preset terminal character.
 7. Several query responses will be sent continuously with 1ms interval. The controller should be ready to receive the responses; otherwise the response information will be lost.
 8. The controller should receive the query response terminal character. Otherwise you will confuse a terminal character with a returned character. At the same time the controller should receive the last returned character before receiving a query response.
 9. For some commands that will take a long time to execute, for example reset command, the controller should keep waiting to avoid the next command being lost when TH1941 is executing the former command.

Please refer to Chapter 8 for serial interface program examples.

5.3 Data Format

TH1941 outputs the measurement results using the ASCII character string format via the RS232 serial interface. The data format is described in the following Figure 5-3.

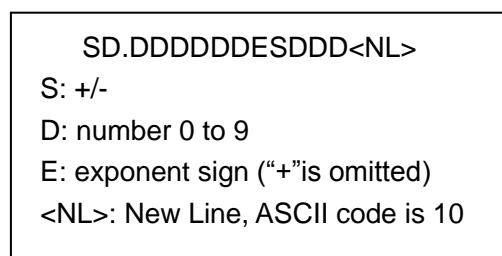

Figure 5-3 Data Format

Chapter 6 SCPI Command Reference

This chapter provides descriptions of all TH1941's available RS232 commands which correspond to Standard Commands for Programmable Instruments (SCPI) command sets. Use this chapter as a reference.

6.1 Command structure

TH1941 commands are divided into two types: common commands and SCPI commands. The common commands are defined in IEEE std. 488.2-1987, and these commands are common for all devices. Not all commands are supported by the TH1941. The SCPI commands are used to control all of the TH1941's functions. The SCPI commands are tree structured three levels deep. (The highest level commands are called the subsystem commands in this manual.) So the lower level commands are legal only when the subsystem commands have been selected. A colon (:) is used to separate the higher level commands and the lower level commands. See Figure 6-1 for a sample.

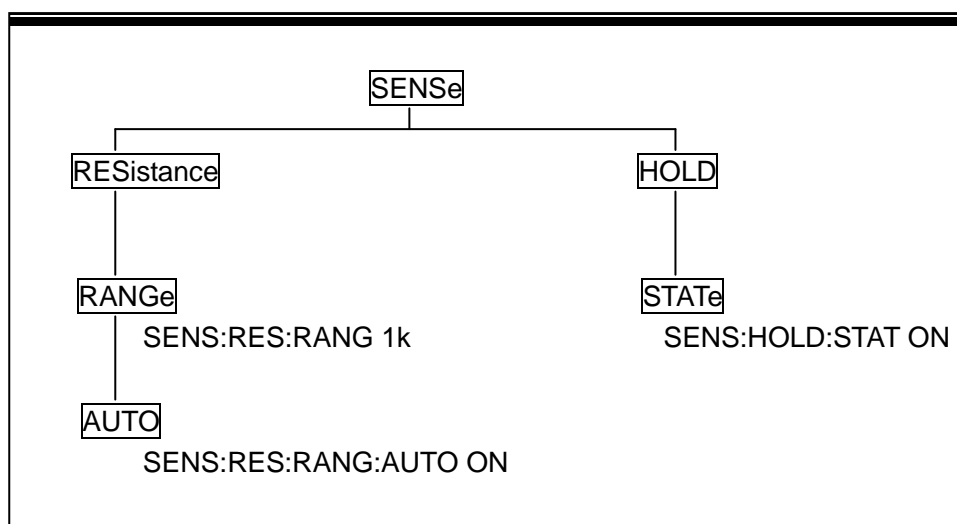

Figure 6-1 Command Tree Example

6.2 Command Syntax

The information in this section covers the syntax for both common commands and SCPI commands.

6.2.1 Commands and command parameters

Common commands and SCPI commands may or may not use a parameter. The following are some examples:

*RST	No parameter used
:FORMat <name>	Parameter<name> required
:IMMediate	No parameter used

Put at least one space between the command word and the parameter.

- Brackets []: Some command words are enclosed in brackets. These brackets are used to denote an optional command word that does not need to be included in the program message. For example:

:RANGe[:UPPer] <n>

These brackets indicate that :UPPer is optional and does not have to be used. Thus, the above command can be sent in one of the two ways below:

:RANGe <n>
or :RANGe:UPPer <n>

NOTICE: When using optional command words in your program, do not include the brackets.

- Angel brackets <>: Angle brackets are used to denote a parameter type. Do not include the brackets in the program message. For example:

:HOLD:STATe

The indicates that a Boolean-type parameter is required. Thus, to enable the HOLD feature, you must send the command with ON or 1 parameter as below:

:HOLD:STATe ON
or :HOLD:STATe 1

- Parameter types: The following are some of the more common parameter types:
 Boolean: Used to enable or disable an instrument operation. 0 or OFF disables the operation and 1 or ON enables the operation. Example:

:CURRent:AC:RANGe:AUTO ON Enable auto ranging

<name> Name parameter: Select a parameter name from a listed group. Example:

<name> = MOVing
REPeat

:RESistance:AVERage:TCONtrol MOVing

<NRf> Numeric Representation format: This parameter is a number that can be expressed as an integer (e.g., 6), a real number (e.g., 25.3) or an exponent (e.g., 5.6E2). Example:

:MMFactor 5

<n> Numeric value: A numeric value parameter can consist of a NRf number or one of the following name parameters: DEFault, MINimum, MAXimum. When DEFault parameter is used, the instrument is programmed to the *RST default value. When the MINimum parameter is used, the instrument is programmed to the lowest allowable value. When the MAXimum parameter is used, the instrument is programmed to the largest allowable value. Examples:

```
:CURRent[:DC]:NPLCycles 1
:CURRent[:DC]:NPLCycles DEFault
:CURRent[:DC]:NPLCycles MINimum
:CURRent[:DC]:NPLCycles MAXimum
```

6.2.2 Short-form Rules

Use the following rules to determine the short-form version of any SCPI command:

- If the length of the command word is four letters or less, no short form version exists. Example:
:AUTO =:AUTO
- These rules apply to command words that exceed four letters:
- If the fourth letter of the command word is a vowel, delete it and all the letters after it. Example:
:immediate =:imm
- Rule exception – The short form version of the following command uses only the first two letters of the word.
:TCouple = :tc
- If the fourth letter of the command word is a consonant, retain it but drop all the letters after it. Example:
:format = :form
- If the command contains a question mark (?; query) or a non-optional number included in the command word, you must include it in the short-form version. Example:
:delay? = :del?
- Command words or characters that are enclosed in brackets ([]) are optional and need not be included in the program message.

6.2.3 Basic Rules of Command Structure

- Letter case (upper and low) is ignored.
For example:
FUNC:VOLT:DC = func:volt:dc = Func:Volt:Dc
- Spaces (␣ is used to indicate a space) must not be placed before and/or after the colon (:).
For example:
(wrong) FUNC␣:␣VOLT:DC
(right) FUNC: VOLT:DC
- The command can be completely spelled out or in abbreviated type. (In the following description, short form will be printed in upper case.)
For example:
FUNCTION: VOLTAGE:DC = FUNC:VOLT:DC
- The command header should be followed by a question mark (?) to generate a query for that

command.

For example:

FUNC?

6.2.4 Multiple Command Rules

The semicolon (;) can be used as a separator to execute multiple commands on a single line. The multiple command rules are as follows.

- Commands at the same level and in the same subsystem command group can be separated by a semicolon (;) on a multiple command line.

For example:

:RESistance:NPLCycle <n>;NPLCycles ?

- To restart commands from the highest level, a semicolon (;) must be used as the separator, and then a leading colon (:), which shows that the restarted command is a command at the top of the command tree, must follow.

For example:

:RESistance:NPLCycle <n>; :RESistance:NPLCycles ?

- The common commands can restart only after a semicolon on a multiple command line.

For example,

:RESistance:NPLCycles<n>;*IDN?

6.2.5 Command Path Rules

- Each new program message must begin with the root command, unless it is optional (e.g., FUNCTION). If the root is optional, simply treat a command word on the next level as the root.
- The colon at the beginning of a program message is optional and need not be used. Example:
:DISPlay:ENABle = DISPlay:ENABle
- When the path pointer detects a colon(;), it moves down to the next command level.
- When the path pointer detects a colon (:) after a semicolon (;), it resets back to the root level.
- The path pointer can only move down. It cannot be moved up a level. Executing a command at a higher level requires that you start over at the root command.

6.3 Command Reference

Model TH1941 provides following subsystem commands:

◆ DISPlay ◆ FUNCtion ◆ VOLTage ◆ CURRent ◆ RESistance ◆ FREQuency
◆ PERiod ◆ HOLD ◆ TRIGer ◆ FETCh

Model TH1941 supports following common commands:

◆ *RST ◆ *TRG ◆ *IDN

6.3.1 DISPlay subsystem

The DISPlay subsystem commands are mainly used to control the display of the TH1941. and are summarized in Table 6-2.

Table 6-1 DISPlay Subsystem Commands Summary

Command	Function Description
:DISPlay :ENABle :ENABle?	Enable or disable front panel display Query state of the display

**:ENABle **

Command syntax:

:DISPlay:ENABle

Command Parameter:

 = 0 or OFF Disable front panel display
 1 or ON Enable front panel display

Query:

:ENABle? Query state of the display

Description:

This command is used to enable or disable front panel display circuitry. When disabled, the instrument operates at a higher speed. While disabled, the display is frozen. All front panel controls except LOCAL are disabled. Normal display operation can be resumed by using:ENABle command or pressing LOCAL key to enable the display.

6.3.2 FUNCTION subsystem

The commands in this subsystem are used to configure the measurement function subsystems and are summarized in Table 6-2.

Table 6-2 FUNCTION Subsystem Commands Summary

命令	功能简述
:FUNCTION <name>	Select measurement function : 'VOLTage:AC', 'VOLTage:DC', 'RESistance', 'FRESistance', 'CURRent:AC', 'CURRent:DC', 'FREQuency', 'PERiod', 'DIODE', 'CONTInuity'.
:FUNCTION?	Query function.

:FUNCTION Command

:FUNCTION <name>

Command syntax:

:FUNCTION <name>

Command Parameter:

<name> =	'VOLTage:AC'	Select AC Voltage
	'VOLTage:DC'	Select DC Voltage
	'CURRent:AC'	Select AC Current
	'CURRent:DC'	Select DC Current
	'RESistance'	Select 2-wire Resistance
	'FRESistance'	Select 4-wire Resistance
	'FREQuency'	Select Frequency
	'PERiod'	Select Period
	'DIODE'	Select Diode Testing
	'CONTInuity'	Select Continuity Testing

Query:

:FUNCTION? Query currently programmed function

Description:

This command is used to select the measurement function of the instrument. Note that the parameter names are enclosed in single quotes ('). However, double quotes (") can instead be used. For example:

```
:FUNC 'VOLT'= :FUNC "VOLT"
```

Each measurement function “remembers” its own unique setup configuration, such as range, speed, filter and rel. This eliminates the need to re-program setup conditions every time you switch from one function to another.

6.3.3 VOLTage subsystem

The commands in this subsystem are used to configure and control voltage measurement function and are summarized in Table 6-3.

Table 6-3 VOLTage Subsystem Commands Summary

Command	Function Description	Default
:VOLTage:DC :NPLCycles <n> :NPLCycles? :RANGe [:UPPer] <n> [:UPPer]? :AUTO :AUTO? :REFerence <n> :STATe :STATe? :ACQuire :REFerence?	Path to configure DC voltage Set integration rate (line cycle; 0.5 to 2) Query line cycle integration rate Path to configure measurement range Select range (0 to 1010) Query range Enable or disable auto range Query auto range Specify reference (-1010 to 1010) Enable or disable reference Query state of reference (0,1) Use input signal as reference. Query reference value	1 1000 ON 0 OFF
:VOLTage:AC :NPLCycles <n> :NPLCycles? :RANGe [:UPPer] <n> [:UPPer]? :AUTO :AUTO? :REFerence <n> :STATe :STATe? :ACQuire :REFerence?	Path to configure AC voltage Set integration rate (line cycles; 0.5 to 2) Query line cycle integration rate Path to set measurement range Select range (0 to 757.5) Query range Enable or disable auto range Query auto range specify reference (-757.5 to 757.5) Enable or disable reference Query state of reference Use input signal as reference Query reference value	1 757.5 ON 0 OFF

Speed Commands

: NPLCycles <n>

Command Syntax:

:VOLTage:AC:NPLCycles <n> Set NPLC for ACV
:VOLTage:DC:NPLCycles <n> Set NPLC for DCV

Command Parameter:

<n> = 0.5 to 2 Set power line cycles per integration
 DEFault 1

MINimum	0.5
MAXimum	2

Query:

:NPLCycles? Query programmed NPLC value

Description:

The integration period (measurement speed) for the basic measurement functions (except Frequency and Period) is set using the:NPLCycles command. NPLC(Number of Power Line Cycles) expresses the integration period by basing it on the power line frequency. For example, for a PLC of 1, the integration period in seconds would be 1/60 (for 60Hz line power) which is 16.67 msec.

:RANGe Commands

:[UPPer] <n>

Command syntax:

:VOLTage:AC:RANGe:[UPPer] <n> Set measurement range for ACV
 :VOLTage:DC:RANGe:[UPPer] <n> Set measurement range for DCV

Command Parameter:

<n> =	0 to 757.5	Expected reading is AC volts (ACV)
	0 to 1010	Expected reading is DC volts (DCV)
	DEFault	757.5 (ACV) 1000 (DCV)
	MINimum	0 (All functions)
	MAXimum	Same as DEFault

Query:

:RANGe:[UPPer]? Query measurement range of the current function.

Description:

This command is used to manually select the measurement range for the specified measurement function. The range is selected by specifying the expected reading as an absolute value. The instrument will then go to the most sensitive range that will accommodate that expected reading. For example, if you expect a reading of approximately 20mV, simply let the parameter (<n>) =0.02 (or 20e-3) in order to select the 200mV range.

:AUTO

Command syntax:

:VOLTage:AC:RANGe:AUTO Set auto range for ACV
 :VOLTage:DC:RANGe:AUTO Set auto range for DCV

Command parameter:

 =	1 or ON	Enable auto range
	0 or OFF	Disable auto range

Query:

:AUTO? Query auto range (ON or OFF)

Description:

These commands are used to control auto ranging. With auto ranging enabled, the instrument automatically goes to the most sensitive range to perform the measurement.

The auto range command (:RANGE:AUTO) is coupled to the command that manually selects the measurement range (:RANGE <n>). When auto range is enabled, the parameter value for :RANGE <n> changes to the automatically selected range value. Thus, when auto range is disabled, the instrument remains at the automatically selected range. When a valid :RANGE <n> command is sent, auto ranging disables.

:REFerence <n> Commands

:REFerence <n>

Command syntax:

:VOLTage:AC:REFerence <n>	Specify reference for ACV
:VOLTage:DC:REFerence <n>	Specify reference for DCV

Command parameter:

<n> =	-757.5 to 757.5	Reference for ACV
	-1010 to 1010	Reference for DCV
	DEFault	0 (All measurement functions)
	MINimum	Minimum value for specified function
	MAXimum	Maximum value for specified function

Query:

:REFerence? Query reference for relative function

Description:

These commands are used to establish a reference value for the specified function. When reference is enabled (:REFerence:STATE), the result will be the algebraic difference between the input signal and the reference value:

$$\text{Reading} = \text{Input signal} - \text{Reference}$$

From the front panel, reference is called relative (REL).

The:REFerence <n> command is coupled to the :ACQUIRE command. The last command sent (:REFerence <n> or :ACQUIRE) establishes the reference. When a reference is set using the:REFerence <n> command, the REFerence? Query command returns the programmed value. Conversely, when a reference is set using the:ACQUIRE command, the:REFerence? Query command returns the acquired reference value.

**:STATE **

Command syntax:

:VOLTage:AC:REFerence:STATe

Control reference for ACV

:VOLTage:DC:REFerence:STATe

Control reference for DCV

Command parameter:

 = 1 or ON

Enable reference

0 or OFF

Disable reference

Query:

:STATe?

Query state of reference.

Description:

These commands are used to enable or disable Reference for the specified function. When enabled, the displayed reading will include the programmed reference value. When disabled, the displayed reading will not include the reference value.

:ACQUIRE

Command syntax:

:VOLTage:AC:REFerence:ACQUIRE

Acquire reference for ACV

:VOLTage:DC:REFerence:ACQUIRE

Acquire reference for DCV

Description:

When one of these commands is sent, the measurement input signal is acquired and established as the reference value. This command is typically used to zero the display. For example, if the instrument is displaying a 1 μ V offset, sending this command and enabling Reference zeroes the display.

This command is functional only if the instrument is on the specified measurement function. Sending this command while in any other function causes an error. Also, if the latest reading is overflowed or a reading has not been triggered, an error occurs when this command is sent.

6.3.4 CURRent subsystem

The commands in this subsystem are used to configure and control current measurement function and are summarized in Table 6-4.

Table 6-4 CURRent Subsystem Commands Summary

Command	Function Description	Default
:CURRent:DC	Path to configure DC current	
:NPLCycles <n>	Set integration rate(line cycles; 0.5 to 2)	1
:NPLCycles?	Query line cycle integration rate	
:RANGe	Path to configure measurement range	
[:UPPer] <n>	Select range (0 to 20)	20
[:UPPer]?	Query range	
:AUTO 	Enable or disable auto range	ON
:AUTO?	Query auto range	
:REFerence <n>	Specify reference (-20 to 20)	0
:STATe 	Enable or disable reference	OFF
:STATe?	Query state of reference	
:ACQuire	Use input signal as reference	
:REFerence?	Query reference value	
:CURRent:AC	Path to configure AC voltage	
:NPLCycles <n>	Set integration rate (line cycles; 0.5 to 2)	1
:NPLCycles?	Query line cycle integration rate	
:RANGe	Path to set measurement range	
[:UPPer] <n>	Select range (0 to 20)	20
[:UPPer]?	Query range	
:AUTO 	Enable or disable auto range	ON
:AUTO?	Query auto range	
:REFerence <n>	specify reference (0 to 20)	0
:STATe 	Enable or disable reference	OFF
:STATe?	Query state of reference	
:ACQuire	Use input signal as reference	
:REFerence?	Query reference value	

Speed Commands

: NPLCycles <n>

Command Syntac:

- : CURRent:AC:NPLCycles <n> Set NPLC for ACI
- : CURRent:DC:NPLCycles <n> Set NPLC for DCI

Command Parameter:

- <n> = 0.1 to 10 Set power line cycles per integration

DEFault	1
MINimum	0.5
MAXimum	2

Query:

:NPLCycles? Query programmed NPLC value

Description:

The integration period (measurement speed) for the basic measurement functions (except Frequency and Period) is set using the:NPLCycles command. NPLC(Number of Power Line Cycles) expresses the integration period by basing it on the power line frequency. For example, for a PLC of 1, the integration period in seconds would be 1/60 (for 60Hz line power) which is 16.67 msec.

:RANGe Commands

:[UPPer] <n>

Command syntax:

: CURRent:AC:RANGe[:UPPer] <n> Set measurement range for ACI
 : CURRent:DC:RANGe[:UPPer] <n> Set measurement range for DCI

Command Parameter:

<n> =	0 to 20	Expected reading is AC volts (ACI)
	-20 to 20	Expected reading is DC volts (DCI)
DEFault	20 (ACI, DCI)	
MINimum	0 (All functions)	
MAXimum	Same as DEFault	

Query:

:RANGe[:UPPer]? Query measurement range of the current function.

Description:

This command is used to manually select the measurement range for the specified measurement function. The range is selected by specifying the expected reading as an absolute value. The instrument will then go to the most sensitive range that will accommodate that expected reading. For example, if you expect a reading of approximately 10mA, simply let the parameter (<n>) =0.01 (or 10e-3) in order to select the 20mA range.

**:AUTO **

Command syntax:

: CURRent:AC:RANGe:AUTO Set auto range for ACI
 : CURRent:DC:RANGe:AUTO Set auto range for DCI

Command parameter:

 =	1 or ON	Enable auto range
	0 or OFF	Disable auto range

Query:

:AUTO? Query auto range (ON or OFF)

Description:

These command are used to control auto ranging. With auto ranging enabled, the instrument automatically goes to the most sensitive range to perform the measurement.

The auto range command (:RANGe:AUTO) is coupled to the command that manually selects the measurement range (:RANGe <n>). When auto range is enabled, the parameter value for :RANGe <n> changes to the automatically selected range value. Thus, when auto range is disabled, the instrument remains at the automatically selected range. When a valid :RANGe <n> command is sent, auto ranging disables.

:REFerence <n> Commands

:REFerence <n>

Command syntax:

: CURRent:AC:REFerence <n>	Specify reference for ACI
: CURRent:DC:REFerence <n>	Specify reference for DCI

Command parameter:

<n> =	-20 to 20	Reference for ACI
	0 to 20	Reference for DCI
	Default	0 (All measurement functions)
	MINimum	Minimum value for specified function
	MAXimum	Maximum value for specified function

Query:

:REFerence? Query reference for relative function

Description:

These commands are used to establish a reference value for the specified function. When reference is enabled (:REFerence:STATe), the result will be the algebraic difference between the input signal and the reference value:

Reading = Input signal – Reference

From the front panel, reference is called relative (REL).

The:REFerence <n> command is coupled to the :ACQuire command. The last command sent (:REFerence <n> or :ACQuire) establishes the reference. When a reference is set using the:REFerence <n> command, the REFerence? Query command returns the programmed value. Conversely, when a reference is set using the:ACQuiry command, the :REFerence? Query command returns the acquired reference value.

**:STATE **

Command syntax:

: CURRent:AC:REFErence:STATe 	Control reference for ACI
: CURRent:DC:REFErence:STATe 	Control reference for DCI

Command parameter:

 = 1 or ON	Enable reference
0 or OFF	Disable reference

Query:

:STATE?	Query state of reference.
---------	---------------------------

Description:

These commands are used to enable or disable Reference for the specified function. When enabled, the displayed reading will include the programmed reference value. When disabled, the displayed reading will not include the reference value.

:ACQUIRE

Command syntax:

: CURRent:AC:REFErence:ACQUIRE	Acquire reference for ACI
: CURRent:DC:REFErence:ACQUIRE	Acquire reference for DCI

Description:

When one of these commands is sent, the measurement input signal is acquired and established as the reference value. This command is typically used to zero the display. For example, if the instrument is displaying a 10 μ A offset, sending this command and enabling Reference zeroes the display.

This command is functional only if the instrument is on the specified measurement function. Sending this command while in any other function causes an error. Also, if the latest reading is overflowed or a reading has not been triggered, an error occurs when this command is sent.

6.3.5 RESlister subsystem

The commands in this subsystem are used to configure and control resistance measurement function and are summarized in Table 6-5.

Table 6-5 RESlister Subsystem Commands Summary

Command	Function Description	Default
:RESistance	Path to configure resistance	
:NPLCycles <n>	Set integration rate (line cycles: 0.5 to 2)	1
:NPLCycles?	Query line cycle integration rate	
:RANGe	Path to configure measurement range	
[:UPPer] <n>	Select range (0 to 20e6)	20e6
[:UPPer]?	Query range	
:AUTO 	Enable or disable auto range	ON
:AUTO?	Query auto range	
:REFerence <n>	Specify reference (0 to 20e6)	0
:STATe 	Enable or disable reference	OFF
:STATe?	Query state of reference	
:ACQuire	Use input signal as reference	
:REFerence?	Query reference value	

Speed Commands

: NPLCycles <n>

Command Syntac:

:RESistance:NPLCycles <n> Set NPLC for Ω

Command Parameter:

<n> =	0.5 to 2	Set power line cycles per integration
DEFault	1	
MINimum	0.1	
MAXimum	10	

Query:

:NPLCycles? Query programmed NPLC value

Description:

The integration period (measurement speed) for the basic measurement functions (except Frequency and Period) is set using the:NPLCycles command. NPLC(Number of Power Line Cycles) expresses the integration period by basing it on the power line frequency. For example, for a PLC of 1, the integration period in seconds would be 1/60 (for 60Hz line power) which is 16.67 msec.

:RANGe Commands

:[UPPer] <n>

Command syntax:

:RESistance:RANGe[:UPPer] <n> Set measurement range for Ω

Command Parameter:

<n> =	0 to 20e6	Expected reading is ohms
	DEFault	20e6 (Ω)
	MINimum	0 (All functions)
	MAXimum	Same as DEFault

Query:

:RANGe[:UPPer]? Query measurement range of the current function.

Description:

This command is used to manually select the measurement range for the specified measurement function. The range is selected by specifying the expected reading as an absolute value. The instrument will then go to the most sensitive range that will accommodate that expected reading. For example, if you expect a reading of approximately 20 Ω , simply let the parameter (<n>) =20 in order to select the 200 Ω range.

**:AUTO **

Command syntax:

**:RESistance:RANGe:AUTO ** Set auto range for Ω

Command parameter:

 =	1 or ON	Enable auto range
	0 or OFF	Disable auto range

Query:

:AUTO? Query auto range (ON or OFF)

Description:

These commands are used to control auto ranging. With auto ranging enabled, the instrument automatically goes to the most sensitive range to perform the measurement.

The auto range command (:RANGe:AUTO) is coupled to the command that manually selects the measurement range (:RANGe <n>). When auto range is enabled, the parameter value for:RANGe <n> changes to the automatically selected range value. Thus, when auto range is disabled, the instrument remains at the automatically selected range. When a valid:RANGe <n> command is sent, auto ranging disables.

:REFerence <n> Commands

:REFerence <n>

Command syntax:

:RESistance:REFerence <n> Specify reference for Ω

Command parameter:

<n> =	0 to 20e6	Reference for Ω
DEFault	923107715guozhigang	0 (All measurement functions)
MINimum		Minimum value for specified function
MAXimum		Maximum value for specified function

Query:

:REFerence? Query reference for relative function

Description:

These commands are used to establish a reference value for the specified function. When reference is enabled (:REFerence:STATe), the result will be the algebraic difference between the input signal and the reference value:

Reading = Input signal – Reference

From the front panel, reference is called relative (REL).

The:REFerence <n> command is coupled to the :ACQuire command. The last command sent (:REFerence <n> or :ACQuire) establishes the reference. When a reference is set using the:REFerence <n> command, the REFerence? Query command returns the programmed value. Conversely, when a reference is set using the:ACQuiry command, the :REFerence? Query command returns the acquired reference value.

**:STATe **

Command syntax:

:RESistance:REFerence:STATe Control reference for Ω

Command parameter:

 =	1 or ON	Enable reference
	0 or OFF	Disable reference

Query:

:STATe? Query state of reference.

Description:

These commands are used to enable or disable Reference for the specified function. When enabled, the displayed reading will include the programmed reference value. When disabled, the displayed reading will not include the reference value.

:ACQuire

Command syntax:

:RESistance:REFerence:ACQuire Acquire reference for Ω

Description:

When one of these commands is sent, the measurement input signal is acquired and established as the reference value. This command is typically used to zero the display. For example, if the instrument is displaying a 0.1Ω offset, sending this command and enabling Reference zeroes the display.

This command is functional only if the instrument is on the specified measurement function. Sending this command while in any other function causes an error. Also, if the latest reading is overflowed or a reading has not been triggered, an error occurs when this command is sent.

6.3.6 FREQUENCY and PERIOD subsystem

The commands in this subsystem are used to configure and control frequency as well as period measurement function and are summarized in Table 6-6.

Table 6-6 FREQUENCY and PERIOD Subsystem Commands Summary

Command	Function Description	Default
:FREQUENCY :THRESHOLD :VOLTAGE :RANGE <n> :RANGE? :REFERENCE <n> :STATE :STATE? :ACQUIRE :REFERENCE?	Path to configure frequency Path to select the threshold voltage range: Select threshold range (0 to 750). Query threshold range Specify reference (0 to 1.0e6) Enable or disable reference Query state of reference Use input signal as reference Query reference value	20 0 OFF
:PERIOD :THRESHOLD :VOLTAGE :RANGE <n> :RANGE? :REFERENCE <n> :STATE :STATE? :ACQUIRE :REFERENCE?	Path to configure period Path to select the threshold voltage range: Select threshold range (0 to 750). Query threshold range Specify reference(0 to 1) Enable or disable reference Query state of reference Use input signal as reference Query reference value	20 0 OFF

:RANGE <n>

Command syntax:

- :FREQUENCY:THRESHOLD:VOLTAGE:RANGE <n> Set voltage threshold range.
- :PERIOD:THRESHOLD:VOLTAGE:RANGE <n> Set voltage threshold range.

Command parameter:

<n> = 0 to 1010 Specify signal levels in volts (voltage threshold)

Query:

:RANGe? Query maximum signal level.

Description:

These commands are used to specify the expected input level. The instrument will then automatically select the most sensitive current or voltage threshold range.

:REFerence <n> Commands

:REFerence <n>

Command syntax:

:FREQuency:REFerence <n> Specify reference for FREQ
:PERiod:REFerence <n> Specify reference for PER

Command parameter:

<n> =	
0 to 1.0e6	Reference for FREQ
0 to 1	Reference for PER
Default	0 (All measurement functions)
MINimum	Minimum value for specified function
MAXimum	Maximum value for specified function

Query:

:REFerence? Query reference for relative function

Description:

These commands are used to establish a reference value for the specified function. When reference is enabled (:REFerence:STATe), the result will be the algebraic difference between the input signal and the reference value:

Reading = Input signal – Reference

From the front panel, reference is called relative (REL).

The:REFerence <n> command is coupled to the :ACQuire command. The last command sent (:REFerence <n> or :ACQuire) establishes the reference. When a reference is set using the:REFerence <n> command, the REFerence? Query command returns the programmed value. Conversely, when a reference is set using the:ACQuiry command, the :REFerence? Query command returns the acquired reference value.

**:STATe **

Command syntax:

:FREQuency:REFerence:STATe Control reference for FREQ
:PERiod:REFerence:STATe Control reference for PER

Command parameter:

 = 1 or ON Enable reference
 0 or OFF Disable reference

Query:

:STATe? Query state of reference.

Description:

These commands are used to enable or disable Reference for the specified function. When enabled, the displayed reading will include the programmed reference value. When disabled, the displayed reading will not include the reference value.

:ACquire

Command syntax:

:FREQuency:REFerence:ACQuire Acquire reference for FREQ
 :PERiod:REFerence:ACQuire Acquire reference for PER

Description:

When one of these commands is sent, the measurement input signal is acquired and established as the reference value. This command is typically used to zero the display. For example, if the instrument is displaying a 10HZ offset, sending this command and enabling Reference zeroes the display.

This command is functional only if the instrument is on the specified measurement function. Sending this command while in any other function causes an error. Also, if the latest reading is overflowed or a reading has not been triggered, an error occurs when this command is sent.

6.3.7 HOLD subsystem

The commands in this subsystem are used to configure and control hold measurement function and are summarized in Table 6-7.

Table 6-7 HOLD Subsystem Commands Summary

Command	Function Description	Default
:HOLD	Path to control Hold feature:	
:WINDow <NRf>	Set Hold window(%); 0.01 to 10	1
:WINDow?	Query Hold window	
:COUNT <NRf>	Set Hold count; 2 to 100	5
:COUNT?	Query HOLD count	
:STATe <NRf>	Enable or disable HOLD	OFF
:STATe?	Query state of HOLD	

:HOLD Command

The following commands are used to configure and control the HOLD feature.

:WINDow <NRf>

Command syntax:

:HOLD:WINDow <NRf>

Command Parameter:

<NRf> = 0.01 to 10 Set window (percent)

Query:

:WINDow? Query Hold window

Description:

This command is used to set the window for HOLD. This window is expressed as a percent of the “seed” reading for the Hold process.

:COUNT <NRf>

Command syntax:

:HOLD:COUNT <NRf>

Command Parameter:

<NRf> = 2 to 100 Specify HOLD count

Query:

:COUNT? Query HOLD count.

Descripton:

This command is used to specify the count for HOLD. COUNT is the number of readings that are compared to the “seed” reading during the HOLD process.

**:STATe **

Command syntax:

:HOLD:STATe

Command Parameter:

 = 0 or OFF Disable HOLD
1 or ON Enable HOLD

Query:

:STATe? Query state of HOLD

Description:

This command is used to enable or disable HOLD.

6.3.8 TRIGger subsystem

These commands in this subsystem are used to configure and control trigger measurement function and are summarized in Table 6-8.

Table 6-8 TRIGger Subsystem Commands Summary

Command	Function Description	Default
:TRIGger :SOURce <name> :SOURce?	Select control source Query control source	IMMEDIATE

:TRIGger

TRIGger subsystem commands are used for the instrument settings of trigger mode, trigger delay and trigger a measurement.

:SOURce <name>

Command Syntax:

TRIGger:SOURce <name>

Command parameter:

<name> = IMMEDIATE instrument default setting is internal trigger)
 BUS Triggered via RS232 interface)
 MANual(EXTernal) (Press  in the front panel for Trigger)

Query:

:SOURce? Query control source)

Description:

These are used to select the event control source.

6.3.9 FETCH Subsystem

FETCh? Command

Command syntax:

:FETCh?

Description:

This query command is used to obtain the latest post-processed reading. This command does not affect the configuration of the instrument.

This command does not trigger a measurement. The command simply requests the last available reading. This command continues to return the same old reading, until there is a new reading.

This command will be automatically asserted when :READ? or :MEASure? command is sent.

6.3.10 Common Commands

Common commands can be used to all equipments. We provide some common commands as below:

***RST**

Command Syntax:

*RST

Description:

Reset the instrument

***TRG**

Command Syntax:

*TRG

Description:

Trigger the instrument for measurement

***IDN?**

Query Syntax:

*IDN?

Query return:

<product>,<version><LF^END>

Here:

<product> TH1941 Digital Multimeter

<version> Ver1.0

Description:

Query information returned to instrument

Chapter 7 Specifications

A-1 Introduction

Chapter 7 describes the complete specifications of the Model TH1941 Multimeter.

A-2 Technical Specifications

Specifications Assumptions

- One year calibration cycle.
- Operating temperature at 18°C to 28°C
- Accuracy is expressed as: \pm (% of reading + digits) after 30 minutes' warm-up.
- Temperature Coefficient: add \pm [0.1% \times (the applicable accuracy)/°C] for 0°C to 18°C and 28°C to 40°C;
- Relative Humidity: Up to 80% for 0°C to 28°C (75% RH for 10M Ω and above ranges of resistance measurement). Up to 70 for 28°C to 40°C.

Displayed Readings and Reading rates

Reading rates on front panel (Reading/sec, Approximate)

Measurement Function	Slow	Med	Fast
DCV	5	10	25
DCA	5	10	25
ACV	5	10	25
ACA	5	10	25
Ω (Ranges below 2M)	5	10	25
Ω (20M range and above)	1.3	2.6	5.6
Freq/ Period	1	2	3.9
Using dual display	0.9	0.9	0.8
True RMS DC+AC	1.2	1.4	1.5
Diode	_____	10	_____
Continuity	_____	_____	25

DC Voltage

Resolution, Full Scale reading and Accuracy

Rate	Range	Resolution	Full Scale Reading	Accuracy (1 year)	Typical Input Impedance
Slow	200.00mV	1 0μV	210.00	0.03%+0.04% ⁽¹⁾	>10MΩ
	2.0000 V	10 0μV	2.1000	0.03%+0.02% ⁽¹⁾	>11.1MΩ
	20.000V	1mV	21.000	0.03%+0.02%	>10.1MΩ
	200.00 V	10 mV	210.00	0.03%+0.02%	10MΩ
	1000.0 V	100 mV	1010.0 ⁽²⁾	0.03%+0.02%	10MΩ
⁽¹⁾ under REL status					
⁽²⁾ 1% over-range (1010V) is readable at 1000V range					

Maximum input voltage: 1000VDC or peak ac for all ranges.

AC Voltage

Resolution, Full Scale reading and Accuracy

Range	Resolution	Full Scale Reading
200.00 mV	10 μV	210.00
2.0000 V	100 μV	2.1000
20.000 V	1 mV	21.000
200.00 V	1 0mV	210.00
750.0 V	100 mV	757.5 ⁽¹⁾
⁽¹⁾ 1% over-range (757.50V) is readable at 750V range		

ACCURACY: ± (% of reading + % of range), 23°C±5°C。

Rate	Range	Accuracy(1 year) ⁽¹⁾ 23°C±5°C			
		20~50 Hz	50~20kHz	20~50kHz	50~100kHz
Slow	200.00mV	1.0%+0.2%	0.5%+0.15%	1.8%+0.25%	3.0%+0.75%
	2.0000 V	1.0%+0.2%	0.4%+0.05%	1.5%+0.1%	3.0%+0.25%
	20.000 V	1.0%+0.2%	0.4%+0.05%	1.5%+0.1%	3.0%+0.25%
	200.00 V	-----	0.8%+0.075%	1.5%+0.1%	3.0%+0.25%
	750.0 V	-----	0.8%+0.075%	1.5%+0.1% ⁽²⁾	3.0%+0.25% ⁽¹⁾
⁽¹⁾ Specifications are for SLOW rate and sinewave inputs >5% of range.					
⁽²⁾ Limit at 40KHZ or ≤3×10 ⁷ Volt-Hz for t 750V range					

Measurement method: True RMS measurement

Maximum Crest factor: 3.0 at full scale

Maximum input voltage: 750Vrms

≤3×10⁷ Volt-Hz for all ranges

Input impedance: 1MΩ±2% in parallel with capacitance <100pF

Maximum DCV: 500V for all AC ranges

DC Current

Rate	Range	Resolution	Full Scale Reading	Accuracy (1 year)	Burden Voltage ⁽¹⁾ & Shunt Resistor
Slow	2.0000mA	0.1 μA	2.1000	0.08%+0.025% ⁽²⁾	<0.3V / 100Ω
	20.000mA	1μA	21.000	0.08%+0.02% ⁽²⁾	<0.04V / 1Ω
	200.00mA	10μA	210.00	0.08%+0.02%	<0.3V / 1Ω
	2.0000 A	100A	2.1000	0.3%+0.025%	<0.05V / 10mΩ
	20.000A	1mA	21.000 ⁽³⁾	0.3%+0.025%	<0.6V / 10mΩ
⁽¹⁾ Typical voltage across the input terminals at full scale reading. ⁽²⁾ Use REL function ⁽³⁾ In 20A range,>10~20Adc is readable for 20 seconds maximum					

Maximum Input and Overload Current Protection: 1A/ 250V fuse.

AC Current (True RMS, AC Coupling)

Rate	Range	Resolution	Full Scale Reading	Burden Voltage /shunt Resistor
Slow	2.0000mA	0.1 μA	2.1000	<0.3V / 100Ω
	20.000 mA	10 μA	21.000	<0.04V / 1Ω
	200.00m A	100 μA	210.00	<0.3V / 1Ω
	2.0000A	1mA	2.1000	<0.05V / 10mΩ
	20.000A	10mA	21.000 ⁽²⁾	<0.6V / 10mΩ
⁽¹⁾ Typical voltage across the input terminals at full scale reading. ⁽²⁾ In 20A range,>10~20Aac is readable for 20 seconds maximum				

ACCURACY: ± (% of reading + % of range), 23°C±5°C.

Rate	Range	Accuracy(1 year) ⁽¹⁾ 23°C±5°C		
		20~50 Hz	50~2kHz	2~20kHz
Slow	2.0000mA	1.5%+0.5%	0.5%+0.3%	2%+0.5%
	20.000 mA	1.5%+0.5%	0.5%+0.3%	2%+0.38%
	200.00m A	1.5%+0.5%	0.5%+0.3%	2%+0.38%
	2.0000A	2.0%+0.5%	0.5%+0.5%	-----
	20.000A	2.0%+0.5%	0.5%+0.5%	-----
⁽¹⁾ Specifications are for SLOW rate and sinewave inputs >5% of range.				

Measurement method: True RMS measurement

Maximum Crest factor: 3.0 at full scale

Maximum Input and Overload Current Protection: 1A/ 250V fuse.

Resistance

Rate	Range ⁽¹⁾	Resolution	Full Scale Reading	Test Current	Accuracy (1 year)
Slow	200.00Ω	10mΩ	210.00	0.5 mA	0.10%+0.05% ⁽²⁾
	2.0000 kΩ	100mΩ	2.1000	0.45 mA	0.10%+0.025% ⁽²⁾
	20.000kΩ	1Ω	21.000	45μA	0.10%+0.025% ⁽²⁾
	200.00 kΩ	10 Ω	210.00	4.5μA	0.10%+0.025%
	2.0000MΩ	100 Ω	2.1000	450nA	0.15%+0.025%
	20.000MΩ	1kΩ	21.000	45nA	0.3%+0.05%

⁽¹⁾ In order to eliminate the noise interference, which might be induced to the test leads, it is recommended to use a shielded test cable for measuring resistance above 100kΩ.

⁽²⁾ Using REL function

Maximum Input Protection: 1000VDC or 750VAC for all ranges.

Open circuit voltage: Maximum voltage is 5.5V dc

Continuity

Range	Resolution	Full Scale Reading	Test Current	Accuracy (1 year) 23°C±5°C
200Ω	100mΩ	999.9	0.5mA	0.1%+0.1%

Maximum Input Protection: 1000VDC or 750VAC for all ranges.

Open circuit voltage: <5.5V DC

Test Current: around 0.5 mA DC

Threshold value: 5% of range

Diode

Rate	Range	Resolution	Full Scale Reading	Test Current
Med	2.0000V	100μV	2.3000V	0.5mA

Frequency

ACV Range	Frequency Range	Resolution	Full Scale Reading	Accuracy ⁽²⁾	Input Sensitivity (Sine Wave)
100mV to 750V	5~10 Hz	100μHz	9.9999	0.05%+0.02%	200mV rms
	10~100Hz	1 m Hz	99.999	0.01%+0.02%	300mV rms
	100~100 kHz	10m Hz	999.99	0.01%+0.008%	300mV rms
	100k ~1MHz ⁽¹⁾	10Hz	999.99	0.01%+0.008%	500mV rms

Period

ACV Range	Frequency Range	Resolution	Full Scale Reading	Accuracy ⁽²⁾	Input Sensitivity (Sine Wave)
100mV to 750V	1~10 μ s ⁽¹⁾	0.1ns	9.9999	0.01%+0.008%	500mV rms
	10 μ s~10ms	1ns	9.9999	0.01%+0.008%	300mV rms
	10ms~100ms	1 μ s	99.999	0.01%+0.02%	300mV rms
	100ms~200ms	10 μ s	199.99	0.05%+0.02%	200mV rms

Maximum Crest factor: 3.0 at full scale

Maximum input voltage: 750Vrms

$\leq 3 \times 10^7$ Volt-Hz for all ranges

Input impedance: 1M Ω ±2% in parallel with capacitance <100pF

Maximum DCV: 500V for all AC ranges

Triggering and Memory

Reading hold sensitivity: 0.01%, 0.1%, 1% or 10% of reading

Math Functions

Rel, Max/Min, dBm, dB, Compare Limit Test and %

dBm Reference Resistance: 1 Ω to 9999 Ω (1 Ω step size), default is 75 Ω

Standard Programming Languages

SCPI (Standard Commands for Programmable Instruments)

Remote Interface

RS-232C

General Specifications

Power Supply: 110/220V±10%

Power Line Frequency: 50/60Hz ±5%

Power Consumption: \leq 10VA

Operating Environment: 0 $^{\circ}$ C to 40 $^{\circ}$ C, \leq 90%RH,

Storage Environment: -40 $^{\circ}$ C to 70 $^{\circ}$ C

Warm-up: more than 30mins

Dimensions (WxHxD): 225mmx100mmx355mm

Net Weight: Around 2.5Kg

Warranty: 2 years

Chapter 8 Program Examples

Serial Interface Program

The following example is a communication program. It is programmed with C Language and working in DOS environment. Where the MAIN Function could be extended for communication functions by users and other sub functions show you how to input and output character strings using serial interfaces.

```
#define PORT 0
#include "dos.h"
#include "stdio.h"
#include "stdlib.h"
#include "ctype.h"
#include "string.h"
#include "conio.h"

void port_init( int port,unsigned char code );
int check_stat( int port );          /* read serial port state(16bit) */
void send_port( int port,char c );  /* send a character to serial port */
char read_port( int port );         /* receive a character form serial port */

void string_wr( char *ps );         /* write a string to serial port */
void string_rd( char *ps );         /* read a string from serial port */

char input[256];                    /* query receive buffer */

main()
{ port_init( PORT,0xe3 );/* initialize serial port:baud = 9600,no verify,1 bit stop,8 bit data */
  string_wr( "trig:sour bus;*trg" );
  string_rd( input );
  printf( "\n%s",input );

  string_wr( "volt:dc:rang 1.0" );
  string_wr( "func 'volt:ac' );
}

/* write string to serial port */
void string_wr( char *ps )
{ char c;
  int m,n;
  while( check_stat(PORT) & 256) read_port(PORT);/* read data until null */
  for( ;*ps; )
```

```

{ c = 0;
  for( m = 100;m;m-- )
  { send_port( PORT,*ps );
    for( n = 1000;n;n-- )
    { delay(2); /* wait about 2ms,can use dos.h libray funtion:delay */
      if( kbhit() && ( getch() == 27 ) ) /* if escape key keypress */
      { printf( "\nE20:Serial Port Write Canceled!" );
        exit(1);
      }
      if( check_stat(PORT) & 256 )
      { c = read_port( PORT );
        break;
      }
    }
    if( n ) break;
  }
  if( c == *ps ) ps++;
  else
  { printf( "\nE10:Serial Port Write Echo Error!" );
    exit(1);
  }
}
send_port( PORT,'\n' );/* send command end symbol */
delay( 2 );
while( !(check_stat(PORT) & 256) );
read_port( PORT );
}

```

```

/* read string from serial port */
void string_rd( char *ps )
{ unsigned char c,i;
  for( i = 0;i < 255;i++ ) /* max read 256 characters */
  { while( ! (check_stat(PORT) & 256) ) /* wait serial receive ready */
    if( kbhit() && ( getch() == 27 ) ) /* if escape key keypress */
    { printf( "\nE21:Serial Port Read Canceled!" );
      exit(1);
    }
    c = read_port( PORT );
    if( c == '\n' ) break;
    *ps = c;
    ps++;
  }
  *ps = 0;
}

```



```

/* send a character to serial port */
void send_port( int port,char c )
{ union REGS r;
  r.x.dx = port;          /* serial port */
  r.h.ah = 1;             /* int14 function1: send character */
  r.h.al = c;             /* character to be sent */
  int86( 0x14,&r,&r );
  if( r.h.ah & 128 ) /* check ah.7,if set by int86( 0x14,&r,&r ),mean trans error */
  { printf( "\nE00:Serial port send error!" );
    exit(1);
  }
}

/* read a character from serial port */
char read_port( int port )
{ union REGS r;
  r.x.dx = port;          /* serial port */
  r.h.ah = 2;             /* int14 function2:read character */
  int86( 0x14,&r,&r );
  if( r.h.ah & 128 ) /* if ah.7 be set, mean trans error */
  { printf( "\nE01:Serial port read error!" );
    exit(1);
  }
  return r.h.al;
}

/* check the status of serial port */
int check_stat( int port )
{ union REGS r;
  r.x.dx = port;          /* serial port */
  r.h.ah = 3;             /* int14 function3:read status */
  int86( 0x14,&r,&r );
  return r.x.ax;          /* ax.7 show serial operation, ax.8 show serial receive ready */
}

/* initialize the serial port */
void port_init( int port, unsigned char code )
{ union REGS r;
  r.x.dx = port;          /* serial port */
  r.h.ah = 0;             /* int14 function0:initial serial port */
  r.h.al = code;          /* initialization code */
  int86( 0x14,&r,&r );
}

```