

General

Voltmeter is designed to watch voltage between phase-neutral and phase-phase.

Selective voltmeter is designed to watch voltage between 3 pahse-neutral and 3 phase-phase in one device.

Frequensymeter is designed to watch frequency between pahse-neutral or phase-phase.

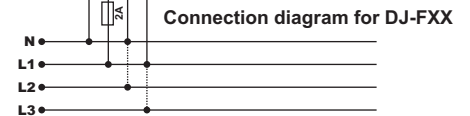
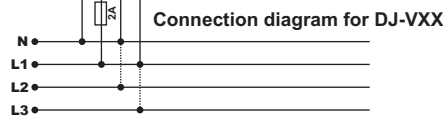
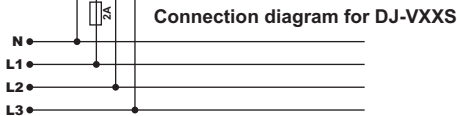
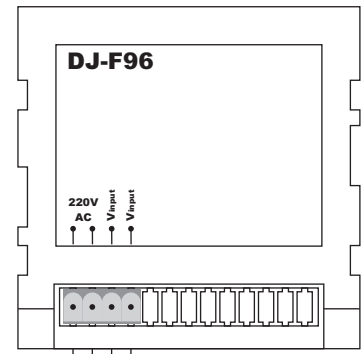
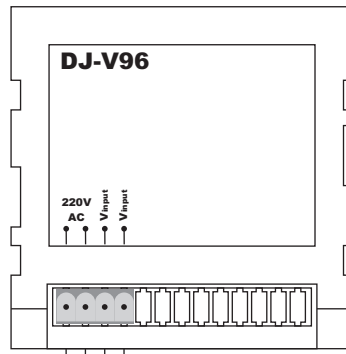
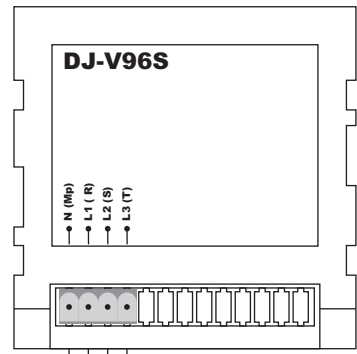

Usage of Device and Working Principle

Make the connections according to the diagram.

Voltmeter display the voltage comes to inputs when power is on. Input can be connected by phase-neutral or phase-phase.

Selective Voltmeter display voltage between L1-N and L1 led switches on when the power is on. You can see voltages between L2-N, L3-N, L1-L2, L2-L3 and L1-L3 by pressing the button on the panel. Related Led will switch on refer to the voltage displayed.

Frequencymeter display frequency between phase-neutral or phase-phase comes to the inputs when power is on.

Maintenance

Switch off the device and release from connections. Clean the trunk of device with a swab. Don't use any conductor or chemical might damage the device. Make sure device works after cleaning.

Warnings

Please use the device according to the manual.

Don't use the device in wet.

Include a switch and circuit breaker in the assembly.

Put the switch and circuit breaker nearby the device, operator can reach easily.

Mark the switch and circuit breaker as releasing connection for device.

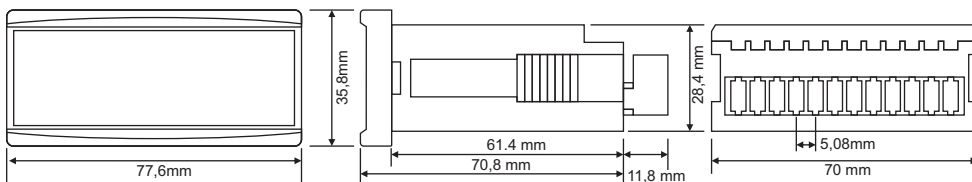

Dimensions for DJ-V36 / DJ-F36

Dimensions for DJ-V72 / DJ-F72 / DJ-V72S

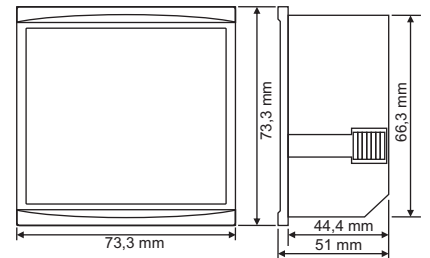

Dimensions for DJ-V96 / DJ-F96 / DJ-V96S

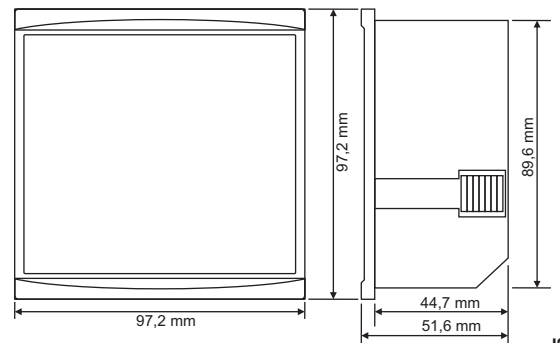

Dimensions for DJ-V48 / DJ-F48

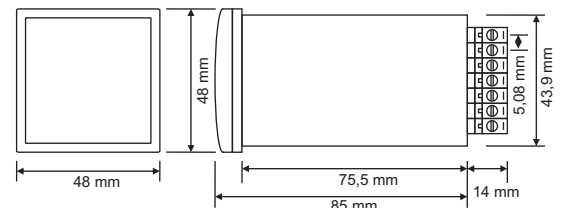

Technical Specifications:

- Operating Voltage(Un):.....:140V - 270V AC
- Operating Frequency.....:50/60 Hz.
- Operating Power.....:<6VA
- Operating Temperature.....:-20°C.....+55°C
- Frequency Measurement Range.: 1 - 400Hz (15V - 500V AC / DJ-FXX)
- Voltage Measurement Range.....:0V - 500V AC(DJ-VXX ve DJ-VXXS)
- Measurement Precision.....:±%1
- Display.....: 20mm(96), 14mm(72, 36) ve 9mm(48) display
- Connection Type.....:Plug-in terminal
- Cable Diameter.....:1,5mm²
- Weight.....: Max. 220gr.
- Panel Hole Sizes.....:91x91mm(96), 68x68mm(72),
46x46mm(48) and 31mmx72mm(36)
- Protection Class.....: Front panel IP 41, Body IP 00
- Mounting.....:Panel front mounted
- Operating Altitude.....:<2000meter

