



testo 324 - Leakage rates measuring instrument

Instruction manual



1 Contents

1	Contents	3
2	Safety and the environment.....	6
	2.1. About this document.....	6
	2.2. Ensure safety.....	8
	2.3. Protecting the environment.....	9
3	Specifications	10
	3.1. Use	10
	3.1. Physical principles	11
	3.1.1. Physical influence of temperature on the pressure to be measured	11
	3.1.2. The standardised measurement result of the testo 324 relating to temperature influences	11
	3.2. Technical data	12
	3.2.1. Examinations	12
	3.2.2. Bluetooth® module (option)	12
	3.2.3. Approvals	12
	3.2.4. Declaration of conformity	15
	3.2.5. Measuring ranges and accuracies	15
	3.2.6. Other instrument data	16
4	Product description.....	17
	4.1. Measuring instrument	17
	4.1.1. Overview.....	17
	4.1.2. Keypad	18
	4.1.3. Display.....	18
	4.1.4. Instrument connections.....	19
	4.1.5. Interfaces.....	20
	4.2. testo 324 in the case system with feeding unit	21
5	First steps	23
	5.1. Commissioning	23
	5.2. Getting to know the product.....	23
	5.2.1. Mains unit, rechargeable batteries	23
	5.2.1.1. Charging the battery	23
	5.2.1.2. Rechargeable battery care	24
	5.2.1.3. Mains operation	24
	5.2.2. Connecting hoses/probes	24
	5.2.3. Switching on	24
	5.2.4. Calling up the function	25
	5.2.5. Entering values	25
	5.2.6. Printing/saving data	26
	5.2.7. Confirming an error message.....	27
	5.2.8. Switching off	27

5.3.	Address/location	27
5.4.	Measurement records	30
5.5.	Instrument diagnosis	30
6	Using the product	32
6.1.	Performing settings	32
6.1.1.	Assigning the right function key	32
6.1.2.	Instrument settings	32
6.1.2.1.	Units	32
6.1.2.2.	Date/Time	33
6.1.2.3.	Energy management	33
6.1.2.4.	Display brightness	33
6.1.2.5.	Printer	33
6.1.2.6.	Bluetooth®	34
6.1.2.7.	Automatic measuring rate	35
6.1.2.8.	Inspector	35
6.1.2.9.	Language	36
6.1.2.10.	Country version	36
6.1.2.11.	Password protection	36
6.1.3.	Gas type	37
6.2.	Measuring	38
6.2.1.	Preparing for measurement	38
6.2.2.	Options menu	39
6.2.3.	Pipe volume	40
6.2.4.	Gas pipe (TRGI 2008)	41
6.2.4.1.	Pretest	42
6.2.4.2.	Main test	44
6.2.4.3.	Leakage test (leakage measurement)	45
6.2.4.4.	Combined pretest/main test	48
6.2.4.5.	Caravan Check	49
6.2.5.	Liquid gas (DVGW TRF 2012)	51
6.2.5.1.	Pressure test	52
6.2.5.2.	Main test	53
6.2.5.3.	Repeated testing (PS>0.5 bar / PS<=0.5 bar)	54
6.2.5.4.	Carrying out repeated testing PS <0.5 bar	56
6.2.6.	Drinking water (ZVSHK sheet as per DIN EN 806-4)	57
6.2.6.1.	Testing with air – main test	58
6.2.6.2.	Testing with air – pretest	59
6.2.6.3.	Test with water	61
6.2.7.	Waste water (DIN EN 1610) with air	63
6.2.8.	Programs	64
6.2.8.1.	Spot measurement	64
6.2.8.2.	Programs 2-5	66
6.2.9.	Controller test	69
6.2.9.1.	Static pressure	70
6.2.9.2.	Flow pressure	71
6.2.9.3.	SAV_triggering pressure	72
6.2.9.4.	SRV_triggering pressure	73

6.3.	Transferring data	74
6.3.1.	Record printer	74
6.3.2.	PC/pocket PC	74
6.3.3.	Data transfer to IrDA record printer	74
7	Maintaining the product	75
7.1.	Cleaning the measuring instrument	75
7.2.	Regular calibration	75
7.3.	Replacing the gas bladder	75
8	Tips and assistance.....	76
8.1.	Questions and answers	76
8.2.	Accessories and spare parts	76
8.3.	Updating the instrument software	78

2 Safety and the environment

2.1. About this document



This document describes the product testo 324 with the instrument setting **Country version | Germany**.

Use

- > Please read this documentation through carefully and familiarize yourself with the product before putting it to use. Pay particular attention to the safety instructions and warning advice in order to prevent injuries and damage to the products.
- > Keep this document to hand so that you can refer to it when necessary.
- > Hand this documentation on to any subsequent users of the product.

Warnings



Always pay attention to information that is marked by the following warnings with warning pictograms. Implement the specified precautionary measures.

Representation	Explanation
 WARNING	Indicates potential serious injuries
 CAUTION	indicates potential minor injuries
NOTICE	indicates circumstances that may lead to damage to the products

Symbols and writing standards

Representation	Explanation
	Note: Basic or further information.
1. ... 2. ...	Action: more steps, the sequence must be followed.
> ...	Action: a step or an optional step.
- ...	Result of an action.

Symbols and writing standards

Display	Explanation
	Warning advice, risk level according to the signal word: Warning! Serious physical injury may occur. Caution! Minor physical injury or damage to the equipment may occur. > Take the specified precautionary measures.
	Note: Basic or further information.
1. ... 2. ...	Handling: several steps, the sequence must be followed.
> ...	Handling: one step or optional step.
- ...	Result of an action.
Menu	Elements of the instrument, the instrument display or the program interface.
[OK]	Control keys of the instrument or buttons of the program interface.
... ...	Functions/paths within a menu.
“...”	Example entries

2.2. Ensure safety

- > Only operate the product properly, for its intended purpose and within the parameters specified in the technical data. Do not use any force.
- > Do not operate the instrument if there are signs of damage at the housing, mains unit or feed lines.
- > Do not perform contact measurements on non-insulated, live parts.
- > Do not store the product together with solvents. Do not use any desiccants.
- > Carry out only the maintenance and repair work on this instrument that is described in the documentation. Follow the prescribed steps exactly. Use only original spare parts from Testo.
- > Any further or additional work must only be carried out by authorised personnel. Testo will otherwise refuse to accept responsibility for the proper functioning of the measuring instrument after repair and for the validity of certifications.
- > Only use the device in closed, dry rooms and protect it from rain and moisture.
- > Temperatures given on probes/sensors relate only to the measuring range of the sensors. Do not expose handles and feed lines to any temperatures in excess of 70 °C unless they are expressly permitted for higher temperatures.
- > The gas feeding unit should only be emptied in an open environment.
- > Do not operate the instrument if there are signs of damage at the housing, mains unit or feed lines.
- > Dangers may also arise from the systems being measured or the measuring environment: Note the safety regulations valid in your area when performing the measurements.

For products with Bluetooth® (optional)

Changes or modifications that have been made without the explicit consent of the responsible approval authority, may cause the retraction of the type approval.

Data transfer may be disturbed by equipment that uses the same ISM-band, e.g. WLAN, microwave ovens, ZigBee.

The use of radio communication links is not permitted, among others, in aeroplanes and hospitals. For this reason the following points must be ensured before entering:

- > Switch off the device:
- > Isolate the device from any external power sources (mains cable, external rechargeable batteries, ...).

2.3. Protecting the environment

- > Dispose of faulty rechargeable batteries/spent batteries in accordance with the valid legal specifications.
- > At the end of its useful life, send the product to the separate collection for electric and electronic devices (observe local regulations) or return the product to Testo for disposal.

3 Specifications

3.1. Use

testo 324

The testo 324 is a leakage measuring instrument for the professional performance of the following measuring tasks:

- Pretest and main test on gas pipes
- Determining the usability of gas pipes
- Measuring low pressure against atmospheric pressure
- Pressure test on waste water pipes
- Pressure tests on liquid gas pipes
- Controller test

 WARNING
Escaping gas can produce an explosive mixture of gases! Potential risk of explosion!
> The testo 324 leakage measuring instrument may only be used by authorised personnel who have been trained in the maintenance and inspection of gas systems.
> Observe local accident prevention and test regulations.

i Testo guarantees the functionality of its products when used in accordance with their intended purpose. This guarantee does not apply to features of Testo products in combination with unauthorised third-party products. Competitor products are not authorised by Testo. As is common practice, Testo generally excludes support, warranty or guarantee claims relating to functionality that has not been guaranteed by Testo as part of the product offered. Claims shall also be excluded in the event of improper use or handling of the products, e.g. in combination with unauthorised third-party products. Further warranty terms: see website www.testo.com/warranty.

Feeding unit

When used in conjunction with the testo 324 leakage measuring instrument, the feeding unit (gas bladder) enables leakage measurement to be carried out independently of the gas supply.

3.1. Physical principles

3.1.1. Physical influence of temperature on the pressure to be measured

Temperature fluctuations and positional changes have an effect on the measuring accuracy of pressure measurements. The following should therefore be observed:

- ✓ The entire measurement system must be adapted to the ambient temperature and to the temperature of the line system to be tested.
- ✓ The temperature of the measurement system and the line system must remain stable during measurement.

Example of temperature influence:

with a test pressure of 100 hPa and an air pressure of 1000 hPa, the ambient temperature changes from +22 °C to +23 °C. The air in the test system expands and the test pressure increases by 3.73 hPa. The temperature influence on the pressure change is unaffected by the test volume.

3.1.2. The standardised measurement result of the testo 324 relating to temperature influences

The testo 324 leak rate measuring instrument certified to DVGW G 5952 enables measuring values to be reproduced. Comparable results based on the standardised reference operating pressure of 23 mbar are always achieved. The volume measured during the test is based on a reference temperature of 20 °C and the current air pressure.

A change in the ambient temperature therefore has no influence on the measuring values!

The ambient temperature and the relevant test gas or medium for each test section must nevertheless show a constant temperature within the range of 15 °C to 25 °C with a maximum deviation of ± 2 °C. Only then can a measurement be carried out. During the stability time at the start of each measurement, this check is carried out automatically and a warning is issued if the temperature and therefore the pressure fluctuates too greatly.

3.2. Technical data

3.2.1. Examinations

Tested in accordance with DVGW¹ G5952 by DVGW Karlsruhe.
As declared in the Certificate of Conformity, this product complies with Directive 2014/30/EU.



3.2.2. Bluetooth® module (option)

The use of the wireless module is subject to the regulations and stipulations of the respective country of use, and the module may only be used in countries for which a country certification has been granted. The user and every owner has the obligation to adhere to these regulations and prerequisites for use, and acknowledges that the re-sale, export, import etc. in particular in countries without wireless permits, is his responsibility.

3.2.3. Approvals

Product	Testo 324
Mat.-No.	0632 3240
Country	Comments
Canada	contains IC 5123A-WT11U IC Warnings
Europa + EFTA	 <p>EU countries: Belgium (BE), Bulgaria (BG), Denmark (DK), Germany (DE), Estonia (EE), Finland (FI), France (FR), Greece (GR), Ireland (IE), Italy (IT), Latvia (LV), Lithuania (LT), Luxembourg (LU), Malta (MT), Netherlands (NL), Austria (AT), Poland (PL), Portugal (PT), Romania (RO), Sweden (SE), Slovakia (SK), Slovenia (SI), Spain (ES), Czech Republic (CZ), Hungary (HU), United Kingdom (GB), Republic of Cyprus (CY).</p> <p>EFTA countries: Iceland, Liechtenstein, Norway, Switzerland</p>

¹ German Technical and Scientific Association for Gas and Water

Japan	  209- J00232																		
Turkey	Authorized																		
USA	 contains FCC ID: QOQWT11U FCC Warnings																		
Radio module	<table border="1"> <thead> <tr> <th>Feature</th> <th>Values</th> </tr> </thead> <tbody> <tr> <td>Bluetooth Range</td> <td><10 m (free field)</td> </tr> <tr> <td>Bluetooth type</td> <td>Bluegiga WTT11u Bluetooth Module</td> </tr> <tr> <td>Qualified Design ID</td> <td>22298</td> </tr> <tr> <td>Declaration ID</td> <td>B016141</td> </tr> <tr> <td>Bluetooth radio class</td> <td>Class 1</td> </tr> <tr> <td>Bluetooth company</td> <td>Silicon Laboratories Inc.</td> </tr> <tr> <td>RF Band</td> <td>2402 - 2480 MHz</td> </tr> <tr> <td>Nominal output power</td> <td>17 dBm</td> </tr> </tbody> </table>	Feature	Values	Bluetooth Range	<10 m (free field)	Bluetooth type	Bluegiga WTT11u Bluetooth Module	Qualified Design ID	22298	Declaration ID	B016141	Bluetooth radio class	Class 1	Bluetooth company	Silicon Laboratories Inc.	RF Band	2402 - 2480 MHz	Nominal output power	17 dBm
Feature	Values																		
Bluetooth Range	<10 m (free field)																		
Bluetooth type	Bluegiga WTT11u Bluetooth Module																		
Qualified Design ID	22298																		
Declaration ID	B016141																		
Bluetooth radio class	Class 1																		
Bluetooth company	Silicon Laboratories Inc.																		
RF Band	2402 - 2480 MHz																		
Nominal output power	17 dBm																		

IC Warnings

RSS-Gen & RSS-247 statement:

This device complies with Industry Canada licence-exempt RSS standard(s).

Operation is subject to the following two conditions:

- (1) this device may not cause interference, and
- (2) this device must accept any interference, including interference that may cause undesired operation of the device.

Le présent appareil est conforme aux CNR d'Industrie Canada applicables aux appareils radio exempts de licence.

L'exploitation est autorisée aux deux conditions suivantes :

- (1) l'appareil ne doit pas produire de brouillage, et
- (2) l'utilisateur de l'appareil doit accepter tout brouillage radioélectrique subi, même si le brouillage est susceptible d'en compromettre le fonctionnement.

Caution: Radio Frequency Radiation Exposure

This equipment complies with IC radiation exposure limits set forth for an uncontrolled environment and meets the IC radio frequency (RF) Exposure Guidelines. This equipment should be installed and operated keeping the radiator at least 20 cm or more away from person's body in normal use position.

Co-Location:

This transmitter must not be co-located or operated in conjunction with any other antenna or transmitter.

Attention : exposition au rayonnement de radiofréquences

Cet équipement est conforme aux limites d'exposition aux radiofréquences IC fixées pour un environnement non contrôlé et aux Lignes directrices relatives à l'exposition aux radiofréquences (RF). Cet équipement devrait être installé et utilisé à une distance d'au moins 20 cm d'un radiateur ou à une distance plus grande du corps humain en position normale d'utilisation.

Co-location

Ce transmetteur ne peut pas être installé en colocation ou être utilisé avec une autre antenne ou transmetteur, quel qu'en soit le type.

FCC Warnings

Information from the FCC (Federal Communications Commission)

For your own safety

Shielded cables should be used for a composite interface. This is to ensure continued protection against radio frequency interference.

FCC warning statement

This equipment has been tested and found to comply with the limits for a Class B digital device, pursuant to Part 15 of the FCC Rules. These limits are designed to provide reasonable protection against harmful interference in a residential installation. This equipment generates, uses and can radiate radio frequency energy and, if not installed and used in accordance with the instructions, may cause harmful interference to radio communications. However, there is no guarantee that interference will not occur in a particular installation. If this equipment does cause harmful interference to radio or television reception, which can be determined by turning the equipment off and on, the user is encouraged to try to correct the interference by one or more of the following measures:

- Reorient or relocate the receiving antenna.
- Increase the separation between the equipment and receiver.
- Connect the equipment into an outlet on a circuit different from that to which the receiver is connected.
- Consult the dealer or an experienced radio/TV technician for help.

Caution

Changes or modifications not expressly approved by the party responsible for compliance could void the user's authority to operate the equipment. Shielded interface cable must be used in order to comply with the emission limits.

Warning

This device complies with Part 15 of the FCC Rules. Operation is subject to the following two conditions:

- (1) this device may not cause harmful interference, and
- (2) this device must accept any interference received, including interference that may cause undesired operation.

Caution: Radio Frequency Radiation Exposure

This equipment complies with FCC radiation exposure limits set forth for an uncontrolled environment and meets the FCC radio frequency (RF) Exposure Guidelines. This equipment should be installed and operated keeping the radiator at least 20 cm or more away from person's body in normal use position.

Japan Information

当該機器には電波法に基づく、技術基準適合証明等を受けた特定無線設備を装着している。

3.2.4. Declaration of conformity

You can find the EU declaration of conformity on the Testo homepage www.testo.com under the product-specific downloads.

3.2.5. Measuring ranges and accuracies

Measurement type	Measuring range	Accuracy	Resolution
Flow (Leakage measurement)	0 to 10 l/h	±0.2 l/h or ±5% of meas. val.	0.1 l/h
Pressure	0...1000 hPa	±0.5 hPa or ±3% of meas. val.	0.1 mbar
Pressure measurement with a high pressure probe (optional)	0...25 bar	0...10 bar: ± 0.6 % of fullscale >10...25 bar: ± 0.6 % of fullscale	10 hPa
Temperature measurement TC type K (only instrument) ²	-40...600 °C	± 0,5°C (0,0...100,0 °C) ± 0,5% of meas. val. (rest of range)	0,1°C
Instrument overload	Max. 1200 hPa		
Pipe volume calculation	Max. 1200 l. ³	+/-0,2l or 5% of meas. val. (1-200l)	

² The accuracy of a connected temperature probe must also be taken into account.

³ per 200 l: Test time 12 min

3.2.6. Other instrument data

Flue gas analyser

Feature	Values
Storage/transportation conditions	Temperature: -20 to 50°C
Operating conditions	5 to 40°C
Power supply	Rech. batt.: Lithium-ion battery 11.0 V / 2400 mAh Mains unit: 115-230 V – 50/60 Hz
Protection class	IP40 acc. to EN 60529
Weight	1070 g (incl. battery)
Dimensions	270 x 90 x 75 mm
Additional probe sockets	2 Hirschmann sockets for connecting pressure probes and temperature probes
Gas connections	2 pressure connections DN 5
Interference immunity and interference emission	According to DIN EN 61326-1
Memory	500,000 measuring values
Integrated pressure pump	For test pressure build-up up to 300 mbar and for filling the feeding unit
Display	Graphic colour display, 240 x 320 pixels
Data transfer to PC	USB or Bluetooth (option)
Battery charge time	Approx. 5-6 h
Rech. batt. life	> 5 h (pump on, 20°C ambient temperature)
Supported testo printer	0554 0549, 0554 0547, 0554 0544 or 0554 0553, 0554 0620 (with Bluetooth option)
Bluetooth® (option)	Range < 10 m

4 Product description

4.1. Measuring instrument

4.1.1. Overview



- 1 Switch on/off
- 2 Attachment eye for carrying strap
- 3 Interfaces (USB, infrared) and reset button









⚠ CAUTION

Risk of injury from infrared beam!

- > Do not direct infrared beam at human eyes!

- 4 Display
- 5 Keypad
- 6 Instrument connections



4.1.2. Keypad

Button	Functions
	Switch measuring instrument on/off
 Example	Function key (grey, 3x), relevant function is shown on the display
	Scroll up, increase value
	Scroll down, reduce value
	Back, cancel function
	Open main menu
	Help texts, e.g. for individual measurements
	Transmit data to the record printer.

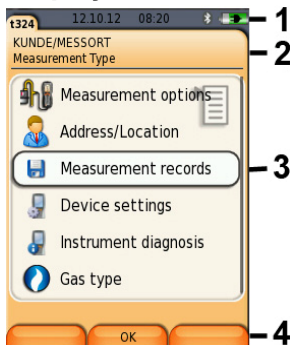

4.1.3. Display



1 Status bar (dark grey background):

- Warning symbol  (only if there is an instrument error, display of error in instrument diagnosis menu), otherwise: Instrument designation.
- Symbol 
- Display of date and time.
- Indication of Bluetooth® status, power supply and remaining rechargeable battery capacity:

Symbol	Feature
	Blue symbol = Bluetooth® on, Grey symbol = Bluetooth® off

Symbol	Feature
	Battery operation Display of remaining rechargeable battery capacity by colour and fill level of the battery icon (green = 5 - 100%, red = < 5%)
	Mains operation Display of remaining rechargeable battery capacity: see above

- 2 Info field of register tabs: Display of selected address/location, selected measurement type.
- 3 Selection field for functions (selected menu item appears against a white background, unavailable functions are identified by grey font) or display of measuring values.
- 4 Function display for function keys.

4.1.4. Instrument connections

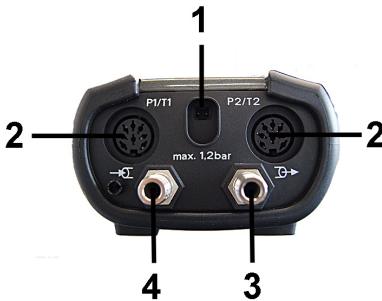

- 1 Mains unit socket
- 2 Probe sockets for connecting the temperature probe or the high pressure probes
- 3 Pressure connection 1.2 bar for connecting a pressure hose
- 4 Pressure connection for connecting a feeding unit or a pressure hose

4.1.5. Interfaces

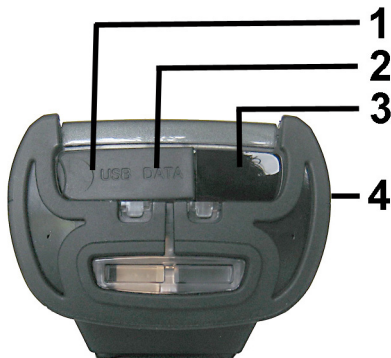

- 1 USB interface (under cover)
- 2 Reset button (under cover)
- 3 Infrared interface (IrDA)
- 4 Bluetooth interface (option)

4.2. testo 324 in the case system with feeding unit

Overview

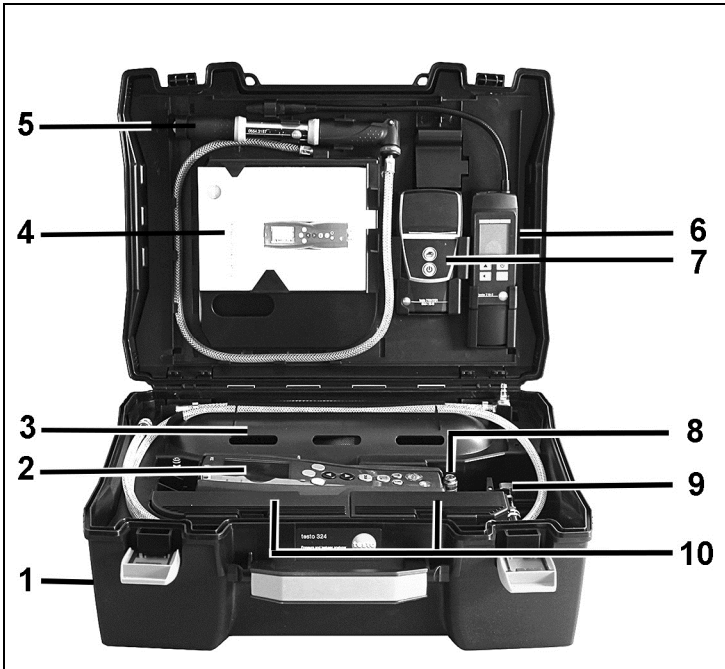

- 1 Transport case
- 2 testo 324
- 3 Feeding unit (gas bladder)
- 4 Storage compartment for instruction manual
- 5 Hand pump
- 6 Holder for gas leak detection instrument testo 316-2 or testo 316-EX
- 7 Holder for IRDA or Bluetooth printer (option)
- 8 Connection for an external hand pump or a compressor

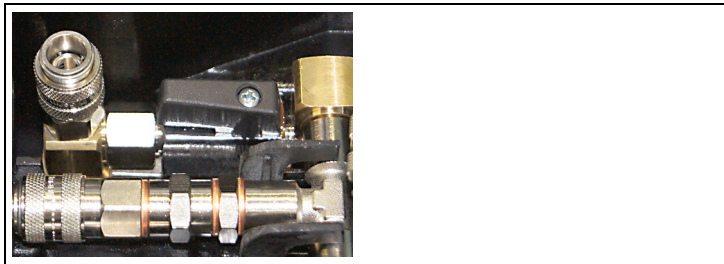

9 Connection block with shut-off valve for pump, instrument and hose connection

10 Storage compartments for accessories

5 First steps

5.1. Commissioning

testo 324

The testo 324 has a permanently installed rechargeable battery.

- > Charge the rechargeable battery fully before using the measuring instrument.
- > Remove the protective film from the display.

Feeding unit

Flushing is required when starting up the unit for the first time, after replacing the gas bladder and when changing the medium.

- > Fill and empty the feeding unit once, see Options menu, page 39

5.2. Getting to know the product

5.2.1. Mains unit, rechargeable batteries



In case of an extended interruption in the power supply to the testo 324 (e.g. rechargeable battery pack empty), the date/time settings will be lost.

5.2.1.1. Charging the battery

The rechargeable battery can only be charged at an ambient temperature of 5 to +35 °C. If the rechargeable battery pack has discharged completely, the charging time at room temperature is approx. 5 - 6 h (charging with mains adapter).

Charging via a mains unit

- ✓ The testo 324 is off.
- 1. Connect the mains unit instrument plug to the mains unit socket.
- 2. Connect the mains plug of the mains unit to a mains socket.
 - The charging process starts. The charge status is shown on the display.
 - Once the rechargeable battery has been charged, the instrument switches over automatically to trickle charge.

5.2.1.2. Rechargeable battery care

- > Do not fully exhaust rechargeable batteries.
- > For extended periods of disuse, you should discharge and recharge the batteries every 3 - 4 months. Trickle charging should not exceed 2 days.

5.2.1.3. Mains operation

i In case of danger, the instrument must be disconnected from the power supply by simply pulling out the mains cable.

- > Always position the instrument so that the power supply plug can be easily reached.
- 1. Connect the mains unit instrument plug to the mains unit socket.
- 2. Connect the mains plug of the mains unit to a mains socket.
 - The power supply is provided by the mains unit.
 - If the testo 324 is switched off, the rechargeable battery charging process starts automatically. Switching on the testo 324 stops the battery charging and the instrument is then powered via the mains unit.

5.2.2. Connecting hoses/probes

- > Connect the required hoses/probes at the corresponding connections.

5.2.3. Switching on

- > Press .
-

i When the instrument is switched on, the valves of the testo 324 are activated. Four short acoustic signals are output.

If fewer than 4 acoustic signals are sounded, the testo 324 must be switched on and off several times before use until 4 signals are sounded.

The testo 324 then starts up as usual.

- The start screen is displayed (duration: approx 15 s).
- If the voltage supply was interrupted for an extended period: The Date/Time menu is opened.
- The pressure sensors are zeroed.
- If there is an instrument error, the **Error diagnosis** menu is displayed.
- The **Measurement options** menu is displayed.

5.2.4. Calling up the function

1. Select function: [**▲**], [**▼**].
 - A box appears around the selected function.
2. Confirm selection: [**OK**].
 - The selected function is opened.

5.2.5. Entering values

Some functions require values (numbers, units, characters) to be entered. Depending on the selected function, the values are entered either via a list field or an input editor.

List field

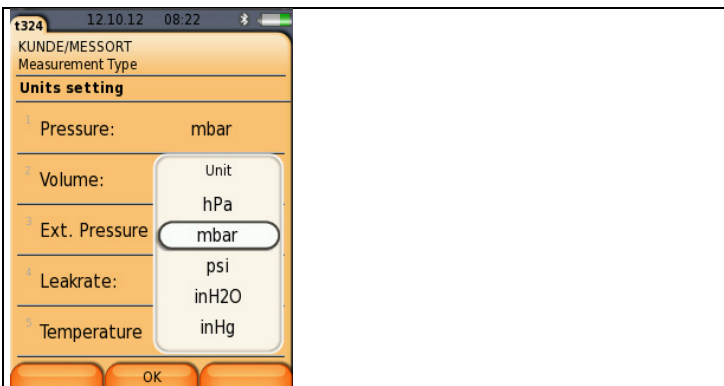

1. Select the value to be changed (numerical value, unit): [**▲**], [**▼**], [**◀**], [**▶**] (depending on the selected function).
2. Press [**Edit**].
3. Set value: [**▲**], [**▼**], [**◀**], [**▶**] (depending on the selected function).
4. Confirm the entry: [**OK**].
5. Repeat steps 1 and 4 as required.
6. Save the entry: [**Finished**].

Input editor



1. Select the value (characters) to be changed: **[▲]**, **[▼]**, **[◀]**, **[▶]**.
2. Adopt the value: **[OK]**.
Options:
 - > Toggle between upper/lower case:
select **|← ABC→&\$/ →|** : **[▲]**, **[▼]** → **[ABC→&\$/]**.
 - > Position the cursor in the text:
select **|← ABC→&\$/ →|** : **[▲]**, **[▼]** → **[|←]** or **[→|]**.
 - > Delete character before or after the cursor:
select **Del Finished ←** : **[▲]**, **[▼]** → **[←]** or **[Del]**.
3. Repeat steps 1 and 2 as required.
4. Save the entry: select **Del Finished ←** : **[▲]**, **[▼]** → **[Finished]**.

5.2.6. Printing/saving data

Data is printed out via the key **[Print]**.

To be able to transfer data to a record printer via infrared or Bluetooth interface, the printer used must be enabled, see Printer, page 33

Data is saved via the **Options** menu. The **Options** menu is accessed via the left function key and is available in many different menus.

Once a measurement has been carried out, the measurement result can be saved via the right function key **Save**. Assignment of the right function key with the function **Save** or **Print**, see **Assigning the right function key** page 32.

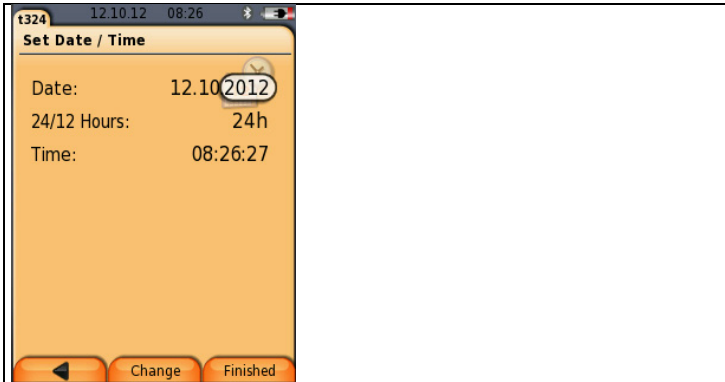

With other functions, saving is carried out automatically via the function key **Finished**, e.g. when creating **Address/Location** or entering **Date/Time**.

5.2.7. Confirming an error message

If an error occurs, an error message is shown on the display.

> Confirm error message: **[OK]**.

Errors that have occurred but have not yet been rectified are indicated by a warning symbol (⚠) in the header.

Error messages not yet resolved can be displayed in the menu **Error diagnosis**, see Instrument diagnosis, page 30.

5.2.8. Switching off



Unsaved measuring values are lost if the testo 324 is switched off.

> Press **[⏻]**.

- The measuring instrument switches off.

5.3. Address/location

All measuring values can be saved under the currently active location. Measuring values that have not been saved are lost when the measuring instrument is switched off!

Addresses and locations can be created, edited, copied and enabled. Addresses and locations (incl. records) can be deleted.

Call up function:

> **[📄]** → **Address/Location** → **[OK]** .

There are various options for opening folders.

1. Edit search setting (**Search** / **Filter** / **Show all**): **[Edit]**
2. Select search setting: **[▲]**, **[▼]** → **[OK]**.

Possible settings:

- **Show all**: all addresses/locations are displayed
- **Search**: A search text only brings up addresses/locations that contain characteristics of the search text.
- **Filter**: Individual letters or numbers can be selected. All data beginning with the relevant letter/number is displayed.



The initial letter is the determining factor for the filter function, and this can only be selected individually. The search function can also be used to find a series of several letters within the folder name!

3. Carry out search according to search setting: **[Search]**

Show all

1. Select address: **[▲]**, **[▼]**.
2. Show details: **[Details]**.
3. Enable location: select location → **[OK]**.
 - The location is enabled.
 - > Open measurements menu: press **[OK]** again.

Search

1. Edit search criterion: **[▶]** → **[Edit]**.
2. Select search criteria: **[▲]**, **[▼]** → **[OK]**.

Possible options:

 - Contact person
 - Folder name
 - Town/city
 - Postcode
 - Street
 - The selected criterion is displayed.
3. Call up entry field for search text: **[▶]** or **[▼]**
 - > Enter search text → **[Finished]**

Filter

1. Edit search criteria: **[Edit]**.
2. Select search criteria: **[▲]**, **[▼]** → **[OK]**.

Possible options:

 - Contact person
 - Folder name

- Town/city
- Postcode
- Street
- The selected criterion is displayed.
- 3. Enable tab: [▼]
- 4. Select the required tab: [▲], [▼] and sometimes [◀], [▶] → [Filter].
- The search result for the relevant letter or number is displayed.

Creating a new location:

A measuring location is always created under an address.

1. Select the address under which the location should be created.
2. [Options] → **New location** → [OK].
3. Enter values or make settings.
4. Finalise the entry: [Finished].

Other location options:

- > [Options] → **Edit location**: make changes to an existing location.
- > [Options] → **Copy location**: make a copy of an existing location in the same folder.
- > [Options] → **Delete location**: delete an existing location.

Creating new addresses:

1. [Options] → **New address** → [OK].
2. Enter values or make settings.
3. Finalise the entry: [Finished].

Additional address options:

- **Edit address**: make changes to an existing folder.
- **Copy address**: make a copy of an existing address.
- **Delete address**: delete an existing address, including the locations created there.
- **Delete all addresses**: delete all existing addresses, including the locations created there.

5.4. Measurement records

Call up function:

>  → **Measurement records** → [OK].

There are various options for opening records, see Address/location, page 27.

Displaying a record:

1. Select the required record from the detailed view.
2. [Data].

Options:

> [Options] → **Show Graphic**: display saved record data as graphic.

> [Options] → **Delete Record**: delete the selected record.

> [Options] → **Number of lines**: change the number of measuring values per display page.

> [Options] → **Delete all records**: delete all saved records for a location.

5.5. Instrument diagnosis

Important operating values and instrument data are displayed. A main test can be carried out. Instrument errors that have not yet been rectified can be displayed.

Call up function:

>  → **Instrument diagnosis** → [OK].

Error diagnosis

> **Error diagnosis** → [OK].

- Unresolved errors, warnings and notes are displayed.

> View next/previous error: [▲], [▼].

Instrument information

> **Device Information** → [OK].

- Information is displayed.

Tightness test

1. **Main test** → **Tightness test** → [OK]

2. Short both gas connections through the connection hose.

3. Start the check: [OK].

- Zeroing of pressure sensor

- Pressure is built up and measurement is carried out

- The result of the measurement is indicated by a traffic light.

Gas feeding unit test

1. **Gas feeding unit test** → **[OK]**.
2. Connect the measuring instrument to the gas feeding unit.
3. Start the test: **[OK]**.
 - If the gas feeding unit is full, it is emptied.
4. Gas feeding unit is filled.
 - Settling period expires (15 min)
 - Measuring time expires (5 min)
 - The measurement result is indicated by a traffic light.
5. Gas feeding unit is emptied.
6. Exit testing: **[Back]**

6 Using the product

6.1. Performing settings

6.1.1. Assigning the right function key

The right function key can have a function from the **Options** menu assigned to it. The menu **Options** is accessed via the left function key and is available in many different menus. This assignment is only valid for the currently opened menu / the opened function.

✓ A menu / function is opened in which the **Options** menu is displayed on the left function key.

1. Press **[Options]** .
2. Select option: **[▲]**, **[▼]**.

Depending on the menu / function from which the **Options** menu was opened, the following functions are available.

3. Assign the selected function to the right function key: Press **[Config. Key]**.

6.1.2. Instrument settings



It is assumed that the contents of the chapter **First steps** (see **First steps**, page 23) are known.

Calling up a function:

> **[Menu]** → **Device Settings**.

6.1.2.1. Units

The units used for parameters in configuration menus can be set.

Call up function:

> **[Menu]** → **Instrument settings** → **[OK]** → **Units** → **[OK]**.

Adjustable units

Parameter	Unit
Pressure	hPa, mbar, psi, inW, inHg
Volume	m³, l, ft³
Ext. Pressure	bar, psi, kPa
Leakrate	l/h, fl.oz, ml/min

1. Select the line: [▲], [▼] → [Edit].
2. Select the unit to be changed: [▲], [▼] → [OK].
3. Confirm the entry: [Finished].

6.1.2.2. Date/Time

Date, time mode and time can be set.

Calling up the function:

- >  → Instrument settings → [OK] → Date/Time → [OK].

Set date/time:

1. Select parameter: [◀], [▲], [▼] → [Edit].
2. Set parameter: [▲], [▼] and sometimes [◀], [▶] → [OK].
3. Save settings: [Finished].

6.1.2.3. Energy management

Automatic instrument shutdown (Auto-Off) and switching off of the display light in battery operation can be set.

Calling up the function:

- >  → Instrument Settings → [OK] → Energy Management → [OK]

Making settings:

1. Select function or parameter: [▲], [▼] → [Edit].
2. Set parameter: [▲], [▼] and partly [◀], [▶] → [OK].
3. Save changes: [Finished].

6.1.2.4. Display brightness

The intensity of the display illumination can be set.

Calling up the function:

- >  → Instrument Settings → [OK] → Display Brightness → [OK]

Performing settings

- > Set parameter: [◀], [▶] → [OK].

6.1.2.5. Printer

The headers (lines 1-3) and the footer for the printout can be set.
The printer that is used can be enabled.

Call up function:

- >  → Instrument settings → [OK] → Printer → [OK].

Enabling the printer:

i The 0554 0553 and 0554 0620 printers can only be selected if the Bluetooth® interface is enabled, see **Bluetooth®**, page 34.

i When using the testo IrDA record printer 0554 0547, the testo IrDA fast printer 0554 0549 must be selected.

i Graphics can be printed out using the following Testo printers:

0554 0547 IrDA report printer

0554 0549 IrDA report printer

0554 0553 Bluetooth® printer

0554 0620 Bluetooth® printer

1. **Select printer** → **[OK]**.
2. Select the printer: **[▲]**, **[▼]** → **[OK]**.
 - The printer is enabled and the **Printer** menu is opened.

Setting the print text:

1. **Print text** → **[OK]**.
2. Select function: **[▲]**, **[▼]** → **[Edit]**.
3. Enter values → **[OK]**.
4. End input: **[Finished]**.
5. Save the entry: **[Finished]**.

6.1.2.6. Bluetooth®

This menu is only available if the instrument is equipped with Bluetooth. The Bluetooth module can be switched on / off. The relay can now be tested.

Calling up the function:

> **[☰]** → **Instrument Settings** → **[OK]** → **Bluetooth** → **[Edit]**.

Making settings:

> Set parameter → **[OK]**.

6.1.2.7. Automatic measuring rate

The automatic measuring rate can be switched on or off.

If the automatic measuring rate is on, the following measuring rate is saved for the individual measurement programs (except

Programs menu):

Messzeit	Measuring rate
< 15 min	1 s
> 15 min	1 min

If the automatic measuring rate is switched off, a measuring rate of 1 second is used, irrespective of the measuring time.

Call up a function:

>  → **Instrument settings** → [OK] → **Autom. meas. rate** → [OK].

Making settings:

1. [Edit]
2. Set parameter: [▲], [▼] → [OK].

6.1.2.8. Inspector

In this menu, an inspector can be selected and/or a new one can be created.

Calling up the function:

>  → **Instrument settings** → [OK] → **Inspector** → [OK].

Making settings:

1. Edit/create inspector: [▼] → [Edit] → [Finished].
2. Set parameter: [▲], [▼] and sometimes [◀], [▶] → [OK].
3. Save changes: [Finished].
4. [Finished].

Selecting an inspector

> Select inspector: [▲], [▼] → [Enable] → [Finished].

6.1.2.9. Language

The menu language can be set. The number of available languages depends on the activated country version.

Calling up the function:

>  → **Instrument Settings** → [OK] → **Language** → [OK]

Activating the language:

> Select the language → [OK].

see Country version, page 36

6.1.2.10. Country version

The country version with national defaults (measurement types, standard values) can be set. The selection of the country version influences the menu languages that can be enabled.

Call up function:

>  → **Instrument settings** → [OK] → **Country version** → [OK].



This setting can be password protected. A password is specified in the menu **Password Protection**, see Password protection, page 36.

Possibly:

> Enter password: [Enter] → Enter password → [Finished] → [OK].



Setting the country version:

1. Select the country version: [**▲**], [**▼**] → [OK].

2. Confirm confirmation request: **Yes** → [OK]

- The system is restarted.

6.1.2.11. Password protection

The password protection is only valid for functions identified by the following symbol:  or .

Password protection can be enabled/disabled, the password can be changed.

To disable password protection, change the password to **0000** (factory setting).

Call up function:

>  → **Instrument settings** → [OK] → **password protection** → [OK].

Possibly:

- > Enter the current password:
[Enter] → Enter password → **[Finished]** → **[OK]**.

Changing the password:

1. **[Edit]**.
2. Enter a new password → **[Finished]**.
3. **[Edit]**.
4. Enter the new password again to confirm → **[Finished]**.
5. Save changes: **[Finished]**.

6.1.3. Gas type

The gas type can be selected. The gas-specific coefficients and threshold values can be set.

i In order to maintain the measuring accuracy of the instrument, the correct gas must be selected or configured.

i Correct representation of measuring results is only assured if the threshold values for the ideal range of the corresponding measurement task have been set correctly. Preset threshold values are typical values for the selected gas type.

Gas	Standard designation	Gas composition	Measuring range
Natural gas (G20)	Complies with G20	Methane 100%	0 to 10 l/h
Natural gas (G25)	Complies with G25	Methane 86% Nitrogen 14%	0 to 10 l/h
Propane G31	G31 burner test gas	Propane 100%	0 to 5 l/h
Propen G32	G32 burner test gas	Propen 100%	0 to 5.7 l/h
G21	G21 burner test gas EN 437, DIN 3362	Methane 87% Propane 13%	0 to 10 l/h
G30	G30 burner test gas	n-butane 50% Iso-butane 50%	0 to 3.2 l/h

Gas	Standard designation	Gas composition	Measuring range
Air	-	Nitrogen 78% Oxygen 21%	0 to 10 l/h
CO2	--	CO2 100%	0 to 9 l/h

Call up function:

>  → **Gas type** → **[OK]**.

Enabling gas type:

- > Select the gas type → **[OK]**.
- The gas type is enabled and the main menu is opened.

Setting coefficients:

1. Select gas type → **[Coeff.]**.
2. Select the coefficients: **[Edit]**.

Possibly:

- > Enter password: **[Enter]** → Enter password → **[Finished]** → **[OK]**.
- 3. Set values → **[OK]**.
- 4. Save changes: **[Finished]**.

6.2. Measuring

6.2.1. Preparing for measurement

i The feeding unit (gas bladder) must be tested for leaks at regular intervals, see Instrument diagnosis, page **30**, gas feeding unit test.

Caution

Avoid damage to the instrument due to high pressure!

> For tests with a test pressure of > 1 bar or using a liquid test medium e.g. water, a high pressure probe (art. no. 0638 1748) must be used.

i The **First steps** chapter (see First steps, page **23**) **must have been read.**

i General information on the tightness tests on gas and water pipes according to DVGW

-
- Before starting work on pipes carrying gas, the relevant shut-off device must be closed and secured against opening by unauthorised persons (e.g. when the key or the hand wheel is removed). Where gas escapes or could escape, it is necessary to ensure that the gas is disposed of safely through ventilation or routing it outdoors via a hose. The shut-off device should only be opened again when all openings of the pipes through which gas could escape have been tightly sealed. The above does not apply when dealing with external maintenance measures on pipes.
 - If a leak is detected in accessible pipes carrying gas using a gas detector in accordance with DVGW advice G465-4 or with foaming agents in accordance with DIN EN 14291, the point must be sealed by means of suitable measures. Illumination with flames is not permitted. Temporary sealing is only permissible in the short term to avoid immediate risks.
 - Pipes with operating pressures up to 100 mbar are subject to a pretest and a main test, as well as a serviceability test (for system in operation). The tests should be carried out before the pipe is plastered over or covered and its connections are coated or encased. The tests can also be carried out in step-by-step.
 - All tests must be documented.
-



To protect the testo 324, it is necessary to ensure that the gases flowing into the pipes are free of oil, dust and moisture.

Setting the location and gas type

Before carrying out measurements, the location and gas type must be correctly selected, see Address/location, page 27 and see Gas type, page 37.

6.2.2. Options menu

In the Measurement Type menu, for the various measurement types, under **[Options]**, the following selection is available:

- > **[Options]** → **Address/Location**: The Address/Location folder is opened.
- > **[Options]** → **Gas type**: The Gas type folder is opened.
- > **[Options]** → **Main test**: A main test can be carried out.
- > **[Options]** → **Please empty gas feeding unit**: If a gas feeding unit is available, this is emptied automatically.

i This option is only available in conjunction with a feeding unit.

- > **[Options]** → **Release air**: Air is released from the pipe into the environment.
- > **[Options]** → **Release gas**: Gas is released from the pipe into the gas feeding unit.

i This option is only available in conjunction with a feeding unit.

There are other options depending on the measurement type used.

6.2.3. Pipe volume

Based on the pipe volume calculation, unknown pipe volumes can be determined and allocated to the relevant measuring location. Particularly for the tightness test, where the stability time and measurement time depends on the pipe volume, the advantage is even more accurate and more reliable measurement.

Calling up the function:

- > **[Menu]** → **Measurements** → **[OK]** → **Pipe volume** → **[OK]**.

Setting parameters

Parameter	Selection	Explanation
Gas feeding unit	Yes/No	Enable/disable gas feeding unit
Test gas	Air, CO ₂ , G30, G21, propane, natural gas,	Select test gas

1. Select parameter → **[Edit]**.
2. Select or enter values: **[▲]**, **[▼]** and sometimes **[◀]**, **[▶]** → **[OK]**.

Carrying out the measurement:

3. Start measurement: [**▶**].
 - > When **Gas feeding unit Yes** is selected: carry out steps in accordance with the information on the display and confirm with [**OK**].
 - Zeroing starts (5 s)
 - Volume calculation is carried out (bar shows progress of the calculation)
 - Volume is displayed.
4. Adopt measurement result: [**Apply**].

6.2.4. Gas pipe (TRGI 2008)

⚠ WARNING
<p>Risk of explosion due to hazardous gas/air mixtures</p> <ul style="list-style-type: none"> > Do not feed air into pipes carrying gas. > Observe the information for the instrument if there is a risk that air is being routed into pipes carrying gas.

CAUTION
<p>Avoid damage to the instrument due to high pressure!</p> <ul style="list-style-type: none"> > The test pressure of 1.2 bar must not be exceeded.

There are 5 different test types to choose from:

Test type	Explanation
Pretest	The pretest (using air) is used for the load test (stability test) of newly laid gas pipes. The test is performed on the pipe without gas meter and fittings.
Main test	The main test (using air or inert gas, e. g. CO ₂ or N ₂) is used for the tightness test (acceptance test) on newly laid or renovated pipes. The test is performed at the pipe, including the fittings, without gas installations and corresponding control and safety equipment.

Test type	Explanation
Leakage test	This measurement is carried out to test the serviceability of an existing gas pipe system and is used to check the actual condition of the pipes. The pipe system may be in operation or disused. After handover of a gas system, the operator is responsible for proper operation, which is why it is recommended that the serviceability test is carried out every 12 years.
Combined pretest/main test	This measurement is carried out for newly laid pipe systems with operating pressures of 100 mbar to 1 bar. The test includes pipe systems including fittings, but without gas pressure controllers, gas appliances, gas meters and relevant regulating and safety devices.
Caravan check	Tightness test on gas pipes in accordance with the EN 1949 standard and DVGW G 607. Since 1 April 2006, a valid G 607 test is a requirement for the HU (general inspection) with the TÜV (German Technical Inspection Agency). Caravan and motorhome owners are obliged to have their liquid gas systems checked every 2 years.

6.2.4.1. Pretest

This test is used as a load test for newly laid gas pipes and is carried out before the main test. The test is performed on the pipe without a gas meter and fittings. The pipe is subjected to many times the subsequent operating pressure, so the material is exposed to a significantly greater load than is expected during normal operation.

Calling up the function:

>  → **Measurements** → **[OK]** → **Gas pipe (TRGI 2008** → **Pretest** → **[OK]**.

Setting parameters

Parameter	Explanation
Stability time	Set stability time
Measurement period	Adopt or set measurement period
	i According to DVGW TRGI 2008, the measurement period is 10 min.
Test pressure (target)	Adopt or set test pressure
	i According to DVGW TRGI 2008, the test pressure (target) is 1000 mbar
Pressure	Set pressure

1. Edit values: **[Edit]**.
2. Enter values. **[▲]**, **[▼]** and sometimes **[◀]**, **[▶]** → **[OK]**.

Carrying out a pretest

1. Build up test pressure (target) manually with the test pump or a compressor at the connection provided.
2. Close the shut-off valve.

i The valve must always be closed during measurements. Only open to apply pressure. Close it again

3. Start measurement: **[▶]**.
 - Zeroing starts (5 s)
 - Option
 - > End stability time early: **[Next]**
 - > End measurement period early: **[Next]**
 - Pretest is ended.
4. Evaluate measurement result: **[▲]**, **[▼]** → **[OK]**.
 - The measurement result is displayed
5. Save measurement result: **[Save]**.

Options

- > **[Options]** → **Show Graphic**: a section of past measuring values is displayed in a line graph (zoom function available **[▲]**, **[▼]**).
- > **[Options]** → **Manometer**: the measuring values are displayed in the same way.

- > **[Options]** → **Factory setting**: the values are reset to the default settings.
- > **[Options]** → **Overall graphic curve**: the measuring values across the overall measuring time are displayed in a line graph.

6.2.4.2. Main test

The main test (using air or inert gas such as CO₂ or N₂) is a tightness test for pipes including fittings, but without gas appliances and the relevant regulating and safety devices. The main test is carried out after a successfully completed pretest on newly laid gas pipes or after renovation of existing gas pipes and is used for the acceptance of these pipes. It shows up even the smallest leaks in gas pipes.

Calling up the function:

- > **[Menu]** → **Measurements** → **[OK]** → **Gas pipe (TRGI 2008)** → **Main test** → **[OK]**.

Setting parameters

- i** According to DVGW TRGI 2008, the stability time and measurement period depend on the pipe volume.
- Pipe volume < 100 l: Adjustment time 10 min, measurement period 10 min.
 - Pipe volume > 100 l - < 200 l: Adjustment time 30 min, measurement period 20 min.
 - Pipe volume > 200 l: Adjustment time 60 min, measurement period 30 min.

Parameter	Explanation
Volume	Set volume i The pipe volume can also be measured directly, see [Options] → Volume
Stability time	Set stability time
Measurement period	Set measurement period
Test pressure (target)	Set test pressure i According to DVGW TRGI 2008, the test pressure (target) is 150 mbar.

1. Edit values: **[Edit]**.
2. Enter values. **[▲]**, **[▼]** and sometimes **[◀]**, **[▶]** → **[OK]**.

Carrying out a main test

1. Start measurement: [▶].
 - Zeroing starts (5 s)
 - Test pressure (target) is built up automatically by the instrument
 - Option
 - > End stability time early: [Next]
 - > End measurement period early: [Next]
 - Main test is ended.
2. Evaluate measurement result: [▲], [▼] → [OK].
 - The measurement result is displayed
3. Save measurement result: [Save].

Options

- > [Options] → **Show Graphic**: a section of past measuring values is displayed in a line graph (zoom function available [▲], [▼]).
- > [Options] → **Volume**: The pipe volume is determined directly (the option is no longer available after the measurement).
- > [Options] → **Manometer**: The measuring values are displayed in the same way.
- > [Options] → **Factory setting**: the values are reset to the default settings.
- > [Options] → **Overall graphic curve**: the measuring values across the overall measuring time are displayed in a line graph.

6.2.4.3. Leakage test (leakage measurement)

This measurement is carried out to test the serviceability of an existing gas pipe system (in contrast to the pretest and main test) and is used to check the actual condition of the pipes. The pipe system may be in operation or disused

For the serviceability test, the testo 324 can be operated together with the feeding unit. The feeding unit supplies the test medium (gas or air).

The advantages of a measurement with the feeding unit:

- Pressure fluctuations that may occur in gas pipes and affect the measurement are compensated (test independent of the gas supply).
- No need to dismantle the gas meter/the instrument can be used at any point on the system.
- Safe measurements thanks to the feed-in of gas, as there is no risk caused by air in a pipe carrying gas.

Test pressure:

- Operating pressure <30 mbar = reference pressure (23 mbar)
- Operating pressure >30 mbar = operating pressure



According to DVGW TRGI 2008, the stability time and measurement period depend on the pipe volume.

- Pipe volume < 100 l: Adjustment time 10 min, measurement period 5 min.
- Pipe volume < 200 l: Adjustment time 30 min, measurement period 10 min.
- Pipe volume < 300 l: Adjustment time 60 min, measurement period 15 min.
- Pipe volume < 400 l: Adjustment time 120 min, measurement period 20 min.
- Pipe volume < 500 l: Adjustment time 240 min, measurement period 25 min.

Calling up the function:

1. [F4] → **Measurements** → [OK] → **Gas pipe (TRGI 2008** → **Leakage test** → [OK].
2. Select **Feeding with gas** (feeding unit required), **Feeding with air, as gas meter replacement**: [▲], [▼] → [OK].

Setting parameters

Parameter	Explanation
Volume	Set volume The pipe volume can also be measured directly, see [Options] → Volume
Stability time	Set stability time
Measurement period	Set measurement period
Pipe type	Set pipe type

1. Edit values: [Edit].
2. Enter values. [▲], [▼] and sometimes [◀], [▶] → [OK].

Carrying out a leakage test (leakage measurement)

1. Start measurement: [▶].
 - > When **Feeding with gas**, **Feeding with air** is selected: carry out steps in accordance with the information on the display and confirm with [OK].
 - Zeroing starts (5 s)
 - Regulation
 - Option
 - > End stability time early: [Next]
 - > End measurement period early: [Next]
 - Measurement is cancelled.
 - Leakage test (leakage measurement) is ended.
2. Evaluate measurement result: [▲], [▼] → [OK].
 - The measurement result is displayed
3. Save measurement result: [Save].
 - The measurement result is displayed
4. Evaluate measurement result:

Leakage test result	Select result
Visual check	Select result
System checked	Enter system details
Gas meter number	Enter gas meter number
Gas meter level	Enter gas meter level
Inspector	Enter name of inspector

5. Edit values: [Edit].
6. Enter values. [▲], [▼] and sometimes [◀], [▶] → [OK].
7. Save entries: [Save].

Option

- > [Options] → **Show Graphic**: a section of past measuring values is displayed in a line graph (zoom function available [▲], [▼]).
- > [Options] → **Settings**: The type of test (reference pressure/operating pressure) can be set and the reference pressure of 23 mbar is displayed.
- > [Options] → **Volume**: the pipe volume is determined directly (the option is no longer available after the measurement).
- > [Options] → **Manometer**: the measuring values are displayed in the same way.

- > **[Options]** → **Factory setting**: the values are reset to the default settings.
- > **[Options]** → **Overall graphic curve**: the measuring values across the overall measuring time are displayed in a line graph.

6.2.4.4. Combined pretest/main test

The combined pretest/main test is carried out on newly laid pipe systems with operating pressures of 100 mbar to 1 bar.

The test includes pipe systems including fittings, but without gas pressure controllers, gas appliances, gas meters and relevant regulating and safety devices.



A high pressure probe is required for this test.

Calling up the function:

- > **[Menu]** → **Measurement** → **[OK]** → **Gas pipe (TRGI 2008)** → **Combined Pre-/ Maintest** → **[OK]**.

Setting parameters

Parameter	Explanation
Volume	Set volume The pipe volume can also be measured directly, see [Options] → Volume
Stability time	Set stability time
Measurement period	Set measurement period
Test pressure (target)	Set test pressure

1. Edit values: **[Edit]**.
2. Enter values. **[▲]**, **[▼]** and sometimes **[◀]**, **[▶]** → **[OK]**.

Carrying out a combined pretest/main test

1. Start measurement: **[▶]**.
 - Zeroing starts (5 s)
 - Build up test pressure (target) manually with the test pump or a compressor at the connection provided.

- Option
 - > End stability time early: **[Next]**
 - > End measurement period early: **[Next]**
 - Measurement is cancelled.
 - Combined pretest/main test is ended.
- 2. Evaluate measurement result: **[▲]**, **[▼]** → **[OK]**.
 - The measurement result is displayed
- 3. Save measurement result: **[Save]**.

Options

- > **[Options]** → **Show Graphic**: a section of past measuring values is displayed in a line graph (zoom function available **[▲]**, **[▼]**).
- > **[Options]** → **Manometer**: The measuring values are displayed in the same way.
- > **[Options]** → **Factory setting**: the values are reset to the default settings.
- > **[Options]** → **Overall graphic curve**: the measuring values across the overall measuring time are displayed in a line graph.

6.2.4.5.

Caravan Check

The caravan check is a tightness test in accordance with DVGW G 607 and relates to vehicles with a permanently installed gas system. The whole gas installation is checked.

Call up function:

- > **[📄]** → **Measurements** → **[OK]** → **Gas pipe (TRGI 2008** → **Caravan Check** → **[OK]**.

Set parameters

Parameters	Explanation
Stability time	Set stability time
Measurement period (nominal)	Set measurement period (nominal)
Diff. pressure Δp_{max}	Set maximum permissible differential pressure
Pressure build-up	Automatic Pressure is built up automatically via the integrated pressure pump (up to max. 200 mbar, up to max. line volume 5 l)

Parameters	Explanation
Test pressure (nom.)	Set test pressure
Vehicle number	Enter vehicle number
Inspector	Enter inspector's name

1. Edit values: **[Edit]**.
2. Enter values: **[▲]**, **[▼]** and sometimes **[◀]**, **[▶]** → **[OK]**.

Carry out caravan check

1. Start measurement: **[▶]**.
 - Zeroing starts (5 s).
 - Test pressure (nom.) is built up automatically.

i If the test pressure (nom.) is not reached after 2 min. 30 sec., the pressure build-up is terminated and an information is displayed.
Reasons for aborting the pressure build-up can be too much leakage in the gas line.

Option

- > End stability time early: **[Next]**.
- > End measurement period early: **[Next]**.

i If the test pressure drops by more than 10 % within the stabilization or measuring time, the measurement is interrupted and an information is displayed.

- Measurement is cancelled.
 - Caravan check ends.
2. Evaluate measurement result: **[▲]**, **[▼]** → **[OK]**.
 - Measurement result is displayed.
 3. Save measurement result: **[Save]**.

Options

- > **[Options]** → **Show Graphic**: An excerpt of past measuring values is displayed in a line graph (zoom function available **[▲]**, **[▼]**).
- > **[Options]** → **Manometer**: The measuring values are shown in an analogue display.
- > **[Options]** → **Overall graphic curve**: The measuring values across the overall measuring time are displayed in a line graph.

6.2.5. Liquid gas (DVGW TRF 2012)

CAUTION

Avoid damage to the instrument due to high pressure!

> The test pressure of 1.2 bar must not be exceeded.



Liquid gas pipes must be subjected to a pressure test and a main test before corrosion protection is applied, before plastering or any other covering work and before a liquid gas vessel is commissioned (filled). It must be certified that the pipelines have been properly constructed.

There are 3 different test types to choose from:

- Pressure test

During the pressure test, the liquid gas pipes are tested at a higher pressure than the normal operating pressure. This means that the material is exposed to a greater load. The pressure test detects weaknesses and shows up any material defects.

Installed pressure controllers and gas meters must be dismantled before the pressure test. The pressure test is carried out before commissioning.

Pressure testing of liquid gas pipelines must be carried out with air or nitrogen, taking equipment accessories into account. However, it can also be carried out using water as the test medium. According to the TRF (Germany), the pressure during the pressure test must be 1.1 times the permissible pressure (determined by the SSV triggering pressure), but at least 1 bar. A pressure drop is not permissible after expiry of the stability time and measurement period.
- Main test

The main test (using air or inert gas, e.g. CO₂ or N₂) is carried out immediately before commissioning. It is used as a tightness test (acceptance test) on newly laid or renovated pipes. The test includes all pipelines up to the closed instrument connectors of the gas appliances.

Immediately prior to commissioning and following the pressure test, all pipelines, going as far as the adjustment elements of the instrument, must be tested for tightness using air at an overpressure of 100 mbar (TRF, Germany).
- Repeated testing PS >0.5 bar

Pipelines with PS >0.5 bar must be subjected to a pressure test every 10 years. Pipelines with DN > 25 must be subjected to a main test under operating conditions every 2 years.



- Repeated testing PS ≤ 0.5 bar
Pipelines with PS ≤ 0.5 bar must be subjected to a main test every 10 years.

6.2.5.1. Pressure test

Calling up the function:

- >  → **Measurements** → **[OK]** → **Liquid gas (TRF)** → **Pressure test** → **[OK]**.

Setting parameters

Parameter	Explanation
Stability time	Set stability time
	 TRF 2012 stipulates a stability time of 10 min.
Measurement period	Set measurement period
	 TRF 2012 stipulates a measurement period of 10 min.
Test pressure (target)	Set test pressure
	 TRF 2012 stipulates a test pressure of 1000 mbar.

1. Edit values: **[Edit]**.
2. Enter values. **[▲]**, **[▼]** and sometimes **[◀]**, **[▶]** → **[OK]**.

Carrying out a pressure test

1. Build up test pressure (target) manually with the test pump or a compressor at the connection provided.
2. Start measurement: **[▶]**.
 - Zeroing starts (5 s)
Option
 - > End stability time early: **[Next]**
 - > End measurement period early: **[Next]**
 - Measurement is cancelled.
 - Pressure test is ended.
3. Evaluate measurement result: **[▲]**, **[▼]** → **[OK]**.
 - The measurement result is displayed
4. Save measurement result: **[Save]**.

Options

- > **[Options]** → **Show Graphic**: a section of past measuring values is displayed in a line graph (zoom function available **[▲]**, **[▼]**).
- > **[Options]** → **Manometer**: The measuring values are displayed in the same way.
- > **[Options]** → **Factory setting**: the values are reset to the default settings.
- > **[Options]** → **Overall graphic curve**: the measuring values across the overall measuring time are displayed in a line graph.

6.2.5.2.

Main test

Immediately prior to commissioning and following the pressure test, all pipelines, going as far as the closed instrument connectors of the gas appliances, must be tested for tightness using air at an overpressure of 150 mbar (TRF 2012). The pipelines are deemed leak-proof if, following temperature equalisation, the test pressure does not drop throughout the subsequent 10 minute duration of the test.

Calling up the function:



- > **[📄]** → **Measurements** → **[OK]** → **Liquid gas (TRF)** → **Main test** → **[OK]**.

Setting parameters



Parameter	Explanation
Stability time	Set stability time
Measurement period	Set measurement period i TRF 2012 stipulates a measurement period of 10 min.
Test pressure (target)	Set test pressure i According to TRF 2012, the test pressure is 150 mbar.

1. Edit values: **[Edit]**.
2. Enter values. **[▲]**, **[▼]** and sometimes **[◀]**, **[▶]** → **[OK]**.

Carrying out a main test

1. Start measurement: [].
 - The test pressure (target) is built up automatically by the instrument.
 - Zeroing starts (5 s)
Option
 - > End stability time early: [Next]
 - > End measurement period early: [Next]
 - Measurement is cancelled.
 - Pressure test is ended.
2. Evaluate measurement result: [, ] → [OK].
 - The measurement result is displayed
3. Save measurement result: [Save].

Options

- > [Options] → **Show Graphic**: a section of past measuring values is displayed in a line graph (zoom function available [, )
- > [Options] → **Manometer**: The measuring values are displayed in the same way.
- > [Options] → **Factory setting**: the values are reset to the default settings.
- > [Options] → **Overall graphic curve**: the measuring values across the overall measuring time are displayed in a line graph.

6.2.5.3. Repeated testing (PS>0.5 bar / PS<=0.5 bar)

The aim of this testing is to establish, at the time of testing, whether the pipe is in proper working condition for the intended application and can satisfy the requirements until the next test.

Calling up the function:

- > [] → **Measurements** → [OK] → **Liquid gas (TRF)** → **Repeated testing PS>0.5 bar** or **Repeated testing PS<=0.5 bar** → [OK].

Setting parameters

Parameter	Explanation
Stability time	Set stability time
Measurement period	Set measurement period
	i TRF 2012 stipulates a measurement period of 10 min.
Test pressure (target)	Set test pressure
	i According to TRF 2012, the test pressure is 150 mbar.

1. Edit values: **[Edit]**.
2. Enter values. **[▲]**, **[▼]** and sometimes **[◀]**, **[▶]** → **[OK]**.

Carrying out repeated testing PS>0.5 bar

1. Build up test pressure (target) manually with the test pump or a compressor at the connection provided.
2. Start measurement: **[▶]**.
 - Zeroing starts (5 s)
 - Option
 - > End stability time early: **[Next]**
 - > End measurement period early: **[Next]**
 - Measurement is cancelled.
 - Pressure test is ended.
3. Evaluate measurement result: **[▲]**, **[▼]** → **[OK]**.
 - The measurement result is displayed
- 4 Save the measurement result: **[Save]**.

Options

- > **[Options]** → **Show Graphic**: a section of past measuring values is displayed in a line graph (zoom function available **[▲]**, **[▼]**).
- > **[Options]** → **Manometer**: The measuring values are displayed in the same way.
- > **[Options]** → **Factory setting**: the values are reset to the default settings.
- > **[Options]** → **Overall graphic curve**: the measuring values across the overall measuring time are displayed in a line graph.



6.2.5.4. Carrying out repeated testing PS <0.5 bar

The aim of this testing is to establish, at the time of testing, whether the pipe is in proper working condition for the intended application and can satisfy the requirements until the next test.

Call up a function:

>  → **Measurement options** → **[OK]** → **Liquid gas (TRF)** → **Repeated testing PS < 0.5 bar.**

Setting parameters

Parameter	Explanation
Stability time	Set stability time
Measurement period	Set measurement period  DVGW TRF 2012 and ÖVGW G2/2 specify a measurement period of 10 min.
Test pressure (target)	Set test pressure  DVGW TRF 2012 and ÖVGW G2/2 specify a test pressure of 150 mbar.

1. Edit values: **[Edit]**.
2. Enter values. **[▲]**, **[▼]** and sometimes **[◀]**, **[▶]** → **[OK]**.

Carrying out repeated testing (PS <0.5 bar)

1. Start measurement: **[▶]**.
 - The test pressure (target) is built up automatically by the instrument.
 - Zeroing starts (5 s).
 - Option
 - > End stability time early: **[Next]**.
 - > End measurement period early: **[Next]**.
 - Measurement is cancelled.
 - Pressure test is ended.
2. Evaluate measurement result: **[▲]**, **[▼]** → **[OK]**.
 - The measurement result is displayed.
3. Save measurement result: **[Save]**.

Options

- > **[Options]** → **Show Graphic**: a section of past measuring values is displayed in a line graph (zoom function available [**▲**], [**▼**]).
- > **[Options]** → **Manometer**: The measuring values are displayed in the same way.
- > **[Options]** → **Factory setting**: the values are reset to the default settings.
- > **[Options]** → **Overall graphic curve**: the measuring values across the overall measuring time are displayed in a line graph.

6.2.6. Drinking water (ZVSHK sheet as per DIN EN 806-4)

The drinking water pipes are tested for tightness before commissioning using air/inert gas or water. For reasons of hygiene, it is best if the pipes remain dry until shortly before commissioning and do not undergo a main test using water. It is also recommended that a pressure test be carried out with air as a preventive measure against corrosion in metallic materials.

There are 2 different test types to choose from:

- Testing with air
 - The main test should be carried out with air if:
 - Following the main test, there is prolonged downtime to eliminate the possibility of bacterial growth
 - Following the main test, the pipe system cannot remain completely filled (e.g. frost period)
 - The corrosion resistance of a material of a partially-filled pipe is compromised
 - In buildings with more stringent hygienic requirements (e.g. hospitals), it may be necessary to use inert gases to eliminate the risk of condensation of humidity in the pipeline.
- Testing with water
 - The main test should only be carried out with water if testing is taking place shortly before the commissioning of a drinking water system. According to the ZVSHK sheet as per DIN EN 806-4, there are three different test methods. These depend on various material properties.
 - The main test with water can only be carried out if:
 - From the main test up until the drinking water installation is commissioned, the water is changed regularly (after 7 days at the latest).



- It is guaranteed that the house or construction site water connections are approved for connection and operation.
- The pipe system is filled hygienically.
- The system remains fully filled from the main test up until commissioning (no partial filling!).

6.2.6.1. Testing with air – main test

Calling up the function:

>  → **Measurements** → **[OK]** → **Drinking water** → **Test with air** → **Main test** → **[OK]**.

Setting parameters

Parameter	Explanation
Volume	Set volume
	 The pipe volume can also be measured directly, see [Options] → Volume
Stability time	Set stability time
Measurement period	Set measurement period
	 According to DIN EN 806-4, the test time is at least 120 min after an appropriate stability time and a pipe volume < 100 l. For each further 100 l, the measurement period increases by 20 min.
Test pressure (target)	Set test pressure
	 According to DIN EN 806-4, the test pressure is 150 mbar.

Carrying out a main test

1. Start measurement: .
- Zeroing starts (5 s)
 - The test pressure (target) is built up automatically by the instrument.

Option

- > End stability time early: **[Next]**
- > End measurement period early: **[Next]**
- Main test is ended.
- 2. Evaluate measurement result: **[▲], [▼]** → **[OK]**.
 - The measurement result is displayed
- 3. Save measurement result: **[Save]**.

Options

- > **[Options]** → **Show Graphic**: a section of past measuring values is displayed in a line graph (zoom function available **[▲], [▼]**).
- > **[Options]** → **Volume**: The pipe volume is determined directly (this option is no longer available after the measurement).
- > **[Options]** → **Manometer**: The measuring values are displayed in the same way.
- > **[Options]** → **Overall graphic curve**: the measuring values across the overall measuring time are displayed in a line graph.
- > **[Options]** → **Settings**: The type of test (reference pressure/operating pressure) can be set and the reference pressure of 23 mbar is displayed.

6.2.6.2. Testing with air – pretest

The pretest is carried out to ensure that the test pressure for the pipe system is not exceeded. The pretest is carried out with a maximum test pressure of 3 bar. Once the test pressure is applied, the test time is 10 min.

Cution**Avoid damage to the instrument due to high pressure!**

- > For tests with a test pressure of > 1 bar, a high pressure probe (art. no. 0638 1748) must be used.

Calling up the function:

- > **[📄]** → **Measurements** → **[OK]** → **Drinking water** → **Test with air** → **Pretest** → **[OK]**.

Setting parameters

Parameter	Explanation
Stability time	Set stability time
Measurement period	Set measurement period
	i According to DIN EN 806-4, the test time is 10 min.
Nominal diameter	Select nominal diameter
Test pressure (target)	Set test pressure
	i According to DIN EN 806-4, the test pressure for DN 50 pipes is 3 bar and for DN 50-100 pipes, it is 1 bar.

1. Edit values: **[Edit]**.
2. Enter values. **[▲]**, **[▼]** and sometimes **[◀]**, **[▶]** → **[OK]**.

Carrying out a pretest

1. Build up the test pressure (target) manually, for example with a test pump or a compressor.
2. Start measurement: **[▶]**.
 - Zeroing starts (5 s)
 - Option
 - > End stability time early: **[Next]**
 - > End measurement period early: **[Next]**
 - Pretest is ended.
3. Evaluate measurement result: **[▲]**, **[▼]** → **[OK]**.
 - The measurement result is displayed
4. Save measurement result: **[Save]**.

Options

- > **[Options]** → **Show Graphic**: a section of past measuring values is displayed in a line graph (zoom function available **[▲]**, **[▼]**).
- > **[Options]** → **Manometer**: The measuring values are displayed in the same way.
- > **[Options]** → **Overall graphic curve**: the measuring values across the overall measuring time are displayed in a line graph.

- > **[Options]** → **Settings**: The type of test (reference pressure/operating pressure) can be set and the reference pressure of 23 mbar is displayed.

6.2.6.3. Test with water



A high pressure probe is required for this test.

Calling up the function:

- > **[Menu]** → **Measurements** → **[OK]** → **Drinking water** → **Test with water** → **[OK]**.

Setting parameters

Parameter	Explanation
Pipe material	Select pipe material
Crimp connection	Enable/disable
Stability time	Set stability time The ZVSHK sheet as per DIN EN 806-4 stipulates a stability time of 30 min if there is a significant difference between the ambient and water temperature.
Measurement period	Set measurement period

Parameter	Explanation
Test pressure (target)	Set test pressure  The ZVSHK sheet as per DIN EN 806-4 stipulates the following times and pressures: <ul style="list-style-type: none"> • Testing crimp connections: pressure max. 6 bar, test time 15 min • Testing metal multi-layer composite and PVC pipes: pressure max. 11 bar, test time 30 min • Testing PP, PE, PE-X and PB pipes and combined installations made of metal and multi-layer composite pipes: <ul style="list-style-type: none"> ◦ Pressure 11 bar, test time 30 min ◦ Reduce pressure to 5.5 bar (drain water from system), further test time of 120 minutes.

1. Edit values: **[Edit]**.
2. Enter values. **[▲]**, **[▼]** and sometimes **[◀]**, **[▶]** → **[OK]**.

Carrying out a test

 To prevent the penetration of moisture into the instrument, dry hoses should be used.

- The test pressure (target) must be built up manually.
1. Start measurement: **[▶]**.
 - Zeroing starts (5 s)
 - Option
 - > End stability time early: **[Next]**
 - > End measurement period early: **[Next]**
 - Measurement is cancelled.
 - Testing of crimp connection ended: **[Next]**.
 2. Start pressure test: **[Next]**
 - Zeroing starts (5 s)

- Option
 - > End stability time early: **[Next]**
 - > End measurement period early: **[Next]**
 - Measurement is cancelled.
 - Pressure test is ended.
- 3. Evaluate measurement result: **[▲]**, **[▼]** → **[OK]**.
 - The measurement result is displayed
- 4. Save measurement result: **[Save]**.

Options

- > **[Options]** → **Show Graphic**: a section of past measuring values is displayed in a line graph (zoom function available **[▲]**, **[▼]**).
- > **[Options]** → **Manometer**: The measuring values are displayed in the same way.
- > **[Options]** → **Overall graphic curve**: the measuring values across the overall measuring time are displayed in a line graph.
- > **[Options]** → **Settings**: The type of test (reference pressure/operating pressure) can be set and the reference pressure of 23 mbar is displayed

6.2.7. Waste water (DIN EN 1610) with air

Calling up the function:



- >  → **Measurements** → **[OK]** → **Waste water** → **[OK]**.

Setting parameters



Parameter	Explanation
Test method	Select test method
Pipe material	Select pipe material
Nominal diameter	Select nominal diameter
Stability time	Set stability time
Measurement period	Set measurement period
Test pressure (target)	Set test pressure

1. Edit values: **[Edit]**.
2. Enter values. **[▲]**, **[▼]** and sometimes **[◀]**, **[▶]** → **[OK]**.

Carrying out a main test

1. Start measurement: [].
 - Zeroing starts (5 s)
 - Test pressure (target) is built up automatically by the instrument
Option
 - > End stability time early: **[Next]**
 - > End measurement period early: **[Next]**
 - Measurement is cancelled.
 - Main test is ended.
2. Evaluate measurement result: [, ] → **[OK]**.
 - The measurement result is displayed
3. Save measurement result: **[Save]**.

Options

- > **[Options]** → **Show Graphic**: The measuring values are displayed in the form of a line graph. > **[Options]** → **Show Graphic**: a section of past measuring values is displayed in a line graph (zoom function available [, ]).
- > **[Options]** → **Manometer**: The measuring values are displayed in the same way.
- > **[Options]** → **Overall graphic curve**: the measuring values across the overall measuring time are displayed in a line graph.
- > **[Options]** → **Settings**: The type of test (reference pressure/operating pressure) can be set and the reference pressure of 23 mbar is displayed.

6.2.8. Programs



6.2.8.1. Spot measurement

This program is predefined to carry out a spot measurement of pressure and temperature. The current pressure values (**Press.**, →  **Press.**, **Diff Press. ΔP**) and temperature values (**Temp T1 (ext.)**, **Temp T2 (ext.)** and **Diff.Temp.(ext)**) are displayed.



Calling up the function:

- > [] → **Measurements** → **[OK]** → **Programs** → **Spot measurement** → **[OK]** → **Enable**.
 - Current measuring values are displayed
 - Zeroing starts (5 s)

Option	
Spot measurement	<ol style="list-style-type: none"> 1. [Edit]. 2. Edit program name: → [Edit] → [▲], [▼] and sometimes [◀], [▶] → [OK]. 3. Save changes: [Finished].
Configure measurement view	<ol style="list-style-type: none"> 1. Select the program: [▲], [▼] → [Edit]. 2. Select Measurement view: [▼] → [Edit]. 3. Select parameter: [▲], [▼] → [+] (enabled), [✖] (disabled) 4. Save changes: [Finished].

1. Start measurement: .
 - > End measurement period early: 
 - Measurement is cancelled.
2. Save measurement result: **[OK]**.

Options

- > > **[Options]** → **Show Graphic**: a section of past measuring values is displayed in a line graph (zoom function available **[▲]**, **[▼]**).
- > **[Options]** → **Configure Graphic**: the measurement parameters to be represented (max. 4) can be displayed () or hidden () .
- > **[Options]** → **Number of lines**: change the number of measuring values per display page.
- > **[Options]** → **Manometer**: The measuring values are displayed in the same way.
- > **[Options]** → **Measurement view**: (this function is not available during a measurement): The reading display menu is opened. Up to 8 measurement parameters can be selected.
- > **[Options]** → **Measurement view order**: (this function is not available during a measurement): the reading display order can be changed.
- > **[Options]** → **Note**: customer-specific notes can be stored.

6.2.8.2. Programs 2-5

Four measurement programs for different measurement types can be configured and enabled. The measurement programs are used to save and represent measuring sequences. At the end of the measuring process, the measuring values of a measurement program are automatically saved in a record.

Only one measurement program can be activated in the instrument.

Call up the function:

>  → **Measurements** → **[OK]** → **Programs** → **[OK]**.

Selecting and setting a program:

> Select and set program and then confirm with **[Finished]**.

Setting options:

Parameter	Function
Program	<ol style="list-style-type: none"> 1. Select the program: [▲], [▼] → [Edit]. 2. Edit program name: → [Edit] → [▲], [▼] and sometimes [◀], [▶] → [OK]. 3. Save changes: [Finished].
Configure measurement view	<ol style="list-style-type: none"> 1. Select the program: [▲], [▼] → [Edit]. 2. Select Measurement view: [▼] → [Edit]. 3. Select parameter: [▲], [▼] → [+] (enabled), [x] (disabled), see table below 4. Save changes: [Finished].
Meastime	<ol style="list-style-type: none"> 1. Select the program: [▲], [▼] → [Edit]. 2. Select Gas time: [▼] → [Edit]. 3. Enter values. [▲], [▼] and sometimes [◀], [▶] → [OK]. 4. Save changes: [OK].
Measuring rate	<p>The measuring rate is the storage cycle for mean values It is programmed in units of seconds, minutes, whereby the smallest possible measuring rate depends on the number and type of connected probes.</p> <ol style="list-style-type: none"> 1. Select the program: [▲], [▼] → [Edit]. 2. Select Measuring rate: [▼], [▶] → [Edit]. 3. Enter values. [▲], [▼] and sometimes [◀], [▶] → [OK]. 4. Save changes: [OK].

Parameter	Function
Stability time	<ol style="list-style-type: none"> 1. Select the program: [▲], [▼] → [Edit]. 2. Select Measuring rate: [▼], [▶] → [Edit]. 3. Enter values. [▲], [▼] and sometimes [◀], [▶] → [OK]. 4. Save changes: [OK].

Selectable measurement parameters

Measurement parameter	Description
Press.	Current pressure at the pressure connection ○→
Start pressure	Start pressure at the pressure connection ○→
End pressure	End pressure at the pressure connection ○→
Diff Press. ΔP	Difference between the start pressure and the current pressure at the pressure connection ○→
→○ Press.	Current pressure at the pressure connection →○
→○ Press. ←→ Press.	Differential pressure between the instrument's two pressure connections
Press P1 (ext)	Current pressure of the high pressure probe at probe socket P1
Press P2 (ext)	Current pressure of the high pressure probe at probe socket P2
Start pressure (ext.)	Start pressure of the high pressure probe (P1 or P2)
End pressure (ext)	End pressure of the high pressure probe (P1 or P2)
Diff Press. (ext)	Difference between the start pressure and the current pressure of the high pressure probe
P1(ext)←→P2(ext)	Differential pressure between the current pressure at probe socket P1 and P2
Temp T1 (ext)	Current temperature at probe socket T1
Temp T2 (ext)	Current temperature at probe socket T2

Measurement parameter	Description
Start temperature (ext)	Start temperature at T1 or T2
End temperature (ext)	End temperature at T1 or T2
Diff Temp. (ext)	Difference between the start temperature and the current temperature at T1 or T2
T1(ext)←→T2(ext)	Differential temperature between the current temperature at probe socket T1 and T2
Flow rate	Leak rate calculated via the flow rate sensor
Test press.(targ)	Required test pressure
Diff Press. Δp max	Maximum permissible differential pressure
Diff Temp ΔT max	Maximum permissible differential temperature
Test Result	Option for evaluating the result: Pass Not checked Failed

Enabling/disabling a program:

- > Select the program: [**▲**], [**▼**] → [**Enable**]
 - When enabling a program: The program is enabled and the reading display matching the selected program is opened.
- Zeroing starts (5 s)

i Once the measurement program has been enabled, it is possible to change the parameters **Test press. (targ)**, **Diff. Press. Δp max**, **Diff. Temp ΔT max** and **Test Result**.

1. Select the parameter.
2. [**Options**] → [**Edit**] → [**OK**].
3. Enter values. [**▲**], [**▼**] and sometimes [**◀**], [**▶**] → [**OK**].

Starting the program:

1. Start measurement: .
- If a test pressure (target) has been set, the pressure can be built up automatically by the instrument (up to 300 mbar).

Carry out the steps according to the notes on the display and confirm with [OK].





If the set test pressure (target) is greater than 300 mbar, the test pressure must be built up manually.

Option

- > End stability time early: [Next]
- > End measurement period early: []
- Measurement is cancelled.

2. Save measurement result: [OK].

Options

- > [Options] → **Show Graphic**: a section of past measuring values is displayed in a line graph (zoom function available [, ]).
- > [Options] → **Configure Graphic**: the measurement parameters to be represented (max. 4) can be displayed () or hidden ().
- > [Options] → **Number of lines**: change the number of measuring values per display page.
- > [Options] → **Manometer**: the measuring values are displayed in the same way.
- > [Options] → **Measurement view**: (this function is not available during a measurement): The reading display menu is opened. Up to 8 measurement parameters can be selected.
- > [Options] → **Overall graphic curve**: the measuring values across the overall measuring time are displayed in a line graph.

6.2.9. Controller test

There are 4 different test types to choose from:

Test type	Explanation
Static pressure	The static pressure measurement enables defects in the pressure reducer (controller) and the shut-off valve (ball valve) upstream of the consumer to be detected.
Flow pressure	The flow pressure measurement enable defects in the pressure reducer (controller) to be detected.

Test type	Explanation
SSV triggering pressure	This measurement enables you to ascertain whether the triggering pressure of the SSV (safety shut-off valve) has been set correctly.
SRV triggering pressure	The measurement enables you to ascertain whether the triggering pressure of the SRV (safety relief valve) has been set correctly.

6.2.9.1. Static pressure

The static pressure measurement enables defects in the pressure reducer (controller) and the shut-off valve (ball valve) upstream of the consumer to be detected. It is important to ensure that the valve upstream of the controller is open and the valve upstream of the consumer is closed.

Overview and interpretation of results:

Description	Explanation
Pressure increases	Controller leaks
Pressure drops and then rises again	Ball valve downstream of controller leaks
Pressure is constant	Ball valve and controller OK

Calling up the function:

>  → **Measurements** → **[OK]** → **Controller test** → **[OK]**.

1. Select **Static pressure**. **[▲]**, **[▼]** → **[OK]**.

- Measurement is started.

The following values are displayed:

Parameter	Explanation
Pressure	Current pressure
Start pressure	Pressure at the start of the measurement
Δp	Pressure differential between start pressure and current pressure
Min	Lowest pressure during the current measurement

Parameter	Explanation
Max.	Highest pressure during the current measurement

2. End measurement: [■].
3. Save measurement result: [Save].

Options

- > [Options] → **Show Graphic**: a section of past measuring values is displayed in a line graph (zoom function available [▲], [▼]).
- > [Options] → **Manometer**: the measuring values are displayed in the same way.
- > [Options] → **Overall graphic curve**: the measuring values across the overall measuring time are displayed in a line graph.

6.2.9.2. Flow pressure

Calling up the function:

- > [📄] → **Measurements** → [OK] → **Controller test** → [OK].
- 1. Select **Flow pressure**. [▲], [▼] → [OK].
- Measurement is started

The following values are displayed:

Parameter	Explanation
Pressure	Current pressure
Min	Lowest pressure during the current measurement
Max.	Highest pressure during the current measurement

2. End measurement: [■].
3. Save measurement result: [Save].

Options

- > [Options] → **Show Graphic**: a section of past measuring values is displayed in a line graph (zoom function available [▲], [▼]).
- > [Options] → **Manometer**: the measuring values are displayed in the same way.
- > [Options] → **Overall graphic curve**: the measuring values across the overall measuring time are displayed in a line graph.

6.2.9.3. SAV_triggering pressure

For the measurement, it is important to ensure that the valve upstream of the SSV is open and the valve upstream of the consumer is closed. The pressure downstream of the controller (secondary side) in the gas pipe must be increased. If the triggering pressure is exceeded, the SSV is triggered, indicated by a click, and the gas supply is blocked on the primary side. The existing pressure at the time of the click (secondary side) is the SSV triggering pressure.



The SSV stop must then be manually released again.

Calling up the function:

> → **Measurements** → **[OK]** → **Controller test** → **[OK]**.

1. **SAV_triggering pressure** → **[OK]**.

- Measurement is started
- Gas is released from the pipe into the gas feeding unit. Carry out steps in accordance with the information on the display and confirm with **[OK]**.
- Zeroing starts (5 s).
- The pressure is increased automatically by the instrument.

The following values are displayed:

Parameter	Explanation
Pressure	Current pressure
Max.	Highest pressure during the current measurement

2. End the measurement as soon as the safety shut-off valve closes: **[■]**.

3. Save measurement result: **[Save]**.

Options

> **[Options]** → **Show Graphic**: a section of past measuring values is displayed in a line graph (zoom function available **[▲]**, **[▼]**).

> **[Options]** → **Manometer**: the measuring values are displayed in the same way.

> **[Options]** → **Overall graphic curve**: the measuring values across the overall measuring time are displayed in a line graph.

6.2.9.4. SRV triggering pressure

It is important to ensure that the valve upstream of the SRV is open and the valve upstream of the consumer is closed. The pressure downstream of the controller (secondary side) in the gas pipe must be increased. If the triggering pressure is exceeded, the SRV opens, indicated by a hissing sound, and gas is released on the secondary side. The pressure during opening (secondary side) is the SRV triggering pressure. The SRV closes again automatically once the pressure falls below the triggering pressure.

Calling up the function:



- >  → **Measurements** → [OK] → **Controller test** → [OK].
- 1. **SRV triggering pressure** → [OK].
 - Measurement is started
 - Gas is released from the pipe into the gas feeding unit. Carry out steps in accordance with the information on the display and confirm with [OK].
 - Zeroing starts (5 s).
 - The pressure is increased automatically by the instrument.

The following values are displayed:

Parameter	Explanation
Pressure	Current pressure
Max.	Highest pressure during the current measurement

- 2. End the measurement as soon as the safety shut-off valve closes: .
- 3. Save measurement result: **[Save]**.

Options

- > **[Options]** → **Show Graphic**: a section of past measuring values is displayed in a line graph (zoom function available , ).
- > **[Options]** → **Manometer**: the measuring values are displayed in the same way.
- > **[Options]** → **Overall graphic curve**: the measuring values across the overall measuring time are displayed in a line graph.

6.3. Transferring data

6.3.1. Record printer

To be able to transfer data to a testo record printer via the infrared or Bluetooth interface (optional), the printer used must be enabled, see Printer, page 33.

Data is printed out via . The function is only available if a printout is possible.

6.3.2. PC/pocket PC

Data transfer to a PC can take place via USB, IrDA or Bluetooth®.

You must also refer to the documentation that comes with the software.

6.3.3. Data transfer to IrDA record printer



To transfer data from the testo 324 to the IrDA record printer, the printer can be placed in a storage compartment on top of the testo 324.

7 Maintaining the product

7.1. Cleaning the measuring instrument

- > If the housing of the measuring instrument is dirty, clean it with a damp cloth. Do not use any aggressive cleaning agents or solvents! Mild household cleaning agents and soap suds may be used.

7.2. Regular calibration

Leakage measuring instruments must be calibrated once a year in accordance with DVGW guideline G5952. Calibration is performed by Testo Customer Services or a service centre authorised by testo.

7.3. Replacing the gas bladder

The gas bladder for the feeding unit must be replaced every 5 years (production date stated on barcode sticker on the case). It is replaced by Testo Customer Service or a service centre authorized by Testo.



After replacing the gas bladder, flushing is required (fill and empty the feeding unit once).

Identifying the production date

Barcode sticker 1	Barcode sticker 2
<p>Order no.: 0563 3240 Serial no.: 60373663 Set no.: 0563 3240</p>  <p>(93)05633240 (21)60373663</p>	<p>0563 3240 70</p>  <p>4 029547 012488 Made in Germany Testo AG 504 1 ST</p>
<p>1 2</p> 	<p>1 2</p> 

- 1 Year of production (example: 5 stands for the year 2015)
- 2 Month of production (example: 04 stands for the month of April)

8 Tips and assistance

8.1. Questions and answers

Question	Possible causes/solution
Measuring instrument switches itself off or will not switch on.	Battery spent. > Charge battery
No pressure can be build up, or the pressure is falling.	Inlet or outlet is open. There is a leak. > Check connections. > Check system for leaks.
testo 324 stops responding.	 > Press reset button (1).

If we have not been able to answer your question, please contact your dealer or Testo Customer Service. For contact details, see the back of this document or visit the website www.testo.com/service-contact.

8.2. Accessories and spare parts

Description	Article no.
High pressure probe up to 25 bar	0638 1748
testo 316-2	0632 3162
testo 316-1	0632 0316
Surface probe	0604 0194
Connecting line, length 1.5 m	0430 0143
Connection hose (2 m) for extension purposes Pressure side with coupling pin, test side with coupling	0554 3158
Dual valve connector	0554 3161
Conical test stop 1/2"	0554 3151

Description	Article no.
Conical test stop 3/4"	0554 3155
High-pressure stage stop 3/8" & 3/4"	0554 3163
High-pressure stage stop 1/2" & 1"	0554 3164
High-pressure stage stop 3/4" & 1 1/4"	0554 0533
High-pressure connection	0554 3139
Pressure release plug	0554 3171
Hose set with stop valve	0554 3172
Connection hose 2 m, on both sides with quick-release coupling	0554 0529
Single pipe counter cap	0554 3156
Mains unit	0554 1096
IrDA record printer	0554 0549
testo BLUETOOTH®/ IRDA printer	0554 0620
Spare printer paper (6 rolls)	0554 0568
PC software easyHeat	0554 3332
USB cable	0449 0047
System case incl. feeding unit, connection block and connection hose	0516 3240
Instrument case (height: 130 mm) for instrument, probes and accessories	0516 3300
Carrying strap	0516 0402
TopSafe for testo 316-1	0516 0189
ISO calibration certificate for sensor	0520 0005

For a complete list of all accessories and spare parts, please refer to the product catalogues and brochures or visit our website www.testo.com

8.3. Updating the instrument software

Under www.testo.com/download-center you can download the current instrument software (Firmware) for testo 324 (registration required).

- > Unplug the mains unit and switch off the testo 324.
- 1. Hold down [▲].
- 2. Plug in the mains unit, continue holding down [▲].
 - The display shows **Firmware update** along the bottom edge.
- 3. Release [▲].
- 4. Insert the connecting cable (0449 0047) into the USB-port on the instrument, then connect it to the PC.
 - Your PC recognises the testo 324 as a removable medium.
- 5. Copy the new file (ap324rel.bin) to the detected removable medium.
 - On the display the status bar progresses from left to right. This process may take a few minutes.
- 6. Disconnect the connecting cable from the testo 324.
 - Once the instrument software (firmware) has been updated, the system will automatically reboot and is ready for use.

