

No. GT-P5XD

Air Screwdrivers Oil Xtra Series



A wide variety of air screwdrivers for high efficiency work.

We have developed products such as "Oil Extra" series which is filled with oil in the impact part unit, as well as air tube exhaust models, aiming at reducing noise and vibration.



No. GT-P5XD

Air Screwdrivers

The impact mechanism is filled with lubricating oil. In addition to changing the impact noise to a softer, smoother sound, the oil prevents part damage due to friction.

Applicable Models ※Only for referential purposes.

Small screw	Philips	Applicable Models
M2	0 (Old JIS 1)	S4TFG, S4TG
M2.3	0 (Old JIS 1)	S4TFG, S4TFS, S4TG, S4TS
M2.5	1	S4TFG, S4TFS, S4TG, S4TS, S5TFG, S5TG
M2.6	0 (Old JIS 1)	H4RC, S4TFS, S4TS, S5TFG, S5TG
M3	1 (Old JIS 2)	H4R, H4PR, PH4, H4RC, S4TFS, S4TFR, S4TS, S4TR, S5TFG, S5TFB, S5TG, S5TB
M3.5	2	H4R, H4PR, PH4, H4RC, H5RC, S4TR, S4TFR, S5TFB, S5TB
M4	2	H4R, H4PR, PH4, H5R, H5P, PH5, H5RC, S4.5DR, P4.5DR, PLR, PLP, PLZ, PLRC, P5LS, S4TFR, S4TR, S5TFB, S5TFR, S5TB, S5TR, PLXD, S4.5XD, P4.5XD, PLIXD, P5XD
M4.5	2	H5R, H5P, PH5, H5RC, S4.5DR, P4.5DR, PLR, PLP, PLZ, PLRC, P5LS, S5TFR, S5TR, S5TS, PLXD, S4.5XD, P4.5XD, PLIXD, P5XD
M5	2	H5R, H5P, PH5, S4.5DR, P4.5DR, PLR, PLP, PLZ, PLRC, P5LS, P6LSIII, P6HS, PLHII, P60XD, S6MLR, S6HS, S6CD, S5TFR, S5TR, S5TS, PLXD, S4.5XD, P4.5XD, P6EXD, S6LXD, P6LXD, S60XD, PLIXD, P5XD
M6	3	P6LSIII, P6HS, PLHII, S6MLR, S6HS, S5TS, S6.5D, P6.5D, S6CD, P6EXD, S6LXD, P6LXD, P60XD, S60XD
M8	4 (Old JIS 3)	S6.5D, P6.5D, P8D, P10SII, P60XD, S60XD, P80XD
M10	4	P8D, P10SII, P80XD

Wood screw	Philips	Applicable Models
1.8	—	H4R, H4PR, PH4
2.1	1	H4R, H4PR, PH4
2.4	1	H4R, H4PR, PH4
2.7	1	H5R, H5P, PH5, S4.5DR, P4.5DR, PLR, PLP, PLZ, P5LS, S4.5XD, P4.5XD
3.1	2	H5R, H5P, PH5, S4.5DR, P4.5DR, PLR, PLP, PLZ, P5LS, S4.5XD, P4.5XD
3.5	2	H5R, H5P, PH5, S4.5DR, P4.5DR, PLR, PLP, PLZ, P5LS, P6LSIII, P6HS, PLHII, S6MLR, S6HS, S6CD, PLXD, S4.5XD, P4.5XD, P6EXD, S6LXD, P6LXD, P60XD, S60XD, PLIXD, P5XD
3.8	2	PLHII, P6LSIII, S6MLR, S6HS, P6HS, S6CD, S6.5D, P6.5D, PLXD, P6EXD, S6LXD, P6LXD, P60XD, S60XD, PLIXD, P5XD
4.1	2	PLHII, P6LSIII, S6MLR, S6HS, P6HS, S6CD, S6.5D, P6.5D, P6EXD, S6LXD, P6LXD, P60XD, S60XD
4.5	2	S6.5D, P6.5D, P6EXD, P60XD, P8D, P10SII, S60XD, P80XD
4.8	2	P8D, P10SII, P6EXD, P80XD
5.1	3	P8D, P10SII, P80XD
5.5	3	P8D, P10SII, P80XD
5.8	3	P8D, P10SII, P80XD
6.2	3	P8D, P10SII, P80XD

Tapping screw	Philips	Applicable Models
3.5	2	H5R, H5P, PH5, S4.5DR, P4.5DR, PLR, PLP, PLZ, P5LS, S4.5XD, P4.5XD
4	2	H5R, H5P, PH5, S4.5DR, P4.5DR, PLR, PLP, PLZ, P5LS, P6LSIII, P6HS, PLHII, S6MLR, S6HS, S6.5D, P6.5D, S6CD, PLXD, PLIXD, P5XD, S4.5XD, P4.5XD, P6EXD, S6LXD, P6LXD, P60XD, S60XD
4.2	2	P6LSIII, P6HS, PLHII, S6MLR, S6HS, S6.5D, P6.5D, S6CD, PLXD, PLIXD, P5XD, P6EXD, S6LXD, P6LXD, P60XD, S60XD
4.5	2	P6LSIII, P6HS, PLHII, S6MLR, S6HS, S6.5D, P6.5D, S6CD, P6EXD, S6LXD, P6LXD, P60XD, S60XD
4.8	2	P6.5D, P60XD, S60XD
5	2	P6.5D, P8D, P10SII, P60XD, S60XD, P80XD
5.5	3	P8D, P10SII, P80XD
6	3	P8D, P10SII, P80XD

Hexagonal recess bolt Hexagonal head bolt	H (mm)	H (mm)	Applicable Models
M2.5	2.0	5.0	H4RC
M3	2.5	5.5	H4R, H4PR, PH4, H4RC
M3.5	—	6.0	H4R, H4PR, PH4, H4RC, H5RC
M4	3.0	7.0	H4R, H4PR, PH4, H5R, H5P, PH5, H5RC, S4.5DR, P4.5DR, PLR, PLP, PLZ, P5LS, PLRC, PLXD, S4.5XD, P4.5XD, PLIXD, P5XD
M5	4.0	8.0	H5R, H5P, PH5, S4.5DR, P4.5DR, PLR, PLP, PLZ, P5LS, P6LSIII, P6HS, PLHII, S6MLR, S6HS, S6CD, PLXD, S4.5XD, P4.5XD, P6EXD, S6LXD, P6LXD, P60XD, S60XD, PLIXD, P5XD
M6	5.0	10.0	P6LSIII, P6HS, PLHII, S6MLR, S6HS, S6.5D, P6.5D, S6CD, P6EXD, S6LXD, P6LXD, P60XD, S60XD
M7	—	11.0	S6.5D, P6.5D, P60XD, S60XD
M8	6.0	13.0 (Small bolt 12.0)	S6.5D, P6.5D, P8D, P10SII, P60XD, S60XD, P80XD
M10	8.0	16.0 (Old JIS 17.0) Small bolt 14.0)	P8D, P10SII, P80XD

HAND TOOLS

BITS & SOCKETS

ELECTRIC TOOLS

AIR TOOLS

STATIC SOLUTIONS

GASOLINE ENGINE TOOLS

Standard screw **4~5mm** Compact, lightweight and high revolution motor. For recycle plant, small sash frame, etc.

Oil Xtra Series

←See P138



No. GT-S4.5XD

Bit sleeve retainer

Noise reducer

No. GT-P4.5XD

Bit sleeve retainer

Noise reducer/Rear exhaust



No. GT-PLXD

Bit sleeve retainer

Adjust dial

Noise reducer



No. GT-P5XD NEW

Bit sleeve retainer

Noise reducer/Rear exhaust



No. GT-PLIXD

Bit sleeve retainer

Adjust dial

Noise reducer

Suppress noise with air tube

See P141 One point→

Standard screw **5~6mm** Stable tightening performance with high power. For sash frame for building, exterior, home building, etc.



No. GT-S6LXD

Bit sleeve retainer

Adjust dial

Noise reducer

No. GT-P6LXD

Bit sleeve retainer

Noise reducer/Rear exhaust



Model No.	Capacity (mm)				No Load Speed (rpm)	Air Consumption (m ³ /min)	Hose Coupling	Overall Length (mm)	Weight (g)	Accessories		EDP No.
	Standard Screw	Tapping Screw	Wood Screw	Bolt						Bit	Plug	
GT-S4.5XD	4.0~5.0	3.5~4.0	2.7~3.5	4.0~5.0	14,500	0.2	G 1/4	188	585	A14 Φ 2×65G	BPN-2F	311085
GT-P4.5XD	4.0~5.0	3.5~4.0	2.7~3.5	4.0~5.0	14,000	0.2	Rc 1/4	170	735	A14 Φ 2×65G	BPB-2	311089
GT-PLXD	4.0~5.0	3.8~4.2	3.3~3.8	4.0~5.0	11,000	0.35	G 1/4	198.5	670	A14 Φ 2×65G	BPN-2F	311113
GT-P5XD	4.0~5.0	3.5~4.0	3.3~3.8	4.0~5.0	11,000	0.33	Rc 1/4	172	790	A14 Φ 2×65G	BPB-2	311100
GT-PLIXD	4.0~5.0	3.8~4.2	3.3~3.8	4.0~5.0	7,300	0.29	G 1/4	198	740	A14 Φ 2×65G	BPN-2F Tube fitting PL8-02	311114
GT-S6LXD	5.0~6.0	4.0~4.5	3.6~4.1	5.0~6.0	12,000	0.4	G 1/4	212	815	A14 Φ 2×65G	BPN-2F	311115
GT-P6LXD	5.0~6.0	4.0~4.5	3.6~4.1	5.0~6.0	12,500	0.45	Rc 1/4	184	876	A14 Φ 2×65G	BPB-2	311116

·Air pressure: 0.6MPa ·Air hose diameter: 6.35mm ·Overall length and Weight: Accessories not included.
 ·Capacity is listed as instant reference and depends on operation conditions.

·w/Rotary parts oil (VG-10), Impact parts oil (VG-32)

Bit installation anvil application

Unless otherwise mentioned, following type is a standard.

Standard type in Japan

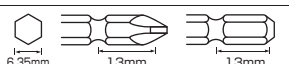

※Option: Following retainer anvil is available.

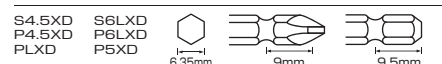

Standard screw **6~8mm** Powerful torque force. For installing parts, fastening concrete screw, etc.

Oil Xtra Series



No. GT-P60XD

6.35 Bit sleeve retainer

3 Adjust dial

Noise reducer/Rear exhaust



No. GT-S60XD

6.35 Bit sleeve retainer

3 Adjust dial

Noise reducer/Rear exhaust



Standard screw **8~10mm** Powerful torque force. For installing parts, fastening concrete screw, etc.



No. GT-P80XD

8 Bit sleeve retainer

4 Adjust dial

Noise reducer/Rear exhaust



Standard screw **5~6mm** High power models for construction.



No. GT-P6EXD

6.35 Bit sleeve retainer

3 Adjust dial

Noise reducer/Rear exhaust



Does not damage work piece with protector.

One point

Suppress noise with air tube

Exhaust noise is reduced by mounting existing $\varnothing 8$ air tube.

No. GT-PLIXD

-8dB

※No-load noise
Approx. **78dB**

Compared to the existing similar models
with 2m air tube attached.

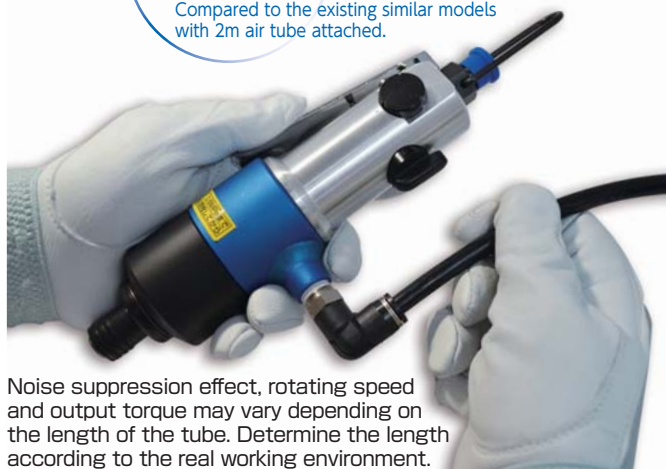

Noise suppression effect, rotating speed and output torque may vary depending on the length of the tube. Determine the length according to the real working environment.

Model No.	Capacity (mm)				No Load Speed (rpm)	Air Consumption (m ³ /min)	Hose Coupling	Overall Length (mm)	Weight (g)	Accessories			EDP No.
	Standard Screw	Tapping Screw	Wood Screw	Bolt						Bit	Plug	L-wrench	
GT-P60XD	6.0~8.0	4.0~5.0	3.8~4.5	6.0~8.0	7,500	0.38	Rc 1/4	176	1,130	A14 $\varnothing 2 \times 65E / \varnothing 3 \times 65E$	BPB-2	-	324021
GT-S60XD	6.0~8.0	4.0~5.0	3.8~4.5	6.0~8.0	7,500	0.38	Rc 1/4	198	1,030	A14 $\varnothing 2 \times 65E / \varnothing 3 \times 65E$	BPB-2	-	324023
GT-P80XD	8.0~10.0	5.0~6.0	4.5~6.2	8.0~10.0	7,000	0.4	Rc 1/4	172	1,520	A15 $\varnothing 2 \times 65G / \varnothing 3 \times 65E$	BPB-2	H4	324050
GT-P6EXD	5.0~6.0	4.0~4.5	3.6~4.8	5.0~6.0	9,300	0.55	Rc 1/4	155	1,085	A14 $\varnothing 2 \times 65G$	BPB-2	-	311150

*Air pressure: 0.6MPa *Air hose diameter: 6.35mm *Overall length and Weight: Accessories not included.
*Capacity is listed as instant reference and depends on operation conditions.

-w/Rotary parts oil (VG-10), Impact parts oil (VG-32)

Bit installation anvil application

Unless otherwise mentioned, following type is a standard.

Standard type in Japan

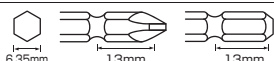

※Option: Following retainer anvil is available.

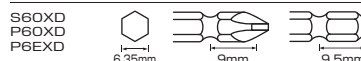

Standard screw **2.6~3.5mm** Speed-reduction type air driver.

Standard screw **3.5~4.5mm** Speed-reduction type air screwdriver.



No. GT-H4RC

6.35 Ball spring retainer
Noise reducer

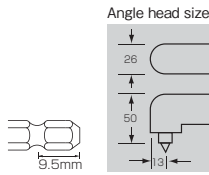

No. GT-H5RC

6.35 Ball spring retainer

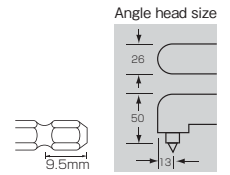

Standard screw **3~4mm** Compact, lightweight and silent gear speed-reduction mechanism.



No. GT-H4R

6.35 Ball spring retainer
Lever push starting/Noise reducer



No. GT-H4PR

6.35 Ball spring retainer
Push starting/Noise reducer

Standard screw **4~5mm** Stable tightening performance with high power. For installing electrical parts.



No. GT-H5R

6.35 Ball spring retainer
Lever push starting



No. GT-H5P

6.35 Ball spring retainer
Push starting/Noise reducer

Model No.	Capacity (mm)				No Load Speed (rpm)	Air Consumption (ml/min)	Hose Coupling	Overall Length (mm)	Weight (g)	Accessories		EDP No.
	Standard Screw	Tapping Screw	Wood Screw	Bolt						Bit	Plug	
GT-H4R	3~4	—	1.8~2.4	3~4	1,500	0.2	G 1/4	190	590	A14 Φ 2×65G	BPN-2F	311036
GT-H4PR	3~4	—	1.8~2.4	3~4	1,500	0.19	G 1/4	213	610	A14 Φ 2×65G	BPN-2F	311046
GT-H4RC	2.6~3.5	—	—	2.6~3.5	1,500	0.2	G 1/4	216	735	B39 Φ 2×23H	BPN-2F	311034
GT-H5R	4~5	3.5~4	2.7~3.5	4~5	1,500	0.25	G 1/4	225	880	A14 Φ 2×65G	BPN-2F	311066
GT-H5P	4~5	3.5~4	2.7~3.5	4~5	1,500	0.25	G 1/4	235	880	A14 Φ 2×65G	BPN-2F	311065
GT-H5RC	3.5~4.5	—	—	3.5~4.5	1,500	0.25	G 1/4	248	1,047	B39 Φ 2×23H	BPN-2F	311064

·Air pressure: 0.6MPa ·Air hose diameter: 6.35mm ·Overall length: Accessories and hanger parts not included. ·Weight: Accessories not included.
·Capacity is listed as instant reference and depends on operation conditions.

Bit installation anvil application

Unless otherwise mentioned, following type is a standard.

Standard type in Japan

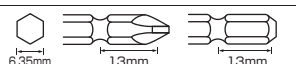

※Option: Following retainer anvil is available.

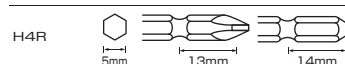

 Standard screw **4~5mm** Compact and lightweight. Basic models for assembly plant.



No. GT-S4.5DR

6.35 Bit sleeve retainer

Noise reducer



No. GT-P4.5DR

6.35 Bit sleeve retainer

Noise reducer/Rear exhaust



No. GT-PLR

6.35 Ball spring retainer

3 Adjust dial



No. GT-P5LS

6.35 Bit sleeve retainer

Noise reducer/Rear exhaust



No. GT-PLP

6.35 Ball spring retainer

Push starting/Noise reducer



No. GT-PLZ

6.35 Bit sleeve retainer

3 Adjust dial

Noise reducer



Model No.	Capacity (mm)				No Load Speed (rpm)	Air Consumption (m ³ /min)	Hose Coupling	Overall Length (mm)	Weight (g)	Accessories		EDP No.	
	Standard Screw	Tapping Screw	Wood Screw	Bolt						Bit	Plug		
GT-S4.5DR	4.0~5.0	3.5~4.0	2.7~3.5	4.0~5.0	14,000	0.2	G 1/4	180	585	A14 Φ 2×65G	BPN-2F	311084	
GT-P4.5DR	4.0~5.0	3.5~4.0	2.7~3.5	4.0~5.0	14,000	0.2	Rc 1/4	160	715	A14 Φ 2×65G	BPB-2	311088	
GT-PLR	4.0~5.0	3.5~4.0	2.7~3.5	4.0~5.0	9,000	0.2	G 1/4	187	830	A14 Φ 2×65G	BPN-2F	311097	
GT-P5LS	4.0~5.0	3.5~4.0	2.7~3.5	4.0~5.0	9,000	0.2	Rc 1/4	165	980	A14 Φ 2×65G	BPB-2	Air regulator	311099
GT-PLP	4.0~5.0	3.5~4.0	2.7~3.5	4.0~5.0	9,000	0.2	G 1/4	197	750	A14 Φ 2×65G	BPN-2F	311095	
GT-PLZ	4.0~5.0	3.5~4.0	2.7~3.5	4.0~5.0	9,000	0.2	G 1/4	205	950	A14 Φ 2×65G	BPN-2F	311111	

*Air pressure: 0.6MPa *Air hose diameter: 6.35mm *Overall length: Accessories and hanger parts not included. *Weight: Accessories not included.
 *Capacity is listed as instant reference and depends on operation conditions.

Bit installation anvil application

Unless otherwise mentioned, following type is a standard.

Standard type in Japan

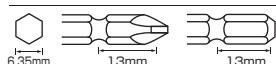

*Option: Following retainer anvil is available.



Standard screw **5~6mm** Compact and lightweight. Basic models for assembly plant.

HAND TOOLS

BITS & SOCKETS

ELECTRIC TOOLS

AIR TOOLS

STATIC SOLUTIONS

GASOLINE ENGINE TOOLS



No. GT-PLHII

- Bit sleeve retainer (Pull type)
- Adjust dial
- OP Anvil (Bit sleeve retainer, push type)



No. GT-P6LSIII

- Bit sleeve retainer (Pull type)
- Noise reducer/Rear exhaust
- OP Anvil (Bit sleeve retainer, push type)
- Rubber grip



Rubber grip type available as option.



No. GT-S6HS

- Bit sleeve retainer
- Adjust dial



No. GT-P6HS

- Bit sleeve retainer
- Noise reducer/Rear exhaust



No. GT-S6MLR

- Bit sleeve retainer (Pull type)
- Adjust dial



Model No.	Capacity (mm)				No Load Speed (rpm)	Air Consumption (ml/min)	Hose Coupling	Overall Length (mm)	Weight (g)	Accessories		EDP No.
	Standard Screw	Tapping Screw	Wood Screw	Bolt						Bit	Plug	
GT-PLHII	5.0~6.0	4.0~4.5	3.6~4.1	5.0~6.0	8,500	0.3	Rc 1/4	213	925	A14 Φ 2×65G	BPB-2	311094
GT-P6LSIII	5.0~6.0	4.0~4.5	3.6~4.1	5.0~6.0	9,000	0.3	Rc 1/4	177	955	A14 Φ 2×65G	BPB-2	311098
GT-S6HS	5.0~6.0	4.0~4.5	3.6~4.1	5.0~6.0	10,000	0.3	G 1/4	220	1,100	A14 Φ 2×65G	BPB-2F	311107
GT-P6HS	5.0~6.0	4.0~4.5	3.6~4.1	5.0~6.0	10,000	0.3	Rc 1/4	180	1,170	A14 Φ 2×65G	BPB-2	Air regulator 311131
GT-S6MLR	5.0~6.0	4.0~4.5	3.6~4.1	5.0~6.0	8,500	0.25	G 1/4	215	1,120	A14 Φ 2×65G	BPB-2F	311106

*Air pressure: 0.6MPa ·Air hose diameter: 6.35mm ·Overall length: Accessories and hanger parts not included. ·Weight: Accessories not included.
 ·Capacity is listed as instant reference and depends on operation conditions.

Bit installation anvil application

Unless otherwise mentioned, following type is a standard.

Standard type in Japan

※Option: Following retainer anvil is available.

Standard screw **4~5mm** Angle impact screwdriver.



No. GT-PLRC

6.35 Ball spring retainer

3 Adjust dial

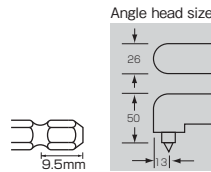

Standard screw **6~8mm** Powerful torque force. Excellent durability.



No. GT-S6.5D

6.35 Bit sleeve retainer

4 Adjust dial

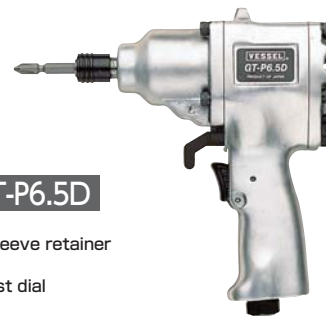

No. GT-P6.5D

6.35 Bit sleeve retainer

3 Adjust dial

Standard screw **8~10mm** High power models. For installing various parts.



No. GT-P8D

8 Bit sleeve retainer

3 Adjust dial

Model No.	Capacity (mm)				No Load Speed (rpm)	Air Consumption (m³/min)	Hose Coupling	Overall Length (mm)	Weight (g)	Accessories			EDP No.
	Standard Screw	Tapping Screw	Wood Screw	Bolt						Bit	Plug	L-wrench	
GT-PLRC	4.0~5.0	—	—	4.0~5.0	9,000	0.2	G 1/4	228	1,100	B39 Φ 2×23H	BPN-2F	—	311112
GT-S6.5D	6.0~8.0	4.0~4.5	3.8~4.5	6.0~8.0	7,500	0.35	Rc 1/4	217	1,300	A14 Φ 2×65E/ Φ 3×65E	BPB-2	H4	324040
GT-P6.5D	6.0~8.0	4.0~5.0	3.8~4.5	6.0~8.0	8,500	0.38	Rc 1/4	152	1,450	A14 Φ 2×65E/ Φ 3×65E	BPB-2	H4	324041
GT-P8D	8.0~10.0	5.0~6.0	4.5~6.2	8.0~10.0	7,500	0.4	Rc 1/4	172	1,930	A15 Φ 2×65G/ Φ 3×65E	BPB-2	H4	324046

*Air pressure: 0.6MPa *Air hose diameter: 6.35mm *Overall length and Weight: Accessories and hanger parts not included.
 *Capacity is listed as instant reference and depends on operation conditions.

Bit installation anvil application

Unless otherwise mentioned, following type is a standard.

Standard type in Japan

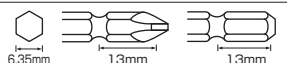

Torque Control Air Screwdriver, Reduced Type

Standard screw **2~2.5mm** Air is automatically shut out when torque reaches a set value.



No. GT-S4TFG

5 Ball spring retainer

Push startup type/Noise reducer/Rear exhaust
 Torque Spring

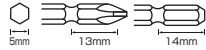

No. GT-S4TG

6.35 Ball spring retainer

Adjust dial type Push startup type/Noise reducer/Rear exhaust
 Torque Spring Hose Coupling(1/8")

Standard screw **2.2~3mm** Air is automatically shut out when torque reaches a set value.



No. GT-S4TFS

5 Ball spring retainer

Push startup type/Noise reducer/Rear exhaust
 Torque Spring

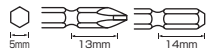

No. GT-S4TS

6.35 Ball spring retainer

Adjust dial type Push startup type/Noise reducer/Rear exhaust
 Torque Spring Hose Coupling(1/8")

Standard screw **3~4mm** Air is automatically shut out when torque reaches a set value.



No. GT-S4TFR

5 Ball spring retainer

Push startup type/Noise reducer/Rear exhaust
 Torque Spring

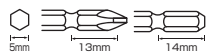

No. GT-S4TR

6.35 Ball spring retainer

Adjust dial type Push startup type/Noise reducer/Rear exhaust
 Torque Spring Hose Coupling(1/8")

Model No.	Capacity Standard Screw (mm)	Torque Range (N·m)	No Load Speed (rpm)	Air Consumption (ml/min)	Hose Coupling	Overall Length (mm)	Weight (g)	Accessories		EDP No.
								Bit	Plug	
GT-S4TFG	2.0~2.5	0.3~0.8	2,300	0.28	Rc 1/8	215	565	B36 Φ 2×70H	—	311206
GT-S4TFS	2.2~3.0	0.5~1.3	1,700	0.28	Rc 1/8	215	555	B36 Φ 2×70H	—	311205
GT-S4TFR	3.0~4.0	0.7~2.1	1,100	0.28	Rc 1/8	215	565	B36 Φ 2×70H	—	311204
GT-S4TG	2.0~2.5	0.3~0.8	2,300	0.28	Rc 1/4	215	650	A14 Φ 2×65G	BPB-2	311203
GT-S4TS	2.2~3.0	0.5~1.3	1,700	0.28	Rc 1/4	215	640	A14 Φ 2×65G	BPB-2	311202
GT-S4TR	3.0~4.0	0.7~2.1	1,100	0.28	Rc 1/4	215	650	A14 Φ 2×65G	BPB-2	311201

·Air pressure: 0.6MPa ·Air hose diameter: 6.35mm ·Overall length: Accessories and hanger parts not included. ·Weight: Accessories not included.
 ·Capacity is listed as instant reference and depends on operation condition.

One point

Torque Spring Change

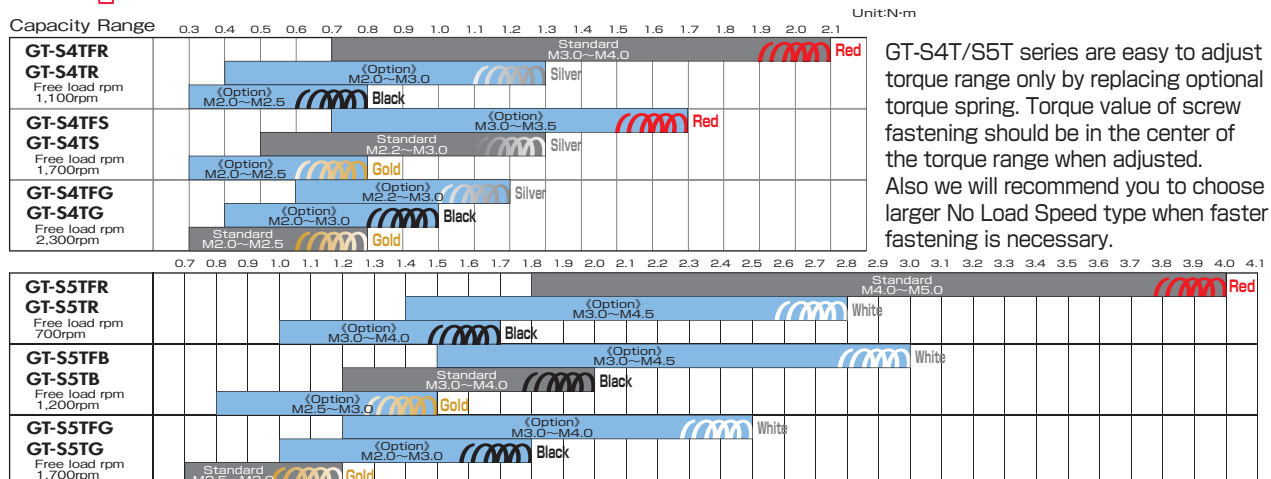

GT-S4T/S5T series are easy to adjust torque range only by replacing optional torque spring. Torque value of screw fastening should be in the center of the torque range when adjusted. Also we will recommend you to choose larger No Load Speed type when faster fastening is necessary.

HAND TOOLS

BITS & SOCKETS

ELECTRIC TOOLS

AIR TOOLS

STATIC SOLUTIONS

GASOLINE ENGINE TOOLS

Standard screw **2.5~3mm** Air is automatically shut out when torque reaches a set value.



No. GT-S5TFG

5 Ball spring retainer

Push startup type/Noise reducer/Rear exhaust
 OP Torque Spring

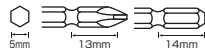

No. GT-S5TG

6.35 Ball spring retainer

Adjust dial type Push startup type/Noise reducer/Rear exhaust
 OP Torque Spring

Standard screw **3~4mm** Air is automatically shut out when torque reaches a set value.



No. GT-S5TFB

5 Ball spring retainer

Push startup type/Noise reducer/Rear exhaust
 OP Torque Spring

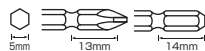

No. GT-S5TB

6.35 Ball spring retainer

Adjust dial type Push startup type/Noise reducer/Rear exhaust
 OP Torque Spring

Standard screw **4~5mm** Air is automatically shut out when torque reaches a set value.



No. GT-S5TFR

5 Ball spring retainer

Push startup type/Noise reducer/Rear exhaust
 OP Torque Spring

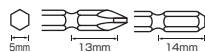

No. GT-S5TR

6.35 Ball spring retainer

Adjust dial type Push startup type/Noise reducer/Rear exhaust
 OP Torque Spring

Torque Control Air Screwdriver, Impact Type

Standard screw **4.5~6mm** Combination between impact and torque control systems gives an excellent workability.

No. GT-S5TS

6.35 Bit sleeve retainer (Pull type)

Adjust dial type



Model No.	Capacity Standard Screw (mm)	Torque Range (N·m)	No Load Speed (rpm)	Air Consumption (ml/min)	Hose Coupling	Overall Length (mm)	Weight (g)	Accessories			EDP No.
								Bit	Plug	L-wrench	
GT-S5TFG	2.5~3.0	0.7~1.2	1,700	0.35	Rc 1/8	243	860	B36 Φ 2×70H	—	—	311215
GT-S5TG	2.5~3.0	0.7~1.2	1,700	0.35	Rc 1/4	260	920	A14 Φ 2×65G	BPB-2	—	311212
GT-S5TFB	3.0~4.0	1.2~2.0	1,200	0.35	Rc 1/8	243	830	B36 Φ 2×70H	—	—	311214
GT-S5TB	3.0~4.0	1.2~2.0	1,200	0.35	Rc 1/4	260	910	A14 Φ 2×65G	BPB-2	—	311211
GT-S5TFR	4.0~5.0	1.8~4.0	700	0.35	Rc 1/8	243	850	B36 Φ 2×70H	—	—	311213
GT-S5TR	4.0~5.0	1.8~4.0	700	0.35	Rc 1/4	260	930	A14 Φ 2×65G	BPB-2	—	311210
GT-S5TS	4.5~6.0	3.9~9.8	6,500	0.25	Rc 1/4	292	1,310	A14 Φ 2×65G	BPB-2	H3	324002

*Air pressure: 0.6MPa *Air hose diameter: 6.35mm *Overall length: Accessories and hanger parts not included. *Weight: Accessories not included.
 *Capacity is listed as instant reference and depends on operation conditions.

Bit installation anvil application

Unless otherwise mentioned, following type is a standard.

Standard type in Japan

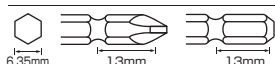

※Option: Following retainer anvil is available.

