

No. GT-C1400

Corner type impact wrench



Compact and lightweight, these impact wrenches have been designed to achieve the best possible balance in the hand, ensuring a secure hold for optimum nut/bolt work.



No. GT-C1400

Corner type impact wrench

Unique mechanism pursuing high hammering efficiency (PAT.P.)
Transverse-mounted hammer part transmitting hammering forces directly to the anvil, it gives high power with its compact body.

HAND TOOLS

BITS & SOCKETS

ELECTRIC TOOLS

AIR TOOLS

STATIC SOLUTIONS

GASOLINE ENGINE TOOLS

Air Impact Wrenches Model Selection Chart

※Fastening torque is based on JIS B1083. (Metric coarse screw, friction coefficient μ : 0.15) The following selection chart is for referential purposes only.

JISB1051 Strength Category																			
		3.6		4.6		4.8		5.6		5.8		6.8		8.8		10.9		12.9	
Screw diameter	Torque (N · m)	Applicabl Models	Torque (N · m)	Applicabl Models	Torque (N · m)	Applicabl Models	Torque (N · m)	Applicabl Models	Torque (N · m)	Applicabl Models	Torque (N · m)	Applicabl Models	Torque (N · m)	Applicabl Models	Torque (N · m)	Applicabl Models	Torque (N · m)	Applicabl Models	
M8	8.7	800	11.0	800	15.6	800	13.7	800 1000	19.2	800 1000	22.0	800 1000	29.3	1000	43.0	1000 1400	50.4	1000 1400	
M10	17.1	800 1000	21.6	1000	30.6	1000	27.0	1000	37.8	1000 1400	43.2	1000 1400	57.6	1000 1400	84.7	1000 1400	99.1	1400 1600	
M12	29.4	1000 1400	37.2	1000 1400	52.7	1400 1600	46.5	1400 1600	65.1	1400 1600	74.4	1400 1600	99.1	1400 1600	145.6	1600 2000	170.4	1600 2000	
M14	46.9	1400	59.3	1400 1600	84.0	1600 2000	74.1	1400 1600	103.8	1400 1600	118.6	1600	158.1	1600 2000	232.2	2000	271.7	2000	
M16	73.0	1600	92.2	1600	130.6	1600 2000	115.3	1600 2000	161.4	1600 2000	184.4	1600 2000	245.9	2000 2500	361.2	2000 2500	422.7	2000 2500	
M18	100.8	1600 2000	127.3	1600 2000	180.4	2000	159.2	2000	222.8	2000	254.7	2000 2500	350.2	2000 2500	498.8	2500	583.6	2500	
M20	142.7	2000	180.3	2000	255.4	2000	225.4	2000	315.5	2000 2500	360.6	2000 2500	495.9	2500	706.2	2500	826.4	2500 3800	
M22	196.6	2000	284.4	2500	351.9	2500	310.5	2500	434.7	2500	496.7	2500 3800	683.0	2500 3800	972.8	3800	1138.4	3800 4200 4800	
M24	245.9	3800	310.7	3800	440.1	3800	388.3	3800	543.7	3800	621.3	3800	854.3	3800	1216.8	3800 4200 4800	1423.9	3800 4200 4800	
M27	365.0	3800	461.0	3800	653.1	3800	576.2	3800	806.7	3800	922.0	3800	1267.7	3800 4200	1805.6	S55R	2112.9	S55R	
M30	494.6	3800	624.8	3800	885.2	3800	781.0	3800	1093.4	3800 4200 4800	1249.6	3800 4200 4800	1718.2	4200 4800 S55R	2447.2	S55R	2863.7		
M33	666.7	3800	842.1	3800	1193.0	3800	1052.6	3800	1473.7	4200 4800	1684.2	S55R	2315.8	S55R	3298.2		3859.6		
M36	862.5	3800	1089.5	4200 4800	1543.4	4200 4800 S55R	1767.8	4200 4800	1906.6	S55R	2178.9	S55R	2996.0		4267.1		4993.4		
M39	1119.6	4200 4800	1414.2	4200 4800	2003.5	S55R	1767.8	S55R	2474.9		2828.5		3889.2		5539.1		6482.0		
M42	1385.0	4200 4800	1749.4	S55R	2478.3	S55R	2186.8	S55R	3061.5		3498.8		4810.9		6851.9		8018.2		
M45	1733.0	S55R	2189.0	S55R	3101.1		2736.3		3830.8		4378.0		6019.8		8573.6		10033.0		
M48	2092.1	S55R	2642.6		3743.7		3303.3		4624.6		5285.3		7267.3		10350.3		12112.1		
M52	2692.9	S55R	3401.6		4818.9		4252.0		5953.8		6803.2		9354.4		13322.9		15590.6		

- 800 : GT-P6 II / S650 / S65W / P65W / S70WK / P60XW / S60XW
- 1000 : GT-P8 II / P80W / P80XW / C900
- 1400 : GT-1400P / P12 / C1400
- 1600 : GT-1600VPX / 1600VPH(L) / 1600VP(L) / P14J (L) / 1600P(L) / P14W / 1600JP
- 2000 : GT-2000PF / P18J(L) / 2000P(L) / S20RW / 1700BX
- 2500 : GT-2500LF / 2500PF / S220W
- 3800 : GT-3900VL / 3900VP / 3900V / 3800LX / S32RW
- 4200 : GT-4200LF / 4200PF / 4200L / 4200
- 4800 : GT-4800VL
- S55R : GT-S55R

HAND TOOLS

BITS & SOCKETS

ELECTRIC TOOLS

AIR TOOLS

STATIC SOLUTIONS

GASOLINE ENGINE TOOLS

 Machine Bolt Dia. **16mm** Compact, lightweight and high power with V shape hammer system.



No. GT-1600VPX

12.7 Retainer ring

④ Adjust dial

Rear exhaust



No. GT-1600VP

12.7 Retainer ring

④ Adjust dial

Rear exhaust



No. GT-1600VPL

12.7 Retainer ring

④ Adjust dial

Rear exhaust



No. GT-1600VPH

12.7 Retainer ring

④ Adjust dial

Rear exhaust

Oil-less type



No. GT-1600VPHL

12.7 Retainer ring

④ Adjust dial

Rear exhaust

Oil-less type



One point

GT-1600VPH/GT-1600VPHL Oilless mechanism

Completely oil-less model with rust-proofing and lubrication treatment on the air passage. Maintenance-free and environmental-friendly impact wrench, not causing oil mist.

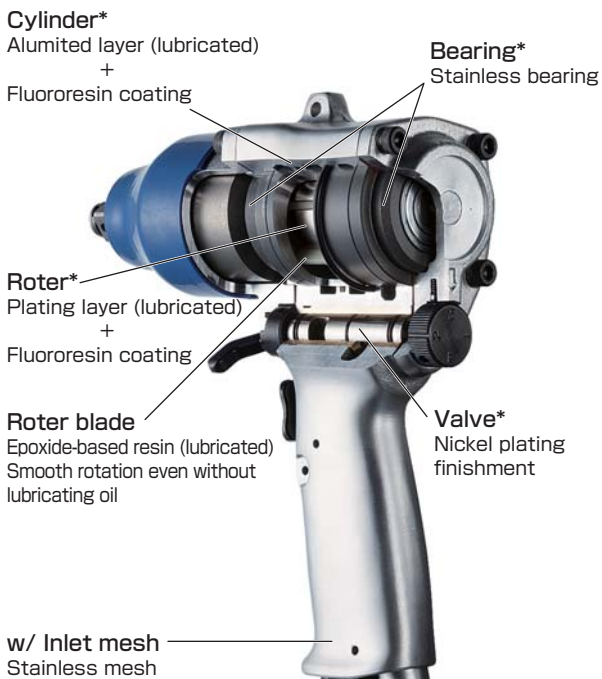

*Rust-proof and lubrication-free

Model No.	Capacity Ordinary Bolt Dia. (mm)	Torque Range (N-m)	Max. Torque (N-m)	No Load Speed (rpm)	Air Consumption (ml/min)	Hose Coupling	Air Hose Inner Dia. (mm)	Overall Length (mm)	Weight (kg)	Accessories		EDP No.
										Plug	L-wrench	
GT-1600VPX	16	49~294.2	360.0	8,200	0.4	Rc 1/4	6.35	169	1.48	BPB-2	H4	336013
GT-1600VP	16	49~304.0	366.7	8,500	0.4	Rc 1/4	6.35	171	1.91	BPB-2	H4	336010
GT-1600VPL	16	49~304.0	366.7	8,500	0.4	Rc 1/4	6.35	199	1.95	BPB-2	H4	336016
GT-1600VPH	16	49~284.3	352.0	8,200	0.4	Rc 1/4	6.35	174.5	1.75	BPB-2	H4	336012
GT-1600VPHL	16	49~284.3	352.0	8,200	0.4	Rc 1/4	6.35	202.5	1.8	BPB-2	H4	336017

•Air pressure: 0.6MPa •Overall length and Weight: Accessories not included. •Capacity is listed as instant reference and depends on operation conditions.

HAND TOOLS

BITS & SOCKETS

ELECTRIC TOOLS

AIR TOOLS

STATIC SOLUTIONS

GASOLINE ENGINE TOOLS

VESSEL Air motor tightens really fast Air Impact Wrenches Super Light V-Hammer

 Machine Bolt Dia. **39mm** Compact, lightweight and high power with V shape hammer system.



No. GT-3900VP

25.4 Retainer ring

 Adjust dial
Rear exhaust



No. GT-3900VL

25.4 Retainer ring

 Adjust dial

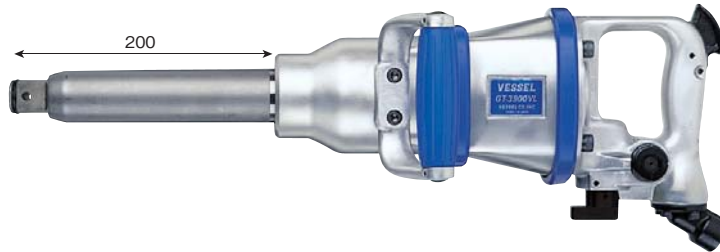

No. GT-3900V

25.4 Retainer ring

 Adjust dial



 Machine Bolt Dia. **48mm** Compact, lightweight and high power with V shape hammer system.



No. GT-4800VL

25.4 Pin-lock

 Adjust dial

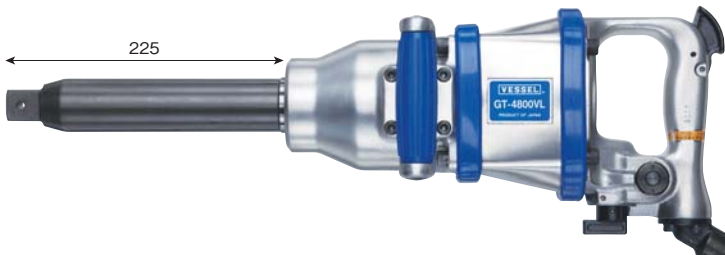

Model No.	Capacity Ordinary Bolt Dia. (mm)	Torque Range (N·m)	Max. Torque (N·m)	No Load Speed (rpm)	Air Consumption (ml/min)	Hose Coupling	Air Hose Inner Dia. (mm)	Overall Length (mm)	Weight (kg)	Accessories		EDP No.
										Plug	L-wrench	
GT-3900VP	39	490~1716	2013.4	4,200	0.7	Rc 3/8	12.7	268	7.95	BPB-3	H5,H6	336118
GT-3900VL	39	490~1716	2094.9	4,200	0.7	Rc 1/2	12.7	524	8.95	BPB-4	H5,H6	336117
GT-3900V	39	490~1716	2094.9	4,200	0.7	Rc 1/2	12.7	358.6	8.2	BPB-4	H5,H6	336113
GT-4800VL	48	343~2010	2542.1	3,200	1.0	Rc 1/2	12.7	559	12.8	1/2"×1/2" (hose nipple)	H6	336121

*Air pressure: 0.6MPa *Overall length and Weight: Accessories not included. *Capacity is listed as instant reference and depends on operation conditions.

HAND TOOLS

BITS & SOCKETS

ELECTRIC TOOLS

AIR TOOLS

STATIC SOLUTIONS

GASOLINE ENGINE TOOLS

Air Impact Wrenches Lightweight F-Hammer Air motor tightens really fast **VESSEL**

 Machine Bolt Dia. **20mm** Models with the best balance between strength and lightness.



No. GT-2000PF

19 Retainer ring

4 Adjust dial

Rear exhaust/Noise reducer



 Machine Bolt Dia. **25mm** Models with the best balance between strength and lightness.



No. GT-2500PF

19 Retainer ring

4 Adjust dial

Rear exhaust/Noise reducer



178



No. GT-2500LF

19 Retainer ring

4 Adjust dial

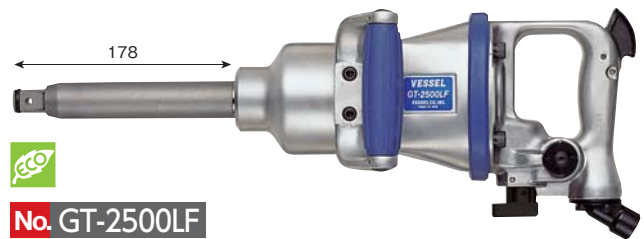

 Machine Bolt Dia. **39mm** Models with the best balance between strength and lightness.



See P153 One point→

No. GT-3800LX PAT.

25.4 Retainer ring

3 Adjust dial

Rear exhaust/
Noise reducer

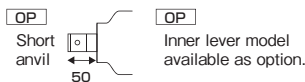

No. GT-3800PX

25.4 Retainer ring

Rear exhaust/Noise reducer



Model No.	Capacity Ordinary Bolt Dia. (mm)	Torque Range (N-m)	Max. Torque (N-m)	No Load Speed (rpm)	Air Consumption (m ³ /min)	Hose Coupling	Air Hose Inner Dia. (mm)	Overall Length (mm)	Weight (kg)	Accessories		EDP No.
										Plug	L-wrench	
GT-2000PF	20	98~460.9	542.7	5,500	0.43	Rc 1/4	9.5	210	3.5	BPB-2	H5	331298
GT-2500PF	25	147~961	1187.7	3,200	0.6	Rc 3/8	9.5	242	6.2	BPB-3	H5	335326
GT-2500LF	25	245~961	1315.2	4,400	0.7	Rc 3/8	9.5	478	7.3	BPB-3	H5,H6	335321
GT-3800LX	39	490~1607	2082.3	4,100	0.7	Rc 1/2	12.7	520	9.8	BPB-4	H5	335373
GT-3800PX	39	490~1607	2063.0	4,100	0.7	Rc 1/2	12.7	270	8.9	BPB-4	H5	335389

*Air pressure: 0.6MPa *Overall length and Weight: Accessories not included. *Capacity is listed as instant reference and depends on operation conditions.

HAND TOOLS

BITS & SOCKETS

ELECTRIC TOOLS

AIR TOOLS

STATIC SOLUTIONS

GASOLINE ENGINE TOOLS

VESSEL Air motor tightens really fast Air Impact Wrenches Lightweight F-Hammer

Machine Bolt Dia. **42mm** Models with the best balance between strength and lightness.



No. GT-4200PF

25.4 Pin-lock

4 Adjust dial



No. GT-4200LF

25.4 Pin-lock

4 Adjust dial

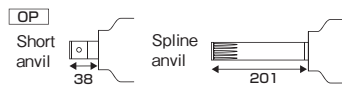
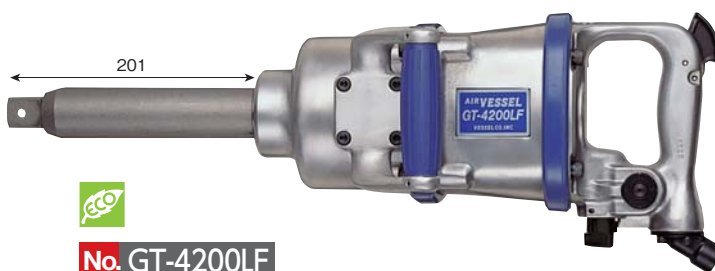

Machine Bolt Dia. **52mm** Models with the best balance between strength and lightness.



No. GT-S55R

25.4 Pin-lock

4 Adjust dial
Noise reducer

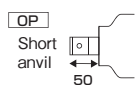

Model No.	Capacity Ordinary Bolt Dia. (mm)	Torque Range (N·m)	Max. Torque (N·m)	No Load Speed (rpm)	Air Consumption (ml/min)	Hose Coupling	Air Hose Inner Dia. (mm)	Overall Length (mm)	Weight (kg)	Accessories		EDP No.
										Plug	L-wrench	
GT-4200PF	42	343~1863	2250	2,500	1.0	Rc 3/8	12.7	297	11.5	BPB-3	H6	335388
GT-4200LF	42	343~1863	2250	3,200	1.0	Rc 1/2	12.7	547	13.3	BPB-4	H6	335385
GT-S55R	52	343~2450	3000	2,800	1.2	Rc 1/2	12.7	610	17.0	1/2"×1/2" (hose nipple)	H6	335391

*Air pressure: 0.6MPa *Overall length and Weight: Accessories not included. *Capacity is listed as instant reference and depends on operation conditions.

One point

Grip shape specialized for working with tires

Designed so that the center of gravity comes to the center of the whole body with the socket and air hose attached.

Very recommended to large tire shops replacing many tires a day.



No. GT-3800LX

HAND TOOLS

BITS & SOCKETS

ELECTRIC TOOLS

AIR TOOLS

STATIC SOLUTIONS

GASOLINE ENGINE TOOLS

Air Impact Wrenches Single Hammer Air motor tightens really fast **VESSEL**

 Machine Bolt Dia. **6~8mm** For strong tightening work. Excellent durability.



No. GT-S650

9.5 Retainer ring

4 Adjust dial



No. GT-P6II

9.5 Retainer ring

3 Adjust dial

 Machine Bolt Dia. **8~10mm** For strong tightening work. Excellent durability.



No. GT-P8II

12.7 Retainer ring

3 Adjust dial

 Machine Bolt Dia. **10mm** Corner type impact wrench.



No. GT-C900 **NEW PAT.P.**

9.5 Retainer ring

4 Adjust dial

 Machine Bolt Dia. **6~8mm** Corner type impact wrench.



No. GT-S600C

9.5 Pin-lock

4 Adjust dial

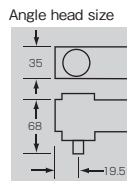

 Machine Bolt Dia. **14mm** Corner type impact wrench.



No. GT-C1400 **PAT.P.**

12.7 Retainer ring

4 Adjust dial



← See P144

Model No.	Capacity Ordinary Bolt Dia. (mm)	Torque Range (N·m)	Max. Torque (N·m)	No Load Speed (rpm)	Air Consumption (ml/min)	Hose Coupling	Air Hose Inner Dia. (mm)	Overall Length (mm)	Weight (kg)	Accessories		EDP No.
										Plug	L-wrench	
GT-S650	6~8	49~121.6	140.5	7,500	0.35	Rc 1/4	6.35	210	1.3	BPB-2	H4	331221
GT-P6II	6~8	49~121.6	140.5	8,500	0.38	Rc 1/4	6.35	146	1.43	BPB-2	H4	331234
GT-P8II	8~10	49~259.8	295.3	7,500	0.4	Rc 1/4	6.35	166	1.89	BPB-2	H4	331244
GT-C900	10	49~100	131.7	7,000	0.25	Rc 1/4	6.35	257	1.9	BPB-2	H3,H4	331228
GT-S600C	6~8	25~47	51.5	7,300	0.35	Rc 1/4	6.35	255	1.87	BPB-2	H4	331226
GT-C1400	14	49~220	241.8	4,500	0.3	Rc 1/4	6.35	277	2.8	BPB-2	H4,H5	331227

*Air pressure: 0.6MPa *Overall length and Weight: Accessories not included. *Capacity is listed as instant reference and depends on operation conditions.

HAND TOOLS

BITS & SOCKETS

ELECTRIC TOOLS

AIR TOOLS

STATIC SOLUTIONS

GASOLINE ENGINE TOOLS

VESSEL Air motor tightens really fast Air Impact Wrenches Single Hammer

 Machine Bolt Dia. **14mm** For strong tightening work. Excellent durability.



No. GT-P12

12.7 Retainer ring

④ Adjust dial



No. GT-1400P

12.7 Retainer ring

④ Adjust dial



 Machine Bolt Dia. **16mm** For strong tightening work. Excellent durability. Long anvil model also available.



No. GT-P14J

12.7 Retainer ring

④ Adjust dial



No. GT-P14JL

12.7 Retainer ring

④ Adjust dial



No. GT-1600P

12.7 Retainer ring

④ Adjust dial



No. GT-1600PL

12.7 Retainer ring

④ Adjust dial



Model No.	Capacity Ordinary Bolt Dia. (mm)	Torque Range (N·m)	Max. Torque (N·m)	No Load Speed (rpm)	Air Consumption (ml/min)	Hose Coupling	Air Hose Inner Dia. (mm)	Overall Length (mm)	Weight (kg)	Accessories		EDP No.
										Plug	L-wrench	
GT-P12	12~14	49~294.1	344.9	7,500	0.4	Rc 1/4	6.35	185	2.3	BPB-2	H4	331262
GT-1400P	12~14	49~294.1	344.9	7,000	0.35	Rc 1/4	6.35	182	2.25	BPB-2	H4	331265
GT-P14J	14~16	75~323.6	409.6	6,500	0.42	Rc 1/4	6.35	197	2.95	BPB-2	H5	331272
GT-P14JL	14~16	75~323.6	365.0	6,500	0.42	Rc 1/4	6.35	226	3.0	BPB-2	H5	331276
GT-1600P	14~16	75~308.9	362.3	6,700	0.36	Rc 1/4	6.35	196	2.7	BPB-2	H5	331275
GT-1600PL	14~16	75~308.9	338.8	6,700	0.36	Rc 1/4	6.35	224	2.8	BPB-2	H5	331277

·Air pressure: 0.6MPa ·Overall length and Weight: Accessories not included. ·Capacity is listed as instant reference and depends on operation conditions.

HAND TOOLS

BITS & SOCKETS

ELECTRIC TOOLS

AIR TOOLS

STATIC SOLUTIONS

GASOLINE ENGINE TOOLS

Air Impact Wrenches Single Hammer Air motor tightens really fast **VESSEL**

 Machine Bolt Dia. **20mm** For strong tightening work. Excellent durability. Long anvil model also available.



No. GT-P18J

19 Retainer ring

4 Adjust dial



No. GT-P18JL

19 Retainer ring

4 Adjust dial

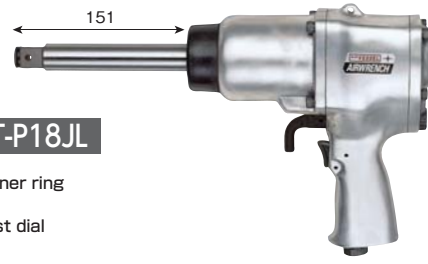

No. GT-2000P

19 Retainer ring

4 Adjust dial



No. GT-2000PL

19 Retainer ring

4 Adjust dial

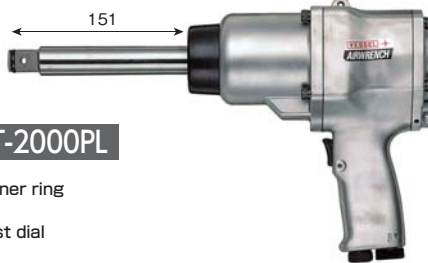

 Machine Bolt Dia. **33mm** For strong tightening work.



No. GT-P32J

25.4 Pin-lock

4 Adjust dial



 Machine Bolt Dia. **42mm** For strong tightening work.

No. GT-4200P

25.4 Pin-lock

4 Adjust dial



No. GT-4200L

25.4 Pin-lock

4 Adjust dial

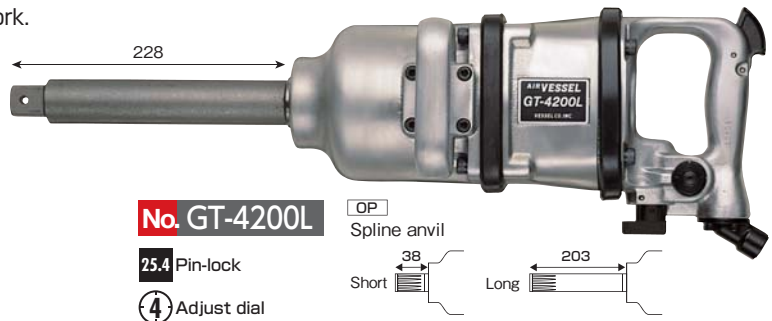

No. GT-4200

25.4 Pin-lock

4 Adjust dial

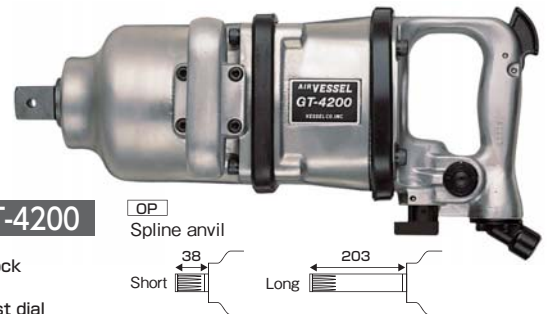

Model No.	Capacity Ordinary Bolt Dia. (mm)	Torque Range (N·m)	Max. Torque (N·m)	No Load Speed (rpm)	Air Consumption (ml/min)	Hose Coupling	Air Hose Inner Dia. (mm)	Overall Length (mm)	Weight (kg)	Accessories		EDP No.
										Plug	L-wrench	
GT-P18J	16~20	98~470.7	556.5	5,000	0.52	Rc 1/4	9.5	240	4.2	BPB-2	H5	331292
GT-P18JL	16~20	98~441.3	471.4	5,000	0.52	Rc 1/4	9.5	353	4.7	BPB-2	H5	331296
GT-2000P	16~20	98~470.7	556.5	5,000	0.45	Rc 1/4	9.5	241	4.3	BPB-2	H5	331295
GT-2000PL	16~20	98~441.3	471.4	5,000	0.45	Rc 1/4	9.5	354	4.7	BPB-2	H5	331297
GT-P32J	33	343~1569	1906.9	3,700	0.8	Rc 3/8	12.7	264	11.2	BPB-3	H6	335181
GT-4200P	27~42	490~1863	2250	2,500	1.0	Rc 3/8	12.7	315	14.2	BPB-3	H6	331335
GT-4200L	27~42	490~1863	2250	3,200	1.0	Rc 1/2	12.7	593	15.9	BPB-4	H6	335378
GT-4200	27~42	490~1863	2267	3,200	1.0	Rc 1/2	12.7	403	14.9	BPB-4	H6	335377

*Air pressure: 0.6MPa ·Overall length and Weight: Accessories not included. ·Capacity is listed as instant reference and depends on operation conditions.

HAND TOOLS

BITS & SOCKETS

ELECTRIC TOOLS

AIR TOOLS

STATIC SOLUTIONS

GASOLINE ENGINE TOOLS

VESSEL Air motor tightens really fast Air Impact Wrenches Double Hammer

Machine Bolt Dia. **6~8mm** Low noise and low vibration. High power and high durability.

Oil Xtra Series



No. GT-S60XW

9.5 Pin-lock

3 Adjust dial

Noise reducer/Rear exhaust

↓ See One point



No. GT-P60XW

9.5 Pin-lock

3 Adjust dial

Noise reducer/Rear exhaust

↓ See One point

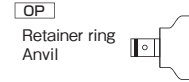

Machine Bolt Dia. **8~10mm** Low noise and low vibration. High power and high durability.



No. GT-P80XW

12.7 Pin-lock

4 Adjust dial

Noise reducer/Rear exhaust

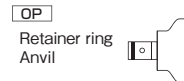

Model No.	Capacity Ordinary Bolt Dia. (mm)	Torque Range (N·m)	Max. Torque (N·m)	No Load Speed (rpm)	Air Consumption (ml/min)	Hose Coupling	Air Hose Inner Dia. (mm)	Overall Length (mm)	Weight (kg)	Accessories			EDP No.
										Socket	Plug	L-wrench	
GT-S60XW	6~8	49~116.8	135.0	7,500	0.38	Rc 1/4	6.35	192	1.0	—	BPB-2	—	324022
GT-P60XW	6~8	49~116.8	135.0	7,500	0.38	Rc 1/4	6.35	169.4	1.1	—	BPB-2	—	324020
GT-P80XW	8~10	49~229.7	242.9	7,000	0.4	Rc 1/4	6.35	163.5	1.48	—	BPB-2	H4	324049

*Air pressure: 0.6MPa *Overall length and Weight: Accessories not included. *Capacity is listed as instant reference and depends on operation conditions.

One point

GT-S60XW / GT-P60XW Quest for easy-to-use tools

Flexible ways to hold. Easy-to-hold grip and balanced body improve workability.

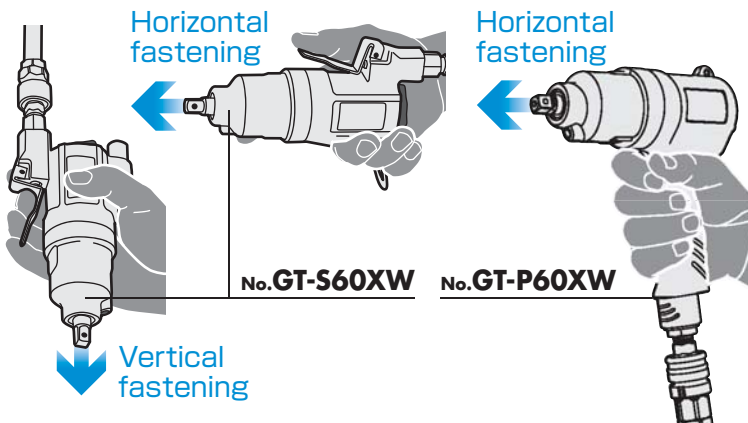

Adjustor and switch to change right/left rotation

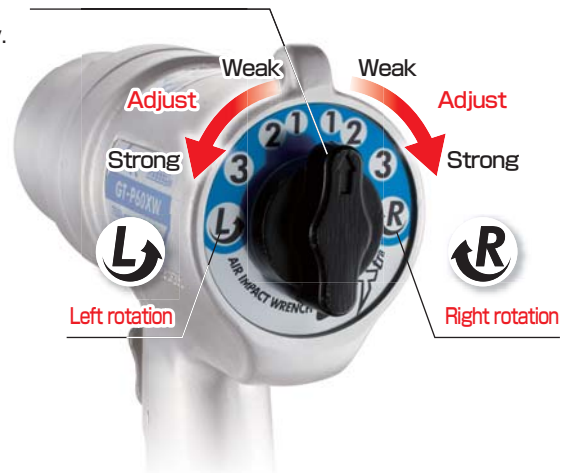

HAND TOOLS

BITS & SOCKETS

ELECTRIC TOOLS

AIR TOOLS

STATIC SOLUTIONS

GASOLINE ENGINE TOOLS

Air Impact Wrenches Double Hammer Air motor tightens really fast **VESSEL**

 Machine Bolt Dia. **5~6mm** For powerful constant fastening. Excellent durability.



No. GT-S6MLRB

9.5 Pin-lock

3 Adjust dial

 Machine Bolt Dia. **6~8mm** Corner type impact wrench.



No. GT-S60CW

9.5 Pin-lock

4 Adjust dial

Angle head size

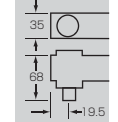

 Machine Bolt Dia. **6~8mm** For powerful constant fastening. Excellent durability.



No. GT-S65W

9.5 Pin-lock

4 Adjust dial



No. GT-P65W

9.5 Pin-lock

3 Adjust dial



No. GT-S70WK

9.5 Pin-lock

4 Adjust dial

Noise reducer/Rear exhaust

 Machine Bolt Dia. **8~10mm** For powerful constant fastening.



No. GT-P80W

12.7 Pin-lock

3 Adjust dial

 Machine Bolt Dia. **12~16mm** For powerful constant fastening.



No. GT-P14W

12.7 Pin-lock

4 Adjust dial

Model No.	Capacity Ordinary Bolt Dia. (mm)	Torque Range (N·m)	Max. Torque (N·m)	No Load Speed (rpm)	Air Consumption (ml/min)	Hose Coupling	Air Hose Inner Dia. (mm)	Overall Length (mm)	Weight (kg)	Accessories			EDP No.
										Socket	Plug	L-wrench	
GT-S6MLRB	5~6	10~39	—	8,500	0.25	G 1/4	6.35	200	1.1	A/F10	BPN-2F	—	311103
GT-P65W	6~8	49~121.6	140.5	8,500	0.38	Rc 1/4	6.35	146	1.43	A/F10	BPB-2	H4	324038
GT-S65W	6~8	49~121.6	140.5	7,500	0.35	Rc 1/4	6.35	210	1.3	A/F10	BPB-2	H4	324008
GT-S70WK	6~8	85~176.5	193.5	7,000	0.39	Rc 1/4	6.35	231	1.3	—	BPB-2	H4	324017
GT-S60CW	6~8	25~47	51.5	7,300	0.35	Rc 1/4	6.35	255	1.87	A/F10	BPB-2	H4	324011
GT-P80W	8~10	49~259.8	295.3	7,500	0.4	Rc 1/4	6.35	164	1.89	A/F14	BPB-2	H4	324048
GT-P14W	12~16	49~421.6	505.0	6,400	0.47	Rc 1/4	9.5	200	3.2	A/F22	BPB-2	H5	324073

*Air pressure: 0.6MPa *Overall length and Weight: Accessories not included. *Capacity is listed as instant reference and depends on operation conditions.

HAND TOOLS

BITS & SOCKETS

ELECTRIC TOOLS

AIR TOOLS

STATIC SOLUTIONS

GASOLINE ENGINE TOOLS

Air Impact Wrenches Double Hammer

Machine Bolt Dia. **20mm** For powerful constant fastening.



No. GT-S20RW

19 Pin-lock

4 Adjust dial

Machine Bolt Dia. **33mm** For powerful constant fastening.



No. GT-S32RW

25.4 Pin-lock

4 Adjust dial

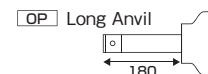

Model No.	Capacity Ordinary Bolt Dia. (mm)	Torque Range (N·m)	Max. Torque (N·m)	No Load Speed (rpm)	Air Consumption (ml/min)	Hose Coupling	Air Hose Inner Dia. (mm)	Overall Length (mm)	Weight (kg)	Accessories		EDP No.
										Plug	L-wrench	
GT-S20RW	20	75~610	928	4,800	0.9	Rc 3/8	9.5	300	5.4	BPB-3	H5	324101
GT-S32RW	33	343~1,569	1801.2	3,600	1.0	Rc 1/2	12.7	380	12.2	BPB-4	H5,H6	324088

·Air pressure: 0.6MPa ·Overall length and Weight: Accessories not included. ·Capacity is listed as instant reference and depends on operation conditions.

Air Impact Wrenches Twin Hammer

Machine Bolt Dia. **16mm** Well balanced, less shock from the impact.



No. GT-1600JP NEW

12.7 Retainer ring

3 Adjust dial

Rear exhaust

Machine Bolt Dia. **20mm** Well balanced, less shock from the impact.



No. GT-1700BX NEW

12.7 Retainer ring

4 Adjust dial

Rear exhaust

Oil lubricating mechanism
Oil protects the hammer unit and reduces irritating noises, preventing parts from being burned.

Model No.	Capacity Ordinary Bolt Dia. (mm)	Torque Range (N·m)	Max. Torque (N·m)	No Load Speed (rpm)	Air Consumption (ml/min)	Hose Coupling	Air Hose Inner Dia. (mm)	Overall Length (mm)	Weight (kg)	Accessories		EDP No.
										Plug	L-wrench	
GT-1600JP	16	50~220	280	10,000	0.6	Rc1/4	6.35	109	1.4	BPB-2	—	336014
GT-1700BX	20	Right rotation 49~450 Left rotation 75~500	Right rotation 480 Left rotation 540	Right rotation 7,000 Left rotation 8,000	0.9	Rc1/4	6.35	192	2.2	—	—	331286

·Air pressure: 0.6MPa ·Overall length and Weight: Accessories not included. ·Capacity is listed as instant reference and depends on operation conditions.

Air Ratchet Wrenches

 Machine Bolt Dia. **10mm** This ratchet tightening system makes it possible to fine-tune the wrenching torque.



The exhaust cover is 360-degree rotatable.

No. GT-R10M

9.5 Ball-lock

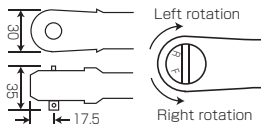

No. GT-R10

9.5 Ball-lock

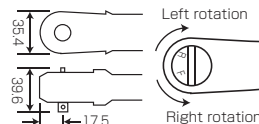

Model No.	Capacity Ordinary Bolt Dia. (mm)	No Load Speed (rpm)	Air Consumption (ml/min)	Hose Coupling	Air Hose Inner Dia. (mm)	Overall Length (mm)	Weight (kg)	Accessories		EDP No.
								Plug		
GT-R10M	10	250	0.3	Rc 1/4	6.35	170	500	BPB-2		339003
GT-R10	10	160	0.4	Rc 1/4	6.35	297	1,090	BPB-2		339001

*Air pressure: 0.6MPa *Overall length and Weight: Accessories not included.

Air Impact Wrenches, Torque Control Type

 Machine Bolt Dia. **6~8mm** Automatic suspensions by torque set-up



No. GT-P6T

9.5 Pin-lock

Adjust dial

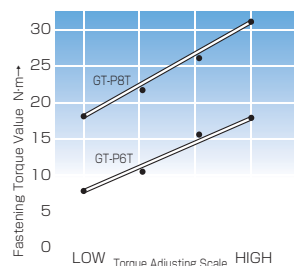

*The above is an actual measurement value by our specified torque tester. It depends upon screw, bolts, nuts, or material differences.

 Machine Bolt Dia. **8~10mm** Automatic suspensions by torque set-up



No. GT-P8T

12.7 Pin-lock

Adjust dial

Model No.	Capacity Ordinary Bolt Dia. (mm)	Torque Range (N·m)	No Load Speed (rpm)	Air Consumption (ml/min)	Hose Coupling	Air Hose Inner Dia. (mm)	Overall Length (mm)	Weight (kg)	Accessories		EDP No.
									Plug	L-wrench	
GT-P6T	6~8	7.8~17.6	3,000	0.27	Rc 1/4	6.35	246	1.5	BPB-2	H3,H4	324003
GT-P8T	8~10	17.6~31.4	2,500	0.31	Rc 1/4	6.35	266	2.2	BPB-2	H3,H4	324005

*Air pressure: 0.6MPa *Overall length and Weight: Accessories not included. *Capacity is listed as instant reference and depends on operation conditions.