



PCE-LOC 20

PCE-LOC 20 Current Calibrator



User manuals in various languages (français, italiano, español, português, nederlands, türk, polski, русский, 中文) can be found by using our product search on: www.pce-instruments.com

Last change: 10 August 2018
v1.0



Contents

1	Safety notes	1
2	PCE-LOC 20 Hardware Parts and Accessories	2
2.1	Unpacking and Inspection	2
2.2	Operational Sections and Connections	3
2.3	Power Options	8
2.4	Battery	8
3	Start Up and Basic Operations	9
3.1	Power ON or OFF	9
3.2	User Interface	9
4	Menu Layout	20
4.1	MENU page	20
4.2	MEASURE Page	20
4.3	SOURCE Page	22
4.4	DISPLAY Page	27
4.5	DATA LOGGING Page	33
4.6	ALARM Page	35
4.7	SETTING Page	37
5	Maintenance and Troubleshooting	39
5.1	Common Problems	39
5.2	Replacing the Battery	40
6	Technical Specifications	40
7	Warranty	42
8	Disposal	42

1 Safety notes

Please read this manual carefully and completely before you use the device for the first time. The device may only be used by qualified personnel and repaired by PCE Instruments personnel. Damage or injuries caused by non-observance of the manual are excluded from our liability and not covered by our warranty.

- The device must only be used as described in this instruction manual. If used otherwise, this can cause dangerous situations for the user and damage to the meter.
- The instrument may only be used if the environmental conditions (temperature, relative humidity, ...) are within the ranges stated in the technical specifications. Do not expose the device to extreme temperatures, direct sunlight, extreme humidity or moisture.
- Do not expose the device to shocks or strong vibrations.
- The case should only be opened by qualified PCE Instruments personnel.
- Never use the instrument when your hands are wet.
- You must not make any technical changes to the device.
- The appliance should only be cleaned with a damp cloth. Use only pH-neutral cleaner, no abrasives or solvents.
- The device must only be used with accessories from PCE Instruments or equivalent.
- Before each use, inspect the case for visible damage. If any damage is visible, do not use the device.
- Do not use the instrument in explosive atmospheres.
- The measurement range as stated in the specifications must not be exceeded under any circumstances.
- To prevent electrical shocks or damage to the instrument, do not connect more than 30 V between the terminals, or between the terminals and the ground.
- This instrument uses a Lithium-Ion battery pack. To prevent an explosion or fire, do not short circuit, do not disassemble and keep it safe from damage.
- To prevent battery leakage or heat generation, only use the battery charger in the temperature range 0 ... 45 °C (32 ... 113 °F).
- To make sure the display shows the correct data, disconnect the test leads before you set the power to on or change to another measure or source function.
- To prevent damage to the display, do not use sharp objects on the screen.
- Only sufficiently skilled persons may use the meter. Qualifications from an approved training establishment may be necessary.
- Follow good engineering practice at all times.
- Non-observance of the safety notes can cause damage to the device and injuries to the user.

We do not assume liability for printing errors or any other mistakes in this manual.

We expressly point to our general guarantee terms which can be found in our general terms of business.

If you have any questions please contact PCE Instruments. The contact details can be found at the end of this manual.



2 PCE-LOC 20 Hardware Parts and Accessories

2.1 Unpacking and Inspection

At the factory each new PCE-LOC 20 passes a careful inspection. It should be free of scrapes and scratches and in proper operation order upon receipt. The recipient should, however, inspect the unit for any damage that may have occurred during transit. If there are signs of obvious mechanical damage, package contents are incomplete, or the instrument does not operate according to its specifications, please contact PCE Instruments as soon as possible.

Delivery contents:

- 1 x Calibrator PCE-LOC 20
- 2 x Laboratory cables with 2 mm plug
- 2 x Adapter 2 mm on 4 mm laboratory cable
- 2 x Alligator clips
- 1 x Mini USB cable
- 1 x Power supply 5V / 1 A
- 1 x Carrying bag
- 1 x User manual

The software can be downloaded here: https://www.pce-instruments.com/english/download-win_4.htm

If you have to return the instrument to the factory for any reason, use the original packing whenever possible. Include a detailed description of the reason for the return, templates are available from PCE Instruments.

2.2 Operational Sections and Connections

All sections and connections are presented in detail on the next pages.

Note: Keep in mind that the next picture (as well as all pictures of PCE-LOC 20 in this manual) has an example configuration of modules. The configuration of your PCE-LOC 20 may vary significantly from the one in the picture.



- 1 Terminal Connection for Measure and Source
- 2 Keypad Section
- 3 Color Display
- 4 USB Connection Slot for PC Communication and Charging

2.2.1 Terminal Connections

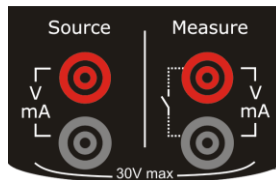

Source Terminals	
mA	Range: 0.000 ... 24.000 mA Resolution: 0.001 mA
mA(2W)	Range: 0.000 ... 24.000 mA Resolution: 0.001 mA
mV	Range: 0.00 ... 250.00 mV Resolution: 0.01 mV
V	Range: 0.000 ... 12.000 V Resolution: 0.001 V



Current Generation

The PCE-LOC 20 is able to generate current both in source and sink mode. In source mode, the PCE-LOC 20 provides the supply power to the loop. In sink mode, an external power supply is used and the PCE-LOC 20 controls the current flow.

The following picture displays the connection for current source for different mode.

mA Current Source

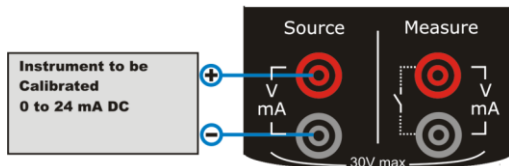

mA 2-Wire Simulation

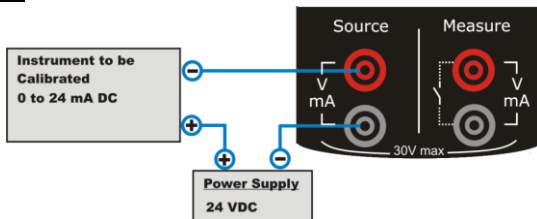

Voltage Generation

The PCE-LOC 20 is capable of voltage generation with two voltage generation ranges.

The following picture displays the connection for voltage source for both mV & V Output Type.

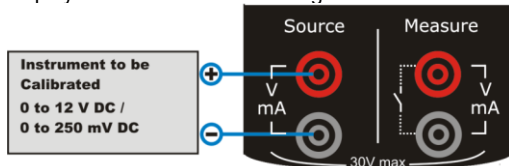

Measure Terminal	
mA	Range: 0.000 ... 24.000 mA Resolution: 0.001 mA
mA(24V)	Range: 0.000 ... 24.000 mA Resolution: 0.001 mA
mV	Range: 0.000 ... 250.00 mV Resolution: 0.01 mV
V	Range: 0.000 ... 30.000 V Resolution: 0.001 V
Switch Test	Potential free contacts Trigger level: 24V, 24mA (2V) Voltage level detection Trigger level: 0 ... 30V in 1V steps Input impedance: >1MΩ

Current Measurement

The PCE-LOC 20 supports current measurement using either PCE-LOC 20 as the loop power supply while at the same time measuring the current or simply measuring the current while an external power supply is used.

The following picture displays the connection for Current Measurement for different mode. And also different ways of providing the supply power to the loop.

mA Current Measurement

In this mode, the PCE-LOC 20 is not providing any supply voltage. For proper measurement, the external device should be capable of providing the voltage supply. If the external device is not capable, an external Power Supply should be connected in series.

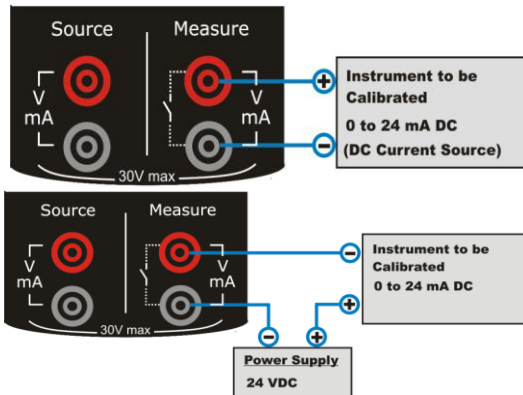

mA Read Power Current Measurement

In this mode, the PCE-LOC 20 works as a Loop Power Supply while at the same time measuring the current.

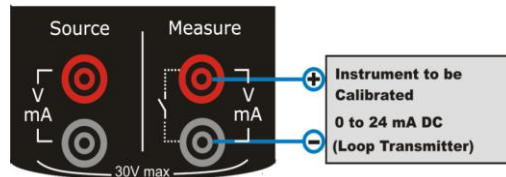

Voltage Measurement

The PCE-LOC 20 is capable of voltage Measurement with two voltage measurement ranges.

The following picture displays the connection for Voltage Measurement for different mode.

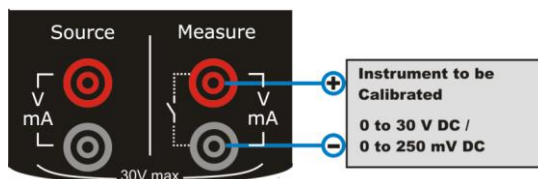



Switch Test

The PCE-LOC 20 is capable of detecting switch's state both when the switch is free of external potential or switches with DC voltages within the range 0 V ... +30 V.

Switch Mode: 2V (24VDC, 30mA)

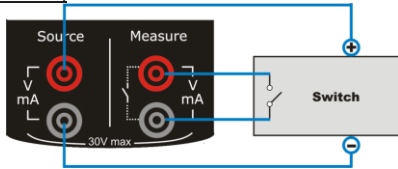

Switch Mode: Voltage Trigger

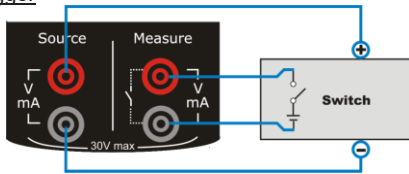

2.2.2 Keypad



The PCE-LOC 20 has six different keys. The key description is given below.

	This key has different functionalities in different menus. These are shown in the bottom left part of the display.
	This key has different functionalities in different menus. These are shown in the bottom left part of the display.
	<ul style="list-style-type: none"> - Scroll down to next parameter - Decrease value of digit in Editbox
	<ul style="list-style-type: none"> - Scroll down to previous parameter - Increase value of digit in Editbox
	<ul style="list-style-type: none"> - Enter menu when in Run mode - Save edited parameter to memory
	<ul style="list-style-type: none"> - Log current reading in memory if device is in Run mode and log mode is manual - When not in Run mode, this key is used to enter Run mode - Press and hold (approx. 2 s) to turn meter on/off

2.2.3 Display

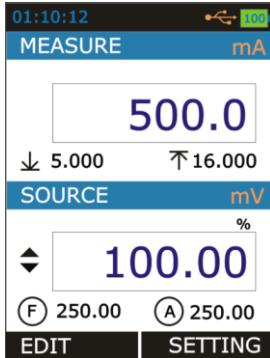

- LCD with a 2.4" color display
- Resolution of 240x320 pixels
- Supporting 262K colors

2.2.4 USB Connection

- The USB connection is located at the top of the PCE-LOC 20. It is a USB mini B-Type female connector.
- It can be used for PC communication and for charging the device.
- The USB cable supplied with the device is USB A-type male to USB B-type male. It is used for connecting charger and PC.

2.2.5 Stand for Table Top Use

- This stand offers the best support for table top use which gives good viewing angle when the PCE-LOC 20 is placed on a table.
- Procedure to open stand:



is being engraved on the top of the stand. You should pull a bit first.



can
can

is being engraved on the bottom of the stand. Now during first pull of above you release this lower part easily so that you maneuver the stand as you like.

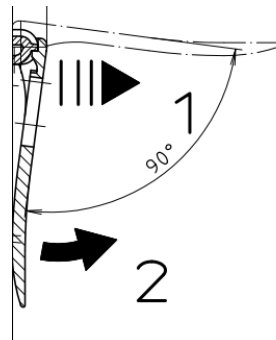



2.3 Power Options

There are three power options:

- Lithium-Ion battery: All the instrument functions are available with a charged battery.
- 5 V DC charging adaptor: It supplies power to the instrument and charges the battery at the same time. It charges the battery when the instrument is on or off.
- USB mini Type B connection: This charges the battery when the instrument is off and increases the battery life when the instrument is on.

2.4 Battery

The Device uses 2300mAh Lithium-Ion battery.

WARNING

- To prevent an explosion or fire, do not short circuit, do not disassemble, and keep it safe from damage.
- To prevent an explosion or fire, use only the supplied battery, battery charger and USB cable.
- To prevent battery leakage or heat generation, only use the battery charger in the temperature range 0 ... 45 °C (32 ... 113 °F).

When you set the power on, the battery symbol at the top of the display shows the charging status. To get more information on the battery, go to the Battery Info Page in the Setting menu.

2.4.1 Charging time

Charging method	Charging time (to full capacity)
External charging adaptor	≈ 5 hours
USB mini Type B connector	≈ 6 hours (with 500 mA supply) (When device is Off)

2.4.2 Operating time

Operation	Battery duration
Continuous operation (measure)	>18 hours
Continuous operation (measure and source (@12 mA))	>8 hours

These are typical operating times for a new, fully charged Li-Ion battery pack with these settings:

- *Backlight Intensity* set to 5 % (Default: 100 %)
- *Backlight Timeout* set to 0 (0=Infinite) (Default: 0)

Power saving options: To get the best battery duration, set a low value for the *Backlight Intensity* (40 %) and a short *Timeout*. The maximum operating time without recharging varies depending on the usage and brightness setting of the display light. Also the generated output current and the usage of the 24 V transmitter supply affect the maximum operating time.

Notes:

- The PCE-LOC 20's memory and the internal clock/calendar use a small amount of power although the calibrator is switched off. Remember to check the capacity of the batteries from time to time although the PCE-LOC 20 is not in use.
- Do not leave the PCE-LOC 20 without a battery pack or an empty battery for a long time. The PCE-LOC 20 may lose its settings if it is left without a support voltage for an extended period.

3 Start Up and Basic Operations

3.1 Power ON or OFF

To power ON the instrument, press and release the **LOG/Power** button until the display comes on. During the power on sequence, the instrument shows a startup message and then shows the applicable data.

To power OFF the instrument, press and hold (\approx 2 seconds) the same button again. When the power is off, the last set of configuration options stays in memory.

3.2 User Interface

Everytime the PCE-LOC 20 is switched on, the startup message ends in RUN Page.

4 display modes are available in the RUN page.

1. Measure + Source
2. Measure Only
3. Source Only
4. Switch Test + Source

This display mode can be selected from MENU \rightarrow DISPLAY Page.

In case of Dual Mode display, screen is divided into two parts. Due to that only few additional info will appear on RUN Page. The information to be shown can be selected in Display Mode menu.

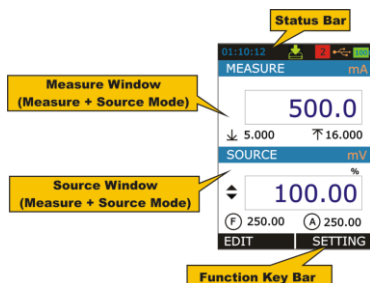

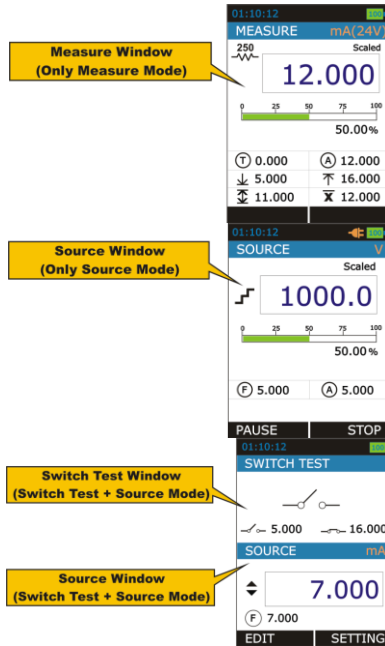







Not all possible elements are included in the previous picture, but the most important ones are discussed in the following chapters.

3.2.1 The Status Bar



The status bar at the top of the display is visible only in RUN Page. It is divided into five main sections.

1	<p>Time in HH:MM:SS format</p> <p>Available in two formats</p> <ol style="list-style-type: none"> 1. 24 hour (default) 2. 12 hour <p>This setting is available in Date/Time in Settings Menu</p>																		
2	<p>Error Code Indicator</p> <p>3.2.2 This icon is visible if any on-board peripherals like RTC, ADC, DAC, etc. are not working properly, see chapter 4.7.6 About Calibrator</p> <p>This Page illustrates the Connection diagrams for valid connections to this device. Maintenance and Troubleshooting.</p> <p>The List of error codes available in this device is given below.</p> <table border="1" data-bbox="230 587 927 826"> <thead> <tr> <th>Error code</th> <th>Description</th> </tr> </thead> <tbody> <tr> <td>0</td> <td>Memory corrupted or device unable to read/write it</td> </tr> <tr> <td>1</td> <td>RTC not working properly</td> </tr> <tr> <td>2</td> <td>Device unable to read battery information</td> </tr> <tr> <td>3</td> <td>Measure mode not working</td> </tr> <tr> <td>4</td> <td>Device unable to get source feedback reading</td> </tr> <tr> <td>5</td> <td>Data log memory corrupt</td> </tr> <tr> <td>6</td> <td>Source mode not working</td> </tr> <tr> <td>9</td> <td>More than one error from above list is occurring</td> </tr> </tbody> </table>	Error code	Description	0	Memory corrupted or device unable to read/write it	1	RTC not working properly	2	Device unable to read battery information	3	Measure mode not working	4	Device unable to get source feedback reading	5	Data log memory corrupt	6	Source mode not working	9	More than one error from above list is occurring
Error code	Description																		
0	Memory corrupted or device unable to read/write it																		
1	RTC not working properly																		
2	Device unable to read battery information																		
3	Measure mode not working																		
4	Device unable to get source feedback reading																		
5	Data log memory corrupt																		
6	Source mode not working																		
9	More than one error from above list is occurring																		
3	<p>USB Connection Status Icon</p> <p>Icon is visible if USB charging adaptor or USB data cable is connected to the device. Icon is different for both indications, see below.</p> <table border="1" data-bbox="210 959 927 1098"> <tbody> <tr> <td data-bbox="210 959 350 1018">  </td> <td data-bbox="350 959 927 1018"> USB data cable is connected and communication with PC is available </td> </tr> <tr> <td data-bbox="210 1018 350 1098">  </td> <td data-bbox="350 1018 927 1098"> USB charging adaptor is connected. Battery starts charging. </td> </tr> </tbody> </table>		USB data cable is connected and communication with PC is available		USB charging adaptor is connected. Battery starts charging.														
	USB data cable is connected and communication with PC is available																		
	USB charging adaptor is connected. Battery starts charging.																		
4	<p>Battery Charge Percentage Indicator</p> <p>Always visible in Run page; battery % is shown in the centre of the icon and the icon background is filled with green, yellow or red color if battery % is $\geq 50\%$, ≥ 20 and <20 respectively.</p>																		
5	<p>Data Logging Enable Status Indicator</p> <p>Icon is visible if data logging is enabled and will flash when a data log is stored to the memory</p>																		

3.2.3 Function Key Bar









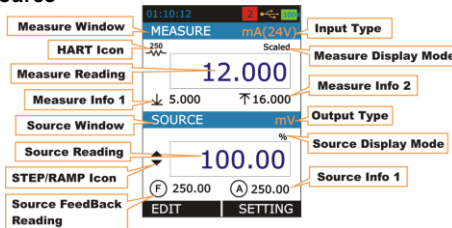













The function key bar at the bottom of the display is visible all the time. 2 function keys are available. The meaning of the function keys varies depending on the situation. A blank function key text means that the function is disabled at the moment.

3.2.4 Display Mode

1. Measure + Source



Measure Window									
Input Type	<p>The Input Type</p> <table border="1"> <tr> <td>mA</td> <td>mA Current Input</td> </tr> <tr> <td>mA(24V)</td> <td>mA Current (Read Power-24V) Input</td> </tr> <tr> <td>mV</td> <td>mV Voltage Input</td> </tr> <tr> <td>V</td> <td>V Voltage Input</td> </tr> </table>	mA	mA Current Input	mA(24V)	mA Current (Read Power-24V) Input	mV	mV Voltage Input	V	V Voltage Input
mA	mA Current Input								
mA(24V)	mA Current (Read Power-24V) Input								
mV	mV Voltage Input								
V	V Voltage Input								
Measure Display Mode	<p>The Measure Reading Display Mode</p> <table border="1"> <tr> <td>Actual</td> <td>Displays the Raw Input Value without any scaling</td> </tr> <tr> <td>Percentage</td> <td>Displays the Percentage Value in (0.00% ... 100.00%)</td> </tr> <tr> <td>Scaled</td> <td>Displays the Scaled Value</td> </tr> </table>	Actual	Displays the Raw Input Value without any scaling	Percentage	Displays the Percentage Value in (0.00% ... 100.00%)	Scaled	Displays the Scaled Value		
Actual	Displays the Raw Input Value without any scaling								
Percentage	Displays the Percentage Value in (0.00% ... 100.00%)								
Scaled	Displays the Scaled Value								
Measure Reading	The Reading as per the Measure Display Mode								
Measure Info 1	<p>Shows the One of the available Addition Information</p> <p>This can be selected by Additional Info. 1 List in <i>MENU → DISPLAY → MEASURE</i> page.</p>								
Measure Info 2	<p>Shows the One of the available Addition Information</p> <p>This can be selected by Additional Info. 2 List in <i>MENU → DISPLAY → MEASURE</i> page.</p> <p>This will disable if Bargraph is selected as Additional Info1 in <i>MENU → DISPLAY → MEASURE</i> page.</p>								

HART Icon	<p>HART Enable Status Icon</p> <p>This icon will appear if HART is enabled from <i>MENU</i> → <i>SETTING</i> → <i>HART</i> page. (This icon is visible for mA(24V) Input Type only. For other Input Types this will invisible regardless of HART settings)</p>																
Source Window																	
Output Type	<p>The Output Type</p> <table border="1"> <tr> <td>mA</td> <td>mA Current Output</td> </tr> <tr> <td>mA(2W)</td> <td>mA Current (2-Wire Simulation) Output</td> </tr> <tr> <td>mV</td> <td>mV Voltage Output</td> </tr> <tr> <td>V</td> <td>V Voltage Output</td> </tr> </table>	mA	mA Current Output	mA(2W)	mA Current (2-Wire Simulation) Output	mV	mV Voltage Output	V	V Voltage Output								
mA	mA Current Output																
mA(2W)	mA Current (2-Wire Simulation) Output																
mV	mV Voltage Output																
V	V Voltage Output																
Source Display Mode	<p>The Source Reading Display Mode</p> <table border="1"> <tr> <td>Actual</td> <td>Displays the Raw Output Value without any scaling</td> </tr> <tr> <td>Percentage</td> <td>Displays the Percentage Value in (0.00% - 100.00%)</td> </tr> <tr> <td>Scaled</td> <td>Displays the Scaled Value</td> </tr> </table>	Actual	Displays the Raw Output Value without any scaling	Percentage	Displays the Percentage Value in (0.00% - 100.00%)	Scaled	Displays the Scaled Value										
Actual	Displays the Raw Output Value without any scaling																
Percentage	Displays the Percentage Value in (0.00% - 100.00%)																
Scaled	Displays the Scaled Value																
Source Reading	The Reading as per the Source Display Mode																
Source Reading Feedback	<p>The Feedback ADC Reading in Output Unit</p> <p>This will disable if Bargraph is selected as Additional Info1 in <i>MENU</i> → <i>DISPLAY</i> → <i>SOURCE</i> page.</p>																
Source Info1	<p>Shows the One of the available Addition Information</p> <p>This can be selected by Additional Info. 1 List in <i>MENU</i> → <i>DISPLAY</i> → <i>SOURCE</i> page.</p>																
STEP/RAMP Icon	<p>Shows the Icon indicating STEP/RAMP mode.</p> <table border="1"> <tr> <td></td> <td>Manual Step</td> <td></td> <td>Rising Ramp</td> </tr> <tr> <td></td> <td>Step UP</td> <td></td> <td>Falling Ramp</td> </tr> <tr> <td></td> <td>Step DOWN</td> <td></td> <td>Ramp Hold @ 0%</td> </tr> <tr> <td></td> <td></td> <td></td> <td>Ramp Hold @ 100%</td> </tr> </table>		Manual Step		Rising Ramp		Step UP		Falling Ramp		Step DOWN		Ramp Hold @ 0%				Ramp Hold @ 100%
	Manual Step		Rising Ramp														
	Step UP		Falling Ramp														
	Step DOWN		Ramp Hold @ 0%														
			Ramp Hold @ 100%														

2. Measure Only

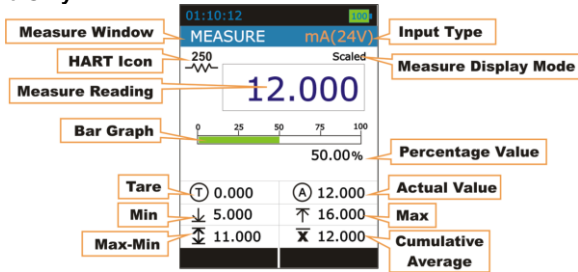

Measure Window	
Input Type Measure Display Mode Measure Reading HART Icon	See chart in 3.2.4 Display Mode 1 Measure + Source
Bar Graph	Horizontal Bar graph according to Input Percentage Value (0.00% ... 100.00%).
Percentage Value	The Percentage Value in (0.00% ... 100.00%) according to Input Value.
Tare	The Tare Value Set from <i>MENU</i> → <i>DISPLAY</i> → <i>MEASURE-Tare</i> page
Actual Value	The Raw Input Value without any scaling This will appear only if Main Display in <i>MENU</i> → <i>DISPLAY</i> → <i>MEASURE</i> is set to PERCENTAGE/SCALED .
Min	Displays the minimum value found after a measurement was started or minimum was reset.
Max	Displays the maximum value found after a measurement was started or maximum was reset.
Max-Min	Displays the Maximum-Minimum value found after a measurement was started or Maximum-Minimum was reset.
Cumulative Average	Displays the Cumulative Average value found after a measurement was started or Cumulative Average was reset.



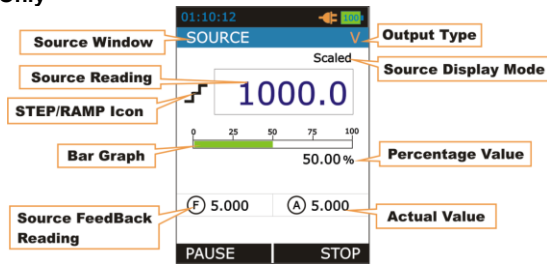



3. Source Only

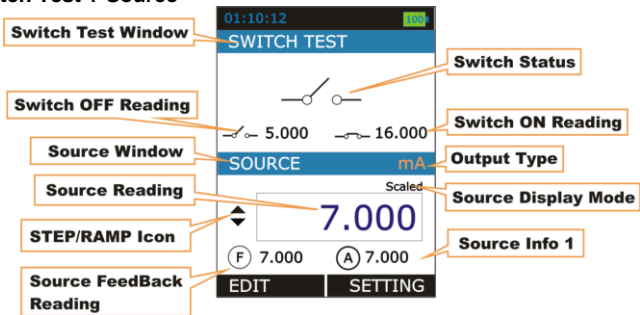

Source Window	
Output Type Source Display Mode Source Reading Source FeedBack Reading STEP/RAMP Icon	See chart in 3.2.4 Display Mode 1 Measure + Source
Bar Graph	Horizontal Bar graph according to Output Percentage Value (0.00% ... 100.00%).
Percentage Value	The Percentage Value in (0.00% ... 100.00%) according to Output Value.
Actual Value	The Raw Output Value without any scaling This will appear only if Main Display in <i>MENU</i> → <i>DISPLAY</i> → <i>SOURCE</i> is set to PERCENTAGE/SCALED .

4. Switch Test + Source



Switch Test Window					
Switch Status	Switch Status Icon <table border="1" style="width: 100%;"> <tr> <td style="text-align: center;"></td> <td>Switch OPEN (OFF)</td> </tr> <tr> <td style="text-align: center;"></td> <td>Switch CLOSE (ON)</td> </tr> </table>		Switch OPEN (OFF)		Switch CLOSE (ON)
	Switch OPEN (OFF)				
	Switch CLOSE (ON)				
Switch OPEN Reading	Displays the Source Reading value after the switch OPEN was detected.				
Switch CLOSE Reading	Displays the Source Reading value after the switch CLOSE was detected.				

3.2.5 Display Operations

Mainly, four types of widgets are available in the Device Menu.

- i. ListBox
- ii. EditText
- iii. CheckBox
- iv. RadioButtonBox

The below section will show how to change the value of different widgets.

i. ListBox

ListBox are used when there is a limited amount of preset values. You have to select one of the available options. The list of available options is displayed in the centre part.

A ListBox list opens when you press the **F1** key. Use the **UP/DOWN** key to scroll through the available options. Select one of the options with the **ENTER** key.

Example: How to change of Input Type (I/P Type) from mA to mV. This Option is available in MENU → MEASURE Page.

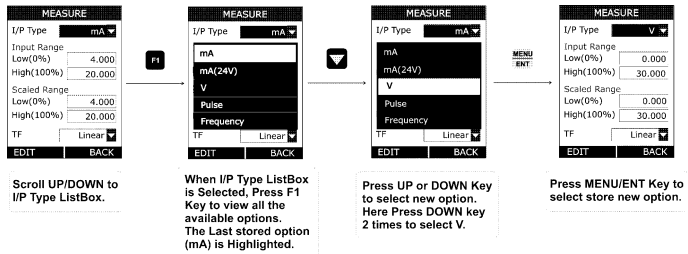

ii. EditBox

EditBox is used where a large range of values is possible for a parameter.

To edit the value of an EditBox, press **F1** key. After that EditBox enters Edit mode where **F1** and **F2** keys work as shifter. User can shift to desired digit and using **UP** or **DOWN** key digit value can be incremented or decremented. The modified value can be saved using **MENU/ENT** key.

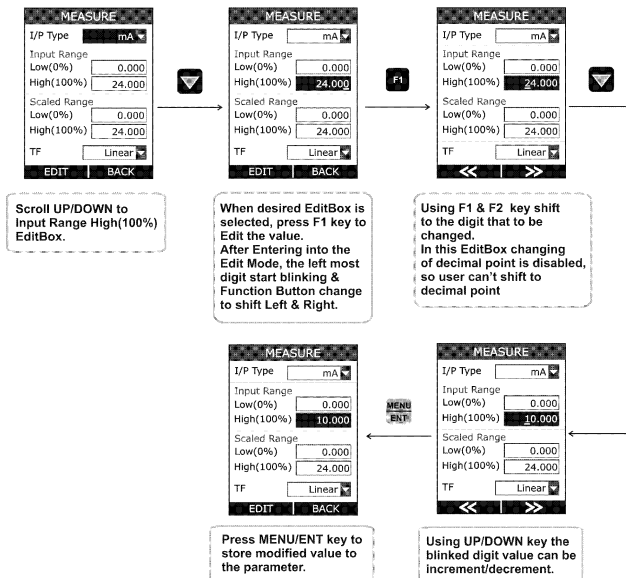



The above figure shows the example how to change Input High (100%) Range from 20.000 to 10.000 mA.

There are mainly 2 types of EditBox in this device. In most of the EditBox changing of decimal point and changing of sign is not allowed. But there are few EditBox, where these are allowed. These types of EditBox are Scaled Low(0%) & High(100%) Range of measure & source, Alarm Low & High value and Editing of Source Value in RUN Page.

The below figure shows the example how to change decimal point of the Input Scaled High(100%) Range

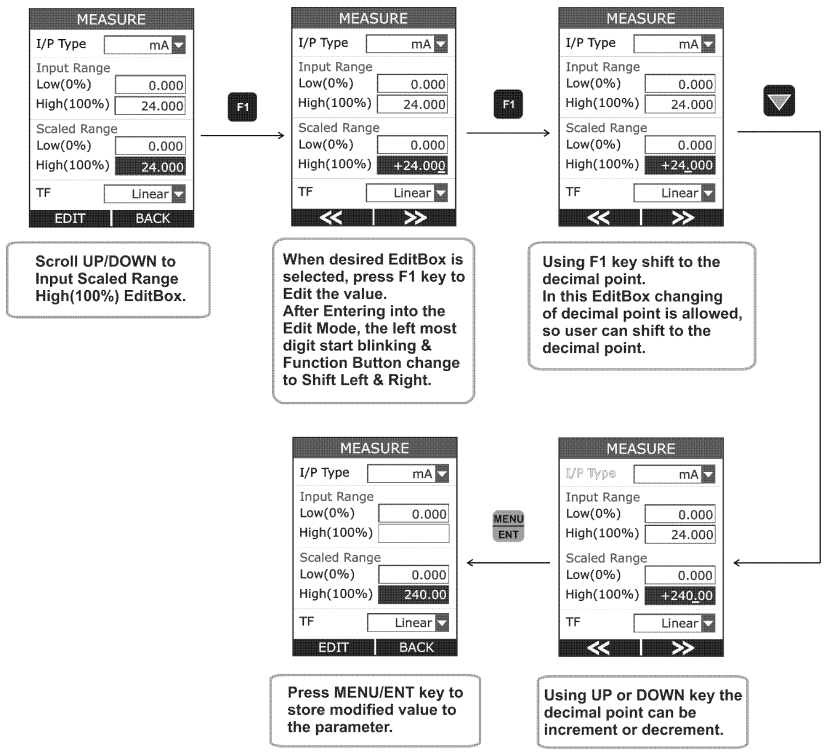

To change the sign of the value, shift to the sign digit and pressing UP or DOWN key will toggle the sign.

iii. CheckBox

CheckBox is used where Binary Value (1/0, True/False) is available for any parameter.

To change the CheckBox status, press **F1** key. This will enter edit mode. In this mode, status can be toggled by pressing **F1** key. Press **MENU/ENT** key to store new status.

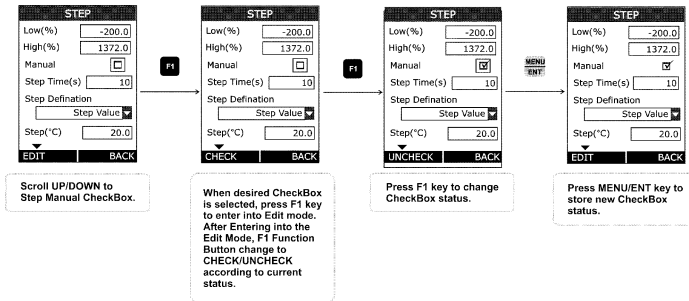

iv. RadioButtonBox

RadioButtonBox is used where very few values are possible and all the available values need to be visible.

In this device, two types of RadioButtonBox are available. One with 1 value can be selectable and the other where 1 or 2 values can be selected at a time.

In RadioButtonBox the other option can be selected by pressing **MENU/ENT** key on that option. When pressing this key the new option will be selected and the other option will be disabled.

Below an example is given, How to change Source Type from STEP to Ramp.

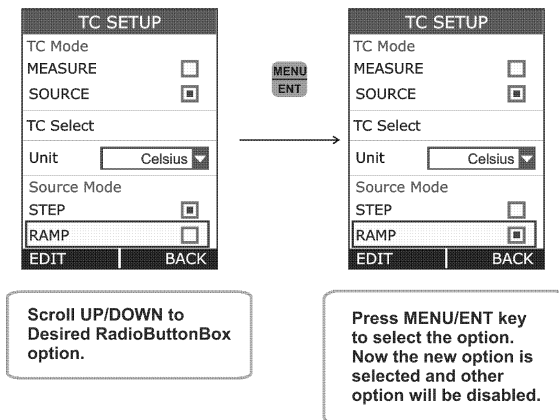

4 Menu Layout

4.1 MENU page

There are mainly six menus in this device.

To enter the MENU page, press **MENU/ENT** key and press **F2** key to leave the Menu page.

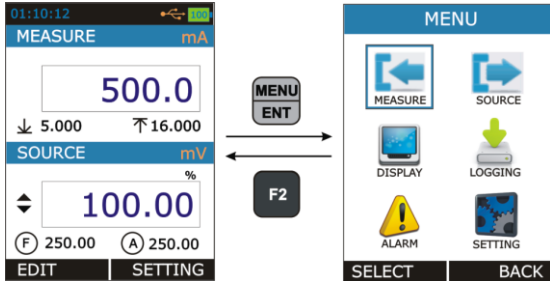

MEASURE	Contains Parameters related to Measure Mode like Input Type, Range etc.
SOURCE	Contains Parameters related to Source Mode like Output Type, Range, Source Type etc.
DISPLAY	Contains Parameters related to different display mode for RUN page
LOGGING	Contains Parameters related to Data Logging. (This)
ALARM	Contains Parameters related to Alarm & Alarm Set-Points.
SETTINGS	Contains Parameters related to General Settings of the device like display, Date/Time, Calibration, Reset, etc.

4.2 MEASURE Page

This Page appears when you select *RUN* → *MENU* → *MEASURE*.

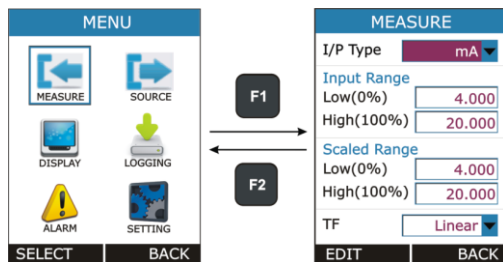

The description of the parameters that appear on this page is given below.

Parameter Name	Description / Options
I/P Type (Input Type)	Measure Input Type <u>Available Options:</u> mA : 0.000 ... 24.000 mA DC mA(24V) : 0.000 ... 24.000 mA DC mV : 0.00 ... 250.00 mV DC V : 0.000 ... 30.000 V DC
Input Range Low (0%)	Low Range for Measure Input. <u>Range:</u> Default Input Low to Input Range High(100%) This parameter is enabled, if Main Display in <i>MENU</i> → <i>DISPLAY</i> → <i>MEASURE</i> is set to Percentage or Scaled .
Input Range High (100%)	High Range for Measure Input. <u>Range:</u> Input Range Low(0%) to Default Input High This parameter is enabled, if Main Display in <i>MENU</i> → <i>DISPLAY</i> → <i>MEASURE</i> is set to Percentage or Scaled .
Scaled Input Range Low(0%)	Scaling Low Range for Measure Input. <u>Range:</u> -99999 to Scaled Input Range High(100%) Decimal Point for this EditBox can be changeable. This parameter is enabled, if Main Display in <i>MENU</i> → <i>DISPLAY</i> → <i>MEASURE</i> is set to Scaled .
Scaled Input Range High(100%)	Scaling High Range for Measure Input. <u>Range:</u> Scaled Input Range Low(0%) to 99999 Decimal Point for this EditBox can be changeable. This parameter is enabled, if Main Display in <i>MENU</i> → <i>DISPLAY</i> → <i>MEASURE</i> is set to Scaled .

TF (Transfer Function)	Transfer Function for Scaling <u>Available Options:</u> Linear x^2 (x^2) $x^{1/2}$ (\sqrt{x}) This parameter is enabled, if Main Display in <i>MENU</i> → <i>DISPLAY</i> → <i>MEASURE</i> is set to Scaled .
----------------------------------	---

4.3 SOURCE Page

This Page appears when you select *RUN* → *MENU* → *SOURCE*.

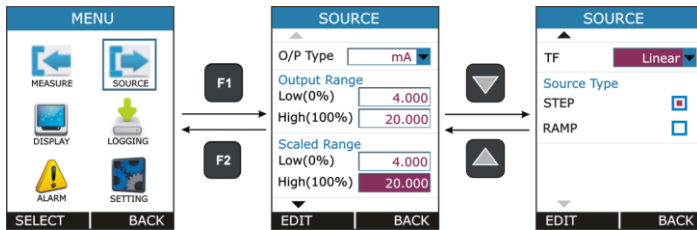

The description of the parameters that appear on this page is given below.

Parameter Name	Description / Options
O/P Type (Output Type)	Source Output Type <u>Available Options:</u> mA : 0.000 ... 24.000 mA DC mA(2W) : 0.000 ... 24.000 mA DC mV : 0.00 ... 250.00 mV DC V : 0.000 ... 12.000 V DC
Output Range Low (0%)	Low Range for Source Output. <u>Range:</u> Default Output Low to Output Range High(100%) This parameter is enabled, if Main Display in <i>MENU</i> → <i>DISPLAY</i> → <i>SOURCE</i> is set to Percentage or Scaled .

Output Range High (100%)	<p>High Range for Source Output.</p> <p><u>Range:</u> Output Range Low(0%) to Default Output High</p> <p>This parameter is enabled, if Main Display in <i>MENU</i> → <i>DISPLAY</i> → <i>SOURCE</i> is set to Percentage or Scaled.</p>
Scaled Range Low(0%)	<p>Scaling Low Range for Source Output.</p> <p><u>Range:</u> -99999 to Scaled Output Range High(100%)</p> <p>Decimal Point for this EditBox can be changeable.</p> <p>This parameter is enabled, if Main Display in <i>MENU</i> → <i>DISPLAY</i> → <i>SOURCE</i> is set to Scaled.</p>
Scaled Range High(100%)	<p>Scaling High Range for Source Output</p> <p><u>Range:</u> Scaled Output Range Low(0%) to 99999</p> <p>Decimal Point for this EditBox can be changeable.</p> <p>This parameter is enabled, if Main Display in <i>MENU</i> → <i>DISPLAY</i> → <i>SOURCE</i> is set to Scaled.</p>
TF (Transfer Function)	<p>Transfer Function for Scaling</p> <p><u>Available Options:</u> Linear x^2 (x^2) $x^{1/2}$ (\sqrt{x})</p> <p>This parameter is enabled, if Main Display in <i>MENU</i> → <i>DISPLAY</i> → <i>SOURCE</i> is set to Scaled.</p>
Source Type	<p>Source Output Format</p> <p><u>Available Options:</u> STEP RAMP</p> <p>At a time one can be selectable. Press F1 key on the one of the option for more settings.</p>

4.3.1 STEP Page

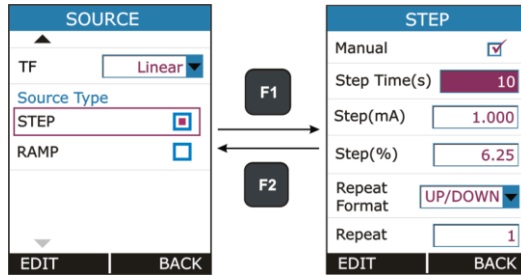

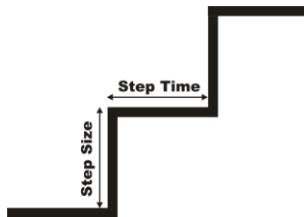

Parameter Name	Description / Options
Manual (Output Type)	Step Manual Mode Selection CheckBox. Ticking this checkbox will enable Step Manual Mode. And un-ticking will enable Auto Step Mode.
Step Time (s)	Enter the time for a single step in seconds, <u>Range:</u> 1 ... 9999 This parameter is enabled only for Auto Step Mode (Manual CheckBox is Un-Checked)
Step(unit) Step Size in unit	Step Size in unit, where unit is changed according to current Output Type and Source Display Mode. Only Specify one Step(unit) or Step(%), the other will automatically changed according to the changed parameter. <u>Range:</u> In accordance with Output Range & Source Display Mode. This parameter is disabled, if Main Display in <i>MENU</i> → <i>DISPLAY</i> → <i>SOURCE</i> is set to Percentage .
Step(%) Step Size in Percentage	Step Size in Percentage. Only Specify one Step(unit) or Step(%), the other will automatically changed according to the changed parameter. <u>Range:</u> 0.00 ... 100.00

Repeat Format	<p>How the stepping should be done.</p> <p><u>Available Options:</u> UP DOWN UP/DOWN DOWN/UP</p> <p>This parameter is enabled only for Auto Step Mode (Manual CheckBox is Un-Checked)</p>
Repeat Repeat Counts	<p>Defines how many times the steps are repeated</p> <p><u>Range:</u> 1 to 9999</p> <p>This parameter is enabled only for Auto Step Mode (Manual CheckBox is Un-Checked)</p>



Manual Stepping

To Enable Manual Stepping, select Source Type as STEP and Check the Manual CheckBox.

If this mode is enabled,   icon will appear in Source Display Window in RUN Page.

Pressing UP or DOWN key in RUN Page will increase or decrease Source Value by Step Size specified in STEP Page.

In RUN Page, Source Value can directly change by Pressing **F1** key (EDIT) and modifying value like in EditBox. and STEP Setting can be accessed directly by **F2** key (SETTING).

Auto Stepping

To Enable Auto Stepping, select Source Type as STEP & Un-Check the Manual CheckBox.

If this mode is enabled,  (Step UP) or  (Step Down) icon will appear in Source Display Window in RUN Page and F1 and F2 Button change to **START** and **SETTING** respectively.

Automated Step can be started by Pressing **F1** key (START). After that F1 and F2 key will change to **PAUSE** and **STOP** respectively. So by pressing F1 and F2 key running STEP can be PAUSE or STOP at any time in RUN Page.

STEP Setting can be accessed directly by **F2** key (SETTING).

4.3.2 RAMP Page

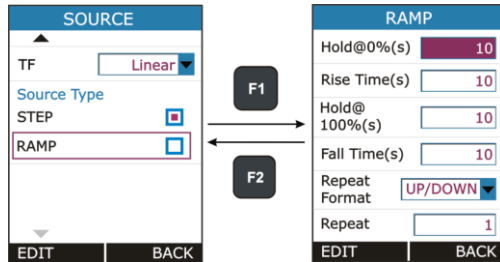



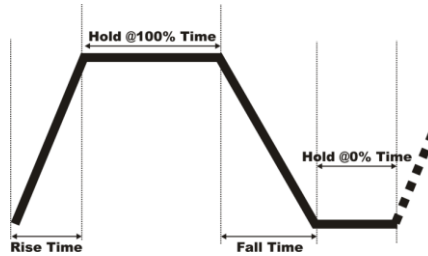

Parameter Name	Description / Options
Hold@0%(s)	Time to wait at Low(0%) level in second This parameter is use for Repeat Format UP/DOWN or DOWN/UP . <u>Range:</u> 0 ... 9999
Rise Time (s)	Time to Increase from Low to High Level <u>Range:</u> 1 ... 9999
Hold@100%(s)	Time to wait at High(100%) level in second This parameter is use for Repeat Format UP/DOWN or DOWN/UP . <u>Range:</u> 0 ... 9999
Fall Time (s)	Time to decrease from High to Low Level <u>Range:</u> 1 ... 9999
Repeat Format	How the Ramp should be done <u>Available Options:</u> UP DOWN UP/DOWN DOWN/UP
Repeat Repeat Counts	Defines how many times the steps are repeated <u>Range:</u> 1 ... 9999



Starting the RAMP

To enable Ramp, select Source Type as RAMP.

If this mode is enabled,  (Rising Ramp) or  (Falling Ramp) or  (Ramp Hold @ 100%) or  (Ramp Hold @ 0%) icon will appear in Source Display Window according to current RAMP mode in RUN Page and F1 and F2 Button change to **START** and **SETTING** respectively.

RAMP can be started by Pressing **F1** key (START). After that F1 and F2 key will change to **PAUSE** and **STOP** respectively. So by pressing F1 and F2 key running RAMP can be PAUSE or STOP at any time in RUN Page.

4.4 DISPLAY Page

This Page appears when you select *RUN* → *MENU* → *DISPLAY*.

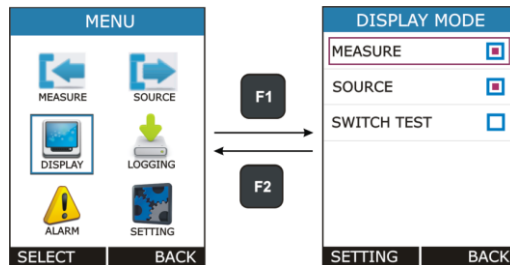

There are mainly four RUN Display Modes possible in this device. And this mode can be selected from the above Page. What information to be shown in each RUN Display Mode can be defined by this page.

In this page, there is one Radio Button Box. At a time, one or two options can be selected. The possible combinations are given below.

1	Measure Only
2	Source Only
3	Measure + Source
4	Switch Test + Source

4.4.1 Measure Display Settings

This Page appears when you select *RUN* → *MENU* → *DISPLAY* → *MEASURE*.

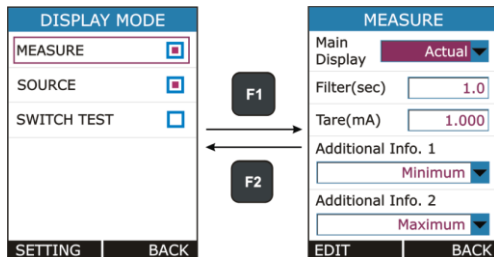





Parameter Name	Description / Options						
Main Display	<p>Select which Reading to be display as a Main Reading (Reading Displays in Box in RUN Page).</p> <p><u>Available Options:</u></p> <table border="1"> <tr> <td>Actual</td> <td>Display the Actual Input Value</td> </tr> <tr> <td>Percentage</td> <td>Display the Percentage Value of the Input. The Value depends on Input Range. These settings are available from <i>MENU</i> → <i>MEASURE</i>.</td> </tr> <tr> <td>Scaled</td> <td>Display the Scaled Value of the Input. The Scale Value depends on Input Range, Input Scaled Range & Transfer Function. These settings are available from <i>MENU</i> → <i>MEASURE</i>.</td> </tr> </table>	Actual	Display the Actual Input Value	Percentage	Display the Percentage Value of the Input. The Value depends on Input Range. These settings are available from <i>MENU</i> → <i>MEASURE</i> .	Scaled	Display the Scaled Value of the Input. The Scale Value depends on Input Range, Input Scaled Range & Transfer Function. These settings are available from <i>MENU</i> → <i>MEASURE</i> .
Actual	Display the Actual Input Value						
Percentage	Display the Percentage Value of the Input. The Value depends on Input Range. These settings are available from <i>MENU</i> → <i>MEASURE</i> .						
Scaled	Display the Scaled Value of the Input. The Scale Value depends on Input Range, Input Scaled Range & Transfer Function. These settings are available from <i>MENU</i> → <i>MEASURE</i> .						
Filter(sec)	<p>1st Order IIR Low Pass Filter for Input Reading. Filter is useful when a measurement signal contains unwanted noise.</p> <p><u>Range:</u> 0.0 to 60.0 sec</p>						
Tare(unit)	<p>The Tare value is subtracted from the reading of the measured value. Here unit is changed according to current Input Type and Measure Display Mode.</p> <p><u>Range:</u> In accordance with Input Range & Measure Display Mode.</p> <p>Note: Beware of the problems that may result in not seeing the true measurement value.</p>						

Additional Info.1

Choose which information to be shown in Bottom Left side of the Measure Window on RUN Page.

Available Options:

Options	Icon	Description
Reset	-	Reset the Minimum, Maximum, Max – Min, Cumulative Avg. Value
None	-	No info is visible.
Minimum		Displays the minimum value found after a measurement was started or minimum was reset
Maximum		Displays the maximum value found after a measurement was started or maximum was reset
Max – Min		Displays the (maximum – minimum) value found after a measurement was started or (maximum – minimum) was reset
Avg. of 2		Displays the average value of present value and previous value.
Bargraph	-	Shows the Horizontal bar Graph in 0% to 100% scale. The value in Bar Graph depends on the Display Mode and Measurement settings
Actual Value		Shows the Actual Input Value. This option is not appear if Main Display is Actual .

If Measure is not selected as Display mode this parameter will be disabled. And for Only Measure Display Mode Only Reset Option is available.

Additional Info.2

Choose which information to be shown in Bottom Right side of the Measure Window on RUN Page.



Options	Icon	Description
Reset	-	Reset the Minimum, Maximum, Max – Min, Cumulative Avg. Value
None	-	No info is visible.
Minimum	↓	Displays the minimum value found after a measurement was started or minimum was reset
Maximum	↑	Displays the maximum value found after a measurement was started or maximum was reset
Max – Min	↕	Displays the (maximum – minimum) value found after a measurement was started or (maximum – minimum) was reset
Avg. of 2	\bar{X}	Displays the average value of present value and previous value.
Actual Value	Ⓐ	Shows the Actual Input Value. This option is not appear if Main Display is Actual .

If Measure is not selected as Display mode this parameter will be disabled.

4.4.2 Source Display Settings

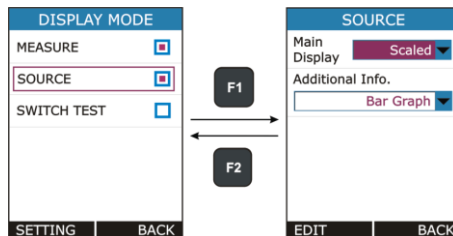
This Page appears when you select *RUN* → *MENU* → *DISPLAY* → *SOURCE*



Parameter Name	Description / Options												
Main Display	<p>Select which Reading to be display as a Main Reading (Reading Displays in Box in RUN Page).</p> <p><u>Available Options:</u></p> <table border="1" data-bbox="331 331 1004 608"> <tbody> <tr> <td data-bbox="331 331 508 363">Actual</td> <td data-bbox="508 331 1004 363">Display the Actual Output Value</td> </tr> <tr> <td data-bbox="331 363 508 475">Percentage</td> <td data-bbox="508 363 1004 475"> Display the Percentage Value of the Output. The Value depends on Output Range. These settings are available from <i>MENU</i> → <i>SOURCE</i>. </td> </tr> <tr> <td data-bbox="331 475 508 608">Scaled</td> <td data-bbox="508 475 1004 608"> Display the Scaled Value of the Output. The Scale Value depends on Output Range, Output Scaled Range & Transfer Function. These settings are available from <i>MENU</i> → <i>SOURCE</i>. </td> </tr> </tbody> </table>	Actual	Display the Actual Output Value	Percentage	Display the Percentage Value of the Output. The Value depends on Output Range. These settings are available from <i>MENU</i> → <i>SOURCE</i> .	Scaled	Display the Scaled Value of the Output. The Scale Value depends on Output Range, Output Scaled Range & Transfer Function. These settings are available from <i>MENU</i> → <i>SOURCE</i> .						
Actual	Display the Actual Output Value												
Percentage	Display the Percentage Value of the Output. The Value depends on Output Range. These settings are available from <i>MENU</i> → <i>SOURCE</i> .												
Scaled	Display the Scaled Value of the Output. The Scale Value depends on Output Range, Output Scaled Range & Transfer Function. These settings are available from <i>MENU</i> → <i>SOURCE</i> .												
Additional Info.1	<p>Choose which information to be shown in Bottom Right side of the Source Window on RUN Page.</p> <p><u>Available Options:</u></p> <table border="1" data-bbox="339 754 1004 1029"> <thead> <tr> <th data-bbox="339 754 514 791">Options</th> <th data-bbox="514 754 617 791">Icon</th> <th data-bbox="617 754 1004 791">Description</th> </tr> </thead> <tbody> <tr> <td data-bbox="339 791 514 831">None</td> <td data-bbox="514 791 617 831">-</td> <td data-bbox="617 791 1004 831">No info is visible.</td> </tr> <tr> <td data-bbox="339 831 514 943">Bargraph</td> <td data-bbox="514 831 617 943">-</td> <td data-bbox="617 831 1004 943"> Shows the Horizontal bar Graph in 0% to 100% scale. The value in Bar Graph depends on the Display Mode and Source settings </td> </tr> <tr> <td data-bbox="339 943 514 1029">Actual Value</td> <td data-bbox="514 943 617 1029">  </td> <td data-bbox="617 943 1004 1029"> Shows the Actual Output Value. This option is not appear if Main Display is Actual. </td> </tr> </tbody> </table> <p>This Parameter is enabled only for Measure + Source or Switch test + Source Display Mode.</p>	Options	Icon	Description	None	-	No info is visible.	Bargraph	-	Shows the Horizontal bar Graph in 0% to 100% scale. The value in Bar Graph depends on the Display Mode and Source settings	Actual Value		Shows the Actual Output Value. This option is not appear if Main Display is Actual .
Options	Icon	Description											
None	-	No info is visible.											
Bargraph	-	Shows the Horizontal bar Graph in 0% to 100% scale. The value in Bar Graph depends on the Display Mode and Source settings											
Actual Value		Shows the Actual Output Value. This option is not appear if Main Display is Actual .											

4.4.3 Switch Test Settings

This Page appears when you select *RUN* → *MENU* → *DISPLAY* → *SWITCH TEST*.

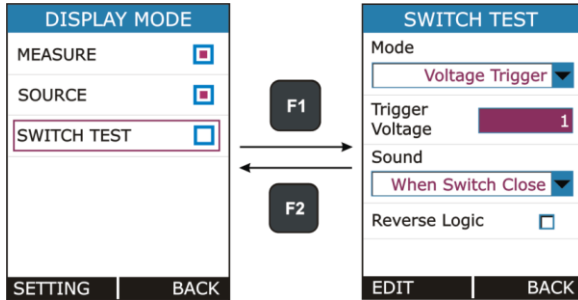





Parameter Name	Description / Options				
Mode	<p>Switch Test Operation Mode</p> <p><u>Available Options:</u></p> <table border="1"> <tr> <td>2V(24Vdc,30mA)</td> <td>Switch Close when External Switch (Potential Free Contacts) short & Switch Open is External Switch open.</td> </tr> <tr> <td>Voltage Trigger</td> <td>Switch Close when Input Voltage > Trigger Voltage Switch Open when Input Voltage < Trigger Voltage</td> </tr> </table> <p>All the MEASURE Page parameters are disabled if Switch Test Display Mode is selected.</p>	2V(24Vdc,30mA)	Switch Close when External Switch (Potential Free Contacts) short & Switch Open is External Switch open.	Voltage Trigger	Switch Close when Input Voltage > Trigger Voltage Switch Open when Input Voltage < Trigger Voltage
2V(24Vdc,30mA)	Switch Close when External Switch (Potential Free Contacts) short & Switch Open is External Switch open.				
Voltage Trigger	Switch Close when Input Voltage > Trigger Voltage Switch Open when Input Voltage < Trigger Voltage				
Trigger Voltage	<p>Trigger Voltage value for Voltage Trigger Switch Test Mode.</p> <p><u>Range:</u> 0 to 30 V</p> <p>Enable only for Switch Test Mode as Voltage Trigger.</p>				
Sound	<p>Sound Setting for Switch Test Mode</p> <p><u>Available Options:</u> Off When Switch Close When Switch Open</p>				
Reverse Logic	<p>Switch Test Switch Logic Reverse Selection.</p> <p>Switch Open-Close Logic Reverse if this CheckBox is Checked.</p>				

4.5 DATA LOGGING Page

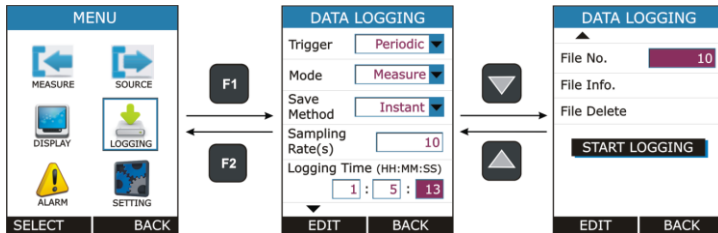
This section gives examples of how to log Readings with time and date over a set time period or on a key press. Logged data is stored in a user defined file in internal memory.

This Page appears when you select **RUN** → **MENU** → **LOGGING**.



Parameter Name	Description / Options								
Trigger	<p>Data Logging Trigger Mode Selection.</p> <p><u>Available Options:</u></p> <table border="1"> <tr> <td>Key Press</td> <td>Log Data on pressing  from RUN key Page.</td> </tr> <tr> <td>Periodic</td> <td>Log Data periodically at every Sampling Rate for total time specified by Logging Time.</td> </tr> </table>	Key Press	Log Data on pressing  from RUN key Page.	Periodic	Log Data periodically at every Sampling Rate for total time specified by Logging Time.				
Key Press	Log Data on pressing  from RUN key Page.								
Periodic	Log Data periodically at every Sampling Rate for total time specified by Logging Time.								
Mode	<p>Data Mode Selection for Logging</p> <p><u>Available Options:</u></p> <table border="1"> <tr> <td>Measure</td> <td>Log only Measure Readings.</td> </tr> <tr> <td>Source</td> <td>Log only Source Readings.</td> </tr> <tr> <td>Both</td> <td>Log Measure and Source both Readings.</td> </tr> <tr> <td>Switch</td> <td>Log Switch Status & Source Readings.</td> </tr> </table> <p>This parameter is enabled only for Periodic Trigger.</p>	Measure	Log only Measure Readings.	Source	Log only Source Readings.	Both	Log Measure and Source both Readings.	Switch	Log Switch Status & Source Readings.
Measure	Log only Measure Readings.								
Source	Log only Source Readings.								
Both	Log Measure and Source both Readings.								
Switch	Log Switch Status & Source Readings.								

Save Method	Reading Type selection for Logging <u>Available Options:</u> Instant Min Max Average All This parameter is enabled only for Periodic Trigger.
Sampling Rate(s)	Sampling Rate for Periodic Data Logging in seconds. <u>Range:</u> 1 ... 9999 This parameter is enabled only for Periodic Trigger.
Logging Time (HH:MM:SS)	Total Logging Time in HH:MM:SS Format for Periodic Logging. This parameter is enabled only for Periodic Trigger.
File No.	File Number. <u>Range:</u> 1 ... 25 This parameter is enabled only for Periodic Trigger.
File Info.	Shows the information of stored files. This information contains Logging Start Time & Date and No of Samples stored in the file.
File Delete	Delete stored file.
START LOGGING	Press F1 key while selecting this button to start the Logging.

Notes

- Maximum No of readings that can be stored in

Logging Mode	Max. no. of readings
Periodic	150000
Key Press	572

- In Periodic mode, changing of any Measure or Source parameter is not allowed. So While Periodic Logging is Running, User can't enter into MEASURE, SOURCE and DISPLAY menu. But in Key Press Logging mode, there is no restriction.
- In Periodic Mode, if error message like "Not Sufficient Memory" comes while starting the Logging. Try to Reduce Logging Time or Increase Sampling Period or try deleting some existing files.

- In Key Press Mode, If No of Samples reach its maximum limit that is 484, the next sample will start from the first overwriting the memory.
- While Logging is running, entering into the LOGGING menu shows below page.

for Periodic Mode

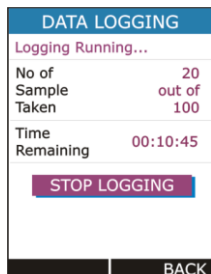

for Key Press Mode

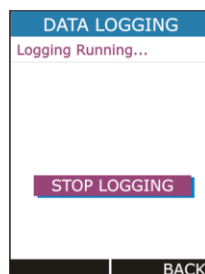

For Periodic Mode, this page contains information of Number of Samples Taken and time remaining for Logging in HH:MM:SS.

- Both Periodic and Key Press logging can be stop manually by pressing F1 key on STOP LOGGING Button. For Periodic Mode, Logging will automatically stopped when defined log time ends and a message "LOGGING DONE" pops up.

Transferring the Results to a Personal Computer:

A 32-bit Windows® software called **mCAL+.exe** can be downloaded here: https://www.pce-instruments.com/english/download-win_4.htm. Start this software just as any other Windows® software.

All communication between the PC and PCE-LOC 20 is initiated from **mCAL+.exe**. More information on the software can be found in the separate software manual.

4.6 ALARM Page

This Page appears when you select *RUN* → *MENU* → *ALARM*.

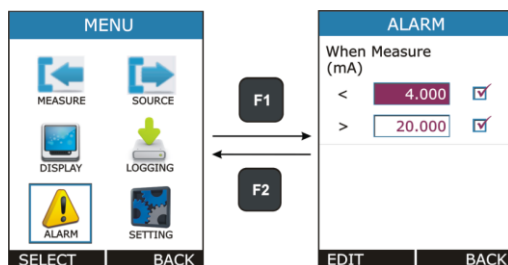

Individual alarm limit values may also be enabled/disabled using the check box preceding the alarm limit value. To stop the alarm, uncheck the appropriate alarm checkbox.

When an alarm limit is exceeded, the PCE-LOC 20 emits an audible alarm and the Main Reading is shown with RED Color.



Parameter Name	Description / Options
<	Alarm Low Limit Value <u>Range:</u> In accordance with Input Range and Measure Display Mode. And also it can't be greater than Alarm High Limit when High Alarm is enabled.
>	Alarm High Limit Value <u>Range:</u> In accordance with Input Range and Measure Display Mode. And also it can't be less than Alarm Low Limit when Low Alarm is enabled.

4.7 SETTING Page

This Page appears when you select *RUN* → *MENU* → *SETTING*.

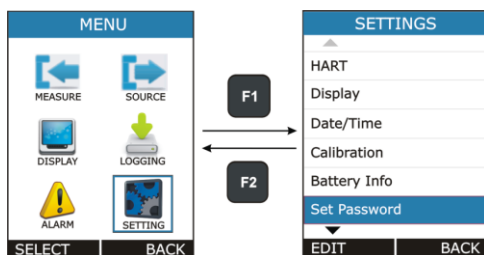

All the available Settings Options are given below.

- i. HART
- ii. Display
- iii. Date/Time
- iv. Calibration
- v. Battery Info.
- vi. Set Password
- vii. Factory Reset
- viii. About Calibrator

Press F1 key to Enter into the settings of any option.
Description of all settings given below.

4.7.1 HART Settings



The screenshot shows a screen titled "HART" with a subtitle "HART (250 ohms)". There are two radio button options: "NO" (which is selected) and "YES". At the bottom of the screen are "EDIT" and "BACK" buttons.

Select YES to add a Series resistor (250Ω) into the mA circuit. You can then use this instrument together with a HART® communicator to set up and calibrate HART® devices. This option is applicable for mA(24V) Read Power Input Type Only.

4.7.2 Display Settings

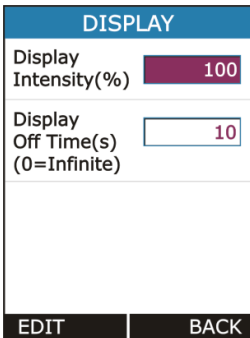

The screenshot shows a screen titled "DISPLAY". It has two settings: "Display Intensity(%)" with a slider set to 100, and "Display Off Time(s) (0=Infinite)" with a text input field set to 10. At the bottom are "EDIT" and "BACK" buttons.

Display Intensity	Display Brightness Settings. <u>Range:</u> 1 ... 100
Display Off Time	Standby Time in second after which display will turn Off. To turn the display off press any key. <u>Range:</u> 0 ... 9999 sec Setting 0 will disable this feature. That means display will never turn off automatically.

4.7.3 Date/Time Settings

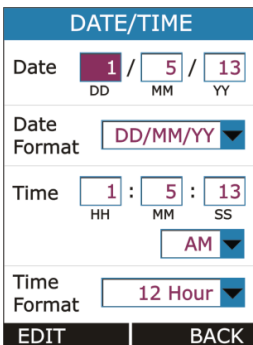

The screenshot shows a screen titled "DATE/TIME". It has four sections: "Date" with fields for DD (1), MM (5), and YY (13); "Date Format" with a dropdown menu showing "DD/MM/YY"; "Time" with fields for HH (1), MM (5), and SS (13), and an "AM" dropdown menu; and "Time Format" with a dropdown menu showing "12 Hour". At the bottom are "EDIT" and "BACK" buttons.

To set the Time + Date of the device

There are 2 Date formats supported in this device DD/MM/YY & MM/DD/YY. This is useful only in Data Logging, to decide in which format Date to be stored.

There are 2 Time formats supported in this device 24 Hour & 12 Hour. This is to select in which format the time should be displayed on Run page & time to be stored in Data Logging.

AM/PM selection is enabled only for 12 Hour Time Format.

4.7.4 Calibration

The instrument is factory calibrated for the specified range, but due to long term drift of components, re-calibration may be necessary in some cases. For calibrating the instrument, a reliable source is required. This source should be at least ten times accurate compared to the range of the instrument.

Note: PCE Instruments can provide a calibration service that is traceable to international standards.

We recommend that you return the instrument to the manufacturer or an approved service agent for calibration. If you use an alternative calibration facility, make sure that it uses these standards.

4.7.5 Battery Info

BATTERY INFO.	
Level(%)	90
Voltage(mV)	4100
Current(mA)	500
Status	Charging
Time to Full(min)	30
Time to Empty(min)	-
BACK	

This page shows the basic battery Information.

- Battery Level (Percentage)
- Battery Voltage (in mV)
- Current (in mA)
- Battery Status
- Time to Full (in min)
- Time to Empty (in min)

4.7.6 About Calibrator

This Page illustrates the Connection diagrams for valid connections to this device.

5 Maintenance and Troubleshooting

5.1 Common Problems

Problem	Possible Causes
Device Not Starting Up	<ul style="list-style-type: none"> • Battery Discharged • Battery Connection Loose
Reading Fluctuation/ Reading OPEN	<ul style="list-style-type: none"> • Wrong / Loose Connections
Error Code on status bar	<ul style="list-style-type: none"> • One of the peripheral not working properly. (Solution: Restart the Device if still error code showing contact PCE Instruments)
Calibration Out	<ul style="list-style-type: none"> • Distortion in due to external noise connection (Solution: Check connection. If still out, contact PCE Instruments or Recalibrate Device in authorized calibration laboratory)
Battery Not Charging	<ul style="list-style-type: none"> • Battery Connection Loose • Battery Dead

5.2 Replacing the Battery

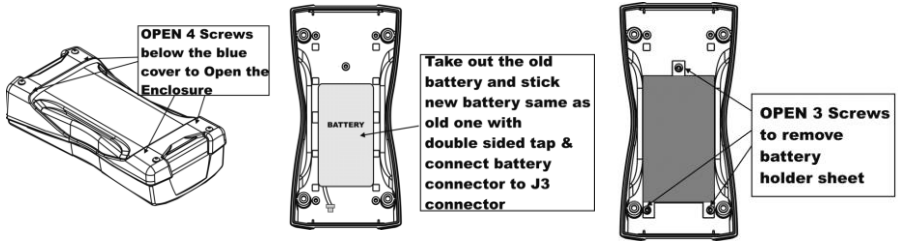

6 Technical Specifications

Measurement parameter		
Voltage mV		
Measuring range	Resolution	Accuracy
0 ... 250 mV	0.01 mV	$\pm 0.02\%$ of rdg. + 2 Dgt
Voltage DC V		
0 ... 30V	0.001V	$\pm 0.02\%$ of rdg. + 2 Dgt
Current DC mA		
0 ... 24-mA	0.001-mA	$\pm 0.02\%$ of rdg. + 2 Dgt
Simulation parameters		
Voltage mV		
0 ... 250 mV	0.01 mV	$\pm 0.02\%$ of rdg. + 2 Dgt
Voltage DC V		
0 ... 12V	0.001V	$\pm 0.02\%$ of rdg. + 2 Dgt
Current DC mA		
0 ... 24-mA	0.001-mA	$\pm 0.02\%$ of rdg. + 2 Dg

General Specifications PCE-LOC 20	
Display modes	Measurement: mA / V // mV Simulation: mA / V // mV
Maximum input voltage	30V DC
Input impedance measurement	mV / V: > 1 M Ω Current measurement: 10 Ω
Response time	<100 ms
Load impedance	> 10 k Ω at mV / V <750 Ω at mA
Refresh rate display	10 Hz
Isolation	500V DC
Data storage	Internal memory 150000 readings
Interface	USB 2.0
Display	2.4" TFT LCD 240 x 320 pixels LED illuminated
Output voltage current loop	24V DC / 24-mA
HART mA loop resistance	250 Ω \pm 20%
Special features	Step and ramp function Automatic and manual mode \sqrt{x} , x2: For the measuring function
Continuity test	Adjustable threshold up to 100 Ω
Power supply	3.7V / 2300-mAh Li-ion battery
Charging time	About 5 h
Power adapter	Input: 100 ... 240V AC / 50/60 Hz Output: 5V / 1 A DC
Battery life	Approx. 18 h: Simulation and measurement with low LCD illumination, approx. 8 h: Measurement with low LCD illumination
Dimensions	162 x 82 x 40 mm / 6.4 x 3.2 x 1.6 in
Weight	About 300 g / < 1 lb
Degree of protection	IP20
Operating conditions	Battery operation: 0 ... 55°C / 32 ... 131°F, 30 ... 90% RH Main operation: 0 ... 45°C / 32 ... 113°F, 30 ... 90% RH
Storage conditions	-20 .. 60°C / -4 ... 140°F, 30 ... 90% rh non-condensing
Heating time	About 15 minutes



7 Warranty

You can read our warranty terms in our General Business Terms which you can find here: <https://www.pce-instruments.com/english/terms>.

8 Disposal

For the disposal of batteries in the EU, the 2006/66/EC directive of the European Parliament applies. Due to the contained pollutants, batteries must not be disposed of as household waste. They must be given to collection points designed for that purpose.

In order to comply with the EU directive 2012/19/EU we take our devices back. We either re-use them or give them to a recycling company which disposes of the devices in line with law.

For countries outside the EU, batteries and devices should be disposed of in accordance with your local waste regulations.

If you have any questions, please contact PCE Instruments.



PCE Instruments contact information

Germany

PCE Deutschland GmbH
Im Langel 4
D-59872 Meschede
Deutschland
Tel.: +49 (0) 2903 976 99 0
Fax: +49 (0) 2903 976 99 29
info@pce-instruments.com
www.pce-instruments.com/deutsch

France

PCE Instruments France EURL
23, rue de Strasbourg
67250 SOULTZ-SOUS-FORETS
France
Téléphone: +33 (0) 972 3537 17
Numéro de fax: +33 (0) 972 3537 18
info@pce-france.fr
www.pce-instruments.com/french

Spain

PCE Ibérica S.L.
Calle Mayor, 53
02500 Tobarra (Albacete)
España
Tel. : +34 967 543 548
Fax: +34 967 543 542
info@pce-iberica.es
www.pce-instruments.com/espanol

United States of America

PCE Americas Inc.
711 Commerce Way suite 8
Jupiter / Palm Beach
33458 FL
USA
Tel: +1 (561) 320-9162
Fax: +1 (561) 320-9176
info@pce-americas.com
www.pce-instruments.com/us

United Kingdom

PCE Instruments UK Ltd
Unit 11 Southpoint Business Park
Ensign Way, Southampton
Hampshire
United Kingdom, SO31 4RF
Tel: +44 (0) 2380 98703 0
Fax: +44 (0) 2380 98703 9
info@industrial-needs.com
www.pce-instruments.com/english

Italy

PCE Italia s.r.l.
Via Pesciatina 878 / B-Interno 6
55010 LOC. GRAGNANO
CAPANNORI (LUCCA)
Italia
Telefono: +39 0583 975 114
Fax: +39 0583 974 824
info@pce-italia.it
www.pce-instruments.com/italiano

The Netherlands

PCE Brookhuis B.V.
Institutenweg 15
7521 PH Enschede
Nederland
Telefoon: +31 (0)53 737 01 92
Fax: +31 (0) 53 - 430 36 46
info@pcebenelux.nl
www.pce-instruments.com/dutch

Chile

PCE Instruments Chile S.A.
RUT: 76.154.057-2
Santos Dumont 738, local 4
Comuna de Recoleta, Santiago, Chile
Tel. : +56 2 24053238
Fax: +56 2 2873 3777
info@pce-instruments.cl
www.pce-instruments.com/chile

Hong Kong

PCE Instruments HK Ltd.
Unit J, 21/F., COS Centre
56 Tsun Yip Street
Kwun Tong
Kowloon, Hong Kong
Tel: +852-301-84912
jyi@pce-instruments.com
www.pce-instruments.cn

China

PCE (Beijing) Technology Co.,Ltd
1519 Room, 6 Building
Men Tou Gou Xin Cheng,
Men Tou Gou District
102300 Beijing
China
Tel: +86 (10) 8893 9660
info@pce-instruments.cn
www.pce-instruments.cn

Turkey

PCE Teknik Cihazları Ltd.Şti.
Halkalı Merkez Mah.
Pehlivan Sok. No.6/C
34303 Küçükçekmece - İstanbul
Türkiye
Tel: 0212 471 11 47
Faks: 0212 705 53 93
info@pce-cihazlari.com.tr
www.pce-instruments.com/turkish