

MT210 / MT210F
MT220
Digital Manometer
U S E R ' S M A N U A L

Product Registration

Thank you for purchasing YOKOGAWA products.

YOKOGAWA provides registered users with a variety of information and services. Please allow us to serve you best by completing the product registration form accessible from our website.

<http://tmi.yokogawa.com/>

Foreword

Thank you for purchasing the YOKOGAWA MT200 Series* Digital Manometer. This user's manual contains useful information about the instrument's functions and operating procedures MT210, MT210F, and MT220, as well as precautions that should be observed during use. To ensure proper use of the instrument, please read this manual thoroughly before beginning operation. After reading the manual, keep it in a convenient location for quick reference whenever a question arises during operation of the instrument.

*MT200 series: MT210 (pressure measurement only)
MT210F (pressure measurement only, includes a measurement mode switching function)
MT220 (includes DMM and 24 VDC output functions)

Notes

- The contents of this manual are subject to change without prior notice as a result of improvements in the instrument's performance and functions.
- Every effort has been made in the preparation of this manual to ensure the accuracy of its contents. However, should you have any questions or find any errors, please contact your nearest YOKOGAWA representative as listed on the back cover of this manual.
- Copying or reproducing any or all parts of the contents of this manual without the permission of YOKOGAWA is strictly prohibited.

Trademarks

- The PC-9800 Series is a product line of NEC Corporation.
- Adobe and Adobe Acrobat are trademarks of Adobe Systems Incorporated.
- VCO is a registered trademark of SWAGELOK in the United States.

Revisions

January 2001	1st Edition
March 2001	2nd Edition
October 2017	3rd Edition
September 2018	4th Edition

Safety Precautions

This product is designed to be used by a person with specialized knowledge. The following general safety precautions must be observed during all phases of operation, service, and repair of this instrument. If this instrument is used in a manner not specified in this manual, the protection provided by this instrument may be impaired. Also, YOKOGAWA assumes no liability for the customer's failure to comply with these requirements.

This manual is part of the product and contains important information. Store this manual in a safe place close to the instrument so that you can refer to it immediately. Keep this manual until you dispose of the instrument.

General definitions of safety symbols used on the instrument and in the manuals



Handle with Care (To avoid injury, death of personnel, or damage to the instrument, the user must refer to an explanation in the user's manual or service manual.)



Alternating current



Direct current



ON (power)



In-position of a bistable push control



OFF (power)



Out-position of a bistable push control

French



À manipuler délicatement. Toujours se reporter aux manuels d'utilisation et d'entretien. Ce symbole a été apposé aux endroits dangereux de l'instrument pour lesquels des consignes spéciales d'utilisation ou de manipulation ont été émises.



Courant alternatif



Courant direct



Marche (alimentation)



Marche



Arrêt (alimentation)



Arrêt

WARNING

- **Use the Instrument Only for Its Intended Purpose**
This instrument is designed to measure the pressure. Use this instrument only as a pressure measurement.
- **Check the Physical Appearance**
Do not use the instrument if there is a problem with its physical appearance.
- **Use the Correct Power Supply**
Before connecting the power cord, ensure that the source voltage matches the rated supply voltage of the instrument and that it is within the maximum rated voltage of the provided power cord.

- **Use the Correct Power Cord and Plug**

To prevent an electric shock or fire, be sure to use the power supply cord supplied by YOKOGAWA. The main power plug can only be plugged into an outlet with a protective grounding terminal. Do not invalidate this protection by using an extension cord without protective earth grounding. Additionally, do not use the power cord supplied with this instrument with another instrument.

- **Connect the Protective Grounding Terminal**

Make sure to connect the protective earth to prevent electric shock before turning on the power. The power cord for this instrument is a three-prong type power cord. Connect the power cord to a properly grounded three-prong outlet.

- **Do Not Impair the Protective Grounding**

Never cut off the internal or external protective earth wire or disconnect the wiring of the protective earth terminal. Doing so may result in electric shock or damage to the instrument.

- **Do Not Use When the Protection Functions Are Defective**

Before using this instrument, check that the protection functions, such as the protective grounding and fuse, are working properly. If you suspect a defect, do not use the instrument.

- **External Connection**

Securely connect the protective grounding before connecting to the item under measurement or control unit.

- **Fuse**

To prevent fire, be sure to use a fuse with the specified ratings (current, voltage, and type). Before replacing the fuse, turn both the POWER switch and the MAIN POWER switch OFF and unplug the power cord. Do not use any fuse other than the specified one. Also do not short-circuit the fuse holder.

- **Do Not Operate in an Explosive Atmosphere**

Do not operate the instrument in the presence of flammable gasses or vapors. Doing so is extremely dangerous.

- **Do Not Remove the Covers or Disassemble or Alter the Instrument**

Only qualified YOKOGAWA personnel may remove the covers and disassemble or alter the instrument. The inside of the instrument is dangerous because parts of it have high voltages.

- **Measuring High-Pressure Gases**

- Use piping and pressure connectors that can withstand the pressure to be measured.
- Make sure that there are no leaks from the piping, connectors, and joints and that the joints are not loose. If the fluid under measurement leaks or if a joint comes loose, the pressure can endanger the user or the surrounding instruments. Note that higher the pressure, greater the danger.
- Do not measure flammable, explosive, toxic, or corrosive fluids.

- **Limitation of Pressure**

Applying a pressure exceeding the prescribed allowable input can damage the instrument. In addition, the applied pressure may be passed on to the device that is connected to the output connector, and cause secondary accidents.

CAUTION

- Do not use the instrument to measure gas or liquids that can corrode the piping material, high temperature liquids (50°C or higher) or gas-liquid mixtures. If you are measuring gas, make sure the gas is dry and clean. Do not measure air with high moisture or high oil content.
- For safety and sanitary reasons, do not use the instrument to measure liquids for drinking.
- This instrument has been designed to withstand physical shock, but to maintain high accuracy, handle the instrument with care (protect the instrument from physical shock).
- Do not use the instrument where the ambient temperature drastically fluctuates. Such environment can cause measurement errors.
- Do not overcharge the batteries.
- Do not operate the instrument in a place where wind or air blows noticeably, otherwise the measurement accuracy will decrease.
- This is an overvoltage category CAT II (EN61010-1) instrument.

French

AVERTISSEMENT



- **Utiliser l'instrument aux seules fins pour lesquelles il est prévu**
Cet instrument est conçu pour mesurer la pression. Utilisez cet instrument uniquement pour la mesure de pression.
- **Inspecter l'apparence physique**
Ne pas utiliser l'instrument si son intégrité physique semble être compromise.
- **Vérifier l'alimentation**
Avant de brancher le cordon d'alimentation, vérifier que la tension source correspond à la tension d'alimentation nominale du cet instrument et qu'elle est compatible avec la tension nominale maximale du cordon d'alimentation.
- **Utiliser le cordon d'alimentation et la fiche adaptés**
Pour éviter les risques de choc électrique ou d'incendie, utilisez le cordon d'alimentation fourni par YOKOGAWA. La fiche doit être branchée sur une prise secteur raccordée à la terre. En cas d'utilisation d'une rallonge, celle-ci doit être impérativement reliée à la terre. Par ailleurs, n'utilisez pas le cordon d'alimentation fourni pour cet instrument avec un autre appareil.
- **Brancher la prise de terre**
Avant de mettre l'instrument sous tension, penser à brancher la prise de terre pour éviter tout choc électrique. Le cordon d'alimentation livré avec l'instrument est doté de trois broches. Brancher le cordon d'alimentation sur une prise de courant à trois plots et mise à la terre.
- **Ne pas entraver la mise à la terre de protection**
Ne jamais neutraliser le fil de terre interne ou externe, ni débrancher la borne de mise à la terre. Cela pourrait entraîner un choc électrique ou endommager l'instrument.
- **Ne pas utiliser lorsque les fonctions de protection sont défectueuses**
Avant d'utiliser l'instrument, vérifier que les fonctions de protection, telles que le raccordement à la terre et le fusible, fonctionnent correctement. En cas de dysfonctionnement possible, ne pas utiliser l'instrument.

- **Connexion externe**
Branchez correctement la mise à la terre protectrice avant de brancher l'élément à mesurer ou l'unité de commande.
- **Fusible**
Pour éviter un incendie, veillez à utiliser un fusible avec les valeurs nominales spécifiées (courant, tension et type). Avant de remplacer le fusible, tournez le commutateur POWER et le commutateur MAIN POWER sur OFF et débranchez le cordon d'alimentation. N'utilisez pas de fusible autre que celui spécifié. Ne court-circuitez pas non plus le porte-fusible.
- **Ne pas utiliser dans un environnement explosif**
Cet instrument n'est pas antidéflagrant. Ne pas utiliser l'instrument en présence de gaz ou de vapeurs inflammables. Cela pourrait être extrêmement dangereux.
- **Ne pas retirer le capot, ni démonter ou modifier l'instrument**
Seul le personnel YOKOGAWA qualifié est habilité à retirer le capot et à démonter ou modifier l'instrument. Certains composants à l'intérieur de l'instrument sont à haute tension et par conséquent, représentent un danger.
- **Mesure du fluide haute pression**
 - Utiliser une tuyauterie et des connecteurs pression pouvant résister à la pression à mesurer.
 - S'assurer de l'absence de fuites au niveau de la tuyauterie, des connecteurs et des joints, et vérifier que les joints ne sont pas desserrés. En cas de fuite du fluide mesuré ou de desserrage d'un joint, la pression risque de mettre en danger l'utilisateur ou les instruments environnants. Il est à noter que plus la pression est élevée, plus le danger est important.
- Ne pas mesurer des liquides inflammables, toxiques ou corrosifs. Une telle action peut s'avérer dangereuse pour l'utilisateur.
- **Limite de pression**
Appliquer une pression dépassant l'entrée autorisée préconisée peut endommager l'instrument. En outre, la pression appliquée peut être transmise à l'appareil branché au connecteur de sortie, et provoquer des accidents secondaires.

ATTENTION

- Ne pas utiliser l'instrument pour mesurer des gaz ou des liquides susceptibles de corroder le matériau de la tuyauterie, des liquides haute température (50 °C ou plus) ni des mélanges gaz-liquides. En cas de mesure de gaz, s'assurer que le gaz est propre et sec. Ne pas mesurer de l'air très humide ni de l'air à haute teneur en huile.
- Pour des raisons sécuritaires et sanitaires, ne pas utiliser l'instrument pour mesurer des liquides destinés à être ingérés.
- Cet instrument a été conçu de façon à résister à des chocs physiques. Cependant, pour maintenir son haut niveau de précision, manipuler l'instrument avec précaution (protéger l'instrument contre les chocs physiques).
- Ne pas utiliser l'instrument dans un lieu exposé à de fortes fluctuations de la température ambiante. Un tel environnement peut provoquer des erreurs de mesure.
- Ne surchargez pas les batteries.
- L'utilisation de l'instrument dans un lieu exposé au vent ou aux courants d'air risque d'affecter la précision de la mesure.
- Il s'agit d'un instrument de catégorie de surtension CAT II (EN61010-1)

Symbols Used in this Manual

Type	Symbol	Meaning
Note		Affixed to the main unit, this indicates that to avoid injury, death, or damage to the instrument, the operator must refer to the corresponding explanation in the manual.
		Describes precautions that should be observed to prevent injury or death to the user.
		Describes precautions that should be observed to prevent damage to the instrument.
	Note	Provides information that is important for proper operation of the instrument.
Key	HOLD	Indicates a key on the front panel.

Checking the Contents of the Package

If you have received the wrong instrument or accessories, or if some accessories are missing or appear abnormal, contact the dealer from which you purchased them. Tell the dealer the model name, suffix code, and instrument number given on the name plate on the side panel.

MODEL (Type Name)

Model Code (Series Name)	Basic Specifications
767351 (MT220)	Gauge pressure (10 kPa) (includes DMM and 24 VDC output functions)
767353 (MT220)	Gauge pressure (130 kPa) (includes DMM and 24 VDC output functions)
767355 (MT220)	Gauge pressure (700 kPa) (includes DMM and 24 VDC output functions)
767356 (MT220)	Gauge pressure (3000 kPa) (includes DMM and 24 VDC output functions)
767357 (MT220)	Absolute pressure (130 kPa abs) (includes DMM and 24 VDC output functions)
767361 (MT210)	Gauge pressure (10 kPa)
767363 (MT210)	Gauge pressure (130 kPa)
767365 (MT210)	Gauge pressure (700 kPa)
767366 (MT210)	Gauge pressure (3000 kPa)
767367 (MT210)	Absolute pressure (130 kPa abs)
767370 (MT210)	Differential pressure (1 kPa)
767371 (MT210)	Differential pressure (10 kPa)
767372 (MT210)	Differential pressure (130 kPa)
767373 (MT210)	Differential pressure (700 kPa)
767381 (MT210F)	Gauge pressure (10 kPa) includes measurement mode switching function
767383 (MT210F)	Gauge pressure (130 kPa) includes measurement mode switching function
767385 (MT210F)	Gauge pressure (700 kPa) includes measurement mode switching function
767386 (MT210F)	Gauge pressure (3000 kPa) includes measurement mode switching function
767387 (MT210F)	Absolute pressure (130 kPa abs) includes measurement mode switching function

SUFFIX (Suffix Code)

Name	Suffix Code	Description
Units of pressure	-U1	kPa only
	-U2	kPa, switchable to kgf/cm ² , mmH ₂ O, and mmHg
	-U3	kPa, switchable to kgf/cm ² , mmH ₂ O, mmHg, inH ₂ O, inHg, and psi
Communication interface	-C1	GP-IB Interface
	-C2	RS-232 Interface
Input connection	-P1	Rc 1/4
	-P2	1/4 NPT female-threaded
	-P3	VCO 1/4 ^{*1}
Power cord ^{*2}	-D	UL Standard
	-F	VDE Standard
	-R	AS Standard
	-Q	BS Standard
	-H	GB Standard

Options /DA D/A output, comparator output, and external trigger input

*1: VCO is a registered trademark of SWAGELOK Company.

*2: The power cord must be changed if a 200-V power line is used. Consult the manufacture.

Standard Accessories

The following standard accessories are supplied with the instrument. Make sure that all items are present and undamaged.

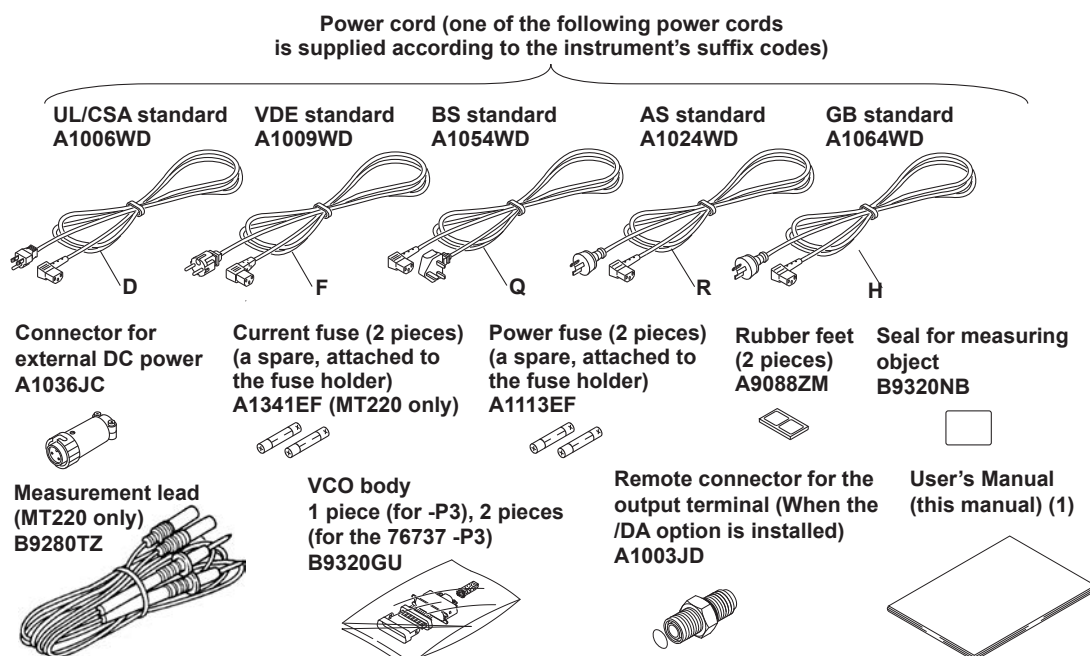

Standard accessories are not covered by warranty of this instrument.

Optional Accessories

The following optional accessories are also available. Upon receipt of any optional accessories, make sure that no items are missing or damaged.

Part Name	Model/Part No.	Minimum Purchase Quantity
Battery pack		
Seal, screws (M5 × 40 mm × 4)	269913	1
Ni-Cd batteries	269914	1 (3 Ni-Cd batteries as a set)
Carrying case	B9320ND	1
Connector assembly for Rc (for φ4 × φ6 vinyl tube) (For I/O connection section code -P1)	B9984BY	1
Connector assembly for Rc (for φ4 × φ6 vinyl tube) (For I/O connection section code -P2)	B9984BW	1
Conversion connector (JIS, R1/4-Rc1/8)	G9612BG	1
Conversion connector (ANSI, R1/4-1/4NPT female)	G9612BJ	1
Conversion connector (ANSI, R1/4-1/8NPT female)	G9612BW	1

**Connector assembly for Rc
for the φ4×φ6 vinyl tube**

For I/O connection section code -P1: B9984BY
For I/O connection section code -P2: B9984BW

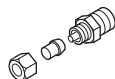

**Simple connector assembly
B9310ZH**

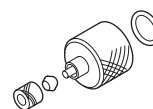

**Conversion connector
(JIS) G9612BG**



**Conversion connector
(ANSI) G9612BJ**



**Conversion connector
(ANSI) G9612BW**



Optional accessories (sold separately) are not covered by warranty of this instrument.

If you have any questions regarding optional accessories, or if you wish to place an order, contact the dealer from whom you purchased the instrument.

Compliance with the Radio Waves Act (Republic of Korea)

This product complies with the Radio Waves Act Act (Republic of Korea).

Note the following when using the product in Republic of Korea.

이 기기는 업무용 (A 급) 전자파적합기기로서 판매자 또는 사용자는 이 점을 주의하시기 바라며 , 가정외의 지역에서 사용하는 것을 목적으로 합니다 .

(The product is for business use (Class A) and meets the electromagnetic compatibility requirements. The seller and the user must note the above point and use the product in a place except for home.)

Registration No: KCC-REM-IMY-ERA010
 Equipment Name: DIGITAL MANOMETER
 Trade Name: Yokogawa Test & Measurement Corporation
 Manufacturer: Yokogawa Test & Measurement Corporation

Emission	This is a Class A product. Operation of this product in a residential area may cause radio interference in which case the user is required to correct the interference.
Test conditions	CHARGE START: ON, 24V DC: ON, LIGHT: ON, AC mode/DC mode(BATTERY PACK) All other settings at factory default.
Cable conditions	<ul style="list-style-type: none"> • AC POWER Connector Connect the power cord A1009WD. • DC POWER SUPPLY connector Connect the DC power supply cable (length: 2.8 m). • OUTPUT connector Connect the DA output cable (length: 3.0 m) . • DA OUTPUT connecto Connect the banana-alligator cable(366961, length: 2.5 m). • GP-IB (IEEE488) connector Connect the GP-IB cables (IEEE488, length: 3.0 m). • INPUT A/COM (MT220) Connect the measurement lead (758933^{*1}, length: 1.0 m). • 24 V OUTPUT Connect the banana-alligator cable(366961^{*2}, length: 1.3 m). • INPUT Unconnect.
Immunity	
Immunity influence	Within the range specified by measured value $\pm 15\%$ of range EN61326-1 Table 2 (for industrial environment)
Test conditions	CHARGE START: ON, 24V DC: ON, LIGHT: ON, AC mode/DC mode(BATTERY PACK) All other settings at factory default.

*1 The point of banana-alligator cable 366961 is shorted.

*2 Bring registance of 800 Ω (470 Ω , 330 Ω) in the point of the cable

Contents

Foreword.....	1
Safety Precautions	
Symbols Used in this Manual.....	6
Checking the Contents of the Package.....	6
Compliance with the Radio Waves Act (Republic of Korea)	9
Name and Functions of Each Part	
System Block Diagram.....	12
Functions	14
Front Panel	16
Rear Panel	18
Side View	19
Before Starting Measurement	
Precautions During Use.....	20
Operating Conditions	21
Supplying AC Power	22
Supplying DC Power.....	23
Turning the Power Switch ON/OFF.....	24
Opening Messages	26
Default Settings (On Shipment from the Factory).....	27
Initializing Settings	27
Pressure Measurement	
Zero Calibration	28
Input Function	29
Selecting the Units.....	32
Selecting the Number of Display Digits.....	32
Relative Display	32
Turning the Back Lighting ON/OFF.....	33
Turning the ata Hold Function ON/OFF	33
Trigger.....	33
D/A Output (/DA Option).....	34
Comparator Function (/DA Option)	36
Setting the Beep Sound	36
Keylock Function.....	36
Setting the Measurement Mode.....	37
Output Connector (/DA Option).....	38
Adjusting and Calibrating the Differential Pressure Transmitter using the MT220	
Connecting the Differential Pressure Transmitter to the MT220	39
24 VDC Ouput.....	40
DMM Function.....	41
% Display	41
Error Display	42
Storing and Recalling Data (MT220 Only)	
Storing Data	43
Manual Store.....	44
Data Recall	44
Deleting Data	45
Displaying the Number of Data Items Which Can Be Stored.....	45
Battery Pack (Optional)	
Connecting the Battery Pack to the Main Unit	46
Charging the Ni-Cd Batteries	47
Replacing the Ni-Cd Batteries.....	49
Overview of the GP-IB Interface	
GP-IB Interface Function	51
GP-IB Interface Specifications	51

Turning GP-IB ON/OFF.....	51
Interface Messages Supported by the Instrument.....	52
Switching between Remote and Local Mode.....	52
Setting the Mode and Address.....	52
Setting the GP-IB Interface.....	53
Overview of the RS-232 Interface	
RS-232 Interface Functions.....	54
RS-232 Interface Specifications.....	54
Connecting the RS-232 Interface Cable.....	54
Connector and Signal Names.....	55
Signal Direction.....	55
Table of RS-232 Standard Signals and Their JIS and CCITT Abbreviations.....	56
Handshaking.....	56
Description of Each Handshaking Method.....	57
Precautions Regarding Data Receiving Control.....	58
Setting the Data Format.....	58
RS-232 Communications Settings.....	59
Selecting Normal or Talk-Only Mode.....	59
Setting the Handshaking Mode, Data Format, and Baud Rate.....	60
RS-232 Specific Commands.....	60
Before Programming	
Basic Programming Format.....	61
Precautions when Programming.....	61
How to Use the Appendix.....	61
Troubleshooting, Maintenance, and Inspection	
Items to be Checked in Case of an Abnormality.....	62
Error Codes and Corrective Actions.....	62
Self-Test Error When the Power is Turned ON.....	63
Calibrating the Pressure Measurement Function.....	64
Calibrating the DMM Function (MT220 Only).....	64
Recommended Replacement Parts.....	66
Replacing the Fuse.....	66
Fuse Position and Replacement Method.....	67
Specifications	
Pressure Measurement Section (767351/767361/767381/767353/767363/767383/ 767355/767365/767385).....	68
Pressure Measurement Section (767356/767366/767386/767357/767367/767387).....	69
Pressure Measurement Section (767370/767371).....	70
Pressure Measurement Section (767372/767373).....	70
Pressure Measurement Section (Common to All Models).....	71
DCV and DCA Measurement Section, MT220 Only.....	71
24 V Supply Section, MT220 Only.....	71
Data memory function, MT220 Only.....	71
Communication Function (install either one).....	72
Option /DA.....	72
Common Specifications.....	73
External Dimensions.....	74
Appendix	
Command List.....	App-1
Communications Command List.....	App-2
Status Byte Format.....	App-12
Data Output Format.....	App-13
Header Section.....	App-13
Output Format for Recalled Data (Response to the "ORD" Command, MT220 Only).....	App-15
Output Format of Setup Information (Response to the "OS" Command).....	App-15
Sample Program.....	App-16
Index	

Name and Functions of Each Part

System Block Diagram

The fluid pressure to be measured is sent to the resonant sensor section. The resonant sensor section consists of a resonant sensor (developed by YOKOGAWA) and an excitation circuit to convert the fluid pressure to a frequency signal. The frequency signal is then sampled in the pressure sensor section at the rate corresponding to the current measurement mode and converted into a pressure value. As necessary, the converted pressure value undergoes processing such as averaging, and is then sent to the main CPU and displayed.

The /DA option section is made up of a D/A output section with comparator output as well as an I/O section that controls the external trigger input. The D/A output section outputs the D/A signal corresponding to the pressure value received from the pressure calculation section at 2 ms period. The comparator output section outputs the results obtained by comparing the upper and lower limits of pressure to the measured pressure (synchronized to D/A output). When put on HOLD, measurement is performed one time when a falling signal is input to the external input trigger.

There are three measurement modes (normal, medium-speed, high-speed) on the MF210F. In addition, dynamic mode is available when the /DA option is installed. This mode provides high precision pressure measurements and high-speed D/A output at the same time.

The MT220 has a DMM function and a 24 VDC output function.

The DMM is controlled by the main CPU. The input current and voltage signals are converted to digital signals by the A/D converter and sent to the main CPU. In the main CPU they are converted to current and voltage values, then averaging is performed (in the same manner as occurs with pressure values) and the results are displayed. 24 VDC output is turned ON and OFF by the main CPU. The instrument has an excess current detection function, and detection signals are sent to the main CPU.

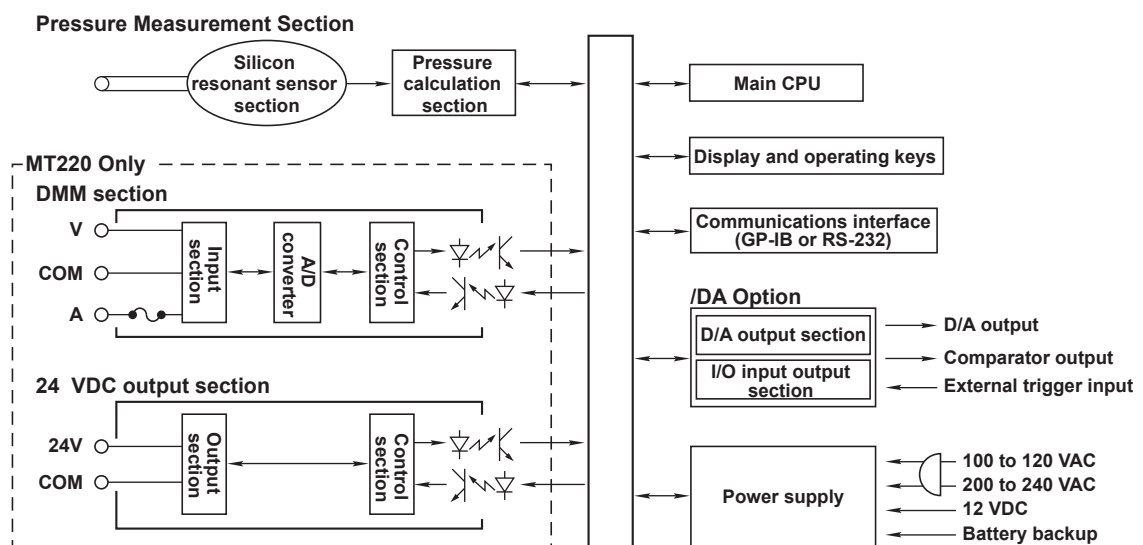

Power Supply and Power Switch

This instrument can be operated from three different kinds of power supply, commercial power, DC power (10 to 15 VDC), and battery pack (optional). To operate the instrument using commercial power, turn ON both the MAIN POWER switch (rear panel) and POWER switch (front panel). In most cases, you should always leave the MAIN POWER switch ON, and turn the power ON or OFF using the POWER switch only.

To operate the instrument using DC power, turn the power ON or OFF using the POWER switch only. It does not matter whether the MAIN POWER switch is ON or OFF.

When operating the instrument using the battery pack, turn the power ON or OFF using the POWER switch only.

If commercial power is supplied to the instrument and the MAIN POWER switch is ON, the batteries will be trickle-charged. In trickle-charging, the batteries are charged until natural discharge has been compensated for. Thus, to charge the batteries completely, follow the operations on page 39, "Charging the Ni-Cd Batteries."

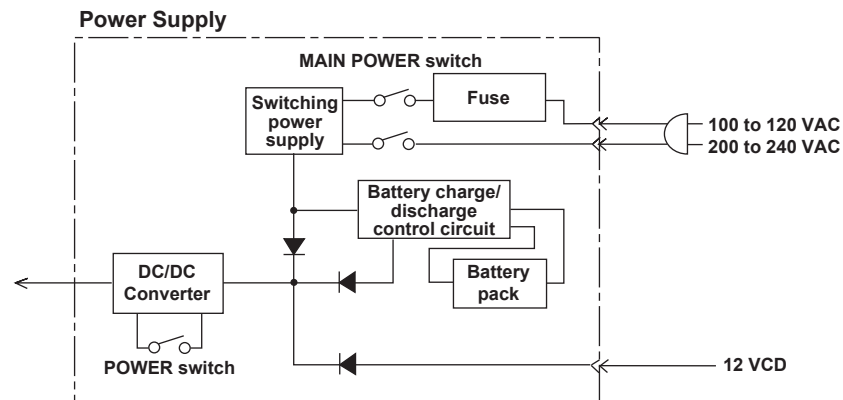

Functions

Functions Common to the MT210, MT210F, and MT220

- **Pressure Measurement (Gas and Liquid)**

Measured values are displayed in 5-1/2 digits. They can also be displayed in 4-1/2 digits (the lowest digit is masked).
However, with the 700 kPa model (767355, 767365, 767373, and 767385), measured values are displayed only in 4-1/2 digits (or 3-1/2 digits when the lowest digit is masked).
- **Zero Calibration**

In order to maintain measurement accuracy, corrections are made to compensate for the effects caused by changes in temperature and installation environment.
- **Communications Function (GP-IB or RS-232)**

Remote control and acquisition of measured data can be performed via the specified communications interface (GP-IB or RS-232).
- **Data Hold**

Stops acquisition of data and puts the displayed data on hold.
- **Relative Display**

Pressure is displayed as relative values.
- **Averaging Function**

Turns ON/OFF averaging for pressure data. Response times differ as shown below depending on whether averaging is ON or OFF.
Averaging ON: 2.5 s or less (5 s or less for the 767370).
Averaging OFF: 1 s or less.
- **Three Types of Power Supply**

The instrument can be operated by commercial power (100 to 120 VAC, 200 to 240 VAC), DC power (10 to 15 VDC), or external battery pack (optional).
- **Key Lock**

Locks the **ZERO CAL** key, or all keys except the **MENU** and **LIGHT** keys.

MT210F Only**• Three Measurement Modes**

With the three measurement modes (normal, medium-speed, and high-speed), you can perform highly precise pressure measurements with rapid response.

• Dynamic Mode (/DA option Only)

When dynamic mode is ON, you can achieve D/A output with fast response regardless of the measurement mode. This allows high-speed D/A output while displaying the data in highly precise normal measurement mode.

MT220 Only**• DMM Function (DCV, DCA Measurement)**

Measurement of voltage (1 to 5 V) and current (4 to 20 mA) is possible, and measured values are displayed in 4-1/2 digits.

A fuse is provided in each current terminal to protect against excessive current.

• 24 VDC Power Supply

Floating output. The maximum output is 24 V/30 mA.

• Input % Display

Pressure: Displayed as a percentage relative to the specified full scale setting.

Current/Voltage: Displayed as a percentage with 1 to 5 V or 4 to 20 mA as 0% to 100%.

• Error Display (%ERROR)

The difference between the measured current or voltage (%) and the input pressure (%) is displayed as a percentage (%).

• Data Storage

Up to 2000 data can be stored in the internal memory.

/DA Option**• D/A output**

D/A output allows you to output measured pressure data at ± 2 V or ± 5 V.

• Comparator Output

Compares measured pressure data (D/A output value) to a reference value and outputs the results as a TTL level.

Front Panel

The front panels of the MT210, MT210F, and MT220 are shown in the figures below. The MT210 and MT210F have the same key layouts. MT210F (not MT210) is displayed in the upper left of the MT210F.

MT210 Differential Pressure Model

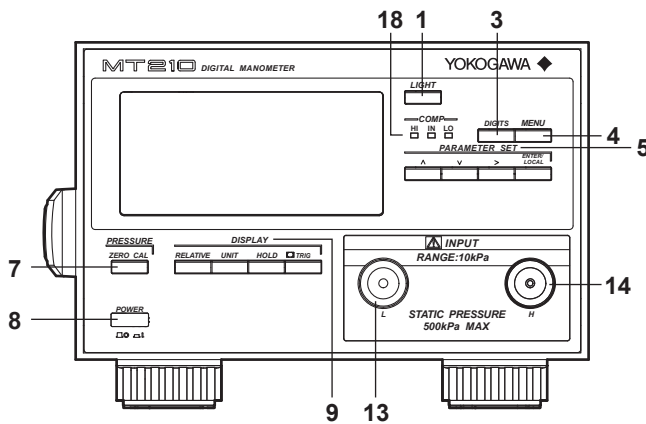

MT210/MT210F Absolute Pressure/Gauge Pressure Model

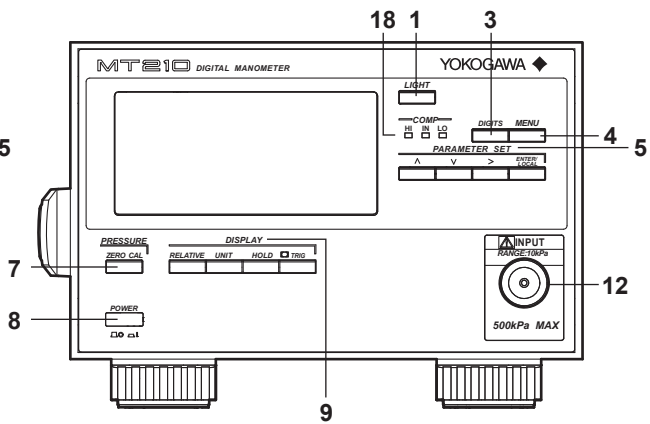

MT220 Absolute Pressure/Gauge Pressure

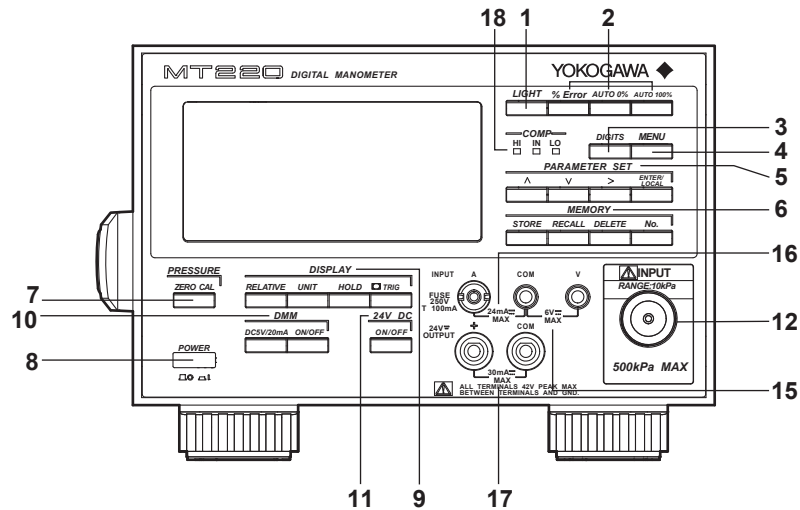

Front Panel

1. LIGHT key
Turns the back lighting ON and OFF.
2. % display setting keys
%ERROR Switches between % display and %ERROR display.
Auto 0% Sets the value corresponding to 0% pressure automatically.
Auto 100% Sets the value corresponding to 100% pressure automatically.
3. DIGITS key
Switches the number of display digits between 5-1/2 and 4-1/2 digits.
(Or between 4-1/2 and 3-1/2 digits for the models 767355, 767365, 767373, and 767385.)
4. MENU key
Controls various kinds of setting actions. Pressing this key when a setting screen is displayed returns to the normal measurement screen.

5. PARAMETER SET keys
 - ▲** Selects parameters to be set, and increments the active (blinking) digit.
 - ▼** Selects parameters to be set, and decrements the active (blinking) digit.
 - >** Changes the active digit.
 - ENTER/** Enters the selected values.
 - LOCAL** Clears remote mode.
6. MEMORY keys
 - STORE** Stores data in the internal memory.
 - RECALL** Recalls data from the internal memory.
 - DELETE** Deletes data from the internal memory.
 - No.** Designates the memory number to which data is to be stored or from which it is to be recalled.
7. ZERO CAL (Zero Calibration) key
 - Performs zero pressure calibration.
8. POWER switch
 - Turns the power ON and OFF during daily operation.
9. DISPLAY keys
 - RELATIVE** Displays pressure as a relative value.
 - UNIT** Switches the unit of measured pressure.
 - HOLD** Stops acquisition of data and puts the displayed data on hold.
 - TRIG** The trigger is activated once while the data is on hold.
10. DMM keys
 - DC5 V/20 mA** Selects whether voltage or current is to be measured.
 - ON/OFF** Selects whether the DMM function is to be used or not.
11. 24 V output key
 - Turns 24 V output ON and OFF.
12. Pressure input port
 - A pressure input port is also provided on the rear panel, but it is not possible to use both ports at the same time.
13. Pressure input port (Low)
 - A pressure input port is also provided on the rear panel, but it is not possible to use both ports at the same time.
14. Pressure input port (High)
 - A pressure input port is also provided on the rear panel, but it is not possible to use both ports at the same time.
15. Voltage input terminal
 - For measuring voltage using the DMM function.
16. Current input terminal
 - For measuring current using the DMM function.
17. 24 VDC output connector
 - Supplies 24 VDC.
18. Comparator monitor LED (/DA option only)
 - Displays the results from the comparator function.
 - Displays the result of the comparator function.

Rear Panel

The rear panels of the MT210, MT210F, and MT220 are shown in the figures below. The MT210F/MT220 differential pressure model is not shown.

Absolute Pressure and Gauge Pressure Models (MT210/MT210F/MT220)

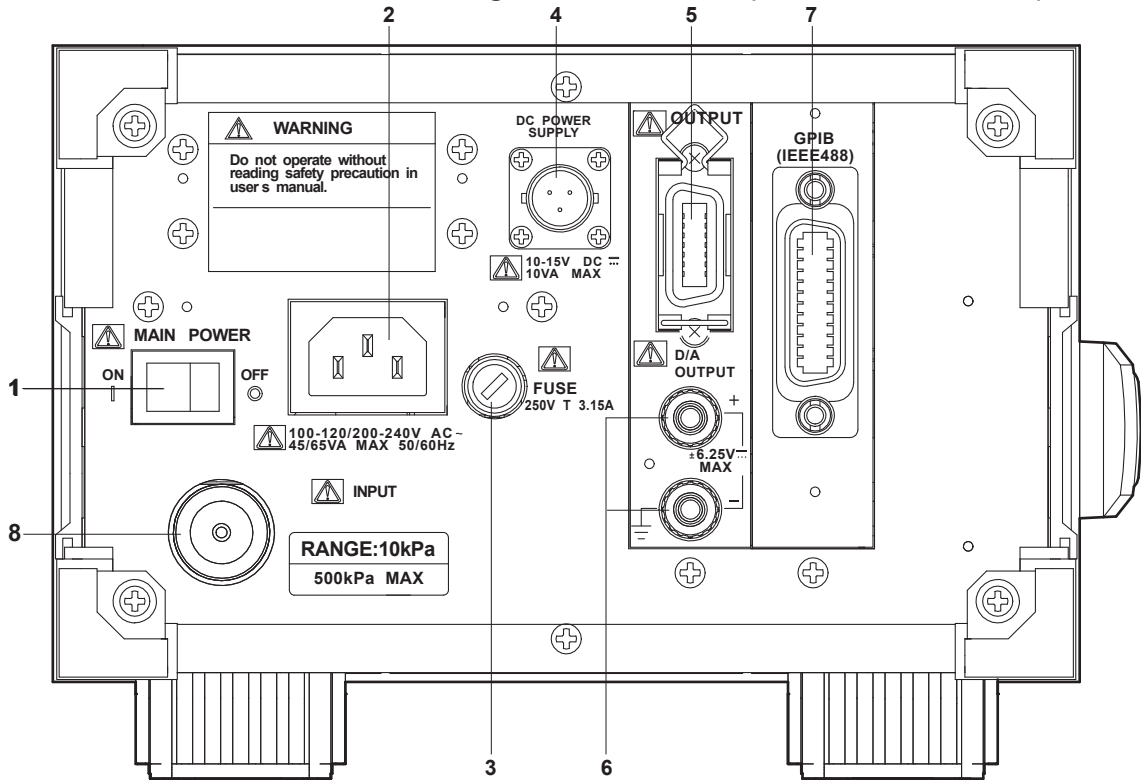

Differential Pressure Model (MT210)

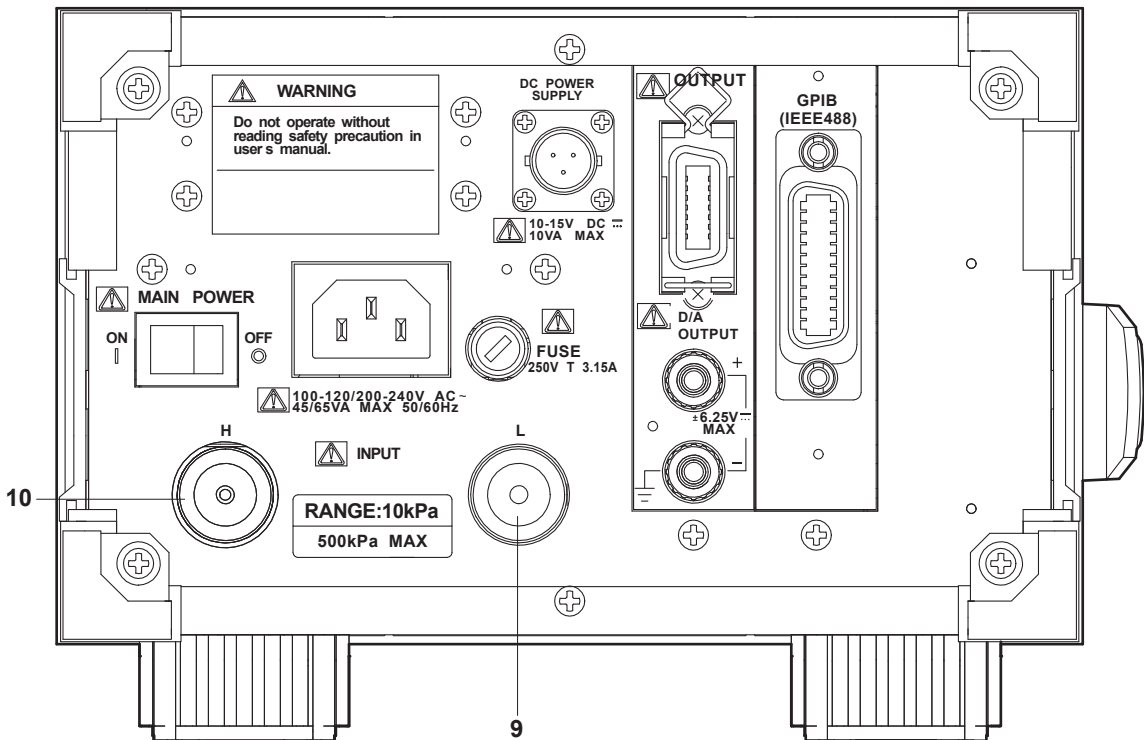

Rear Panel

1. MAIN POWER switch
Turns commercial power ON and OFF. Turning this switch OFF shuts off the primary side of the power supply circuit. Turn this switch ON while the batteries are charging.
2. Power connector
A 3-prong connector with a protective grounding terminal. Connect using the power supply cord provided. Always use protective grounding to prevent electric shock. Only use a power supply within the specified voltage and frequency range.
3. FUSE
A time lag fuse, rated at 250 V, 3.15 A.
4. DC power connector
Used to operate the instrument on DC power (10 to 15 VDC).
5. Output terminal (only when the /DA option is installed)
A connector used for comparator output, external trigger input (both TTL level), or D/A output.
6. D/A output terminal (only when the /DA option is installed)
A connector used for D/A output.
7. Communications connector
A GP-IB or RS-232 used for connecting to a controller (such as a PC) with a communications cable.
8. Pressure input port
A pressure input port is also provided on the front panel, but it is not possible to use both ports at the same time.
9. Pressure input port (Low)
A pressure input port is also provided on the front panel, but it is not possible to use both ports at the same time.
10. Pressure input port (High)
A pressure input port is also provided on the front panel, but it is not possible to use both ports at the same time.

Side View

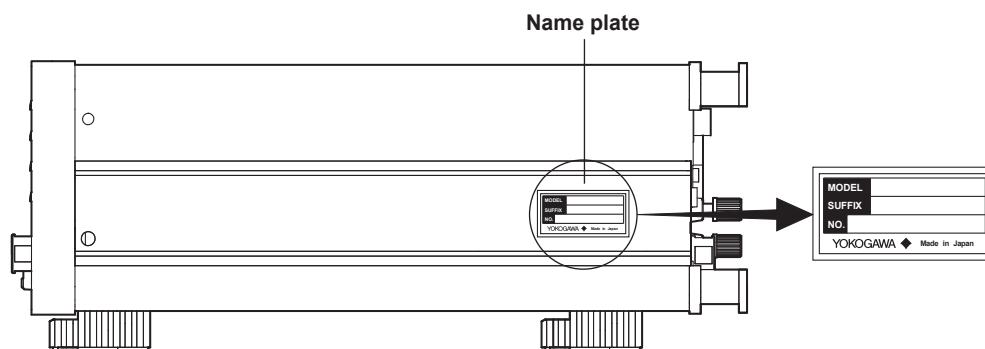

Before Starting Measurement

Precautions During Use

Safety Precautions

- If you are using this instrument for the first time, make sure to thoroughly read the safety precautions given on page 2.
- Do not remove the cover from the instrument.
Some parts of the instrument carry high voltages and are extremely dangerous. When the instrument needs internal inspection or adjustment, contact your dealer or nearest YOKOGAWA representative as listed on the back cover of this manual.
- If you notice smoke or unusual odors coming from the instrument, turn both the POWER and MAIN POWER switches OFF and unplug the power cord immediately. Also turn OFF the power to the measuring object connected to the input section of the instrument. Contact your dealer or nearest YOKOGAWA representative as listed on the back cover of this manual.
- Nothing should be placed on the power cord, and it should be kept away from any heat sources. When unplugging the power cord from the AC outlet, never pull the cord itself. Always hold the plug and pull it. If the power cord is damaged, contact your dealer. Refer to page 5 for the part number to reference when placing an order.

General Handling Precautions

- When moving the instrument, disconnect the power cord and connecting cables. Always carry the instrument by the handle located on the left side of the instrument.
- Keep electrically charged objects away from the input or output terminals. They may damage the internal circuits.
- Do not allow volatile chemicals, or rubber or vinyl products to come into contact with the case or operation panel for prolonged periods. Doing so may result in discoloration.
- Take care not to allow any hot items such as a soldering iron to come into contact with the operation panel.
- When the instrument is not going to be used for a long period, unplug the power cord from the AC outlet.
- For precautions when handling the battery pack, refer to page 39, "Battery Pack (Optional)."
- When removing dirt from the case or operation panel, first remove the power cord, then use a clean, dry cloth to gently wipe the external surfaces of the instrument. Do not use any solvents such as benzene or paint thinner. Doing so might cause discoloration or deformation.

Operating Conditions

The instrument must be used in a place where the following conditions are met.

Ambient Temperature and Humidity

- Ambient temperature: 5 to 40°C (10 to 35°C for the 767370).
To ensure high measurement accuracy, the ambient temperature should be $23 \pm 3^\circ\text{C}$.
- Ambient humidity: 20% to 80% RH, with no condensation present.

Note

- Internal condensation may occur if the temperature changes rapidly or if the instrument is moved to a new location where both the ambient temperature and humidity are higher. If the instrument is moved, allow it to acclimatize to its new environment for at least one hour before starting operation.
- Never use the instrument in a place where it may be exposed to direct sunlight, otherwise the temperature of the instrument will rise higher than the ambient temperature.

Never Use the Instrument in the Following Places

- Near heat sources
- Where an excessive amount of soot, steam, dust, or corrosive gases are present
- Near strong magnetic field sources
- Near high voltage equipment or power lines
- Where there is a high level of mechanical vibration
- On an unstable surface
- At an altitude exceeding 2000 meters

Operation Position

Place the instrument in a horizontal or vertical position, or place it so that it is tilted and supported by the stand.

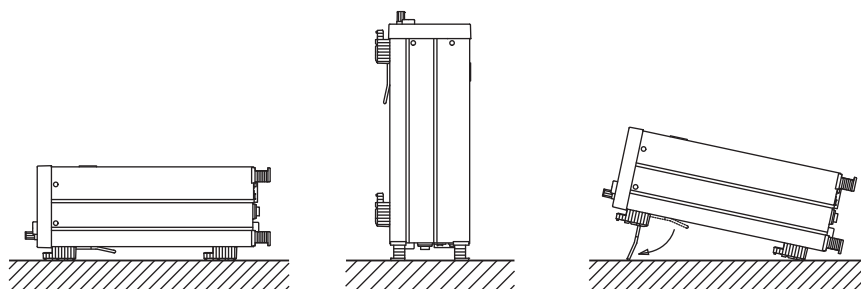

Supplying AC Power

Connecting the Power Cord

Make sure that you perform the following steps before connecting the power. Failure to do so may cause an electric shock or cause damage to the instrument.



WARNING

- Before connecting the power cord, ensure that the source voltage matches the rated supply voltage of the instrument and that it is within the maximum rated voltage of the provided power cord.
- Connect the power cord after confirming that both the MAIN POWER switch (rear panel) and the POWER switch (front panel) are OFF.
- To prevent electric shock or fire, use only the power cord supplied with this instrument.
- Make sure to connect protective earth grounding to prevent electric shock. Connect the power cord to a three-prong power outlet with a protective earth terminal.
- Do not use an extension cord without protective earth ground. The protective features of the instrument will be rendered ineffective.

French



AVERTISSEMENT

- Avant de brancher le cordon d'alimentation, vérifier que la tension source correspond à la tension d'alimentation nominale du DLM4000 et qu'elle est compatible avec la tension nominale maximale du cordon d'alimentation.
- Brancher le cordon d'alimentation après avoir vérifié que l'interrupteur d'alimentation principal de l'instrument est sur OFF.
- Pour éviter tout risque de choc électrique ou d'incendie, utiliser exclusivement le cordon d'alimentation fourni par YOKOGAWA et prévu pour l'instrument.
- Relier l'instrument à la terre pour éviter tout risque de choc électrique. Brancher le cordon d'alimentation sur une prise de courant à trois plots reliée à la terre.
- Toujours utiliser une rallonge avec broche de mise à la terre, à défaut de quoi l'instrument ne serait pas relié à la terre.

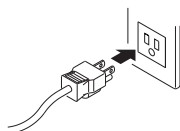

Power Rating

Rated supply voltage range	: 100 to 120 VAC/220 to 240 VAC
Permitted supply voltage range	: 90 to 132 VAC/180 to 264 VAC
Rated supply voltage frequency	: 50/60 Hz
Permitted supply voltage frequency range	: 47 to 63 Hz
Power consumption (pressure measurement only)	
	: 25 VA MAX (100 VAC)
	: 40 VA MAX (200 VAC)
Power consumption (pressure measurement + DMM + 24V output + charging time)	
	: 45 VA MAX (100 VAC)
	: 65 VA MAX (200 VAC)

Supplying DC Power**Connecting the Power Cord**

The pin assignment of the external DC power connector is shown below. Use a cord that matches the DC power to be used.

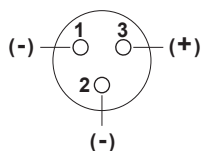
**Note**

Pins 1 and 2 are short-circuited internally.

Power Rating

Rated supply voltage range	: 10 to 15 VDC
Permitted supply voltage range	: 9 to 16.5 VDC
Maximum power consumption	: 10 VA MAX

**WARNING**

- To prevent electric shock, use a power supply not exceeding 60 VDC.

**CAUTION**

- Never short-circuit the terminals.
- If a DC voltage exceeding the permitted supply voltage range is input to the instrument, damage may result.
- The number 1 and 2 connector pins of the external DC power supply have the same electric potential as the meter case. Do not connect a floating power supply.
- Do not supply AC power when a DC power supply is used. It may damage the instrument.

French



AVERTISSEMENT

- Afin d'éviter tout risque de choc électrique, utilisez une alimentation électrique ne dépassant pas 60 VDC.
-



ATTENTION

- Ne mettez jamais les bornes en court-circuit.
 - L'application à l'instrument d'une tension c.c. dépassant la plage de tension d'alimentation permise peut provoquer des dommages.
 - Les broches du connecteur numéro 1 et 2 de l'alimentation électrique c.c. externe ont le même potentiel électrique que le boîtier du compteur. Ne branchez pas une alimentation électrique flottante.
 - Ne fournissez pas de courant c.a. lorsqu'une alimentation électrique c.c. est utilisée. Cela peut endommager l'instrument.
-

Turning the Power Switch ON/OFF

To Be Checked before Turning the Power ON

- Check that the instrument is correctly installed as described on page 17, "Operation Position."
- Check that the power supply specification to be used matches the one specified for the power cord. Refer to "SUFFIX (Suffix Code)" on page 4.
- Is the proper power is being supplied? See page 18, "Power Rating"
See page 39, "Battery Pack"

Location of the Power Switches

There are two power switches. One is the MAIN POWER switch which is located on the rear panel. The other is the POWER switch located at the lower left corner of the front panel. For a description of the differences between these switches, refer to page 9, "Power Supply and Power Switch."

Turning the Power ON/OFF

MAIN POWER Switch on Rear Panel

Press the ON side of the switch. This operation is not necessary if the instrument is operated using DC power or the battery pack.

POWER Switch on Front Panel

This is a push-button type switch and the power is turned ON and OFF alternately as the switch is pressed.

Note

- When operating under DC power or the battery pack an indicator  is displayed in the upper part of the screen.
 - When starting up using DC power or the battery back, the GP-IB and D/A output functions are turned off.
 - If the power is cut while the power switch is turned ON, the instrument may not start up properly. If this happens, turn the power switch OFF, then back ON again.
 - The warm-up time required to satisfy all specifications is approximately five minutes.
-

Response at Power OFF

Settings made prior to turning OFF the power are backed up. Thus, the instrument will be setup using these saved settings the next time the power is turned ON. However, some settings are not backed up. For details, refer to page 22, "Default Settings (on Shipment from the Factory)."

Note

The settings are backed up by lithium batteries. The batteries last for approximately five years if they are used at an ambient temperature of 23°C. If the batteries run out, the data stored in the internal memory will be lost when the power is turned OFF. If the batteries appear to be running out, they need to be replaced immediately. The batteries cannot be replaced by the user. Contact your nearest YOKOGAWA representative as listed on the back cover of this manual.

Response and Display at Power ON

The self-test starts automatically when the POWER switch is turned ON. The self-test checks each memory location. If the check results are satisfactory, the opening messages will appear as shown on the following page, and the instrument will be ready for measurement.

If an error code appears at the end of the self-test, the instrument is not functioning properly. In this case, turn both the POWER and MAIN POWER switches OFF immediately and contact your dealer or nearest YOKOGAWA representative. Give them the model name and serial number from the name plate on the side panel, as well as any error codes that were displayed.

Note

If an error code appears, refer to page 54, "Error Codes and Corrective Actions."

Opening Messages

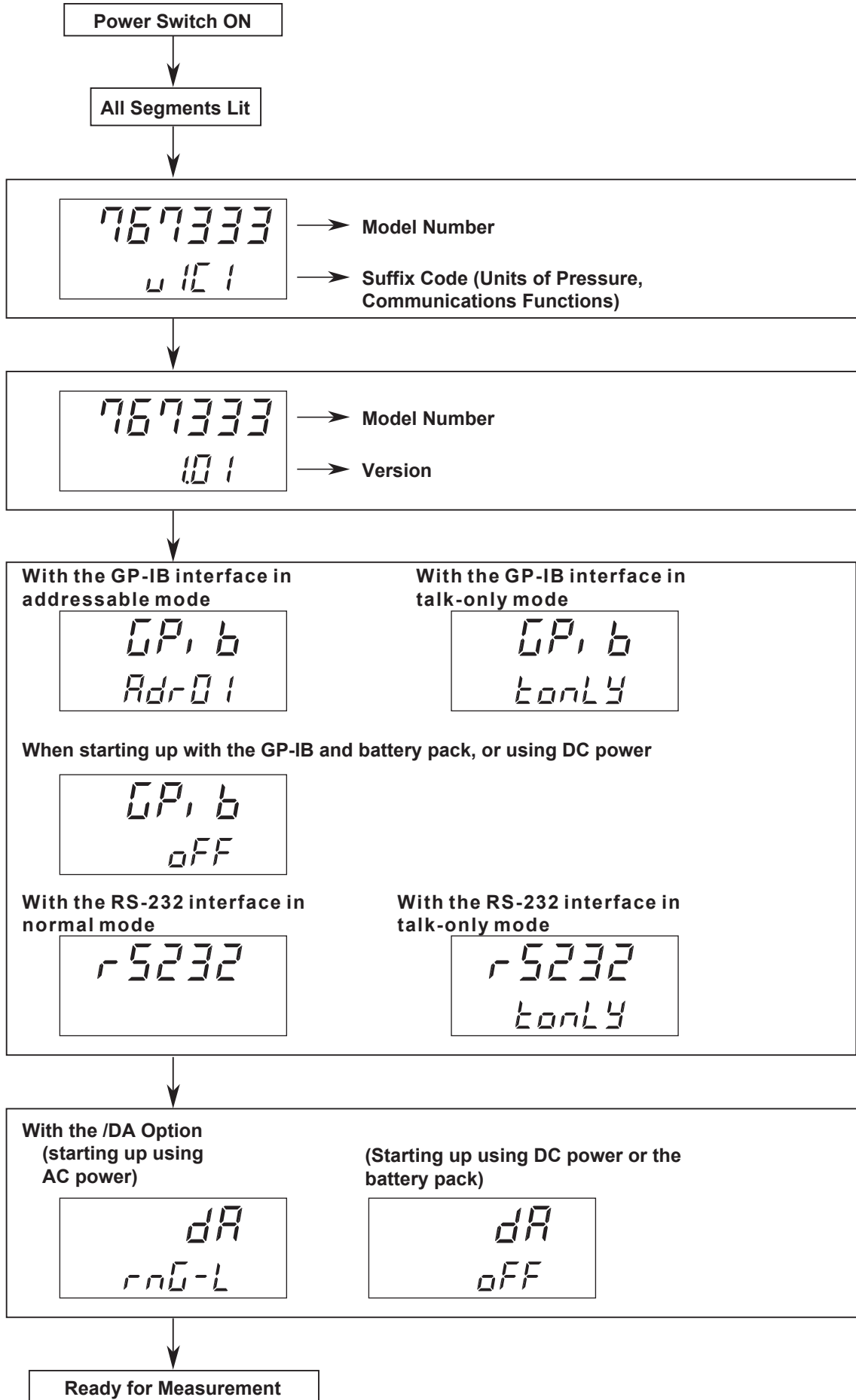

Default Settings (On Shipment from the Factory)

Item	Default (Factory Setting)	Backup ^{*1}
Functions Common to the MT210, MT210F, and MT220		
Pressure zero calibration value	0 ^{*2}	Yes
Units of pressure	kPa	Yes
Number of display digits	5-1/2 ^{*3}	Yes
Relative display	OFF	Yes
Data hold	OFF	No
Pressure averaging	ON ^{*5}	Yes
Back lighting	OFF	No
Key lock mode	OFF	Yes
Beep ON/OFF	ON	Yes
Header for output data	Included ^{*4}	Yes
Status byte interrupt setting	31 ^{*4}	Yes
MT120 Only		
Measurement mode (normal, medium-speed, high-speed)	Normal	Yes
Dynamic mode (/DA option)	OFF	Yes
MT220 only		
0% pressure value	0	Yes
100% pressure value	Measuring range	Yes
DMM function ON/OFF	ON	Yes
Measuring object for DMM	DC voltage (5 V range)	Yes
DMM averaging	ON	Yes
24 V output	OFF	No
Store mode	Manual store mode	Yes
Storing rate (auto store mode)	Each time one data item is updated	Yes
Number of data stored (auto store mode)	20	Yes
Store memory no.	1 ^{*6}	Yes
Recall memory no.	1 ^{*6}	Yes
With GP-IB		
GP-IB mode	Addressable mode ^{*4}	Yes
Address	1 ^{*4}	Yes
Delimiter	0 (CR + LF + EOI) ^{*4}	Yes
GP-IB ON/OFF (when using DC or battery power)	OFF ^{*7}	No
With RS-232		
RS-232 mode	Normal mode ^{*4}	Yes
Handshake mode	0 ^{*4}	Yes
Format	0 ^{*4}	Yes
Baud rate	9600 ^{*4}	Yes
Delimiter	0 (CR + LF) ^{*4}	Yes
/DA board		
D/A output range (2V/5V)	2V	Yes
Comparator output ON/OFF	OFF	Yes
Comparator lower limit	0	Yes
Comparator upper limit	Measuring range	Yes
D/A board ON/OFF (when using DC or battery power)	OFF ^{*7}	No

*1 Yes: Backed up No: Not backed up

*2 Not initialized in the case of absolute pressure models (767357, 767367 and 767387).

*3 4-1/2 digits in the case of the 700 kPa models (767355, 767365, 767373, and 767385).

*4 Not initialized by the "RC" command since this setting is related to the communications interface specifications.

*5 Off on the 767370. The initial pressure sample rate is 4 s.

*6 This value is not initialized since it is a critical value for the measured data memory function.

*7 This value is not initialized since it is a critical value for power supply control when operating on battery or DC power.

Initializing Settings

Settings can be reset to their defaults (i.e. reset to the factory settings) in the following two ways.

- By holding down the ENTER/LOCAL when the power switch is turned ON until the model name and version number are displayed.
- By sending the RC communications command from the controller.

Pressure Measurement

Zero Calibration

Zero calibration refers to corrections made to compensate for effects caused by changes in temperature and the installation environment, in order to perform measurement with high accuracy. Before starting measurement, make sure that zero calibration (ZERO CAL) has been performed. Furthermore, if operating conditions are likely to change, perform zero calibration again periodically.

When Using the Gauge Pressure Model

1. Open the pressure input port to the atmosphere.
2. Press the **ZERO CAL**.
3. Zero calibration is performed after the buzzer sounds for approximately one second.

When Using an Absolute Pressure Model (767357, 767367 or 767387)

To avoid operational error, zero calibration for the absolute pressure models differ from that of the gauge pressure model.

1. Connect a vacuum pump having a capacity of 1 Pa (7.5×10^{-3} torr) or higher to the input port, create a vacuum, then perform zero calibration. Make sure that the pipe between the pump and the instrument is as short as possible to increase the degree of vacuum.
2. After the reference pressure value has become stable, hold down **ZERO CAL** for five seconds.
3. Zero calibration is performed after the beep sounds for approximately one second. However, if the reference pressure value is 1 kPa higher or lower than the initial value (factory setting), zero calibration is not performed and error code 17 is displayed. Refer to 54 for error code information.

Note

- Zero calibration remains in effect even if a new unit of pressure is selected.
- Zero calibration cannot be performed until after the instrument has been warmed up.
- For measurement of liquid pressure, be sure to fill the pipes and instrument (measurement section) with the liquid before starting zero calibration.
- If it is necessary to match the pressure reference with a gauge, such as a piston pressure gauge whose pressure reference position is clear, align it with the reference point of the pressure receiving section as shown below before starting zero calibration.

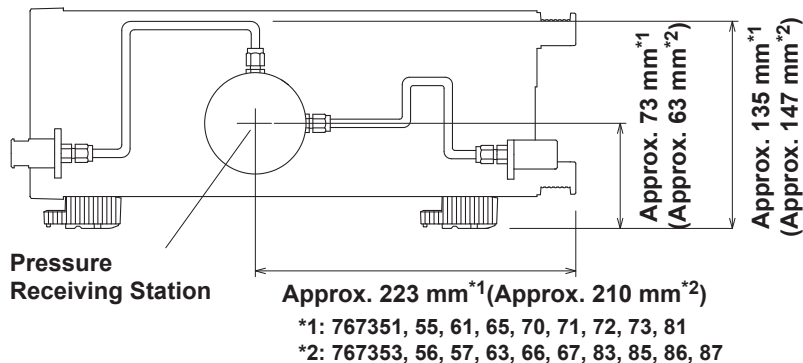

- When working with gauge pressure models, perform zero calibration whenever the operating position is changed.

- When working with absolute pressure models, zero calibration is very complex, so use the relative function to correct errors if the operating position differs from that in which zero calibration was performed.
- In the case of the absolute pressure model, zero calibration values cannot be changed by initializing setup information using the RC communications command or the **ENTER/LOCAL** after the power switch is turned ON.
- In the case of the absolute pressure model, zero calibration values are not initialized even if error code 60 (set-up information back-up error) occurs. However, they are initialized after a voltage drop in the back-up battery. In this case, error 63 will be displayed.

Input Function



CAUTION

- Never apply a pressure exceeding the permitted input pressure to the input port, otherwise damage to the instrument may result. The allowable input pressure range is shown below.

Model	Allowable Input Pressure Range	Display
767351	2.7 kPa abs to 500 kPa gauge	-12.0000 to 12.0000 kPa
767353	2.7 kPa abs to 500 kPa gauge	Up to 156.000 kPa
767355	2.7 kPa abs to 3000 kPa gauge	Up to 840.00 kPa
767356	2.7 kPa abs to 4500 kPa gauge	Up to 3600.00 kPa
767357	1 Pa abs to 500 kPa abs	Up to 156.000 kPa abs
767361	2.7 kPa abs to 500 kPa gauge	-12.0000 to 12.0000 kPa
767363	2.7 kPa abs to 500 kPa gauge	156.000 kPa or lower
767365	2.7 kPa abs to 3000 kPa gauge	840.00 kPa or lower
767366	2.7 kPa abs to 4500 kPa gauge	3600.00 kPa or lower
767367	1 Pa abs to 500 kPa abs	156.000 kPa abs or lower
767370	1 Pa abs to 50 kPa gauge ^{*1}	-1.20000 to 1.20000 kPa
767371	2.7 kPa abs to 500 kPa gauge	-12.0000 to 12.0000 kPa
767372	2.7 kPa abs to 500 kPa gauge	-156.000 to 156.000 kPa
767373	2.7 kPa abs to 1000 kPa gauge	-156.00 to 840.00 kPa
767381	2.7 kPa abs to 50 kPa gauge	-12.0000 to 12.0000 kPa
767383	2.7 kPa abs to 500 kPa gauge	156.000 kPa or lower
767385	2.7 kPa abs to 3000 kPa gauge	840.00 kPa or lower
767386	2.7 kPa abs to 4500 kPa gauge	3600.00 kPa or lower
767387	1 Pa abs to 500 kPa abs	156.000 kPa abs or lower

*1: The difference between L and H is less than or equal to 50 kPa.

- Make sure the following input pressure is not exceeded when using the 767370 or 767381. If exceeded, damage to the the sensor section may result.
 - 767370: A difference in pressure between the High and Lo sides of less than 50 kPa.
 - 767381: A difference to the atmospheric pressure of less than 50 kPa.

French



ATTENTION

- N'appliquez jamais au port d'entrée une pression dépassant la pression d'entrée autorisée, sinon cela pourrait endommager l'instrument. La plage de pression d'entrée autorisée est indiquée ci-dessous.

Modèle	Plage de pression d'entrée autorisée	Affichage
767351	2,7 kPa abs à 500 kPa jauge	-12,0000 à 12,0000 kPa
767353	2,7 kPa abs à 500 kPa jauge	Jusqu'à 156.000 kPa
767355	2,7 kPa abs à 3000 kPa jauge	Jusqu'à 840.00 kPa
767356	2,7 kPa abs à 4500 kPa jauge	Jusqu'à 3600.00 kPa
767357	1 Pa abs à 500 kPa abs	Jusqu'à 156.000 kPa abs
767361	2,7 kPa abs à 500 kPa jauge	-12.0000 à 12.0000 kPa
767363	2,7 kPa abs à 500 kPa jauge	156.000 kPa ou moins
767365	2,7 kPa abs à 3000 kPa jauge	840.00 kPa ou moins
767366	2,7 kPa abs à 4500 kPa jauge	3600.00 kPa ou moins
767367	1 Pa abs à 500 kPa abs	156.000 kPa abs or lower
767370	1 Pa abs à 50 kPa jauge ^{*1}	-1.20000 à 1.20000 kPa
767371	2,7 kPa abs à 500 kPa jauge	-12.0000 à 12.0000 kPa
767372	2,7 kPa abs à 500 kPa jauge	-156.000 à 156.000 kPa
767373	2,7 kPa abs à 1000 kPa jauge	-156.00 à 840.00 kPa
767381	2,7 kPa abs à 50 kPa jauge	-12.0000 à 12.0000 kPa
767383	2,7 kPa abs à 500 kPa jauge	156.000 kPa ou moins
767385	2,7 kPa abs à 3000 kPa jauge	840.00 kPa ou moins
767386	2,7 kPa abs à 4500 kPa jauge	3600.00 kPa ou moins
767387	1 Pa abs à 500 kPa abs	156.000 kPa abs ou moins

*1 : La différence entre B et H est inférieure ou égale à 50 kPa.

- Assurez-vous que la pression d'entrée suivante n'est pas dépassée lorsque vous utilisez le 767370 ou 767381. Si elle est dépassée, cela peut endommager la section du capteur.
 - 767370: Une différence de pression entre les côtés Haut et Bas inférieure à 50 kPa.
 - 767381: Une différence de pression atmosphérique inférieure à 50 kPa.

Connect to the input port. When making connections to models with the -P1 and -P2 suffixes, be sure to wind the seal tape tightly around the connector to prevent leakage. When using a -P3 model, attach the VCO body included with the unit. Clean any dirt that may be on the input port and o-ring before attaching it.

The connector must be tightened to the input port firmly to prevent leakage. Do not only tighten the connector, since damage to the internal pipes of the instrument may result. Instead, use two wrenches. Place one at the cut-out on the input port and the other on the connector, then tighten the connector to the input port.

There are two input ports on both the front and rear panels. However it is not possible to connect pressure inputs to both ports at the same time. Make sure that the port which is not being used is properly blocked with a plug.

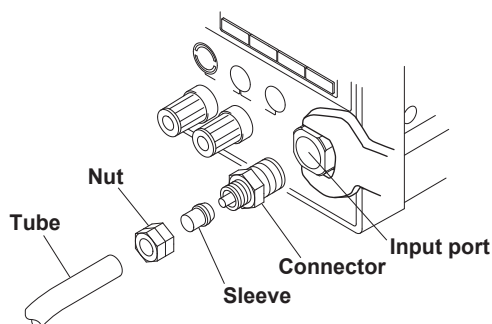

Note

- Only non-flammable, non-explosive, non-toxic, and non-corrosive gases or liquids may be measured.
- Affix the seal (included with the unit) near the input port. The seal must state the nature of the fluid to be measured.
- Connect the fluid tube properly so that no gas or liquid leakage occurs.
- Switching the fluid to be measured from gas to liquid or vice versa may cause a measurement error. It is recommended that use of the instrument be limited to either gas or liquid only. Should the fluid to be measured be changed, open the plug to discharge the fluid remaining in the tubes and instrument completely, then fill them with the fluid to be measured and perform pressure measurement.
- If cleaning of the inside of the instrument is necessary, contact your nearest YOKOGAWA representative as listed on the back cover of this manual.

When Using the 1 kPa Model (767370), or the 10 kPa Model (7673□1)

With 1 kPa and 10 kPa models, zero point hysteresis occurs when the measurement mode is switched between positive pressure and negative pressure modes.

To avoid the hysteresis, after inputting full-scale pressure, open the input port to the atmosphere, then perform zero calibration before starting measurement.

We recommend the same operation be performed to improve measurement accuracy when measurements are made in both positive or negative pressure ranges.

Selecting the Units

Select the units of pressure using the **UNIT** key.

For -U1 models Pressing the **UNIT** does not change the units.

For -U2 models Pressing the **UNIT** switches the units in the order kPa, kgf/cm², mmH₂O, mmHg, kPa.

For -U3 models Pressing the **UNIT** switches the units in the order kPa, kgf/cm², mmH₂O, mmHg, inH₂O, inHg, psi, kPa.

Note

- The factory default units setting is kPa.
- Units cannot be switched when in % display or %ERROR display modes. During normal measurement units are displayed as shown in the left column below. However, when in % display mode they appear as shown in the right column, and only the units for the current input pressure being % displayed are shown.

The same is true for the current and voltage display of the DMM function.

▶ kPa	kPa
kgf/cm ²	
mmH ₂ O	
mmHg	
%	▶ %

During normal measurement: using -U2 models % display mode

- Pressure calculation coefficient

1.0	kPa
9.806650E+1	kgf/cm ²
9.806650E-3	mmH ₂ O
1.333224E-1	mmHg
2.490889E-1	inH ₂ O
3.386388	inHg
6.894757	psi

Selecting the Number of Display Digits

Measured pressure values can be displayed with the lowest digit masked. This is useful when the lowest digit flickers and is difficult to read.

Pressing **DIGITS** causes the lowest digit to be masked, and the display to show 4-1/2 digits. Pressing **DIGITS** a second time un masks the lowest digit, and causes the display to show 5-1/2 digits.

However with 700 kPa models (767355, 767365, 767373 and 767385), measured values are displayed only in 4-1/2 digits without the mask, or 3-1/2 digits with the mask.

Note

This also applies to % display of DMM (%ERROR display) if % display or %ERROR display mode is active.

Relative Display

When the **RELATIVE** key is pressed the difference between a reference pressure and the pressure being measured is displayed.

1. Input the pressure to be used as the reference.
2. Press the **RELATIVE**.
3. **RELATIVE** is displayed as shown next page.
4. To cancel relative display, press the **RELATIVE**. **RELATIVE** disappears from the screen.

Note

While % or %ERROR display is active, relative display is inoperable even if the **RELATIVE** key is pressed.

Turning the Back Lighting ON/OFF

You can turn on a back light for the screen. The back light makes it easier to see the screen when you are working in a dark area. However, the life of the batteries will be shortened if the instrument is running on them while the back light is ON.

1. Press **LIGHT**.
2. To turn the back lighting OFF, press **LIGHT** again.

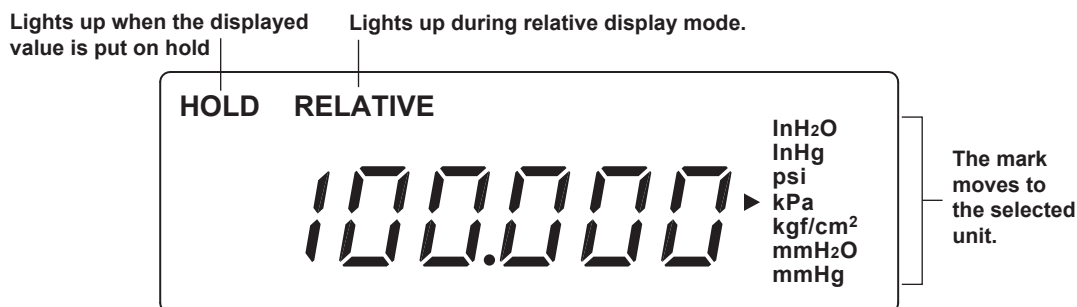

Turning the Hold Function ON/OFF

Acquisition of data stops and the displayed value is put on hold.

The following operations can be performed while data hold is ON.

- Zero calibration
- Changing the units
- Relative value display ON/OFF
- Data store/recall
- Change the number of display digits
- Setting AUTO 0% and AUTO 100%
- Displaying the measured value as a percentage
- Displaying ERROR as a percentage

1. Press the **HOLD** key. HOLD is displayed as shown upper.
2. To cancel data hold, press the **HOLD** key again. This causes HOLD to disappear from the screen.

Trigger

When data hold is ON, you can use the trigger function. Pressure is measured one time after the trigger is activated. The trigger can be activated in the following three ways.

- By pressing the **TRIG** key on the front panel
- By using a communications command (the "E" command, or the GET interface message)
- By inputting an external (falling) trigger signal (when using the D/A option)

After the trigger is activated, the LED lights to indicate that data is being sampled.

If a trigger occurs in the middle of the data sampling operation, data is sampled again from that point. To make measurements by repetitively activating the trigger, activate the trigger at an interval that is longer than the minimum input interval below. If a continuous trigger occurs before the minimum input interval, the measured value is not updated.

• Other than 767360

Measurement Mode	Pressure Averaging	Minimum Trigger Input Interval			
		MT210/MT210F	MT220		
			DMM OFF	DMM ON	
				ON	OFF
Normal	ON	1.6 s	1.6 s	2.5 s	1.6 s
	OFF	260 ms	500 ms	2.5 s	500 ms
Medium-speed	—	110 ms	—	—	—
High-speed	—	80 ms	—	—	—

• 767370

Measurement Mode	Sample Rate	Averaging	Minimum Trigger Input Interval
Normal	4000 ms	—	4.1 s
	250 ms	ON	2.6 s
		OFF	260 ms

D/A Output (/DA Option)

Converts pressure measurement results from digital to analog and outputs them. When starting the instrument using DC power or the battery pack, the D/A output function is turned OFF. Turn it ON before using the instrument.

- Output range : 2 V or 5 V
- D/A conversion time : 2 ms
- The relationship between pressure measurement values and the output voltage (for the 130-kPa range)

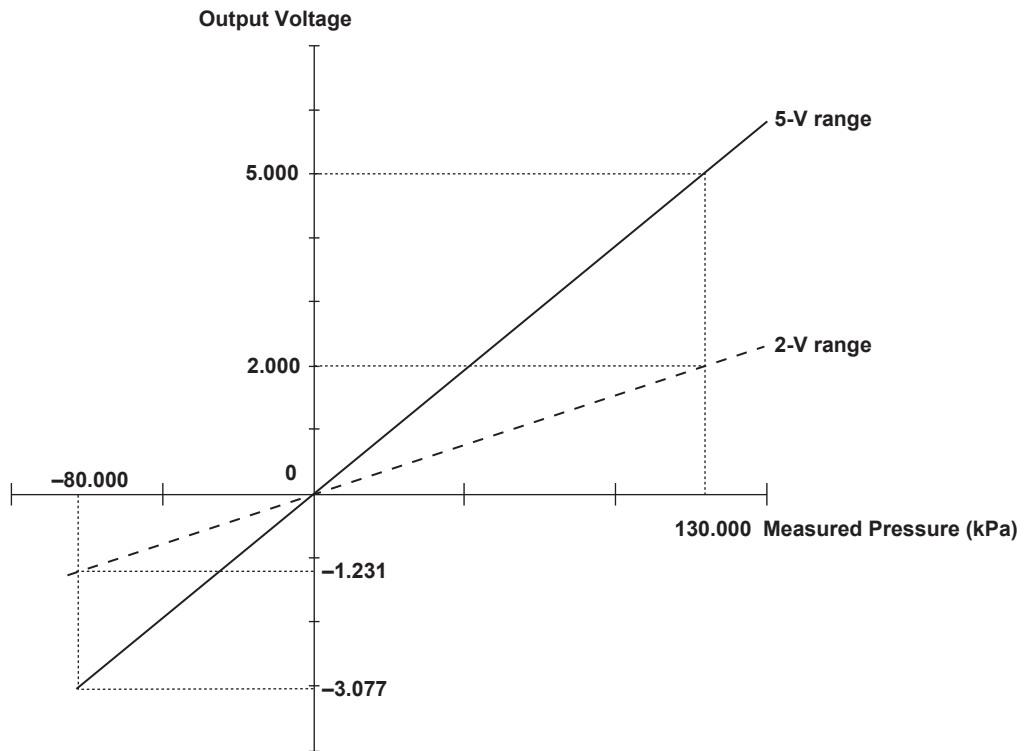

- The relationship between the display update and the output voltage.

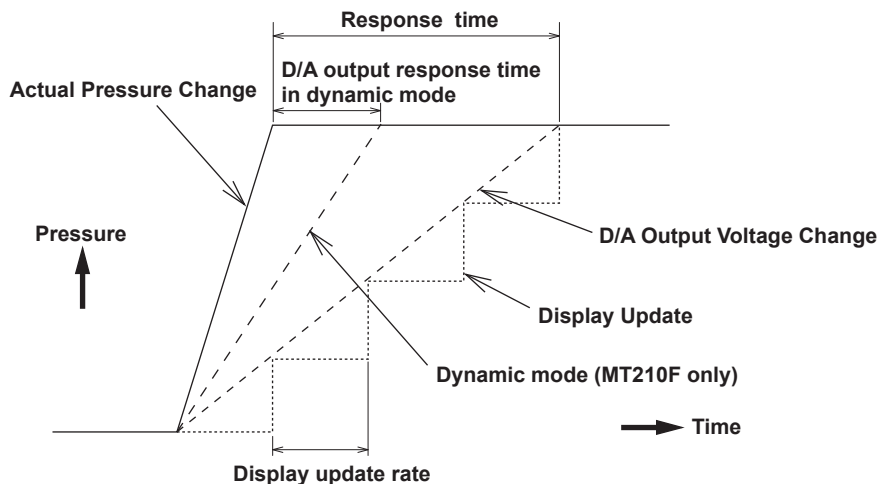

1. Press **MENU**.
2. Use the **▲** and **▼** to select dR , then press **ENTER/LOCAL**.
Proceed to step 4 when using the AC power supply. Proceed to step 3 when using the battery pack or DC power supply.
3. Use the **▲** and **▼** to set the D/A output function (P_{OUT}), then press **ENTER/LOCAL**.
 ON : Turns the function ON
 OFF : Turns the function OFF
4. Use the **▲** and **▼** to set the D/A output range (dR), then press **ENTER/LOCAL**.
 $RU-L$: Selects 2 V range
 $RU-H$: Selects 5 V range
5. On the MT210F, set dynamic mode (d_{mode}) using the **▲** and **▼**, and press **ENTER/LOCAL**.
 ON : Dynamic mode ON
 OFF : Dynamic mode OFF
6. To return to the normal measurement screen, press **MENU**.

Comparator Function (/DA Option)

Determines whether the measured pressure data is greater than or less than two reference values (Hi and Lo) and displays the results on the front panel LED. Also, the determined results are output as a TTL from the output connector on the rear panel. Determinations are made once per conversion period of the D/A output (2 ms).

Criterion	X>Hi	HiXLo	Lo>X
Determination	HI	IN	LO

X: Measured value Hi: Upper limit setting Lo: Lower limit setting

1. Press **MENU**.
2. Use the **▲** and **▼** to select $\overline{C} \overline{O} \overline{N} \overline{P}$, then press **ENTER/LOCAL**.
3. Use the **▲** and **▼** to set the comparator output function ($\overline{C} \overline{O} \overline{N} \overline{P}$) and press **ENTER/LOCAL**.
 $\overline{O} \overline{N}$: Enable
 $\overline{O} \overline{F} \overline{F}$: Disable
 If you turn the comparator function , also set the upper and lower limits.
4. Use the **▲**, **▼** and **▶** to set the lower limit pressure value ($\overline{L} \overline{O} \overline{L}$), then press **ENTER/LOCAL**.
5. Use the **▲**, **▼** and **▶** to set the upper limit pressure value ($\overline{H} \overline{I} \overline{L}$), then press **ENTER/LOCAL**.
6. To return to the normal measurement screen, press **MENU**.

Note

Set the reference value so that Hi > Lo.

Setting the Beep Sound

You can turn the beep and key clic sounds ON and OFF.

1. Press **MENU**.
2. Use the **▲** and **▼** to select , then press **ENTER/LOCAL**.
3. Use the **▲** and **▼** to set the beep and key click sounds ($\overline{B} \overline{E} \overline{E} \overline{P}$).
 $\overline{O} \overline{N}$: Activates the beep and key click sounds.
 $\overline{O} \overline{F} \overline{F}$: Deactivate the beep and key click sounds.
4. To return to the normal measurement screen, press **MENU**.

Keylock Function

Locks **ZERO CAL** or all keys excluding **MENU** and **LIGHT**.

1. Press **MENU**.
2. Use the **▲** and **▼** to set $\overline{L} \overline{O} \overline{C} \overline{K}$, and press **ENTER/LOCAL**.
3. Use the **▲** and **▼** to set the key lock type ($\overline{L} \overline{O} \overline{C} \overline{K}$).
 $\overline{O} \overline{F} \overline{F}$: Releases the lock
 $\overline{Z} \overline{L} \overline{O} \overline{C} \overline{K}$: Locks only **ZERO CAL**
 $\overline{A} \overline{L} \overline{L} \overline{O} \overline{C} \overline{K}$: Locks all keys excluding **MENU** and **LIGHT**
4. Press **ENTER/LOCAL** to confirm.

Setting the Measurement Mode

• For the MT210

1. Press **MENU**.
2. Use the **▲** and **▼** to set $\bar{n}EAS$, and press **ENTER/LOCAL**.
3. Use the **▲** and **▼** to set the pressure sample rate (rRE) and press **ENTER/LOCAL** (767370 only).
 - 250 : 250 ms
 - 4000 : 4000 ms
4. Use the **▲** and **▼** to set the pressure moving average (ABE) and press **ENTER/LOCAL**.
 - ON : Enable pressure moving average.
 - OFF : Disable pressure moving average
5. To return to the normal measurement screen, press **MENU**.

Note

If you set the pressure sample rate to 4000 ms on the 767370, the pressure moving average is fixed at OFF.

• For the MT210F

You can select from three different measurement modes, normal, medium-speed, and high-speed.

1. Press **MENU**.
2. Use the **▲** and **▼** to select $\bar{n}EAS$, then press **ENTER/LOCAL**.
3. Use the **▲** and **▼** to set the measurement mode ($\bar{r}odE$), then press **ENTER/LOCAL**.
 - Std : Normal measurement mode
 - $\bar{n}d$: Medium-speed measurement mode
 - $FASL$: High-speed measurement mode

If you specified normal mode, proceed to step 4. If you specified medium-speed or high-speed mode, proceed to step 5.

4. Use the **▲** and **▼** to set the pressure moving average (ABE) and press **ENTER/LOCAL**.
 - ON : Enable pressure moving average
 - OFF : Disable pressure moving average
5. To return to the normal measurement screen, press **MENU**.

• For the MT220

1. Press **MENU**.
2. Use the **▲** and **▼** to select $\bar{n}EAS$, then press **ENTER/LOCAL**.
3. Use the **▲** and **▼** to set the pressure moving average (ABE), then press **ENTER/LOCAL**.
 - ON : Enable pressure moving average
 - OFF : Disable pressure moving average
4. Use the **▲** and **▼** to set the DMM moving average ($dABE$), then press **ENTER/LOCAL**.
 - ON : Enable DMM moving average
 - OFF : Disable DMM moving average
5. To return to the normal measurement screen, press **MENU**.

Output Connector (/DA Option)

- Pin assignment

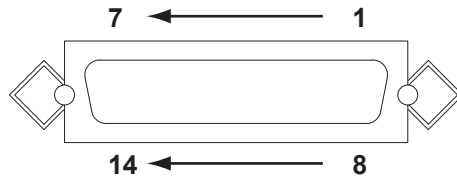

- Input/output circuit

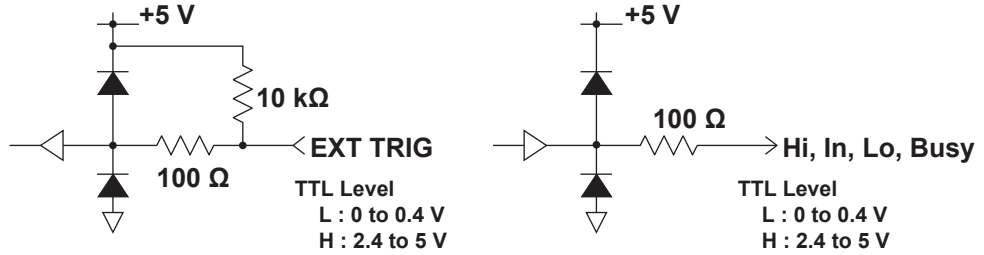

- Signal allocation

Pin Number	Signal Name*	Input/Output	Specification
1	EXT TRG	Input	Trigger (rising edge, pulse width 2 ms or more)
2	BUSY	Output	Output upon change in comparator signal (active "H")
3	NC		
4	HI	Output	Comparator output (active "H")
5	IN	Output	Comparator output (active "H")
6	LO	Output	Comparator output (active "H")
7	GND		
8	D/A OUT(+)	Output	D/A output (2 V or 5 V)
9	D/A GND		D/A ground (connected to ground internally)
10-13	NC		
14	GND		Ground

* The signal level is TTL.

* NC stands for No Connection.

Adjusting and Calibrating the Differential Pressure Transmitter using the MT220

Connecting the Differential Pressure Transmitter to the MT220

To measure output from the differential pressure transmitter in terms of current, connect the transmitter to the instrument and calibrate the transmitter.

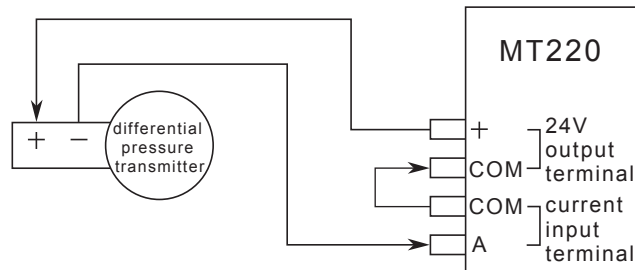

WARNING

Including the internal electric potential, the maximum allowable potential difference for all input/output and ground terminals is 42 V_{peak}. Ensure that the potential of each terminal does not exceed the following values. If this value is exceeded, damage to the instrument and injury to personnel may result.

DMM measurement terminal: 18 V_{peak} relative to ground.



CAUTION

- Do not apply an external voltage to the 24 VDC output connector. Doing so may damage the instrument.
- If the 24 VDC output terminals are short-circuited or the load current exceeds the limit (approx. 40 mA), -OL- is displayed and the output is turned OFF.
- If the instrument is operated continuously from the Ni-Cd batteries with the load current for the 24 VDC output exceeding 20 mA, the life of the batteries will be shortened rapidly.
- Never apply a voltage exceeding the permitted maximum to the voltage input terminals. Doing so may damage the instrument.
Maximum permitted input voltage: 30 VDC
- Never apply a current exceeding the maximum permitted input current to the current input terminals. Make sure that the fuse used meets the specified rating. Only use a fuse of the specified rating. For details, refer to page 58.
Maximum permitted input current: 100 mADC

French

AVERTISSEMENT

Y compris le potentiel électrique interne, la différence de potentiel maximum autorisée pour tous les bornes d'entrée/sortie et de terre est de 42 V crête. Assurez-vous que le potentiel de chaque borne ne dépasse pas les valeurs suivantes.

Si cette valeur est dépassée, cela peut endommager l'instrument ou des blessures corporelles.

Terminal de mesure DMM : 18 V crête relatifs à la terre.



ATTENTION

- N'appliquez pas une tension externe au connecteur de sortie de 24 VDC. Ceci pourrait endommager l'instrument.
 - Si les bornes de sortie de 24 VDC sont mis en court-circuit ou si le courant de charge dépasse la limite (environ 40 mA), -OL- s'affiche et la sortie est mise hors tension.
 - Si l'instrument fonctionne en continu sur les batteries Ni-Cd avec un courant de charge pour la sortie de 24 VDC dépassant 20 mA, la durée de vie des batteries diminuera rapidement.
 - N'appliquez jamais aux bornes d'entrée de la tension une tension dépassant le maximum autorisé. Ceci pourrait endommager l'instrument. Tension d'entrée maximum autorisée : 30 VDC
 - N'appliquez jamais aux bornes d'entrée de courant un courant dépassant le courant d'entrée maximum autorisé. Assurez-vous que le fusible respecte la cote spécifiée. Utilisez uniquement un fusible de la cote spécifiée. Pour plus de détails, consultez la page 58. Courant d'entrée maximum autorisé : 100 mADC
-

24 VDC Ouput

1. Press **24 V DC ON/OFF**.
2. 24 V will be displayed in the bottom right corner of the screen.
3. To stop 24 VDC output, press **24 V DC ON/OFF** again. This causes 24 V to disappear from the screen.

Note

If the 24 VDC output becomes overloaded, -OL- will be displayed in the bottom right corner of the screen, and the 24VDC output will be turned OFF automatically.

Press **24V DC ON/OFF** to remove -OL- from the bottom right of the screen and go around the cause of the overload, then restart 24 VDC output.

DMM Function

1. If nothing is displayed in the lower part of the screen, press the **ON/OFF** under the DMM group to turn the DMM function ON.
2. Press **DC5 V/20 mA** to set the mark to either V or mA.
3. To cancel DMM measurement, press the **ON/OFF** under the DMM group again to turn the DMM function OFF.

Note

The display range for the measured values are shown below.

Voltage -6.0000 V to $+6.0000$ V

Current -24.000 mA to $+24.000$ mA

% Display

If 0% and 100% pressure values have been set, the measured values can be displayed as a percentage (%) relative to these 0% and 100% values. 0% and 100% values can be set by directly entering a desired numerical value or by applying actual pressure.

If % display mode is active during measurement of current or voltage using the DMM function, the measured value is displayed as a percentage: 1 to 5 V or 4 to 20 mA being equivalent to 0 to 100%. The display range for pressure and voltage/current values is shown below.

Pressure: 999.99%. $---$ is displayed in the upper part of the screen if the value exceeds the specified number of display digits.

Current/voltage: 0 to 24 mA/0 to 6 V (-25 to 125%). $---$ is displayed at the lower part of the screen if the input exceeds this range.

Example

When 20 kPa is set as 0% and 100 kPa as 100%:

If the input pressure is 40 kPa, 25% will be displayed in the upper part of the screen. 25% (8 mA) will also be displayed in the lower part of the screen if the output current from the differential pressure transmitter is correct..

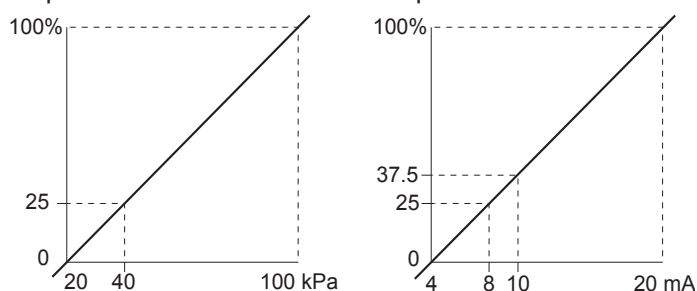

Setting 0% and 100% by Entering the Desired Numerical Value (Manual Setting)

1. Press **MENU**.
Use the **▲** and **▼** to select $\frac{5}{P}$, then press **ENTER/LOCAL** to activate the 0% pressure setting screen.
2. Use the **▲**, **▼** and **➤** to enter the value corresponding to 0%, then press **ENTER/LOCAL**.
3. To set the value corresponding to 100% value, use the **▲**, **▼** and **➤** then press **ENTER/LOCAL**.
4. Press **MENU** to return to the normal measurement screen.
5. Press the **%ERROR** to activate % display mode.

Setting 0% and 100% by Applying Actual Pressure (Automatic Setting)

1. Apply pressure which corresponds to 0%.
2. Press the **Auto %**.
3. Apply pressure which corresponds to 100%.
4. Press the **Auto 100%**.
5. Press the **%ERROR** key to activate % display mode.

Note

- Any 0% and 100% pressure values can be set as long as they are within the display range and satisfy the condition 0% value < 100% value.
- If the applied pressure is outside the display range, it can be set as the 0% or 100% value even if the **AUTO 0%** or **AUTO 100%** has been pressed.
- If the 0% value is greater than the 100% value, **SPERR** will be displayed when the **%ERROR** is pressed. In this case, enter the correct 0% and 100% values.
- Automatic setting (using the **AUTO 0%** and **AUTO 100%**) is possible only when the instrument is in normal measurement display mode.
- If the instrument is in relative display mode, % display will not be activated even if the **%ERROR** is pressed.

Error Display

The output voltage (or current) can be checked against the pressure input to the differential pressure transmitter. The %ERROR value represents the value obtained by subtracting the input pressure value displayed as a percentage from the current/voltage value displayed as a percentage.

The pressure values are shown under % display, and the DMM values are shown under %ERROR display.

Example

When 20 kPa is set as 0% and 100 kPa as 100%:

When the applied pressure is 40 kPa, 0% (25 - 25) will be displayed as the %ERROR if the current is 8 mA, and 12.5% (37.5 - 25) will be displayed as %ERROR if the current is 10 mA.

1. Make the necessary settings for % display (Refer to the diagram of the previous page).
2. Press the **%ERROR** to activate %ERROR display mode.

Note

- If the %ERROR key is pressed to activate % display mode, the value measured by the DMM function is also displayed as a percentage. However, this does not apply if the DMM function is OFF.
- The display switches as follows each time the %ERROR key is pressed.
 DMM function ON: normal measurement display→% display→%ERROR display→normal measurement display
 DMM function OFF: normal measurement display→% display→normal measurement display

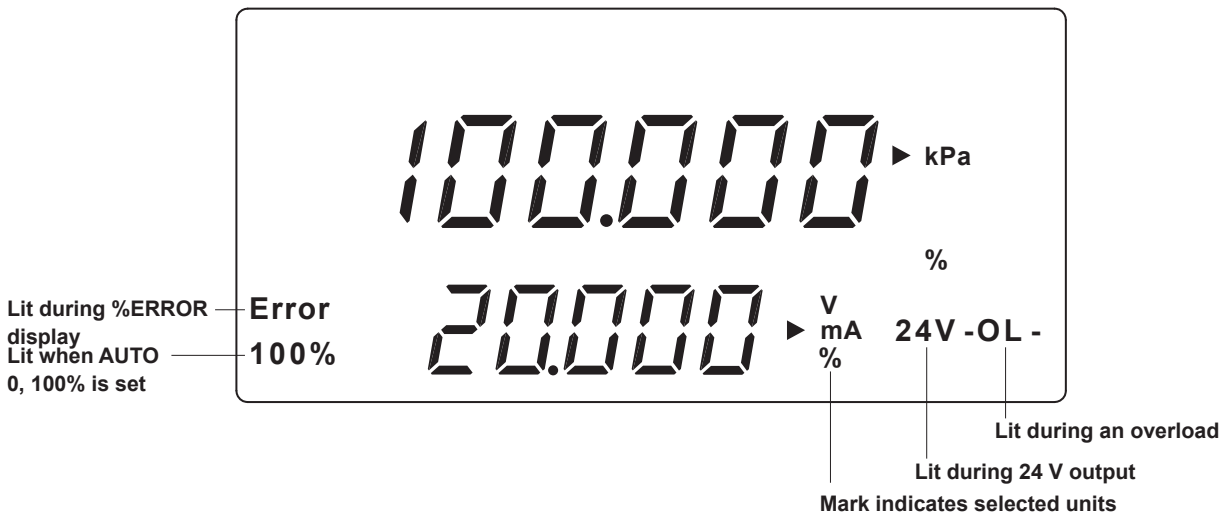

Storing and Recalling Data (MT220 Only)

Storing Data

Acquired data is assigned a specific memory number and then stored in the internal memory.

1 to 9999 can be set as the data number (memory number). If no destination memory number is specified, data will be stored under consecutive memory numbers (default starting number is 1). When a memory number is specified, data is saved successively starting with that number.

Two types of storage methods are available, auto store and manual store.

Data acquisition interval

(number of samples taken per stored data item): 1, 4, 16, 64, 512

No. of storage times: 1 to 2000

Destination memory No.: 1 to 9999

No. of data which can be stored: 2000

Auto Store

Data is stored automatically the specified number of times and at the specified interval. If no destination memory number is specified, storage starts from the memory number after the one in which last data item was stored.

Making Auto Store Settings

1. Press **MENU**.
2. Keep pressing **▲** or **▼** until StorE is displayed in the screen, then press **ENTER/LOCAL** to proceed to the store mode setting screen.
3. Press **▲** or **▼** to display Auto , then press **ENTER/LOCAL** to select the mode.
4. In the store rate setting screen (Rate), use **▲** and **▼** to select the desired acquisition interval, then press **ENTER/LOCAL**.
5. In the screen to set the number of data (Count), use **▲**, **▼** and **▶** to set the number of data to be stored, then press **ENTER/LOCAL**.
6. To return to the normal measurement screen, press **MENU**.

Setting the Memory Number at Which Storage Is to Be Started

7. Press **No.** to display the memory number setting screen (No.).
8. Use **▼** and **▶** to set the desired memory number, then press **ENTER/LOCAL**.

Storing Data

9. Pressing **STORE** automatically stores data items one by one. The current memory number to which data is being stored is displayed for approximately 0.5 seconds in the upper part of the screen.

Data automatically ceases to be stored when the stored number of data reaches the specified maximum number. Then StorE is displayed in the upper part of the screen and Stop in the lower part of the screen for approximately 0.5 seconds.

Stopping Auto Store

10. Press **STORE** again. Auto store stops. StorE is displayed in the upper part of the screen and Abort in the lower part of the screen for approximately 0.5 seconds.

Note

The store mode, store rate, and allowed number of stores cannot be changed during auto store.

Manual Store

Pressing the STORE key stores data. If no destination memory number is specified, the data is stored under the memory number immediately following the one in which the last data item was stored.

Making Manual Store Settings

1. Press **MENU**.
2. Keep pressing **▲** or **▼** until \overline{STORE} is displayed in the screen, then press **ENTER/LOCAL** to proceed to the store mode setting screen.
3. Press **▲** or **▼** to display \overline{USER} , then press **ENTER/LOCAL** to select the mode.
4. To return to the normal measurement screen, press **MENU**.
5. Press No. to display the memory number setting screen (\overline{NO}).
6. Use **▲**, **▼** and **▶** to set the desired memory number, then press **ENTER/LOCAL**.

Storing Data

7. Pressing **STORE** stores data and displays \overline{STORE} in the upper part of the screen, while the memory number to which the data is being stored is displayed in the lower part of the screen for approximately 0.5 seconds.

Note

- It is not possible to overwrite data. If a destination memory in which data already exists is selected, error code $\overline{38}$ will be displayed, indicating that overwriting is not possible. In auto store, error code $\overline{38}$ is displayed and auto store stops automatically when a memory number in which data already exists is reached. If you want to store data in a memory in which data already exists, delete the existing data first, then store the new data.
 - All data stored in the internal memory will be backed up even if the power is turned OFF.
-

Data Recall

Data stored in the internal memory can be recalled. Specify the number of the data items you want to recall.

The set-up information which was in effect when the last store was performed will be restored when a recall is performed.

- Relative value display ON/OFF
- DMM function ON/OFF, selected measurement item (current or voltage)
- Pressure values specified as 0% and 100% in the case of % display

When recall mode is cleared, the settings which were effective before the recall will be restored.

Recall Mode

RECALL is displayed during recall mode.

1. Press **RECALL**.
RECALL lights up on the screen, indicating that recall mode is now active and the latest stored data is recalled.

Recalling Data Sequentially

2. When you press **▲** or **▼** while in recall mode, the number of the data to be recalled is incremented or decremented, and the corresponding data will be recalled.
3. To cancel recall mode, press **RECALL** again. RECALL disappears from the screen.

Recalling Data by Specifying the Corresponding Memory Number

2. Press **No.** while recall mode is active.
3. Use **▲**, **▼**, or **▶** to select the desired memory number.
4. Press **ENTER/LOCAL** to recall the data.
5. To cancel recall mode, press **RECALL** again. **RECALL** disappears from the screen.

Note

- If recall is performed from a memory number in which no data has been stored, error code $\overline{32}$ will be displayed, and the - - - - - screen will appear.
- If the desired data is relative display data, it cannot be recalled if % display or %ERROR display is active. In this case, display is switched automatically to the normal display screen.

Deleting Data

Data stored in the internal memory can be deleted. Two methods are available; one is used to delete the desired data by specifying the corresponding memory number and the other is used to delete all data at once.

1. Press the **DELETE**.
2. Press **▲** or **▼** to select $\overline{bL\ 0\ 0\ 0}$ (partial delete) or (delete all data), \overline{ALL} then press **ENTER/LOCAL**.
3. If $\overline{bL\ 0\ 0\ 0}$ is selected, specify the delete start and stop memory numbers. If \overline{ALL} is selected, skip to step 4.
Delete start memory Number setting screen: $\overline{F\ 0\ r\ n}$
Delete stop memory Number setting screen: $\overline{t\ 0}$
Use **▲**, **▼**, and **▶** to set both the start and stop memory numbers, then press **ENTER/LOCAL**.
4. In the delete execution setting screen, select \overline{YES} if you want to delete the data or \overline{NO} if you do not, then press **ENTER/LOCAL**. Press **DELETE** to return to the normal measurement screen.

Displaying the Number of Data Items Which Can Be Stored

The possible number of data to be stored can be displayed.

1. Press **MENU**.
2. Keep pressing **▲** or **▼** until $\overline{F\ r\ E\ E}$ is displayed, then press **ENTER/LOCAL**.
3. The number of data items which can be stored is displayed for approximately one second.
4. To return to the normal measurement screen, press **MENU**.

Battery Pack (Optional)

Connecting the Battery Pack to the Main Unit



WARNING

- Before attaching the battery pack to the instrument, be sure to turn OFF the POWER switch (on the front panel) then the MAIN POWER switch (on the rear panel), and remove the power cord from the AC outlet.
- When connecting the battery pack to the instrument, use only the screws provided with the battery pack (part number: Y9540LB). Using other screws is dangerous, because the battery pack may not be properly connected or the screws may damage the internal circuitry.

French



AVERTISSEMENT

- Avant d'attacher le pack de batteries à l'instrument, assurez-vous de mettre hors tension l'interrupteur POWER (à l'avant du panneau) puis l'interrupteur MAIN POWER (à l'arrière du panneau), et de retirer le cordon d'alimentation de la prise secteur.
- Lors du branchement du pack de batteries à l'instrument, utilisez uniquement les vis fournies avec le pack de batteries (numéro de pièce : Y9540LB). L'utilisation d'autres vis est dangereuse, car le pack de batteries pourrait ne pas être branché correctement ou les vis pourraient endommager les circuits internes.

Remove the blank cover from the top of the instrument, plug the connector on the battery pack into the connector on the instrument, then tighten the battery pack with the four screws (M5 × 40 mm) using a screwdriver.

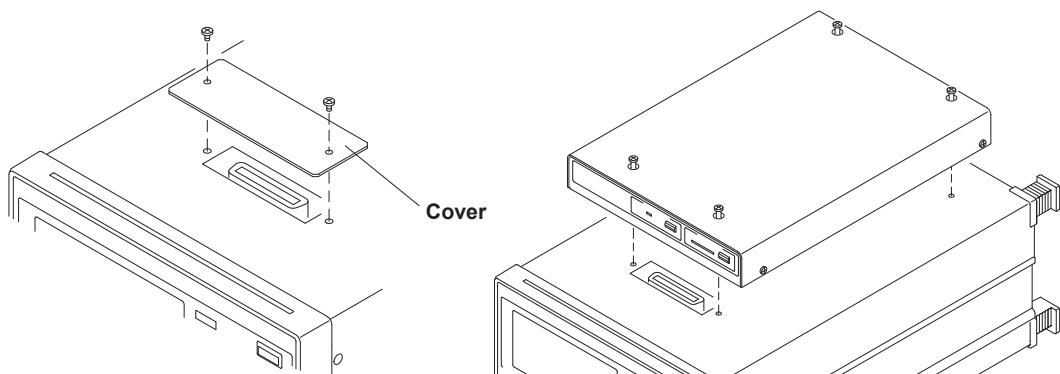

Note

Affix the seal supplied with the battery pack to the top of the pack.

Charging the Ni-Cd Batteries

1. Turn the MAIN POWER switch ON.
2. Press the **CHARGE START** to start charging. The green LED on the battery pack will blink during charging.
3. Charging continues for approximately 12 hours. Charging automatically stops after approximately 12 hours. This is called a complete charge. The LED stops blinking and remains lit. The LED stays lit until the LINE switch is turned OFF.



Note

- Before charging a battery pack, make sure that each Ni-Cd battery contained in the pack has been discharged completely. If charging is started on a battery which has not been discharged completely or on a battery for which charging has been stopped half way through, the life of the battery pack will be reduced.
- When you are going to use a new battery pack, be sure to charge it completely.
- Use only the AC power supply to charge the battery pack.

Checking the Remaining Life of the Battery Pack

When the instrument is operated from the battery pack, it is possible to check the life remaining in the battery pack.

Hold down the **BATTERY CHECK**. The red LED lights up and the remaining life of the battery pack is indicated as follows.

Two LEDs are lit. Approximately 6 to 10 hours (MT210 + battery pack)

One LED is lit. Approximately 3 to 6 hours (MT210 + battery pack)

No LEDs are lit. Within 3 hours. Use up the batteries (discharge them completely).



Note

- The battery pack contains three Ni-Cd batteries. Charge remaining means the total remaining life of the three batteries and is described as follows. When both red LEDs go out, a  icon is displayed in the upper part of the screen.

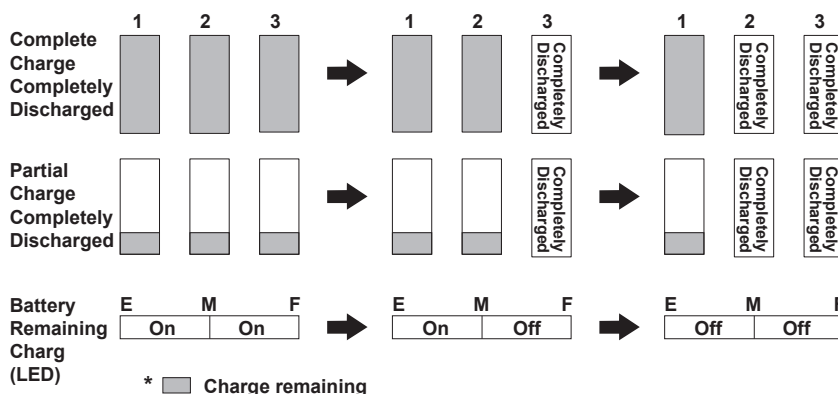

- When  is blinking on the screen, blinking continues even if the power is switched to DC power.



CAUTION

- When charging, make sure that the instrument is in the horizontal or vertical position, or that it is leaning on its stand. To prevent overheating, do not lean the instrument on its side. Also, allow the unit to dissipate heat by keeping the area around it clear of any objects.
- If the MAIN POWER switch is turned ON with the battery pack connected to the instrument, the batteries will be trickle-charged. In trickle-charging, the batteries are charged until natural discharge is compensated for. If you are not going to use the instrument for a long period of time, make sure that both the POWER and MAIN POWER switches are turned OFF.
- Never overcharge the batteries, otherwise the life of the batteries will become shorter. Since gas or an electrolytic solution may begin to leak from the batteries if they are charged for an excessively long time, be sure to turn the MAIN POWER switch OFF if you are not going to use the instrument after charging.

French



ATTENTION

- Lors de la charge, assurez-vous que l'instrument est en position horizontale ou verticale, ou qu'il est appuyé sur son support. Afin d'éviter toute surchauffe, ne couchez pas l'instrument sur le côté. En outre, conservez la zone entourant l'unité libre de tout objet pour permettre l'évacuation de la chaleur.
- Si l'interrupteur MAIN POWER est sous tension lorsque le pack de batteries est connecté à l'instrument, les batteries seront chargées lentement. En charge lente, les batteries sont chargées jusqu'à ce que la décharge naturelle soit compensée. Si vous avez l'intention de ne pas utiliser l'instrument pendant une longue période, assurez-vous que les interrupteurs POWER et MAIN POWER sont hors tension.
- Ne surchargez jamais les batteries, sinon la durée de vie des batteries sera moindre. Comme du gaz ou une solution électrolytique peuvent commencer à s'échapper des batteries si elles sont chargées pendant une période excessivement longue, assurez-vous de mettre l'interrupteur MAIN POWER hors tension si vous n'allez pas utiliser l'instrument après la charge.

Life of the Ni-Cd Battery

The Ni-Cd batteries inside the battery pack last approximately 10 hours when they are used continuously. However, the life of the batteries vary depending on the operating conditions.

If it is used continuously with a load current at a 24-VDC output exceeding 20 mA, the life of the battery will be drastically reduced. Refer to the table below.

DMM	24 VDC Output	Back Lighting	Life (when used continuously)
ON	ON	ON	Approximately 6 hours
ON	OFF	OFF	Approximately 9 hours
OFF	OFF	ON	Approximately 11 hours
OFF	ON	OFF	Approximately 12 hours
OFF	OFF	OFF	Approximately 14 hours

Replacing the Ni-Cd Batteries

The life of the Ni-Cd batteries is reduced if they are used repeatedly, even if they are charged completely. The battery replacement interval differs depending on operating conditions, but you should replace them approximately every two years.

Battery replacement must be performed as described on the next page.



WARNING

- Before replacing the batteries, be sure to turn OFF the POWER switch (front panel) then the MAIN POWER switch (rear panel), and remove the power cord from the AC outlet, since there is the possibility of an accident or short-circuit in the charging circuit.
- Use only Ni-Cd batteries manufactured by YOKOGAWA (Model 269914).

French



AVERTISSEMENT

- Avant de remplacer le fusible, assurez-vous de mettre hors tension les interrupteurs POWER et MAIN POWER, de retirer les branchements de chaque borne d'entrée et de sortie, et de retirer le cordon d'alimentation de la prise secteur.
- Utilisez uniquement des batteries Ni-Cd fabriquées par YOKOGAWA (Modèle 269914).

Battery Pack (Optional)

1. Turn OFF the POWER switch, then the MAIN POWER switch.
2. Remove the power cord from the AC outlet.
3. Unfasten the four screws (M3 × 5 mm) indicated in the diagram below and remove the cover.
4. Unplug the connector (see figure next page). Do not pull on the connector cable. All three Ni-Cd batteries must be replaced together.
5. Plug in the connector all the way, replace the blank connector cover, then tighten the four screws. When replacing the blank connector cover, take care not to trap the connector cable.

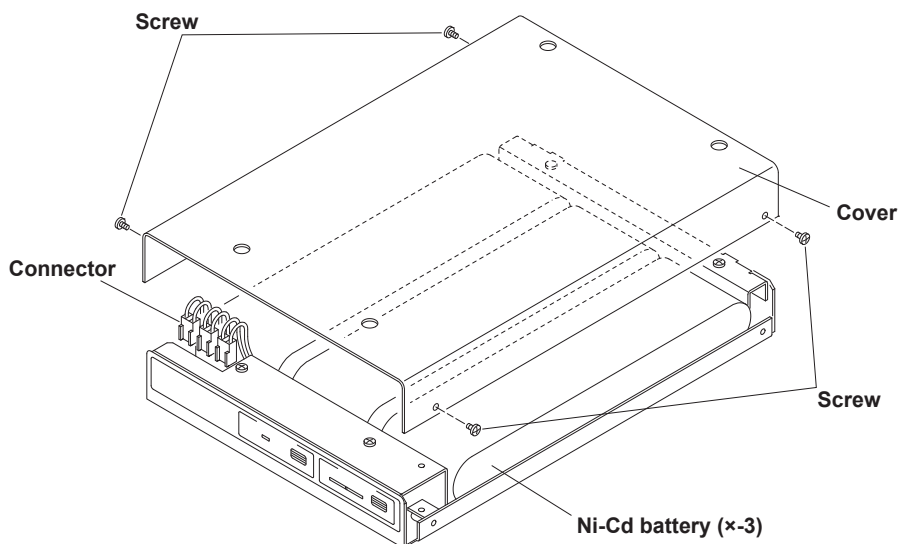

Note

- When disposing of the Ni-Cd batteries, follow the laws and ordinances of your country or region.
 - Do not mix old and new batteries.
-

Overview of the GP-IB Interface

GP-IB Interface Function

Listener

It is possible to enter the same settings via the GP-IB interface that can be made using the front panel keys.

Measured or computed data, panel setup information, and error codes can be received.

Talker

Measured or computed data can be output.

Panel setup information and the status byte can be output.

Error codes which have occurred can be output.

GP-IB Interface Specifications

Electrical and mechanical specifications : Conforms to IEEE St'd 488-1978.

Functional Specifications : See the table below.

Code : ISO (ASCII) code

Address setting : Listener and talker addresses 0 to 30, or talk-only can be selected.

Remote mode clear : Remote mode can be cleared by pressing the **ENTER/LOCAL** on the front panel. However, this is not possible if Local Lockout has been set by the controller.

Functional Specifications

Function	Subset Name	Description
Source handshaking	SH1	Full source handshaking capability
Acceptor handshaking	AH1	Full acceptor handshaking capability
Talker	T5	Basic talker capability, serial polling, untalk on MLA (My Listen Address), talk-only capability
Listener	L4	Basic listener capability, unlisten on MTA (My Talk Address), no listen-only capability
Service request	SR1	Full service request capability
Remote local	RL1	Full remote/local capability
Parallel poll	PP0	No parallel polling capability
Device clear	DC1	Full device clear capability
Device trigger	DT1	Full device trigger capability
Controller	C0	No controller function

Turning GP-IB ON/OFF

When starting up using DC power or the battery back, GP-IB is turned OFF.

Turn it ON before use.

Interface Messages Supported by the Instrument

- IFC (Interface Clear)
Cancels (unaddresses) talker and listener.
- REN (Remote Enable)
Transfers the instrument from local control to remote control.
- GTL (Go To Local)
Transfers the instrument from remote control to local control.
- SDC (Selective Device Clear), DCL (Device Clear)
Clears the GP-IB input/output buffer and resets after an error. The setup information and measurement state are not affected.
DCL applies to all devices on the bus, while DSC applies only to designated devices.
- GET (Group Execute Trigger)
Updates the displayed data during sample hold.
- LLO (Local Lockout)
Invalidates the **ENTER/LOCAL** on the front panel, preventing an inadvertent switch from remote control to local control.

Switching between Remote and Local Mode

REMOTE is displayed on the screen when the instrument is in remote mode.

No front panel keys except the **ENTER/LOCAL** can be operated.

To cancel remote mode, press the **ENTER/LOCAL**. REMOTE will disappear from the screen, indicating that the instrument is now in local mode. However, this is not possible if Local Lockout has been set.

Setting the Mode and Address

The following operation modes are available for the GP-IB interface provided with the instrument.

Setting the Mode

Addressable Mode

In this mode, the instrument is controlled by commands issued from the controller. When the OD command (measured or computed data output request command) is received, the instrument outputs the measured or computed data.

Talk-Only Mode

This mode does not require a controller.

Measured or computed data is output at the display update intervals. This mode is useful when the instrument is connected to a listener-only device such as a printer.

Setting the Address

A particular address is assigned to each device connected to the GP-IB interface so that every device can be recognized by every other device. Therefore, an address must be assigned to this instrument when it is connected to a personal computer.

If this instrument is to be used with a listen-only device, it must be set to talk-only mode.

Address Setting Range

0–30

The factory setting is 1.

Talk-Only Function

This function only allows the instrument to send measured or computed data to other devices. Even if the instrument is not assigned as a talk-only device, it can still send data. In talk-only mode, the instrument cannot be controlled by the controller.

Setting the GP-IB Interface

1. Press **MENU**.
Keep pressing **▲** or **▼** until \overline{GP} , \overline{b} is displayed in the lower part of the screen, then press **ENTER/LOCAL**.
Proceed to step 2 when using the battery pack or DC power supply.
Proceed to step 3 when using the AC power supply.
2. Use the **▲** and **▼** to set the GP-IB function ($\overline{P_{OFF}}$) and press **ENTER/LOCAL**.
 \overline{ON} : Activates the function.
 \overline{OFF} : Deactivates the function.
3. Press **▲** or **▼** to select \overline{Addr} (addressable mode) or \overline{Talk} (talk-only mode), then confirm the selection by pressing **ENTER/LOCAL**.
4. If addressable mode is selected, keep pressing **➤** until the desired digit starts to blink, then set the desired value by pressing **▲** or **▼** to set the address (\overline{Addr}), then press **ENTER/LOCAL**.
5. Press **MENU** to return to the normal measurement screen.

Overview of the RS-232 Interface

RS-232 Interface Functions

Receiving Function

It is possible to enter the same settings via the RS-232 interface as can be entered using the front panel keys.

Measured or computed data, panel setup information, and error codes can be received.

Sending Function

Measured or computed data can be output.

Panel setup information and the status byte can be output.

Error codes which have occurred can be output.

RS-232 Interface Specifications

- Electrical characteristics : Complies with the EIA232(RS-232) standard
- Connection : Point-to-point
- Communications : Full-duplex
- Synchronization : Start-stop system
- Baud Rate : 1200, 2400, 4800, 9600
- Start bit : 1 bit
- Data length (word length): 7 or 8 bits
- Parity : EVEN, ODD, or OFF (no parity)
- Stop bit : 1 or 2 bits
- Hardware handshaking : User can select whether CA and CB signals will always be True, or will be used for control.
- Software handshaking : User can select whether to control only transmission or both transmission and reception using X-on and X-off signals.
X-on (ASCII 11H)
X-off (ASCII 13H)
- Receive buffer size : 256 bytes

Connecting the RS-232 Interface Cable

When connecting this instrument to a computer, make sure that the handshaking method, data transmission rate, and data format selected for the instrument match those selected for the computer.

For details, refer to the following pages. Also make sure that the correct interface cable is used.

Connector and Signal Names

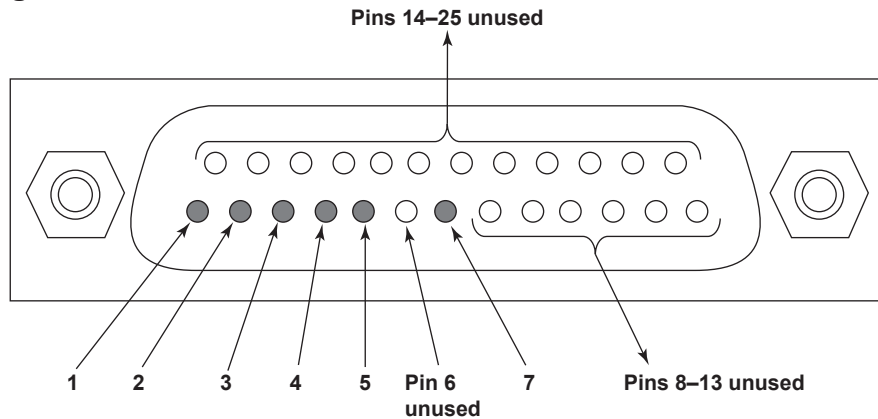

RS-232 connector: DBSP-JB25S equivalent

The figure above shows the pin numbers on the RS-232 connector.

- 1 AA (GND: Protective Ground) : Grounded to the case of this instrument.
- 2 BA (TXD: Transmitted Data) : Data transmitted to a personal computer.
Signal direction Output
- 3 BB (RXD: Received Data) : Data received from personal computer.
Signal direction Input
- 4 CA (RTS: Request to Send) : Signal used for handshaking when receiving data from a personal computer.
Signal direction Output
- 5 CB (CTS: Clear to Send) : Signal used for handshaking when transmitting data to a personal computer.
Signal direction Input
- 7 AB (GND: Signal Ground) : Ground for signals

Note

Pins 6, and 8 through 25 are unused.

Signal Direction

The figure below shows the direction of the signals used by the RS-232C interface.

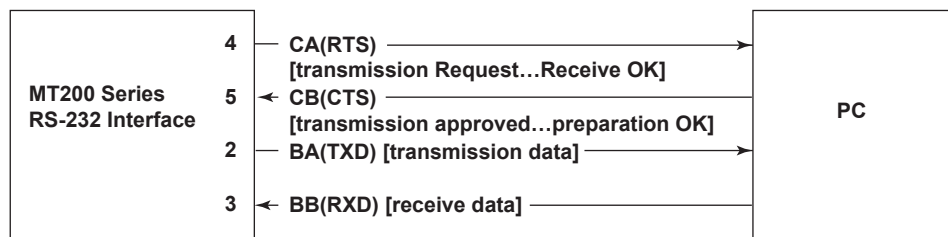

Table of RS-232 Standard Signals and Their JIS and CCITT Abbreviations

Table of Signals

Pin Number (25-pin connector)	Abbreviation		Name
	RS-232	CCITT JIS	
1*	AA (GND)	101 FG	Protective ground
7*	AB (GND)	102 SG	Signal ground
2*	BA (TXD)	103 SD	Transmitted data
3*	BB(RXD)	104 RD	Received data
4*	CA(RTS)	105 RS	Request to send
5*	CB(CTS)	106 CS	Clear to send
6	CC(CSR)	107 DR	Data set ready
20	CD(DTR)	108/2 ER	Data terminal ready
22	CE(RI)	125 CI	Ring indicator
8	CF(DCD)	109 CD	Data channel received carrier detect
21	CG(-)	110 SRS	Data signal quality detect
23	CH/CI(-)	111 SRS	Data signal rate select
24/15	DA/DB(TXC)	113/114 ST1/ST2	Transmitter signal element timing
17	DD(RXC)	115 RT	Receiver signal element timing
14	SBA(-)	118 BSD	Secondary transmitted data
16	SBB(-)	119 BRD	Secondary received data
19	SCA(-)	120 BRS	Secondary request to send
13	SCB(-)	121 BCS	Secondary clear to send
12	SCF(-)	122 BCD	Secondary received carrier detect

* Pins used by the MT200 or MT200 series or this instrument RS-232 interface.

Handshaking

To use an RS-232 interface for transferring data between the instrument and a PC, it is necessary to use certain mutually determined procedures to ensure the proper transfer of data. The execution of these procedures is called handshaking. There are many different handshaking methods corresponding to the different possible combinations of instruments and PCs, so it's necessary choose the same handshaking method for this device and the PC. This instrument allows you to choose any handshaking mode from the following eight modes.

Table of Handshaking Methods (○ = Function Available)

Mode Selection No. (Handshaking method)	Data sending control (Control method when sending data to a PC)			Data receiving control (control method when receiving data from a PC)		
	Software Handshake	Hardware Handshake	No handshake	Software Handshake	Hardware Handshake	No handshake
	Sending stops when X-off received, and resumed when X-on is received.	Sending stops when CB(CTS) is False, and resumed when CB is True.		X-off is sent when received data buffer becomes 3/4 full, and X-on is sent when the received data buffer is only 1/4 full.	CA(RTS) is set to False when received data buffer is only 3/4 full, and is set to True when received data buffer is only 1/4 full.	
0(OFF-OFF)			○			○
1(XON-XON)	○			○		
2(XON-RTS)	○				○	
3(CTS-RTS)		○			○	

Description of Each Handshaking Method

OFF-OFF

- **Data Sending Control**

Handshaking is not carried out between the instrument and the PC. X-on and X-off messages from the PC are treated as data, and CB(CTS) is ignored.

- **Data Receiving Control**

Handshaking is not carried out between the instrument and the PC. After the instrument's receive buffer becomes FULL, excess data is discarded. Therefore, in order to prevent both the instrument's and the PC's receive buffers from becoming FULL, you should create a program on the PC. CA(RTS) is fixed at True.

XON-XON

- **Data Sending Control**

Software handshaking is carried out between the instrument and the PC. If the instrument receives the X-off code from the PC while the instrument is transmitting data, the transmission is stopped until the X-on code is received. CB(CTS) messages from the PC are ignored.

- **Data Receiving Control**

Software handshaking is carried out between the instrument and the PC. When the instrument's available buffer space reaches 64 bytes it transmits an X-off code to the PC, and when the buffer space reaches 192 bytes an X-on code is sent. CA(RTS) is fixed at True.

XON-RTS

- **Data Sending Control**

Software handshaking is carried out between the instrument and the PC. If the instrument receives the X-off code from the PC while the instrument is transmitting data, the transmission is stopped until the X-on code is received. CB(CTS) messages from the PC are ignored.

- **Data receiving control**

Hardware handshaking is carried out between the instrument and the PC. When the instrument's receive buffer reaches 64 bytes CA(RTS) is set to False, and when the buffer reaches 192 bytes CA(RTS) is set to True.

CTS-RTS

- **Data Sending Control**

Hardware handshaking is carried out between the instrument and the PC. If CB(CTS) becomes False while the instrument is transmitting data, the transmission is stopped until CB(CTS) becomes True again. X-on and X-off messages from the PC are treated as data.

- **Data Receiving Control**

Hardware handshaking is carried out between the instrument and the PC. When the instrument's receive buffer reaches 64 bytes, CA(RTS) is set to False, and when the buffer reaches 192 bytes CA(RTS) is set to True.

Precautions Regarding Data Receiving Control

When handshaking is used to control the reception of data, data may still be sent from the computer even if the free space in the receive buffer drops below 64 bytes. In this case, after the receive buffer becomes full, the excess data will be lost whether handshaking is in effect or not. Data storage to the buffer will begin again when there is free space in the buffer.

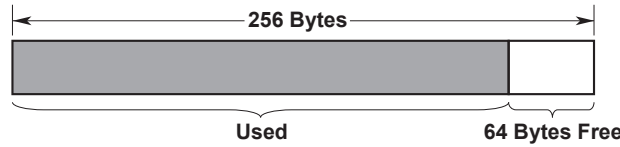

When handshaking is in use, the transfer of data from the buffer to the internal program cannot keep up with the transmission, so the reception of data is stopped when the free space in the buffer reaches 64 bytes.

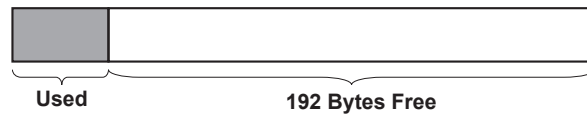

When this occurs, the instrument waits until the free space in the buffer reaches 192 bytes and then resumes reception of data.

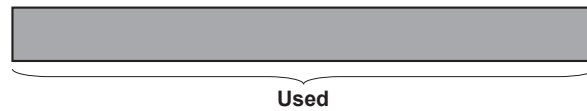

Regardless of whether handshaking is in use or not, if the receive buffer becomes full, the excess data will be lost.

Data Receiving Control Using Handshaking

Setting the Data Format

The RS-232 interface of this instrument performs communications using start-stop synchronization. In start-stop synchronization, one character is transmitted at a time. Each character consists of a start bit, data bits, a parity bit, and a stop bit. (Refer to the figure below.)

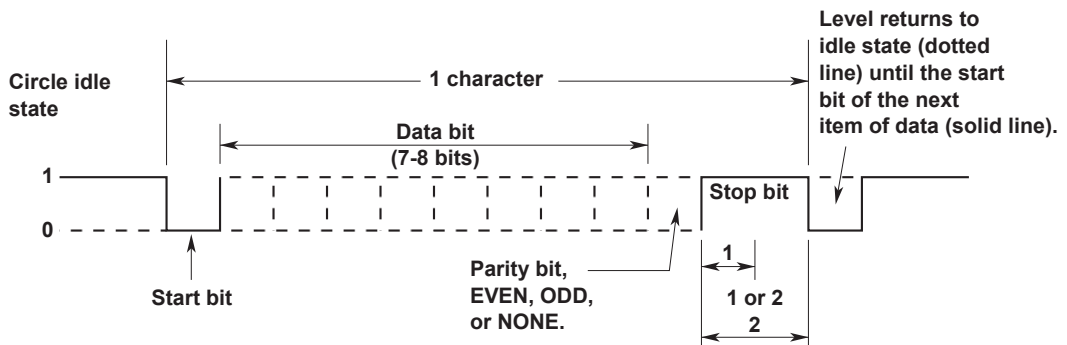

RS-232 Communications Settings

Use the settings below to setup communications so that you can enter settings on the instrument using the PC, or output setting information or values to the computer.

- **Selecting the Handshaking Method**

Choose a data sending/receiving control from the following:

Settings	Handshaking Method
0	OFF-OFF
1	XON-XON
2	XON-RTS
3	CTS-RTS

- **Setting the Data Format**

Choose a data length–parity–stop-bit combination from the following:

Settings	Data Length	Parity bit	Stop bit
0	8	none	1
1	7	ODD	1
2	7	EVEN	1
3	7	none	2

- **Setting the Baud Rate**

Choose from the options below:

1200
2400
4800
9600

Selecting Normal or Talk-Only Mode

The RS-232C interface for this instrument has two control modes: normal mode and talk-only mode. Normal mode is equivalent to the addressable mode for the GP-IB interface, and enables reception of commands and transmission of data. Measured or computed data is output on receipt of the “OD” command. Talk-only mode is equivalent to the talk-only mode for the GP-IB interface. Only transmission of measured or computed data is allowed. No commands can be received.

1. Press **MENU**.
Keep pressing **▲** or **▼** until *r 5232* is displayed in the screen, then press **ENTER/LOCAL**.
2. Press **▲** or **▼** to select *normal* (normal mode) or *talk only* (talk-only mode), then press **ENTER/LOCAL**.
3. Press **MENU** to return to the normal measurement screen. However, if you want to set the handshake mode, data format, or baud rate settings, proceed to “Setting the Handshaking Mode, Data Format, and Baud Rate” on this page.

Setting the Handshaking Mode, Data Format, and Baud Rate

4. With the handshake mode setting screen ($H\bar{H}r\bar{d}$) displayed, press **▲** or **▼** to set the value corresponding to the desired mode, then press **ENTER/LOCAL**. For a description of the settings, refer to the table given on the previous page.
5. With the data format setting screen ($F\bar{d}r\bar{n}$) displayed, press **▲** or **▼** to set the value corresponding to the desired data format, then press **ENTER/ LOCAL**. For a description of the settings, refer to the table given on the previous page.
6. With the data format setting screen ($b_r\bar{H}E$) displayed, press **▲** or **▼** to set the value corresponding to the desired data format, then press **ENTER/ LOCAL**.

RS-232 Specific Commands

The following commands imitate the interface message function of the GP-IB interface.

<ESC>S <Terminator>

Equivalent to the GP-IB's serial poll function. The status byte is output when this command is received.

<ESC>R <Terminator>

Equivalent to the GP-IB's remote/local control function. The instrument is placed in remote status and the panel keys become inoperative when this command is received. Press the **ENTER/LOCAL** to exit from remote status.

<ESC>L <Terminator>

Equivalent to the GP-IB's remote/local control function. When this instrument is in remote status, the instrument will be placed in local status when this command is received.

<ESC>C <Terminator>

Equivalent to the GP-IB's device clear function. The instrument's communications interface is initialized when this command is received.

Before Programming

Basic Programming Format

The following shows the structure of program data.

Command + Parameter + Terminator

ASCII codes are used.

Example	DF	2	CRLF
	Command	Parameter	Terminator

Command

Predefined string of 1 to 3 capital letters

Parameter

Numeric values or character string (ASCII code)

Terminator

GP-IB interface

Specify CR+LF, LF, or EOI for the receive terminator.

The "DL" command is used to set the transmit terminator. The default setting is CR+LF+EOI. For details, see page App-5.

RS-232 Communications Settings

Specify CR+LF or EOI for the receive terminator.

The "DL" command is used to set the transmit terminator. The default setting is CR+LF.

For details, see page App-5.

Precautions when Programming

A single line can contain multiple commands. In this case, make sure that command statements (a command + parameters) are separated by a semicolon (;).

Note

A space or tab between the command and parameter can be omitted.

How to Use the Appendix

Query Command

Query commands can easily be identified since a question mark (?) is added to the end of the command. Data returned in response to a query command is shown as in the example below.

Query Returned data

HD? → HD1

Sample Program

Sample programs demonstrating the commands are given in the appendix. Refer to page App-16.

Troubleshooting, Maintenance, and Inspection

Items to be Checked in Case of an Abnormality

If the instrument does not operate properly even if the actions given in the table below are performed, or if Service required is stated as a corrective action, or if there are any other problems, contact YOKOGAWA or your YOKOGAWA sales representative.

Symptom	What to Check	Page
Nothing is displayed when the power is turned ON.	• Is the LINE switch turned ON?	19
	• Is the fuse blown out?	58
	• Was the power supply cut?	19
The data is not correct.	• Are the ambient temperature and humidity within the acceptable range?	17, 64
	• Is the unused input port covered?	12 to 15
Keys do not function.	• Is the REMOTE indicator LED in the left of the corner OFF?	44
	• Is keylock turned ON?	30
Instrument cannot be controlled via the GP-IB interface.	• Does the GP-IB address specified in the program match the address set up in the instrument?	44, 45
	• Does the interface meet the IEEE Standard 488-1978 electrical and mechanical requirements?	43
	• Is the GP-IB communication turned ON?	22, 45
Instrument cannot be controlled via the RS-232 interface.	• Do the communications specifications of the instrument match those of the controller?	46

Error Codes and Corrective Actions

Error Codes for Operation and Measurement

No.	Type of Error	Cause	Corrective Action	Page
11	Communications command error	Received command not used by this instrument.	Check for error in the command sent.	App-1
12	Parameter error	Parameter value specified is outside allowed range.	Correct the value.	App-2 to App-11
14	Error in execution	Attempted to execute a command not allowed during auto store or while in recall mode.	Make sure that the instrument is not in auto store or recall mode.	36, 37 App-2 to App-11
15	Error in Execution	Attempted to execute a command not allowed in the instrument's current mode.	Check for error in the command or key operation.	App-2 to App-11
16	Error in execution	Attempted to execute a command not allowed when the DMM function is OFF.	Check that the DMM function is OFF.	34 App-2 to App-11
17	Zero calibration error	Attempted to perform zero calibration with an invalid reference pressure value. • Overrange occurred in the measured pressure value • When using an absolute pressure model (767357/767367/767387), the value differs from the factory default by more than 1 kPa.	Check whether the reference value (0 kPa) was correctly input.	23, App-9
18	Option error	Attempted to execute commands related to the D/A output and comparator output function when the /DA option was not installed.	Install the /DA option.	App-1
21	DMM calibration error	Error in DMM calibration procedure.	Input the correct values for the three calibration points.	56 to 58 App-3 to App-4
22	DMM calibration error	Overflow during DMM calibration.	Check the connections and procedures then try the calibration again.	56 to 58 App-3 to App-4
23	DMM calibration error	Overwrite error occurred during DMM calibration (EEPROM failure in DMM section).	Service required.	—
32	Recall error	No data present for the recalled data number.		36 to 38

No.	Type of Error	Cause	Corrective Action	Page
33	Store error	Internal memory full	Delete unneeded measurement data.	36 to 38
38	Store error	Attempted to store measurement data under an already existing data number.	Delete the existing data, or use an unused data number.	
50	Error in measured pressure value	Measured pressure value update error. "-----" appears in the upper part of the screen.	Service required if this continues to be displayed.	–
51	Error in measured pressure value	Overrange occurred in the measured pressure value. "--oL--" is displayed in the upper part of the screen.	Input a pressure within 120% of the measurement range.	24
52	Error in measured pressure value	Overflow occurred in the measured pressure value. "--oF--" is displayed in the upper part of the screen (or [SPn.Err] when in % display mode).	If [SPn.Err] is displayed, reenter the correct pressure value for 0%, 100%.	34, 35
53	DMM measurement error	DMM A/D conversion timeout.	Service required.	–
54	DMM measurement error	DMM measurement update error. "-----" appears in the lower part of the screen,	Service required if this continues to be displayed. (Service is required if, when using the OE communications command to readout the error message, that message to be displayed.)	–
55	DMM measurement error	DMM measurement overrange. "--oL--" appears in the lower part of the screen.	Input a pressure value within the displayed range.	34, 35
56	DMM measurement error	%ERROR calculation overflow. "--oF--" is displayed in the lower part of the screen.	Check whether the pressure percentage, voltage, and current values are all correctly displayed.	34, 35

Self-Test Error When the Power is Turned ON.

No.	Type of Error	Cause	Corrective Action	Page
60	Setting information backup error (excluding communications settings)	Panel setting information other than communications settings were corrupted.	Initialize the settings.	22
61	Communications settings information backup error	File is damaged.	Initialize the settings.	22
62	Measurement data backup error	Measurement data saved to the internal memory was corrupted.	Initialize the data.	–
63	Zero calibration backup value failure (absolute pressure models only)	Values for Zero CAL were corrupted. (767357/767367/767387)	Initialize the Zero CAL values.	23
83	EEPROM error (DMM calibration)	EEPROM values were corrupted.	DMM calibration is required.	56 to 58
84	EEPROM error (D/A output calibration value)	EEPROM values were corrupted.	Service is required.	–
90	Hardware error	Hardware failure in the pressure measurement section.	Service required.	–
91	Pressure measurement section calibration data failure (sensor section)	Calibration data from the pressure sensor were corrupted.	Service required.	–
92	Calibration error in the pressure measurement (calculation) section	Calibration data from the pressure calculation section were corrupted.	Service required.	–
93	Setting value error in the pressure measurement section (sensor section)	Setting data from the pressure sensor were corrupted.	Service required.	–
94	Setting value error in the pressure measurement (calculation) section	Failure in the setting values of the pressure calculation section.	Service required.	–

- If an error 60–63, 83, or 84 occur when turning ON the power, the error will be displayed until a certain key is pressed.

Calibrating the Pressure Measurement Function

Calibration in this section means to establish the relationship between the values displayed on the instrument and those shown on the standard equipment. It is recommended that the instrument be calibrated every six months since it is a high accuracy measuring instrument. When calibrating, close attention should be paid to the pressure standard used and the measurement environment. The pressure standard used for calibration of this instrument must provide tracability to the national standard and have an accuracy of $\pm 0.01\%$ or higher. If a piston pressure gauge is used as the standard, apply the correct pressure to calibrate the instrument, with the following taken into account: gravity at the measuring point, weight of the piston, correction to be made due to buoyancy in the air, temperature coefficient, and measuring temperature. Calibration and adjustment of the accuracy can be performed at YOKOGAWA. Calibration and adjustment of the accuracy requires a high level of skill, so contact your nearest YOKOGAWA representative as listed on the back cover of this manual.

Calibrating the DMM Function (MT220 Only)

Calibration in this section means an adjustment of accuracy based on the relationship between the values shown on the measuring instrument and those shown on the standards instrument. Please note that it is up to the user to calibrate the DMM function as YOKOGAWA does not perform this service.

Pressure Standards for Calibration

Digital multimeter:	DC voltage measuring accuracy ± 6 ppm, (YOKOGAWA model 1281 recommended)
Standard resistor (100 Ω):	Accuracy $\pm 0.02\%$, (YOKOGAWA model 2794 recommended)
DC voltage/current generator:	Stability $\pm 0.02\%$, (YOKOGAWA model 7651 recommended)

Environment

Ambient temperature:	23 \pm 1 $^{\circ}$ C
Corresponding humidity:	45 to 75%
Power supply voltage:	100 to 200/200 to 240 VAC, however you must use the power cord supplied by YOKOGAWA with a 3-to-2 prong adapter, and connect it to an outlet with a protective ground terminal.
Frequency:	50 \pm 1 or 60 \pm 1 Hz
Vibration:	An amount that will have only negligible effect on the instrument
Electric/magnetic fields:	A distance from such fields so that they will not effect the measured values
Surrounding area:	Amounts of gas from decomposing food, steam, salts, and dust that will not effect the measured values.
Warm-up:	Before calibration, this instrument must be warmed up for more than 30 minutes and each standards instrument must be warmed up for a time no shorter than indicated by their specifications.

Connection Method

Connect each instrument as shown below.

For voltage calibration

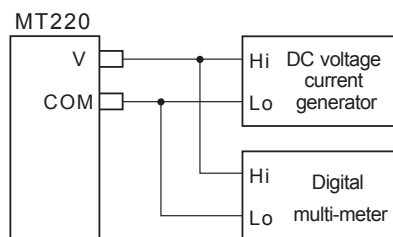

* Do not make any connections to the current terminal of the MT220.

For current calibration

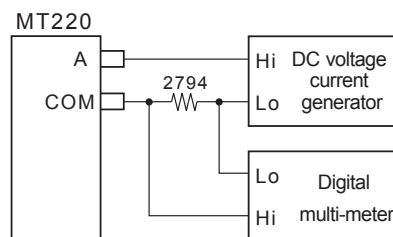

* Do not make any connections to the voltage terminal of the MT220.

Calibration Method

When you connect the pressure standard to each calibration point x_i as shown below, the value displayed on the instrument is given as y_i since this is prior to calibration. During the calibration, the correction factor is computed such that $x_i = y_i$.

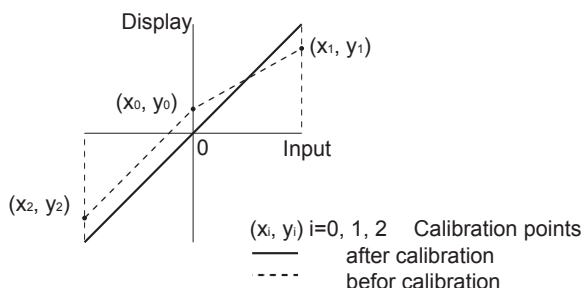

Procedure (Using the Front Panel Keys)

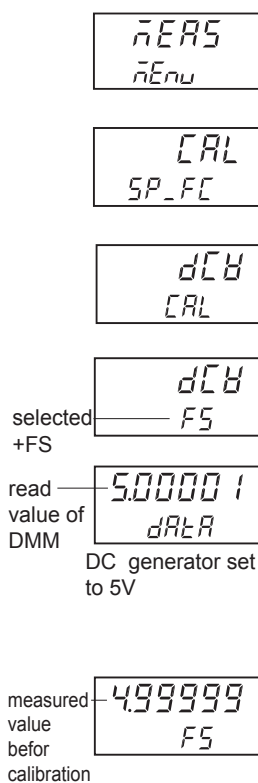

1. Press **MENU**.
2. Hold down the **ZERO CAL** button for 2 seconds, until the **SP_FL** screen appears. If this operation fails, **Err.15** is displayed. If this happens, repeat the above operation.
3. In the **SP_FL** screen, press **▲** or **▼** to display **CAL**, then press **ENTER/LOCAL** to enter calibration mode. Select **End** to return to the normal measurement screen.
4. Press **▲** or **▼** to select the calibration item (current or voltage), then press **ENTER/LOCAL**. With this operation, the DMM measurement item changes automatically.
5. Press **▲** or **▼** to select the calibration point, then press **ENTER/LOCAL**. Set the calibration point in the order **0**, **FS**, **-FS**.
6. When all three calibration points have been set, set the output on the standard instrument. Read the values from the output of the standard equipment on the digital multimeter, then press **▲** or **▼** to enter those values as calibration points. Then press **ENTER/LOCAL**. That is, for a calibration point of 0, you must enter 0 on the instrument (if the standards instrument cannot output a 0, short the voltage input terminal during voltage calibration and open the current input terminal during current calibration.)
7. The measured value prior to calibration is displayed for one second. If the values set as calibration points differ greatly from the measured values there may have been a user error or a problem with the connections, so enter the same calibration points once again.

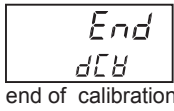

8. You will return to the screen in step 5. Select the next calibration point and press **ENTER/LOCAL**. Once you have entered the three points, select *End*, then press **ENTER/LOCAL**.

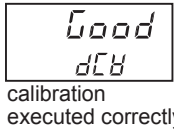

9. The three calibration points are calculated per the correction factor, and written to the EEPROM. When the calibration has been successfully completed, *Good* is displayed and you are returned to the screen in step 4. To return to the normal measurement screen, select *End* then press **ENTER/LOCAL**.

Procedure (Using Communications Commands)

Please see the sample program on page App-17 to App-18.

Note

Set the value of the current calibration point to the current value which was converted from the voltage value read out by the digital multimeter.

Recommended Replacement Parts

We recommend periodic replacement so that you will be able to use the MT210/MT210F/MT220 for a long period of time. Contact your nearest YOKOGAWA dealer for replacement parts.

Parts Name	Part No.	Replacement Period
EL panel (for backlight)	B9320TN	Approx. 5000 hours under continuous use
Lithium battery	A1096EB	Approx. 5 years

Replacing the Fuse



WARNING

- To prevent fire, only use a fuse of the specified rating. Never use a fuse of any other rating and never short-circuit the fuse holder to bypass the fuse.
- Never operate the instrument if you have any reason to suspect any defect or problem with the fuse.
- Before replacing the fuse, be sure to turn the POWER and MAIN POWER switches OFF, remove the connections from each input and output terminal, and remove the power cord from the AC outlet.

French



AVERTISSEMENT

- Afin d'éviter tout risque d'incendie, utilisez uniquement un fusible de la cote spécifiée. N'utilisez jamais de fusible d'une autre cote et ne mettez jamais le porte-fusible en court-circuit pour contourner le fusible.
- Ne faites jamais fonctionner l'instrument si, pour quelque raison que ce soit, vous suspectez un défaut ou un problème du fusible.
- Avant de remplacer le fusible, assurez-vous de mettre hors tension les interrupteurs POWER et MAIN POWER, de retirer les branchements de chaque borne d'entrée et de sortie, et de retirer le cordon d'alimentation de la prise secteur.

Fuse Ratings

When you order a spare fuse, specify the following part number.

Rating	Part Number	Location for Use	Replacement Procedure
250 V, 100 mA, time lag	A1341EF	Current input terminal	See next page
250 V, 3.15 A, time lag	A1113EF	Rear panel	See next page
250 V, 2 A, time lag	A1429EF	Power supply board	Service required*

*: Professional service is required. Contact your nearest YOKOGAWA representative as listed on the back cover of this manual.

Fuse Position and Replacement Method

Turn the fuse holder to the left and pull out the fuse holder. Then, replace with a new fuse.

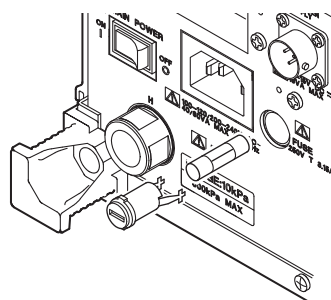

Turn the fuse holder to the left and pull out the fuse holder. Then, replace with a new fuse.

Each current input terminal accommodates a built-in fuse. A fuse is contained in the fuse holder as shown below. To replace the fuse, turn the fuse holder counter-clockwise with your fingers to remove it, then replace the fuse with a new one.

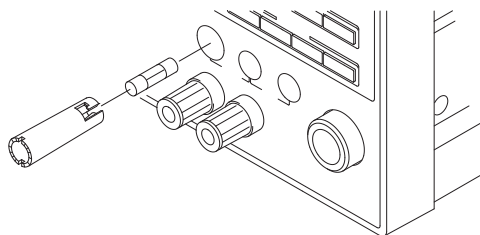

Specifications

Pressure Measurement Section (767351/767361/767381/767353/767363/767383/767355/767365/767385)

Model Code	767351/767361/767381	767353/767363/767383	767355/767365/767385
Pressure Type	Gauge pressure	Gauge pressure	Gauge pressure
Measuring Range (Accuracy guaranteed)	Positive pressure: 0 to 10 kPa Negative pressure: -10 to 0 kPa	Positive pressure: 0 to 130 kPa Negative pressure: -80 to 0 kPa	Positive pressure: 0 to 700 kPa Negative pressure: -80 to 0 kPa
Maximum Display	-12.0000 to 12.0000 kPa	to 156.000 kPa	to 840.00 kPa
Accuracy ^{*1} (Zero CAL) 6 months after calibration	Positive pressure $\pm(0.01\%$ of rdg $+0.15\%$ of FS)	Positive pressure 20 to 130 kPa: $\pm(0.01\%$ of rdg $+3$ digits)	Positive pressure: $\pm(0.01\%$ of rdg $+0.005\%$ of FS)
Normal measurement mode (Averaging ON)	Negative pressure $\pm(0.2\%$ of rdg $+0.1\%$ of FS)	Negative pressure $\pm(0.2\%$ of rdg $+0.1\%$ of FS)	Negative pressure $\pm(0.2\%$ of rdg $+0.1\%$ of FS)
Medium-speed ^{*2} measurement mode (added to normal measurement mode)	$\pm 0.02\%$ of FS	$\pm 0.02\%$ of FS	$\pm 0.02\%$ of FS
High-speed mode ^{*2} (added to medium-speed measurement mode)	$\pm 0.04\%$ of FS	$\pm 0.03\%$ of FS	$\pm 0.03\%$ of FS
One year after calibration (Represented by adding the value shown on the right to the accuracy percentages given above for six months after calibration.)	$\pm 0.01\%$ of FS	$\pm 0.005\%$ of FS	$\pm 0.005\%$ of FS
Display Update Interval ^{*3}			
Normal measurement mode	250 ms	250 ms	250 ms
Medium-speed ^{*2} measurement mode	100 ms	100 ms	100 ms
High-speed ^{*2} measurement mode	100 ms	100 ms	100 ms
Response Time ^{*4}			
Normal measurement mode	2.5 s or lower	2.5 s or lower	2.5 s or lower
Medium-speed ^{*2} measurement mode	200 ms or lower	200 ms or lower	200 ms or lower
High-speed ^{*2} measurement mode	200 ms or lower	50 ms or lower	70 ms or lower
Resolution	0.0001 kPa	0.001 kPa	0.01 kPa
Internal Capacity	Approx. 10 cm ³	Approx. 10 cm ³	Approx. 10 cm ³
Input Tolerance	2.7 kPa abs to 500 kPa gauge (Up to 50 kPa gauge for the 767381)	2.7 kPa abs to 500 kPa gauge	2.7 kPa abs to 3000 kPa gauge
Temperature Coefficient	Zero drift $\pm 0.0015\%$ of FS/ $^{\circ}$ C Sensitivity $\pm 0.001\%$ of FS/ $^{\circ}$ C	Zero drift $\pm 0.001\%$ of FS/ $^{\circ}$ C Sensitivity $\pm 0.001\%$ of FS/ $^{\circ}$ C	Zero drift $\pm 0.001\%$ of FS/ $^{\circ}$ C Sensitivity $\pm 0.001\%$ of FS/ $^{\circ}$ C
Effect of Inclination	at 90° inclined forward or backward Zero drift $\pm 0.1\%$ of F.S. 30° inclined right or left Zero point $\pm 2.5\%$ of FS	at 90° inclined forward or backward Zero drift $\pm 0.01\%$ of FS 30° inclined right or left Zero point $\pm 0.2\%$ of FS	at 90° inclined forward or backward Zero drift $\pm 0.01\%$ of FS 30° inclined right or left Zero point $\pm 0.05\%$ of FS
Weight (Main unit)	767351: approx. 8 kg 767361/767381: approx. 8 kg	767353: approx. 7 kg 767363/767383: approx. 6.5 kg	767385: approx. 6.5 kg 767355: approx. 8.5 kg/ 767365: approx. 8 kg

*1 Operating conditions: Temperature $23 \pm 3^{\circ}$ C, humidity 20 to 80% RH, power voltage rating $\pm 5\%$, positioned horizontally. Refer to Yokogawa's pressure standard.

*2 Measurement mode can be switched between normal, medium-speed, and high-speed on the 76738 only.

*3 Data output rate via communications is the same as the display update rate.

*4 Measurement conditions of response time:

- Time from the start of change until the value settles within $\pm 1\%$ of the convergence value.
- Release from full scale value to atmospheric pressure. (Input section is no load condition. From 0 to atmospheric pressure for the absolute pressure model.)
- Measure using D/A output.

Pressure Measurement Section (767356/767366/767386/767357/767367/767387)

Model Code	767356/767366/767386	767357/767367/767387
Pressure Type	Gauge pressure	Absolute pressure
Measuring Range (Accuracy guaranteed)	Positive pressure: 0 to 3000 kPa Negative pressure: -80 to 0 kPa	0 to 130 kPa abs
Maximum Display	to 3600.00 kPa	to 156.000 kPa abs
Accuracy ¹ (Zero CAL) 6 months after calibration	Positive pressure $\pm(0.01\%$ of rdg $+0.005\%$ of FS)	$\pm(0.01\%$ of rdg $+0.005\%$ of FS)
Normal measurement mode (Averaging ON)	Negative pressure $\pm(0.2\%$ of rdg $+0.1\%$ of FS)	
Medium-speed ² measurement mode (added to normal measurement mode)	$\pm 0.02\%$ of FS	$\pm 0.02\%$ of FS
High-speed mode ² (added to medium-speed measurement mode)	$\pm 0.03\%$ of FS	$\pm 0.03\%$ of FS
One year after calibration (Represented by adding the value shown right to the accuracy percentages given for six months after calibration.)	$\pm 0.005\%$ of FS	$\pm 0.005\%$ of FS
Display update interval ³		
Normal measurement mode	250 ms	250 ms
Medium-speed ² measurement mode	100 ms	100 ms
High-speed ² measurement mode	100 ms	100 ms
Response Time ⁴		
Normal measurement mode	2.5 s or lower	2.5 s or lower
Medium-speed ² measurement mode	200 ms or lower	200 ms or lower
High-speed ² measurement mode	100 ms or lower	50 ms or lower
Resolution	0.01 kPa	0.001 kPa
Input Tolerance	2.7 kPa abs to 4500 kPa gauge	1 Pa abs to 500 kPa gauge
Internal Capacity	Approx. 10 cm ³	Approx. 10 cm ³
Temperature Coefficient	Zero drift $\pm 0.001\%$ of FS/ $^{\circ}$ C Sensitivity $\pm 0.001\%$ of FS/ $^{\circ}$ C	Zero drift $\pm 0.001\%$ of FS/ $^{\circ}$ C Sensitivity $\pm 0.001\%$ of FS/ $^{\circ}$ C
Effect of Inclination	at 90° inclined forward or backward Zero point $\pm 0.01\%$ of FS 30° inclined right or left Zero point $\pm 0.01\%$ of FS	at 90° inclined forward or backward Zero point $\pm 0.01\%$ of FS 30° inclined right or left Zero point $\pm 0.2\%$ of FS
Weight (Main unit)	767356: approx. 7 kg 767366/767386: approx. 6.5 kg	767357: approx. 7 kg 767367/767387: approx. 6.5 kg

*1 Operating conditions: Temperature 23 \pm 3°C, humidity 20 to 80% RH, power voltage rating $\pm 5\%$, positioned horizontally.
Refer to Yokogawa's pressure standard.

*2 Measurement mode can be switched between normal, medium-speed, and high-speed on the 76738□ only.

*3 Data output rate via communications is the same as the display update rate.

*4 Measurement conditions of response time:

- Time from the start of change until the value settles within $\pm 1\%$ of the convergence value.
- Release from full scale value to atmospheric pressure. (Input section is no load condition. From 0 to atmospheric pressure for the absolute pressure model.)
- Measure using D/A output.

Pressure Measurement Section (767370/767371)

Model Code	767370	767371
Pressure Type	Differential pressure (H input ≥ L input)	Differential pressure (H input ≥ L input)
Measuring Range (Accuracy guaranteed)	0 to 1 kPa	0 to 10 kPa
Maximum Display	-1.20000 to 1.20000 kPa	-12.0000 to 12.0000 kPa
Accuracy ^{*1} (Zero CAL) 6 months after calibration	±(0.015% of rdg +0.03% of FS)	±(0.01% of rdg +0.025% of FS)
One year after calibration (Represented by adding the value shown right to the accuracy percentages given for six months after calibration.)	±0.01% of FS	±0.01% of FS
Display update interval	250 ms	250 ms
Response time	5 s or less	2.5 s or less
Resolution	0.00001 kPa	0.0001 kPa
Input Tolerance	1 Pa abs to 50 kPa gauge ^{*2}	2.7 kPa abs to 500 kPa gauge
Internal Capacity	L and H, approx. 10cm ³	L and H, approx. 10cm ³
Temperature Coefficient	Zero drift ±0.005% of FS/°C Sensitivity ±0.001% of FS/°C	Zero drift ±0.0015% of FS/°C Sensitivity ±0.001% of FS/°C
Effect of Inclination	at 90° inclined forward or backward Zero point ±0.5% of FS 5° inclined right or left Zero point ±3% of FS	at 90° inclined forward or backward Zero point ±0.1% of FS 30° inclined right or left Zero point ±2.5% of FS
Weight (Main unit)	Approx. 8.2 kg. Approx. 289 oz.	Approx. 8.2 kg. Approx. 289 oz.

*1 Operating conditions: Temperature 23 ± 3°C, humidity 20 to 80% RH, power voltage rating ±5%, positioned horizontally.
Averaging is OFF for the 767370 and ON for the 767371.

Refer to Yokogawa's pressure standard.

*2 The difference between L and H is less than 50 kPa

Pressure Measurement Section (767372/767373)

Model Code	767372	767373
Pressure Type	Differential pressure (H input ≥ L input)	Differential pressure (H input ≥ L input)
Measuring Range (Accuracy guaranteed)	0 to 130 kPa	0 to 700 kPa
Maximum Display	-156.000 to 156.000 kPa	-156.00 to 840.00 kPa
Accuracy ^{*1} (Zero CAL) 6 months after calibration (Averaging ON)	20 to 130 kPa: ±(0.01% of rdg +(0.01% of FS + 3 digits) 0 to 20 kPa: ±(0.01% of FS + 5 digits)	±(0.01% of rdg +0.015% of FS)
One year after calibration (Represented by adding the value shown right to the accuracy percentages given for six months after calibration.)	±0.005% of FS	±0.005% of FS
Display update interval	250 ms	250 ms
Response time	2.5 s or less	2.5 s or less
Resolution	0.001 kPa	0.01 kPa
Input Tolerance	2.7 kPa abs to 500 kPa gauge	2.7 kPa abs to 1000 kPa gauge
Internal Capacity	L and H, approx. 10cm ³	L and H, approx. 10cm ³
Temperature Coefficient	Zero drift ±0.001% of FS/°C Sensitivity ±0.001% of FS/°C	Zero drift ±0.001% of FS/°C Sensitivity ±0.001% of FS/°C
Effect of Inclination ^{*1}	at 90° inclined forward or backward Zero point ±0.01% of FS 30° inclined right or left Zero point ±0.2% of FS	at 90° inclined forward or backward Zero point ±0.01% of FS 30° inclined right or left Zero point ±0.05% of FS
Weight (Main unit)	Approx. 8.2 kg. Approx. 289 oz.	Approx. 8.2 kg. Approx. 289 oz.

*1 Operating conditions: Temperature 23 ± 3°C, humidity 20 to 80% RH, power voltage rating ±5%, positioned horizontally.
Refer to Yokogawa's pressure standard.

Pressure Measurement Section (Common to All Models)

Leakage	Less than 10^{-5} cm ³ /sec
Permissible Fluids	Non-flammable, non-explosive, non-toxic, or non-corrosive gasses and liquids
Fluid Temperature	5 to 50°C
Fluid Viscosity	Less than 5×10^{-6} m ² /s
Pressure Sensor	Silicon resonant sensor
Pressure Sensing Element	Diaphragm
Display Units	kPa only, kPa (kgf/cm ² , mmHg, mmH ₂ O), or kPa (psi, inHg, inH ₂ O, kgf/cm ² , mmHg, mmH ₂ O) ^{*1}
Input Connector	Rc1/4, NPT1/4 (female), and VCO ^{*2} 1/4 (optional) on both front and rear panels. It is not permitted to use both connectors at the same time.
Material	Diaphragm: Hastelloy C 276 Measurement chamber flange: SUS316 Internal piping: SUS316 O-ring: Fluoro-rubber Input port: SUS316

*1: Select at time of purchase In all cases, factory default is kPa.

*2: VCO is registered trademark of SWAGELOK in the United States.

DCV and DCA Measurement Section, MT220 Only

Measuring Range	0 to ± 5 V, 0 to ± 20 mA	
Accuracy Guaranteed Range	0 to ± 5.25 V, 0 to ± 21 mA	
Accuracy ^{*1}	30 days after calibration	$\pm(0.01\%$ of rdg + 2 digits)
	90 days after calibration	$\pm(0.03\%$ of rdg + 2 digits)
	6 months after calibration	$\pm(0.05\%$ of rdg + 3 digits)
	One year after calibration	$\pm(0.07\%$ of rdg + 3 digits)
Display Range	DCV 0 to ± 6.0000 V DCA 0 to ± 24.000 mA	
Maximum Allowable Input Voltage	30 VDC	
Maximum Allowable Input Current	100 mA	
Display Units	V, mA	
Insertion Impedance	DCV	Approx. 10 M Ω
	DCmA	Approx. 20 Ω
CMRR (DCV only)	120 dB min. (50/60 Hz, RS=1 k Ω)	
NMRR (DCV only)	60 dB min. (50/60 Hz)	
Temperature Coefficient	$\pm(0.01\%$ of rdg + 2 digits)/10°C	

*1 Operating condition: Temperature of 23 \pm 3°C, humidity of 20 to 80% RH, and a power supply voltage rating of $\pm 5\%$.

24 V Supply Section, MT220 Only

Output Voltage ^{*1}	24 ± 1 VDC (fixed)
Output Current	Max. 30 mA max. (with limiter approx. 40 mA)

*1 Operating condition: Temperature of 23 \pm 3°C, humidity of 20 to 80% RH, and a power supply voltage rating of $\pm 5\%$.

Data memory function, MT220 Only

Capacity	2000 data
----------	-----------

Communication Function (install either one)

• GP-IB Interface

Electrical and mechanical specifications	Conforms to IEEE St'd 488-1978
Functional specifications	SH1, AH1, T5, L4, SR1, RL1, PP0, DC1, DT1, and C0

• RS-232 Interface

Synchronization	Start-stop synchronization
Baud rate	1200, 2400, 4800, or 9600 bits/s

Option /DA

• D/A Output Specifications

Output voltage	0 to ±2 V or 0 to ±5 V (switchable) Output example: 130 kPa gauge pressure model Output range when ±2 V 0 kPa: 0 V 65 kPa: 1 V 130 kPa: 2 V 156 kPa: 2.4 V -80 kPa: -1.231 V
Output resolution	16 bits (full scale is approx. ±125% of the range)
Output accuracy (23±3°C) (after ZERO CAL) (At the D/A output terminal)	When dynamic mode is ON (MT210F only) ±0.5% of FS ^{*1} When dynamic mode is OFF Add ±0.05% of FS to the pressure measurement accuracy
Temperature influence	±(0.005% of FS)/°C
Output update rate	Approx. 2 ms
Response time	When dynamic mode is ON (MT210F only) Same as the specifications of the high-speed measurement mode. When dynamic mode is OFF Same as the specifications of the selected measurement mode.
Output resistance	0.1 Ω or less
Load resistance	1 kΩ or more

*1: ±0.7% of full scale for the 767381 only.

• Comparator Output Specifications

Output signal	HIGH, IN, LOW, and BUSY
Operation	When D/A > upper limit: HIGH = 1 When upper limit ≥ D/A ≥ lower limit: IN = 1 When D/A < lower limit: LOW = 1 When converting signal: BUSY = 1 LED (on display) corresponding to HIGH, IN, and LOW lights
Signal level	TTL level

• External Trigger Specifications

Input level	TTL level
Operation	If a high level signal is applied externally when measurement is held, measurement trigger is activated on the falling edge. When a trigger occurs, the LED on the front panel section lights.

Common Specifications

Display	LCD (with back lighting), pressure measurement section: 5-1/2 digits/4-1/2 digits ^{*1} DC V,DC A measurement section: 4-1/2 digits
Warmup Time	Approx. 5 minutes
Operating Temperature/ Humidity Range	5 to 40,°C ² , 20 to 80% RH (no condensation allowed)
Operating altitude	2000 m or less
Storage Temperature Range	-20 to 60°C
Over Voltage Category	CAT II (EN61010-1)
Power Source	AC, DC, or Ni-Cd batteries (sold separately)
Rated AC Voltage	100 to 120 VAC/200 to 240 VAC
Rated AC Frequency	50/60 Hz
Permitted AC Voltage Range	90 to 132 VAC/180 to 264 VAC
Permitted AC Frequency Range	47 to 63 Hz
Rated DC Voltage	10 to 15 VDC
Permitted DC Voltage Range	9 to 16.5 VDC
Battery Pack (Optional Accessory)	External Ni-Cd batteries: For the MT210/MT210F The instrument can be operated continuously for approximately 10 hours (with back light on) if the batteries have been charged fully. For the MT220 The instrument can be operated continuously for approximately 6 hours (with back light, DMM, and 24 VDC output ON) if the batteries have been charged fully. However, this varies according to the operating conditions. Charger: Built in to the MT120/MT210F/MT220. Charging time: Approximately 12 hours
Maximum power consumption	Pressure measurement: 25 VA max. (100 VAC), 40 VA max. (200 VAC) Charging: 45 VA max. (100 VAC), 65 VA max. (200 VAC) When operated on DC power: 10 VA max.
Insulation Resistance	More than 20 MΩ at 500 VDC (between AC power line and case)
Withstanding Voltage	1500 VAC for one minute at 50/60 Hz (between AC power line and case) 350 VAC for one minute at 50/60 Hz (between each DMM input terminal and 24 VDC output terminal and case)
External Dimensions	Main unit approximately 132 × 213 × 350 mm (no projecting parts included) Battery pack (optional) approximately 33 × 182 × 260 mm (no projecting parts included)
Weight	Refer to "Weight (Main Unit)" in the Pressure Measurement Section. Battery pack (optional) approximately 2.7 kg
Accessories	Connector for external DC power (1), rubber feet (2), seal for measuring object, power cord (1), and one user's manual (this manual), Remote connector for the output terminal (when the /DA option is installed) (1), Fuse (2) (1 is attached to the manometer), VCO body (1) (for -P3) or (2) (for the 76737□-P3), fuse for current input terminal (2, one being pre-installed, MT220 only), and one measurement lead (MT220 only).

*1 Values are displayed with 4-1/2 and 3-1/2 digits with the models 767355, 767365, 767373, and 767385.

*2 Operating temperature is 10 to 35°C (model 767370 only)

External Dimensions

Unit: mm

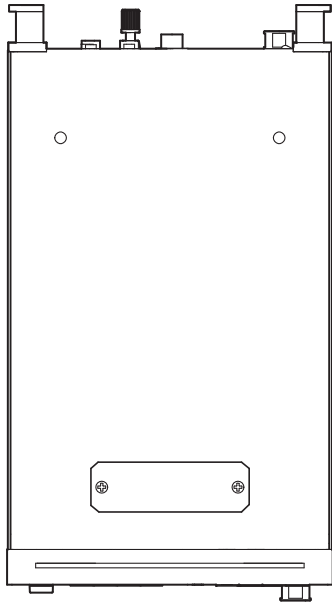

Rear Panel

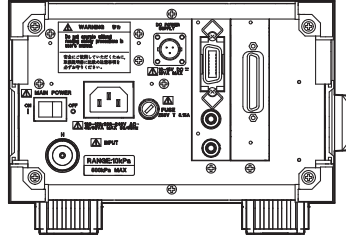

(With RS-232 Connector)

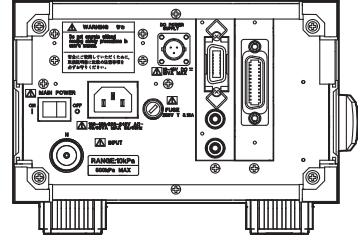

(With GP-IB Connector)

MT210/MT210F Absolute Pressure/Gauge Pressure

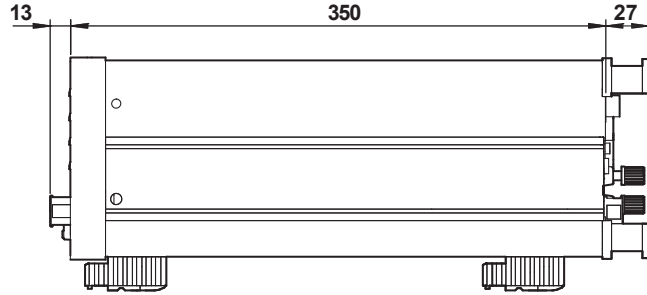
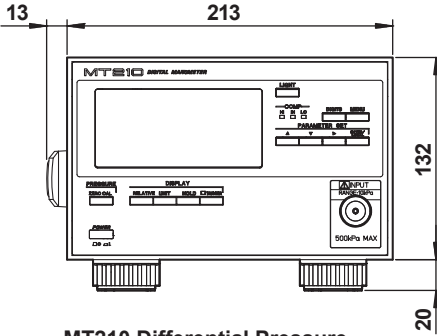

MT210 Differential Pressure

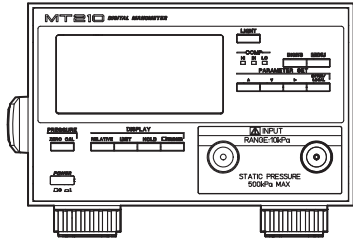

MT220 Absolute Pressure/Gauge Pressure



Battery Pack (269913)

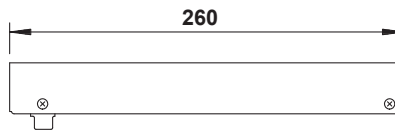
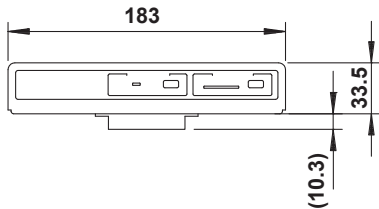

Unless otherwise specified, tolerance is 3%, however, tolerance is 0.3 mm when a dimension is below 10 mm.

Appendix

Command List

A detailed description of each command is provided in these appendices.

Command	Description	Notes
Functions Common to the MT210, the MT210F, and the MT220		
PZ	Pressure zero calibration	
PUm	Setting the Units	
PDm	Sets the number of pressure display digits (4-1/2 or 5-1/2)	
RELm	Setting relative value display ON/OFF	
HDm	Setting data hold ON/OFF	
E/<GET>	Activates a trigger	
AGm	Sets averaging function ON or OFF	
SI _m	Sets the pressure sample rate ^{*1}	
BL _m	Turns the back lighting ON or OFF	
BP _m	Turns the beep sound ON/OFF	
DR _m	Sets the D/A output range	/DA
CMP _m	Sets the comparator output ON/OFF	/DA
CMD _{m,n}	Sets the comparator upper and lower limit	/DA
OD	Measurement Data output request	
OS	Setting Information output request	
OE	Error code output request	
Hm	Turns the output header setting ON or OFF	
DL _m	Sets output data terminator	
IM _m	Sets the criteria for status byte interrupts	
RC	Initializes Settings	
MT210F only		
MS _m	Sets the measurement mode	
DY _m	Turns ON/OFF D/A output dynamic mode	/DA
MT220 only		
DIS _m	Selects display mode	
AL	Sets 0% pressure automatically	
AH	Sets 100% pressure automatically	
ML _{m, n}	Sets 0% pressure manually	
MH _{m, n}	Sets 100% pressure manually	
DMM _n	Sets DMM function ON or OFF	
DF _m	Selects current or voltage measurement	
VO _m	Sets 24 VDC output ON or OFF	
ST	Selects manual store of measured data	
SO _m	Turns measurement data auto store ON or OFF	
SM _m	Selects the storage mode (manual/auto)	
SR _m	Sets the rate of auto store	
SND _m	Sets the number of data items to be stored in auto store mode	
SNOM	Sets the memory number to which data is to be stored	
OM	Requests output of the number of data which can be stored	
RO _m	Turns measurement data recall mode ON or OFF	
RNO _m	Selects the memory number from which data is to be recalled	
ORD _{m,n}	Requests output of recall data	
DB _{m,n}	Partially deletes the stored measurement data	
DA	Deletes all of the stored measurement data	
SY _m	Switches between DMM calibration mode and normal measurement mode	
CAL _m	Selects the item to be DMM-calibrated	
CVP _m	Sets DMM calibration points (DC5 V range)	
CVD _m	Sets DMM calibration points (DC5 V range)	
CAP _m	Sets DMM calibration points (DC20 mA range)	
CAD _m	Sets DMM calibration points (DC20 mA range)	

*1: 767370 (MT210 1 kPa differential pressure model) only.

Communications Command List

AG/AG?

Turns the averaging function ON and OFF, and queries the current setting.

Syntax

AGm <terminator>

“m” represents ON/OFF for the averaging function.

For the MT210/MT210F

0: Averaging is OFF for pressure measurement.

1: Averaging is ON for pressure measurement.

For the MT220

0: Pressure averaging OFF
DMM averaging OFF

1: Pressure averaging ON
DMM averaging OFF

2: Pressure averaging OFF
DMM averaging ON

3: Pressure averaging ON
DMM averaging ON

Query

AG? <terminator>

Response Example

AG1

Description

- For the MT210F, averaging settings are only valid for normal measurement mode. The averaging function does not work when in medium and high-speed measurement modes so it cannot be selected. An error 15 occurs.
- Pressure averaging ON(AG1) cannot be selected when the pressure sampling rate is 4 s (S11) on the 767370 (1 kPa differential model). An error 12 occurs.
- Cannot change in recall mode. An error 14 occurs.

AH

Sets the current measured pressure value as the 100% value.

Syntax

AH <terminator>

Description

- The 100% value cannot be automatically set when in % or %ERROR display mode. An error 15 occurs.
- Cannot be executed while displaying the relative value. An error 15 occurs.
- Cannot execute in recall mode. An error 14 occurs.

AL

Sets the current measured pressure value as the 0% value.

Syntax

AL <terminator>

Description

- The 0% value cannot be automatically set when in % or %ERROR display mode. An error 15 occurs.
- Cannot be executed while displaying the relative value. An error 15 occurs.
- Cannot execute in recall mode. An error 14 occurs.

BL/BL?

Turns the back lighting function ON and OFF, and queries the current setting.

Syntax

BLm<terminator>

“m” represents ON/OFF for the back lighting.

0: OFF

1: ON

Query

BL?<terminator>

Response Example

BL0

BP/BP?

Queries the setting for the beep sound (the sound when keys are pressed).

Syntax

BPm<terminator>

“m” represents the ON/OFF for the beep sound setting.

0: OFF

1: ON

Query

BP?<terminator>

Response Example

BP1

CAD

Sets the value of the DC current in the calibration point and queries the measurement value of the input before calibration.

Syntax

CADm<terminator>

“m” represents the calibration value.

0 (CAP1): 0.0000 <fixed>

+FS(CAP2): 0.0000 to 24.0000

+FS(CAP3): -24.0000 to 0.0000

Response Example

A_N_20.0000

Description

- Error 11 occurs if the mode is not DMM calibration mode.
- If the item to be calibrated is not set to DC current (CAL2), an error 21 occurs.
- For the calibration value for calibration point 0, set m to 0.
- For details regarding the calibration procedure, refer to pages 57 and App-18.

CAL/CAL?

Sets the DMM calibration item and queries the current setting.

Syntax

CALm<terminator>

“m” represents the item to be calibrated.

0: Returns to normal measurement mode.

1: DC voltage (5 V range)

2: DC voltage (20 mA range)

Query

CAL?<terminator>

Response Example

CAL1

Description

- Error 11 occurs if the mode is not DMM calibration mode.
- For details regarding the calibration procedure, refer to pages 57 and App-18.

CAP/CAP?

Sets the calibration points for the DC current (20 mA range), and queries the current setting.

Syntax for setting

CAPm<terminator>

“m” represents the calibration point.

0: After calibration, the correction coefficient is calculated, then the result is written to the EEPROM.

1: (0 mA)

2: +FS(20.0 mA)

3: -FS(-20 mA)

Query

CAP?<terminator>

Response Example

CAP1

Description

- Error 11 occurs if the mode is not DMM calibration mode.
- If the item to be calibrated is not set to DC current (CAL2), an error 21 occurs.
- If the three calibration points have not been set when end (end of calibration) is selected, calibration error 21 occurs. Also, if the calculated correction coefficient is not correct, calibration error 22 occurs.
- For details regarding the calibration procedure, refer to pages 57 and App-18.

CMD/CMD?

Sets the upper and lower limit of the comparator, and queries the current setting.

Syntax

CMDm,n<terminator>

“m” represents the comparator lower limit

“n” represents the comparator upper limit

The setting range and resolution for m and n is the same as that of the pressure measurement display.

Query

CMD?<terminator>

Response Example

CMD0.000,130.000 (for 130-kPa range models)

Description

- Only valid with the D/A output option (/DA)
- The parameters are set in the order lower limit, then upper limit. The setting, Lower limit \geq upper limit, is not possible. An error 12 occurs.

CMP/CMP?

Turns comparator output ON/OFF, and queries the current setting.

Syntax

CMPm<terminator>

“m” represents the comparator output

0: OFF

1: ON

Query

CMP?<terminator>

Response Example

CMP1

Description

Only valid with the D/A output option (/DA)

CVD

Sets the value of the DC voltage (5-V range) in the calibration point and queries the measurement value of the input before calibration.

Syntax

CVDm<terminator>

“m” represents the calibration value.

0 (CVP1): 0.0000 <fixed>

+FS(CVP2): 0.00000 to 6.00000

-FS(CVP3): -6.00000 to 0.00000

Response Example

V_N_5.0000

Description

- Error 11 occurs if the mode is not DMM calibration mode.
- If the item to be calibrated is not set to DC voltage (CAL1), an error 21 occurs.
- For the calibration value for calibration point 0 (CVP1), set m to 0.
- For details regarding the calibration procedure, refer to pages 57 and App-18.

CVP/CVP?

Sets the calibration points for the DC voltage (5 V range), and queries the current setting.

Syntax

CVPm<terminator>

“m” represents the calibration point.

0: After calibration, the correction coefficient is calculated, then the result is written to the EEPROM.

1: 0(0V)

2: +FS (5 V)

3: -FS (-5 V)

Query

CVP?<terminator>

Response Example

CVP1

Description

- Error 11 occurs if the mode is not DMM calibration mode.
- If the item to be calibrated is not set to DC voltage (CAL1), an error 21 occurs.
- If the three calibration points have not been set when end (end of calibration) is selected, calibration error 21 occurs. Also, if the calculated correction coefficient is not correct, calibration error 22 occurs.
- For details regarding the calibration procedure, refer to pages 57 and App-18.

DA

Deletes all the stored data.

Syntax

DA <terminator>

Description

Cannot be executed during auto store. An error 14 occurs.

DB/DB?

Deletes the specified stored data.

Syntax

DB m, n <terminator>

“m” represents the Number of the first memory location to be deleted.

m=1 to 9999

“n” represents the number of the last memory location to be deleted.

n=1 to 9999 (n≥m)

Query

DB? <terminator>

Response Example

DB1, 1

Description

- If the end memory number is smaller than the start memory number, error 12 occurs.
- Cannot be executed during auto store. An error 14 occurs.

DF/DF?

Makes the current/voltage measurement setting/queries the current setting.

Syntax

DF m <terminator>

“m” represents the measurement item.

1: DC voltage (5V range)

2: DC current (20mA range)

Query

DF? <terminator>

Response Example

DF1

Description

- Cannot change during data hold. An error 15 occurs.
- Cannot change with DMM function OFF. An error 16 occurs.
- Cannot change in recall mode. An error 14 occurs.

DIS/DIS?

Sets display mode and queries the current setting.

Syntax

DIS m <terminator>

“m” represents the display mode.

0: Normal measurement display

1: % display

2: %ERROR display (possible only when the DMM function is ON)

Query

DIS? <terminator>

Response Example

DIS0

Description

Cannot be changed while displaying the relative value. An error 15 occurs.

DL/DL?

Sets the communications output data terminator and queries the current setting.

Syntax

DLm<terminator>

“m” represents the terminator type.

GP-IB RS-232

0: CR+LF+EOI CR+LF

1: LF LF

2: EOI CR

Query

DL?<terminator>

Response Example

DL0

DMM/DMM?

Turns the DMM function ON and OFF and queries the current setting.

Syntax

DMM m <terminator>

“m” represents ON/OFF for the DMM function.

0: DMM function is OFF

1: DMM function is ON.

Query

DMM? <terminator>

Response Example

DMM1

Description

- Cannot change during data hold. An error 15 occurs.
- Cannot change in recall mode. An error 14 occurs.

DR/DR?

Sets the D/A output range, and queries the current setting.

Syntax

DRm<terminator>

“m” represents the D/A output range

0: ±2 VDC

1: ±5 VDC

Query

DR?<terminator>

Response Example

DR0

Description

Only valid with the D/A output option (/DA)

DY/DY?

Turns D/A output dynamic mode ON/OFF and queries the current setting.

Syntax

DYm<terminator>

“m” represents D/A output dynamic mode

0: OFF

1: ON

Query

DY?<terminator>

Response Example

DY0

Description

- Only valid with the D/A output option (/DA) on the MT210F.
- On the MT210/MT210F, it is fixed to OFF(DY0)It cannot be set to ON(DY1).

E, <interface message GET>

Activates a trigger.

Syntax

E<terminator>

<interface message GET>

Description

Only applicable when data is on hold. An error 15 occurs.

H/H?

Sets whether the header is added to the measurement data output via communications and queries the current setting.

Syntax

Hm<terminator>

“m” represents the header setting.

0: OFF (no header)

1: ON (header is added)

Query

H?<terminator>

Response Example

H1

HD/HD?

Sets the data hold and queries the current setting.

Syntax

HDm<terminator>

“m” represents the state of data hold.

0: Data hold is OFF.

1: Data hold is ON.

Query

HD?<terminator>

Response Example

HD0

IM/IM?

Sets the criteria for a status byte interrupt and queries the current setting.

Syntax

IMm<terminator>

“m” is the cause for the interrupt, (0 to 31).

1: Computation END

2: Auto store END(only for MT220)

4: Syntax error

8: OVER

16: 24 VOUT-OL- (MT220 only)

Query

IM?<terminator>

Response Example

IM31

Description

If more than one interrupt is to be used, the sum of the interrupt numbers must be set as “m.”

For example, to select all interrupts, the setting is IM31.

MH/MH?

Sets the value corresponding to the 100% value (% display)/queries the current setting.

Syntax

MH m, n <terminator>

“m” represents the units of pressure, 1 to 7 (refer to the PU command)

“n” represents the 100% range value

The setting range and resolution

for n is the same as that of the pressure measurement display (see

“Specifications” on page 60).

Query

MHm? <terminator>

Response Example

MH4, 130.000

Description

“m” in the query syntax also represents the unit of pressure as specified in the setting syntax.

ML/ML?

Sets the value corresponding to the 0% value (% display)/queries the current setting.

Syntax

ML m, n <terminator>

“m” represents the units of pressure, 1 to 7 (refer to the PU command)

“n” represents the 0% range value

The setting range and resolution

for n is the same as that of the pressure measurement display (see

“Specifications” on page 60).

This is the setting range when the units of pressure are kPa.

Query

MLm? <terminator>

Response Example

ML4, 0.000

Description

m in the query syntax also represents the unit of pressure as specified in the setting syntax.

MS/MS?

Sets the measurement mode and queries the current setting.

Syntax

MSm<terminator>

“m” represents the measurement mode.

0: normal measurement mode

1: medium-speed measurement mode

2: high-speed measurement mode

Query

MS?<terminator>

Response Example

MS0

Description

- Measurement mode changes can only be made on the MT210F.
- On the MT210/MT220, the mode is fixed at (MS0). Middle-speed (MS1) and high-speed (MS2) cannot be selected.

OD

Requests output of the measured or computed data.

Syntax

OD<terminator>

Description

- Cannot execute in recall mode. An error 14 occurs.
- Refer to page App-13, “Output Format for Measurement and Computation Data.”

OE

Requests output of the error information.

Syntax

OE<terminator>

Response Example

ERR11

Description

For a description of each error code, refer to “Error Codes and Corrective Actions” on page 54.

OM

Requests output of the number of data items it is possible to store.

Syntax

OM <terminator>

Response Example

FREE2000 <terminator>

ORD

Requests output of the recall data.

Syntax

ORDm, n <terminator>

“m” represents the number of the first memory location to be recalled.

m=1 to 9999

“n” represents the number of the last memory location to be recalled.

n=1 to 9999(n≥m)

Description

- Cannot execute unless in recall mode. An error 15 occurs.
- 100 data can be output at one time. If a memory data higher than 100 is specified, only the first 100 data will be output.
- If the end memory number is smaller than the start memory number, error 12 occurs.
- Refer to page App-15, “Output Format for Recall Data.”

OS

Requests output of the setting information.

Syntax

OS<terminator>

Description

Refer to page App-15, “Output Format for Panel Setting Information.”

PD/PD?

Sets the number of display digits for the measured pressure value and the value to be displayed in %, and queries the current setting.

Syntax

PDm<terminator>

“m” represents the number of display digits.

0: Measured pressure value in 5-1/2 digits, % value in 4-1/2 digits

1: Measured pressure value in 4-1/2 digits, % value in 3-1/2 digits

Query

PD?<terminator>

Response Example

PD0

Description

In the case of 700 kPa models (767355/767365/767373/767385), “m” represents the number of display digits as follows:

0: Measured pressure value in 4-1/2 digits, % value in 4-1/2 digits

1: Measured pressure value in 3-1/2 digits, % value in 3-1/2 digits

PU/PU?

Sets the units of pressure and queries the current setting.

Syntax

PUm<terminator>

The value “m” is the unit of pressure.

1: inH₂O (available with the -U3 model)

2: inHg (available with the -U3 model)

3: psi (available with the -U3 model)

4: kPa

5: kgf/cm² (available with the -U2 and -U3 models)

6: mmH₂O (available with the -U2 and -U3 models)

7: mmHg (available with the -U2 and -U3 models)

Query

PU?<terminator>

Response Example

PU4

Description

- The available settings vary depending on the pressure units specification code you selected at the time of purchase.
- The units cannot be changed when in % or %ERROR display mode. An error 15 occurs.

PZ

Performs zero calibration for pressure measurement.

Syntax

PZ<terminator>

Description

- As shown below, if the reference pressure value is wrong, zero calibration cannot be performed. An error 17 occurs.
- An overrange occurred in the measured pressure value (and "--OL-" was displayed).
- When using an absolute pressure model (767357/767367/767387), the value differs from the factory default by more than 1 kPa.
- Cannot execute in recall mode. An error 14 occurs.

RC

Initializes the setup information.

Syntax

RC<terminator>

REL/REL?

Sets the relative display and queries the current setting.

Syntax

RELM<terminator>

"m" represents the display setting.

0: OFF

1: ON

Query

REL?<terminator>

Response Example

REL0

Description

- When an overrange occurred in the measured pressure value (and "--OL-" was displayed), the relative display could not be turned ON. An error 15 occurs.
- The relative value cannot be displayed when in % or %ERROR display mode. An error 15 occurs.
- Cannot change in recall mode. An error 14 occurs.

RNO/RNO?

Sets the memory Number to be recalled/queries the current setting.

Syntax

RNO m <terminator>

"m" represents the memory Number to be recalled.

m=1 to 9999

Description

Cannot set unless in recall mode. An error 15 occurs.

RO/RO?

Turns recall mode ON and OFF/queries the current setting.

Syntax

RO m <terminator>

"m" represents ON/OFF for recall mode.

0: Recall mode is OFF

1: Recall mode is ON

Query

RO? <terminator>

Response Example

RO0

SI/SI?

Sets the sampling rate and queries the current setting.

Syntax

SI m <terminator>

"m" represents the sample rate.

0: 250 ms

1: 4 s

Query

SI?<terminator>

Response Example

SI0

Description

- The sampling rate can only be changed on the 767370 (1 kPa differential model).
This setting is not available on other models. An error 11 occurs.
- When the pressure sampling rate is set to 4 s (SI1), the pressure averaging is simultaneously set to OFF.

SM/SM?

Makes store mode setting/queries the current setting.

Syntax

SM m <terminator>

“m” represents the type of store mode.

0: Manual store mode

1: Auto store mode

Query

SM? <terminator>

Response Example

SM0

Description

Cannot be changed during auto store.
An error 14 occurs.

SND/SND?

Sets the number of data to be stored in auto store mode/queries the current setting.

Syntax

SND m <terminator>

“m” represents the Number of data items to be stored.

m=1 to 2000

Query

SND? <terminator>

Response Example

SND20

Description

Cannot be changed during auto store.
An error 14 occurs.

SNO/SNO?

Sets the store destination memory number/queries the current setting.

Syntax

SNO m <terminator>

“m” represents the store destination memory Number

m=1 to 9999

Query

SNO? <terminator>

Response Example

SN01

Description

Cannot be changed during auto store.
An error 14 occurs.

SR/SR?

Sets the store interval for auto store/queries the current setting.

Syntax

SR m <terminator>

“m” represents the store interval.

0: Stores each time one data item is sampled.

1: Stores one data item for every four sampled.

2: Stores one data item for every 16 sampled.

3: Stores one data item for every 64 sampled.

4: Stores one data item for every 512 sampled.

Query

SR? <terminator>

Response Example

SR0

Description

Cannot be changed during auto store.
An error 14 occurs.

SO/SO?

Sets whether to start or stop data storage in auto store mode/queries the current setting.

Syntax

SO m <terminator>

“m” represents whether data storage is to be started or stopped.

0: Stops (aborts) data storage.

1: Starts data storage.

Query

SO? <terminator>

Response Example

SO0

Description

- Cannot execute in manual store mode. An error 14 occurs.
- Cannot change in recall mode. An error 14 occurs.

ST

Stores data in manual store mode.

Syntax

ST <terminator>

Description

- Cannot execute in auto store mode. An error 14 occurs.
- Cannot execute in recall mode. An error 14 occurs.

SY/SY?

Sets DMM calibration mode and normal measurement mode and queries the current setting.

Syntax

SYm<terminator>

“m” represents the system mode.

0: Normal measurement mode

1: DMM calibration mode

Query

SY? <terminator>

Response Example

SY0

Description

- DMM calibration mode cannot be set if the DMM function is OFF. An error 16 occurs.
- DMM calibration mode cannot be set when data is on hold. An error 15 occurs.
- DMM calibration mode cannot be set when in recall mode. An error 14 occurs.

VO/VO?

Turns 24 VDC output ON and OFF and queries the current setting.

Syntax

VO m <terminator>

“m” represents ON/OFF of 24 VDC output.

0: 24 VDC output is OFF

1: 24 VDC output is ON

Query

VO? <terminator>

Response Example

VDO

Status Byte Format

GP-IB (Response to the Serial Poll)

DI08	DI07	DI06	DI05	DI04	DI03	DI02	DI01
0 (fixed)	SRQ	ERROR	24 VOUT -OL-	OVER	Syntax Error	Auto store END	Calcula- tion END

SRQ (DIO 7)

This bit is set to 1 when a computation END, syntax ERROR, or OVER occurs, and SRQ is set to True, thereby issuing a service request to the controller.

ERROR (DIO 6)

When a syntax ERROR, or OVER occurs, this bit is set to 1.

24VOUT-OL- (DIO 5)

When an overload occurs while 24 VDC is being output, thereby forcing the 24 VDC output to turn OFF, this bit is set to 1.

OVER (DIO 4)

This bit is set to 1 when an overrange occurs in the measured data or when a computation overflow occurs. The status of OVER can be identified using the OE command.

Syntax ERROR (DIO 3)

This bit is set to 1 when a command error, parameter error, or execution error occurs. The nature of the syntax error can be identified using the OE command.

Auto store END (DIO 2)

This bit is set to 1 when the measured or computed data has been stored in auto store mode.

Computation END (DIO 1)

This bit is set to 1 when computation has been completed and the display is updated.

Note

- After the status byte responds to the serial poll from the controller, this bit is reset to 0. Until the serial poll is responded to, each interrupt is stored, and if more interrupts occur thereafter, they are added.
 - To prevent the SRQ and status byte being affected by a computation END, syntax ERROR, or OVER, use the IM command to set a value with the corresponding bits set to 0.
 - When you are creating a communications program using the status byte, make sure that the SRQ bit is set to 1 as well as the bit corresponding to the interrupt. In this way you can acknowledge interrupts by issuing a serial poll continuously, instead of by using an SRQ interrupt.
-

RS-232 (Response to the <ESC>S Command)

DI08	DI07	DI06	DI05	DI04	DI03	DI02	DI01
0 (fixed)	1 (fixed)	ERROR	24 VOUT -OL-	OVER	Syntax Error	Auto store END	Calcula- tion END

For DIO1 to DIO6, the status byte format is identical to that used for the GP-IB interface. For details, refer to page App-12.

Note

- After the status byte responds to the serial poll from the controller, this bit is reset to 0. Until the serial poll is responded to, each interrupt is stored, and if more interrupts occur thereafter, they are added.
- To prevent the status byte being affected by a computation END, syntax ERROR, or OVER, use the "IM" command to set a value with the corresponding bits set to 0.

Data Output Format**Output Format for Measurement and Computation Data (Response to the "OD" Command)****Data Format**

Each data consists of a 4-byte header and 8 bytes of data.

You can specify whether a header is output using the H command.

Header	Data
--------	------

Header Section

The header section consists of four bytes (h1 to h4). □ indicates a space.

h1	h2	h3	h4
----	----	----	----

h1 to h3:

KPA: Pressure (kPa)
 KGF: Pressure (kgf/cm²)
 MHO: Pressure (mmH₂O)
 MHG: Pressure (mmHg)
 IHO: Pressure (inH₂O)
 IHG: Pressure (inHg)
 PSI: Pressure (psi)
 PP □: Pressure %

Data type h4: Data state

N: Normal measured data
 I: Overrange data
 O: Computation overflow
 E: No data

DMM Header (MT220 Only)**h1 to h3: Data type**

V □ □: DC voltage (V)
 A □ □: DC current (mA)
 PV □: DC voltage %
 PA □: DC current %
 ERR: Error %

h4: Data state

N: Normal measured data
 I: Overrange data
 O: Computation overflow
 F: No DMM data when DMM function is off
 E: No data

Data Section

The data section consists of 8 bytes (d1 to d8).

d1	d2	d3	d4	d5	d6	d7	d8
----	----	----	----	----	----	----	----

d1: Polarity, (space), or – (minus)
 d2 to d8: Up to 6 digits + decimal point

Data state in the case of an overrange (“- - 0 L - -” is displayed.)

h1	h2	h3	I	□	9	9	9	9	9	9	.
----	----	----	---	---	---	---	---	---	---	---	---

Data state in the case of a computation overflow (“- - 0 F - -”, “SPnErrr” is displayed.)

h1	h2	h3	0	□	8	8	8	8	8	8	.
----	----	----	---	---	---	---	---	---	---	---	---

Data state when there is no data (“- - - - -” is displayed.)

h1	h2	h3	E	□	8	8	8	8	8	8	.
----	----	----	---	---	---	---	---	---	---	---	---

Data state on the DMM side when the DMM function is off

h1	h2	h3	F	□	8	8	8	8	8	8	.
----	----	----	---	---	---	---	---	---	---	---	---

Output Format

For the MT210/MT210F

Pressure header	Pressure data	Terminator
-----------------	---------------	------------

Output Examples

KPAN □ 130.000

For the MT220

Pressure header	Pressure data	,	DMM header	DMM data	Terminator
-----------------	---------------	---	------------	----------	------------

Output Examples

- Normal measurement
 KPAN □ 130.000, V □ □ N □ □ 04.0000
- % display
 PP □ N □ 0100.00, PV □ N □ 0075.00
- Error display
 PP □ N □ 0100.00, ERRN □ 0025.00
- DMM function OFF, normal display
 KPAN □ 130.000, V □ □ F □ 888888.
- Normal display (no header)
 □ 130.000, □ 05.0000

Output Format for Recalled Data (Response to the “ORD” Command, MT220 Only)

Data Number

h1	h2	h3	h4	d1	d2	d3	d4
----	----	----	----	----	----	----	----

h1-h3

NO.: Recall data number

h4

└: Recall data is present.

E: No recall data is present.

d1-d4

4 digit number (recall data number)

Output Format

Data number	,	Pressure header	Pressure data	,	DMM header	DMM data	Terminator
-------------	---	-----------------	---------------	---	------------	----------	------------

Output Examples

- DMM function OFF, normal display of recall data
NO. └ 0001, KPAN └ 130.000, V └ └ N └ 05.0000
- No recall data
NO.E0002, KPAE └ 888888., V └ └ E └ 888888.

Output Format of Setup Information (Response to the “OS” Command)

For the MT210/MT210F

1st line: Model, software version number.

2nd line: Pressure setup information

3rd line: Measurement condition

4th line: Backlight and beep

5th line^{*1}: D/A output and comparator settings

6th line: Output end

*1: Line 5 is output only when the D/A output option (/DA) is installed.

Example of response

MDL767313;REV1.01

REL0;PU4;PDO

HD0;AG1

BL0;BP1

DR0;CMP0;CMD0.000,130.000

END

For the MT220

1st line: Model, software version number

2nd line: Pressure set-up information

3rd line: DMM set-up information

4th line: Measurement conditions

5th line: Power output, back light, beep

6th line: Data memory function

7th line^{*2}: D/A output and comparator settings

8th line: Output end

*2: 7th line output only with the D/A output option (/DA) installed

Example of response

```
MDL767303;REV1.01
RELO;PU4;PD0;ML4,0.000;MH4,130.000
DMM1;DF1
HD0;AG3;DIS0
VOOL;BL0;BP1
SM0;SN01;SR0;SND20
DR0;CMP0;CMD0.000,130.000
END
```

Sample Program**Operating Environment**

Target model: NEC PC-9801 Series
 Target language: N88-BASIC (standard program language on the PC-9801 Series)
 GP-IB board: PC-9801-29N interface board

```
10  \*****
20  \*   Program that reads/displays the measured data 10 times (GP-IB)'   *
30  \*****
40  \
100 ISET IFC           \ interface/clear
110 ISET REN          \ set remote
120 CMD DELIM=0       \controller side delimiter = CR+LF
130 IO=1              \Address=1
140 \
150 PRINT @IO;"PU4"   \Pressure units = kPa
160 PRINT @IO;"H1"   \Communications output data header present
170 PRINT @IO;"DL0"  \Communications output delimiter=CR+LF+EOI
180 \
190 FOR I=1 TO 10     \read measured data ten times
200   INPUT WAIT 10," ",A \wait (random)
210   PRINT @IO;"OD"   \measured data output request
220   LINE INPUT @IO;D$ \read measured data
230   PRINT D$         \display measured data
240 NEXT I
250 \
260 \
300 \*****
310 \*   Program that reads data using trigger and serial poll (GP-IB)'   *
320 \*****
330 \
340 PRINT @IO;"HD1"   \data hold
350 \
360 PRINT @IO;"IM1"   \status byte mask
370 POLL IO,STB      \status byte initialization
380 \
390 FOR I=1 TO 10     \read measured data ten times
400   PRINT @IO;"E"   \activates trigger
410   POLL IO,STB     \send serial poll
420   IF (STB AND &H41)<>&H41 THEN 410 \check whether measurement has finished
430   PRINT @IO;"OD"   \measured data output request
440   LINE INPUT @IO;D$ \read measured data
450   PRINT D$         \display measured data
460 NEXT I
470 \
480 PRINT @IO;"HD0"   \release data hold
```

```

490 `
500 IRESET REN `cancel remote
510 STOP `exit
520 END

10 `*****
20 `* Program that reads/displays the measured data 10 times (RS-232) *
30 `*****
40 `
100 OPEN "COM:N81NN" AS #1 `open line
110 PRINT #1,CHR$( &H1B)+"R" `set remote
120 `
130 PRINT #1,"PU4" `pressure units = kPa
140 PRINT #1,"H1" `communications output data header present
150 PRINT #1,"DL0" `communications output delimiter=CR+LF
160 `
170 FOR I=1 TO 10 `read measured data ten times
180 INPUT WAIT 10," ",A `wait (random)
190 PRINT #1,"OD" `measured data output request
200 LINE INPUT #1,D$ `read measured data
210 PRINT D$ `display measured data
220 NEXT I
230 `
240 `
300 `*****
310 `* Program that reads data using trigger and serial poll (RS-232) *
320 `*****
330 `
340 PRINT #1,"HD1" `data hold
350 `
360 PRINT #1,"IM1" `status byte mask
370 PRINT #1,CHR$( &H1B)+"S" `status byte initialization
380 LINE INPUT #1,B$
390 `
400 FOR I=1 TO 10 `read measured data ten times
410 PRINT #1,"E" `activates trigger.
420 PRINT #1,CHR$( &H1B)+"S" `read status byte
430 LINE INPUT #1,B$
440 STB=ASC (LEFT$( B$,1))
450 IF (STB AND &H41)<>&H41 THEN 420 `check whether measurement has finished
460 PRINT #1,"OD" `measured data output request
470 LINE INPUT #1,D$ `read measured data
480 PRINT D$ `display measured data
490 NEXT I
500 `
510 PRINT #1,"HD0" `release data hold
520 `
530 PRINT #1,CHR$( &H1B)+"L" `cancel remote
540 CLOSE #1 `close line
550 `
560 STOP `exit
570 END

10 `*****
20 `* DMM calibration program (voltage calibration) *
30 `*****
40 `
100 ISET IFC ISET REN `set remote
110 CMD DELIM=0: IO=1 `address=1
120 `
130 POLL IO,STB `status byte initialization
140 PRINT @IO;"IM4" `status byte mask
150 `
160 PRINT @IO;"SY1" : INPUT WAIT 10," ",A `enter calibration mode
170 PRINT @IO;"CAL1" `calibrating the voltage

```

```

180 GOSUB *CHECKSYNTAX           `error check
190 `
200 *CAL1
210 PRINT @IO;"CVP1"             `calibration point = 0
220 PRINT "Set standard equipment output to 0 V.""
230 INPUT "Press Return. ",K$
240 PRINT @IO;"CVD0" : INPUT WAIT 30," ",A`calibration point value = 0.00000 (fixed)
250 GOSUB *CHECKSYNTAX           `error check
260 LINE INPUT @1;D$ : E$=MID$(D$,5,8) `read measured value
270 PRINT "The current measured value is ";E$;" (V)."
```

```

280 PRINT "OK? <Y/N>"
290 Q$=INPUT$(1) : PRINT : IF Q$<>"Y" AND Q$<>"y" THEN *CAL1
300 *CAL2
310 PRINT @IO;"CVP2"             `calibration point = +FS
320 PRINT "Set standard equipment output to 5 V.""
330 INPUT "Input the value output from the standard equipment. -> ",K$
340 PRINT @IO;"CVD"+K$ : INPUT WAIT 30," ",A `set the calibration point value
350 GOSUB *CHECKSYNTAX           `error check
360 LINE INPUT @1;D$ : E$=MID$(D$,5,8) `read measured value
370 PRINT "The current measured value is ";E$;" (V)."
```

```

380 PRINT "OK? <Y/N>"
390 Q$=INPUT$(1) : PRINT : IF Q$<>"Y" AND Q$<>"y" THEN *CAL2
400 *CAL3
410 PRINT @IO;"CVP3"             `calibration point = -FS
420 PRINT "Set standard equipment output to -5 V."
430 INPUT "Input the value output from the standard equipment. -> ",K$
440 PRINT @IO;"CVD"+K$ : INPUT WAIT 30," ",A `set the calibration point value
450 GOSUB *CHECKSYNTAX           `error check
460 LINE INPUT @1;D$ : E$=MID$(D$,5,8) `read measured value
470 PRINT "The current measured value is ";E$;" (V)."
```

```

480 PRINT "OK? <Y/N>"
490 Q$=INPUT$(1) : PRINT : IF Q$<>"Y" AND Q$<>"y" THEN *CAL3
500 *CAL4
510 PRINT "The correction coefficient will be calculated, and the result will be
written to the EEPROM."
520 PRINT "OK? <Y/N>"
530 Q$=INPUT$(1) : PRINT : IF Q$<>"Y" AND Q$<>"y" THEN *CALEND
540 PRINT @IO;"CVP0" : INPUT WAIT 20," ",A `Writing correction coefficient to EEPROM
550 GOSUB *CHECKSYNTAX           `error check
560 PRINT "Calibration finished" : GOTO *CALEND
570 `
580 *CHECKSYNTAX `error checking subroutine
590 POLL IO,STB `send serial poll
600 IF (STB AND &H64)<>&H64 THEN RETURN `check for syntax error
610 PRINT @IO;"OE" `requests output of error number
620 LINE INPUT @IO;D$ `reads error number
630 PRINT "error occurred. ";D$
640 `
650 *CALEND
660 PRINT @IO;"SY0" `returns to normal measurement mode.
670 IRESET REN `cancel remote
680 STOP `exit
690 END
```

Index

Symbol	Page
--------	------

% Display.....	41
%ERROR display	42
24 VDC Output.....	40

A	Page
---	------

Accessories	7
Addressable mode.....	52
Auto %	42
Auto 100%.....	42
Auto Store.....	43
Averaging function.....	14

B	Page
---	------

back light	33
Backup.....	25, 27
Battery pack.....	46
Charging the Ni-Cd batteries.....	47
Checking the remaining life of the battery pack.....	47
Life of the Ni-Cd battery.....	48
Replacing the Ni-Cd batteries.....	49

C	Page
---	------

Calibrating the DMM Function	64
Calibrating the Pressure Measurement Function	64
Command list.....	App-1
Communications command list.....	App-2
Computed data	51

D	Page
---	------

Data hold function.....	33
Data Recall.....	44
Default settings.....	27
Deleting Data.....	45
DMM Function	41

E	Page
---	------

Error codes	62
External DC power connector.....	23
external DC power supply	23
External dimensions	74

F	Page
---	------

Front panel	16
Fuse Position and Replacement Method.....	67
Fuse ratings.....	67

G	Page
---	------

GP-IB interface	
Listener.....	51
Remote mode.....	52
Response to the serial poll	App-12
Specifications	51
Status byte format	App-12
Talker	51
Talk-only function.....	53

H	Page
---	------

Handshaking.....	57
------------------	----

I	Page
---	------

Initializing settings	27
Input function	29
Input port	31

M	Page
---	------

MAIN POWER switch	13, 19, 24
Manual Store	44
MODEL (Type Name).....	6

O	Page
---	------

Opening messages.....	26
Optional accessories	8
overload.....	40

P	Page
---	------

Power switch	13
POWER switch	13, 17, 24
Pressure input port	17

R	Page
---	------

Rear panel	18
Recall Mode.....	44
Relative display	32
Replacing the fuse.....	66
RS-232 interface	
Baud rate.....	59
Commands	60
Data output format.....	App-13
Handshaking.....	56
Handshaking method.....	59
Normal or talk-only mode	59
Output format for measurement and computation data.....	App-13
Response to the <ESC>S command.....	App-13
Specific Commands.....	60

Index

S	Page
Sample program	App-16
Selecting the number of display digits	32
Selecting the units	32
Self-test	25
Specifications	68
Standard accessories	7
Storing Data.....	43
SUFFIX.....	7
Suffix code.....	7
Supplying AC Power	22
Supplying DC Power	23
System Block Diagram	12

T	Page
Talk-Only Mode.....	52
Terminator.....	61
Trigger	33
Turning the ata Hold Function ON/OFF.....	33

Z	Page
ZERO CAL.....	28
Zero calibration.....	28