

No. MX14

# Double End MAGNUM bit

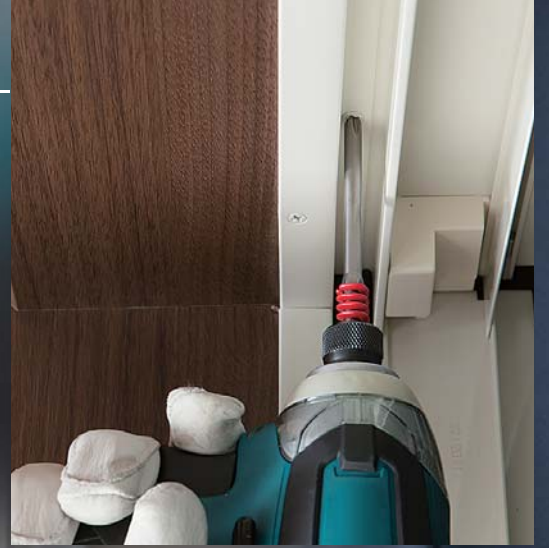

Under the theme of "problem solution", these bits have been developed.

Torsion bit which absorbs excessive load and impact, for improvement in durability; Jaws fit bit which hold a screw firmly; Slender bit which allows for easy visibility around the tip, etc.

Now Magnum bit has come along, which has definitely strong resistance to breakage and distortion by introducing the tip with reinforced ribs developed, using new technology.

Ribs protect the tip firmly!  
Strong resistance to torsion!

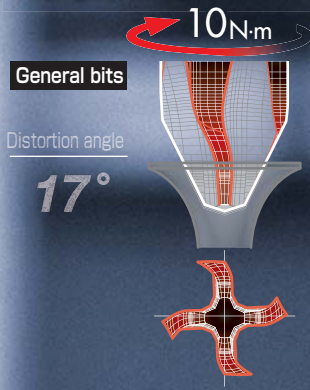

**MAGNUM**

Torsion angle

**11°**

Tip with reinforced ribs  
PAT.

**No. MX14**

## Double End MAGNUM bit

Long life with ribbed tip and torsion  
Plastic spring facilitates bit replacement.



## No. MX14 Double End MAGNUM bit 2-Piece Set PAT.

- Long life with ribbed tip and torsion.
- Plastic spring facilitates bit replacement.

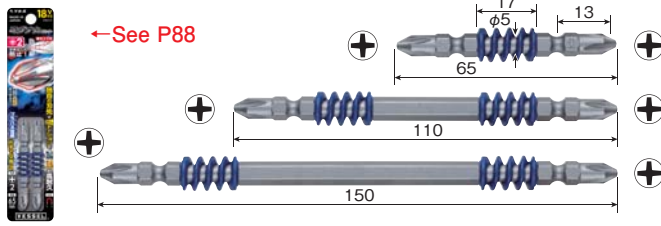

Model No.	Contents	Heat treatment classification	Card size (mm)	EDP No.
MX142065	⊕2×φ5× 65 2pcs.	H	160×35×8	485031
MX142110	⊕2×φ5×110 2pcs.	H	160×35×8	485033
MX142150	⊕2×φ5×150 2pcs.	H	210×35×8	485034

Inner Ctn.: 10 sets

## No. MX5P Double End MAGNUM bit 5-Piece Set PAT.



MX5P2065 MX5P2110



Model No.	Contents	Heat treatment classification	Card size (mm)	EDP No.
MX5P2065	⊕2×φ5× 65 5pcs.	H	160×70×8	485051
MX5P2110	⊕2×φ5×110 5pcs.	H	160×70×8	485052

Inner Ctn.: 10 sets

## No. MX16 Recessed MAGNUM bit 2-Piece Set PAT.

- Long life with ribbed tip and torsion.
- Plastic spring facilitates bit replacement.

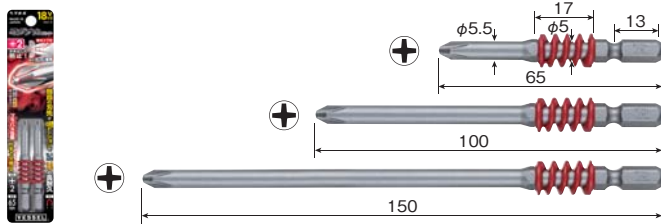

Model No.	Contents	Heat treatment classification	Card size (mm)	EDP No.
MX162065	⊕2×φ5× 65 2pcs.	H	160×35×8	485035
MX162100	⊕2×φ5×100 2pcs.	H	160×35×8	485037
MX162150	⊕2×φ5×150 2pcs.	H	210×35×8	485038

Inner Ctn.: 10 sets

## No. MX5P Recessed MAGNUM bit 5-Piece Set PAT.



MX5P2065D MX5P2100D



Model No.	Contents	Heat treatment classification	Card size (mm)	EDP No.
MX5P2065D	⊕2×φ5× 65 5pcs.	H	160×70×8	485053
MX5P2100D	⊕2×φ5×100 5pcs.	H	160×70×8	485054

Inner Ctn.: 10 sets

## No. RT "SUPER TORSION BIT" 2-Piece Set PAT.

- Tapered tip allows for easy view of small screw head.
- Combination of strong tip-end and torsion which is suitable for heavy works.
- Ultra Hex shank avoids damage to the chuck.

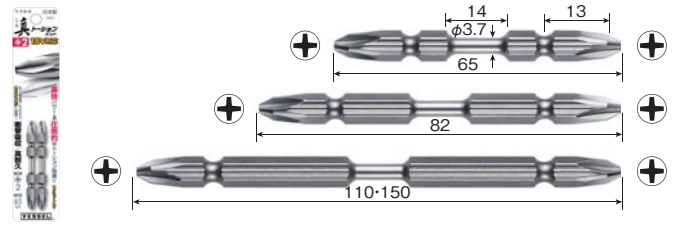

Model No.	Contents	Heat treatment classification	Card size (mm)	EDP No.
RT142065	⊕2×φ3.7× 65 2pcs.	X	160×35×8	484461
RT142082	⊕2×φ3.7× 82 2pcs.	X	160×35×8	484462
RT142110	⊕2×φ3.7×110 2pcs.	X	160×35×8	484463
RT142150	⊕2×φ3.7×150 2pcs.	X	210×35×8	484464

Inner Ctn.: 10 sets

## No. RT5P "SUPER TORSION BIT" 5-Piece Set PAT.

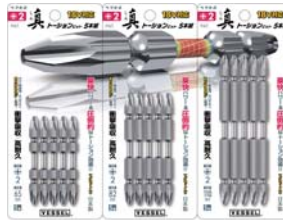

RT5P2065 RT5P2082 RT5P2110



Model No.	Contents	Heat treatment classification	Card size (mm)	EDP No.
RT5P2065	⊕2×φ3.7× 65 5pcs.	X	160×70×8	484471
RT5P2082	⊕2×φ3.7× 82 5pcs.	X	160×70×8	484472
RT5P2110	⊕2×φ3.7×110 5pcs.	X	160×70×8	484473

Inner Ctn.: 10 sets

## No. RT10P "SUPER TORSION BIT" 10-Piece Set PAT.



RT10P2065F RT10P2082F RT10P2110F



Model No.	Contents	Heat treatment classification	Card size (mm)	EDP No.
RT10P2065F	⊕2×φ3.7× 65 10pcs.	X	143×87×7	413441
RT10P2082F	⊕2×φ3.7× 82 10pcs.	X	143×87×7	413442
RT10P2110F	⊕2×φ3.7×110 10pcs.	X	162×87×7	413443

Inner Ctn.: 10 sets



**No. MT MEGA TORSION BIT 2-Piece Set PAT.**

- Jaws fit tip fits screw head hole.
- Torsion design suitable for heavy works.

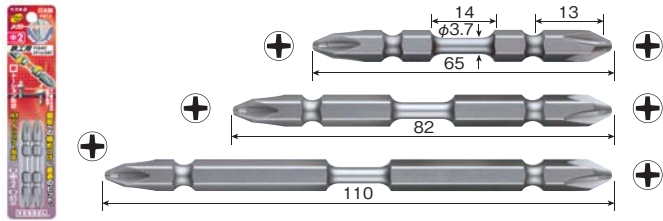

Model No.	Contents	Heat treatment classification	Card size (mm)	EDP No.
MT142065	⊕2×φ3.7× 65 2pcs.	X	160×35×8	484435
MT142082	⊕2×φ3.7× 82 2pcs.	X	160×35×8	484436
MT142110	⊕2×φ3.7×110 2pcs.	X	160×35×8	484437

**No. MT5P MEGA TORSION BIT 5-Piece Set PAT.**

Inner Ctn.: 10 sets



Model No.	Contents	Heat treatment classification	Card size (mm)	EDP No.
MT5P2065	⊕2×φ3.7× 65 5pcs.	X	160×70×8	484440
MT5P2082	⊕2×φ3.7× 82 5pcs.	X	160×70×8	484441
MT5P2110	⊕2×φ3.7×110 5pcs.	X	160×70×8	484442

Inner Ctn.: 10 sets

**No. AT TORSION BIT 2-Piece Set**

- Absorbs efficiently the impact caused when screws are fully seated.
- Torsion design suitable for tightening wood screws.

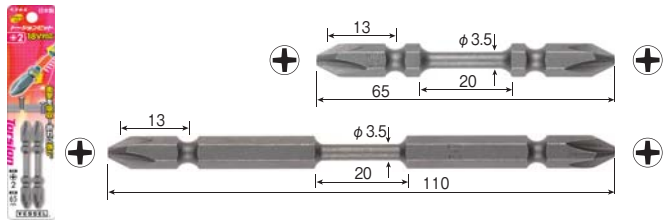

Model No.	Contents	Heat treatment classification	Card size (mm)	EDP No.
AT142065	⊕2×φ3.5× 65 2pcs.	H	160×35×8	486113
AT142110	⊕2×φ3.5×110 2pcs.	H	160×35×8	486114

Inner Ctn.: 10 sets

**No. BW TORSION BIT 5-Piece Set**



Model No.	Contents	Heat treatment classification	Card size (mm)	EDP No.
BW-163	⊕2×φ3.5× 65 5pcs.	H	140×70×23	486306
BW-164	⊕2×φ3.5×110 5pcs.	H	140×70×23	486307
BW-165	⊕2×φ3.5× 65 3pcs. ⊕2×φ3.5×110 2pcs.	H	140×70×23	486308

Provided with one bit holder. Outer Ctn.: 10 sets

**No. ST SLENDER TORSION BIT 2-Piece Set PAT.**

- Absorbs efficiently the impact caused when screws are fully seated.
- Tapered finished tip fits to slim screws.
- Torsion design suitable for tightening wood screws.

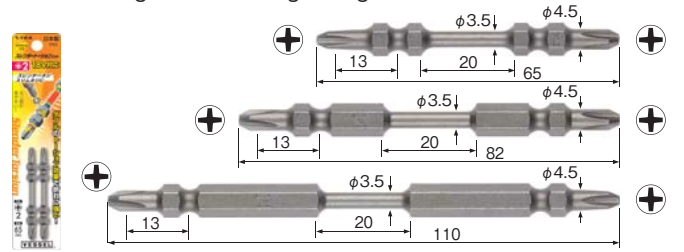

Model No.	Contents	Heat treatment classification	Card size (mm)	EDP No.
ST141065	⊕1×φ3.5× 65 2pcs.	H	160×35×8	484400
ST142065	⊕2×φ3.5× 65 2pcs.	H	160×35×8	484401
ST142082	⊕2×φ3.5× 82 2pcs.	H	160×35×8	484403
ST142110	⊕2×φ3.5×110 2pcs.	H	160×35×8	484402

Inner Ctn.: 10 sets

**No. BW SLENDER TORSION BIT 5-Piece Set PAT.**



Model No.	Contents	Heat treatment classification	Card size (mm)	EDP No.
BW-301	⊕2×φ3.5× 65 5pcs.	H	140×70×23	486691
BW-302	⊕2×φ3.5×110 5pcs.	H	140×70×23	486692
BW-303	⊕2×φ3.5× 65 3pcs. ⊕2×φ3.5×110 2pcs.	H	140×70×23	486693
BW-305	⊕2×φ3.5× 82 5pcs.	H	140×70×23	486694

Provided with one bit holder. Outer Ctn.: 10 sets

**No. AC CUSHION BIT 2-Piece Set PAT.**

- Cushion ring is attached to reduce vibration.
- UltraHex shank avoids damage to the chuck.

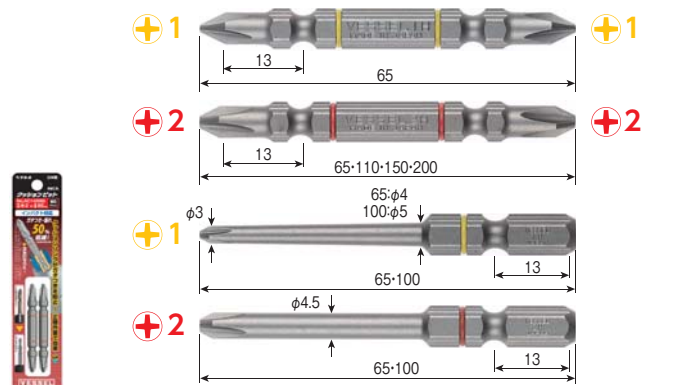

Model No.	Contents	Heat treatment classification	Card size (mm)	EDP No.
AC141065	⊕1× 65 2pcs.	H	160×35×8	484376
AC142065	⊕2× 65 2pcs.	H	160×35×8	484378
AC142110	⊕2×110 2pcs.	H	160×35×8	484379
AC142150	⊕2×150 2pcs.	H	210×35×8	484380
AC142200	⊕2×200 2pcs.	H	260×35×8	484381
AC161065	⊕1×φ4 × 65 2pcs.	H	160×35×8	484386
AC161100	⊕1×φ5 ×100 2pcs.	H	160×35×8	484387
AC162065	⊕2×φ4.5× 65 2pcs.	H	160×35×8	484388
AC162100	⊕2×φ4.5×100 2pcs.	H	160×35×8	484389

\*Colors inside the table cells indicate the ring color.

Inner Ctn.: 10 sets

HAND TOOLS

BITS & SOCKETS

ELECTRIC TOOLS

AIR TOOLS

STATIC SOLUTIONS

GASOLINE ENGINE TOOLS

## No. AS SLENDER BIT 2-Piece Set

- Tapered finished tip fits to slim screws.
- For soft joint such as wood screws and resin tapping screws.



Model No.	Contents	Heat treatment classification	Card size (mm)	EDP No.
AS141065	⊕1× 65 2pcs.	H	160×35×8	486187
AS142045	⊕2× 45 2pcs.	H	160×35×8	486186
AS142065	⊕2× 65 2pcs.	H	160×35×8	486184
AS142110	⊕2×110 2pcs.	H	160×35×8	486185

Inner Ctn.: 10 sets

## No. BW SLENDER BIT 5-Piece Set



BW-180 BW-181 BW-182



Model No.	Contents	Heat treatment classification	Card size (mm)	EDP No.
BW-180	⊕2× 65 5pcs.	H	140×70×23	486650
BW-181	⊕2×110 5pcs.	H	140×70×23	486651
BW-182	⊕2× 65 3pcs. ⊕2×110 2pcs.	H	140×70×23	486652

Provided with one bit holder. Outer Ctn.: 10 sets

## No. AS5P SLENDER BIT 5-Piece Set



AS5P1065F AS5P2065F  
AS5P2110F



Model No.	Contents	Heat treatment classification	Card size (mm)	EDP No.
AS5P1065F	⊕1× 65 5pcs.	H	135×50×7	485441
AS5P2065F	⊕2× 65 5pcs.	H	135×50×7	485442
AS5P2110F	⊕2×110 5pcs.	H	160×50×7	485443

Inner Ctn.: 10 sets

## No. AS20P SLENDER BIT 20-Piece Set



AS20P2065F AS20P2110F



Model No.	Contents	Heat treatment classification	Card size (mm)	EDP No.
AS20P2065F	⊕2× 65 20pcs.	H	143×87×14	484481
AS20P2110F	⊕2×110 20pcs.	H	162×87×14	484482

Inner Ctn.: 5 sets

# One point

## Bit Selection

- Different tip-end for various application.

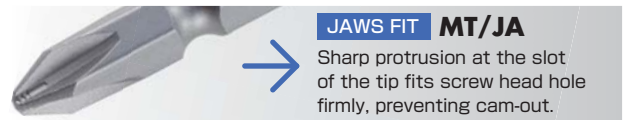
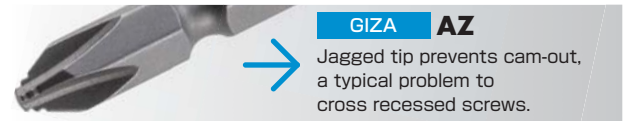

- Selection according to torsion effect

**AL**

Ball groove

Impact is absorbed with the torsion effect at the tempered groove part.

**HARD JOINT**

**SOFT JOINT**

**AT/ST**

φ3.5

20mm

Impact is absorbed by the torsion part (φ3.5 × 20mm).

**SOFT JOINT**

**HARD JOINT**

**RT/MT**

φ3.7

14mm

Impact is absorbed by the torsion part (φ3.7 × 14mm).

**HARD JOINT**

**SOFT JOINT**

When an instantaneous impact is given when the head of drill screw or tapping screw is fully seated

When the load is gradually increased such as in fastening wood screws

**No. JA JAWS BIT 2-Piece Set PAT.**

- Jaws Fit tip fits screw head hole.
- Reliable work possible as this tip prevents screws from falling over.

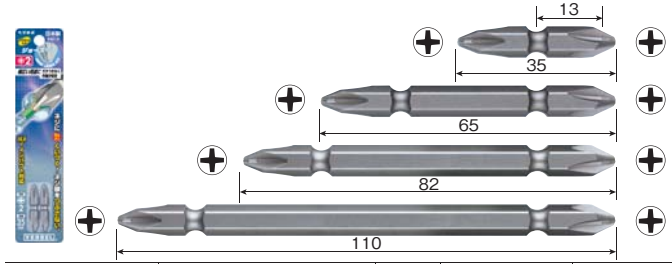

Model No.	Contents	Heat treatment classification	Card size (mm)	EDP No.
JA142035	⊕2× 35 2pcs.	H	160×35×8	484450
JA142065	⊕2× 65 2pcs.	H	160×35×8	484451
JA142082	⊕2× 82 2pcs.	H	160×35×8	484452
JA142110	⊕2×110 2pcs.	H	160×35×8	484453

**No. JA5P JAWS BIT 5-Piece Set PAT.** Inner Ctn.: 10 sets



Model No.	Contents	Heat treatment classification	Card size (mm)	EDP No.
JA5P2065	⊕2× 65 5pcs.	H	160×70×8	484456
JA5P2082	⊕2× 82 5pcs.	H	160×70×8	484457
JA5P2110	⊕2×110 5pcs.	H	160×70×8	484458

**No. AX EXTRA HARD BIT 2-Piece Set**

- The highest hardness of 62HRC, suited for stainless screws and plaster board screws.

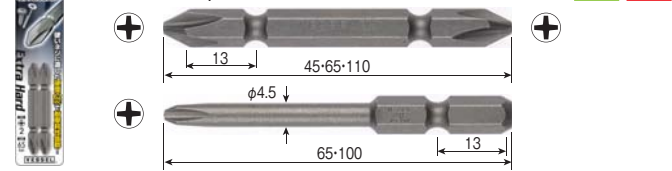

Model No.	Contents	Heat treatment classification	Card size (mm)	EDP No.
AX142045	⊕2× 45 2pcs.	X	160×35×8	486192
AX142065	⊕2× 65 2pcs.	X	160×35×8	486193
AX142110	⊕2×110 2pcs.	X	160×35×8	486194
AX162065	⊕2×φ4.5× 65 2pcs.	X	160×35×8	486195
AX162100	⊕2×φ4.5×100 2pcs.	X	160×35×8	486196

**No. BW EXTRA HARD BIT 5-Piece Set** Inner Ctn.: 10 sets



Model No.	Contents	Heat treatment classification	Card size (mm)	EDP No.
BW-36	⊕2× 65 5pcs.	X	140×70×23	486596
BW-37	⊕2×110 5pcs.	X	140×70×23	486597
BW-38	⊕2×φ4.5× 65 5pcs.	X	140×70×23	486598
BW-39	⊕2×φ4.5×100 5pcs.	X	140×70×23	486599

**No. AZ GIZA BIT 2-Piece Set**

- Jagged parts prevents cam-out.
- Suited for fastening screws in a poor footing unstable place.

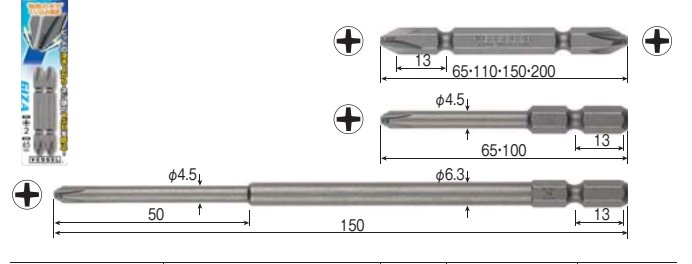

Model No.	Contents	Heat treatment classification	Card size (mm)	EDP No.
AZ142065	⊕2× 65 2pcs.	H	160×35×8	486177
AZ142110	⊕2×110 2pcs.	H	160×35×8	486178
AZ142150	⊕2×150 2pcs.	H	210×35×8	486179
AZ142200	⊕2×200 2pcs.	H	260×35×8	486180
AZ162065	⊕2×φ4.5× 65 2pcs.	H	160×35×8	486181
AZ162100	⊕2×φ4.5×100 2pcs.	H	160×35×8	486182
AZ162150	⊕2×φ4.5×φ6.3×150 2pcs.	H	210×35×8	486183

**No. BW GIZA BIT 5-Piece Set** Inner Ctn.: 10 sets



Model No.	Contents	Heat treatment classification	Card size (mm)	EDP No.
BW-172	⊕2× 65 2pcs. ⊕2×110 3pcs.	H H	140×70×23	486636
BW-175	⊕2×φ4.5× 65 2pcs. ⊕2×φ4.5×100 3pcs.	H H	140×70×23	486639

**No. AL ALFA BIT 2-Piece Set**

- Different hardness applied to ball groove and shank, absorbing and relieving the impact during fastening.
- Suited for a wide variety of works with an excellent torque transmission.

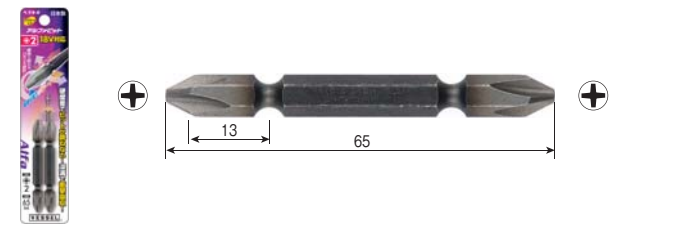

Model No.	Contents	Heat treatment classification	Card size (mm)	EDP No.
AL142065	⊕2× 65 2pcs.	H	160×35×8	486217

Provided with one bit holder. Outer Ctn.: 10 sets

HAND TOOLS

BITS & SOCKETS

ELECTRIC TOOLS

AIR TOOLS

STATIC SOLUTIONS

GASOLINE ENGINE TOOLS



## No. A14H TAPPING BIT 2-Piece Set



- Increased thickness of the cross blade recommended to heavy works.
- Suited for screws for sash frames with a thread size of about 4mm.



Model No.	Contents	Heat treatment classification	Card size (mm)	EDP No.
A14H2065	⌀2×65 2pcs.	H	160×35×8	486190
A14H2110	⌀2×110 2pcs.	H	160×35×8	486191

Inner Ctn.: 10 sets

## No. IR14 IRO BIT (Color-coded Bit) 2-Piece Set

- Bits colored according to size.
- Excellent rust proof performance.

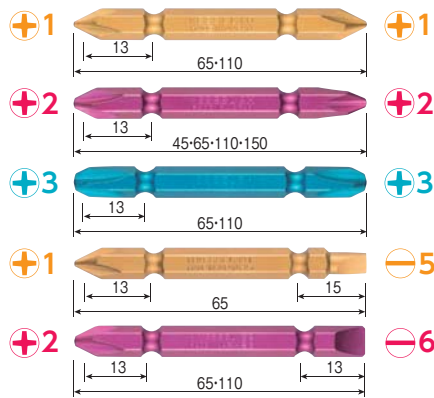

Model No.	Contents	Heat treatment classification	Card size (mm)	EDP No.
IR141045	⌀1×45 2pcs.	H	160×35×8	485100
IR141065	⌀1×65 2pcs.	H	160×35×8	485101
IR141110	⌀1×110 2pcs.	H	160×35×8	485102
IR142045	⌀2×45 2pcs.	H	160×35×8	485103
IR142065	⌀2×65 2pcs.	H	160×35×8	485104
IR142082	⌀2×82 2pcs.	H	160×35×8	485107
IR142110	⌀2×110 2pcs.	H	160×35×8	485105
IR142150	⌀2×150 2pcs.	H	210×35×8	485106
IR143045	⌀3×45 2pcs.	H	160×35×8	485110
IR143065	⌀3×65 2pcs.	H	160×35×8	485111
IR143110	⌀3×110 2pcs.	H	160×35×8	485112
IR143150	⌀3×150 2pcs.	H	210×35×8	485113
IR141565	⌀1/⌀5×65 2pcs.	H	160×35×8	485120
IR142665	⌀2/⌀6×65 2pcs.	H	160×35×8	485121
IR142611	⌀2/⌀6×110 2pcs.	H	160×35×8	485122
IR142615	⌀2/⌀6×150 2pcs.	H	210×35×8	485123

※Colors inside the table cells indicate the bit color. Inner Ctn.: 10 sets

## No. IR5P IRO BIT (Color-coded Bit) 5-Piece Set



IR5P2065F IR5P3065F  
IR5P2110F

Model No.	Contents	Heat treatment classification	Card size (mm)	EDP No.
IR5P2065F	⌀2×65 5pcs.	H	135×50×7	485167
IR5P2110F	⌀2×110 5pcs.	H	160×50×7	485168
IR5P3065F	⌀3×65 5pcs.	H	135×50×7	485169

※Colors inside the table cells indicate the bit color. Inner Ctn.: 10 sets

## No. IR16 Recessed IRO Bit (Color-coded Bit) 2-Pieces Set

- Bits colored according to size.
- Excellent rust proof performance.

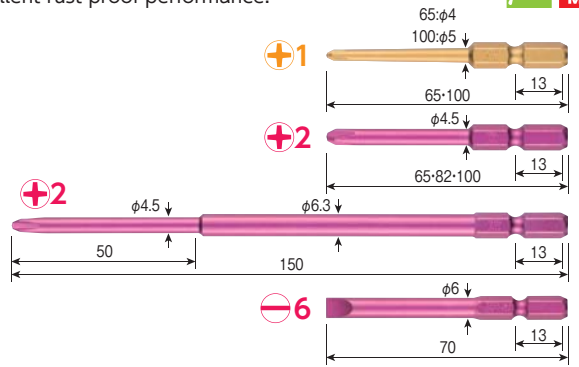

Model No.	Contents	Heat treatment classification	Card size (mm)	EDP No.
IR161065	⌀1×⌀4 × 65 2pcs.	H	160×35×8	485132
IR161100	⌀1×⌀5 × 100 2pcs.	H	160×35×8	485133
IR162065	⌀2×⌀4.5×65 2pcs.	H	160×35×8	485134
IR162082	⌀2×⌀4.5×82 2pcs.	H	160×35×8	485135
IR162100	⌀2×⌀4.5×100 2pcs.	H	160×35×8	485136
IR162150	⌀2×⌀4.5×⌀6.3×150 2pcs.	H	210×35×8	485137
IR166070	⌀6×⌀6 × 70 2pcs.	H	160×35×8	485131

※Colors inside the table cells indicate the bit color. Inner Ctn.: 10 sets

## No. IR5P Recessed IRO Bit (Color-coded Bit) 5-Pieces Set



IR5P1065DF IR5P2100DF

Model No.	Contents	Heat treatment classification	Card size (mm)	EDP No.
IR5P1065DF	⌀1×⌀4 × 65 5pcs.	H	135×50×7	485170
IR5P2100DF	⌀2×⌀4.5×100 5pcs.	H	160×50×7	485171

※Colors inside the table cells indicate the bit color. Inner Ctn.: 10 sets

## No. IR5P IRO BIT (Color-coded Bit) 5-Piece Set

- Bits colored according to size.
- Excellent rust proof performance.



IR5P01 IR5P02

Model No.	Contents	Heat treatment classification	Card size (mm)	EDP No.
IR5P01	⌀1×⌀4.0×65, ⌀2×⌀4.5×100, ⌀2/⌀6×65, ⌀2×110, ⌀3×65	H	160×70×8	485165
IR5P02	⌀1×65, ⌀2×65 ⌀3×65, ⌀2×110(2pcs.)	H	160×70×8	485166

Inner Ctn.: 10 sets

**No. A14SQ SQUARE DOUBLE END BIT 2-Piece Set**

● Bit for square screws mostly used for sash frames and quake resistant hardware.

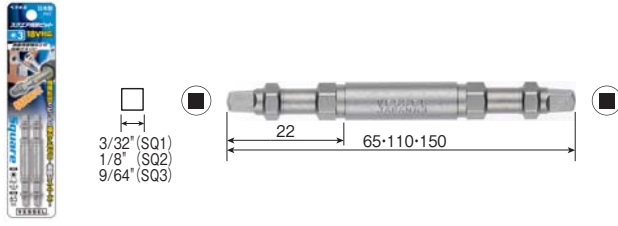

Model No.	Contents	Heat treatment classification	Card size (mm)	EDP No.
<b>A14SQ1065</b>	SQ 1× 65 2pcs.	H	160×35×8	486219
<b>A14SQ2065</b>	SQ 2× 65 2pcs.	H	160×35×8	486208
<b>A14SQ2110</b>	SQ 2×110 2pcs.	H	160×35×8	486210
<b>A14SQ2150</b>	SQ 2×150 2pcs.	H	210×35×8	486220
<b>A14SQ3065</b>	SQ 3× 65 2pcs.	H	160×35×8	486209
<b>A14SQ3110</b>	SQ 3×110 2pcs.	H	160×35×8	486211
<b>A14SQ3150</b>	SQ 3×150 2pcs.	H	210×35×8	486221

**No. A14RSQ SQUARE DOUBLE END BIT 2-Piece Set**

● Bit for square screws mostly used for sash frames and quake resistant hardware.

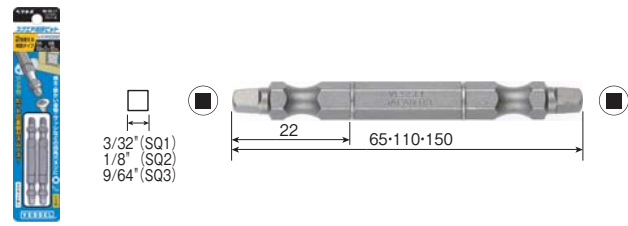

Model No.	Contents	Heat treatment classification	Card size (mm)	EDP No.
<b>A14RSQ1065</b>	SQ 1× 65 2pcs.	H	160×35×8	486222
<b>A14RSQ2110</b>	SQ 2×110 2pcs.	H	160×35×8	486224
<b>A14RSQ2150</b>	SQ 2×150 2pcs.	H	210×35×8	486225
<b>A14RSQ3065</b>	SQ 3× 65 2pcs.	H	160×35×8	486226
<b>A14RSQ3110</b>	SQ 3×110 2pcs.	H	160×35×8	486227

**No. BW SQUARE DOUBLE END BIT 5-Piece Set** Inner Ctn.: 10 sets



Model No.	Contents	Heat treatment classification	Card size (mm)	EDP No.
<b>BW-401</b>	SQ 2× 65 5pcs.	H	140×70×23	486850
<b>BW-403</b>	SQ 2×110 5pcs.	H	140×70×23	486852
<b>BW-405</b>	SQ 2× 65 3pcs.	H	140×70×23	486854
	SQ 2×110 2pcs.	H		
<b>BW-407</b>	SQ 2× 65 1pc.	H	140×70×23	486856
	SQ 3× 65 2pcs.	H		
	SQ 2×110 1pc.	H		
	SQ 3×110 1pc.	H		

Provided with one bit holder. Outer Ctn.: 10 sets

**No. BW SQUARE DOUBLE END BIT 5-Piece Set** Inner Ctn.: 10 sets

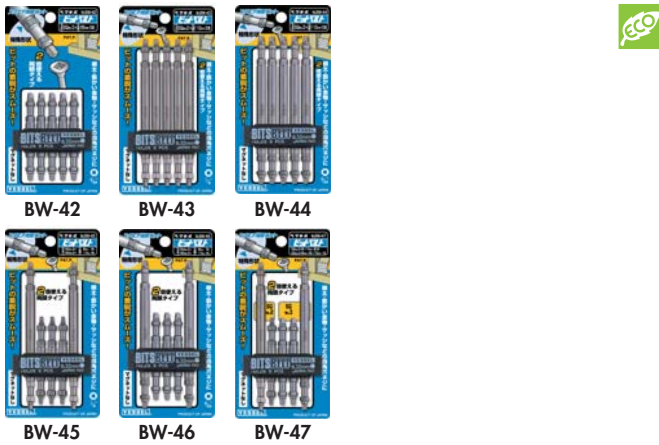

Model No.	Contents	Heat treatment classification	Card size (mm)	EDP No.
<b>BW-42</b>	SQ 3× 65 5pcs.	H	140×70×23	486662
<b>BW-43</b>	SQ 2×110 5pcs.	H	140×70×23	486663
<b>BW-44</b>	SQ 3×110 5pcs.	H	140×70×23	486664
<b>BW-45</b>	SQ 2× 65 3pcs.	H	140×70×23	486665
	SQ 2×110 2pcs.	H		
<b>BW-46</b>	SQ 3× 65 3pc.	H	140×70×23	486666
	SQ 3×110 2pcs.	H		
<b>BW-47</b>	SQ 2× 65 1pc.	H	140×70×23	486667
	SQ 3× 65 2pcs.	H		
	SQ 2×110 1pc.	H		
	SQ 3×110 1pc.	H		

Provided with one bit holder. Outer Ctn.: 10 sets

**No. M16SQ Square bit 2-Piece Set**

● Bit for square screws mostly used for sash frames and quake resistant hardware.

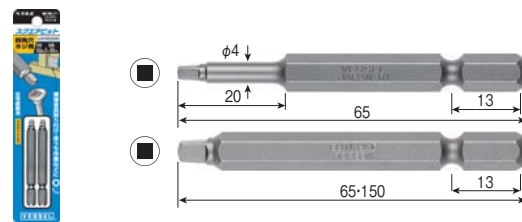

Model No.	Contents	Card size (mm)	EDP No.
<b>M16SQ1065</b>	SQ 1× 65 2pcs.	160×35×8	486155
<b>M16SQ2065</b>	SQ 2× 65 2pcs.	160×35×8	486156

Inner Ctn.: 10 sets

HAND TOOLS

BITS & SOCKETS

ELECTRIC TOOLS

AIR TOOLS

STATIC SOLUTIONS

GASOLINE ENGINE TOOLS

## No. SM16H Hex Bit

●For hexagon socket head bolts or set screws commonly used for machines and facilities, cars and motorcycles.



Model No.	Contents	Card size (mm)	EDP No.
SM16H020	H 2 × 65 1pc.	135×35×8	486671
SM16H025	H 2.5× 65 1pc.	135×35×8	486672
SM16H030	H 3 × 65 1pc.	135×35×8	486673
SM16H040	H 4 × 65 1pc.	135×35×8	486674
SM16H050	H 5 × 65 1pc.	135×35×8	486675
SM16H060	H 6 × 65 1pc.	135×35×8	486676
SM16H080	H 8 × 65 1pc.	135×35×8	486677

Inner Ctn.: 10 sets

## No. BW Hex Bit 5-Piece Set



BW-31

Model No.	Contents	Card size (mm)	EDP No.
BW-31	H2.5, 3, 4, 5, 6×65 1 for each	140×70×23	486591

Provided with one bit holder. Outer Ctn.: 10 sets

## No. SMVT TORX Bit (Tamper-Proof)

●For TORX screws used in the automobile industry.  
●With a round hole for tamper-proof.

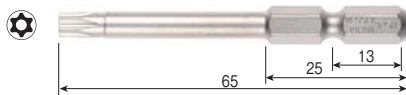

Model No.	Contents	Card size (mm)	EDP No.
SMVT08H	T 8H× 65 1pc.	135×35×8	486681
SMVT10H	T10H× 65 1pc.	135×35×8	486682
SMVT15H	T15H× 65 1pc.	135×35×8	486683
SMVT20H	T20H× 65 1pc.	135×35×8	486684
SMVT25H	T25H× 65 1pc.	135×35×8	486685
SMVT27H	T27H× 65 1pc.	135×35×8	486686
SMVT30H	T30H× 65 1pc.	135×35×8	486687
SMVT40H	T40H× 65 1pc.	135×35×8	486688

Inner Ctn.: 10 sets

TORX is a registered trademark of Acument TM Intellectual Properties, LLC (USA).  
VESSEL has a manufacturing license in Japan and selling same to the world.

## No. SM16BP Ball Point Bit

●For bolts with holes or set screws commonly used for machines and facilities, cars and motorcycles.



Model No.	Contents	Card size (mm)	EDP No.
SM16BP40	H 4 × 82 1pc.	160×35×8	486696
SM16BP50	H 5 × 82 1pc.	160×35×8	486697
SM16BP60	H 6 × 82 1pc.	160×35×8	486698

Inner Ctn.: 10 sets

## No. D83 Bit 2-Piece Set

●Stepped shape useful for fastening screws in narrow spaces.

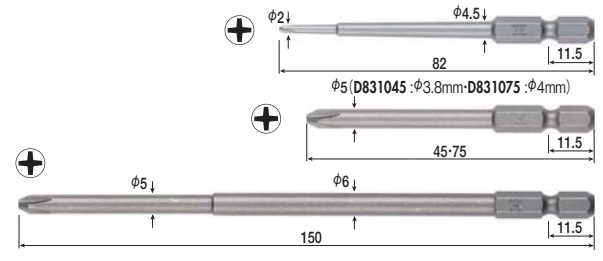

Model No.	Contents	Card size (mm)	EDP No.
D830082	⊕0×φ2 ×φ4.5× 82 2pcs.	160×35×8	486287
D831045	⊕1×φ3.8× 45 2pcs.	160×35×8	486282
D831075	⊕1×φ4 × 75 2pcs.	160×35×8	486283
D832075	⊕2×φ5 × 75 2pcs.	160×35×8	486284
D832150	⊕2×φ5 ×φ6 ×150 2pcs.	210×35×8	486286

Inner Ctn.: 10 sets

## No. M16 Bit for small precision screws 2-Piece Set

●Stepped shape useful for fastening screws in narrow spaces.



Model No.	Contents	Card size (mm)	EDP No.
M160082	⊕0×φ2×φ4.5× 82 2pcs.	160×35×8	486158

Inner Ctn.: 10 sets



**No. GM14 Double End Gold Color Bit (Magnetic) 2-Piece Set**

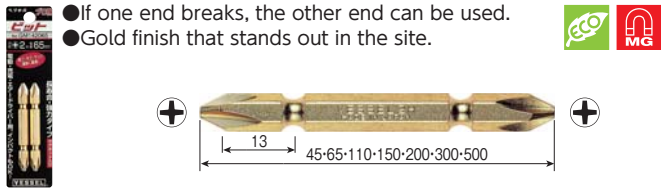

- If one end breaks, the other end can be used.
- Gold finish that stands out in the site.



Model No.	Contents	Heat treatment classification	Card size (mm)	EDP No.
GM141065	⊕1× 65 2pcs.	H	135×35×8	486421
GM141110	⊕1×110 2pcs.	H	160×35×8	486422
GM142045	⊕2× 45 2pcs.	H	135×35×8	486423
GM142065	⊕2× 65 2pcs.	H	135×35×8	486424
GM142110	⊕2×110 2pcs.	H	160×35×8	486425
GM143065	⊕3× 65 2pcs.	H	135×35×8	486428
GM142150	⊕2×150 2pcs.	H	210×35×8	486426
GM142200	⊕2×200 2pcs.	H	260×35×8	486569
GM143110	⊕3×110 2pcs.	H	160×35×8	486429

Inner Ctn.: 10 sets

**No. GM14 Double End Gold Color Bit (Magnetic) 1-Piece**

Model No.	Contents	Heat treatment classification	Card size (mm)	EDP No.
GM142300	⊕2×300 1pc.	H	340×35×17	486570
GM142500	⊕2×500 1pc.	H	540×35×17	486571

Silver finish. For the S hanger. Inner Ctn.: 10 sets

**No. GM14 ⊕⊖ Double End Gold Color Bit 2-Piece Set**

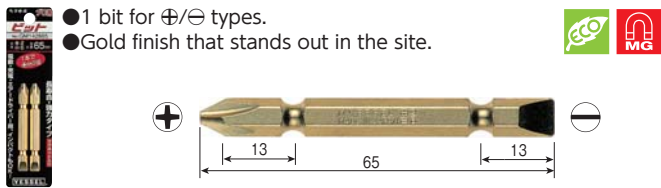

- 1 bit for ⊕/⊖ types.
- Gold finish that stands out in the site.



Model No.	Contents	Heat treatment classification	Card size (mm)	EDP No.
GM141565	⊕1/⊖5 × 65 2pcs.	H	135×35×8	486441
GM142665	⊕2/⊖6 × 65 2pcs.	H	135×35×8	486442

Inner Ctn.: 10 sets

**No. BW Gold Color Bit 5-Piece Set**

- Gold finish that stands out in the site.



Model No.	Contents	Card size (mm)	EDP No.
BW-51	Double End Gold Color Bit ⊕2× 45 5pcs.	95×70×23	486621
BW-52	Double End Gold Color Bit ⊕2× 65 5pcs.	95×70×23	486622
BW-53	Double End Gold Color Bit ⊕2×110 5pcs.	140×70×23	486623
BW-55	Double End Gold Color Bit 1 for each ⊕2× 65, ⊕2×110 ⊕⊖ Double End Gold Color Bit ⊕2/⊖6× 65 1pc. Gold Color Bit 1 for each ⊕1×100, ⊕2×100	140×70×23	486625

Provided with one bit holder. Outer Ctn.: 10 sets

**No. GD Gold Color Bit 2-Piece Set**

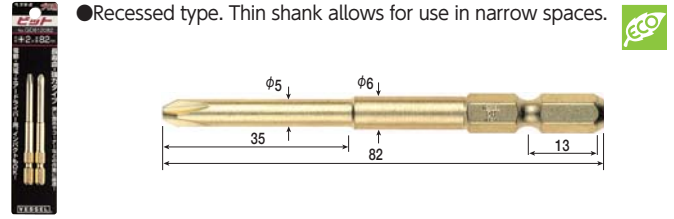

- Recessed type. Thin shank allows for use in narrow spaces.



Model No.	Contents	Heat treatment classification	Card size (mm)	EDP No.
GD812082	⊕2×φ5×φ6×82 2pcs.	H	160×35×8	486451

Inner Ctn.: 10 sets

**No. GM16 Step Gold Color Bit 2-Piece Set**

- Recessed type. Thin shank allows for use in narrow spaces.

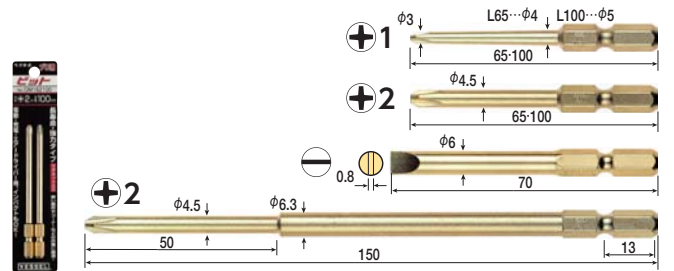

Model No.	Contents	Heat treatment classification	Card size (mm)	EDP No.
GM166070	⊖6×φ6 × 70 2pcs.	G	160×35×8	486454
GM161065	⊕1×φ4 × 65 2pcs.	H	135×35×8	486455
GM161100	⊕1×φ5 × 100 2pcs.	H	160×35×8	486459
GM162065	⊕2×φ4.5× 65 2pcs.	H	135×35×8	486456
GM162100	⊕2×φ4.5×100 2pcs.	H	160×35×8	486457
GM162150	⊕2×φ4.5×φ6.3×150 2pcs.	H	210×35×8	486458

Inner Ctn.: 10 sets

**No. BW Recessed Gold Color Bit 5-Piece Set**

- Recessed type. Thin shank allows for use in narrow spaces.



Model No.	Contents	Card size (mm)	EDP No.
BW-66	Gold Color Bit ⊕2× 65 5pcs.	140×70×23	486646
BW-67	Gold Color Bit ⊕2×100 5pcs.	140×70×23	486647

Provided with one bit holder. Outer Ctn.: 10 sets

HAND TOOLS

BITS & SOCKETS

ELECTRIC TOOLS

AIR TOOLS

STATIC SOLUTIONS

GASOLINE ENGINE TOOLS

## No. BW Gold Color Bit 10-Piece Set

●Excellent rust proof performance.



Except BW-10



Model No.	Contents	Card size (mm)	EDP No.
<b>BW-11</b>	Double End Gold Color Bit $\Phi 2 \times 45$ 10pcs.	120×85×23	486311
<b>BW-12</b>	Double End Gold Color Bit $\Phi 2 \times 65$ 10pcs.	120×85×23	486312
<b>BW-13</b>	Double End Gold Color Bit $\Phi 2 \times 110$ 10pcs.	150×100×23	486313
<b>BW-15</b>	Double End Gold Color Bit $\Phi 1 \times 65, \Phi 2 \times 110, \Phi 3 \times 65$ 1 for each $\Phi 2 \times 45, \Phi 2 \times 65$ 2 for each $\Phi 2$ / $\Phi 6 \times 65$ 1pc. Step Gold Color Bit $\Phi 1 \times 100, \Phi 2 \times 100$ 2 for each	150×100×23	486315

Provided with one bit holder. Outer Ctn.: 10 sets

## No. GM16H Hex Gold Color Bit

- Bit for hexagon socket head bolts or set screws commonly used for machines and facilities, cars and motorcycles.
- Gold finish that stands out in the site.



Model No.	Contents	Card size (mm)	EDP No.
<b>GM16H025</b>	H 2.5× 65 1pc.	135×35×8	486558

Inner Ctn.: 10 sets

## No. GSB Gold Color Nut Setter (Locked with ball)

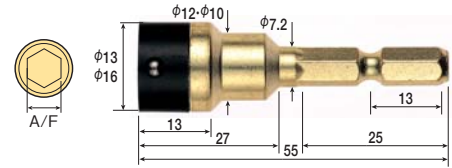

Model No.	Contents	Card size (mm)	EDP No.
<b>GSB8055</b>	A/F $5/16" \times 55$ (for 5mm) 1pc.	135×35	486511
<b>GSB9655</b>	A/F $3/8" \times 55$ (for 6mm) 1pc.	135×35	486512

Inner Ctn.: 5 sets

## No. GSAM Gold Color Nut Setter (Magnetic)



Model No.	Contents	Card size (mm)	EDP No.
<b>GSAM8055</b>	A/F $5/16" \times 55$ (for 5mm) 1pc.	135×35	486501
<b>GSAM9655</b>	A/F $3/8" \times 55$ (for 6mm) 1pc.	135×35	486502

Inner Ctn.: 5 sets

## No. GMA Gold Bits (in zip pack)

- Packed in a bag with a zipper for easy storage.
- Gold finish that stands out in the site.



Model No.	Contents	Heat treatment classification	Package size (mm)	EDP No.
<b>GMA14 <math>\Phi 2 \times 45H</math></b>	GM14 $\Phi 2 \times 45$ 10pcs.	H	145×80×7	410150
<b>GMA14 <math>\Phi 2 \times 65H</math></b>	GM14 $\Phi 2 \times 65$ 10pcs.	H	145×80×7	410153
<b>GMA14 <math>\Phi 2 \times 110H</math></b>	GM14 $\Phi 2 \times 110$ 10pcs.	H	190×80×7	410156
<b>GMA16 <math>\Phi 1 \times \phi 3 \times 65H</math></b>	GM16 $\Phi 1 \times \phi 3 \times 65$ 10pcs.	H	145×80×7	418303
<b>GMA16 <math>\Phi 1 \times \phi 3 \times 100H</math></b>	GM16 $\Phi 1 \times \phi 3 \times 100$ 10pcs.	H	190×80×7	418306
<b>GMA16 <math>\Phi 2 \times \phi 4.5 \times 65H</math></b>	GM16 $\Phi 2 \times \phi 4.5 \times 65$ 10pcs.	H	145×80×7	418313
<b>GMA16 <math>\Phi 2 \times \phi 4.5 \times 100H</math></b>	GM16 $\Phi 2 \times \phi 4.5 \times 100$ 10pcs.	H	190×80×7	418316

Inner Ctn.: 10 sets

**No. BW-70** Socket Bit Belt



Model No.	Contents	Card size (mm)	EDP No.
<b>BW-70</b>	A/F 8×60 A/F 10×60 A/F 12×60 A/F 13×60 A/F 14×60 1 for each	140×80×23	486705

Provided with one bit holder. Outer Ctn.: 5 sets

**No. SB** Nut Setter (For power tools)



Model No.	Contents	Card size (mm)	EDP No.
<b>SB A/F 5/16"×55</b>	A/F 5/16"×55 (for 5mm) 5pcs.	127×87×15	482531
<b>SB A/F 3/8"×55</b>	A/F 3/8"×55 (for 6mm) 5pcs.	127×87×15	482532

Outer Ctn.: 10 sets

**No. BB** Bit Belt Holder



Model No.	Contents	Package size (mm)	EDP No.
<b>BB-5</b>	Bit Belt Holder for 5pcs.	158×78×28	486579
<b>BB-10</b>	Bit Belt Holder for 10pcs.	118×98×38	486580

Outer Ctn.: 10 sets

**No. VBA** Double End Power Bit (w/Bit Belt) **NEW**

- Holder included for hanging from the waist belt.
- Anti-rust surface treatment.
- Popular 2 sizes available.



Model No.	Contents	Card size (mm)	EDP No.
<b>VBA20651</b>	Non-electrolytic plated bit $\varnothing 2 \times 65$ mm 10pcs.	50×100	484056
<b>VBA21101</b>	Non-electrolytic plated bit $\varnothing 2 \times 110$ mm 10pcs.	85×120	484057

with one piece of holder case Inner Ctn.: 10 sets

**No. SMG14** Bit Mag Bottle 20-pc Set **SAKISUBO** Double End Bits **NEW PAT.**

- Tip is easy to see, and the torsion effect of the constricted part produces great durability.
- Used for soft joints such as wood screw work.
- Integrated magnetizer in the cap to magnetize/demagnetize bits.
- Provided with a ring to hang onto hooks.



Model No.	Contents	Heat treatment classification	Bottle size (mm)	EDP No.
<b>SMG14 <math>\varnothing 2 \times 65</math>H</b>	$\varnothing 2 \times 65$ 20pcs.	H	53×100×111	415283
<b>SMG14 <math>\varnothing 2 \times 110</math>H</b>	$\varnothing 2 \times 110$ 20pcs.	H	53×100×153	415284

Inner Ctn.: 5 sets

**No. AMG14** Bit Mag Bottle 20-pc Set **Double End Bits (A-type)** **NEW PAT.**

- Basic bits which are long popular in assembly factories.
- Optimal for hard joint parts such as tapping and machine screws.
- Integrated magnetizer in the cap to magnetize/demagnetize bits.
- Provided with a ring to hang onto hooks.

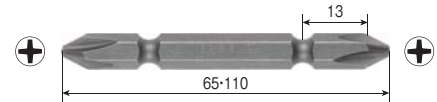

Model No.	Contents	Heat treatment classification	Bottle size (mm)	EDP No.
<b>AMG14 <math>\varnothing 2 \times 65</math>H</b>	$\varnothing 2 \times 65$ 20pcs.	H	53×100×111	415285
<b>AMG14 <math>\varnothing 2 \times 110</math>H</b>	$\varnothing 2 \times 110$ 20pcs.	H	53×100×153	415286

Inner Ctn.: 5 sets

One point

Magnetize/demagnetize with freedom

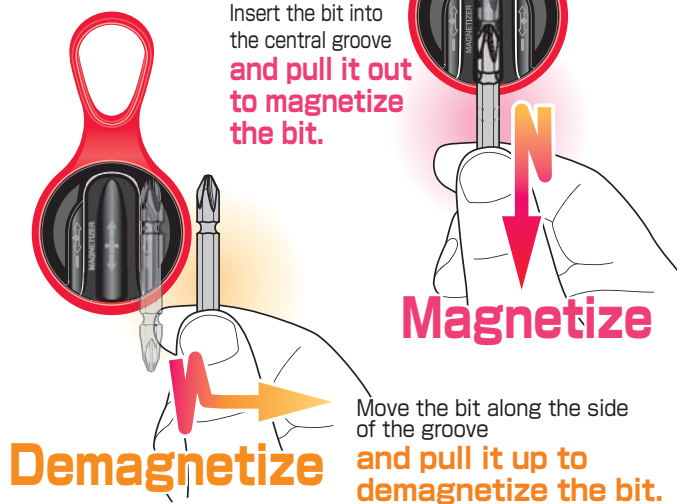

HAND TOOLS

BITS & SOCKETS

ELECTRIC TOOLS

AIR TOOLS

STATIC SOLUTIONS

GASOLINE ENGINE TOOLS



## No. BMG43 Bit Mag Bottle 20-pc Set Double End Bits (B-type) **NEW PAT.**

- Basic bits which are long popular in assembly factories.
- Optimal for hard joint parts such as tapping and machine screws.
- Integrated magnetizer in the cap to magnetize/demagnetize bits.
- Provided with a ring to hang onto hooks.

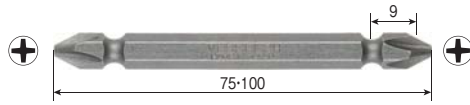

Model No.	Contents	Heat treatment classification	Bottle size (mm)	EDP No.
BMG43 $\Phi$ 2×100H	$\Phi$ 2×100 20pcs.	H	53×100×153	415282

Inner Ctn.: 5 sets

## No. QB-10 Quick Catcher **NEW**

- Bit can be replaced with just one hand.
- Smooth surface finish and pull-up type sleeve prevent tools from dropping.
- Strong ball chuck enables to mount a tool up to 500g.
- Flat ring with large diameter is easy to mount on carabiners, etc.



QB-10R QB-10B QB-10Y

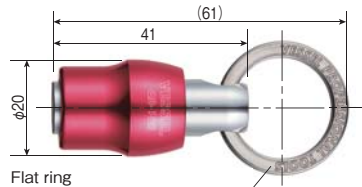

Model No.	Contents	Card size (mm)	EDP No.
QB-10R	Quick Catcher (Red) 1pc.	135×50×22	486921
QB-10B	Quick Catcher (Blue) 1pc.	135×50×22	486922
QB-10Y	Quick Catcher (Yellow) 1pc.	135×50×22	486923

Inner Ctn.: 10 sets Outer Ctn.: 10 sets

## No. QB-K3C Quick Catcher 3-Piece Set **NEW**

- Bit can be replaced with just one hand.
- Smooth surface finish and pull-up type sleeve prevent tools from dropping.
- Strong ball chuck enables to mount a tool up to 500g.
- Provided with a carabiner to hang onto your belt, etc.



Model No.	Contents	Card size (mm)	EDP No.
QB-K3C	Quick catcher (Red-Blue-Yellow), Carabiner (Black) 1 for each	135×50×50	486924

Inner Ctn.: 10 sets Outer Ctn.: 100 sets

## No. QB-KBAD Quick Cather with Key Adapter **NEW**

- Bit can be replaced with just one hand.
- Smooth surface finish and pull-up type sleeve prevent tools from dropping.
- Strong ball chuck enables to mount a tool up to 500g.
- Provided with a carabiner to hang onto your belt, etc.



Model No.	Contents	Card size (mm)	EDP No.
QB-KBAD	Quick catcher (Black), Key adapter, Carabiner (Black) 1 for each	135×50×31	486925

Inner Ctn.: 10 sets Outer Ctn.: 100 sets

## No. QB-AD Key adapter **NEW**

- Key adapter for Quick Catcher QB series.
- A flat blade for prizing, which can also be used to open paint can lids.
- Flat ring with large diameter is easy to mount on carabiners, etc.

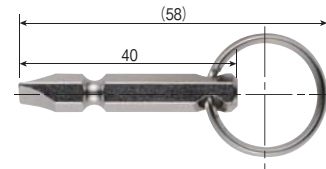

Model No.	Contents	Card size (mm)	EDP No.
QB-AD	Key adapter 1pc.	135×50×9	486926

Inner Ctn.: 10 sets Outer Ctn.: 100 sets

## One point

**Insert/withdraw with just one hand**

Pinch sleeve up to withdraw.

Insert, and automatically locks