

## PW3365-20

Instruction Manual

# CLAMP ON POWER LOGGER



### Video

Scan this code to watch an instructional video.

Carrier charges may apply.



**!** Be sure to read this manual before using the instrument.

▶ p.5

**✓** When using the instrument for the first time

Names and Functions ▶ p.18

Measurement Preparations ▶ p.27

**📖** Troubleshooting

Trouble Shooting ▶ p.221

Error Indication ▶ p.225

## EN

July 2019 Revised edition 4  
PW3365A981-04 19-07H



\* 6 0 0 4 2 9 6 2 4 \*



# Contents

<b>Introductions .....</b>	<b>1</b>
<b>Confirming Package Contents .....</b>	<b>2</b>
■ Storing the Instrument in the Carrying Case (Option) .....	4
<b>Safety Information .....</b>	<b>5</b>
<b>Operating Precautions .....</b>	<b>9</b>
<b>Measurement Flowchart .....</b>	<b>13</b>
<b>Chapter 1</b>	
<b>Overview .....</b>	<b>15</b>
<b>1.1 Product Overview .....</b>	<b>15</b>
<b>1.2 Features .....</b>	<b>16</b>
<b>1.3 Names and Functions (PW3365) .....</b>	<b>18</b>
<b>1.4 Names and Functions     (PW9020 Safety Voltage Sensor) .....</b>	<b>21</b>
<b>1.5 Screen Configuration .....</b>	<b>22</b>
<b>1.6 On-Screen Indicators .....</b>	<b>24</b>
<b>Chapter 2</b>	
<b>Measurement Preparations .....</b>	<b>27</b>
<b>2.1 Preparation Flowchart .....</b>	<b>27</b>
<b>2.2 Preparing to Use the Instrument after Purchase ..</b>	<b>28</b>
■ Attaching Color Clips around Voltage Sensors and Grouping Together Cords .....	28
■ Attaching Color Clips around Clamp Sensors and Grouping Together Cords .....	30
■ Installing (replacing) the Battery Pack .....	32
■ Setting the Language and Measurement Target Frequency (50 Hz/60 Hz) .....	35
■ Setting the Clock .....	36
<b>2.3 Pre-Operation Inspection .....</b>	<b>37</b>
<b>2.4 Inserting (Removing) an SD Memory Card .....</b>	<b>38</b>
<b>2.5 Connecting the AC Adapter .....</b>	<b>41</b>
<b>2.6 Turning the Power On/Off .....</b>	<b>42</b>

## **Chapter 3**

### **Connecting to Target to be Measured \_\_\_\_\_ 43**

- 3.1 Checking the Equipment before Connecting the Instrument ..... 43**
- 3.2 Connection Procedure ..... 44**
- 3.3 Setting Measurement Conditions on the Wiring Diagram Screen ..... 45**
- 3.4 Connecting the Current Sensors to the Instrument ..... 53**
- 3.5 Connecting the Clamp Sensors to the Instrument ... 55**
- 3.6 Connecting the Voltage Sensors to Target to be Measured ..... 57**
- 3.7 Connecting Clamp Sensors to Target to be Measured ..... 60**
  - Load Current Measurement ..... 61
  - Leakage Current Measurement ..... 62
- 3.8 Checking the Current Range ..... 63**
- 3.9 Verifying Correct Wiring (Wiring Check) ..... 65**

## **Chapter 4**

### **Changing Settings \_\_\_\_\_ 71**

- 4.1 Viewing and Using the Settings Screen ..... 71**
  - 4.2 Changing Measurement Settings ..... 72**
    - Measurement 1 Setting Screen ..... 72
    - Measurement 2 Setting Screen ..... 74
  - 4.3 Changing Recording (Save) Settings ..... 78**
    - Recording 1 Setting Screen ..... 78
    - Recording 2 Setting Screen ..... 83
  - 4.4 Changing System Settings (as Necessary) ..... 89**
    - System 1 Setting Screen ..... 89
    - System 2 Setting Screen ..... 91
  - 4.5 Initializing the Instrument (System Reset) ..... 92**
    - When the Instrument Is Operating in an Odd or Unexpected Manner (System Reset) ..... 92
    - Reverting All Settings to the Factory Defaults (Factory Reset) ..... 93
    - Factory Settings ..... 94
-

## Chapter 5 Viewing Measurement Data \_\_\_\_\_ 97

- 5.1 Viewing and Using the Measurement Screen .....97
  - 1P2W x 2 or 1P2W x 3 Wiring ..... 98
- 5.2 List of Measurement Screens .....99
- 5.3 Viewing Data (Voltage, Current, Power, and Energy) as a List ..... 101
- 5.4 Viewing Voltage and Current Value Details (RMS/Fundamental Wave/Peak Values, and Phase Angles) ..... 102
- 5.5 Viewing Power Details (Channel Power Values) 104
- 5.6 Viewing Energy (Active Energy and Reactive Energy) ..... 105
- 5.7 Viewing a Demand Graph ..... 106
- 5.8 Viewing a Harmonic Graph ..... 107
- 5.9 Viewing a Harmonic List ..... 108
- 5.10 Viewing Waveforms ..... 109
  - Changing the Zoom Factor for the Vertical Axis Used to Display Voltage and Current Waveforms ..... 110
- 5.11 Enlarging Measured Values on the Display ..... 111
- 5.12 Viewing a Trend Graph ..... 113
- 5.13 If No Measured Value Is Displayed ..... 115

## Chapter 6 Starting and Stopping Recording and Measurement \_\_\_\_\_ 117

- 6.1 Starting Recording ..... 118
  - Starting Recording Manually ..... 118
  - Starting Recording by Specifying a Time [TIME] ..... 119
  - Starting Recording at a Good Time Division [INTERVAL]... 120
- 6.2 Stopping Recording ..... 121
  - Stopping Recording Manually ..... 121
  - Stopping Recording by Specifying a Time [TIME] ..... 122
  - Stopping Recording with a Timer [TIMER] ..... 123
- 6.3 Repeat Recording [REPEAT] ..... 124

3

4

5

6

---

6.4	Operation When a Power Outage Occurs While Recording .....	125
<b>Chapter 7</b>		
<b>Quick Set</b> .....		<b>127</b>
7.1	Settings Configured with the Quick Set .....	127
7.2	Settings That Can Be Added to Quick Set Settings .....	128
<b>Chapter 8</b>		
<b>Saving Data and Manipulating Files</b> .....		<b>131</b>
8.1	Viewing and Using the File Screen .....	132
8.2	Folder and File Structure .....	134
	■ SD Memory Card .....	134
	■ Internal Memory .....	139
8.3	Saving Copies of the Screen (SD Memory Card Only) .....	140
8.4	Saving Settings Files .....	141
8.5	Loading Settings Files .....	142
	■ SD Memory Card .....	142
	■ Internal Memory .....	143
8.6	Copying Internal Memory Files to the SD Memory Card .....	144
8.7	Deleting Folders and Files .....	145
8.8	Formatting the SD Memory Card or Internal Memory .....	146
<b>Chapter 9</b>		
<b>Analyzing Data on a Computer</b> .....		<b>149</b>
9.1	Copying Data to a Computer (SD) .....	150
9.2	Copying Data to a Computer (USB) .....	152
9.3	SF1001 Power Logger Viewer (Optional) .....	155
9.4	Checking Recording and Measurement Data with Excel® .....	157
	■ Opening recording and measurement data .....	157
	■ Saving Data as an Excel® File .....	158
	■ Example of Data from a Measurement File .....	159

---

■ Measurement File Contents .....	160
■ Converting Measured Value Exponential Data .....	167
<b>9.5 Using the PW3360/PW3365 Excel automatic graphing software .....</b>	<b>168</b>

## Chapter 10

### Using Communications (LAN) \_\_\_\_\_ 169

<b>10.1 Preparing for LAN Communications .....</b>	<b>169</b>
■ Configure the Instruments LAN Settings .....	171
■ Connecting the Instrument and Computer with a LAN Cable .....	173
<b>10.2 Remote Control of the Instrument by Internet Browser .....</b>	<b>176</b>
■ Preparing for Remote Operation .....	176
■ Operating the Instrument Remotely .....	178
■ Setting a Password .....	179
■ If You Forget Your Password .....	179
<b>10.3 Downloading Recorded Data to Computer .....</b>	<b>180</b>
■ Setup .....	180
■ Download .....	182

## Chapter 11

### Specifications \_\_\_\_\_ 185

<b>11.1 General Specifications .....</b>	<b>185</b>
<b>11.2 Basic Specifications .....</b>	<b>186</b>
<b>11.3 Detailed Measurement Specifications .....</b>	<b>190</b>
<b>11.4 Functional Specifications .....</b>	<b>197</b>
<b>11.5 Calculation Formulas .....</b>	<b>206</b>
<b>11.6 Range Configuration and Accuracy by Clamp Sensor .....</b>	<b>215</b>
■ When Model 9660, 9661, or 9695-03 Clamp on Sensor is Used .....	215
■ When Model 9669 Clamp on Sensor is Used .....	216
■ When Model 9694 or 9695-02 Clamp on Sensor is Used ..	216
■ When Model CT9667 Flexible Clamp on Sensor is Used ..	217
<b>11.7 PW9020 Safety Voltage Sensor .....</b>	<b>218</b>

**Chapter 12**  
**Maintenance and Service** \_\_\_\_\_ **221**

**12.1 Trouble Shooting** ..... **221**  
        ■ Before Having the Instrument Repaired ..... 223

**12.2 Cleaning** ..... **225**

**12.3 Error Indication** ..... **225**

**12.4 Disposing of the Instrument** ..... **231**

**Appendix** \_\_\_\_\_ **A1**

**Appendix 1 Voltage Sensor Measurement Principles** ..... **A1**

**Appendix 2 How the Instrument Samples Data**..... **A1**

**Appendix 3 Three-phase 3-wire Measurement**..... **A2**

**Appendix 4 Method for Calculating Active Power Accuracy** ..... **A9**

**Appendix 5 Terminology** ..... **A11**

**Index** \_\_\_\_\_ **Index 1**

---



## Introductions

Thank you for purchasing the HIOKI PW3365 Clamp on Power Logger. To obtain maximum performance from the instrument, please read this manual first, and keep it handy for future reference.

### Trademarks

- Microsoft, Windows and Excel are either registered trademarks or trademarks of Microsoft Corporation in the United States and other countries.
- SD, SDHC Logos are trademarks of SD-3C LLC. 

### Model Numbers

In this Instruction Manual, “PW3365” is used as the instrument model.

Model No.	Operation panel
PW3365-10	Japanese
PW3365-20	English
PW3365-30	Chinese

## Confirming Package Contents

When you receive the instrument, inspect it carefully to ensure that no damage occurred during shipping. In particular, check the accessories, panel keys, switch, and connectors. If damage is evident, or if it fails to operate according to the specifications, contact your authorized Hioki distributor or reseller.

Check that the package contents are correct.

- PW3365 Clamp on Power Logger..... 1

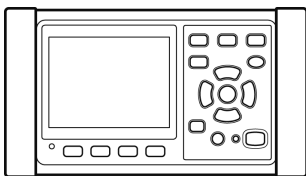

### Accessories

- PW9020 Safety Voltage Sensor..... 4

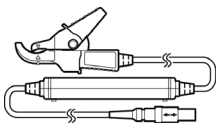

**See:** "3.4 Connecting the Current Sensors to the Instrument" (p.53)

- Z1008 AC Adapter ..... 1  
(includes power cord)



- USB Cable ..... 1  
(Ver.2.0, with ferrite cores, approx. 0.9 m)



- Instruction manual (This document) 1



- Measurement guide ..... 1



- Colored clip in red, yellow, blue and white  
(color coding for current sensors and voltage sensors)..... ×4 each



- Spiral tubes in black  
(cord bundling for current sensors and voltage sensors)..... 10



**See:** "Attaching Color Clips around Voltage Sensors and Grouping Together Cords" (p.28)  
"Attaching Color Clips around Clamp Sensors and Grouping Together Cords" (p.30)

## Transport precautions

When transporting the instrument, use the original packing materials in which it was shipped, and pack in a double carton. Damage occurring during transportation is not covered by warranty.

## Options

The following options are provided for the PW3365. For purchase, contact your authorized Hioki distributor or reseller.

### For current measurement

- 9660 Clamp on Sensor (100 Arms rated)
- 9661 Clamp on Sensor (500 Arms rated)
- 9669 Clamp on Sensor (1000 Arms rated)
- 9694 Clamp on Sensor (5 Arms rated)
- 9695-02 Clamp on Sensor (50 Arms rated)
- 9695-03 Clamp on Sensor (100 Arms rated)
- 9219 Connection Cable (For use with Model 9695-02/9695-03)
- CT9667 Flexible Clamp on Sensor (5000 A rms rated)
- 9657-10 Clamp on Leak Sensor
- 9675 Clamp on Leak Sensor
- 9290-10 Clamp on Adapter

### For voltage measurement

- PW9020 Safety Voltage Sensor (for replacement use)

### Power supply

- PW9002 Battery Set (9459 Battery Pack and battery case set)
- 9459 Battery Pack (for replacing the 9459 Battery Pack that comes with PW9002)
- Z1008 AC Adapter

### Media for recording

- Z4001 SD Memory Card (2 GB)
- Z4003 SD Memory Card (8 GB)

### For communications

- 9642 LAN Cable

### Software

- SF1001 Power Logger Viewer

To request a paper copy of the SF1001 user manual (PDF), please contact an authorized Hioki distributor or reseller. A fee applies.

### Carrying case

- C1005 Carrying Case
  - C1008 Carrying Case
-

**Storing the Instrument in the Carrying Case (Option)**

The instrument can be stored in the C1005 Carrying Case and C1008 Carrying Case as follows:

**C1005 Carrying Case**

This divider is attached by means of Velcro-style fasteners and can be removed. It can be arranged as desired to accommodate the case's contents.

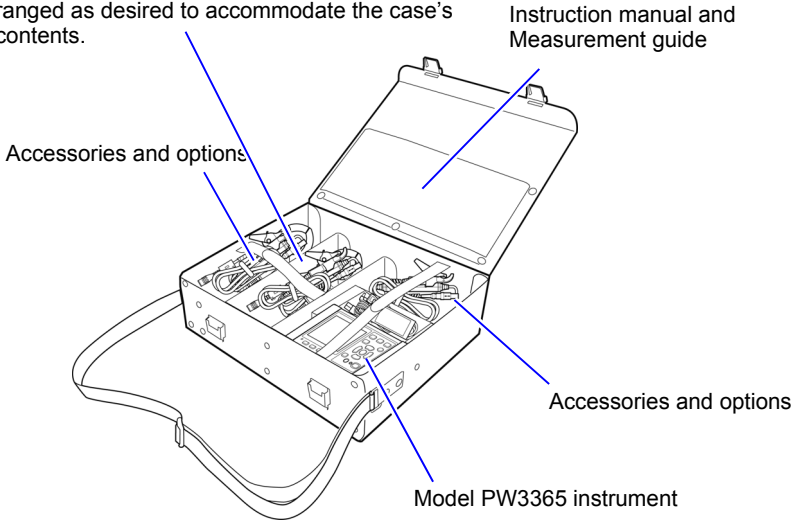
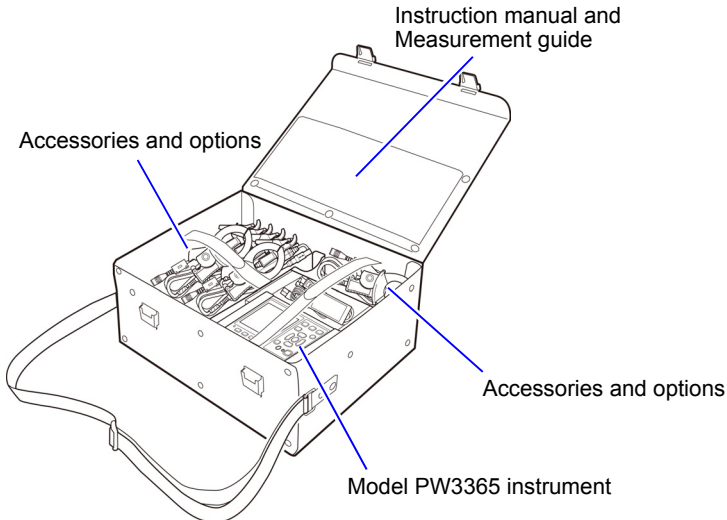
**C1008 Carrying Case**

## Safety Information

This instrument is designed to conform to IEC 61010 Safety Standards, and has been thoroughly tested for safety prior to shipment. However, using the instrument in a way not described in this manual may negate the provided safety features. Before using the instrument, be certain to carefully read the following safety notes.



**Mishandling during use could result in injury or death, as well as damage to the instrument. Be certain that you understand the instructions and precautions in the manual before use.**



**With regard to the electricity supply, there are risks of electric shock, heat generation, fire, and arc discharge due to short circuits. If persons unfamiliar with electricity measuring instrument are to use the instrument, another person familiar with such instruments must supervise operations.**

### Symbols on the instrument



Indicates cautions and hazards. When the symbol is printed on the instrument, refer to a corresponding topic in the Instruction Manual.



Indicates a double-insulated device.



Indicates a grounding terminal.



Indicates AC (Alternating Current).



Indicates DC (Direct Current).



Indicates the ON side of the power switch.



Indicates the OFF side of the power switch.

**Notation**

In this manual, the risk seriousness and the hazard levels are classified as follows.

**DANGER**

Indicates an imminently hazardous situation that will result in death or serious injury to the operator.

**WARNING**

Indicates a potentially hazardous situation that may result in death or serious injury to the operator.

**CAUTION**

Indicates a potentially hazardous situation that may result in minor or moderate injury to the operator or damage to the instrument or malfunction.

**IMPORTANT**

Indicates information related to the operation of the instrument or maintenance tasks with which the operators must be fully familiar.

**Reference**

Indicates advisory items related to performance or correct operation of the instrument.



Indicates prohibited actions.



Indicates the action which must be performed.

**Select**

Indicates the item to select.

\*

Additional information is presented below.

Windows

Unless otherwise specified, "Windows" represents Windows XP, Windows Vista (32 bit), Windows 7 (32 bit/64 bit), Windows 8 (32 bit/64 bit), or Windows 10 (32 bit/64 bit).

[ ]

Menus, commands, dialogs, buttons in a dialog, and other names on the screen and the keys are indicated in brackets.

## Symbols for various standards

	<p>WEEE marking: This symbol indicates that the electrical and electronic appliance is put on the EU market after August 13, 2005, and producers of the Member States are required to display it on the appliance under Article 11.2 of Directive 2002/96/EC (WEEE).</p>
	<p>This is a recycle mark established under the Resource Recycling Promotion Law (only for Japan).</p>
Ni-MH	
	<p>Indicates that the product conforms to regulations set out by the EU Directive.</p>

## Accuracy

We define measurement tolerances in terms of f.s. (full scale), rdg. (reading) and dgt. (digit) values, with the following meanings:

<b>f.s.</b>	<p>(maximum display value) The maximum displayable value. This is usually the name of the currently selected range.</p>
<b>rdg.</b>	<p>(displayed value) The value currently being measured and indicated on the measuring instrument.</p>
<b>dgt.</b>	<p>(resolution) The smallest displayable unit on a digital measuring instrument, i.e., the input value that causes the digital display to show a "1" as the least-significant digit.</p>

## Safety Information

### Measurement categories

To ensure safe operation of measuring instruments, IEC 61010 establishes safety standards for various electrical environments, categorized as CAT II to CAT IV, and called measurement categories.

**⚠ DANGER**



- Using a measuring instrument in an environment designated with a higher-numbered category than that for which the instrument is rated could result in a severe accident, and must be carefully avoided.
- Using a measuring instrument without categories in an environment designated with the CAT II to CAT IV category could result in a severe accident, and must be carefully avoided.

This instrument conforms to the safety requirements for CAT III 600 V, CAT IV 300 V measuring instruments. (when using the PW9020 Voltage Sensor)

CATII	hen directly measuring the electrical outlet receptacles of the primary electrical circuits in equipment connected to an AC electrical outlet by a power cord (portable tools, household appliances, etc.)
CATIII	When measuring the primary electrical circuits of heavy equipment (fixed installations) connected directly to the distribution panel, and feeders from the distribution panel to outlets
CATIV	When measuring the circuit from the service drop to the service entrance, and to the power meter and primary overcurrent protection device (distribution panel)

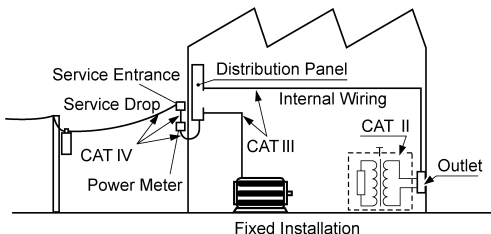



## Operating Precautions

Follow these precautions to ensure safe operation and to obtain the full benefits of the various functions.

Ensure that your use of the instrument falls within the specifications not only of the instrument itself, but also of any accessories, options, batteries, and other equipment being used.

### Operating Precautions

 **DANGER**



- If the PW9020 Safety Voltage Sensor or the instrument is damaged, there is a risk of electric shock. Before using the instrument, perform the following inspection.
  - Before using the instrument, check that the coating of the PW9020 Safety Voltage Sensor are neither ripped nor torn and that no metal parts are exposed. If you find any damage, replace the sensor with a new sensor or contact an authorized Hioki distributor or reseller as electric shock may result.
  - Verify that the instrument operates normally to ensure that no damage occurred during storage or shipping. If you find any damage, contact your authorized Hioki distributor or reseller.

### Instrument Installation

For more information about the operating temperature and humidity range and the storage temperature and humidity range, see "Chapter 11 Specifications" (p.185).

 **WARNING**



Installing the instrument in inappropriate locations may cause a malfunction of instrument or may give rise to an accident. Avoid the following locations.



- Exposed to direct sunlight or high temperature
- Exposed to corrosive or combustible gases
- Exposed to a strong electromagnetic field or electrostatic charge
- Near induction heating systems (such as high-frequency induction heating systems and IH cooking equipment)
- Susceptible to vibration
- Exposed to water, oil, chemicals, or solvents
- Exposed to high humidity or condensation
- Exposed to high quantities of dust particles

 **CAUTION**





Do not place the device on an unstable table or an inclined place. Dropping or knocking down the device can cause injury or damage to the device.

**Handling the Instrument**

 **CAUTION**  To avoid damage to the instrument, protect it from physical shock when transporting and handling. Be especially careful to avoid physical shock from dropping.

**Reference** This instrument and Model PW9020 Safety Voltage Sensor may cause interference if used in residential areas. Such use must be avoided unless the user takes special measures to reduce electromagnetic emissions to prevent interference to the reception of radio and television broadcasts.

**Handling the Voltage Sensor**

 **WARNING**  Touching any of the high-voltage points inside the PW9020 Safety Voltage Sensor is very dangerous. Customers are not allowed to modify, disassemble, or repair the PW9020. Doing so may cause fire, electric shock, or injury.

**IMPORTANT**

- The instrument may not be able to accurately measure waveforms that contain components outside the frequency range indicated in the "Effective measuring range" (p.187) section of the specifications (45 Hz to 66 Hz).
  - If the measurement target is an insulated wire with dirt or moisture on its insulation, the instrument may display lower values than the actual voltage and power. If the surface of the measurement target's insulation has dirt or moisture on it, wipe it clean with a dry cloth before measurement.
-

## Handling the Clamp Sensor

### CAUTION



- Be careful to avoid dropping the clamp sensor or otherwise subjecting them to mechanical shock, which could damage the mating surfaces and adversely affect measurement.

- Keep the clamp jaws and core slits free from foreign objects, which could interfere with clamping action.



- Keep the clamp closed when not in use, to avoid accumulating dust or dirt on the facing core surfaces, which could interfere with clamp performance.

## Handling the Cords

### CAUTION



To prevent cord damage, do not step on cords or pinch them between other objects. Do not bend or pull on cords at their base.

## Handling the Battery Pack

### WARNING



- **To avoid the possibility of explosion, do not short circuit, disassemble or incinerate battery pack. Handle and dispose of batteries in accordance with local regulations.**



- **For battery operation, use only the HIOKI Model PW9002 Battery Set. We do not take any responsibility for accidents or damage related to the use of any other batteries and/or screws.**

- **To avoid electric shock, turn off the power switch and disconnect the cords and cables before replacing (removing) the battery pack.**

- **After replacing the battery pack, replace the cover and screws before using the instrument.**

**⚠ CAUTION**

- Do not use the screw holes used for installing the protector or the battery case for other purposes. Doing so may damage the product.
- Avoid using an uninterruptible power supply (UPS) or DC/AC inverter with rectangular wave or pseudo-sine-wave output to power the instrument. Doing so may damage the instrument.



- Install the battery case onto the PW3365 using the screws supplied with the PW9002 (M3 x 25 mm), keeping the protector attached to the case. Installing the battery case with the protector removed or using screws longer than the accompanying screws may damage the PW3365.
- Observe the following to avoid damage to the instrument.
  - Use the battery pack in an ambient temperature range of 0°C to 40°C and charge it in an ambient temperature range of 10°C to 40°C.
  - If the battery pack fails to finish charging within the stipulated time, disconnect the AC adapter to stop charging and contact your dealer or Hioki representative.
  - Consult your dealer or nearest service station should liquid leaks, strange odor, heat, discoloration, deformation and other abnormal conditions occur during use, charging or storage. Should these conditions occur during use or charging, turn off and disconnect the instrument immediately.

**Reference**

- The battery pack is a consumable. If you are able to use the instrument for only a limited period of time despite the battery pack being properly charged, the battery pack's service life is at an end, and it should be replaced.
  - When a battery pack that has not been used for a long time is used, charging may end before the battery pack is fully charged. In such a case, repeat charging and discharging a number of time before use. (A battery pack may also be in such a state immediately after purchase.)
  - When a battery pack is used, the instrument turns off automatically when the capacity drops. Leaving the instrument in this state for a long time may lead to over discharge so be sure to turn off the power switch on the instrument.
-

## Measurement Flowchart

This section presents a series of instrument operations without using the Quick Set function. For more information about the Quick Set function, see the Measurement Guide (published separately in color).

### Measurement preparations

#### At purchase

- Attach the color clips around the voltage sensor cords. (p.28)
- Group together voltage sensor codes. (p.28)
- Attach the color clips around the clamp sensor cords. (p.30)
- Group together clamp sensor codes. (p.30)
- Install the battery pack. (p.32)
- Set the language and measurement object frequency. (p.35)
- Set the clock. (p.36)

Pre-Operation Inspection (p.37)

Inserting an SD memory card (p.38)

Connecting the AC adapter (p.41)

Turning the power on (p.42)

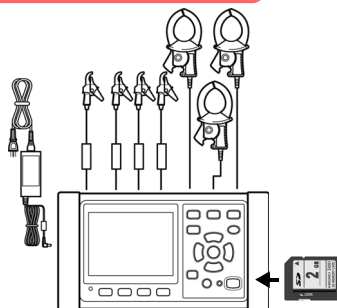

### Connecting voltage sensors to the instrument

Setting measurement conditions on the Wiring Diagram Screen (p.45)

Connecting voltage sensors to the measurement target (p.53)

Connecting clamp sensors to the measurement target (p.55)

Connecting to Target to be Measured (p.57)(p.60)

Checking the current range (p.63)

Verifying that the proper wiring method is being used(p.65)

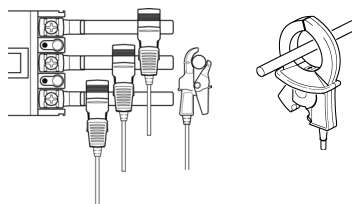

Wiring Check screen

## Measurement Flowchart

### Recording settings(p.78)

Save destination

Folder/File name

Clock (p.36)

Save interval

Recording start

Change the settings as follows when required.

Save items

Recording stop

- Measurement settings (Calculation selection (p.75), Energy cost (p.76))
- System settings (p.89)
- LAN settings (p.171)

### Viewing measurement data (p.97)

MEASURE

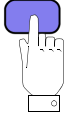

MEAS	LIST	1 YEAR REC	14-05-18
3P4W	I123	9661	500A
U1	222.0 V	I1	30.09 A
U2	215.9 V	I2	30.08 A
U3	218.7 V	I3	29.96 A
f	59.99 Hz	WP+	0.011kWh
P	19.71kW	ELAPSED	0000:00:02
S	19.72kVA		
Q	LEAD 0.66kvar		
PF	LEAD 1.000		

[MEAS, LIST] Screen

### Starting recording (p.118)/ Stopping recording (p.121)

START/STOP

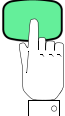

### Measurement is complete

Disconnect the voltage sensors and clamp sensors from the measurement target.

Turn off the instrument. (p.42)

Disconnect the AC adapter, voltage sensors, and clamp sensors from the instrument.

### Analyzing data on a computer (p.149)



# Overview

# Chapter 1

1

Chapter 1 Overview

## 1.1 Product Overview

The PW3365 Clamp on Power Logger is a clamp-type power meter capable of measuring lines with from single-phase to three-phase four-wire. Dedicated voltage sensors can be used to safely measure voltage at all locations, from either insulated wires or exposed metal parts.

### Ability to perform demand measurement

In addition to basic measurement of parameters such as voltage, current, power, power factor, and energy, the instrument can perform demand measurement, an important task in power management.

**See:** "5.7 Viewing a Demand Graph" (p.106)

Demand graph



### Guidance on measurement procedures

The instrument provides guidance on configuring basic settings, connecting the instrument to the measurement target, configuring recording settings, and starting measurement, allowing even users who have never used a power meter before to easily set up the device and perform measurement.

**See:** Quick Set function (p.127),  
Measurement guide (provided separately)

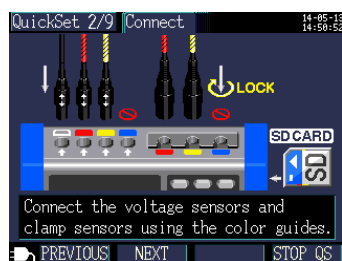

### Ideal for power measurement of commercial frequencies

Since the instrument can automate data collection and measurement over extended periods of time thanks to its SD memory card, USB interface, and LAN interface, it is ideal for power measurement of commercial frequencies in applications such as building and factory power maintenance and management.

**See:** "Chapter 9 Analyzing Data on a Computer" (p.149)  
"Chapter 10 Using Communications (LAN)" (p.169)

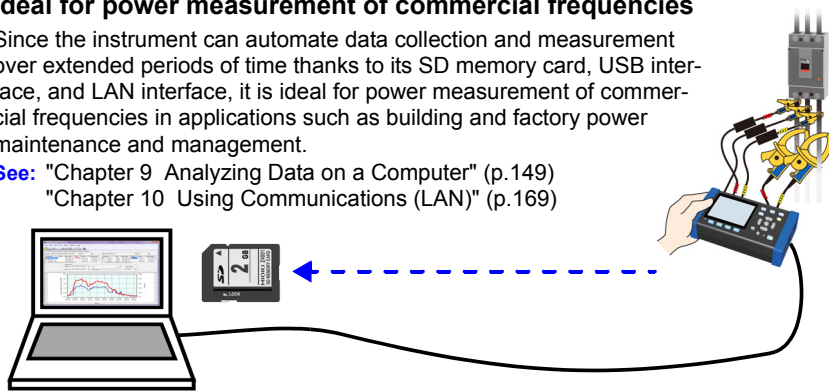

## 1.2 Features

### ◆ Ability to perform measurement safely using metal contactless voltage sensors

The PW9020 Voltage Sensor can be used to measure voltage from insulated wires. Since no contact is made with metal parts, measurement can be performed safely. The PW9020 features a safe design that is compatible with CAT IV (300 V) and CAT III (600 V) use.

### ◆ Quick Set function

Simply follow guidance provided by the instrument to set up and operate the instrument by configuring basic settings, connecting the instrument to the measurement target, configuring recording settings, and starting measurement.

**See:** "Chapter 7 Quick Set" (p.127), Measurement guide (published separately in color)

### ◆ Wiring Check (wiring confirmation)

If the instrument has been connected improperly, tips for connecting it properly will be shown.

**See:** "3.9 Verifying Correct Wiring (Wiring Check)" (p.65)

### ◆ Ability to operate for about 5 hours on battery power

Even when AC power is unavailable, the optional battery pack can be used to enable about five hours of measurement.

**See:** "Installing (replacing) the Battery Pack" (p.32)

### ◆ Corresponding to the various power line

The instrument can perform single-phase/2-wire (up to three circuits), single-phase/3-wire, 3-phase/3-wire (2-power measurement/3-power measurement), and 3-phase/4-wire measurement. When performing single-phase/3-wire, or 3-phase/3-wire 2-power measurement, the instrument can perform power and leakage current measurement simultaneously.

**See:** "4.2 Changing Measurement Settings" (p.72)

### ◆ Broad operating temperature range

The instrument can be used at temperatures ranging from 0°C to 50°C. However, the operating temperature range is limited to 0°C to 40°C when operating on battery power.

### ◆ TFT color LCD

The instrument uses an LCD that is easy to see in both dim and bright conditions.

---



◆ **Extensive line of clamp sensors**

Choose the clamp sensor that's right for your application, with models designed for targets ranging from leakage currents to a maximum rating of 5,000 A.

◆ **Ability to store data on SD memory cards**

Used with a high-capacity, 2 GB SD memory card, the instrument can record data continuously for up to one year.

◆ **Communications functionality**

Since the instrument ships standard with USB and LAN interfaces, it can be connected to a computer in order to configure instrument settings, download data, or remotely operate the instrument.

**See:** "Chapter 10 Using Communications (LAN)" (p.169)

---

# 1.3 Names and Functions (PW3365)

**Front**

Screen name\* Tab (Screen name)\* \*: See "1.5 Screen Configuration" (p.22).

**Display**  
3.5" TFT color LCD  
(p.22)

**POWER LED**  
Green lit up:  
Power on (p.42)  
Green flashing:  
Backlight auto-off  
setting on (p.89)

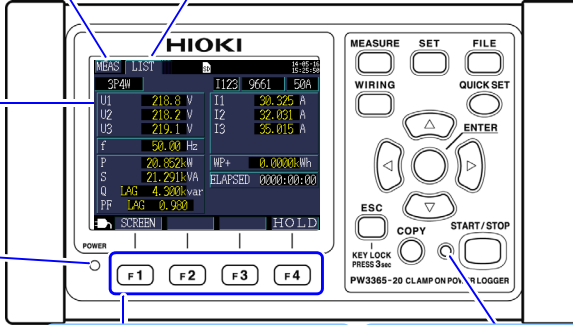

**Function key (F1 to F4 key)**  
Select and change display contents and settings.

**Recording LED**  
Flashing green: When in the recording standby state  
Solid green: When recording

Keys	Description	Reference
	Measurement key. Displays the Measurement screen and switches tabs (screens).	(p.97)
	Settings key. Displays the Settings screen and switches tabs (screens).	(p.71)
	File key. Displays the File (SD memory card/internal memory) screen and switches tabs (screens).	(p.131)
	Wiring key. Displays the Wiring Diagram/Wiring Check screen and switches tabs (screens).	(p.43)
	Quick Set key. Displays the Quick Set screen.	(p.127), Measurement guide
	Cursor keys. Moves the cursor on the screen. The cursor keys are also used to scroll graphs and waveforms. ●: Enter key. Selects items on the screen and accepts changes.	How to change settings and values (p.71)
 KEY LOCK Press 3 sec	Cancel key. Cancels selections and changes, reverting settings to their previous values. Switches to the previous screen. Pressing and holding the ESC key for 3 or more seconds activates the key lock (which is canceled by pressing and holding the key again).	
	Screen Copy key. Outputs an image of the currently displayed screen to the SD memory card.	(p.140)
	Start/Stop key. Starts and stops recording.	(p.117)

## Right

**USB interface**

Connect a computer here using the included USB cable.

See: (p.152)

**SD memory card slot**

Insert an SD memory card here. Be sure to close the cover when recording.

See: (p.38)

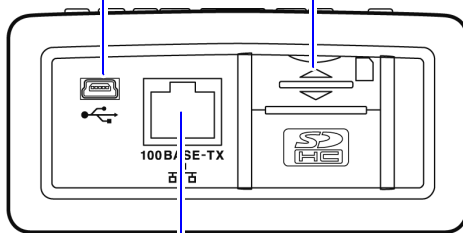
**LAN interface**

Connect a computer here using the optional LAN cable.

See: (p.169)

## Left

**CHARGE LED**

Lights up while the 9459 Battery Pack is charging.

See: (p.32)

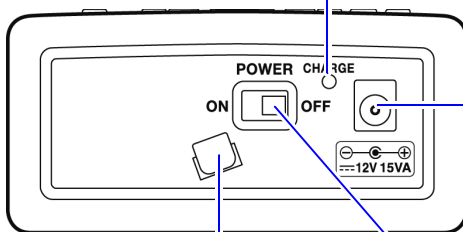
**AC adapter connection jack**

See: (p.41)

**AC adapter hook**

Loop the AC adapter cord through this hook.

See: (p.41)

**POWER switch**

Turns the instrument on and off.

See: (p.42)

### 1.3 Names and Functions (PW3365)

#### Upper

##### Voltage sensor input terminals

Connect the included PW9020 Safety Voltage Sensor here.

##### Current sensor input terminals

Connect optional clamp sensors here.

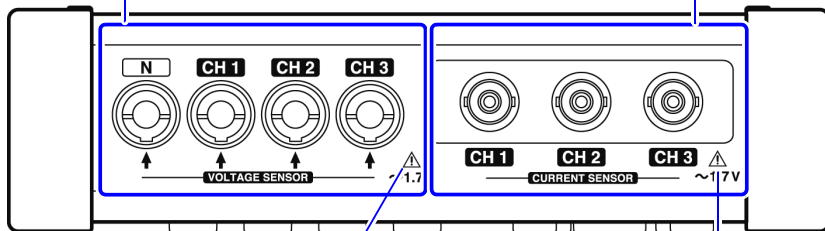

⚠ "3.4 Connecting the Current Sensors to the Instrument" (p.53)

⚠ "3.5 Connecting the Clamp Sensors to the Instrument" (p.55)

#### Back

##### MAC address label

Displays the instrument's unique MAC address, which is used when configuring a LAN connection. Do not remove the label as the information it contains is necessary in order to manage the device.

##### Serial number

The serial number consists of 9 digits. The first two (from the left) indicate the year of manufacture, and the next two indicate the month of manufacture. Required for production control. Do not peel off the label.

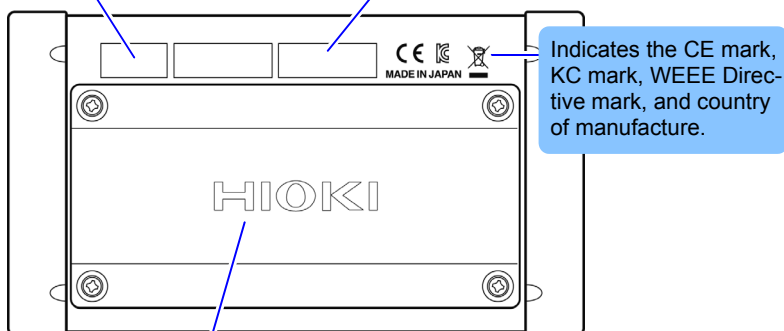

Indicates the CE mark, KC mark, WEEE Directive mark, and country of manufacture.

##### Protector

Remove when using the battery. Connect the PW9002 Battery Set (including the 9459 Battery Pack and a battery case).

See: (p.32)

# 1.4 Names and Functions (PW9020 Safety Voltage Sensor)

## Side

### Clips

Clamp the sensor to the wire and orient it so that the wire coincides to the center of the marks.

### Barriers

To prevent short-circuits and bodily injury, do not touch the sensor in front of these barriers while connecting it.

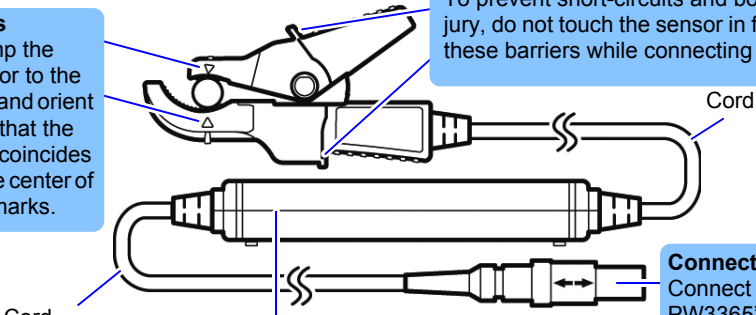

### Relay box

Incorporates electronic circuitry. Do not drop or subject to excessive force.

### Connector

Connect to the PW3365's voltage sensor input terminals.

## Upper

## Bottom

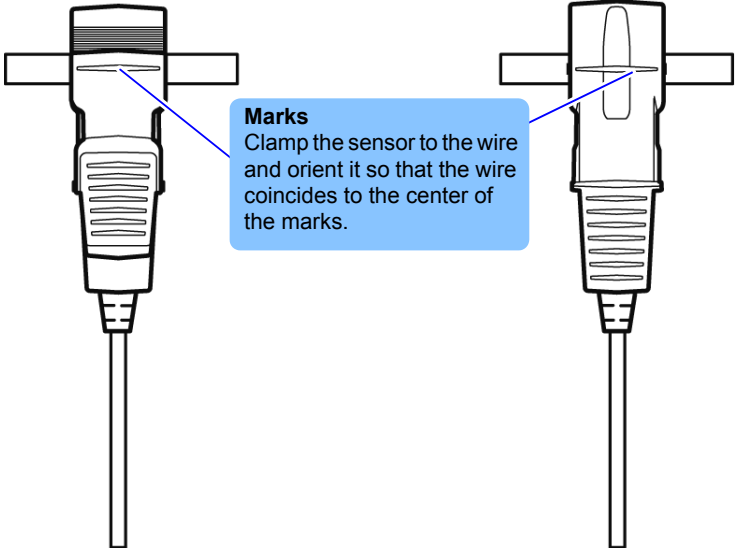

### Marks

Clamp the sensor to the wire and orient it so that the wire coincides to the center of the marks.

# 1.5 Screen Configuration

## Measurement Screen

Tab (displays current screen name)

Bottom screen: Measurement screen's list screen (shown as [MEAS, LIST] in this manual)



See: "Chapter 5 Viewing Measurement Data" (p.97)

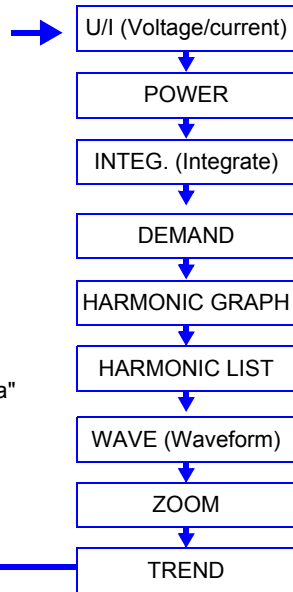

## Setting Screen

There are a total of seven Setting screens.

This field indicates which screen is being displayed.

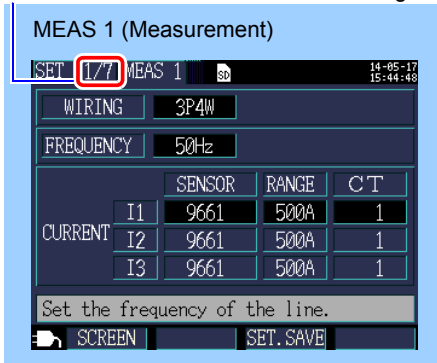

See: "Chapter 4 Changing Settings" (p.71)

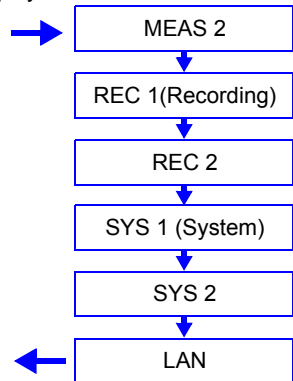

Pressing each of the following keys switches the screens.

Pressing the **ESC** key returns the screen to the previous screen.

## File Screen

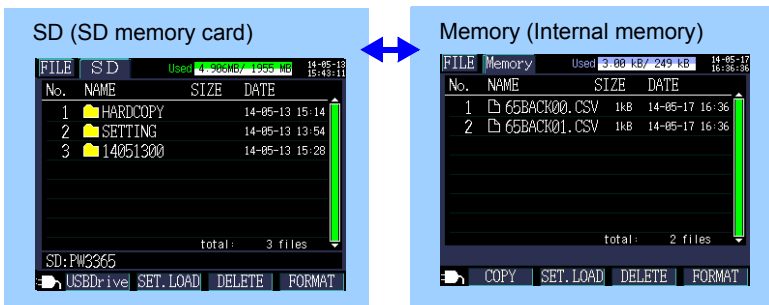

See: "Chapter 8 Saving Data and Manipulating Files" (p.131)

## Wiring Screen

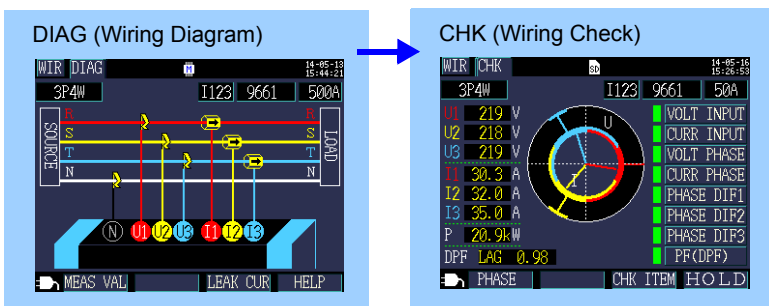





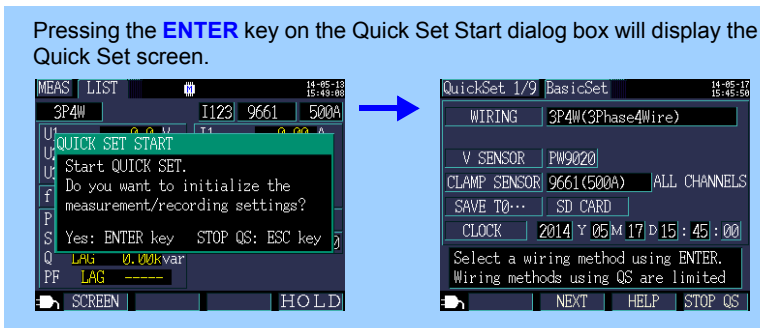











See: "Chapter 3 Connecting to Target to be Measured" (p.43)

## Quick Set Screen





See: "Chapter 7 Quick Set" (p.127),  
Measurement guide (published separately in color)

## 1.6 On-Screen Indicators

Marks	Description
	Lights up when the save destination is <b>[SD CARD]</b> and an SD memory card is loaded in the instrument.
	Lights red when the SD memory card is being accessed.
	Lights up when the save destination is <b>[INTERNAL M]</b> (instrument's internal memory). Lights up when recording is started with the save destination set to <b>[SD CARD]</b> but no card inserted (in this case, data will be saved to the instrument's internal memory).
	Lights red when the instrument's internal memory is being accessed.
	Lights up when data is being sent and received over the LAN interface. (p.169)
	Lights up when data is being sent and received using the HTTP server function. (p.176)
	Lights up when data is being sent and received via both the LAN interface and the HTTP server function.
	Lights up when data is being sent and received over the USB interface.
	Lights up while recording and measurement are being performed.
	Lights up while the instrument is standing by for recording and measurement to start.
	Indicates how much recording time remains on the SD memory card or in the instrument's internal memory.
	Lights up when the voltage exceeds the peak.
	Lights up when the current exceeds the peak.
	Lights up when the key lock has been activated. (p.18)
	Shown instead of the measured value when the upper limit of the display range has been exceeded (p.188), causing the value to be over-range. If the voltage is over-range, the voltage that the instrument is capable of measuring is being exceeded. Immediately disconnect the instrument. If the current is over-range, increase the current range.
	Shown instead of the measured value when measurement is not possible. When there is no input, shown during power factor measurement.



Marks	Description
	Lights up when the PW3365 is being operated using the AC adapter. (p.41)
	Lights up when the PW3365 is being operated on battery power. (p.32)
	Lights up when the PW3365 is being operated on battery power and there is inadequate battery life remaining. Connect the AC adapter and charge the battery. (p.32)



# Measurement Preparations

## Chapter 2

2

Chapter 2 Measurement Preparations

Before starting measurement, connect accessories and options to the instrument. Before performing measurement, be sure to review "Operating Precautions" (p.9) and to inspect the instrument, accessories, and options for damage.

### 2.1 Preparation Flowchart

Follow the procedure described below to prepare for measurement.

(At purchase)

- 1 Attach the color clips around the cords. (p.28), (p.30)

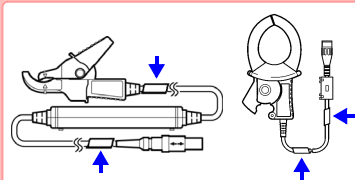

(At purchase)

- 2 Secure the cords together with a black spiral tube. (p.28), (p.30)

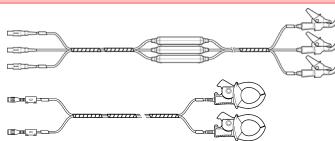

(At purchase)

- 3 Install the battery pack. (p.32)

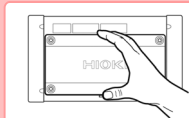

(At purchase)

- 4 Set the language and measurement target frequency. (p.35)

(At purchase)

- 5 Set the Clock. (p.36)

- 6 Perform the pre-operation inspection. (p.37)

- 7 Insert an SD memory card. (p.38)

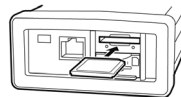

- 8 Connect the AC adapter. (p.41)

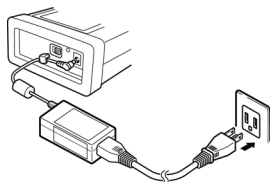

- 9 Turn on the instrument. (p.42)

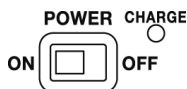

## 2.2 Preparing to Use the Instrument after Purchase



### Attaching Color Clips around Voltage Sensors and Grouping Together Cords

The instrument includes color clips for use with voltage sensors. In order to prevent erroneous connections, these clips are attached around voltage sensor cords and color-coded to help recognize channels. Once you have attached the color clips around the cords, group multiple voltage sensor cords together with the black spiral tubes as necessary.

Measurement target	Voltage sensors (CH, clip color)
Single-phase/2-wire (1P2W)	Two sensors (N none, CH1 red)
Single-phase/3-wire (1P3W1U)	Two sensors (N none, CH1 red)
Single-phase/2-wire (1P3W)	Three sensors (N none, CH1 red, CH2 yellow)
3-phase/3-wire (3P3W2M)	Three sensors (N none, CH1 red, CH2 yellow)
3-phase/3-wire (3P3W3M)	Four sensors (N none, CH1 red, CH2 yellow, CH3 Blue)
3-phase/4-wire(3P4W)	Four sensors (N none, CH1 red, CH2 yellow, CH3 Blue)

#### Preparation items:

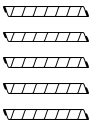
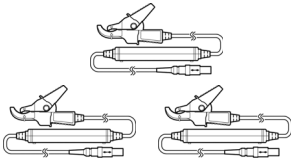
#### single-phase/3-wire (1P3W) and 3-phase/3-wire (3P3W2M)

	Red		Black	
	Yellow			
Four color clips (For color-coding voltage sensors)		Five spiral tubes (For grouping together cords)		PW9020 Safety Voltage Sensor Three voltage sensors in use

- Attach color clips of the same color around the connector and sensor sides of the voltage sensor cord.**

N :Do not attach any clip.  
CH1: Red clips  
CH2: Yellow clips

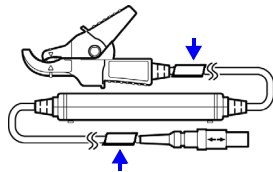

**2** Group together multiple voltage sensor cords with black spiral tubes.

Line up the ends of multiple voltage sensor cords so that they can be more easily grouped together.

Wrap spiral tubes around multiple cords so as to group them together.

The instrument includes five spiral tubes, which should be placed at appropriate intervals.

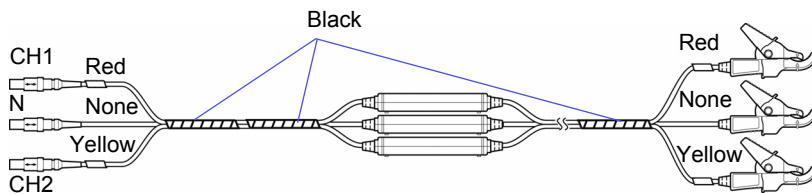

**2.2 Preparing to Use the Instrument after Purchase**

**Attaching Color Clips around Clamp Sensors and Grouping Together Cords**

The instrument includes color clips for use with clamp sensors. In order to prevent erroneous connections, these clips are attached around clamp sensor cords and color-coded to help recognize channels. Once you have attached the color clips around the cords, group multiple clamp sensor cords together with the black spiral tubes as necessary.

Measurement target	Clamp sensors (CH, clip color)
Single-phase/2-wire (1P2W)	One sensor (CH1 red)
Single-phase/2-wire (1P2W) (2 circuit)	Two sensors (CH1 red, CH2 yellow)
Single-phase/2-wire (1P2W) (3 circuits)	Three sensors (CH1 red, CH2 yellow, CH3 blue)
Single-phase/3-wire (1P3W)	Two sensors (CH1 red, CH2 yellow)
Single-phase/3-wire (1P3W)+current only	Three sensors (CH1 red, CH2 yellow, CH3 blue)
3-phase/3-wire (3P3W2M)	Two sensors (CH1 red, CH2 yellow)
3-phase/3-wire (3P3W2M)+current only	Three sensors (CH1 red, CH2 yellow, CH3 blue)
3-phase/3-wire (3P3W3M)	
3-phase/4-wire (3P4W)	

**Preparation items:**

**single-phase/3-wire (1P3W) and 3-phase/3-wire (3P3W2M)**

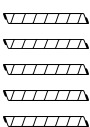
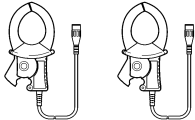
 <p>Red</p> <p>Yellow</p>	 <p>Black</p>	<p>Model 9661</p> 
<p>Four color clips (For color-coding voltage sensors)</p>	<p>Five spiral tubes (For grouping together cords)</p>	<p>Two clamp sensors in use</p>

- Attach color clips of the same color around the connector and sensor sides of the voltage sensor cord.**

CH1: Red  
CH2: Yellow

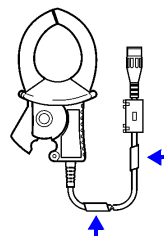

**2 Group together multiple clamp sensor cords with black spiral tubes.**

Line up the ends of multiple clamp sensor cords so that they can be more easily grouped together.

Wrap spiral tubes around multiple cords so as to group them together.

The instrument includes five spiral tubes, which should be placed at appropriate intervals.

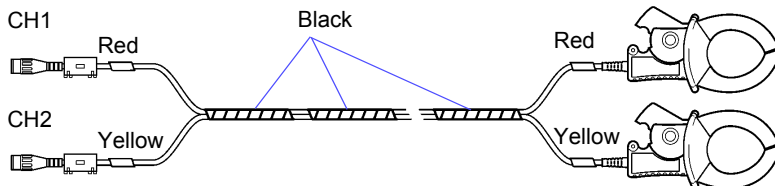

**Installing (replacing) the Battery Pack**

- The battery pack is used to power the instrument during power outages and as a backup power supply. When fully charged, it can provide backup power for approximately 5 hours in the event of a power outage.
- Note that if a power outage occurs while the battery pack is not being used, displayed measurement data will be erased. (Data that has been recorded on the SD memory card and instrument's internal memory is retained.)
- The battery pack is subject to self-discharge. Be sure to charge the battery pack before initial use. If the battery capacity remains very low after correct recharging, the useful battery life is at an end.
- For more information about the operating temperature and humidity range and the storage temperature and humidity range, see "Chapter 11 Specifications" (p.185).

**CAUTION**  When removing the PW9002 Battery Set from the back of the instrument and operating the instrument without the battery pack installed, attach the protector, following Step 2 to 7 in reverse order. Attach the protector using the four accompanying screws (M3×6 mm), which secured the protector onto the instrument when you received the instrument. Securing the protector using screws longer than the accompanying screws may damage the instrument.

**Reference** To remove the 9459 Battery Pack, follow Step 4 to 7 in reverse order.

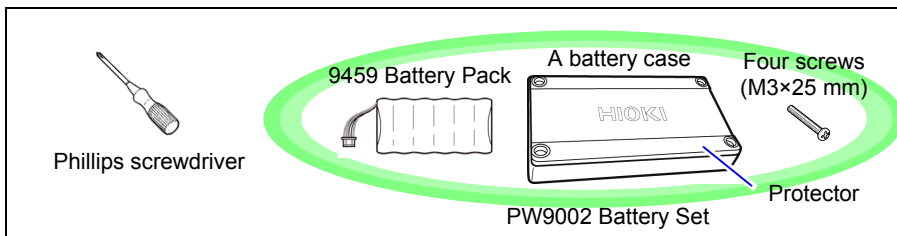
**Preparation items****Procedure**

- 1** Turn off the **POWER** switch and remove all cords and cables.



- 2** Turn the instrument over and use a Phillips screwdriver to remove the screws holding the protector in place.

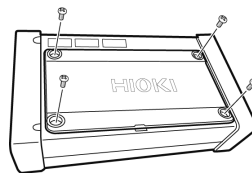

- 3** Remove the protector from the recessed area in the case.

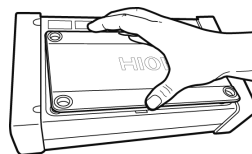

Store the protector and the four screws (M3×6 mm) you removed with care because you will need them when not using the PW9002 Battery Set.



- 4** Fit the 9459 Battery Pack into the battery case.

Position the battery pack so that the cables are routed through the cutout in the case.

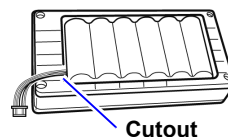

### Reference

When the PW9002 Battery Set is shipped from Hioki factory, the 9459 Battery Pack has already fit into the battery case.

- 5** Insert the connector from the battery pack into the port on the instrument.

Take care to orient the connector properly and insert it as far as it will go.

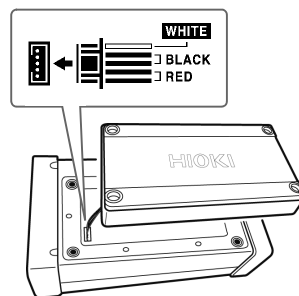

## 2.2 Preparing to Use the Instrument after Purchase

- 6** With the battery case facing down, fit it into the recessed area on the instrument.

Exercise care not to pinch the battery pack's wires between the battery case and the instrument.

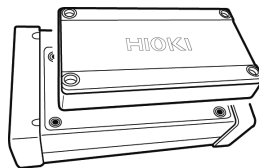

- 7** Install the battery case onto the instrument using the four dedicated screws (M3×25 mm) that come with Model PW9002 Battery Set.

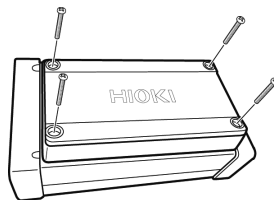

- 8** Connect the AC adapter (p.41) to the instrument to charge the battery pack.

The battery pack will be charged regardless of whether the power is on.

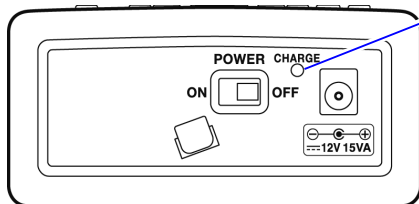

### CHARGE LED

On (red) : Charging  
 Off : Fully charged/when the battery pack is not attached

(Left side of the PW3365)

## Setting the Language and Measurement Target Frequency (50 Hz/60 Hz)

When you turn on the instrument (p.42) for the first time after purchase, the Language Setting screen and Frequency Setting screen will be displayed. Configure the settings as desired. Similarly, these settings must be configured if a factory reset is performed to reset the instrument to its default settings.

**See:** "Reverting All Settings to the Factory Defaults (Factory Reset)" (p.93)

**Reference** Once you have set the display language and frequency, this settings screen will not be shown again when the instrument is turned on. The settings can be changed at any time on the Settings screen.

**See:** Language setting: "System 1 Setting Screen" (p.89)

**See:** Frequency setting: "Measurement 1 Setting Screen" (p.72)

### 1 Turn on the POWER switch.

The Language Setting screen will be displayed.

### 2 Select the desired language with the function keys.

The language will be set, and the Frequency Setting screen will be displayed.

#### Reference

Pressing the **F4** key **[OTHERS]** enables you to select a language between JAPANESE, ENGLISH, CHINESE, GERMAN, ITALIAN, FRENCH, SPANISH, TURKISH, and KOREAN.



### 3 Select the desired measurement line frequency with the function keys.

#### Select

**F1:** 50 Hz range, **F2:** 60 Hz range

Select the measurement target's frequency.

The frequency will be set, and the **[MEAS, LIST]** screen will be displayed.

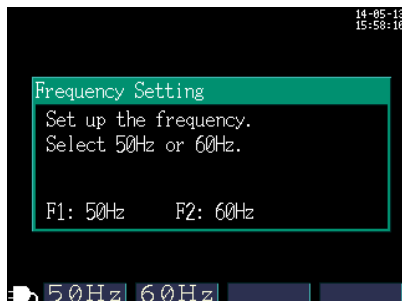

**Setting the Clock**

Set the clock before performing measurement. The clock will also need to be set if you perform a factory reset to revert the instrument to its default settings.

**See:** "Reverting All Settings to the Factory Defaults (Factory Reset)" (p.93)

Once the instrument has been used for an extended period of time, the clock may not show the correct time. Check the clock regularly and re-set it as necessary.

**1**



Press the  key to display the **[SET5/7, SYS1]** screen.

**2**

Move the cursor to the setting you wish to change and press the  **[ENTER]** key.

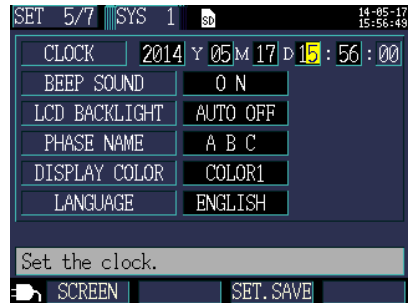
The cursor will expand to the size of one digit, and you will be able to change the digit.

**3**

Change the value with the cursor's  /  keys and then press the  **[ENTER]** key to accept the setting.

## 2.3 Pre-Operation Inspection

Before using the instrument, verify that it operates normally to ensure that no damage occurred during storage or shipping. If you find any damage, contact your authorized Hioki distributor or reseller.

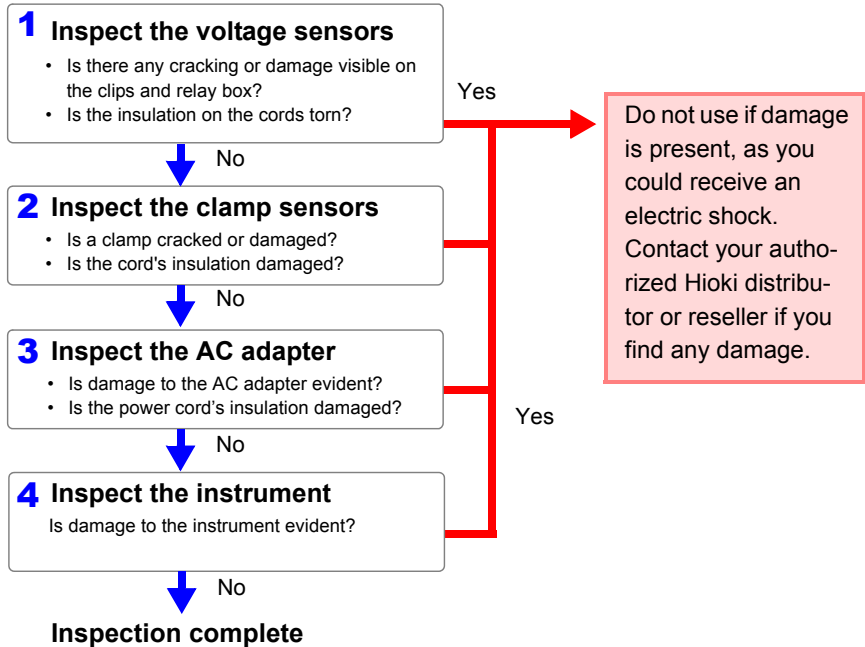

## 2.4 Inserting (Removing) an SD Memory Card

Measurement data can be stored either on SD memory cards or in the instrument's internal memory.

When saving data on an SD memory card, insert an SD memory card and select **[SD CARD]** as the storage destination on the **[SET3/7, REC1]** screen.

### CAUTION



- Inserting a SD memory card upside down, backwards or in the wrong direction may damage the instrument.
- Some SD memory cards are susceptible to static electricity. Exercise care when using such products because static electricity could damage the SD memory card or cause malfunction of the instrument.

### IMPORTANT

- Use only HIOKI-approved SD memory cards. Other SD memory cards may not work with the instrument, and Hioki is unable to guarantee proper operation.
- Format SD memory cards with the instrument. Using a computer to format the card may reduce the card's performance.  
**See:** "8.8 Formatting the SD Memory Card or Internal Memory" (p.146)
- No compensation is available for loss of data stored on the SD memory card, regardless of the content or cause of damage or loss. Be sure to back up any important data stored on an SD memory card.
- Observe the following to avoid corruption or loss of stored data:
  - (1) Do not touch the electrical contacts on the card or inside the insertion slot with your skin or metallic objects.
  - (2) While writing or reading data, avoid vibration or shock, and do not turn the power off or remove the card from the instrument.
  - (3) Before formatting (initializing) a card, confirm that it contains no important information (files).
  - (4) Do not bend or drop the card, or otherwise subject it to intense shock.

- Reference** • The operating lifetime of the SD memory card is limited by its flash memory. After long-term or frequent usage, data reading and writing capabilities will be degraded. In that case, replace the card with a new one.
- If you are unable to write data to an SD memory card, manipulate folders and files, or format the card, check the position of the write-protect lock and disengage it if necessary.  
The SD memory card's connector is used to judge whether the card is write-protected. If the write-protected lock is in an intermediate position, the determination of whether the card is write-protected will depend on the connector. For example, even if the instrument determines that the card is not write-protected and allows data to be written to it, a computer may determine that it is write-protected, preventing data from being written to it.

## 2.4 Inserting (Removing) an SD Memory Card

### Inserting the SD memory card

- 1 Turn off the POWER switch.

- 2 Open the SD memory card slot cover.

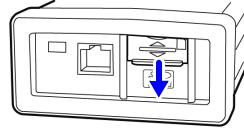

- 3 Disengage the SD memory card's write-protect lock.



- 4 Positioning the SD memory card with the top surface facing up, insert it into the slot in the direction shown by the arrow and push it all the way in.

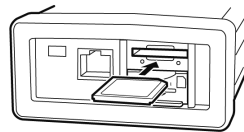

Keep the card level as you insert it. Inserting it at an angle may cause the write-protect lock to engage, preventing data from being written to the card.

- 5 Close the SD memory card slot cover.

Be sure to close the cover.

Format new SD memory cards before use.

**See:** "8.8 Formatting the SD Memory Card or Internal Memory" (p.146)

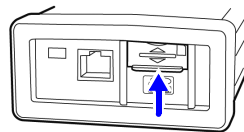

To remove the card, open the cover and push in the SD memory card.

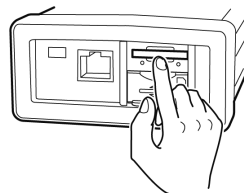



## 2.5 Connecting the AC Adapter

### ⚠ WARNING



- Use only the specified Model Z1008 AC Adapter. AC adapter input voltage range is 100 to 240 V AC at 50 Hz/60 Hz. To avoid electrical hazards and damage to the instrument, do not apply voltage outside of this range.
- To avoid electrical accidents and to maintain the safety specifications of this instrument, connect the power cord provided only to a 3-contact (two-conductor + ground) outlet.

### ⚠ CAUTION



To avoid damaging the power cord, grasp the plug, not the cord, when unplugging it from the power outlet.

**Reference** Make sure the power is turned off before connecting or disconnecting the AC adapter.

Connect the Z1008 AC Adapter to the instrument and plug it into an outlet as follows:

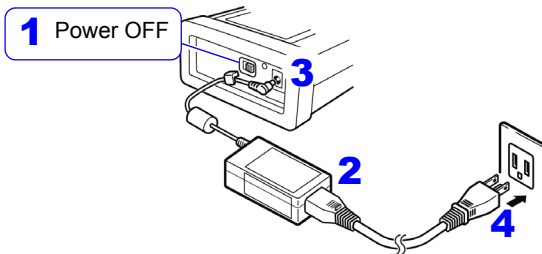

**1** Turn off the **POWER** switch.

**2** Connect the power cord to the inlet on the AC adapter.

**3** Connect the AC adapter's output plug to the instrument.

Once the output plug is connected, route the cord underneath the hook (to keep it from being pulled out).

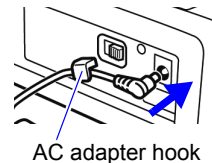

**4** Connect the power cord's input plug to an outlet.

## 2.6 Turning the Power On/Off

Turn on the instrument. After use, always turn off the power.

### ⚠ WARNING



Before turning the instrument on, make sure the supply voltage matches that indicated on the AC adapter. Connection to an improper supply voltage may damage the instrument or AC adapter and present an electrical hazard.

### ⚠ CAUTION



- If the instrument fails to turn on when using the AC adapter, there may be a break in the power cord or an AC adapter or internal instrument malfunction. Contact your authorized Hioki distributor or reseller.
- If the instrument encounters an error during the self-test, the instrument is damaged. Contact your authorized Hioki distributor or reseller.

### Powering On

Turn on the POWER switch. When the instrument is turned on, the Self-test screen will be displayed. Once the self-test is complete, the Measurement screen will be displayed.

See: "Chapter 7 Quick Set" (p.127), Measurement guide (published separately in color)

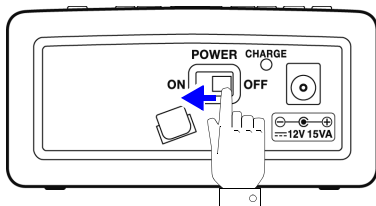

Model No.  
of the  
instrument  
Internal  
memory test  
result  
Version

Screen after the power is turned on  
(Self-test screen)

Measurement screen

**Reference** If **[QUICK SET at PWR ON]** on the **[SET6/7, SYS2]** screen is on, the Quick Set start dialog will be displayed after the self-test is complete. (Initial setting: OFF)

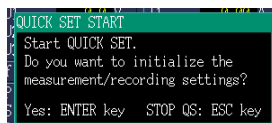

### Powering Off

Turn the POWER switch off.

# Connecting to Target to be Measured

## Chapter 3

### 3.1 Checking the Equipment before Connecting the Instrument

Please read the "Operating Precautions" (p.9) before making connections.

#### DANGER



- Voltage sensor and clamp sensor should only be connected to the secondary side of a breaker, so the breaker can prevent an accident if a short circuit occurs. Connections should never be made to the primary side of a breaker, because unrestricted current flow could cause a serious accident if a short circuit occurs.
- To prevent electrical shock and personnel injury, do not touch any input terminals on the VT (PT), CT or the instrument when they are in operation.
- The PW9020 Voltage Sensor's maximum rated conductor-to-ground voltages are as follows:  
(CAT III) 600 V AC, (CAT IV) 300 V AC  
Attempting to measure voltages exceeding this level with respect to ground could damage the instrument and result in personal injury.

#### CAUTION



- To avoid damaging the instrument, do not short the voltage sensor input terminals or current sensor input terminals or input any voltage to them.
- To ensure safe operation, use only voltage sensor and clamp sensor specified by our company.

# 3.2 Connection Procedure

Connect the instrument as follows:

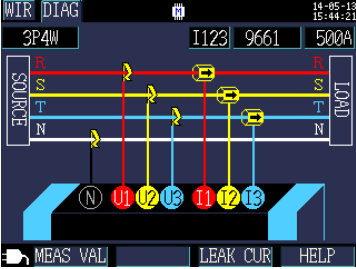
**1**   Set the measurement conditions. (p.45)

**[WIR, DIAG]** screen (Wiring diagram screen)

**2** Connect to the instrument. (p.53)

**3** Connect to the instrument. (p.55)

**4** Connect to the measurement target. (p.57)

**5** Connect to the measurement target. (p.60)

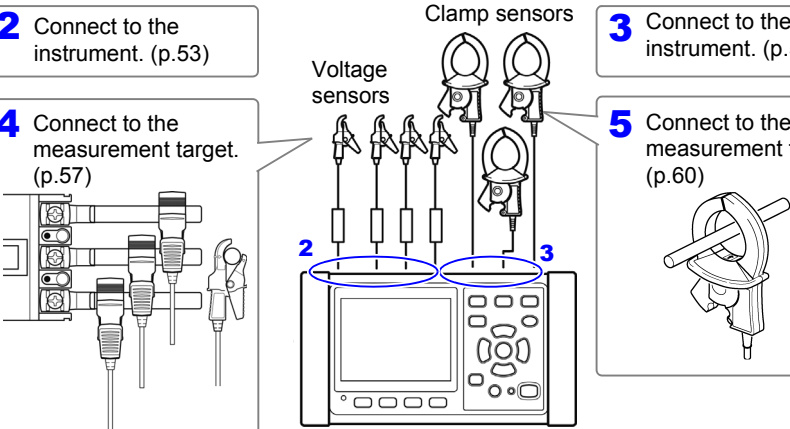

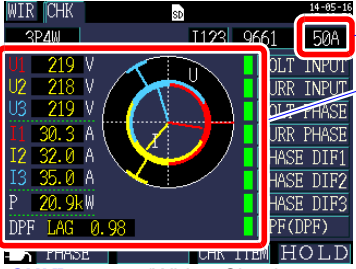
**6**   Check the current range. (p.63)

Check the wirings. (p.65)

**[WIR, CHK]** screen (Wiring Check screen)

## 3.3 Setting Measurement Conditions on the Wiring Diagram Screen

Display the **[WIR, DIAG]** screen and set the wiring method, clamp sensor, and current range as described below.

### Changing an item

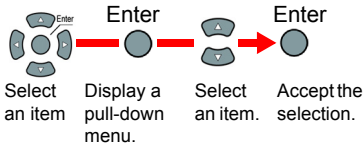

1

Press the **WIRING** key to display the **[WIR, DIAG]** screen.

2

Select the wiring method.

Select

1P2W  
1P3W  
1P3W1U  
3P3W2M  
3P3W3M  
3P4W  
I only

For more information about settings, see the chart below.

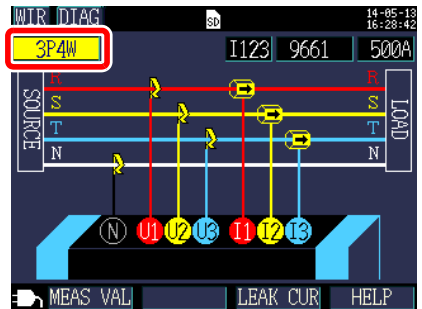

3

**3.3 Setting Measurement Conditions on the Wiring Diagram Screen**

**Selecting the wiring method**

Wiring selection	Sub-selection	Name	Detailed description	[WIR, DIAG] Screen (Wiring diagram screen)
1P2W	x1 x2 x3	Single-phase/2-wire lines	If the single-phase/2-wire lines share the same voltage, you can select from 1 to 3 circuits with the sub-selection. To use only 1P2W measurement and current, use either <b>[1P2Wx2]</b> or <b>[1P2Wx3]</b> . You cannot select the 9657-10 or 9675 Clamp on Leak Sensor.	
1P3W	OFF +I	Single-phase/3-wire lines	The sub-selection allows you to measure current only (+I) for current CH3 in addition to performing normal 1P3W measurement (OFF).	
1P3W1U	OFF +I	Single-phase/3-wire lines (1-voltage measurement)	In 1P3W1U measurement, you can easily measure voltage for single-phase/3-wire lines using only CH1. The CH2 voltage RMS value (U2) is temporarily set to the CH1 voltage RMS value (U1) to calculate the 1P3W power. The sub-selection allows you to measure current only (+I) for current CH3 in addition to performing normal 1P3W1U measurement (OFF).	

### 3.3 Setting Measurement Conditions on the Wiring Diagram Screen

#### Selecting the wiring method

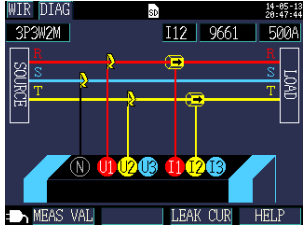
Wiring selection	Sub - selection	Name	Detailed description	[WIR, DIAG] Screen (Wiring diagram screen)
3P3W2M	OFF +I	3-phase/3-wire lines (2-power method)	<p>Three-phase/3-wire measurement is performed from two line-to-line voltages and two line currents. U12 is calculated from U1 and U2, and I12 is calculated from I1 and I2.</p> <p>Although the total active power is the same as 3P3W3M, 3P3W3M is used when measuring the power of individual phases, since that measurement cannot be performed using 3P3W2M.</p> <p><b>See:</b> "Appendix 3 Three-phase 3-wire Measurement" (p.A2)</p> <p>The sub-selection allows you to measure current only (+I) for current CH3 in addition to performing normal 3P3W2M measurement (OFF).</p>	

**3.3 Setting Measurement Conditions on the Wiring Diagram Screen**

**Selecting the wiring method**

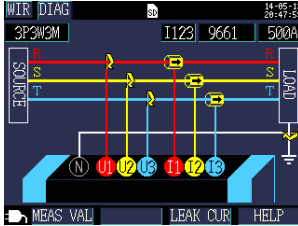
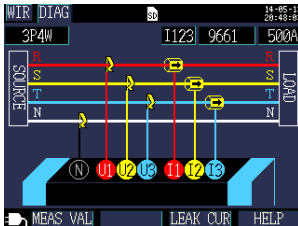
Wiring selection	Sub - selection	Name	Detailed description	[WIR, DIAG] Screen (Wiring diagram screen)
3P3W3M	-	3-phase/3-wire lines (3-power method)	<p>In 3P3W3M measurement, you can measure 3-phase/3-wire lines from three conductor-to-ground voltages (phase voltages from the virtual neutral point) and three wire currents using the load-side grounding wire or a grounded metal part as a virtual neutral point. 3P3W3M measurement can be performed when the measurement target is connected via Y wiring. To measure a target connected via Δ wiring, use the 3P3W2M setting.</p> <p><b>See:</b> "Appendix 3 Three-phase 3-wire Measurement" (p.A2)</p> <p>This setting is used when you wish to check the line voltage for a 3-phase/4-wire line. The 9657-10 and 9675 Clamp On Leak Sensors cannot be used with this setting.</p>	
3P4W	-	3-phase/4-wire lines	<p>In 3P4W measurement, you can measure 3-phase/4-wire lines from three phase voltages and three phase currents (line currents). To check line voltages, use the 3P3W3M wiring setting with 3P4W wiring. You cannot select the 9657-10 or 9675 Clamp on Leak Sensor.</p>	



### 3.3 Setting Measurement Conditions on the Wiring Diagram Screen

#### Selecting the wiring method

Wiring selection	Sub - selection	Name	Detailed description	[WIR, DIAG] Screen (Wiring diagram screen)
I only	x1 x2 x3	Current only	Use this setting when you wish to measure only current and not voltage. The sub-selection allows you to select from one to three circuits.	

**Reference** Four PW9020 Voltage Sensors are required when performing measurement using the [3P3W3M] or [3P4W] setting. Since the instrument only includes three of the sensors, you will need to purchase one additional PW9020 Voltage Sensor.

### 3

(When measuring multiple circuits only)  
Select the current channel.

#### Select

1P2Wx2	I1, I2
1P2Wx3	I1, I2, I3
1P3W+I	I12, I3
1P3W1U+I	I12, I3
3P3W2M+I	I12, I3
I onlyx2 (Ix2)	I1, I2
I onlyx3 (Ix3)	I1, I2, I3

#### Reference

Select each channel and set the clamp sensor (see Step 4) and current range (see Step 5) for each.

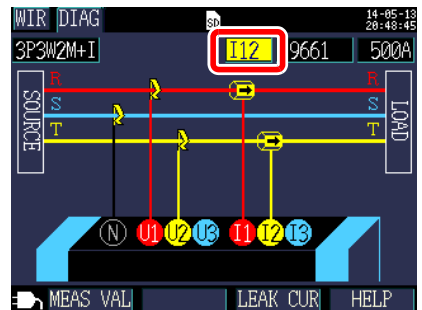

### 3.3 Setting Measurement Conditions on the Wiring Diagram Screen

#### 4 Select the clamp sensor.

##### Select

9660	Load current (power) measurement sensors
9661	
CT9667-500A	
CT9667-5kA	
9669	
9694	
9695-02	
9695-03	Leakage current measurement sen- sors
9657-10	
9675	

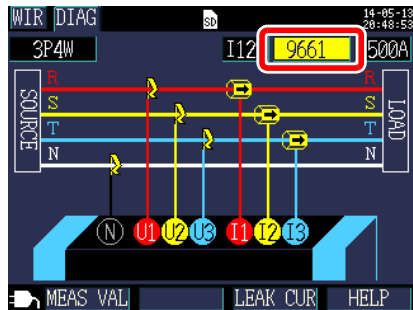

#### Reference

- When measuring power lines using multiple channels, combine multiple clamp sensor types.  
For example, when measuring 3-phase/4-wire lines, use the same clamp sensor for channels 1 to 3.
- When using the CT9667 Flexible Clamp on Sensor, use the same value for the sensor range setting and the instrument's clamp sensor range setting.
- When using the 9667 Flexible Clamp on Sensor, select the CT9667.
- Because the 9657-10 and 9675 Clamp On Leak Sensors have a large phase error, they cannot be selected for power measurement. Only channel 3 (**[I3]**) can be selected when the wiring method is **[I only]**, or when **[+I]** has been set with the sub-selection.

### 3.3 Setting Measurement Conditions on the Wiring Diagram Screen

#### 5 Select the current range.

##### Select

9660	5A, 10A, 50A, 100A
9661	5A, 10A, 50A, 100A, 500A
CT9667-500A	50A, 100A, 500A
CT9667-5kA	500A, 1kA, 5kA
9669	100A, 200A, 1kA
9694	500mA, 1A, 5A, 10A, 50A
9695-02	
9695-03	5A, 10A, 50A, 100A
9657-10	50mA, 100mA,
9675	500mA, 1A, 5A

##### Reference

If you do not know the appropriate range, configure the current range setting while checking the current value on the [WIR, CHK] screen after connecting the instrument.

**See:** "Selecting an appropriate range" (p.63)

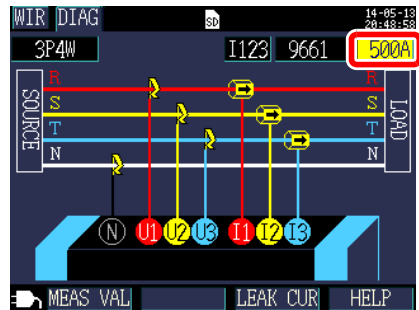

### 3.3 Setting Measurement Conditions on the Wiring Diagram Screen

**Reference** The wiring method, clamp sensor, and current range settings can be configured on the following screens. The CT ratio and VT (PT) ratio settings, if needed, can be configured on the Settings screen.

**See:** "4.2 Changing Measurement Settings" (p.72)



**[MEAS, LIST]** screen  
(Measurement screen)

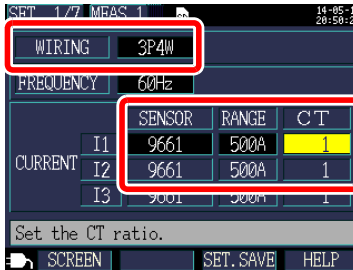

**[SET1/7, MEAS1]** screen  
(Settings screen)

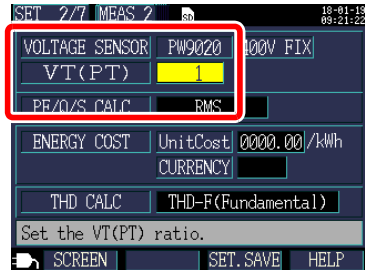

**[SET2/7, MEAS2]** screen  
(Setting screen)

## 3.4 Connecting the Current Sensors to the Instrument

### ⚠ CAUTION



- To avoid electric shock and short-circuit accidents, use only the specified PW9020 Safety Voltage Sensor to connect the instrument input terminals to the circuit to be tested.
- When disconnecting the PW9020 Voltage Sensor from the instrument, be sure to grip the part of the connector indicated by the arrows and pull it straight out. Gripping any other part of the connector and pulling too hard will damage the connector.

Connect the PW9020 Voltage Sensors to the instrument's voltage sensor input terminals while checking the channel on the **[WIR, DIAG]** screen.

To make it easier to identify channels, color-code the cords with color clips and bundle them together.

**See:** "Attaching Color Clips around Voltage Sensors and Grouping Together Cords" (p.28)

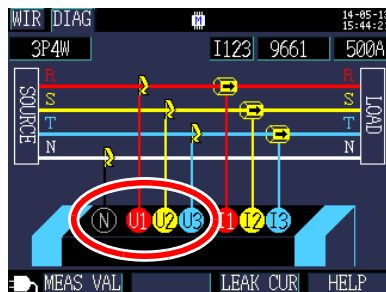

Voltage sensor input terminals

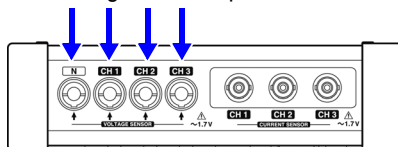

Measuring Object	Voltage Sensors (CH, clip color)
Single-phase/2-wire (1P2W), Single-phase/3-wire (1P3W1U)	Two (N none, CH1 red)
Single-phase/3-wire (1P3W) 3-phase/3-wire (3P3W2M)	Three (N none, CH1 red, CH2 yellow)
3-phase/3-wire (3P3W3M)	Four (N none, CH1 red, CH2 yellow, CH3 blue)
3-phase/4-wire (3P4W)	

## 3.4 Connecting the Current Sensors to the Instrument

**Align the arrow marks on the voltage sensor connector and voltage sensor input terminal and insert.**

To disconnect the sensor, grip the part of the connector indicated by the arrow and pull it straight out.

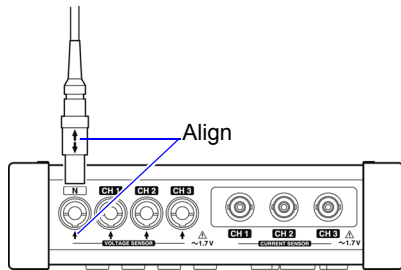

## 3.5 Connecting the Clamp Sensors to the Instrument

**CAUTION** To prevent damage to the connector, be sure to release the locking mechanism, grip the head of the connector (not the cord), and pull it out.

Connect the optional clamp sensors to the instrument's current sensor input terminals while checking the **[WIR, DIAG]** screen.

To make it easier to identify channels, color-code the cords with color clips and bundle them together.

**See:** "Attaching Color Clips around Clamp Sensors and Grouping Together Cords" (p.30)

See the instruction manual supplied with the clamp sensor for specification details and usage procedures.

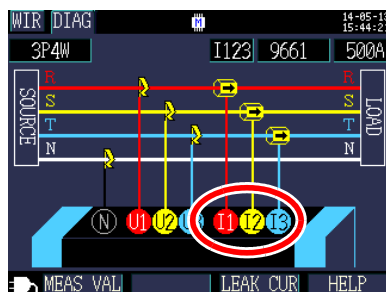

Current sensor input terminals

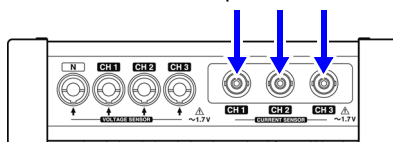

Measurement target	Wiring selection	Clamp sensors (CH, spiral tube color)
Single-phase/2-wire	<b>1P2W</b>	one (CH1 red)
Single-phase/2-wire (2 circuit)	<b>1P2W×2</b>	two (CH1 red, CH2 yellow)
Single-phase/2-wire (3 circuits)	<b>1P2W×3</b>	three (CH1 red, CH2 yellow, CH3 blue)
Single-phase/3-wire	<b>1P3W</b>	two (CH1 red, CH2 yellow)
Single-phase/3-wire + current only	<b>1P3W+I</b>	three (CH1 red, CH2 yellow, CH3 blue)
3-phase/3-wire 2-power method	<b>3P3W2M</b>	two (CH1 red, CH2 yellow)
3-phase/3-wire + current only	<b>3P3W2M+I</b>	three (CH1 red, CH2 yellow, CH3 blue)
3-phase/3-wire 3-power method	<b>3P3W3M</b>	
3-phase/4-wire	<b>3P4W</b>	

### 3.5 Connecting the Clamp Sensors to the Instrument

**1** Insert the clamp sensor's BNC connector into the current sensor input terminal.

Align the groove on the BNC connector with the connector guide on the instrument and push it into place.

Connector guides on instrument current sensor input terminal

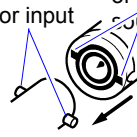

BNC connector of the clamp sensor

**2** Turn the connector clockwise to lock it in place.

To disconnect the connector, turn it counter-clockwise to unlock it and then pull.

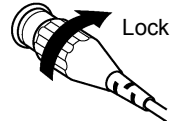



## 3.6 Connecting the Voltage Sensors to Target to be Measured



To avoid short circuits and potentially life-threatening hazards, never attach the voltage sensor to a circuit that operates at more than the maximum rated voltage to earth. Do not grip any sensor in front of the barrier.

### IMPORTANT

If the measurement target is an insulated wire with dirt or moisture on its insulation, the instrument may display lower values than the actual voltage and power. If the surface of the measurement target's insulation has dirt or moisture on it, wipe it clean with a dry cloth before measurement.

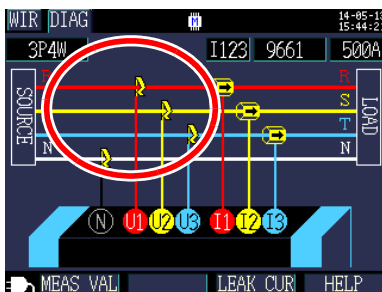

Connect the voltage sensor to the measurement target while checking the wiring target on the [\[WIR, DIAG\]](#) screen.

### 3.6 Connecting the Voltage Sensors to Target to be Measured

#### Proper application

Align the insulated wire or metallic part of the bus bar or other part with the marks on the voltage sensor and clamp the sensor to the wire.

#### **Example: When measuring a thick, insulated wire (with a diameter of 30 mm or less)**

Clamp the sensor to the wire and orient it so that the wire coincides to the center of the marks.

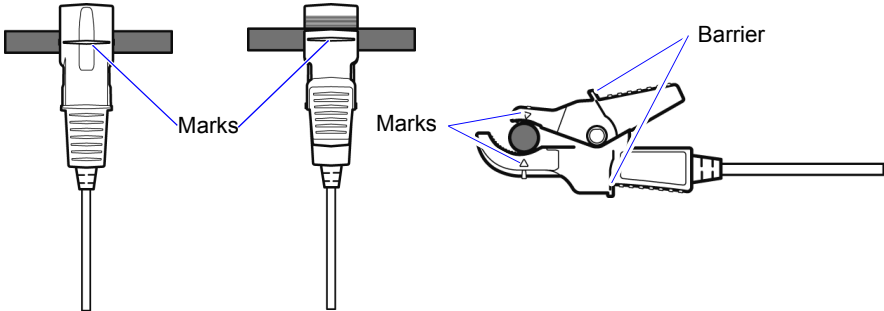

#### **Example: When measuring a thin, insulated wire (with a diameter of at least 6 mm)**

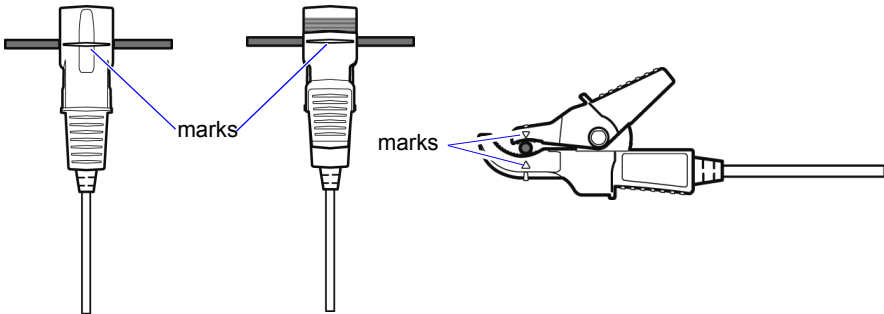

### 3.6 Connecting the Voltage Sensors to Target to be Measured

#### Improper application

Failure to apply the sensor properly will prevent you from being to make an accurate measurement.

#### Example:

Clamped with the tips of the clip

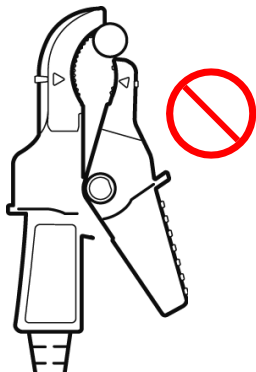

Clamped too far back in the clip

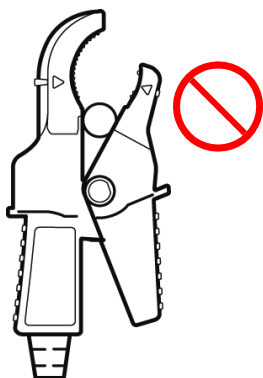

Clamped with the measurement target at an angle

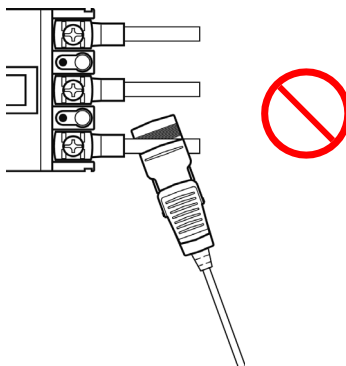

Clamping targets with different voltages at the same time

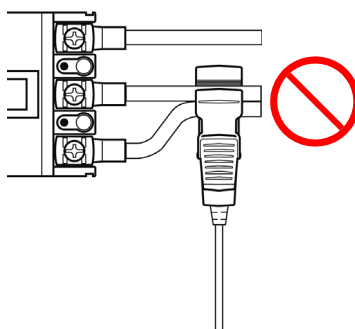

## 3.7 Connecting Clamp Sensors to Target to be Measured

### ⚠ DANGER



- To avoid short circuits and potentially life-threatening hazards, never attach the clamp sensor to a circuit that operates at more than the maximum rated voltage to earth.
- Connect the clamp sensors to the instrument first, and then to the active lines to be measured. Observe the following to avoid electric shock and short circuits.
  - When the clamp sensor is opened, do not short-circuit two wires to be measured by bringing the metal part of the clamp into contact with them, and do not use over bare conductors.

### ⚠ CAUTION



Note that the clamp sensor may be damaged if the current exceeds the maximum input current. For more information about clamp sensor specifications, see the instruction manual that came with the clamp sensor.

Connect the clamp sensor to the measurement target while checking the [\[WIR, DIAG\]](#) screen.

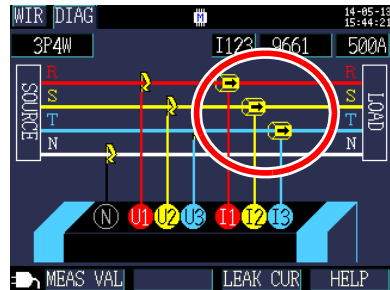

## Load Current Measurement

Make certain that the current flow direction arrow points toward the load.

### Example

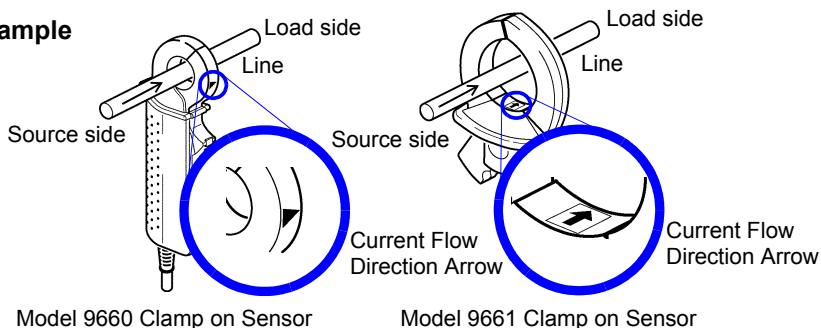

Model 9660 Clamp on Sensor

Model 9661 Clamp on Sensor

Attach the clamp around only one conductor. Single-phase (2-wire) or three-phase (3-wire) cables clamped together will not produce any reading.

### Example

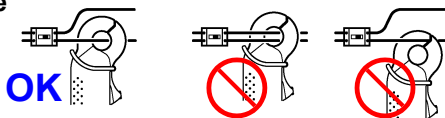

## Leakage Current Measurement

Pressing **F3 [LEAK CUR]** displays a leak current connection diagram.

### Example

single-phase/2-wire: Place the clamp around two wires.  
 single-phase/3-wire: Place the clamp around three wires.  
 3-phase/3-wire: Place the clamp around three wires.  
 3-phase/4-wire: Place the clamp around four wires.  
 Grounding wire: Place the clamp around one wire.

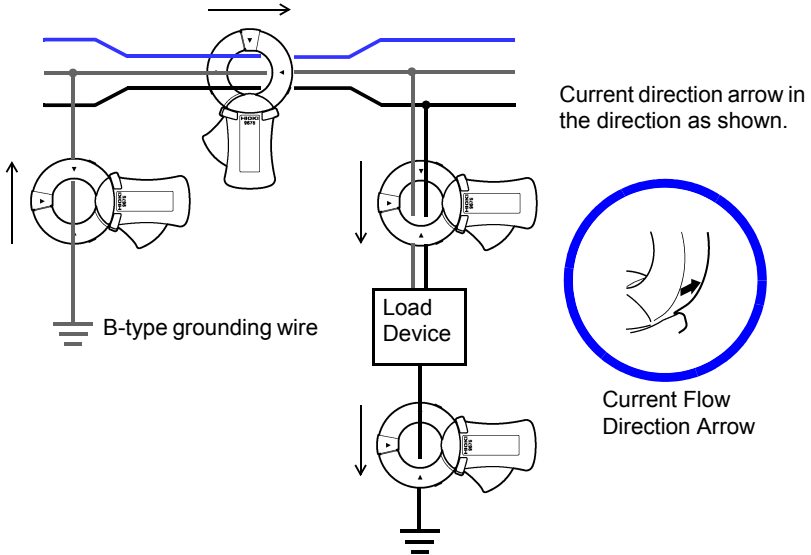

## 3.8 Checking the Current Range

Check the current value on the [WIR, CHK] screen to verify whether the current range is appropriate.

1

Press the  key to display the [WIR, CHK] screen.

2

Check the current value. If it is abnormal, re-set the current range.

### Selecting an appropriate range

Set the current range based on the anticipated maximum load current during the measurement interval. (Refer to the operating status, load rating, breaker rating, and other data to make this determination.) If the range is too low, the instrument will experience an over-range event during measurement, making accurate measurement impossible. If the range is too high, a large error component will result, making accurate measurement impossible.



### Select

9660	5A, 10A, 50A, 100A
9661	5A, 10A, 50A, 100A, 500A
CT9667-500A	50A, 100A, 500A
CT9667-5kA	500A, 1kA, 5kA
9669	100A, 200A, 1kA
9694	500mA, 1A, 5A, 10A, 50A
9695-02	5A, 10A, 50A, 100A
9657-10	50mA, 100mA, 500mA, 1A, 5A
9675	

3

### 3.8 Checking the Current Range

When using one of the following wiring method settings, re-set the range for other circuits (channels) similarly.

- [1P2W×2], [1P2W×3] (multiple 1-phase/2-wire circuits)
- [1P3W+I], [1P3W1U+I], [3P3W2M+I], [I×2], [I×3] (other multiple circuits)

#### Switching circuits (channels)

[1P2W2], [1P2W3]: Press **F2** [CIRCUIT] to switch circuits

Selected circuit The channel will also be switched automatically.

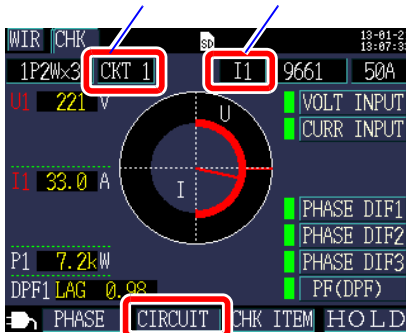

[1P3W+I], [1P3W1U+I], [3P3W2M+I], [I2], [I3]: Select the channel.

Selected channel

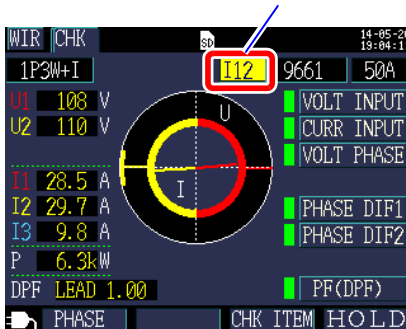



## 3.9 Verifying Correct Wiring (Wiring Check)

Check whether the instrument has been connected properly on the [WIR, CHK] screen.

1

Press the **WIRING** key to display the [WIR, CHK] screen.

- Check the wiring confirmation. A green (PASS) result indicates that there is no problem with the wirings.  
**See:** "If the wiring confirmation result is red (FAIL) or yellow (CHECK)" (p.66), (p.68)

- Check the graph. If the vector phase falls within the pass range, the instrument has been connected properly.  
**See:** If outside the pass range: "Voltage phase" (p.68), "Current phase" (p.69)

### How to read the graph

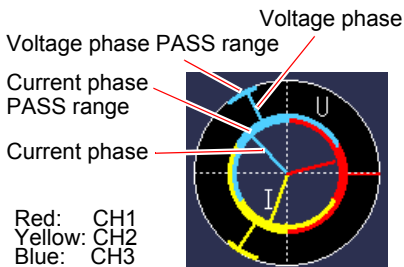

- You can also check the active power value and power factor numerically.

2

Press the **F1** [PHASE] key.

You can check the voltage and current fundamental wave phase angle numerically.

**See:** "5.4 Viewing Voltage and Current Value Details (RMS/Fundamental Wave/Peak Values, and Phase Angles)" (p.102)



Active power

**Result**  
Green : PASS  
Red : FAIL  
Yellow : CHECK

### Power factor

The power factor is displayed as DPF (displacement power factor) on the Connection Confirmation screen, regardless of the [PF/Q/S CALC] setting.

**See:** "PF/Q/S calculation [PF/Q/S CALC]" (p.75)  
"Appendix 5 Terminology" (p.A11)

3

### 3.9 Verifying Correct Wiring (Wiring Check)

#### 3 If you have selected a 1P2W×2 or 1P2W×3 circuits

Change the circuit with **F2** [CIRCUIT] and check the wiring similarly.

You cannot check the wiring for circuits for which you are measuring current only.

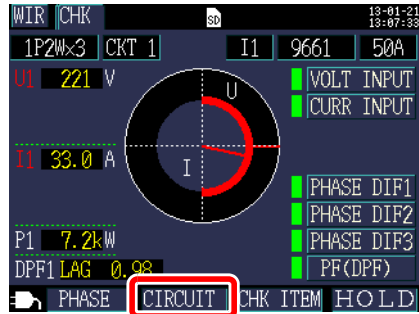

#### 4 If the wiring confirmation result is red (FAIL) or yellow (CHECK)

Press **F3** [CHK ITEM] so that you can move the cursor to the wiring check items.



#### 5 Move the cursor to the item that has been tagged as red (FAIL) or yellow (CHECK) and press the **ENTER** key

A dialog box with helpful information for fixing the wiring will be displayed. Review its content.

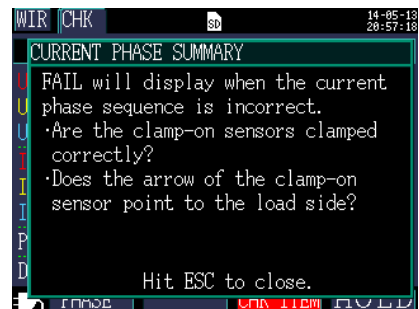

### 3.9 Verifying Correct Wiring (Wiring Check)

**6**

Press the  key to close the dialog box.

Review similar information for other wiring confirmation items as necessary.

To complete your check of the check items, press  [CHK ITEM] again.

**7**

Press the  key to display the [WIR, DIAG] screen and verify that the actual wiring connections are the same as shown on the screen.

**8**

If the wiring is wrong, correct it and check the [WIR, CHK] screen again.

**3**

### 3.9 Verifying Correct Wiring (Wiring Check)

#### If the wiring check result is red (fail) or yellow (check)

wiring confirmation item	Judgment conditions	Confirmation steps
Voltage input	<p>FAIL will display when voltage value is less than 50V. FAIL will display when at wiring other than 1P2W, the lowest voltage value is 70% or less of the highest voltage value.</p>	<ul style="list-style-type: none"> <li>• Are the voltage sensors completely inserted into the voltage sensor input terminals?</li> <li>• Have the voltage sensors been clamped to the measurement target at the proper positions (indicated by the <math>\Delta</math> marks on the sensors)?</li> </ul>
	<p><b>See:</b> "3.4 Connecting the Current Sensors to the Instrument" (p.53) <b>See:</b> "3.6 Connecting the Voltage Sensors to Target to be Measured" (p.57)</p>	
Current input	<p>FAIL will display when input is less than 1% of the current range. CHECK will display when input is less than 10% of the current range.</p>	<p>When no current is flowing, a Wiring Check cannot be performed. Operate the equipment and keep current flowing in order to check the wiring. If the equipment cannot be operated, a proper Wiring Check cannot be conducted. Visually check for proper wiring before measuring.</p> <ul style="list-style-type: none"> <li>• Are the clamp sensors properly inserted into the current sensor input terminals?</li> <li>• Are the clamp-on sensors clamped correctly?</li> <li>• Is the set current range too large for the input level?</li> </ul>
	<p><b>See:</b> "3.5 Connecting the Clamp Sensors to the Instrument" (p.55) <b>See:</b> "3.7 Connecting Clamp Sensors to Target to be Measured" (p.60)</p>	
Voltage phase	<p>FAIL will display when the voltage phase exceeds the range (<math>\pm 10</math> degrees of reference.)</p>	<ul style="list-style-type: none"> <li>• Are the wiring settings correct?</li> <li>• Are the voltage sensor correctly wired?</li> <li>• Were the phases incorrectly laid out during construction? Switch the voltage sensors and adjust the connections of the clamp-on sensors so that PASS is displayed. To double-check, use a phase detector to confirm that the phases are in the correct sequence.</li> </ul>
	<p><b>See:</b> "3.3 Setting Measurement Conditions on the Wiring Diagram Screen" (p.45) <b>See:</b> "3.6 Connecting the Voltage Sensors to Target to be Measured" (p.57)</p>	

### 3.9 Verifying Correct Wiring (Wiring Check)

wiring confirmation item	Judgment conditions	Confirmation steps
Current phase	FAIL will display when the current phase sequence is incorrect.	<ul style="list-style-type: none"> <li>• Are the clamp sensors connected in the right places (on both the measurement target and the instrument's input terminals)?</li> <li>• Does the arrow of the clamp-on sensor point to the load side?</li> </ul>
	<p><b>See:</b> "3.3 Setting Measurement Conditions on the Wiring Diagram Screen" (p.45)</p> <p><b>See:</b> "3.7 Connecting Clamp Sensors to Target to be Measured" (p.60)</p>	
Phase difference	FAIL will display when each current phase is not within 90° with respect to the voltage of each phase.	<ul style="list-style-type: none"> <li>• Are the voltage sensors and clamp sensors connected in the right places (on both the measurement target and the instrument's input terminals)?</li> <li>• Is arrow of clamp sensor pointed to the load?</li> </ul>
	CHECK appears if curr. phase is w/in $\pm 60$ to $\pm 90^\circ$ of each volt. phase.	<ul style="list-style-type: none"> <li>• Are the voltage sensors and clamp sensors connected in the right places (on both the measurement target and the instrument's input terminals)?</li> <li>• Is arrow of clamp sensor pointed to the load?</li> <li>• In light loads, PF may be low and phase diff. may be large. Check wiring for problems and proceed if OK.</li> <li>• When phase advances too much due to phase advancer in light loads, PF may be low and phase diff. may be large. Check wiring for problems and proceed if OK.</li> </ul>
	<p><b>See:</b> "3.4 Connecting the Current Sensors to the Instrument" (p.53) to</p> <p>"3.7 Connecting Clamp Sensors to Target to be Measured" (p.60)</p>	

### 3.9 Verifying Correct Wiring (Wiring Check)

wiring confirmation item	Judgment conditions	Confirmation steps
Power factor	CHECK will display if the power factor of the line to be measured is less than 0.5.	<ul style="list-style-type: none"> <li>• Are the clamp sensors connected in the right places (on both the measurement target and the instrument's input terminals)?</li> <li>• Does the arrow of the clamp-on sensor point to the load side?</li> <li>• When the load is light, the power factor may be low and the phase difference may be large. Check the wiring and if no problems are observed, you may proceed with the measurement</li> <li>• When the phase advances too much due to the use of a phase advance capacitor during a light load, the power factor may be low and the phase difference may be large. Check the wiring and if no problems are observed, you may proceed with the measurement</li> </ul>
<p><b>See:</b> "3.5 Connecting the Clamp Sensors to the Instrument" (p.55)  <b>See:</b> "3.7 Connecting Clamp Sensors to Target to be Measured" (p.60)</p>		

# Changing Settings

# Chapter 4

You can change any setting item on the setting screen.

**See:** About LAN settings (p.169)

## 4.1 Viewing and Using the Settings Screen

Allows you to switch to the Settings screen and change the Setting screen.

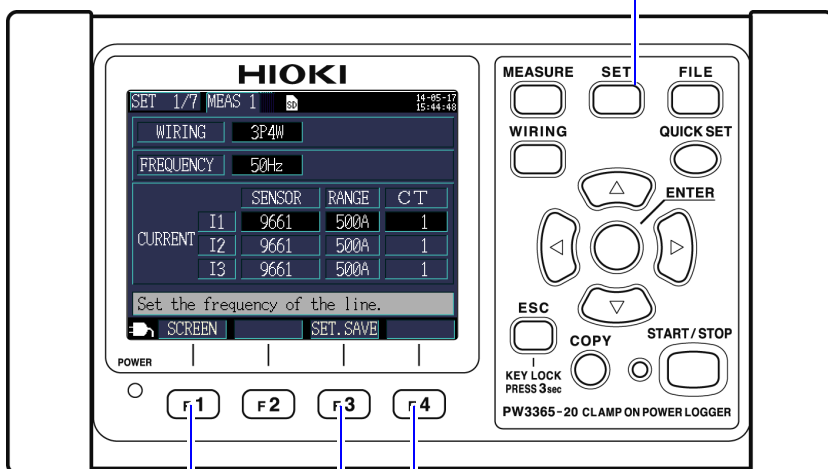

Allows you to review settings details (help function).

Saves settings files. (p.141)

Allows you to select a Settings screen.

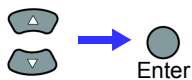
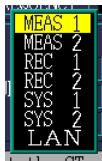

Selects a screen name from a list.

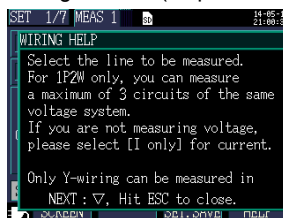

### Changing an item

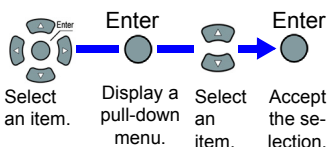

### Changing a value

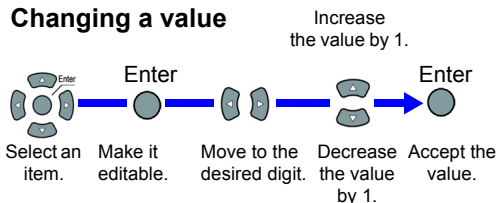

## 4.2 Changing Measurement Settings

You can change measurement conditions on the [SET1/7, MEAS1] and [SET2/7, MEAS2] Settings screens.

### Measurement 1 Setting Screen

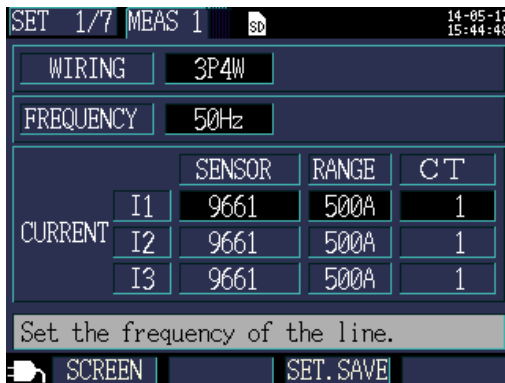

#### Wiring

Selects the measurement line wiring method.

**See:** "Selecting the wiring method" (p.46)

#### Frequency

Selects the frequency. Use of an improper frequency setting will prevent accurate measurement. Be sure to set the frequency to the measurement line frequency.

##### Selection

50Hz, 60Hz

**Reference** • When a factory reset (p.93) is performed to reset the instrument to its default settings, no measurement line frequency will have been set. When you turn on the instrument, first set the frequency to the measurement line frequency.

**See:** "Setting the Language and Measurement Target Frequency (50 Hz/ 60 Hz)" (p.35)

- The [Frequency Setting Error] dialog box will be displayed if the instrument detects voltage input and determines that the frequency differs from the set frequency. Press the **[ENTER]** key and change the frequency settings.

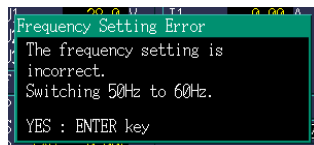



**Clamp sensor, Current range [SENSOR], [RANGE]**

Selects the clamp sensor being used and the current range.

**See:** "3.3 Setting Measurement Conditions on the Wiring Diagram Screen" (p.45)

**CT ratio [CT]**

Set when using an external CT.

Selection	
MANUAL	0.01 to 9999.99
(Select)	1/40/60/80/120/160/200/240/300/400/600/800/1200

- Reference**
- When taking measurements on the secondary side of a current transformer (CT), you can set the CT ratio in order to convert the readings to their primary-side equivalents and display the results. For a CT with a primary-side current of 200 A and a secondary-side current of 5 A, the CT ratio would be 40 (200 A / 5 A).
  - If the 5 A current range were selected with the current sensor, it would be multiplied by the CT ratio of 40 to yield a current range of 200 A.

## Measurement 2 Setting Screen

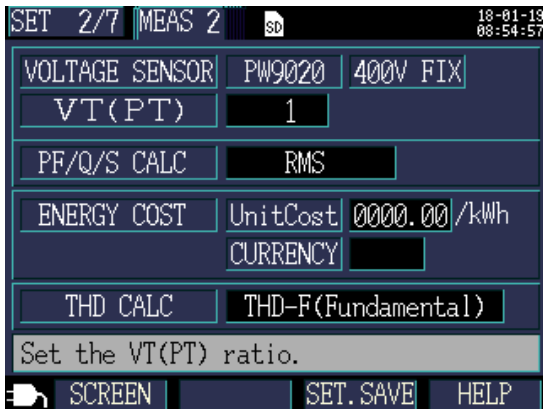

SET 2/7 MEAS 2 18-01-19 08:54:57

VOLTAGE SENSOR PW9020 400V FIX

VT(PT) 1

PF/Q/S CALC RMS

ENERGY COST UnitCost 0000.00/kWh

CURRENCY

THD CALC THD-F(Fundamental)

Set the VT(PT) ratio.

SCREEN SET.SAVE HELP

**Voltage sensor**

The voltage sensor is fixed to PW9020.

**Voltage range [V RANGE]**

The voltage range is fixed to 400 V.

**VT ratio (PT ratio) [VT(PT)]**

Set when using a VT (PT) to perform measurement.

**Selection**

<b>MANUAL</b>	0.01 to 9999.99
(Select)	1/60/100/200/300/600/700/1000/2000/2500/5000

- Reference**
- When taking measurements on the secondary side of a voltage transformer (VT), you can set the VT ratio in order to convert the readings to their primary-side equivalents and display the results. For a VT with a primary-side voltage of 6.6 kV and a secondary-side voltage of 110 V, the VT ratio would be 60 (6,600 V / 110 V).
  - Since the current range is fixed at 400 V, it would be multiplied by the VT ratio of 60 to yield a voltage range of 24 kV.

**PF/Q/S calculation [PF/Q/S CALC]**

Select the method for calculating power factor (PF), reactive power (Q), and apparent power (S).

**See:** "11.5 Calculation Formulas" (p.206)

RMS calculation is generally used in applications such as checking transformer capacity, but fundamental wave calculation is used when measuring power factor and reactive power, which are related to electricity fees.

**Selection**

<b>RMS</b>	<p>Uses voltage and current RMS values to calculate the power factor, reactive power, and apparent power.</p> <ul style="list-style-type: none"> <li>• Power factor PF (RMS power factor)</li> <li>• Reactive power Q (calculated from RMS values)</li> <li>• Apparent power S (calculated from RMS values)</li> </ul>
<b>FUNDAMENTAL</b>	<p>Uses voltage and the current fundamental wave to calculate the power factor, reactive power, and apparent power.</p> <ul style="list-style-type: none"> <li>• Power factor DPF (displacement power factor)</li> <li>• Reactive power Q (fundamental wave reactive power)</li> <li>• Apparent power S (fundamental wave apparent power)</li> </ul> <p>This is the same measurement method as is used by reactive-power meters installed at large electricity consumers' facilities. The value will be close to that obtained when using the 3169-20/21 Clamp on Power HiTester's "Use reactive power measurement method" option.</p>

## 4.2 Changing Measurement Settings

### Energy cost

You can display electricity charges by setting the unit cost (per kWh) and having the instrument multiply the electricity charge unit cost by the active energy (consumption) WP+ value.

#### Selection

<b>UnitCost</b>	0.00000 to 99999.9/kWh
<b>CURRENCY</b>	Set to any three alphanumeric characters. For example, to use the US dollar as the currency, set to "USD," etc.

### Setting the Unit Cost

- 1 Move the cursor to **[UnitCost]**.

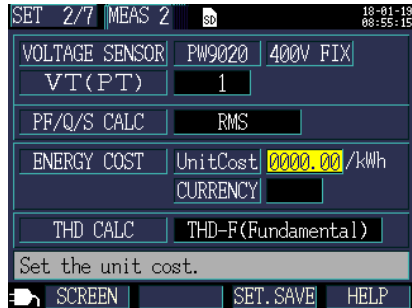





- 2 Press the  **[ENTER]** key.

- 3 A dialog box for setting the unit cost will be displayed.



To slide the decimal point, move the cursor to the decimal point

with the  /  cursor keys, and slide it with the  /  cursor keys.

- 4 To set the unit cost, move the cursor to the digit to be changed with the  /  cursor keys, and change the figure with the  /  cursor keys.

- 5 Accept the new value with the  **[ENTER]** key.

## Setting the Currency

- 1** Move the cursor to **[CURRENCY]**.

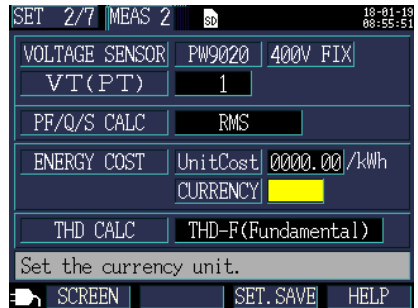

- 2** Press the **[ENTER]** key.

- 3** A dialog box for setting the currency will be displayed.

Select one character at a time with the cursor keys and then accept the entered currency with the **[ENTER]** key.



- 4** Once you have entered the currency, accept it with the **[F1]** **[OK]** key.

Pressing **[F2]** **[Cancel]** will cancel the entered currency.

## THD calculation

Selects the method used to calculate total harmonic distortion (THD). The THD-F method is typically used.

## Selection

<b>THD-F (Fundamental)</b>	Calculates by dividing the harmonic component (total of 2nd to 13th order) by the fundamental wave.
<b>THD-R (RMS)</b>	Calculates by dividing the harmonic component (total of 2nd to 13th order) by the RMS value (total of 1st to 13th order).

## 4.3 Changing Recording (Save) Settings

You can change the conditions used to record (save) measurement data on the [SET3/7, REC1] and [SET4/7, REC2] Settings screens.

### Recording 1 Setting Screen

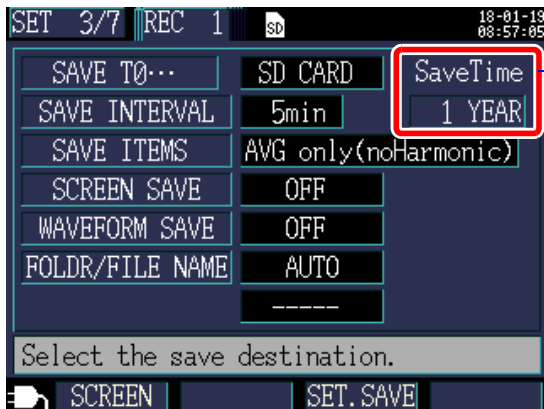

#### Data storage time

Since the instrument can perform recording and measurement for a maximum of one year, the maximum data storage time is one year.

#### NOTE

Even after the elapse of the specified storage time, the instrument continues the measurement; however, it does not save any measured values.

### Save destination [SAVE TO...]

Selects the save destination for measurement data.

#### Selection

<b>SD CARD</b>	Saves data on the SD memory card. If no SD memory card is inserted, data will be saved in the instrument's internal memory.
<b>INTERNAL</b>	Saves data in the instrument's internal memory (capacity: approximately 320 KB).

### Save interval

Selects the interval at which to save measurement data.

#### Selection

1 sec/2 sec/5 sec/10 sec/15 sec/30 sec,  
1 min/2 min/5 min/10 min/15 min/20 min/30 min/60 min

**Save items**

Selects items to be saved at the save intervals.

**Selection**

<b>AVG only (no Harmonic)</b>	Saves average values only, excluding harmonic data.
<b>ALL data (no Harmonic)</b>	Saves all values (average, maximum, and minimum values), excluding harmonic data.
<b>AVG only (w/Harmonic)</b>	Saves average values only, including harmonic data.
<b>ALL data (w/Harmonic)</b>	Saves all values (average, maximum, and minimum), including harmonic data.

Energy- and demand-related measurement data is saved regardless of this setting.

To save harmonic data, set the save destination to **[SD CARD]**.

When the save destination is set to **[Internal M]**, harmonic data is not saved; only recorded measurement data such as voltage, current, power, demand, energy, and other data are saved to the instrument's internal memory.

- Reference**
- Normally, select **[AVG only]**. In the following circumstances, select **[ALL data]** (average, maximum, and minimum values).  
Examples
    - When you wish to check the maximum value for current, power, etc.
    - When you wish to check the minimum value for voltage, power factor, etc.
  - Because the voltage and current peak values are not average values, peak values will not be output when **[AVG only]** is selected. To check peak values, select **[ALL data]**."
  - When a **[I only]** (current only) connection is being used, average values are not used for the current fundamental wave phase angle.
  - Average values are calculated from the results of continuous calculations performed every 200 ms during the save interval.
  - Maximum and minimum values indicate the largest and smallest results obtained from continuous calculations performed every 200 ms during the save interval.
  - For more information about how average, maximum, and minimum values are processed, see "Maximum/minimum/average value processing methods" (p.199).
  - Recording and measurement data (CSV format) (including values such as normal voltage, current, power, demand, and energy) and harmonic measurement data (binary format) are saved in different files.  
**See:** "Chapter 8 Saving Data and Manipulating Files" (p.131)

### 4.3 Changing Recording (Save) Settings

#### Screen save

Sets whether to save the screen being displayed as a BMP-format file every time the save interval elapses.

However, screen copies will be saved every 5 minutes if the save interval time setting is less than 5 minutes.

Screen copies cannot be saved in the instrument's internal memory. To save screen copies, set the save destination to **[SD CARD]**.

#### Selection

<b>ON</b>	Saves screen copies.
<b>OFF</b>	Does not save screen copies.

**Reference** Be sure to perform recording and measurement after displaying the screen you wish to save. The screen being displayed is the screen that will be copied.

#### Waveform save

Sets whether to save waveform data for each time interval as a binary-format file.

However, waveform data will be saved every minute if the save interval time setting is less than 1 minute.

Waveforms are not saved in the instrument's internal memory. To save waveforms, set the save destination to **[SD CARD]**.

#### Selection

<b>ON</b>	The waveforms will be saved.
<b>OFF</b>	The waveforms will not be saved.



**Folder/File name**

Sets the filename used to save data.

**See:** "8.2 Folder and File Structure" (p.134)

**Selection**

<b>MANUAL</b>	<ul style="list-style-type: none"> <li>• Allows the user to set a folder name with a dialog box (up to five byte characters).</li> <li>• If recording and measurement are performed again without changing the <b>[FOLDER/FILE NAME]</b> setting, a sequentially numbered folder will be automatically created, and the data will be saved there.</li> </ul>
<b>AUTO</b>	<ul style="list-style-type: none"> <li>• If the save destination is <b>[SD CARD]</b>, a suffix will be automatically appended in the manner of "YYMMDD-DXX." The first six characters indicate the date, while the remaining characters comprise a sequential number (00 to 99).</li> <li>• If the save destination is <b>[INTERNAL M]</b>, a suffix such as "65SETXX" or "65MEMXX" will be automatically appended (where "XX" indicates a sequential number [00 to 99]).</li> </ul>

**Reference** If the recording and measurement data file or waveform data file is larger than 200MB, all files will be segmented, and a new file will be added (using the **[FOLDER/FILE NAME]** setting + a folder sequential number (if **[AUTO]**, 00 to 99; if **[MANUAL]**, 0 to 99)).

### 4.3 Changing Recording (Save) Settings

#### Procedure

- 1** Move the cursor to **[FOLDER/FILE NAME]**.

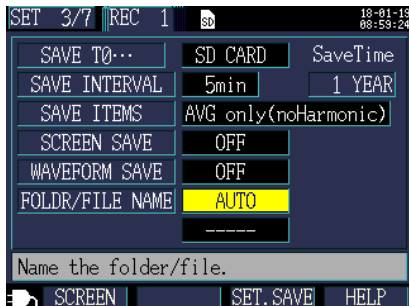

- 2** Press the **[ENTER]** key and select **[MANUAL/AUTO]**.

- 3** If you selected **[MANUAL]**:

A dialog box for inputting the folder and file name will be displayed.

Select one character at a time with the cursor keys and then accept the entered name with the

**[ENTER]** key.

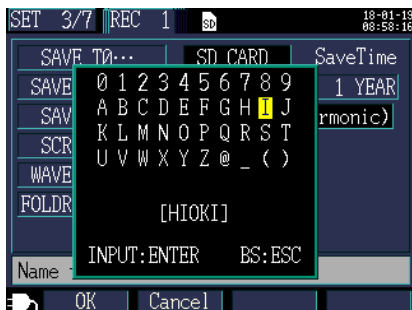

The last character can be deleted with the **[ESC]** key.

- 4** Once you have entered the folder/filename, accept it with the **[F1]** **[OK]** key.

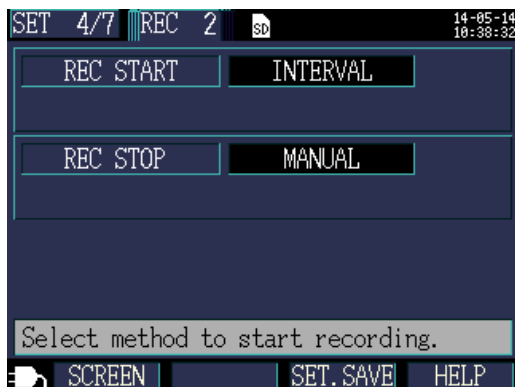

Pressing **[F2]** **[Cancel]** will cancel the entered folder/filename.

## Recording 2 Setting Screen

Recording start method **[REC START]**

Sets the method used to start recording.

## Selection

<b>MANUAL</b>	Starts recording from the point at which the  key is pressed.
<b>TIME</b>	<p>Selecting <b>[TIME]</b> displays the time setting. Recording is started at the set time (YYYY-MM-DD hh:mm).</p> <p>If the start date has already passed, recording will be started as <b>[INTERVAL]</b> setting.</p> <p><b>See:</b> "Setting times for the [TIME] setting" (p.84)</p>
<b>INTERVAL</b>	<p>Starts recording at an even division after the interval time elapses. Example:</p> <p>If the  key is pressed at 10:41:22 with the save interval set to 30 minutes, the instrument will enter the standby state, and recording will start at 11:00:00. Similarly, if the save interval is set to 10 minutes, recording will start at 10:50:00. If the save interval is set to 30 seconds or less, recording will start from the next :00 seconds.</p>
<b>REPEAT</b>	<p>Segments files every day and repeats recording. Recording will be started on the repeat start date. If the start date has already passed, recording will be started as <b>[INTERVAL]</b> setting. When the recording time range on the stop date has passed, recording will be stopped.</p> <p><b>See:</b> "Configuring detailed settings for [REPEAT]" (p.85)</p>

### 4.3 Changing Recording (Save) Settings

#### Setting times for the [TIME] setting

- 1** Move the cursor to **[REC START]** or **[REC STOP]**, press the , and select **[TIME]**.

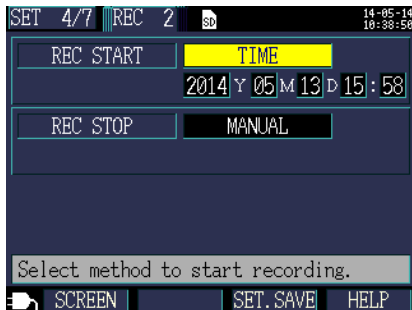

- 2** Move the cursor to the field you wish to change (year, month, day, hour, or minute) and press the  **[ENTER]** key.

The cursor will expand to the size of one digit, and you will be able to change the digit.

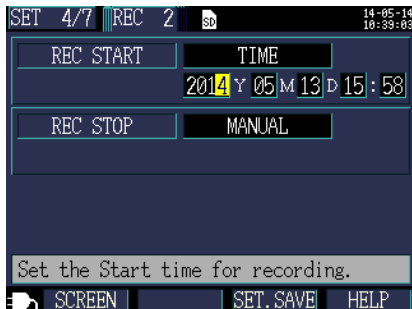

- 3** Change the setting with the  /  cursor keys and then accept the new value with the  **[ENTER]** key.

## Configuring detailed settings for [REPEAT]

- 1** Move the cursor to [REC START], press the  [ENTER] key, and select [REPEAT].  
The [REC STOP] will also be set to [REPEAT] automatically.

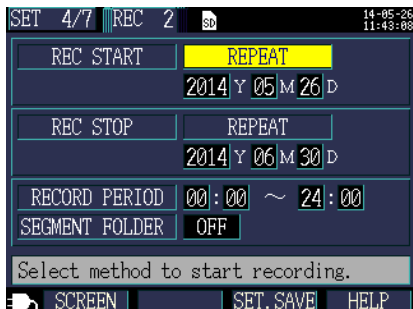

- 2** Move the cursor to the year, month, or day setting you wish to change and press the  [ENTER] key.

The cursor will change to the size of one digit, and you will be able to change the setting.

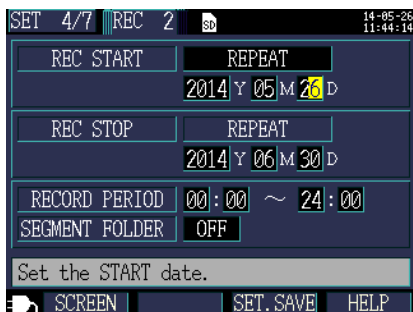

- 3** Change the setting with the  /  cursor keys and then accept the new value with the  [ENTER] key.

- 4** Move the cursor to the [RECORD PERIOD] start time or stop time and press the  [ENTER] key.

The cursor will change to the size of one digit, and you will be able to change the setting.

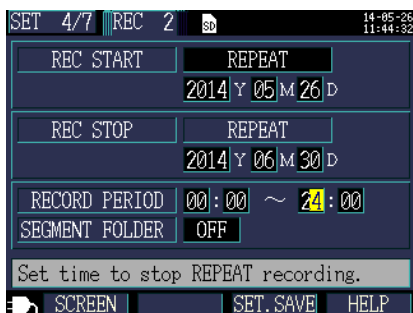

### 4.3 Changing Recording (Save) Settings

#### Configuring detailed settings for [REPEAT]

- 5** Change the setting with the  /  cursor keys and then accept the new value with the  [ENTER] key.

(Valid setting range: 00:00 to 24:00)



#### Example

For a setting of 00:00 to 24:00, recording (integrating power) will be reset every day at 24:00, and recording will resume immediately.

For a setting of 08:00 to 18:00, recording and measurement (integrating power) will be performed during this time range only. From 00:00 to 08:00 and from 18:00 to 24:00, recording and measurement (integrating power) are not performed.

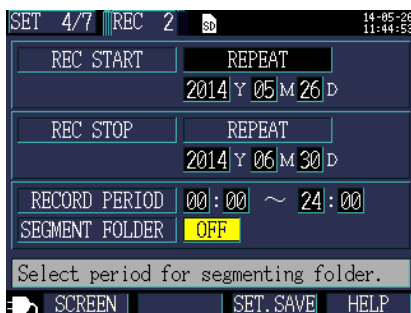
- 6** Move the cursor to the [SEGMENT FOLDER] and press the  [ENTER] key.



- 7** Select the folder creation timing with the cursor  /  keys and accept the setting with the  [ENTER] key.

<b>OFF</b>	Disables folder segmentation.
<b>DAY</b>	Creates a save folder every day. The maximum save length is 100 days.
<b>WEEK</b>	Creates a save folder every seven days from the start of recording. The maximum save length is one year.
<b>MONTH</b>	Creates a save folder on the first of every month. The maximum save length is one year.

- If the savable time for the SD memory card or internal memory is shorter than the specified interval, recording will be started, but data will only be recorded during the savable time.
- If the number of folders in the SD memory card's PW3365 base folder exceeds 50, you will not be able to start recording. Either format the SD memory card or delete unnecessary folders.

## RERER- ENCE

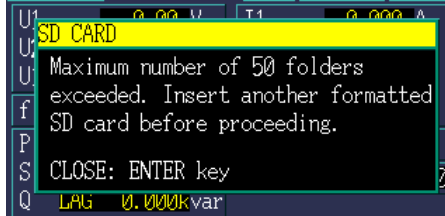

- See:** "8.7 Deleting Folders and Files" (p.145),  
"8.8 Formatting the SD Memory Card or Internal Memory" (p.146)

## Recording stop method

Sets the method used to stop recording.

### Selection

<b>MANUAL</b>	Stops recording when the <small>START/STOP</small>  key is pressed.
<b>TIME</b>	Selecting <b>[TIME]</b> causes a dialog box for setting the time to be displayed. Recording is stopped at the set time (YYYY-MM-DD hh:mm). If the set time has already passed when recording starts, recording will be stopped manually. <b>See:</b> "Setting times for the [TIME] setting" (p.84)
<b>TIMER</b>	Stops recording automatically when the set timer time elapses. <b>See:</b> "Setting the [TIMER]" (p.88)
<b>REPEAT</b>	Segments files every day and repeats recording. Recording will be stopped when the recording time range on the repeat stop date passes. The stop method cannot be changed for repeat recording. <b>See:</b> "Configuring detailed settings for [REPEAT]" (p.85)

**Reference** The maximum recording and measurement time is up to one year.  
Recording will stop automatically in one year.

### 4.3 Changing Recording (Save) Settings

#### Setting the [TIMER]

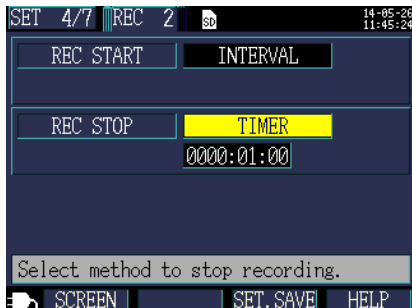

- 1** Move the cursor to the [REC STOP], press the  [ENTER] key, and select [TIMER].

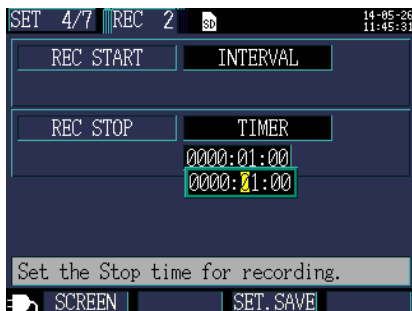

- 2** Move the cursor to the time setting and press the  [ENTER] key.

The cursor will change to the size of one digit, and you will be able to change the setting.



- 3** Change the setting with the  /  cursor keys and then accept the new value with the  [ENTER] key.  
(Valid setting range: 1 sec. to 1,000 hr.)



## 4.4 Changing System Settings (as Necessary)

You can change system settings on the [SET5/7, SYS1] and [SET6/7, SYS2] Settings screens.

### System 1 Setting Screen

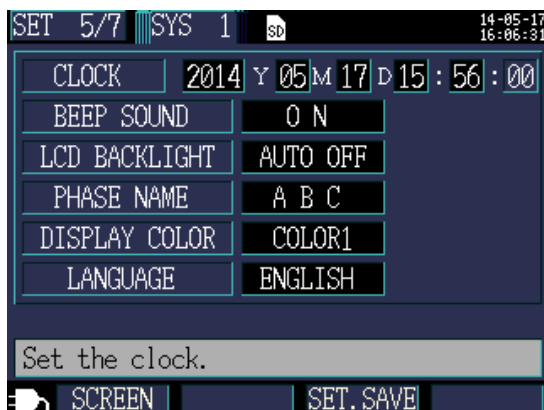

#### Clock

Sets the date and time (using the Western calendar and 24-hour time).

**See:** "Setting the Clock" (p.36)

**Reference** The seconds cannot be set. After changing the time, pressing the **Enter** key causes the seconds to be reset to 00.

#### Beep sound

Turns the key press beep on and off.

**Selection**

**ON/OFF**

#### LCD backlight

Selects whether to automatically turn off the LCD backlight.

**Selection**

**AUTO OFF**

Automatically turns off the backlight once two minutes have elapsed since the last key operation. The POWER LED will flash while the backlight is off.

**ON**

Keeps the backlight on at all times.

#### 4.4 Changing System Settings (as Necessary)

##### Phase name

Selects the phase names for the measurement lines displayed on the **[WIR, DIAG]** screen.

###### Selection

R S T, A B C, L1 L2 L3, U V W

##### Screen color **[DISPLAY COLOR]**

Selects the screen color.

###### Selection

COLOR 1 to COLOR3

##### Language

Selects the display language.

###### Selection

<b>JAPANESE</b>	Selects the Japanese display.
<b>ENGLISH</b>	Selects the English display.
<b>CHINESE</b>	Selects the Chinese display.
<b>GERMAN</b>	Selects the German display.
<b>ITALIAN</b>	Selects the Italian display.
<b>FRENCH</b>	Selects the French display.
<b>SPANISH</b>	Selects the Spanish display.
<b>TURKISH</b>	Selects the Turkish display.
<b>KOREAN</b>	Selects the Korean display.

## System 2 Setting Screen

**Start Quick Set at power-on [QUICK SET at PWR ON]**

Selects whether to display the Quick Set start dialog box when the instrument is turned on.

**Selection**

<b>OFF</b>	Display the Measurement screen instead of displaying the Quick Set start dialog box when the instrument is turned on. The Quick Set can be displayed by pressing the <small>QUICK SET</small>  key, even when this option is set to OFF.
<b>ON</b>	Displays the Quick Set start dialog box when the instrument is turned on.

**Instrument information [ABOUT...]**

Displays the instrument's serial number and software and FPGA versions.

## 4.5 Initializing the Instrument (System Reset)

There are two methods by which the instrument can be initialized:

### System reset

Perform when the instrument is operating in an odd or unexpected manner (with no clear cause).

### Factory reset

Perform when you wish to revert all settings to their factory defaults.

## When the Instrument Is Operating in an Odd or Unexpected Manner (System Reset)

Before performing a system reset, check "Before Having the Instrument Repaired" (p.223). If you are unable to find the cause of the problem, perform the system reset.

All settings other than the frequency setting, clock, language setting, IP address, subnet mask, and default gateway to be initialized to their default values. The instrument's internal memory will not be erased.

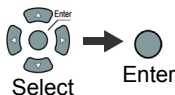
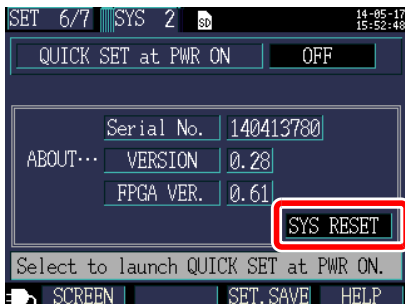



**Reverting All Settings to the Factory Defaults (Factory Reset)**

You can revert all settings, including frequency, language, and communications settings, to their default values by turning on the instrument when you perform a factory reset. The instrument's internal memory will be erased.

After performing the factory reset, set the clock before using the instrument.(p.36)

**1** Turn off the power switch.

**2** Turn on the instrument while holding down the  [ENTER] and  keys, and continue holding them down until the beep sounds after the self-test is complete.

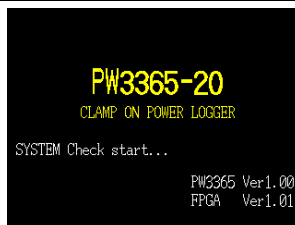

The instrument will be reset to its factory settings, and the Language Setting screen will be displayed.

**See:** "Setting the Language and Measurement Target Frequency (50 Hz/ 60 Hz)" (p.35)



## 4.5 Initializing the Instrument (System Reset)

### Factory Settings

All settings' default values are as follows:

Screens	Settings	Default value
MEAS 1	WIRING	3P4W
	FREQUENCY	Not set. Select [50Hz] or [60Hz] when the instrument is powered on for the first time.
	CURRENT	SENSOR: 9661, RANGE: 500A, CT: 1 (Sensor: Model 9661, Range: 500A, CT ratio: 1)
MEAS 2	V RANGE (Voltage Range)	400V FIX (400 V fixed)
	VT (PT) (VT (PT) ratio)	1
	PF/Q/S CALC (PF/Q/S Calculation)	RMS
	ENERGY COST	UnitCost: 0000.00/kWh, CURRENCY: Not set.
	THD calculation	THD-F (Distortion component/Fundamental wave)
REC 1	SAVE TO... (Save Destination)	SD CARD
	SAVE INTERVAL	5min (5 minutes)
	SAVE ITEMS	AVG only (noHarmonic)
	SCREEN SAVE	OFF
	WAVEFORM SAVE	OFF
	FOLDER/FILE NAME	AUTO
REC 2	REC START (Recording start method)	INTERVAL
	REC STOP (Recording stop method)	MANUAL
SYS 1	CLOCK	Set at time of shipment.
	BEEP SOUND	ON
	LCD BACKLIGHT	AUTO OFF
	PHASE NAME	A B C
	DISPLAY COLOR	COLOR1
	LANGUAGE	Not set. Select [JAPANESE], [ENGLISH], [CHINESE], [GERMAN], [ITALIAN], [FRENCH], [SPANISH], or [TURKISH] when the instrument is powered on for the first time.
SYS 2	QUICK SET at PWR ON (Start Quick Set at power-on)	OFF

**4.5 Initializing the Instrument (System Reset)**

Screens	Settings	Default value
LAN	IP ADDRESS	192.168.1.31
	SUBNET MASK	255.255.255.0
	DEFALT GATEWAY (Default Gateway)	192.168.1.1





# Viewing Measurement Data Chapter 5

The PW3365 allows you to view measured values, waveforms, and graphs on the Measurement screen.

## 5.1 Viewing and Using the Measurement Screen

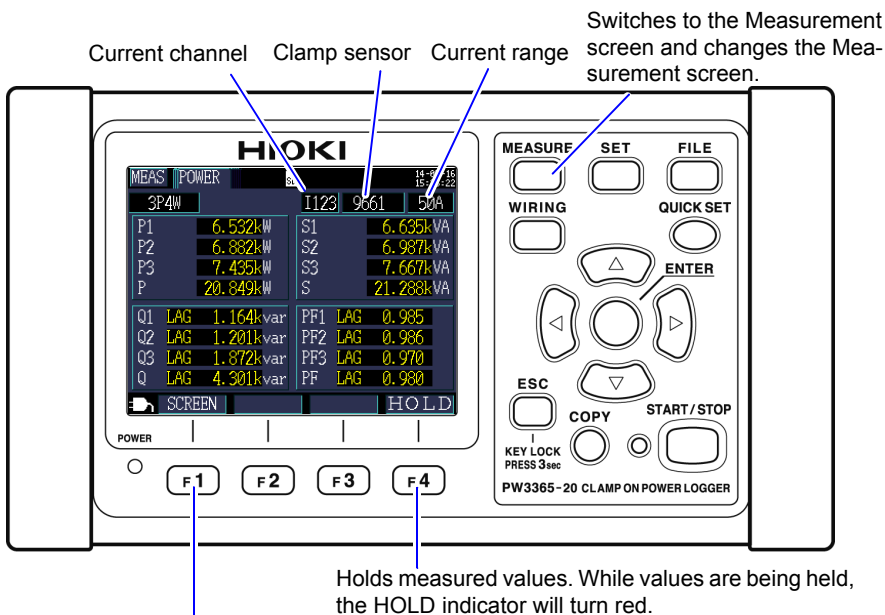

Allows you to select a Measurement screen.



Selects a screen name from a list.

- Reference**
- If a setting is changed while measured values are being held, the hold will be canceled.
  - The time display is not fixed while measured values are being held.

## 1P2W x 2 or 1P2W x 3 Wiring

When using [1P2W2] or [1P2W3] wiring, change the circuit as the [MEAS, LIST] and [MEAS, INTEG.] screens for each circuit vary. The circuit number and current channel displays will change.

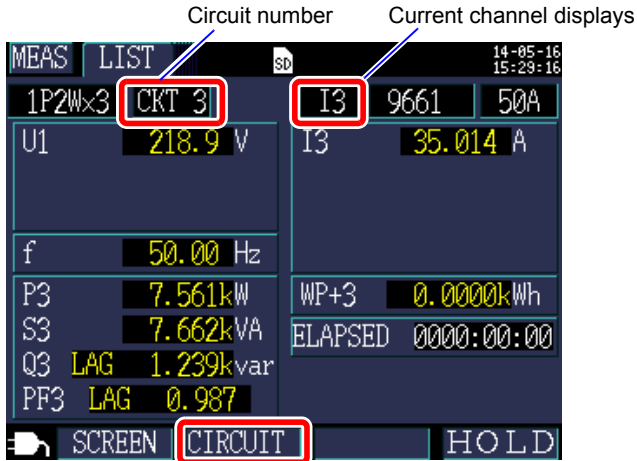

The circuit can also be changed with **F2**.

## 5.2 List of Measurement Screens

Screen name	Displayed data	Reference
List	Voltage RMS (U), current RMS (I), frequency (f), active power (P), reactive power (Q), apparent power (S), power factor (PF) or displacement power factor (DPF), active energy (consumption) WP+, and elapsed time (The display can be switched between two and three circuits when using a 1P2W connection.)	"5.3" (p.101)
U/I	Voltage RMS (U), voltage fundamental wave value (U <sub>fund</sub> ), voltage waveform peak (U <sub>peak</sub> or U <sub>pk</sub> ), voltage fundamental wave phase angle (U <sub>deg</sub> ), current RMS (I), current fundamental wave value (I <sub>fund</sub> ), current waveform peak (I <sub>peak</sub> or I <sub>pk</sub> ), and current fundamental wave phase angle (I <sub>deg</sub> )	"5.4" (p.102)
Power	Per-channel and total active power P, apparent power S, reactive power Q, power factor PF or displacement power factor DPF	"5.5" (p.104)
Integ.	Active energy (consumption WP+, regeneration WP-), reactive energy (lag WQ+, lead WQ-), recording start time, recording stop time, elapsed time, energy cost (The display can be switched between two and three circuits when using a 1P2W connection.)	"5.6" (p.105)
Demand	Can be switched to active power demand value (consumption P <sub>dem</sub> +, regeneration P <sub>dem</sub> -), reactive power demand value (lag Q <sub>dem</sub> LAG, lead Q <sub>dem</sub> -LEAD), power factor demand value (PF <sub>dem</sub> ), or pulse input. Maximum demand value: Displays the maximum active power demand value MAX_DEM and the time at which it occurred.	"5.7" (p.106)
Harmonic graph	Harmonic graph (voltage <sub>a</sub> and current levels, content percentage)	"5.8" (p.107)
Harmonic list	Harmonic list (voltage <sub>a</sub> and current levels, content percentage)	"5.9" (p.108)
Waveform	Displays voltage and current waveforms, voltage and current RMS values, and frequency.	"5.10" (p.109)
Zoom	Enlarged view of 4 user-selected parameters	"5.11" (p.111)

## 5.2 List of Measurement Screens

Screen name	Displayed data	Reference
Trend	Displays one measurement parameter as selected by the user. Displays the maximum, average, and minimum values and allows cursor measurement.	"5.12" (p.113)

## 5.3 Viewing Data (Voltage, Current, Power, and Energy) as a List



Press the  or  [SCREEN] key to display the [MEAS, LIST] screen.



Selects between power factor PF (RMS calculation) and displacement power factor DPF (fundamental wave calculation) with settings.

**See:** "PF/Q/S calculation [PF/Q/S CALC]" (p.75)

## 5.4 Viewing Voltage and Current Value Details (RMS/Fundamental Wave/Peak Values, and Phase Angles)

Press the  or  [SCREEN] key to display the [MEAS, U/I] (VOLT/CURR) screen.

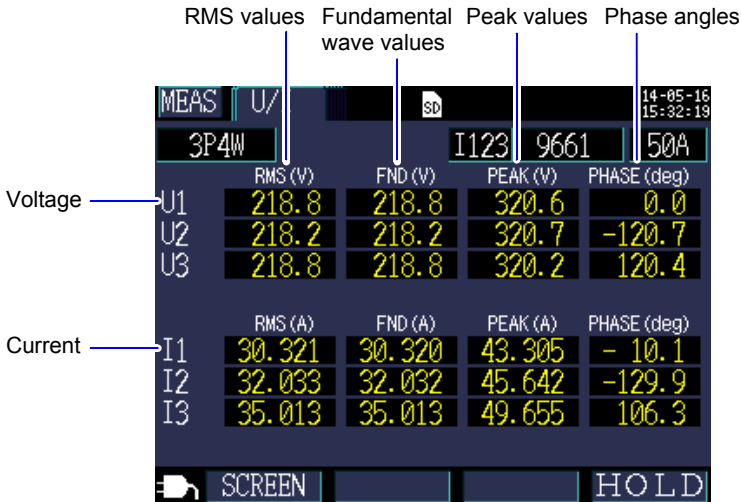

Term	Description
RMS value	The square root of the squares of 2,048 sampling points in a 200 ms interval.
Fundamental wave value (FND)	The value obtained by extracting only the fundamental wave (50 Hz/60 Hz) component from the voltage or current waveform. "FND" stands for "fundamental."
Peak value	The maximum value of the absolute values of the sampling points (2,048 points) in a 200 ms interval.
Fundamental wave phase angle (PHASE)	The phase angle of the fundamental wave component of U1 expressed in terms of 0°. For current only, the fundamental wave phase angle of I1 expressed in terms of 0°.

**Reference** When using [3P3W3M] wiring, the line-to-line voltage is used for voltage RMS values, while the conductor-to-ground voltage (phase voltage) is used for the fundamental wave value, peak value, and fundamental wave phase angle.

**See:** "Appendix 3 Three-phase 3-wire Measurement" (p.A2)

To check the line-to-line voltage RMS value, fundamental wave value, peak value, or fundamental wave phase angle for a 3-phase/3-wire circuit, perform measurement using the 3P3W2M wiring method. Alternatively, to check the phase voltage RMS value, fundamental wave value, peak value, or fundamental wave phase angle, perform measurement with the instrument set to 3P4W after connecting it as per the 3P3W3M wiring method.

## 5.5 Viewing Power Details (Channel Power Values)

Press the  or **F1** [**SCREEN**] key to display the **[MEAS, POWER]** screen.

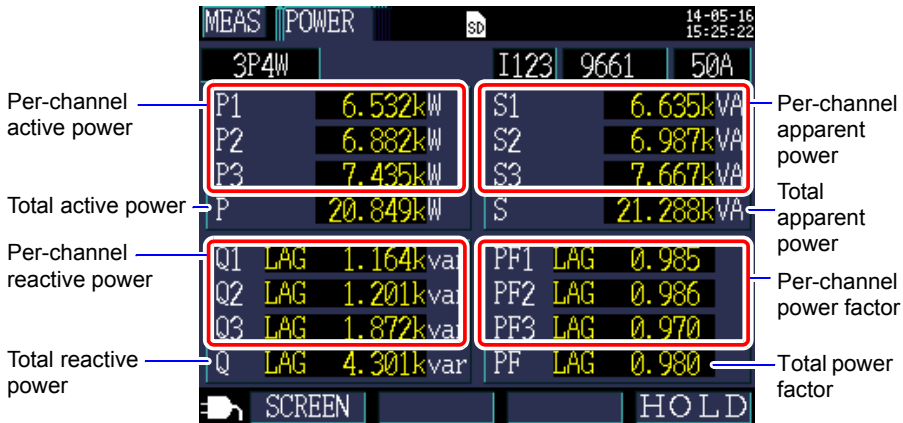



When using the 3-phase/3-wire/2-wattmeter method (3P3W2M), the active power, reactive power, apparent power, and power factor for each channel are obtained by means of a two-wattmeter calculation process and do not have physical significance. However, values for individual channels can serve as reference data when checking the connection.

However, the 3-wattmeter method can be used with the Y wiring method. Even if you use the 3-wattmeter method with the  $\Delta$  wiring method, the active power, reactive power, and apparent power for each channel will be the same as would be obtained using the 2-wattmeter method. In this situation, the 3-wattmeter method is meaningless. Use the 2-wattmeter method with the  $\Delta$  wiring method.

**See:** "Appendix 3 Three-phase 3-wire Measurement" (p.A2)



## 5.6 Viewing Energy (Active Energy and Reactive Energy)

Press the  or  [SCREEN] key to display the [MEAS, INTEG.] (INTEGRATE) screen.

MEAS		INTEG.		SD	1 YEAR	REC	13-04-11
3P4W	I123	9661	50A				09:07:06
ACTIVE POWER	CONS	WP+	325.766k Wh				
	REGEN	WP-	0.0000k Wh				
REACTIVE PWR	LAG	WQ+	140.711kvarh				
	LEAD	WQ-	0.0000kvarh				
START	2013-04-10	17:30:00					
STOP	2014-04-10	17:30:00					
ELAPSED		0015:37:06					
ENERGY COST		37.6260	USD				
	SCREEN						HOLD

- Reference**
- Total energy from the start of recording will be displayed.
  - Energy cost displays the result of multiplying the active energy consumption value WP+ by the Unit cost setting (p.76).

## 5.7 Viewing a Demand Graph

Press the  or **F1 [SCREEN]** key to display the **[MEAS, DEMAND]** screen. The instrument stores data for up to 48 of the latest time intervals in its internal memory for user review.

Switches the display parameter. (The display parameter can be switched even when the cursor is selected and values are being held.)

Active power demand value (consumption Pdem+, regeneration Pdem-)

Reactive power demand value

(lag QdemLAG, lead QdemLEAD)

Power factor demand value (PFdem)

When active power demand value (consumption Pdem+) is selected, a line representing the maximum value (maximum active power demand value MAX\_DEM) for the active demand value (consumption Pdem+) from the start of recording is shown along with the time and date of its occurrence.

Year, month, date, hours, minutes, and seconds at the cursor position    Cursor measured value

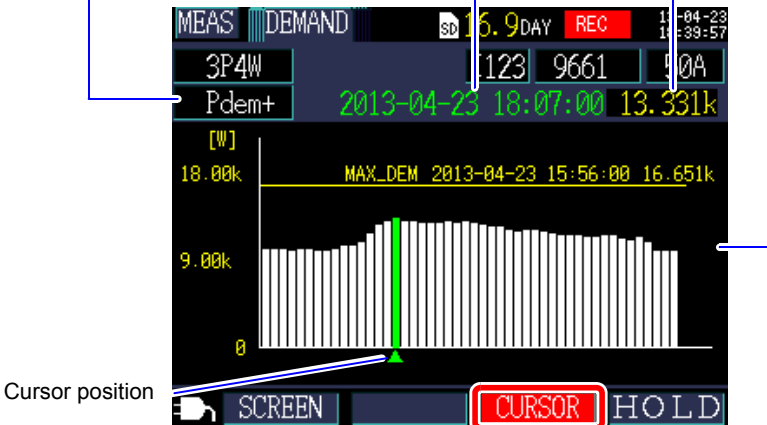

Cursor position

Performs cursor measurement.

The cursor keys can be used to move the cursor. When the cursor is selected, the demand display is not updated. The display will be updated to the latest demand value once the cursor is cleared.

- Reference**
- You can review data for up to 48 of the latest time intervals.
  - The zoom factor for the vertical axis is set automatically. First, it is set to 1/10, and then switched automatically to 1/5, 1/2, and 1/1 in series according to displayed data levels.
  - When measured values exceed the display range, the relevant bars are colored.

## 5.8 Viewing a Harmonic Graph

Press the **MEASURE** or **F1** [**SCREEN**] key to display the **[MEAS, HARM]** (HARMONIC G) screen.

Total harmonic distortion (THD-F or THD-R)  
See: "THD calculation" (p.77)

Cursor  
measured value



Cursor position

Performs cursor measurement.  
The order can be changed using the cursor keys.

Switches the display parameter.

Display parameter	Description
Voltage	U1, U2, U3
Current	I1, I2, I3
LEVEL	Harmonic level for each order Switching between the linear (LINEAR) and logarithmic (LOG) scale axis is available.
%ofFND	Each order's harmonic component expressed as a percentage of the fundamental wave. Switching between the linear (LINEAR) and logarithmic (LOG) scale axis is available.

## 5.9 Viewing a Harmonic List

Press the  or **F1** [**SCREEN**] key to display the **[MEAS, HARM]**(HARMONIC L) screen.

Total harmonic distortion (THD-F or THD-R)  
See: "THD calculation" (p.77)



Switches the display parameter.

Display parameter	Description
Voltage	U1, U2, U3
Current	I1, I2, I3
LEVEL	Harmonic level for each order
%ofFND	Each order's harmonic component expressed as a percentage of the fundamental wave.

## 5.10 Viewing Waveforms

Press the **MEASURE** or **F1 [SCREEN]** key to display the **[MEAS, WAVE]** (WAVEFORM) screen.

The screenshot shows the MEAS/WAVE screen with the following data and annotations:

- MEAS/WAVE Screen Data:**
  - 3P4W, I123, 9661, 50A
  - U1: 221.7 V, U2: 223.4 V, U3: 222.1 V (Voltage RMS)
  - I1: 33.04 A, I2: 36.28 A, I3: 37.99 A (Current RMS)
  - f: 50.00 Hz (Frequency)
  - 300.00 V/div (Voltage vertical axis)
  - 50.000 A/div (Current vertical axis)
  - VOLT x 2, CURR x 1
  - SCREEN, MAGNIFY, HOLD
- Annotations:**
  - Voltage waveforms:** U1: Red, U2: Yellow, U3: Blue
  - Current waveforms:** I1: Red, I2: Yellow, I3: Blue
  - MAGNIFY:** Changes the zoom factor for the vertical axis used to display voltage and current waveforms (p.110).

## Changing the Zoom Factor for the Vertical Axis Used to Display Voltage and Current Waveforms

- 1** Press the **F2** **[MAGNIFY]** key.



The cursor will move to the zoom factor field, and you will be able to change the setting.

- 2** Move the cursor to the voltage or current zoom factor and press the

**[ENTER]** key.

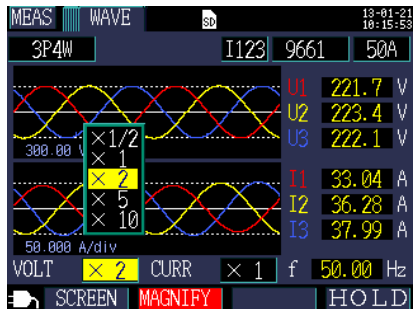
A dialog box for selecting the zoom factor will be displayed.



- 3** Select the desired zoom factor with the cursor's  /  keys and press the **[ENTER]** key.

- Reference**
- For 1P2W x 2 or 1P2W x 3 wirings, changes to the vertical axis zoom factor will affect all channels, even if individual channels use different clamp sensors or current ranges.
  - When using the 3P3W3M wiring method, the terminal-to-ground voltage (phase voltage) is displayed for the voltage waveform, but the line-to-line voltage is displayed for the voltage (RMS value).

## 5.11 Enlarging Measured Values on the Display

Press the  or **F1** [**SCREEN**] key to display the [**MEAS, ZOOM**] screen.



Selects the parameter to enlarge.

### Changing display parameters

**1**

Press the **F2** [**SELECT**] key.

The cursor will move to the display parameter field, and you will be able to change the setting.

**2**

Using the cursor keys, move to the parameter whose enlarged display you wish to change and press the  [**ENTER**] key.

A dialog box for selecting the enlarged display will be displayed.

Display of selection position of the scrolling parameter



**3** Select the desired parameter with the cursor keys and accept the new setting with the  [ENTER] key.  
Change other parameters similarly.

---

---

**4** Press the  [SELECT] key to cancel the setting process.

**Reference** On the expanded display, you cannot select demand or harmonic parameters.

---



## 5.12 Viewing a Trend Graph

Press the **MEASURE** or **F1 [SCREEN]** key to display the **[MEAS, TREND]** screen.

Maximum value during the save interval

Average value during the save interval

Minimum value during the save interval

Switches the display parameter.

The display parameter can be switched even when the cursor is selected and values are being held.

Cursor position

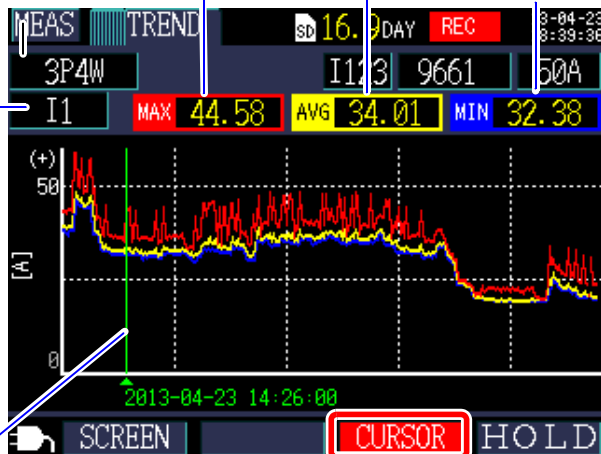

The cursor keys can be used to move the cursor. When the cursor is selected, the trend display is not updated. The trend graph will be updated to the latest values once the cursor is cleared.

### Changing the vertical axis or horizontal axis (time axis) zoom factor

**1** Press the **F2 [MAGNIFY]** key.

The axis selection dialog box will be displayed.

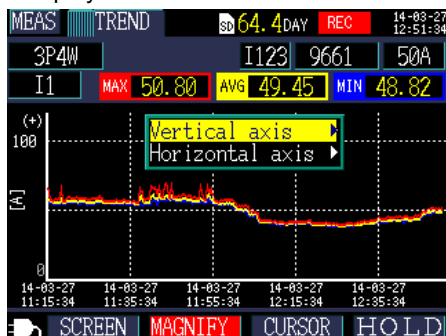

- 2** Select either [Vertical axis] or [Horizontal axis] with the cursor and press the  [ENTER] key.

The magnify selection dialog box will be displayed.

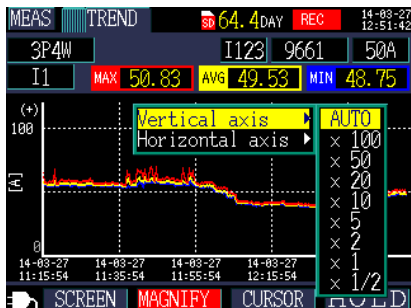



- 3** Select the desired zoom factor with the cursor keys and press the  [ENTER] key.

The other axis can be changed in the same manner.

- Reference**
- You cannot select demand or harmonic parameters (other than THD) on the time-series display.
  - Data for up to 288 time intervals can be displayed on one screen. If this number is exceeded, older data will be discarded.  
For example: Save interval time setting: 1 sec.  
Amount of time that can be displayed on 1 screen: 4 minutes 48 seconds  
Save interval time setting: 5 min.  
Amount of time that can be displayed on 1 screen: 24 hours
  - Time-series data used for display purposes will be lost if the power goes out during recording since that data is not backed up. (However, this is not problematic since the same data will have been saved on the SD memory card or in the instrument's internal memory.) The time-series data will be updated when power is restored.
  - The Plus sign "+" of reactive power (Q) represents a LAG, whereas the minus sign "-" represents a LEAD.
  - When measured values exceed the display range, the background color is changed.

## 5.13 If No Measured Value Is Displayed

No measured value will be displayed in the event of an over-range event or when measurement is not possible.

	<p>Shown instead of the measured value when the upper limit of the display range has been exceeded (p.188), causing the value to be over-range.</p> <p>If the voltage is over-range, the voltage that the instrument is capable of measuring is being exceeded. Immediately disconnect the instrument. If the current is over-range, increase the current range.</p>
	<p>Shown instead of the measured value when measurement is not possible. When there is no input, shown during power factor measurement.</p>



# Starting and Stopping Recording and Measurement

## Chapter 6

The method used to start and stop recording is set with the **[REC START]** and **[REC STOP]** settings on the **[SET4/7, REC2]** screen. Recording and measurement data is saved to the destination selected on the **[SET3/7, REC1]** screen.

See: "4.3 Changing Recording (Save) Settings" (p.78)

### Recording start method

**MANUAL**

Starts recording when the **START/STOP** key is pressed.

**TIME**

Starts recording when the specified time is reached.

**INTERVAL**

Starts recording at an even division based on the save interval time.

**REPEAT**

Segments files every day and repeats recording. Recording will be started on the repeat start date.

### Recording stop method

**MANUAL**

Stops recording when the **START/STOP** key is pressed.

**TIME**

Stops recording when the specified time is reached.

**TIMER**

Automatically stops recording when the set timer time has elapsed.

**REPEAT**

Segments files every day and repeats recording. Recording will be stopped once the repeat time interval range has passed on the repeat stop date.

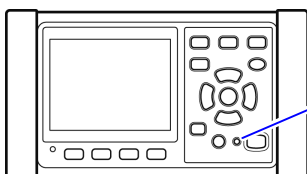

### Recording LED

Flashing : Recording standby  
On : Recording

## 6.1 Starting Recording

**Reference** Do not remove the SD memory card while recording is in progress. If the SD memory card is removed during recording, measurement data will be saved in a new file (with a sequentially numbered suffix) when the card is reinserted.

Similarly, if either the recording and measurement data file or waveform data file surpasses 200MB, all data files being recorded (recording/measurement and waveform) will be segmented and new files saved (with a sequential number at the end of each).

**See:** "8.2 Folder and File Structure" (p.134)

### Starting Recording Manually

- 1 Set the [REC START] on the [SET4/7, REC2] screen to [MANUAL].

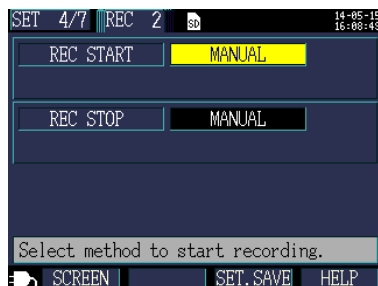

- 2 Press the **START/STOP** key on the Measurement screen.

Recording will start (and the Recording LED will light up).

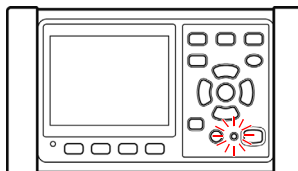

The recording LED On

## Starting Recording by Specifying a Time [TIME]

- 1** Set the [REC START] on the [SET4/7, REC2] screen to [TIME] and set the start time.

See: "Setting times for the [TIME] setting" (p.84)

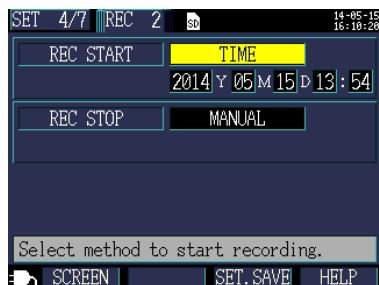

- 2** Press the **START/STOP** key on the Measurement screen.

The instrument will enter the standby state.

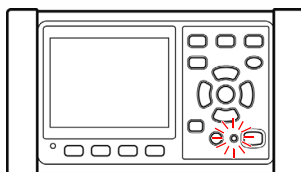

Flashing recording LED

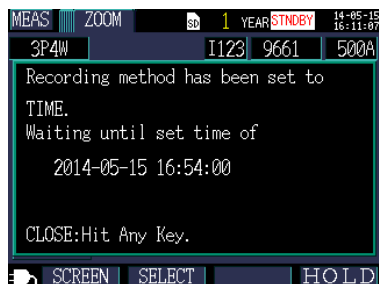

When the set start time is reached, recording will start (and the recording LED will light up).

## Reference

If the recording start time has already passed when the **START/STOP** key is pressed, the "interval time" starting method will be used.

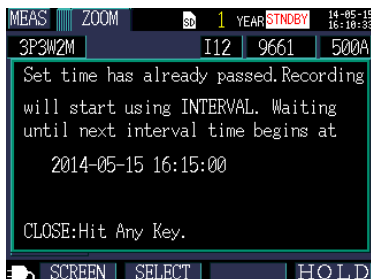

See: "Starting Recording at a Good Time Division [INTERVAL]" (p.120)

Starting Recording at a Good Time Division [INTERVAL]

1 Set the [REC START] on the [SET4/7, REC2] screen to [INTERVAL]

See: "Recording start method [REC START]" (p.83)

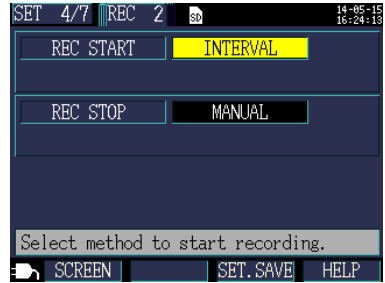

2 Press the  key on the Measurement screen.

The instrument will enter the standby state.

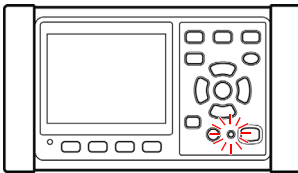

Flashing recording LED

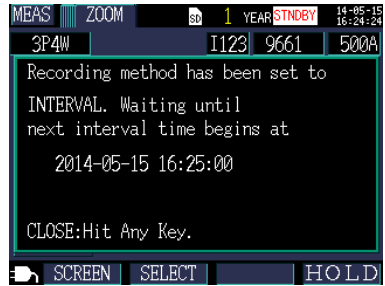

Recording will start automatically when a good time division is reached based on the save interval time. (and the recording LED will light up).

Example

If the  key is pressed at 11:22:23 with the interval save time set to 5 minutes, the instrument will start recording at 11:25:00.

**Reference** If the save interval is set to 30 seconds or less, recording will start from the next :00 seconds.



## 6.2 Stopping Recording

### Stopping Recording Manually

- 1 Set the [REC STOP] on the [SET4/7, REC2] screen to [MANUAL].

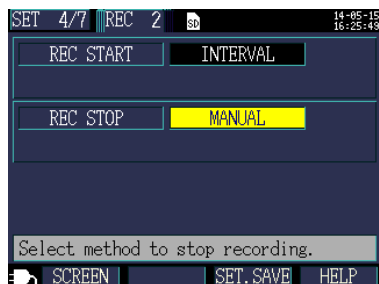

- 2 Press the  key on the Measurement screen. A confirmation dialog box will be displayed.

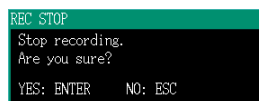

- 3 Press the  [ENTER] key to stop recording.

**Reference** The maximum recording and measurement period is one year. Recording will stop after one year.

## Stopping Recording by Specifying a Time [TIME]

- 1** Set the [REC STOP] on the [SET4/7, REC2] screen to [TIME] and set the stop time.

**See:** "Recording stop method" (p.87),  
"Setting times for the [TIME] setting" (p.84)

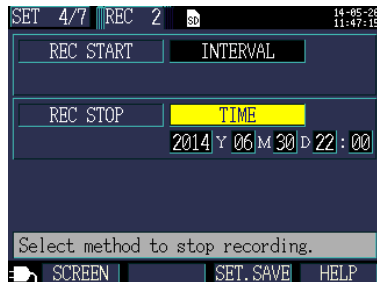

- 2** Once recording has been started and the set recording stop time is reached, recording will stop automatically. (and the recording LED On)

To stop recording before the set stop time is reached, press the <sup>START/STOP</sup>  key, just as when stopping recording manually.

**Reference** If the recording stop time has already passed when starting recording, the instrument will begin recording and continue until recording is stopped manually. To stop recording manually, press the <sup>START/STOP</sup>  key.

## Stopping Recording with a Timer [TIMER]

- 1 Set the [REC STOP] the [SET4/7, REC2] screen to [TIMER] and set the time.

**See:** "Recording stop method" (p.87),  
"Setting the [TIMER]" (p.88)

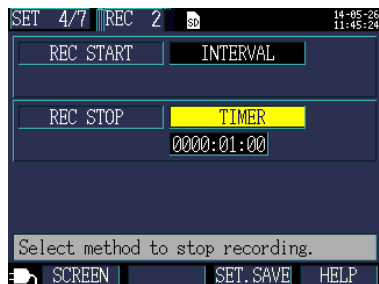

- 2 Once recording has been started and recording will stop automatically when the set timer time elapses. (and the recording LED On)

To stop recording before the set stop time is reached, press the <sup>START/STOP</sup>  key, just as when stopping recording manually.

## 6.3 Repeat Recording [REPEAT]

Repeat recording resets recording every day, segments files, and repeats recording.

- 1** Set the [REC START] on the [SET4/7, REC2] screen to [REPEAT] and set the recording start date, recording stop date, recording time range, and folder segmentation.

**See:** "Recording start method [REC START]" (p.83),  
"Configuring detailed settings for [REPEAT]" (p.85)

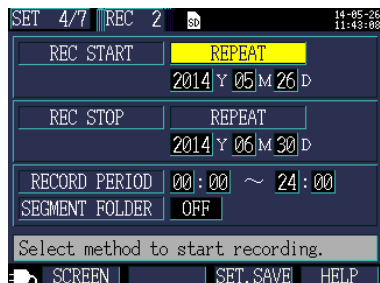

- 2** Press the  key on the Measurement screen.

The instrument will enter the standby state.

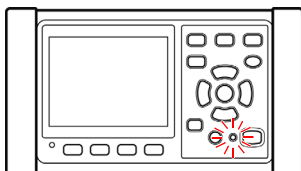

Flashing recording LED

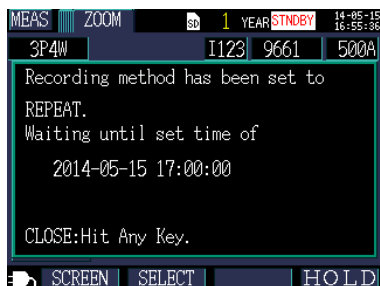

Recording will be started at the start time on the set start date. (The recording LED will light up.)

Recording will repeat at the set interval and time range. (Outside this time range, the recording LED will flash.)

Once the recording time range on the stop date has passed, recording will be stopped.

To stop recording before the set stop time is reached, press the  key, just as when stopping recording manually.

### Reference

If the  key is pressed after the starting time of the recording time period, the interval time starting method is employed.

## 6.4 Operation When a Power Outage Occurs While Recording

If the supply of power to the instrument is cut off while recording is in progress, measurement operation will stop during the outage, but previously recorded measurement data and setting conditions will be backed up. When power returns, a new file will be created, and recording and measurement will continue. If the PW9002 Battery Set (Model 9459 Battery Pack) has been installed, the instrument will automatically switch to battery power in the event of a power outage and continue recording.

**Reference** If the supply of power to the instrument is cut off while accessing the SD memory card, files on the card may be corrupted. Since the SD memory card is accessed frequently when recording with a short save interval time, file corruption is more likely if a power outage occurs during such use.

It will take about 10 seconds for measured values to stabilize once power to the instrument is restored.

It is recommended to avoid power outages by using the optional PW9002 Battery Set (Model 9459 Battery Pack).



# Quick Set

# Chapter 7

## QUICK SET



The Quick Set function provides guidance concerning the following settings and operations, which constitute the minimum level necessary in order to perform recording and measurement:

Basic settings→Connections→Voltage wiring (2 screens)→  
Current wiring→Selecting range→Wiring check→Recording settings→Starting record.

**See:** Measurement Guide (published separately in color)

When not using the Quick Set, configure all settings as desired.

**See:** "Measurement Flowchart" (p.13)

**See:** "Chapter 4 Changing Settings" (p.71)

## 7.1 Settings Configured with the Quick Set

The settings listed below can be configured with the Quick Set. To configure other settings, exit the Quick Set without starting recording after proceeding to **[Quick Set 9/9, Start]** and add the desired settings.

**See:** "7.2 Settings That Can Be Added to Quick Set Settings" (p.128)

- |   |   |
|---|---|
| <ul style="list-style-type: none"> <li>• Wiring<br/>(1P2W/1P3W/3P3W2M/3P3W3M/3P4W)</li> <li>• Clamp sensor</li> <li>• Clock</li> <li>• Current range</li> </ul> | <ul style="list-style-type: none"> <li>• Save interval time</li> <li>• Save item</li> <li>• Recording start method</li> <li>• Recording stop method</li> <li>• File name</li> </ul> |
|---|---|

## 7.2 Settings That Can Be Added to Quick Set Settings

Using the following procedure, normal settings can be applied in combination with the Quick Set to perform recording and measurement as desired:

- 1** Press the  key to start the Quick Set.

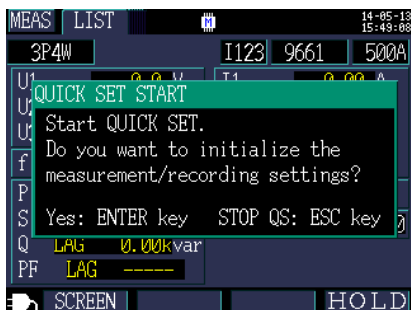

- 2** Following the instructions provided by the Quick Set function, proceed to the [\[QuickSet/9/9, Start\]](#) screen and then press the  **[STOP QS]** key.

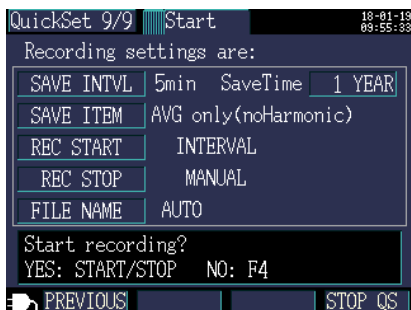

- 3** The [\[QUICK SET END\]](#) dialog box will be displayed.

Press the  **[ENTER]** key to exit the Quick Set function.

The settings configured with the Quick Set up to this point will be saved.

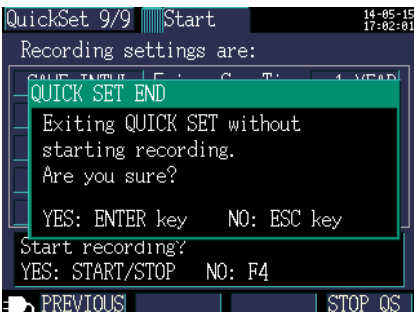



4

Press the  key and configure the necessary settings on the Settings screen.

See: "4.2 Changing Measurement Settings" (p.72)

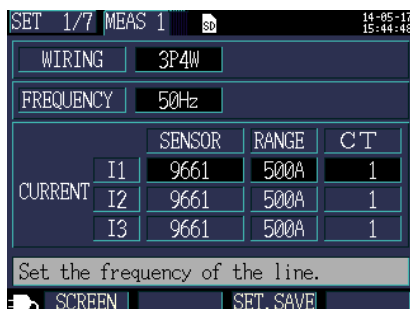

5

Reconfirm the wirings and measured values.

See: "3.9 Verifying Correct Wiring (Wiring Check)" (p.65)

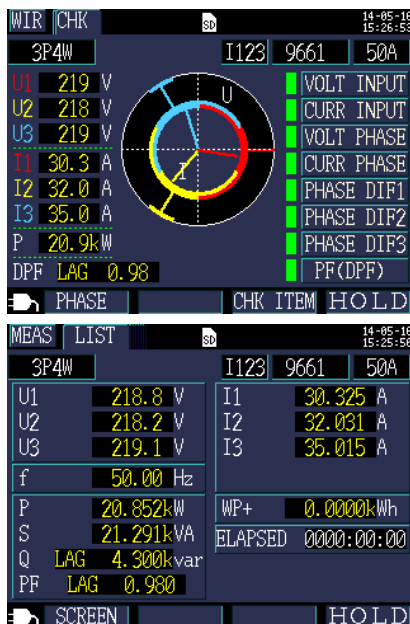

See: "Chapter 5 Viewing Measurement Data" (p.97)

6

Press the  key on the Measurement screen to start recording.



# Saving Data and Manipulating Files Chapter 8

The PW3360 can save the following data on an SD memory card or in its internal memory.

File contents	Extension	Format	SD memory card	Internal memory
Recording and measurement data	CSV	CSV	Available	Available
Harmonic data	HRM	Binary	Available	Not available
Screen copy data	BMP	BMP	Available	Not available
Waveform data	WUI	Binary	Available	Not available
Setting data	SET	Text	Available	Available

The File screen allows you to perform operations such as loading settings data, deleting folders and files, and formatting the SD memory card or internal memory.

# 8.1 Viewing and Using the File Screen

## SD memory card file screen

When you scroll the screen with the / cursor keys, the scroll bar indicates your current position.

Displays the amount of space used on the SD memory card.

Displays the File screen and switches screens (SD memory card/internal memory).

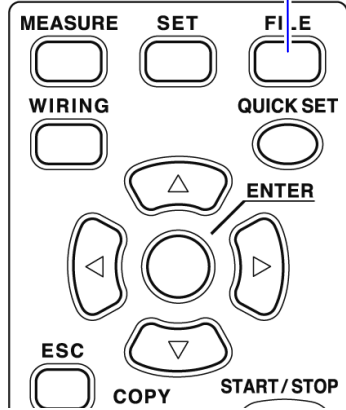
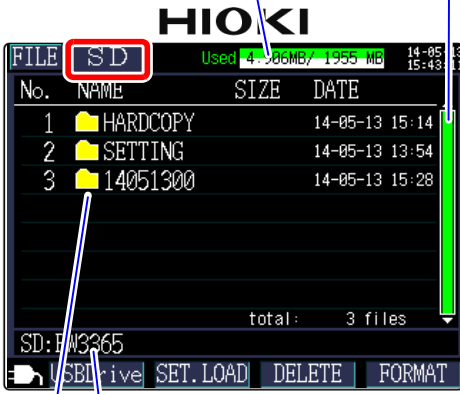

Displays the current display location. In this case, the screen is displaying the PW3365 folder on the SD memory card.

Displays a folder and file list. The list order reflects the order in the save area on the SD memory card.

- : Folder    / or : Move within the folder hierarchy (select folders and files).
- : File    / : Move up and down.

Function keys		Reference
	<b>USB Drive</b>	"9.2 Copying Data to a Computer (USB)" (p.152)
	<b>SET.LOAD</b>	"8.5 Loading Settings Files" (p.142)
	<b>DELETE</b>	"8.7 Deleting Folders and Files" (p.145)
	<b>FORMAT</b>	"8.8 Formatting the SD Memory Card or Internal Memory" (p.146)



**Reference** • The File screen can display folder and file names of up to eight byte characters in length (or four double-byte characters). Longer names are truncated and displayed.

Example: Filename: 1234567890,

Display on File screen: 123456~X (X: number)

- Up to 204 folders and files can be displayed. Folders and files in excess of that number will not be shown.

### Internal memory file screen

When you scroll the screen with the  /  cursor keys, the scroll bar indicates your current position.



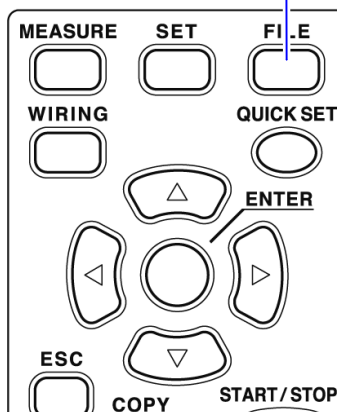
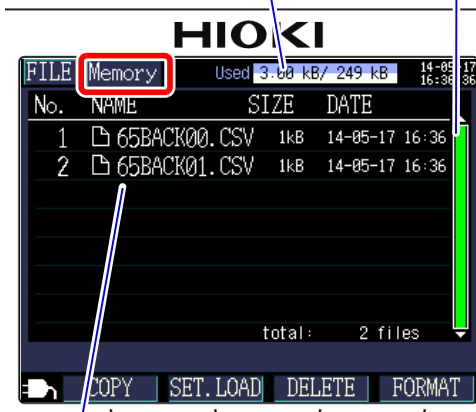

Displays the amount of space used on the internal memory.

Displays the File screen and switches screens (SD memory card/internal memory).



Displays a folder and file list.

The list order reflects the order in the save area on the internal memory.

Function keys	Reference
 <b>COPY</b>	"8.6 Copying Internal Memory Files to the SD Memory Card" (p.144)
 <b>SET. LOAD</b>	"8.5 Loading Settings Files" (p.142)
 <b>DELETE</b>	"8.7 Deleting Folders and Files" (p.145)
 <b>FORMAT</b>	"8.8 Formatting the SD Memory Card or Internal Memory" (p.146)

## 8.2 Folder and File Structure

This section describes the folder and file structure on the SD memory card and in the instrument's internal memory.

### SD Memory Card

The PW3365 base folder is required in order for the instrument to save data on the SD memory card. If the PW3365 base folder does not exist on the SD memory card, it can be created as follows:

#### 1 Insert the SD memory card.

If the PW3365 base folder does not exist on the card, a dialog box asking whether you wish to create it will be displayed.



#### 2 Accept with the [ENTER] key.

The PW3365 base folder (including screen copy and settings folders) will be created in the root folder on the SD memory card.

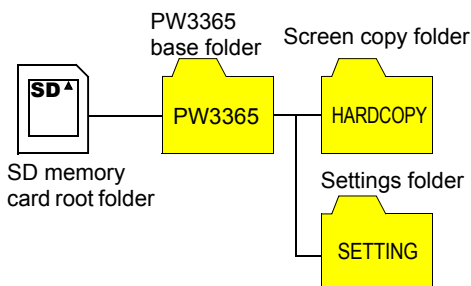

- Reference**
- Even if you choose **[NO]** on the dialog box asking whether you wish to create the PW3365 base folder, the folder will be created the first time data is saved on the SD memory card.
  - The PW3365 base folder cannot be deleted using the instrument.

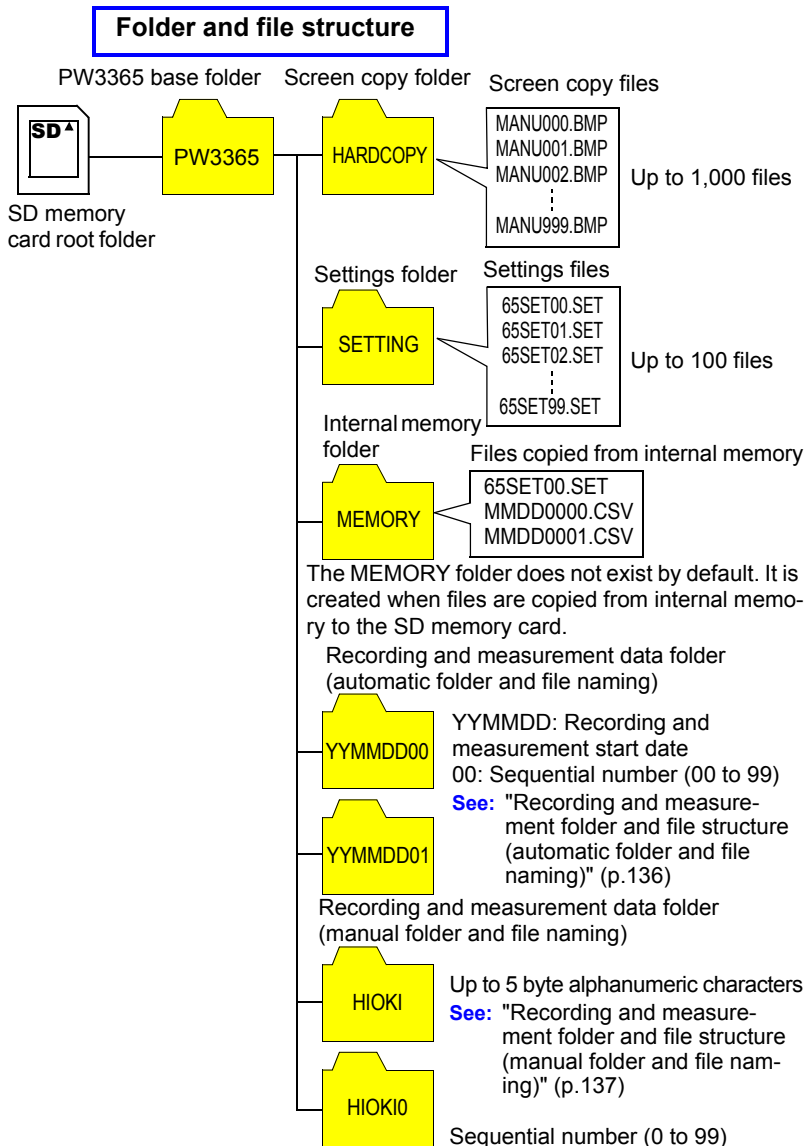

**Reference** • Recording and measurement data files, harmonic data files, and waveform data files are stored in the recording and measurement data folder. When one of the size of them exceeds 200 MB, all the files will be segmented and new files added.

- Up to 203 folders can be created under the PW3365 base folder. If a folder is tried to be created above 203 folders, an error will be displayed.

**Recording and measurement folder and file structure (automatic folder and file naming)**

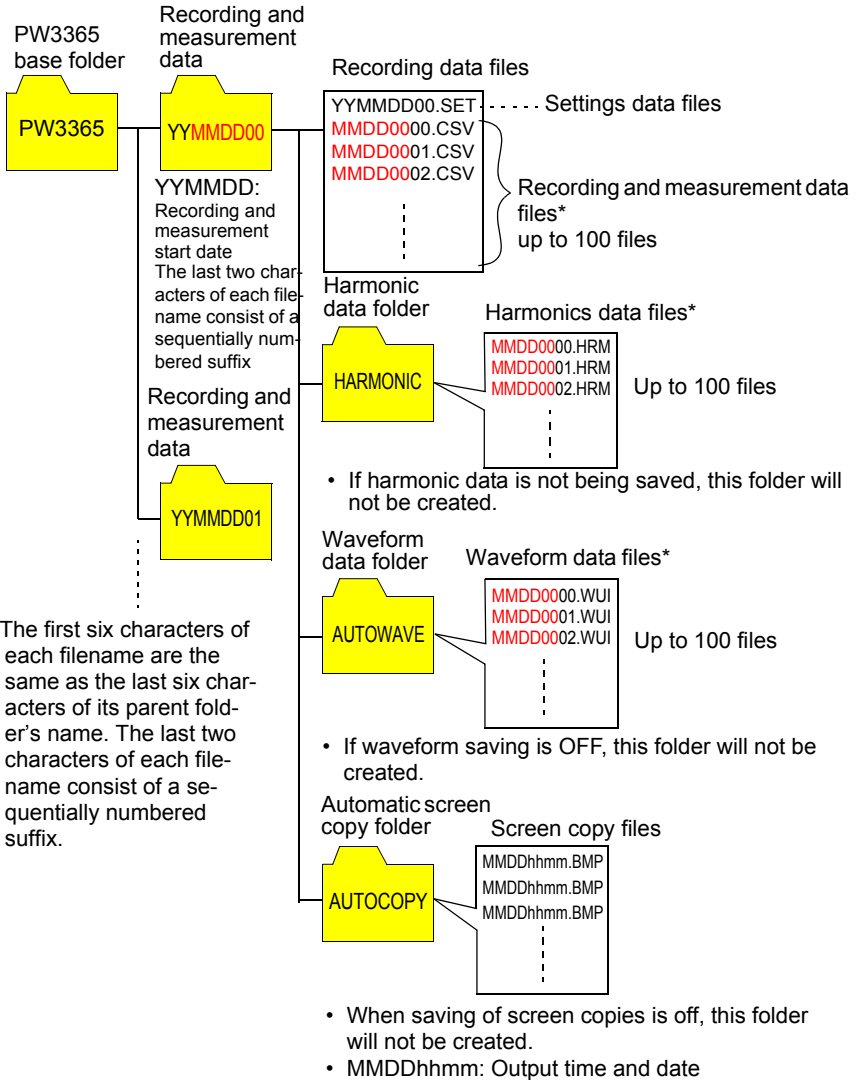

**Reference** When one of the size of recording and measurement data file, harmonic data file, or waveform data file exceeds 200 MB, all the files will be segmented and new files added.



## Recording and measurement folder and file structure (manual folder and file naming)

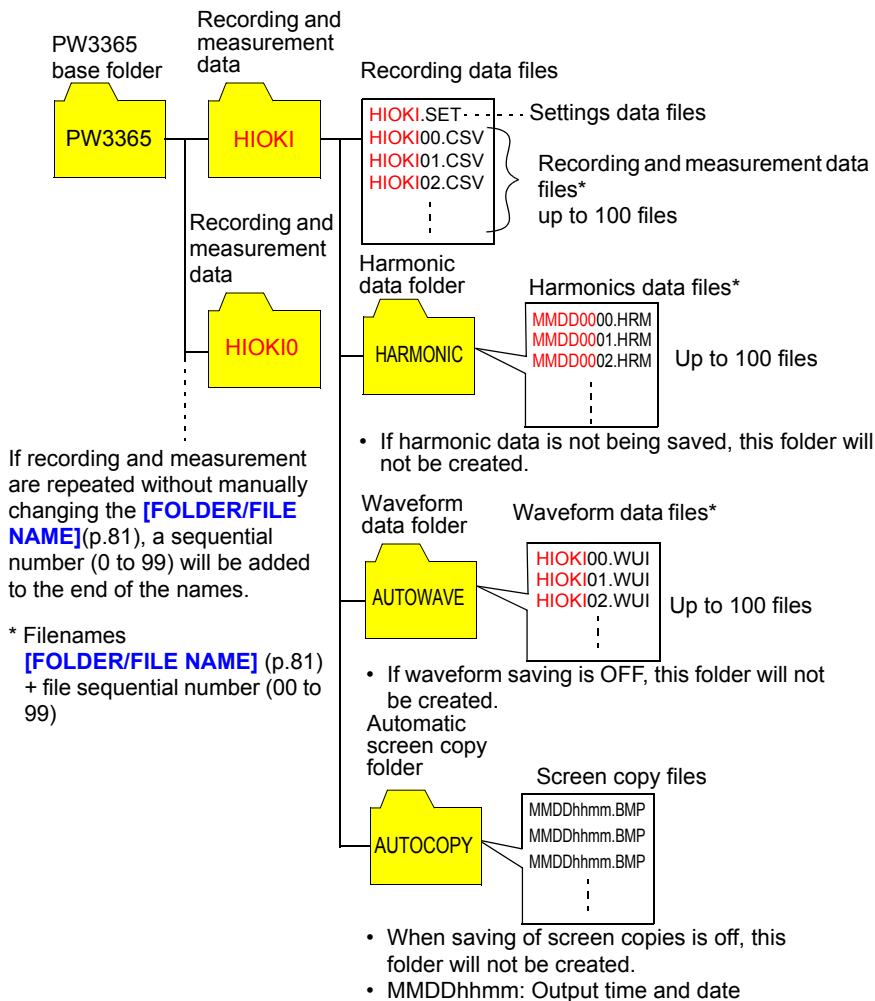

**Reference** When one of the recording and measurement data file, harmonic data file, or waveform data file exceeds 200 MB, all the files will be segmented and new files added.

## 8.2 Folder and File Structure

**Reference** The following table shows a guideline of recording times for which an SD memory card can record data. The available recording time varies depending on setting conditions.

### Available Recording Time

Interval time	Save Time	
	Saving of harmonic data: OFF	Saving of harmonic data: ON
1 seconds	15.6 days	2.8 days
2 seconds	31.2 days	5.5 days
5 seconds	77.9 days	13.8 days
10 seconds	155 days	27.6 days
15 seconds	233 days	41.5 days

Interval time	Save Time	
	Saving of harmonic data: OFF	Saving of harmonic data: ON
30 seconds	1 year	82.9 days
1 minutes	1 year	165 days
2 minutes	1 year	331 days
5 minutes	1 year	1 year
More than 10 minutes	1 year	1 year

Save conditions for above figures

Measurement target: 3P4W

Storage media: Z4001 SD card 2 GB

Saved parameters: All data: average, maximum, and minimum values

Screen copy saving: OFF      Waveform save : OFF

## Internal Memory

Setting files and recording and measurement data files can be stored in the instrument's internal memory. Since harmonic measurement data, screen copies, and waveform data cannot be saved in internal memory, they must be saved on the SD memory card.

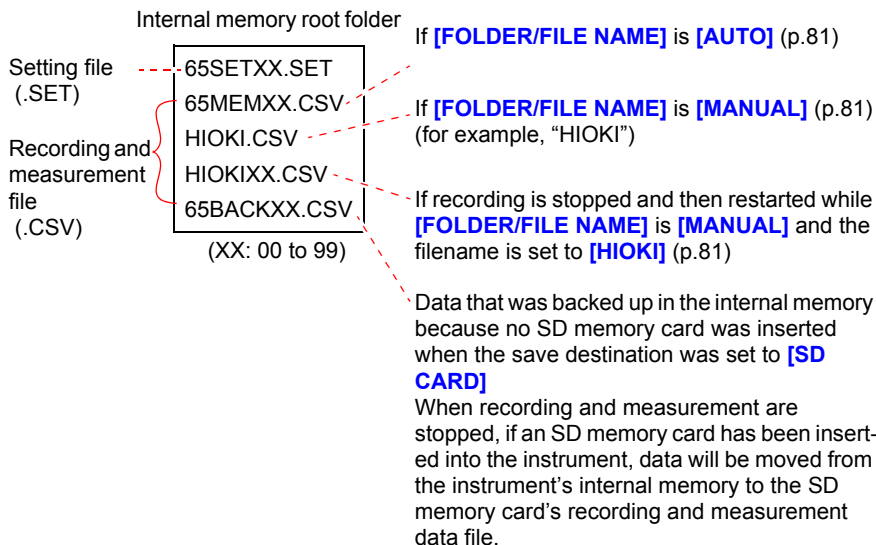

**Reference** The maximum number of files that can be created in the instrument's internal memory is 100. Attempting to create more than 100 files will result in an error.

## 8.3 Saving Copies of the Screen (SD Memory Card Only)

The screen currently being displayed can be saved in BMP file format on the SD memory card.

**Reference** Even if the **[SAVE TO...]** (p.78) is set to **[INTERNAL M]**, screen copies are saved on the SD memory card. If no SD memory card has been inserted, screen copies cannot be saved.

### 1 Verify that an SD memory card has been inserted into the instrument.

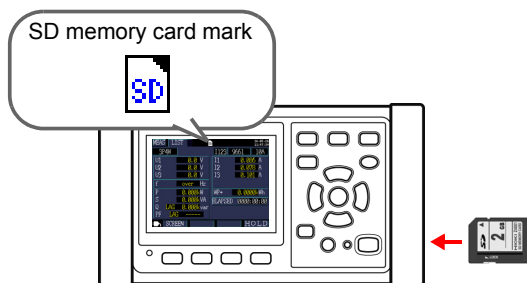

### 2 Display the screen you wish to save and press the **COPY** key.

You can save a hold screen by pressing the **F4** **[HOLD]** key.

The screen will be saved in the **[PW3365]-[HARDCOPY]** folder in the SD memory card's root folder (at the top of the card's folder hierarchy).

**See:** "8.2 Folder and File Structure" (p.134)

## 8.4 Saving Settings Files

By saving the current settings state and then later loading the corresponding settings file, you can restore the instrument to its state at the time the settings were saved.

### 1 Set the settings file save destination.

Set the save destination on the [SET3/7, REC1] screen to either SD memory card or internal memory.

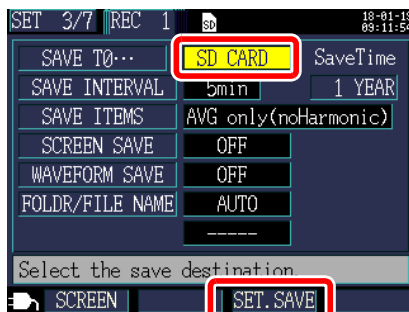

### 2 Press the **F3** [SET.SAVE] key on the Settings screen.

Save destination	Settings file save location
SD memory card	Files are saved in the [PW3365]- [SETTINGS] folder in the SD memory card's root folder (at the top of the card's folder hierarchy). <b>See:</b> "8.2 Folder and File Structure" (p.134)
Internal memory	Files are saved in the root folder (at the top of the internal memory's folder hierarchy). <b>See:</b> "Internal Memory" (p.143)

**Reference** • Up to 100 settings files can be saved.

- Files are named automatically. 65SETXX.SET (XX:00 to 99)

## 8.5 Loading Settings Files

This section describes how to load a settings file that was previously saved on the SD memory card or in the instrument's internal memory.



**Reference** LAN settings are not loaded.



### SD Memory Card

- 1** Press the  key to display the **[FILE, SD]** screen.



- 2** Select the settings file (with the **.SET** extension) to load.

 /  or  : Move within the folder hierarchy.

 /  : Move up and down.

(Select folders and files)

Settings files saved using the functionality provided by the instrument for saving settings can be found in the **[PW3365]-[SETTING]** folder.



- 3** Press the  **[SET. LOAD]** key.

- 4** When the confirmation dialog box is displayed, press the  **[ENTER]** key.

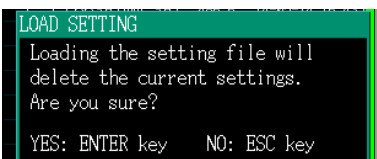

## Internal Memory

1

Press the  key to display the [FILE, Memory] screen.



2

Select the settings file (with the .SET extension) to load.

 /  : Move up and down (select a file).

3

Press the  [SET.LOAD] key.

4

When the confirmation dialog box is displayed, press the  [ENTER] key

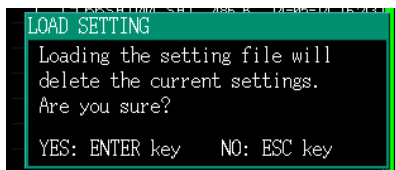

## 8.6 Copying Internal Memory Files to the SD Memory Card

This section describes how to copy internal memory files to the SD memory card.

- 1** Press the  key to display the **[FILE, Memory]** screen.



- 2** Select the file to copy to the SD memory card.

- 3** Press the  **[COPY]** key.

- 4** When the confirmation dialog box is displayed, press the  **[ENTER]** key.

The file will be saved in the **[PW3365] - [MEMORY]** folder in the SD memory card's root folder (at the top of the card's folder hierarchy).

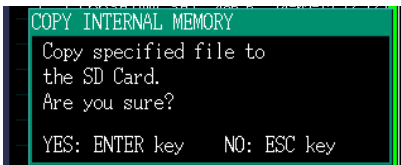







## 8.7 Deleting Folders and Files

This section describes how to delete folders and files stored on the SD memory card or in the instrument's internal memory.

- 1** Press the  key to display the [FILE, SD] or [FILE, Memory] screen.



- 2** Select the folder or file to delete.

 /  or  : Move within the folder hierarchy. (SD memory card only)  
 /  : Move up and down. (Select folders and files)

- 3** Press the  [DELETE] key. A confirmation dialog box will be displayed.

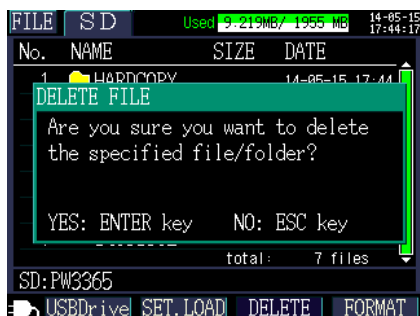

- 4** Accept with the  [ENTER] key.

**Reference** The [PW3365] folder cannot be deleted.

## 8.8 Formatting the SD Memory Card or Internal Memory

This section describes how to format an SD memory card or the instrument's internal memory.

### IMPORTANT

Formatting will cause all saved data to be erased, and it cannot be undone. Check the contents of the card or memory before formatting. It is recommended to back up important data on SD memory cards and in the instrument's internal memory.

1

Press the  key to display the [FILE, SD] screen or the [FILE, Memory] screen.

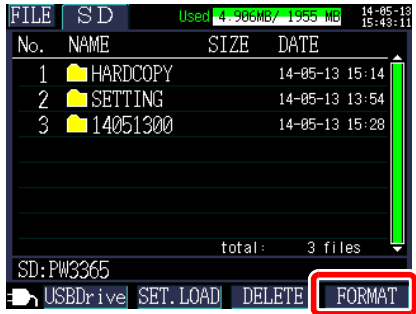

2

Press the  [FORMAT] key. A confirmation dialog box will be displayed.

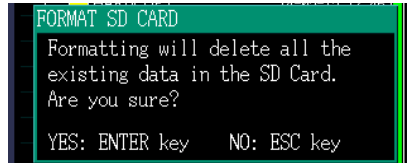

3

Accept with the  [ENTER] key.

When formatting of an SD memory card completes, the PW3365 basic folder (which is used to store screen copies and settings folders) will be automatically created in the root folder of the card.

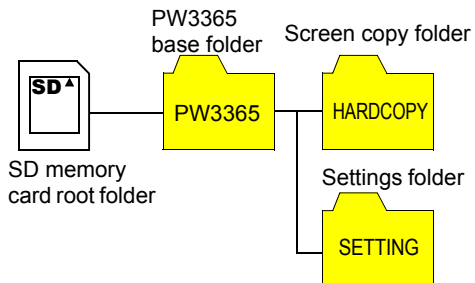

### ***8.8 Formatting the SD Memory Card or Internal Memory***

- Reference**
- Use the instrument to format SD memory cards. Formatting a card with a computer may prevent the media from being initialized with the dedicated SD format, causing decreased performance in the form of slower read and write speeds.
  - The instrument can only save data to SD memory cards that have been initialized with the dedicated SD format.



# Analyzing Data on a Computer

## Chapter 9

This section describes how to load data recorded with the instrument onto a computer and analyze it using the optional SF1001 Power Logger Viewer application. Recording and measurement data can also be checked by loading it into the graphics software such as Excel®.

**See:** SF1001 Power Logger Viewer Instruction Manual



To access data, either load it from the SD memory card on which it was saved using a computer with an SD memory card reader, or use a USB cable to copy data from the SD memory card or internal memory to the computer.

File content	Extension	Format	Supported application software	
			Model SF1001 supported	Other than SF1001
Recording and measurement data	CSV	CSV	Available	<ul style="list-style-type: none"> <li>• Spreadsheet software</li> <li>• PW3360/PW3365</li> <li>• Excel automatic graphing software (p.168)</li> </ul>
Harmonic data	HRM	Binary	Available	-
Waveform data	WUI	Binary	Available	-
Screen copy data	BMP	BMP	Not Available	• Graphics Software
Setting data	SET	Text	Not Available	• Text editor

## 9.1 Copying Data to a Computer (SD)

This section describes how to eject the SD memory card from the instrument and copy data from the card to a computer. If the computer does not have an SD memory card slot, please purchase an SD memory card reader.

### Windows 7

---

---

**1** Verify that recording and measurement have stopped.

Removing a card while data is being written to it may damage the card.

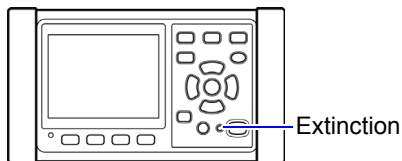

---

---

**2** Eject the SD memory card from the instrument.

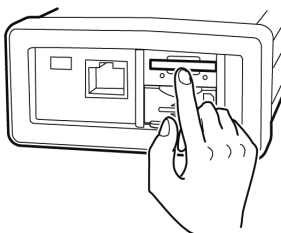

---

---

**3** Insert the SD memory card into the SD memory card slot on the computer.

---

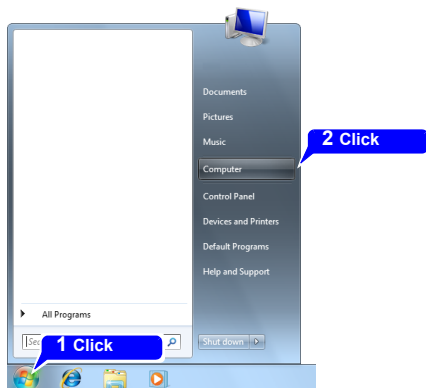
**4** Click the start button - [Computer].**5** Double click the [[PW3365SD].**Reference**

If the SD memory card was not formatted with instrument, [Removable Disk] will be displayed.

**6** Copy the necessary folders or files to the specified folder on the computer.

## 9.2 Copying Data to a Computer (USB)

This section describes how to copy data from an SD memory card or the instrument's internal memory to a computer by connecting the instrument and computer with the included USB cable.

When connecting the instrument with USB, there is no need to configure any instrument settings.

**CAUTION** To avoid malfunctions, do not connect or disconnect the USB cable while the instrument is operating.

- Reference**
- If the instrument and computer are both off and connected with the USB cable, turn on the computer and then the instrument. Powering up the devices in a different order may prevent the instrument and computer from communicating.
  - Copying large data files from the SD memory card to a computer via the instrument's USB interface can be time-consuming. When you need to copy a large data file to a computer, it is recommended to use an SD memory card reader.

**1** Turn on the computer.

**2** Turn on the instrument.

**3** Connect the instrument and computer with the included USB cable.

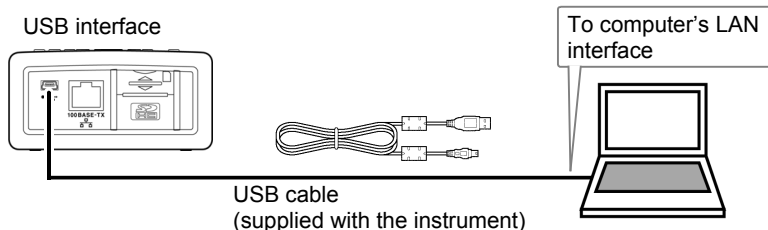

**4** Press the **FILE** key to display the File screen.



## 5 Press the **F1** [USB Drive] key on the [FILE, SD] screen.

If the instrument is connected to the computer, the following message will be displayed on the instrument:

Connecting to mass storage.  
To cancel, hit ESC.  
Cancel: ESC

The computer will recognize the SD memory card and internal memory as removable disks.

### • Devices with Removable Storage (3)

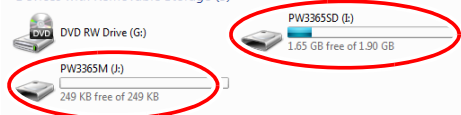

Internal memory      SD memory card

If the SD memory card was formatted with the PW3365, "PW3365SD" will have been written to the volume label, and that label will be displayed. If the SD memory card was not formatted with the PW3365, [Removable Disk] (or the previously written volume label) will be displayed.

## 6 Copy the necessary folders or files to the specified folder on the computer.

- Reference**
- Data on the instrument's SD memory card or internal memory cannot be manipulated (to delete files, change filenames, etc.) from the computer.
  - No USB drive can be connected if no SD memory card has been inserted.

## 9.2 Copying Data to a Computer (USB)

### Disconnecting the cable from the computer

Use the following procedure to disconnect a USB cable that is connected to the instrument from a running computer:

---

---

**1**

Press the <sup>ESC</sup>  key to terminate the USB connection.

Alternately, eject the disks by using the [\[Safely Remove Hardware and Eject Media\]](#) icon on the computer.

---

---

**2**

Disconnect the USB cable from the computer.

**Reference** To reconnect the instrument to a computer (as a mass-storage device)

after pressing the <sup>ESC</sup>  key to terminate the USB connection, disconnect the USB cable, restart the instrument, and then reestablish the connection.

---

## 9.3 SF1001 Power Logger Viewer (Optional)

The SF1001 Power Logger Viewer is a software application that runs on a computer to analyze data recorded with the instrument. The SF1001 can load measurement data recorded with the instrument. However, note that it may lose the ability to load files if they are opened with another application or overwritten, causing the format to change.

The SF1001 provides the following capabilities:

- ◆ **Displaying a time-series graph (2-axis display)**  
Select parameters and display a time-series graph.

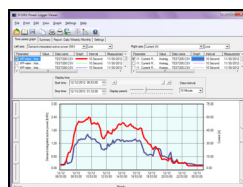

- ◆ **Displaying a ledger-style list**  
Select parameters and display a time-series data.

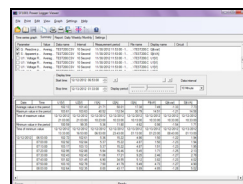

- ◆ **Harmonic display (when harmonic data was saved)**  
Displays a harmonic list and harmonic graph for the specified time.

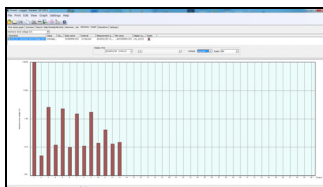

- ◆ **Waveform display (when waveform data was saved)**  
Displays waveforms.

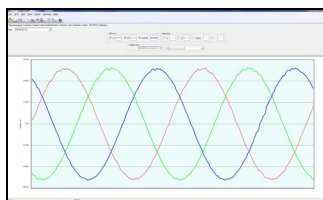

### Reference

The PW9020 Safety Voltage Sensor generates an internal voltage that is equivalent to the measurement voltage by means of switching operation. Due to the effects of switching operation, a frequency component that is not actually contained may be superposed onto the waveform data.

### 9.3 SF1001 Power Logger Viewer (Optional)

#### ◆ Displaying settings

You can load settings data contained in measurement data and review the setting conditions that were used at the time of measurement.

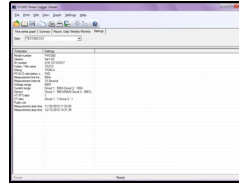

#### ◆ Printing reports

You can print user-specified measurement data as reports.

Date	Time	Voltage	Current	Power	Energy
2010/10/10	00:00:00	1.0000	0.0000	0.0000	0.0000
2010/10/10	00:00:01	1.0000	0.0000	0.0000	0.0000
2010/10/10	00:00:02	1.0000	0.0000	0.0000	0.0000
2010/10/10	00:00:03	1.0000	0.0000	0.0000	0.0000
2010/10/10	00:00:04	1.0000	0.0000	0.0000	0.0000
2010/10/10	00:00:05	1.0000	0.0000	0.0000	0.0000
2010/10/10	00:00:06	1.0000	0.0000	0.0000	0.0000
2010/10/10	00:00:07	1.0000	0.0000	0.0000	0.0000
2010/10/10	00:00:08	1.0000	0.0000	0.0000	0.0000
2010/10/10	00:00:09	1.0000	0.0000	0.0000	0.0000
2010/10/10	00:00:10	1.0000	0.0000	0.0000	0.0000

#### ◆ Converting measurement data into CSV-format files

You can convert a user-specified range of measurement data into a CSV-format file.

You can also load harmonic data that was saved in the binary format into a spreadsheet application by converting it to the CSV format.

Date	Time	Voltage	Current	Power	Energy
2010/10/10	00:00:00	1.0000	0.0000	0.0000	0.0000
2010/10/10	00:00:01	1.0000	0.0000	0.0000	0.0000
2010/10/10	00:00:02	1.0000	0.0000	0.0000	0.0000
2010/10/10	00:00:03	1.0000	0.0000	0.0000	0.0000
2010/10/10	00:00:04	1.0000	0.0000	0.0000	0.0000
2010/10/10	00:00:05	1.0000	0.0000	0.0000	0.0000
2010/10/10	00:00:06	1.0000	0.0000	0.0000	0.0000
2010/10/10	00:00:07	1.0000	0.0000	0.0000	0.0000
2010/10/10	00:00:08	1.0000	0.0000	0.0000	0.0000
2010/10/10	00:00:09	1.0000	0.0000	0.0000	0.0000
2010/10/10	00:00:10	1.0000	0.0000	0.0000	0.0000



**Saving Data as an Excel® File**

When you open measurement data in Excel® and overwrite the original file by saving it as a CSV-format file, the file format will change. When you open a measurement (CSV-format) file, save it as an Excel® file (.xls or .xlsx).

**1** Click **[file]-[Save As]** on the menu bar.

**2** Specify the save destination.

The file can be saved anywhere you wish.

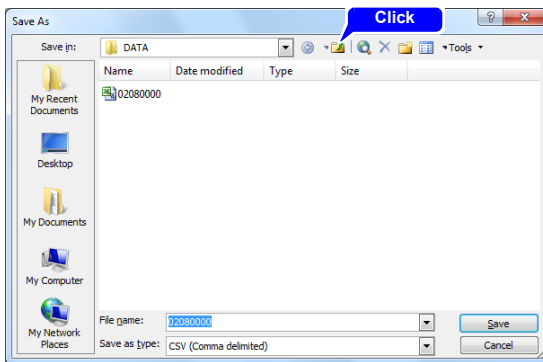

**3** Select **[Microsoft Office Excel Workbook]** under **[Save as type]**.

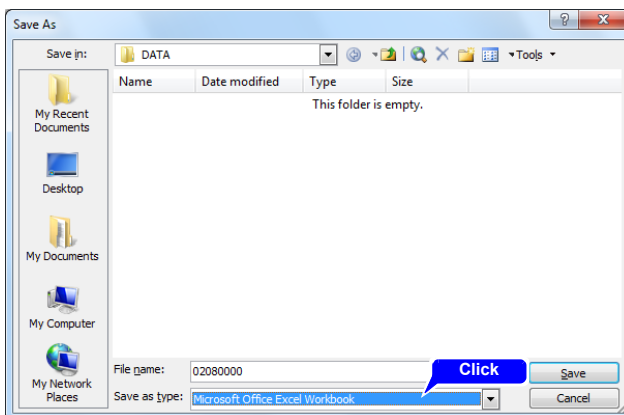

**4** Change the filename as necessary and click **[Save]**.

## Example of Data from a Measurement File

An example of data from a measurement file is shown below:

	A	B	C	D	E	F	G	H
1	HICKI PW3365(Ver1.00)	S/N123456789						
2	FOLDER	14062000						
3	WIRING	3P3W2M						
4	OPERATION	RMS						
5	FREQUENCY	50Hz						
6	INTERVAL	1min						
7	U RANGE	400V						
8	U SENSOR	PW8020						
9	I RANGE	500A						
10	I SENSOR	9661(500A)						
11	VT(PT)	1						
12	CT	1						
13	ENERGY COST	0.						
14								
15	2014/6/20 9:00	START						
16	Date	Etime	Status	Freq_Avg[V]	U1_Avg[V]	Ufn01_Avg	Udeg1_Avg	U2_Avg
17	2014/6/20 9:00							
18	2014/6/20 9:00	0000.01.00		0	5.00E+01	2.00E+02	2.00E+02	2.00E
19	2014/6/20 9:00	0000.02.00		0	5.00E+01	2.00E+02	2.00E+02	2.00E
20	2014/6/20 9:00	0000.03.00		0	5.00E+01	2.00E+02	2.00E+02	2.00E
21	2014/6/20 9:00	0000.04.00		0	5.00E+01	2.00E+02	2.00E+02	2.00E
22	2014/6/20 9:00	0000.05.00		0	5.00E+01	2.00E+02	2.00E+02	2.00E
23	2014/6/20 9:00	0000.03.00		0	5.00E+01	2.00E+02	2.00E+02	2.00E

Instrument information (p.160)

Recording start time

Measurement data header (p.162)

Measurement information (p.161)

Measurement data (p.166)

## Measurement File Contents

### Instrument information

Parameter	Parameter name	Format	Description
HIOKI PW3365 (VerX.XX)	Instrument information (Version number)	S/N.123456789	PW3365's serial number
FOLDER	Folder name	Automatic: YYMMDDXX User-specified: ABCDE (5 characters)	Folder name (For data in internal memory, the filename is shown.)
WIRING	Wiring	1P2W/1P2Wx2/ 1P2Wx3/ 1P3W/1P3W1U/ 1P3W+I/ 1P3W1U+I/3P3W2M/ 3P3W2M+I/ 3P3W3M/3P4W/ I/Ix2/Ix3	Wiring settings I: Current only
OPERATION	PF/Q/S calculation selection	RMS/FND	Power factor PF / reactive power Q / apparent power S calculation selection RMS: RMS calculation FND: Fundamental wave calculation
FREQUENCY	Frequency	50Hz/60Hz	Frequency setting
THD	THD (Total harmonic distortion) Calculation selection	THD-F/ THD-R	Calculation selection at the total harmonic distortion "Appendix 5 Terminology" (p.A11)
INTERVAL	Save interval time	1sec/2sec/5sec/10sec/ 15sec/30sec/1min/2min/ 5min/10min/15min/ 20min/30min/60min	Save interval time
U RANGE	Voltage range	400V	Voltage range setting Fixed at 400V
I RANGE	Current range	5A/10A/50A/100A/500A (when the 9661 sensor is selected)	Current range setting Varies with clamp sensor type. If there are multiple circuits, the current range for each is included.



### 9.4 Checking Recording and Measurement Data with Excel®

Parameter	Parameter name	Format	Description
SENSOR	Clamp sensor	9660(100A)/9661(500A)/ 9694(5A)/9669(1000A)/ 9695-02(50A)/ 9695-03(100A)/ CT9667(500A)/ CT9667(5000A)/ 9657-10(10A)/9675(10A)	Clamp sensor setting If there are multiple circuits, the clamp sensor for each is included.
VT(PT)	VT (PT) ratio	User-specified: 0000.01 to 9999.99 Selected: 1/60/100/200/300/ 600/700/1000/2000/ 2500/5000	VT (PT) ratio setting
CT	CT ratio	User-specified: 0000.01 to 9999.99 Selected: 1/40/60/80/120/ 160/200/240/300/400/ 600/800/1200	CT ratio setting If there are multiple circuits, the ratio for each is included.
ENERGY COST	Energy unit cost	0.00000 to 99999.9	Energy unit cost setting (/kWh)
	Energy cost currency	User-specified: ABC (3 characters)	Energy cost currency setting

### Measurement information

Parameter	Parameter name	Format	Description
Date	Output time and date	YYYY-MM-DD hh:mm:ss	Output time and date
Etime	Elapsed time	hhhh:mm:ss	Elapsed time from start of recording
Status	Measurement Information	HGFEDCBA (A to H: 0 or 1)	A : U1 (voltage CH1) peak exceeded B : U2 (voltage CH2) peak exceeded C : U3 (voltage CH3) peak exceeded D : I1 (current CH1) peak exceeded E : I2 (current CH2) peak exceeded F : I3 (current CH3) peak exceeded G : Frequency error H : Power outage during interval time Example: If data includes I1 (current CH1) data in excess of peak: 00001000

**Measurement data header**

- For average value data, “Avg” is shown as “xxx”.
- For maximum value data, “Max” is shown as “xxx”.
- For minimum value data, “Min” is shown as “xxx”.
- Units are shown in brackets after the parameter name.
- Average values are not available for voltage and current peak values.
- For current-only wirings, no average value is available for the current fundamental wave phase angle.

Parameter	Parameter name	Description
Freq_xxx[Hz]	Frequency	
U1_xxx[V]	Voltage RMS U1(CH1)	
U2_xxx[V]	U2(CH2)	
U3_xxx[V]	U3(CH3)	
U12_xxx[V]	U12(CH12) For 3P3W2M wirings, value for third channel as calculated from U1 and U2	
Ufnd1_xxx[V]	Voltage fundamental waveform value U1(CH1)	
Ufnd2_xxx[V]	U2(CH2)	
Ufnd3_xxx[V]	U3(CH3)	
Ufnd12_xxx[V]	U12(CH12) For 3P3W2M wirings, value for third channel as calculated from U1 and U2	<b>See:</b> "5.4 Viewing Voltage and Current Value Details (RMS/Fundamental Wave/Peak Values, and Phase Angles)" (p.102)
Upeak1_xxx[V]	Peak value of the voltage waveform (Absolute value) U1(CH1)	
Upeak2_xxx[V]	U2(CH2)	
Upeak3_xxx[V]	U3(CH3)	
Upeak12_xxx[V]	U12(CH12) For 3P3W2M connections, value for third channel as calculated from U1 and U2	
Udeg1_xxx[deg]	Voltage fundamental phase angle U1(CH1)	
Udeg2_xxx[deg]	U2(CH2)	
Udeg3_xxx[deg]	U3(CH3)	
Udeg12_xxx[deg]	U12(CH12) For 3P3W2M connections, value for third channel as calculated from U1 and U2	

### 9.4 Checking Recording and Measurement Data with Excel®

Parameter	Parameter name	Description
I1_xxx[A]	Current RMS I1(CH1)	<b>See:</b> "5.4 Viewing Voltage and Current Value Details (RMS/Fundamental Wave/Peak Values, and Phase Angles)" (p.102)
I2_xxx[A]	I2(CH2)	
I3_xxx[A]	I3(CH3)	
I12_xxx[A]	I12(CH12) For 3P3W2M wirings, value for third channel as calculated from I1 and I2	
Ifund1_xxx[A]	Current fundamental wave value I1(CH1)	
Ifund2_xxx[A]	I2(CH2)	
Ifund3_xxx[A]	I3(CH3)	
Ifund12_xxx[A]	I12(CH12) For 3P3W2M wirings, value for third channel as calculated from I1 and I2	
Ipeak1_xxx[A]	Peak value of the current waveform (Absolute value) I1(CH1)	
Ipeak2_xxx[A]	I2(CH2)	
Ipeak3_xxx[A]	I3(CH3)	
Ipeak12_xxx[A]	I12(CH12) For 3P3W2M connections, value for third channel as calculated from I1 and I2	
Ideg1_xxx[deg]	Current fundamental phase angle I1(CH1)	
Ideg2_xxx[deg]	I2(CH2)	
Ideg3_xxx[deg]	I3(CH3)	
Ideg12_xxx[deg]	I12(CH12) For 3P3W2M connections, value for third channel as calculated from I1 and I2	
P1_xxx[W]	Active power P1(CH1)	
P2_xxx[W]	P2(CH2)	
P3_xxx[W]	P3(CH3)	
P_xxx[W]	P(total)	
S1_xxx[VA]	Apparent power S1(CH1)	
S2_xxx[VA]	S2(CH2)	
S3_xxx[VA]	S3(CH3)	
S_xxx[VA]	S(total)	
Q1_xxx[var]	Reactive power Q1(CH1)	
Q2_xxx[var]	Q2(CH2)	
Q3_xxx[var]	Q3(CH3)	
Q_xxx[var]	Q(total)	

### 9.4 Checking Recording and Measurement Data with Excel®

Parameter	Parameter name	Description
PF1_xxx	Power factor PF1(CH1)	<b>See:</b> "PF/Q/S calculation [PF/Q/S CALC]" (p.75) <b>See:</b> "Appendix 5 Terminology" (p.A11)
PF2_xxx	PF2(CH2)	
PF3_xxx	PF3(CH3)	
PF_xxx	PF(total)	
DPF1_xxx	Displacement power factor DPF1(CH1)	
DPF2_xxx	DPF2(CH2)	
DPF3_xxx	DPF3(CH3)	
DPF_xxx	DPF(total)	
WP+[Wh]	Active energy (Consumption)	Active energy from start of recording (Consumption)
WP+1[Wh] to WP+3[Wh]	Active energy (Consumption), first circuit to third circuit Active energy (Consumption) for each of three 1P2W circuits	
WP-[Wh]	Active energy (Regeneration)	Active energy from start of recording (Regeneration)
WP-1[Wh] to WP-3[Wh]	Active energy (Regeneration), first circuit to third circuit Active energy (Regeneration) for each of three 1P2W circuits	
WQLAG[varh]	Reactive energy (Lag)	Reactive energy from start of recording (Lag)
WQLAG1[varh] to WQLAG3[varh]	Reactive energy (Lag), first circuit to third circuit Reactive energy (Lag) for each of three 1P2W circuits	
WQLEAD[varh]	Reactive energy (Lead)	Reactive energy from start of recording (Lead)
WQLEAD1[varh] to WQLEAD3[varh]	Reactive energy (Lead), first circuit to third circuit Reactive energy (Lead) for each of three 1P2W circuits	
WP+dem[Wh]	Active power demand quantity (Consumption)	Active energy (Consumption) for each interval time
WP+dem1[Wh] to WP+dem3[Wh]	Active power demand quantity (Consumption), first circuit to third circuit Active power demand quantity (Consumption) for each of three 1P2W circuits	
WP+[Wh]	Active energy (Consumption)	Active energy from start of recording (Consumption)
WP+1[Wh] to WP+3[Wh]	Active energy (Consumption), first circuit to third circuit Active energy (Consumption) for each of three 1P2W circuits	

### 9.4 Checking Recording and Measurement Data with Excel®

Parameter	Parameter name	Description
WP-dem[Wh]	Active power demand quantity (Regeneration)	Active energy (Regeneration) for each interval time
WP-dem1[Wh] to WP-dem3[Wh]	Active power demand quantity (Regeneration), first circuit to third circuit Active power demand quantity (Regeneration) for each of three 1P2W circuits	
WQLAGdem[varh]	Reactive power demand quantity (Lag)	Reactive energy (Lag) for each interval time
WQLAGdem1[varh] to WQLAGdem3[varh]	Reactive power demand quantity (Lag), first circuit to third circuit Reactive power demand quantity (Lag) for each of three 1P2W circuits	
WQLEADdem[varh]	Reactive power demand quantity (Lead)	Reactive energy (Lead) for each interval time
WQLEADdem1[varh] to WQLEADdem3[varh]	Reactive power demand quantity (Lead), first circuit to third circuit Active power demand quantity for each of three 1P2W circuits	
Pdem+[W]	Active power demand value (Consumption)	Average value of active power (Consumption) for each interval time
Pdem+1[W] to Pdem+3[W]	Active power demand value (Consumption), first circuit to third circuit Active power demand value (Consumption) for each of three 1P2W circuits	
Pdem-[W]	Active power demand value (Regeneration)	Average value of active power (Regeneration) for each time interval
Pdem-1[W] to Pdem-3[W]	Active power demand value (Regeneration), first circuit to third circuit Active power demand value (Regeneration) for each of three 1P2W circuits	
QdemLAG[var]	Reactive power demand value (Lag)	Average value of reactive power (Lag) for each time interval
QdemLAG1[var] to QdemLAG3[var]	Reactive power demand value (Lag), first circuit to third circuit Reactive power demand value (Lag) for each of three 1P2W circuits	
QdemLEAD[var]	Reactive power demand value (Lead)	Average value of reactive power (Lead) for each time interval
QdemLEAD1[var] to QdemLEAD3[var]	Reactive power demand value (Lead), first circuit to third circuit Reactive power demand value (Lead) for each of three 1P2W circuits	

### 9.4 Checking Recording and Measurement Data with Excel®

Parameter	Parameter name	Description
PFdem	Power factor demand value	The average value of the power factor for each time interval $\frac{P_{dem} +}{\sqrt{(P_{dem} +)^2 + (Q_{demLAG})^2}}$
PFdem1 to PFdem3	Power factor demand value, first circuit to third circuit Power factor demand value for each of three 1P2W circuits	

#### Measurement data

Data	Data format	Description
Normal data	12.345E+00	Outputs exponential data.
Invalid data	0.0000E+99	If the display reads [-----] and measurement is not possible, outputs invalid data. Example: With no input, it is not possible to measure the power factor (resulting in invalid data).

## Converting Measured Value Exponential Data

Measured values are displayed exponentially so that the instrument can accommodate values of varying lengths. To make it easier to view data in Excel®, exponential data can be converted into numerical data.

**1** Select the column labels you wish to convert into numerical data and right-click with the mouse.

**2** Select **[Format Cells]**.

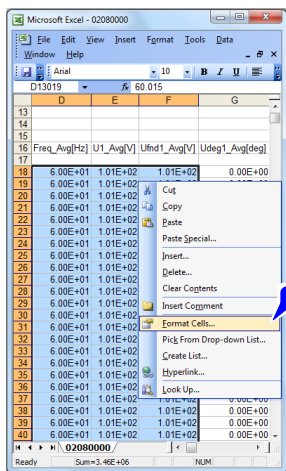

Example  
The figure shows column D, E, and F are selected (Microsoft Office Excel® 2010)

**3** On the **[Format Cells]** dialog box, click the **[Number]** tab.

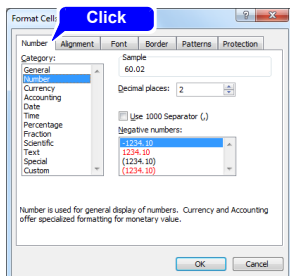

**4** Select **[Number]** and click **[OK]**.

**5** Select **[Number]** and change the number of decimal places as necessary.

## 9.5 Using the PW3360/PW3365 Excel automatic graphing software

By installing the PW3360/PW3365 Excel automatic graphing software, you can automatically create graphs from recording and measurement data in Excel®.

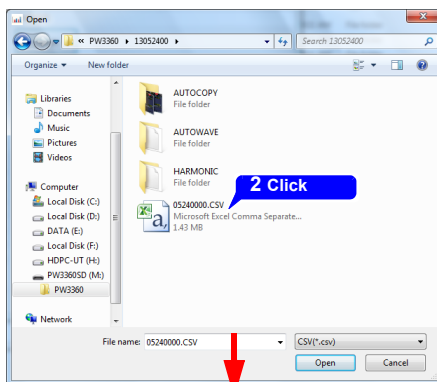
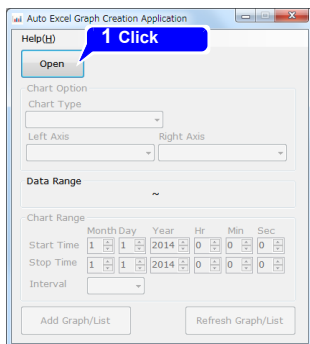

Launch Excel® and automatically create a graph.

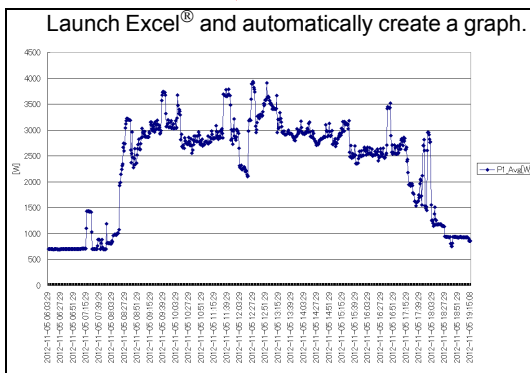

### Installing the software

**1** Download the PW3360/PW3365 Excel automatic graphing software from the Hioki website.

**2** Install the software on your computer.

For more information about how to install and use the software, see [\[MANU-AL.pdf\]](#), which is included in the archive file.



# Using Communications (LAN) Chapter 10

When connected via a LAN, the instrument can be operated remotely from an Internet browser. (p.176)

## 10.1 Preparing for LAN Communications

To use LAN communications, you must perform the following tasks:

- Configure the Instrument's LAN Settings (p.171)
- Create a network (p.172)
- Connect the instrument and a computer with a LAN cable (p.173)

The instrument provides functionality for automatically detecting whether a straight or cross cable is being used.

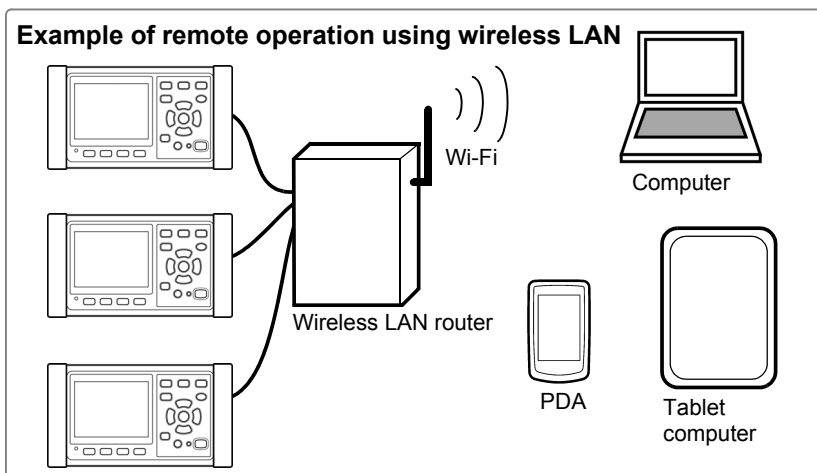
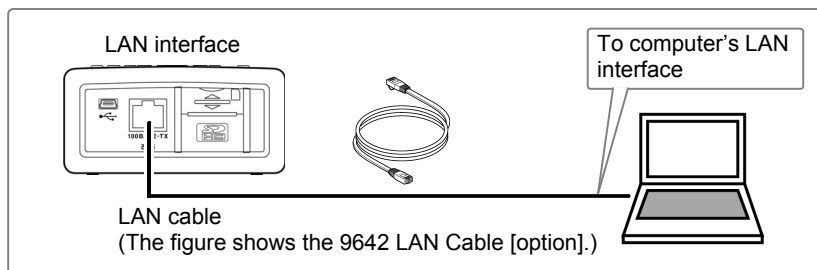

### **Reference When using a wireless LAN router**

The instrument does not support network environments where an IP address is automatically acquired using DHCP (Dynamic Host Configuration Protocol). Configure the router to assign a fixed IP address to the PW3365. For more information about router settings, see the instruction manual for your wireless LAN router.

## Configure the Instruments LAN Settings

- Reference**
- Make these settings before connecting to a network. Changing settings while connected can duplicate IP addresses of other network devices, and incorrect address information may otherwise be presented to the network.
  - The instrument does not support DHCP (automatic IP address assignment) on a network.

1

Press the  key to display the [SET7/7, LAN] screen.

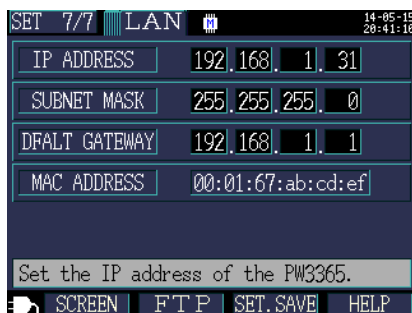

2

Configure the settings as desired.

IP Address	Identifies each device connected on a network. Each network device must be set to a unique address. The instrument supports IP version 4, with IP addresses indicated as four decimal octets, e.g., "192.168.0.1".
Subnet Mask	This setting is used to distinguish the address of the network from the addresses of individual network devices. The normal value for this setting is the four decimal octets "255.255.255.0".
Default Gateway	When the computer and instrument are on different but overlapping networks (subnets), this IP address specifies the device to serve as the gateway between the networks. If the computer and instrument are connected one-to-one, no gateway is used, and the instrument's default setting "0.0.0.0" can be kept as is.

### Reference

The MAC address is a hardware-specific address and cannot be changed.

3

Turn on the instrument.

**IMPORTANT**

After configuring the LAN settings, be sure to cycle the instrument's power. Failure to do so will prevent the settings from taking effect, and you will be unable to use LAN communications functionality.

**Network environment configuration****Example 1. Connecting the instrument to an existing network**

To connect to an existing network, the network system administrator (IT department) has to assign settings beforehand.

Some network device settings must not be duplicated.

Obtain the administrator's assignments for the following items, and write them down.

IP Address _____ Subnet Mask _____ Default Gateway _____
--

**Example 2. Connecting multiple instruments to a single computer using a hub**

When building a local network with no outside connection, the following private IP addresses are recommended.

Configure the network using addresses 192.168.1.0 to 192.168.1.24

IP Address : Computer : 192.168.1.1  
 : PW3365 : assign to each instrument in order 192.168.1.2,  
 192.168.1.3, 192.168.1.4, ...

Subnet Mask : 255.255.255.0

Default Gateway: Computer : \_\_\_\_\_  
 : PW3365 : 0.0.0.0

**Example 3. Connecting one instrument to a single computer using the 9642 LAN Cable**

The 9642 LAN Cable can be used with its supplied connection adapter to connect one instrument to one computer, in which case the IP address is freely settable. Use the recommended private IP addresses.

IP Address : Computer : 192.168.1.1  
 : PW3365 : 192.168.1.2 (Set to a different IP address than the  
 computer.)

Subnet Mask : 255.255.255.0

Default Gateway: Computer : \_\_\_\_\_  
 : PW3365 : 0.0.0.0

## Connecting the Instrument and Computer with a LAN Cable

### ⚠ CAUTION



- When connecting the instrument to your LAN using a LAN cable of more than 30 m or with a cable laid outdoors, take appropriate countermeasures that include installing a surge protector for LANs. Such signal wiring is susceptible to induced lighting, which can cause damage to the instrument.
- To avoid damaging the LAN cable, grasp the connector, not the cable, when unplugging the cable.

Connect the instrument and computer with a LAN cable.  
The Ethernet interface jack is on the right side.

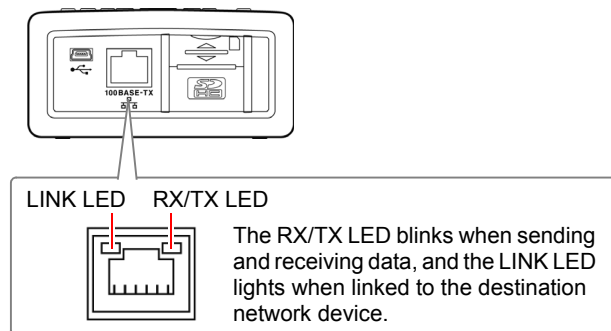

**When connecting the instrument to an existing network (when connecting the instrument to a hub)**

Preparation items (provide either of the following)

A 100Base-TX straight cable (up to 100 m in length, commercially available)  
If using a 10Base network, a 10Base-T cable can be used.



**1** Connect the LAN cable to the instrument's LAN interface.

**2** Connect the LAN cable to the hub's 100Base-TX connector.

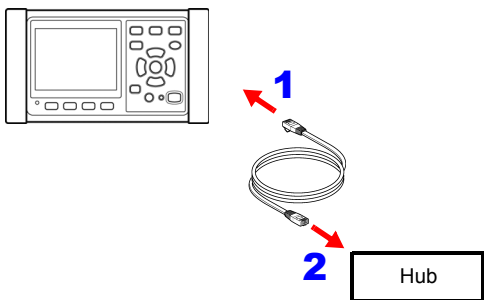

**When connecting the instrument directly to a computer  
(when connecting the instrument to a computer)**

**Preparation items (provide either of the following)**

A 100Base-TX straight or cross  
cable (up to 100 m in length)



Model 9642 LAN Cable (optional)

**1** Connect the LAN cable to the instrument's LAN interface.

**2** Connect the LAN cable to the computer's 100Base-TX connector.

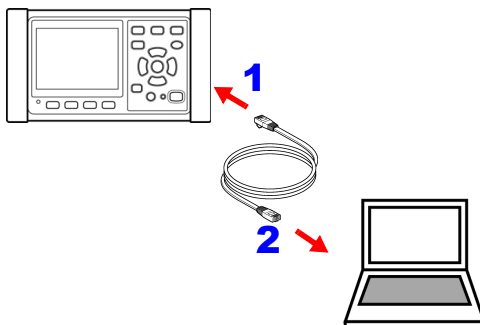

**Reference** Since the instrument provides functionality for automatically detecting whether a straight or cross cable is being used, a straight cable may also be used. If you are unable to establish communications with the computer, try a cross conversion cable (Model 9642 accessory).

## 10.2 Remote Control of the Instrument by Internet Browser

The instrument includes a standard HTTP server function that supports remote control by an internet browser on a computer.

The instrument's display screen and control panel keys are emulated in the browser. Operating procedures are the same as on the instrument.

- Reference**
- It is recommended to use either Microsoft Internet Explorer version 8 or later.
  - Set the browser security level to “Medium” or “Medium-high,” or enable Active Scripting settings.
  - Unintended operations may occur if remote control is attempted from multiple computers simultaneously. Use one computer at a time for remote control.
  - Remote control can be performed even if the instrument's key lock is active.

### Preparing for Remote Operation

#### 1 Launch Internet Explorer.

#### 2 In the address bar, enter “http://” followed by the IP address with which you configured the instrument.

For example, enter the address as shown below if the instrument's IP address is **[192.168.1.31]**:

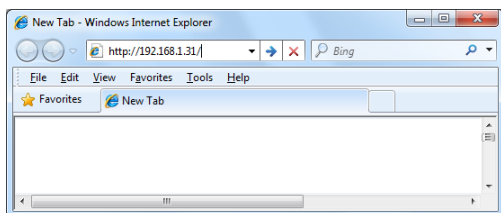



- 3** If the main page is displayed as shown below, you have successfully connected to the instrument:

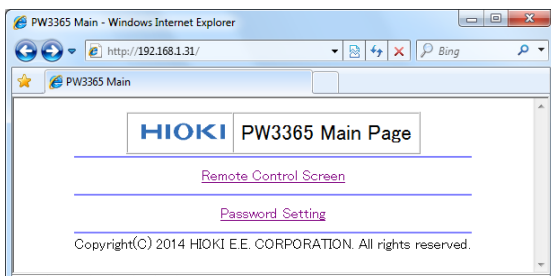

### If the HTTP screen is not displayed

- Check Internet Explorer's settings.

- 1** On the Internet Explorer settings, click **[Tools]-[Internet Options]**.

- 2** On the **[Advanced]** tab, enable **[Use HTTP1.1]** and disable **[Use HTTP1.1 through proxy connections]**.

- 3** Under **[LAN settings]** on the **[Connections]** tab, disable the **[Proxy server]** setting.

- Check the LAN settings.

- 1** Check the instrument's LAN settings and the computer's IP address.  
**See:** "Configure the Instruments LAN Settings" (p.171)

- 2** Verify that the LINK LED on the LAN interface is on and that the Web mark is being shown on the instrument's screen.  
**See:** "Connecting the Instrument and Computer with a LAN Cable" (p.173)

### IMPORTANT

After configuring the LAN settings, be sure to cycle the instrument's power. Failure to do so will prevent the settings from taking effect, and you will be unable to use LAN communications functionality.

## Operating the Instrument Remotely

- 1 Click **[Remote Control Screen]**.  
The remote operation page will be displayed.

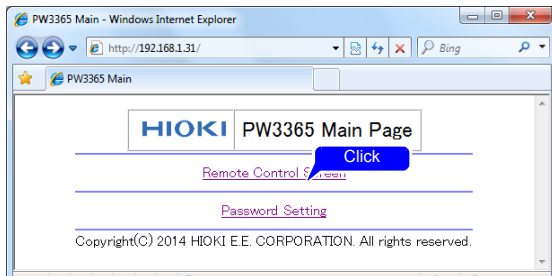

- 2 If a password has been set, the following page will be displayed.

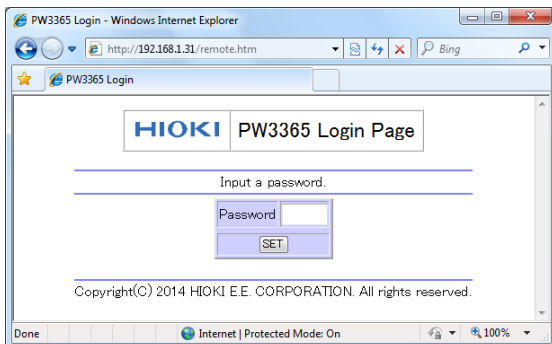

**Enter the password and click the [SET] button.**

The screen and control panel being displayed on the instrument will be shown in the browser.

(If no password has been set, or if the password has been set to "0000" (the digit zero), this page will not be displayed. The default password is "0000".)

## Setting a Password

You can restrict remote operation by setting a password.

### 1 Click **[Password Setting]** on the main page.

The following page will be displayed.



### 2 Enter the **[Old Password]**, **[New Password]**, and **[Confirm New Password]** fields and click the **[SET]** button.

Enter up to four English letters. If setting a password for the first time, enter “0000” (four zeroes) as the **[Old Password]**. If changing a previously set password, enter the previously set password.

The new password will become effective immediately.

## If You Forget Your Password

Triggering a factory reset (p.92) on the instrument will cause the password to be reset to its default value of “0000.” The password cannot be initialized by means of remote operation.

## 10.3 Downloading Recorded Data to Computer

Because the instrument is running an FTP (File Transfer Protocol)\* server, using the FTP client function of the computer allows files from the SD memory card or internal memory to be downloaded to the computer.

\*: A protocol to transfer files within the network.

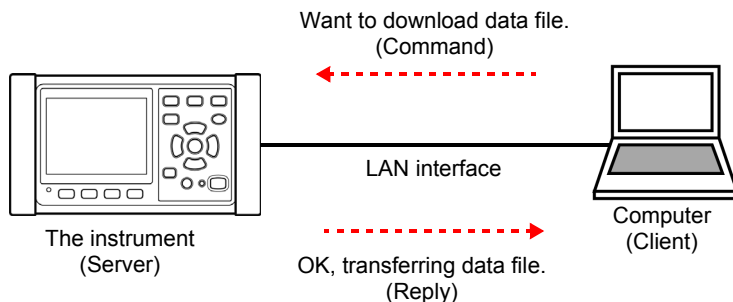

### Setup

To download file with the FTP server function, basic LAN communication needs to be configured in advance

**See:** "10.1 Preparing for LAN Communications" (p.169)

To restrict the connection, use the following procedure for configuration.

- 1 Press the **SET** key to display the **[SET 7/7, LAN]**, Interface settings screen.

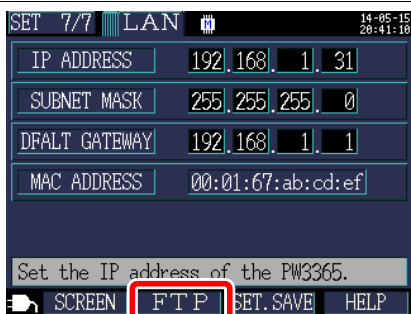

- 2 Press the **F2** [**FTP**] key.

**3 Enable the authorization setting for the FTP server.**

Enable the **[AUTHENTICATION]** and set a **[USER NAME]** and **[PASSWORD]**.

The FTP server of this instrument is set to anonymous authentication, thereby allowing all devices on the network to access to the instrument when **[AUTHENTICATION]** is set to disable.

**To complete the settings:**

Press the **F1** **[OK]** key.

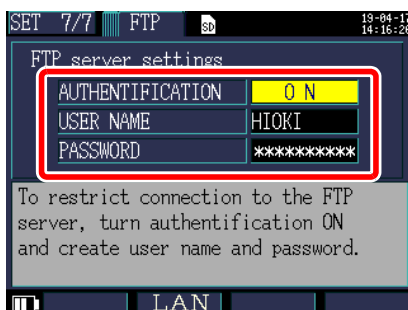
**AUTHENTICATION**

Enable when trying to restrict connection to the FTP server.

Selection

ON/OFF

**USER NAME**

Configure a user name used when connecting an FTP client to the instrument. (Up to 20 one-byte characters, example: HIOKI)

**PASSWORD**

Configure a password used when connecting an FTP client to the instrument. The password does not appear on the screen (displayed as \*\*\*\*\*). (Up to 20 one-byte characters, example: PW3365)

## Download

### 1 Run an FTP client software.

This section explains an example of using a free software WinSCP. Explorer can be used when the FTP authorization is not used.

### 2 Enter the following and click [Login].

<b>Host name</b>	IP address of the instrument (p.171)
<b>User name</b>	When FTP authentication is enabled (p.181) , enter the
<b>Password</b>	Password Password setting of the instrument.

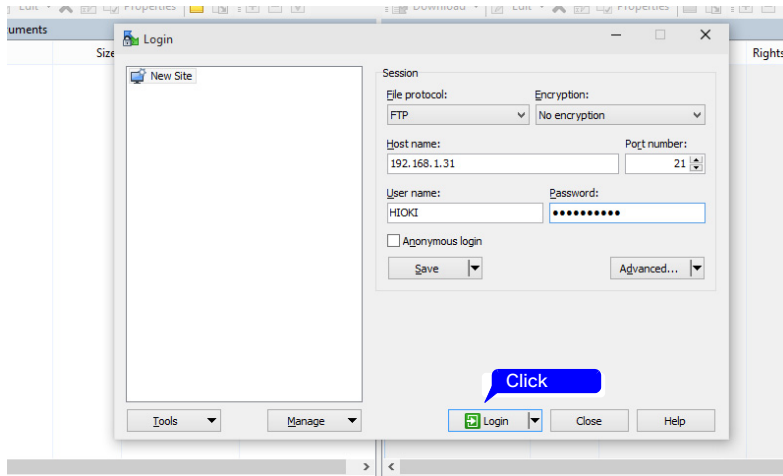

### 3 Click [SD] or [MEM].

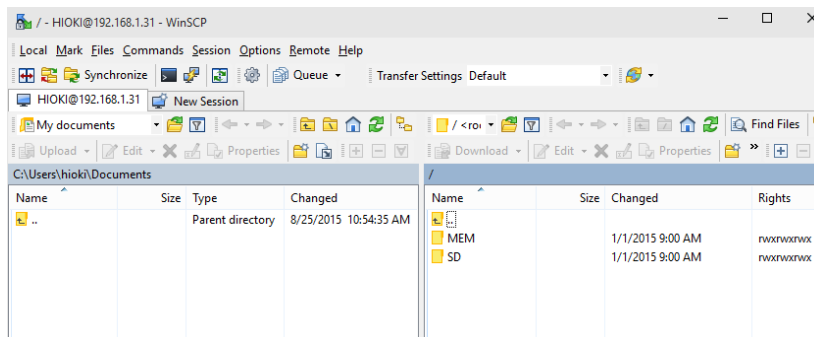

<b>MEM</b>	Internal memory
<b>SD</b>	SD memory card

### 4 Copy to any folder by selecting a folder or file.

- To copy measured data, copy the “Folders for measured data”.  
**See:** "8.2 Folder and File Structure" (p.134)
- Do not move any folder or file. It is recommended to delete the folder and file after the data is copied and checked.

- Unintended operations may occur if operation is attempted from multiple computers simultaneously. Use one computer at a time when operating.
- The instrument may lose connection if no operation is done for 3 minutes or more after making connections. In such case, start over from procedure 1.
- FTP may not connect when trying to reconnect after being disconnected. In such case, try reconnecting after waiting for about one minute.
- The file being recorded cannot be downloaded during recording. When wanting to download file while continuing to record, have **[REC START]** configured to **[REPEAT]** (p.124).  
This setting repeats the start and stop of the recording every day, allowing the measured data up to the previous day to be downloaded through segmentation of measured data folders.
- Disconnect when changing the SD memory card.
- Avoid accessing any files at the same time as when downloading from within the instrument or externally using such tools as telnet and GENNECT Cross. Doing so may cause unintended results.
- Date/time of file update between the Internet browser and the instrument may not be identical.

## 10.3 Downloading Recorded Data to Computer

- Previous data excluding the latest one may end up getting downloaded to the computer (as data left from the previous access gets saved as temporary Internet files in web browsers).

### **When wanting to perform remote control:**

**See:** "10.2 Remote Control of the Instrument by Internet Browser" (p.176)

---



# Specifications Chapter 11

## 11.1 General Specifications

Operating environment	Indoors, Pollution degree 2, altitude up to 2,000 m (6562-ft.)
Operating temperature and humidity	0°C to 50°C (32°F to 122°F), 80% RH or less (non-condensation) When operating on battery power, 0°C to 40°C (32°F to 104°F), when charging the battery, 10°C to 40°C (50°F to 104°F)
Storage temperature and humidity	-10°C to 60°C (14°F to 140°F), 80% RH or less (non-condensation) However, the battery's storage temperature range is -10°C to 30°C (14°F to 86°F).
Power supply	<ul style="list-style-type: none"> <li>Z1008 AC Adapter (12 V 1.25 A) Rated supply voltage 100 V AC to 240 V AC (Voltage fluctuations of ±10% from the rated supply voltage are taken into account.) Rated power supply frequency 50 Hz/60 Hz Anticipated transient overvoltage 2500 V</li> <li>Model 9459 Battery Pack (Ni-MH 7.2 V DC 2700 mAh)</li> </ul>
Charge function	Charges the battery regardless of whether the instrument is on or off. Charge time: Max. 6 hr. 10 min. (Reference value at 23°C)
Maximum rated power	<ul style="list-style-type: none"> <li>When the Z1008 AC Adapter is used: 45 VA (including AC adapter), 15 VA (PW3365 instrument only)</li> <li>When the 9459 Battery Pack is used: 4 VA</li> </ul>
Continuous operation time (when using the 9459)	Approx. 5 hr. (Continuous use, backlight off, when using four PW9020 Safety Voltage Sensor)
Backup battery life	Clock and settings (Lithium battery), Approx. 10 years at 23°C
Dimensions	Without PW9002: Approx. 180 mm W × 100 mm H × 48 mm D (Approx. 7.09" W × 3.94" H × 1.89" D) (excluding protrusions) With PW9002: Approx. 180 mm W × 100 mm H × 67.2 mm D (Approx. 7.09" W × 3.94" H × 2.65" D) (excluding protrusions)
Mass	Without PW9002: Approx. 540 g (19.0 oz.) With PW9002: Approx. 820 g (28.9 oz.)
Product warranty period	3 years
Applicable standards	Safety EN61010 EMC EN61326 Class A
Accessories	<b>See:</b> "Accessories" (p.2)
Options	<b>See:</b> "Options" (p.3)

**11.2 Basic Specifications****Input specifications**

Number of channels	Voltage: 3 channels, Current: 3 channels
Measurement target	Single-phase 2-wire (1P2W, 1P2W × 2 circuits, 1P2W × 3 circuits) Single-phase 3-wire (1P3W, 1P3W1U) Three-phase 3-wire (3P3W2M, 3P3W3M [Y wiring only]) Three-phase 4-wire (3P4W) Current only
Measurement target frequency	50 Hz/60 Hz
Input methods	Voltage: Insulated Model PW9020 Safety Voltage Sensor Current: Insulated clamp sensors
Maximum rated voltage between terminals	Voltage input section: 1.7 V AC, 2.4 V peak Current input section: 1.7 V AC, 2.4 V peak
Maximum rated voltage to earth	Voltage input section: Depends on Model PW9020 (See "PW9020 Safety Voltage Sensor" (p.218)"Maximum rated voltage to earth") Current input section: Depends on clamp sensor in use.

**Measurement specifications**

Measurement method	Digital sampling, zero-cross synchronized calculation method
Sampling	10.24 kHz (50 Hz: 10 cycles; 60 Hz: 12 cycles; 2,048 points) Simultaneous sampling of voltage and current; inter-channel multiplexing at 61.44 kHz Third channel during 3P3W2M measurement is calculated using vector computation.
Calculation processing	50 Hz: Continuous, gapless measurement at 10 cycles 60 Hz: Continuous, gapless measurement at 12 cycles
A/D converter resolution	16 bit

## Measurement specifications

Display range	Voltage	: 5 V to 520 V In case of an over-range event, [over] is displayed as the measured value. Zero-display processing forces voltage RMS values of less than 5 V to be displayed as the value zero. If the voltage RMS value is 0 V, a harmonic voltage of 0 is used for all orders.
	Current	: 0.4% to 130% of range In case of an over-range event, [over] is displayed as the measured value. Zero-display processing forces current RMS values of less than 0.4% to be displayed as the value zero. If the current RMS value is 0 A, a harmonic current of 0 is used for all orders.
	Power	: 0% to 130% of range In case of an over-range event, [over] is displayed as the measured value. If the voltage RMS value or current RMS value is 0, the power value is displayed as the value zero.
Effective measuring range	Voltage	: 90 V to 520 V; peak: $\pm 750$ V In case of a peak-exceeded event, the [Uov] icon is displayed.
	Current	: 5% to 110% of range; peak: $\pm 400\%$ of range However, maximum range is 200%.
	Power	: 5% to 130% of range In case of a peak-exceeded event, the [lov] icon is displayed.
	Frequency	: 45 Hz to 66 Hz
Measurement items	Voltage RMS, current RMS, voltage fundamental wave value, current fundamental wave value, voltage fundamental wave phase angle, current fundamental wave phase angle, frequency (U1), voltage waveform peak (absolute value), current waveform peak (absolute value), active power, reactive power, apparent power, power factor (with lag/lead display) or displacement power factor (with lag/lead display), active energy (consumption, regeneration), reactive energy (lag, lead), energy cost display, active power demand quantity (consumption, regeneration), reactive power demand quantity (lag, lead), active power demand value (consumption, regeneration), reactive power demand value (lag, lead), power factor demand, harmonic voltage, harmonic current, voltage total harmonic distortion (THD-F or THD-R), current total harmonic distortion (THD-F or THD-R)	

## 11.2 Basic Specifications

### Display range, effective measurement range, effective peak range chart (representative example: Model 9661 Clamp on Sensor)

Item	Range	Display range	Effective measurement range		Display range	Effective peak
		Lower limit	Lower limit	Upper limit	Upper limit	Range
Voltage	400 V single range	5.0 V	90.0 V	520.0 V	520.0 V	±750 V peak
Current (Model 9661)	5 A range	0.0200 A	0.2500 A	5.5000 A	6.5000 A	±20 A peak
	10 A range	0.040 A	0.500 A	11.000 A	13.000 A	±40 A peak
	50 A range	0.200 A	2.500 A	55.000 A	65.000 A	±200 A peak
	100 A range	0.40 A	5.00 A	110.00 A	130.00 A	±400 A peak
	500 A range	2.00 A	25.00 A	550.00 A	650.00 A	±1000 A peak

### Display specifications

Display update rate	Approx. 0.5 s (excluding during SD memory card or internal memory access and LAN and USB communications) However, approx. 1.0 s for energy-related data.
Display	320 x 240 dots, 3.5" TFT color LCD
Language	Japanese/ English/ Chinese (simple)/ German/ Italian/ French/ Spanish/ Turkish/ Korean
Backlight	LED backlight AUTO OFF (2 minutes)/ON The POWER LED flashes during auto-off operation.

**Conditions of guaranteed accuracy**

Conditions of guaranteed accuracy	Warm-up time of at least 30 minutes, sine wave input, frequency 50 Hz/60 Hz, conductor-to-ground voltage of 400 V or less
Temperature and humidity for guaranteed accuracy	23°C ± 5°C (73°F ± 9°F), 80% RH or less (applies to all specifications unless otherwise noted)
Display range of guaranteed accuracy	Effective measuring range
Guaranteed accuracy period	1 year

**Other conditions**

Clock function	Auto-calendar, leap-year correcting, 24-hour clock
Real-time clock accuracy	Within ±0.3 s per a day (power on, within operating temperature and humidity range)
Temperature characteristic	Within ±0.1% f.s./°C (other than at 23°C ± 5°C)
Effect of external magnetic field interference	Within ±1.5% f.s. (in a magnetic field of 400 A/m AC, 50 Hz/60 Hz)
Effects of a radiated, radio-frequency, electromagnetic field	Voltage and active power within ±5% f.s. at 10 V/m

**11.3 Detailed Measurement Specifications****Measurement items****Voltage RMS (U)**

Measurement method	True RMS type
Measurement range	400 V single range
Measurement accuracy	45 Hz to 66 Hz: The combined accuracy of the PW3365 and the PW9020 $\pm 1.5\%$ rdg. $\pm 0.2\%$ f.s. (For the PW3365 alone, $\pm 0.3\%$ rdg. $\pm 0.1\%$ f.s.) When using 3P3W3M wiring only, add $\pm 0.5\%$ rdg.

**Current RMS (I)**

Measurement method	True RMS type
Measurement range	Load current Model 9660, Model 9695-03 (1 mV/A): 5.0000/10.000/50.000/100.00 A Model 9661 (1 mV/A): 5.0000/10.000/50.000/100.00/500.00 A Model 9669 (0.5 mV/A): 100.00/200.00/1.0000k A Model 9694 (10 mV/A): 500.00m/1.0000/5.0000/10.000/50.000 A Model 9695-02 (10 mV/A): 500.00m/1.0000/5.0000/10.000/50.000 A Model CT9667 500 A range (1 mV/A): 50.000/100.00/500.00 A Model CT9667 5000 A range (0.1 mV/A): 500.00/1.0000k/5.0000k A  Leakage current Model 9657-10, Model 9675 (100 mV/A): 50.000m/100.00m/500.00m/ 1.0000/5.0000 A
Range control	Manual range
Measurement accuracy	45 Hz to 66 Hz: $\pm 0.3\%$ rdg. $\pm 0.1\%$ f.s. + clamp sensor specifications With a fundamental frequency of 50 Hz/60 Hz, up to 1 kHz: $\pm 3\%$ rdg. $\pm 0.2\%$ f.s. + clamp sensor specifications

**Frequency (f)**

Measurement method	Reciprocal method
Measurement range	40.00 Hz to 70.00 Hz
Measurement channel	Voltage U1
Measurement accuracy	$\pm 0.5\%$ rdg. For sine wave input from 90 V to 520 V

**Voltage waveform peak (Upeak), Current waveform peak (Ipeak)**

Measurement method	Peak value (absolute value) for each calculation interval (10 cycles at 50 Hz or 12 cycles at 60 Hz)
Measurement accuracy	Accuracy not defined.

**Active power (P)**

Measurement method	Calculated using voltage and current waveform sampling data. <b>See:</b> Calculation Formulas:"Active power" (p.206)
Measurement range	Combination of voltage × current range <b>See:</b> "11.6 Range Configuration and Accuracy by Clamp Sensor" (p.215)
Measurement accuracy	45 Hz to 66 Hz: The combined accuracy of the PW3365, PW9020, and clamp sensors ±2.0% rdg. ±0.3% f.s. + clamp sensor specifications.(power factor=1) [For the PW3365 alone, ±0.6% rdg. ±0.2% f.s.(power factor=1)]
Phase effects	The combined phase accuracy of the PW3365 and PW9020 is equivalent to ±1.3°. (The phase accuracy for the PW3365 alone is equivalent to ±0.3°.) (In both cases, 50 Hz/60 Hz and f.s. input are assumed.)
Polarity indication	Consumption: Unsigned Regeneration: Negative

**Reactive power (Q, PF/Q/S calculation selection: RMS calculations)**

Measurement method	Calculated from apparent power and active power. <b>See:</b> Calculation Formulas:"Reactive power" (p.207)
Measurement range	Combination of voltage range × current range <b>See:</b> "11.6 Range Configuration and Accuracy by Clamp Sensor" (p.215)
Measurement accuracy	±1 dgt. relative to calculations from measured values
Lag/Lead display	Uses the sign of reactive power Q (fundamental wave reactive power). Positive : Lag Negative : Lead
Output data	For SD memory card and internal memory output data, the polarity indicates lag/lead. Lag : Positive Lead : Negative

### 11.3 Detailed Measurement Specifications

#### Reactive power (Q, PF/Q/S calculation selection: fundamental calculations)

This reactive power Q is defined as the fundamental wave reactive power.

Measurement method	Calculated from fundamental wave voltage and current. <b>See:</b> Calculation formulas:"Reactive power" (p.207)
Measurement range	Combination of voltage range × current range <b>See:</b> "11.6 Range Configuration and Accuracy by Clamp Sensor" (p.215)
Measurement accuracy	With a fundamental wave frequency of 45 Hz to 66 Hz: The combined accuracy of the PW3365, PW9020, and clamp sensors 2.0% rdg. 0.3% f.s. + clamp sensor specifications. (reactive factor=1) [For the PW3365 alone ±0.6% rdg.±0.2% f.s. (reactive factor=1)]
Phase effects	The combined phase accuracy of the PW3365 and PW9020 is equivalent to ±1.3°. (The phase accuracy for the PW3365 alone is equivalent to ±0.3°.) (In both cases, 50 Hz/60 Hz and f.s. input are assumed.)
Lag/Lead display	Positive : Lag Negative : Lead
Output data	For SD memory card and internal memory output data, the polarity indicates lag/lead. Lag : Positive Lead : Negative

#### Apparent power (S, PF/Q/S calculation selection: RMS calculations)

Measurement method	Calculated from the voltage RMS and current RMS values. <b>See:</b> Calculation formulas:"Apparent power" (p.208)
Measurement range	Combination of voltage × current range <b>See:</b> "11.6 Range Configuration and Accuracy by Clamp Sensor" (p.215)
Measurement accuracy	±1 dgt. relative to calculations from measured values.

#### Apparent power (S, PF/Q/S calculation selection: fundamental calculations)

This apparent power S is defined as the fundamental wave apparent power.

Measurement method	Calculated from the fundamental wave active power and the fundamental wave reactive power. <b>See:</b> Calculation formulas:"Apparent power" (p.208)
Measurement range	Combination of voltage × current range <b>See:</b> "11.6 Range Configuration and Accuracy by Clamp Sensor" (p.215)
Measurement accuracy	±1 dgt. relative to calculations from measured values.



### 11.3 Detailed Measurement Specifications

#### Power factor (PF, PF/Q/S calculation selection: RMS calculations)

Measurement method	Calculated from the apparent power and active power. <b>See:</b> Calculation formulas:"Power factor, Displacement power factor" (p.209)
Measurement range	Lag: 0.000 to 1.000 Lead: 0.000 to 1.000
Measurement accuracy	±1 dgt. relative to calculations from measured values.
Lag/Lead display	Uses the sign of reactive power Q (fundamental wave reactive power). Positive : Lag Negative : Lead
Output data	For SD memory card and internal memory output data, the polarity indicates lag/lead. Lag : Positive Lead : Negative

#### Power factor (PF, PF/Q/S calculation selection: fundamental calculations)

This power factor PF is defined as the displacement power factor DPF.

Measurement method	Calculated from the fundamental wave active power and the fundamental wave reactive power. <b>See:</b> Calculation formulas:"Power factor, Displacement power factor" (p.209)
Measurement range	LAG: 0.000 to 1.000 LEAD: 0.000 to 1.000
Measurement accuracy	±1 dgt. relative to calculations from measured values.
Lag/Lead display	Uses the sign of reactive power Q (fundamental wave reactive power). Positive : Lag Negative : Lead
Output data	For SD memory card and internal memory output data, the polarity indicates lag/lead. Lag : Positive Lead : Negative

### 11.3 Detailed Measurement Specifications

#### Active energy (WP), Reactive energy (WQ)

Measurement method	Active power values are integrated separately for consumption and regeneration from the start of recording. Reactive power values are integrated separately for lag and lead from the start of recording. <b>See:</b> Calculation formulas:"Electric energy, Energy cost" (p.211)
Measurement range	<ul style="list-style-type: none"> <li>Active energy           <ul style="list-style-type: none"> <li>Consumption WP+ : 0.00000 mWh to 99999.9 GWh</li> <li>Regeneration WP- : -0.00000 mWh to -99999.9 GWh</li> </ul> </li> <li>Reactive energy           <ul style="list-style-type: none"> <li>Lag WQ_LAG : 0.00000 mvarh to 99999.9 Gvarh</li> <li>Lead WQ_LEAD : -0.00000 mvarh to -99999.9 Gvarh</li> </ul> </li> </ul>
Measurement accuracy	Active power and reactive power measurement accuracy $\pm 1$ dgt.
Integration time accuracy	$\pm 10$ ppm $\pm 1$ sec.

#### Energy cost (E\_cost)

Measurement method	The active energy (consumption) WP+ is multiplied by the unit cost (per kWh). <b>See:</b> Calculation formulas:"Electric energy, Energy cost" (p.211)
Measurement accuracy	$\pm 1$ dgt. relative to calculations from measured values.

#### Active power demand quantity (WPdem), Reactive power demand quantity (WQdem) (Data is output during recording but is not displayed by the instrument.)

Measurement method	Active power consumption and regeneration obtained during each interval time are integrated separately. Reactive power lag and lead obtained during each interval time are integrated separately. <b>See:</b> Calculation formulas:"Demand quantity (output data only; not displayed)" (p.212)
Measurement items	<ul style="list-style-type: none"> <li>Active power demand quantity           <ul style="list-style-type: none"> <li>Consumption WPdem +</li> <li>Regeneration WPdem -</li> </ul> </li> <li>Reactive power demand quantity           <ul style="list-style-type: none"> <li>Lag WQdem_LAG</li> <li>Lead WQdem_LEAD</li> </ul> </li> </ul>
Measurement accuracy	Active power and reactive power measurement accuracy $\pm 1$ dgt.
Integration time accuracy	$\pm 10$ ppm $\pm 1$ sec.

**Active power demand Value (Pdem), Reactive power demand quantity (Qdem)**

Measurement method	Separate average values are calculated for active power consumption and regeneration during the interval time. Separate average values are calculated for reactive power lag and lead during the interval time. <b>See:</b> Calculation formulas:"Demand value" (p.213)
Measurement items	<ul style="list-style-type: none"> <li>• Active power demand value Consumption Pdem + Regeneration Pdem -</li> <li>• Reactive power demand value Lag Qdem_LAG Lead Qdem_LEAD</li> </ul>
Measurement accuracy	Active power and reactive power measurement accuracy $\pm 1$ dgt.

**Power factor demand value (PFdem)**

Measurement method	Calculated from the active power demand value Pdem and the reactive power demand value Qdem. <b>See:</b> Calculation formulas:"Demand value" (p.213)
Measurement accuracy	$\pm 1$ dgt. relative to calculations from measured values.

**Harmonics**

Standard	Complies with IEC 61000-4-7:2002, except without intermediate harmonics.
Window width	50 Hz: 10 cycles (with interpolation) 60 Hz: 12 cycles (with interpolation)
Number of orders analyzed	Up to 13th
Analysis parameters	<p>Harmonics level: Harmonic level for each order for voltage, current When using 3P3W2M wiring, the U12 and I12 values calculated for the third channel are not displayed.</p> <p>Harmonics content percentage: Harmonic content percentage for each order for voltage, current <b>See:</b> "Harmonic voltage, and current" (p.213) Total harmonic distortion: voltage and current (THD-F or THD-R) <b>See:</b> "Total harmonic distortion" (p.214)</p>
Measurement range	Level: Same as the effective measuring range Content percentage, total harmonic distortion: 0.00% to 500.00%

## 11.3 Detailed Measurement Specifications

### Harmonics

---

Measure- ment accu- racy	<ul style="list-style-type: none"><li>• Harmonics level</li></ul>
	<ul style="list-style-type: none"><li>• Voltage PW3365 alone: <math>\pm 5\%</math> rdg. <math>\pm 0.2\%</math> f.s. The combined accuracy of the PW3365 and PW9020: <math>\pm 30\%</math> rdg. <math>\pm 3\%</math> f.s. Input of each order is limited to 5% of the fundamental wave; however, THD-F is limited to 10%.</li><li>• Current Add the sensor accuracy to <math>\pm 5\%</math> rdg. <math>\pm 0.2\%</math> f.s.</li></ul>
	<ul style="list-style-type: none"><li>• Total harmonic distortion rate No accuracy defined.</li></ul>

---

## 11.4 Functional Specifications

### Screen display

Measurement	<p>List (voltage, current, frequency, active/apparent/reactive power, power factor, integral energy, elapsed time)</p> <p>Voltage and current details (RMS value, fundamental wave value, waveform peak, phase angle)</p> <p>Power (active/reactive/apparent power and power factor by channel and as total)</p> <p>Energy (active energy, reactive energy, start time, planned stop time, elapsed time, energy cost)</p> <p>Demand (active power demand value, reactive power demand value, power factor demand value)</p> <p>Waveforms (display of all channels by voltage and current with user-selectable zoom factor)</p> <p>Enlarged views (selection of four parameters for enlarged views)</p> <p>Trend (Selection of one measurement parameter for a time-series display of maximum, minimum, and average values)</p> <p>Harmonics (voltage and current levels, content percentage graph, and list)</p>
Wiring	Wiring diagram, Wiring check (wiring confirmation)
Setting	Various settings
File	SD memory card and internal memory operations
Quick Set	Provides information about procedures associated with measurement settings, wiring types, wiring check (wiring confirmation), recording settings, and recording initiation.

## 11.4 Functional Specifications

### Measurement screen

List	<p>Voltage RMS value U, current RMS value I, frequency f, total active power P, total reactive power Q and apparent power S, power factor PF or displacement power factor DPF, active energy (consumption) WP+, elapsed time TIME</p> <p>When using 1P2W wiring, the instrument can be switched between two and three circuits.</p>
U/I	<p>Voltage RMS value U, voltage fundamental wave value U<sub>fund</sub>, voltage waveform peak U<sub>peak</sub>, voltage fundamental wave phase angle U<sub>deg</sub>, current RMS value I, current fundamental wave value I<sub>fund</sub>, current waveform peak I<sub>peak</sub>, current fundamental wave phase angle I<sub>deg</sub></p> <p>When using 3P3W3M wiring, the line-to-line voltage RMS value is displayed as U, and the conductor-to-ground voltage (phase voltage) fundamental wave value, waveform peak, and fundamental wave phase angle are displayed as U<sub>fund</sub>, U<sub>peak</sub>, and U<sub>deg</sub>.</p>
Power	<p>Per-channel and total active power P, apparent power S, reactive power Q, power factor PF or displacement power factor DPF</p>
Integ.	<p>Active energy (consumption WP+, regeneration WP-), reactive energy (lag WQ+, lead WQ-), recording start time, recording stop time, elapsed time, energy cost</p> <p>When using 1P2W wiring, the instrument can be switched between two and three circuits.</p>
Demand	<p>Can be switched to active power demand value (consumption P<sub>demand+</sub>, regeneration P<sub>demand-</sub>), reactive power demand value (lag Q<sub>demandLAG</sub>, lead Q<sub>demandLEAD</sub>), or power factor demand value (PF<sub>demand</sub>).</p> <p>When the active demand value (consumption P<sub>demand+</sub>) is selected, the maximum active demand value MAX_DEM since the start of recording and the time and date at which it occurred is displayed (but not saved).</p>
Harmonic	<p>Graph (voltage and current levels, content percentage) List (voltage and current levels, content percentage)</p>
Waveform	<p>Displays voltage and current waveforms, voltage and current RMS values, and frequency. The vertical axis zoom factor can be set.</p> <p>When using 3P3W3M wiring, the conductor-to-ground (phase voltage) waveform is displayed.</p>
Zoom	<p>Enlarged view of 4 user-selected parameters</p>
Trend	<p>Select and display one measurement parameter, except demand and harmonic (other than THD) parameters.</p> <p>Displays maximum, average, and minimum values and allows cursor measurement.</p>

## Maximum/minimum/average value processing methods

Measurement parameter		Average value	Maximum value	Minimum value
		Blank: Arithmetic mean	Blank: Simple max. value	Blank: Simple min. value
Voltage RMS value	U			
Current RMS value	I			
Frequency	f			
Voltage waveform peak	U <sub>peak</sub>	No average value		
Current waveform peak	I <sub>peak</sub>			
Active power	P		Simple maximum and minimum with polarity	
Apparent power	S			
Reactive power	Q	Signed simple average	Lag (positive data polarity)/Lead (negative data polarity); simple maximum and minimum	
Power factor	PF	Calculated from P <sub>avg</sub> and S <sub>avg</sub> .	Maximum and minimum absolute value Signed data based on Lag (positive)/Lead (negative)	
Displacement power factor	DPF	Calculated from P(1) <sub>avg</sub> and S(1) <sub>avg</sub> .	Maximum and minimum absolute value Signed data based on Lag (positive)/Lead (negative)	
Harmonic level				
Harmonic content percentage		Nth harmonic average value / fundamental wave average value × 100%		
Total harmonic distortion rate		Calculated from Nth harmonic average value		

## Wiring diagram screen

Wiring diagram screen	Displays a leak wiring diagram and measured values for single-phase/2-wire (1P2W), single-phase/3-wire (1P3W, 1P3W1U), 3-phase/3-wire (3P3W2M, 3P3W3M), and 3-phase/4-wire (3P4W) connections.
Wiring check screen	Displays measured values (voltage and current RMS values, voltage and current phase angles, active power, and displacement power factor), vector diagrams, and wiring confirmation results.
Settings	Allows the wiring type, clamp sensor, and range to be changed.

## 11.4 Functional Specifications

### Wiring diagram screen

Wiring confirmation (Wiring Check) content	Voltage input, current input, voltage phase, current phase (3-phase only), phase difference, and power factor (CHECK mark displayed if the power factor is 0.5 or less) Displays information about reviewing items for the wiring confirmation result.
--	---

### Setting screen

Wiring	1P2W/1P2W×2/1P2W×3/ 1P3W/1P3W+I/1P3W1U/1P3W1U+I/ 3P3W2M/3P3W2M+I/3P3W3M/3P4W/ Current only (I)/Current only (I×2)/Current only (I×3)
Frequency	50Hz/60Hz If there is voltage input and the frequency setting is wrong, displays an error and changes the frequency setting.
Clamp sensor	Load current: 9660/9661/9669/9694/9695-02/9695-03/ CT9667(500 A)/CT9667(5000 A)/ Leakage current: 9657-10/9675
Current range	Load current 9660, 9695-03 (1 mV/A): 5.0000/10.000/50.000/100.00 A 9661 (1 mV/A): 5.0000/10.000/50.000/100.00/500.00 A 9669 (0.5 mV/A): 100.00/200.00/1.0000 kA 9694 (10 mV/A): 500.00 mA/1.0000/5.0000/10.000/50.000 A 9695-02 (10 mV/A): 500.00m/1.0000/5.0000/10.000/50.000 A CT9667 500A range (1 mV/A): 50.000/100.00/500.00 A CT9667 5000A range (0.1 mV/A): 500.00/1.0000 k/5.0000 kA Leakage current 9657-10,9675 (100 mV/A): 50.000m/100.00m/500.00m/1.0000/5.0000 A
CT ratio	User-specified: 0.01 to 9999.99 Selected: 1/40/60/80/120/160/200/240/300/400/600/800/1200
Voltage range	400 V fixed
VT (PT) ratio	User-specified: 0.01 to 9999.99 Selected: 1/60/100/200/300/600/700/1000/2000/2500/5000)
PF/Q/S calculation selection	RMS calculation / fundamental wave calculation
Energy cost	UnitCost: 0.00000 to 99999.9/kWh CURRENCY: 3 user-specified alphanumeric characters
Remaining save time	Calculated and displayed based on the amount of space remaining on the SD memory card or in the internal memory, the save interval, and the save items. Also updated during time-series measurement.
Save destination	SD memory card / internal memory (capacity: approx. 320 KB)
Save interval time	1/2/5/10/15/30 sec./1/2/5/10/15/20/30/60 min.



## Setting screen

Save items	AVG only (no Harmonic)/ ALL data (no Harmonic) / AVG only (w/Harmonic)/ ALL data (w/Harmonic)
Screen copy	ON/OFF (Saves the displayed screen as a BMP at a fixed interval.) The minimum interval time for saving screen copies is 5 min. If the setting is less than 5 min., screen copies will be saved every 5 min.
Waveform save	ON/OFF (Saves waveform data for each time interval in a binary format.) The shortest time interval for saving waveform data is 1 min. When set to a value less than 1 min., waveform data will be saved every minute.
Folder/ file name	AUTO / MANUAL (5 characters)
Recording start method	INTERVAL / MANUAL / TIME (YYYY-MM-DD hh:mm) / REPEAT During repeat recording, integration is performed for the specified time period only, and the data is saved.
Recording stop method	MANUAL / TIME (YYYY-MM-DD hh:mm)/ TIMER (0000:00:00) The maximum recording and measurement time is up to one year. The timer can be set to any value from 1 sec. to 1,000 hr.
Quick Set at power-on	ON/OFF If ON, confirms whether to launch the Quick Set when the instrument is turned on.
Instrument Information	Displays the serial number and the software and FPGA versions.
Clock	Sets the date and time (using the Western calendar and 24-hour time).
Backlight	AUTO OFF (2 minutes)/ON AUTO OFF automatically turns off the backlight two minutes after the last key operation. After AUTO OFF operation, the backlight turns back on when any key is operated (including when the key lock is engaged).
Screen color	Screen color can be selected (color 1 / color 2 / color 3).
Beep sound	ON/OFF
Language	Japanese/ English/ Chinese/ German/ Italian/ French/ Spanish/ Turkish/ Korean
Phase name	R S T/A B C/L1 L2 L3/U V W
System reset	A system reset causes the instrument settings to be reset to their default values. However, the time, language, frequency, IP address, subnet mask, and default gateway are not reset.
LAN setting	IP address : 3 characters.3 characters.3 characters.3 characters (**.*.*.*.*) Subnet mask : 3 characters.3 characters.3 characters.3 characters (**.*.*.*.*) Default gateway: 3 characters.3 characters.3 characters.3 characters (**.*.*.*.*) MAC address : Written at time of shipment from factory.

## 11.4 Functional Specifications

### Setting screen

FTP server settings	Authentication	: ON/OFF
	User name	: Up to 20 one-byte characters (When FTP Authentication is set to enable)
	Password	: Up to 20 one-byte characters (When FTP Authentication is set to enable)

### File screen

SD memory card	Mass storage, loading settings, deleting folders/files, formatting, upgrades
Internal memory	Copying data from internal memory to the SD memory card, loading settings, deleting files, formatting

### Quick Set screens

Description	Page/item	Quick Set content
Quick Set confirmation		Confirmation of whether to initialize related measurement and recording settings
Basic settings	Wirings	1P2W / 1P3W / 3P3W2M / 3P3W3M / 3P4W* (selection)
	Frequency	No display (The frequency setting is not reset when the Quick Set is started.) Display an error if the frequency is wrong and change the frequency.
	VT ratio	No display (fixed to 1)
	Clamp sensor	9660(100A)/9661(500A)*/9669(1000A)/ 9694(5A)/9695-02(50A)/9695-03(100A)/ CT9667(500A)/CT9667(5000A)
	CT ratio	No display (fixed to 1)
	PF/Q/S calculation selection	No display (RMS calculation)
	THD calculation	No display (THD-F)
	Save destination	SD memory card (disabled) Save to internal memory if no SD memory card has been inserted.
	Clock setting	Clock setting

## Quick Set screens

Description	Page/item	Quick Set content
Wirings	Wirings	Connect the PW9020 sensors and clamp sensors to the instrument.
		The proper way to clamp the PW9020 is shown graphically.
		Make voltage wirings. Check voltage input, phase, and frequency values. If the frequency is wrong, display a window and ask the user whether to change the frequency setting.
		Make current wirings.
		Set the current range.
	Wiring check	Check the current wiring. (Current input, current phase, phase difference CH1/CH2/CH3, phase factor (DPF))
Recording settings	Save interval	1/2/5/10/15/30 sec., 1/2/5*/10/15/20/30/60 min. Display the available save time.
	Save items	<ul style="list-style-type: none"> <li>• AVG only (no Harmonic)* / ALL data (no Harmonic) / AVG only (w/Harmonic) / ALL data (w/Harmonic)</li> <li>• No screen saving (no display)</li> <li>• No waveform saving (no display)</li> </ul>
	Recording start method	INTERVAL* / MANUAL / TIME / REPEAT Repeat setting: Repeat time range fixed from 00:00 to 24:00 (no display) and folder segmentation fixed to off (no display)
	Recording stop method	MANUAL* / TIME / TIMER
	Folder/file name	AUTO* / MANUAL
Recording start	Recording start confirmation	Display the remaining save time and check start of recording.
	Card insertion	Insert an SD memory card (skip information if already inserted).
	Standby	Report standby status.

\* Default value

## 11.4 Functional Specifications

### External interface specifications

SD memory card interface	
Slot	SD standard compliant x 1
Compatible card	SD memory card/ SDHC memory card (Use only HIOKI-approved SD memory card)
Format	SD memory card format
Supported memory capacity	SD memory card: up to 2GB/ SDHC memory card: up to 8 GB
Saved data	Settings data, measurement data, screen data, and waveform data
LAN interface	
Connector	RJ-45 connector x 1
Electrical specifications	IEEE802.3 compliant
Transmission method	10BASE-T/100BASE-TX
Protocol	TCP/IP
Functions	HTTP server function Automatic data acquisition with FTP server (Acquisition of file during saving not available)
Maximum cable length	Up to 100 m
USB interface	
Connector	Mini-B receptacle
Method	USB Ver.2.0 (full speed, high speed) Mass storage class, virtual COM (CDC)
Connection destination	Computer
Supported operating systems	Windows XP/ Windows Vista® (32 bit)/ Windows 7 (32 bit/64 bit)/ Windows 8 (32 bit/64 bit) / Windows 10 (32 bit/64 bit) With latest service packs applied
Functions	When connected to a computer, the SD memory card and internal memory are recognized as removable disks.

**Other functionality**

Display hold	Holds displayed values but not the clock. Measurement continues internally, and readings are applied to maximum, minimum, and average values after the hold is canceled.
Key lock function	Disables all key operation, except the power switch. Turned ON and OFF by pressing and holding the ESC key for at least 3 seconds.
Power supply display	AC adapter/battery
Remaining battery display	Displays the remaining battery life (in four stages).
Warning displays	<ul style="list-style-type: none"> <li>• Over-range: Displays over-range (over). Calculation results are used as-is internally.</li> <li>• Peak over: Displays a warning. ("Uov", or "lov" is displayed)</li> <li>• Frequency error: When the measurement frequency differs from the set frequency (50 Hz/ 60 Hz), displays an error message and changes the frequency setting.</li> </ul>
Self-check function	Checks operation when the instrument is powered on and displays a message.

## 11.5 Calculation Formulas

### Voltage and current RMS values

Wiring setting	Single-phase 2 wire	Single-phase 3 wire		Three-phase 3 wire		Three-phase 4 wire
Item	1P2W	1P3W	1P3W1U	3P3W2M	3P3W3M	3P4W
Voltage $U$ [Vrms]	$U_1$ $Uc = \sqrt{\frac{1}{M} \sum_{s=0}^{M-1} (U_{cs})^2}$	$U_1$ $U_2$	$U_1$	$U_1$ $U_2$ $U_{12}$ $(U_{12s} = U_{1s} - U_{2s})$	$U_1 (U_{1s} = u_{1s} - u_{2s})$ $U_2 (U_{2s} = u_{2s} - u_{3s})$ $U_3 (U_{3s} = u_{3s} - u_{1s})$	$U_1$ $U_2$ $U_3$
<ul style="list-style-type: none"> <li>• For 3P3W2M connections, it is assumed that <math>U_{1s} - U_{2s} - U_{12s} = 0</math>.</li> <li>• For 3P3W3M connections, the conductor-to-ground voltage (phase voltage) <math>u</math> is measured and converted to the line-to-line voltage by means of a calculation.</li> </ul>						
Current $I$ [Arms]	$I_1$ $Ic = \sqrt{\frac{1}{M} \sum_{s=0}^{M-1} (I_{cs})^2}$	$I_1$ $I_2$		$I_1$ $I_2$ $I_{12}$ $(I_{12s} = -I_{1s} - I_{2s})$	$I_1$ $I_2$ $I_3$	$I_1$ $I_2$ $I_3$
<ul style="list-style-type: none"> <li>• For 3P3W2M, it is assumed that <math>I_{1s} + I_{2s} + I_{12s} = 0</math>.</li> </ul>						

\* Subscript c: measurement channel; M: number of sample points; s: sample point number

### Active power

Wiring setting	Single-phase 2 wire	Single-phase 3 wire		Three-phase 3 wire		Three-phase 4 wire
Item	1P2W	1P3W	1P3W1U	3P3W2M	3P3W3M	3P4W
Active power $P$ [W]	$P_1$ $Pc = \frac{1}{M} \sum_{s=0}^{M-1} (U_{cs} \times I_{cs})$	$P_1$ $P_2$	$P_1$ $P_2 = \frac{1}{M} \sum_{s=0}^{M-1} (-U_{1s} \times I_{2s})$	$P_1$ $P_2$		$P_1$ $P_2$ $P_3$
				$P = P_1 + P_2$		$P = P_1 + P_2 + P_3$
<ul style="list-style-type: none"> <li>• The active power <math>P</math> polarity symbols indicate the direction of current flow as either consumption (+<math>P</math>) or regeneration (-<math>P</math>).</li> </ul>						

\* Subscript c: measurement channel; M: number of sample points; s: sample point number

## Reactive power

Wiring setting	Single-phase 2 wire	Single-phase 3 wire		Three-phase 3 wire		Three-phase 4 wire	
Item	1P2W	1P3W	1P3W1U	3P3W2M	3P3W3M	3P4W	
Reactive power $Q$ [var]	$Q_1$	$Q_1$ $Q_2$		$Q_1$ $Q_2$ $Q_3$			
	PF/Q/S (RMS calculation) $Q_c = si \sqrt{S_c^2 - P_c^2}$	$Q = si \sqrt{S^2 - P^2}$					
	<ul style="list-style-type: none"> <li>When <math>S &lt;  P </math> due to the effects of measurement error, unbalance, or other factors, <math>S =  P </math> and <math>Q = 0</math>.</li> <li>The component <math>si</math> indicates lag and lead. The sign of reactive power <math>Q</math> (fundamental wave reactive power) is used. Positive sign: Lag [Display indicates LAG, and output data is positive.] Negative sign: Lead [Display indicates LEAD, and output data is negative.]</li> </ul>						
	$Q_1$	$Q_1$ $Q_2$	$Q_1$ $Q_2$ $= U_{1(1)r} \times I_{2(1)r}$ $U_{1(1)i} \times I_{2(1)r}$	$Q_1$ $Q_2$	$Q_1$ $Q_2$ $Q_3$		
PF/Q/S (fundamental wave calculation) $Q_c = -U_{c(1)r} \times I_{c(1)i}$ $+ U_{c(1)i} \times I_{c(1)r}$	$Q = Q_1 + Q_2$			$Q = Q_1 + Q_2 + Q_3$			
<ul style="list-style-type: none"> <li>This reactive power <math>Q</math> is defined as the fundamental wave reactive power.</li> <li>Positive sign: Lag [Display indicates LAG, and output data is positive.] Negative sign: Lead [Display indicates LEAD, and output data is negative.]</li> </ul>							

\* Subscript c: measurement channel, (1): Harmonic calculation fundamental wave (1st order), r: resistance after FFT; i: reactance after FFT

Apparent power

Wiring setting	Single-phase 2 wire	Single-phase 3 wire		Three-phase 3 wire		Three-phase 4 wire	
Item	1P2W	1P3W	1P3W1U	3P3W2M	3P3W3M	3P4W	
Apparent power $S$ [VA]	$S_1$	$S_1$ $S_2$	$S_1$ $S_2 = U_1 \times I_2$	$S_1$ $S_2$ $S_3$	$S_1 = u_1 \times I_1$ $S_2 = u_2 \times I_2$ $S_3 = u_3 \times I_3$	$S_1$ $S_2$ $S_3$	
	PF/Q/S (RMS calculation) $S_c = U_c \times I_c$	$S = S_1 + S_2$		$S =$ $\frac{\sqrt{3}}{3}(S_1 + S_2 + S_3)$	$S =$ $\frac{\sqrt{3}}{3}(U_1 I_1 + U_2 I_2 + U_3 I_3)$	$S = S_1 + S_2 + S_3$	
	<ul style="list-style-type: none"> <li>The phase voltage is used to calculate <math>S_1</math>, <math>S_2</math>, and <math>S_3</math> for 3P3W3M connections. The line-to-line voltage is used to calculate total <math>S</math>.</li> </ul>						
	$S_1$	$S_1$ $S_2$			$S_1$ $S_2$ $S_3$		
	PF/Q/S (fundamental wave calculation) $S_c =$ $\sqrt{P_{c(1)}^2 + Q_{c(1)}^2}$	$S = \sqrt{P_{(1)}^2 + Q_{(1)}^2}$					
<ul style="list-style-type: none"> <li>This reactive power <math>S</math> is defined as the fundamental wave reactive power.</li> </ul>							

\* Subscript c: measurement channel, (1): Harmonic calculation fundamental wave (1st order)



## Power factor, Displacement power factor

Item	Wiring setting	Single-phase 2 wire	Single-phase 3 wire		Three-phase 3 wire		Three-phase 4 wire
		1P2W	1P3W	1P3W1U	3P3W2M	3P3W3M	3P4W
Power factor <i>PF</i>		$PF_1$	$PF_1$ $PF_2$		$PF_1$ $PF_2$ $PF_3$		
	<i>PF</i> PF/Q/S (RMS calculation)	$PF_c = si \left  \frac{P_c}{S_c} \right $		$PF = si \left  \frac{P}{S} \right $			
		<ul style="list-style-type: none"> <li>The component <i>si</i> indicates lag and lead. The sign of reactive power <i>Q</i> (fundamental wave reactive power) is used. Positive sign: Lag [Display indicates LAG, and output data is positive.] Negative sign: Lead [Display indicates LEAD, and output data is negative.]</li> <li>When <math>S &lt;  P </math> due to the effects of measurement error, unbalance, or other factors, <math>S =  P </math> and <math>PF = 1</math>.</li> <li>When <math>S = 0</math>, <math>PF = \text{over}</math>.</li> </ul>					
Displacement power factor <i>DPF</i>		$DPF_1$	$DPF_1$ $DPF_2$		$DPF_1$ $DPF_2$ $DPF_3$		
	<i>DPF</i> PF/Q/S (fundamental wave calculation)	$DPF_c = si \left  \frac{P_{c(1)}}{S_{c(1)}} \right $		$DPF = si \left  \frac{P_{(1)}}{S_{(1)}} \right $			
		<ul style="list-style-type: none"> <li>The component <i>si</i> indicates lag and lead. The sign of reactive power <i>Q</i> (fundamental wave reactive power) is used. Positive sign: Lag [Display indicates LAG, and output data is positive.] Negative sign: Lead [Display indicates LEAD, and output data is negative.]</li> <li>When <math>S_{c(1)} = 0</math>, <math>DPF = \text{over}</math>.</li> </ul>					

\* Subscript c: measurement channel, (1): Harmonic calculation fundamental wave (1st order)

Fundamental wave phase angle

Item	Wiring setting	Single-phase 2 wire	Single-phase 3 wire		Three-phase 3 wire		Three-phase 4 wire
		1P2W	1P3W	1P3W1U	3P3W2M	3P3W3M	3P4W
Fundamental wave voltage phase angle $\phi U_{c(1)}$ [deg.]		$\phi U_{1(1)}$	$\phi U_{1(1)}$ $\phi U_{2(1)}$	$\phi U_{1(1)}$	$\phi U_{1(1)}$ $\phi U_{2(1)}$ $\phi U_{12(1)}$		$\phi U_{1(1)}$ $\phi U_{2(1)}$ $\phi U_{3(1)}$
		$\tan^{-1} = \left( \frac{U_{c(1)r}}{-U_{c(1)i}} \right)$					
		<ul style="list-style-type: none"> <li>The fundamental wave voltage phase angle is displayed using the <math>U_1</math> fundamental wave as the <math>0^\circ</math> reference. For 3P3W3M connections, the phase voltage <math>u_1</math> fundamental wave is used as the <math>0^\circ</math> reference.</li> <li>When <math>U_{cr}=U_{ci}=0</math>, <math>\phi U_{c(1)}=0^\circ</math>.</li> </ul>					
Fundamental wave current phase angle $\phi I_{c(1)}$ [deg.]		$\phi I_{1(1)}$	$\phi I_{1(1)}$ $\phi I_{2(1)}$		$\phi I_{1(1)}$ $\phi I_{2(1)}$ $\phi I_{12(1)}$		$\phi I_{1(1)}$ $\phi I_{2(1)}$ $\phi I_{3(1)}$
		$\tan^{-1} = \left( \frac{I_{c(1)r}}{-I_{c(1)i}} \right)$					
		<ul style="list-style-type: none"> <li>The fundamental wave current phase angle is corrected and displayed using the <math>U_1</math> fundamental wave as the <math>0^\circ</math> reference.</li> <li>When measuring current only, measurements are corrected and displayed using the <math>I_1</math> fundamental wave as the <math>0^\circ</math> reference. In this case, the maximum value and minimum value are saved, the average value is not saved.</li> <li>When <math>I_{cr}=I_{ci}=0</math>, <math>\phi I_{c(1)}=0^\circ</math></li> </ul>					

\* Subscript c: measurement channel, (1): Harmonic calculation fundamental wave (1st order), r: resistance after FFT; i: reactance after FFT

## Electric energy, Energy cost

Item	Wiring setting	Single-phase 2 wire	Single-phase 3 wire		Three-phase 3 wire		Three-phase 4 wire
		1P2W	1P3W	1P3W1U	3P3W2M	3P3W3M	3P4W
Active energy (consumption) $WP+$ [Wh]	$WP+ = k \sum_1^h P(+)$						
	<ul style="list-style-type: none"> <li><math>k</math>: Calculation unit time [h]; <math>h</math>: measurement duration</li> <li><math>P(+)</math>: Only the consumption component of active power (positive component) is used.</li> </ul>						
Active energy (Regeneration) $WP-$ [Wh]	$WP- = k \sum_1^h P(-)$						
	<ul style="list-style-type: none"> <li><math>k</math>: Calculation unit time [h]; <math>h</math>: measurement duration</li> <li><math>P(-)</math>: Only the regeneration component of active power (negative component) is used.</li> </ul>						
Reactive energy (Lag) $WQ\_LAG$ [varh]	$WQ\_LAG = k \sum_1^h Q(LAG)$						
	<ul style="list-style-type: none"> <li><math>k</math>: Calculation unit time [h]; <math>h</math>: measurement duration</li> <li><math>Q(LAG)</math>: Only the lag component of reactive power is used.</li> </ul>						
Active energy (Lead) $WQ\_LEAD$ [varh]	$WQ\_LEAD = k \sum_1^h Q(LEAD)$						
	<ul style="list-style-type: none"> <li><math>k</math>: Calculation unit time [h]; <math>h</math>: measurement duration</li> <li><math>Q(LEAD)</math>: Only the lead component of reactive power is used.</li> </ul>						
Energy cost $Ecost$ [User-specified units]	$Ecost = WP+ \times rate$						
	<ul style="list-style-type: none"> <li><math>WP+</math>: Uses active energy consumption only.</li> <li><math>rate</math>: Unit cost (User-specified setting from 0.00000 to 99999.9/kWh)</li> </ul>						

Demand quantity (output data only; not displayed)

Item	Wiring setting	Single-phase 2 wire	Single-phase 3 wire		Three-phase 3 wire		Three-phase 4 wire
		1P2W	1P3W	1P3W1U	3P3W2M	3P3W3M	3P4W
Active power demand quantity (consumption) <i>WP+dem</i> [Wh]	$WP+dem = k \sum_1^h P(+)$						
	<ul style="list-style-type: none"> <li>• <i>k</i>: Calculation unit time [h]; <i>h</i>: interval duration</li> <li>• <i>P(+)</i>: Only the consumption component of active power (positive component) is used.</li> </ul>						
Active power demand quantity (Regeneration) <i>WP-dem</i> [Wh]	$WP-dem = k \sum_1^h P(-)$						
	<ul style="list-style-type: none"> <li>• <i>k</i>: Calculation unit time [h]; <i>h</i>: interval duration</li> <li>• <i>P(-)</i>: Only the regeneration component of active power (negative component) is used.</li> </ul>						
Reactive power demand quantity (Lag) <i>WQLAGdem</i> [varh]	$WQLAGdem = k \sum_1^h Q(LAG)$						
	<ul style="list-style-type: none"> <li>• <i>k</i>: Calculation unit time [h]; <i>h</i>: interval duration</li> <li>• <i>Q(LAG)</i>: Only the lag component of reactive power is used.</li> </ul>						
Reactive power demand quantity (Lead) <i>WQLEADdem</i> [varh]	$WQLEADdem = k \sum_1^h Q(LEAD)$						
	<ul style="list-style-type: none"> <li>• <i>k</i>: Calculation unit time [h]; <i>h</i>: interval duration</li> <li>• <i>Q(LEAD)</i>: Only the lead component of reactive power is used.</li> </ul>						

## Demand value

Item	Wiring setting	Single-phase 2 wire	Single-phase 3 wire		Three-phase 3 wire		Three-phase 4 wire
		1P2W	1P3W	1P3W1U	3P3W2M	3P3W3M	3P4W
Active power demand value (consumption) $P_{dem+}[W]$	$P_{dem+} = \frac{1}{h} \sum_1^h P(+)$						
	<ul style="list-style-type: none"> <li><math>h</math>: Interval duration</li> <li><math>P(+)</math>: Only the consumption component of active power (positive component) is used.</li> </ul>						
Active power demand value (regeneration) $P_{dem-}[W]$	$P_{dem-} = \frac{1}{h} \sum_1^h P(-)$						
	<ul style="list-style-type: none"> <li><math>h</math>: Interval duration</li> <li><math>P(-)</math>: Only the regeneration component of active power (negative component) is used.</li> </ul>						
Reactive power demand value (Lag) $Q_{dem\_LAG}[var]$	$Q_{dem\_LAG} = \frac{1}{h} \sum_1^h Q(LAG)$						
	<ul style="list-style-type: none"> <li><math>h</math>: Interval duration</li> <li><math>Q(LAG)</math>: Only the lag component of reactive power is used.</li> </ul>						
Reactive power demand value (Lead) $Q_{dem\_LEAD}[var]$	$Q_{dem\_LEAD} = \frac{1}{h} \sum_1^h Q(LEAD)$						
	<ul style="list-style-type: none"> <li><math>h</math>: Interval duration</li> <li><math>Q(LEAD)</math>: Only the lead component of reactive power is used.</li> </ul>						
Power factor demand value $PF_{dem} [ ]$	$PF_{dem} = \frac{P_{dem+}}{\sqrt{(P_{dem+})^2 + (Q_{dem\_LAG})^2}}$						

## Harmonic voltage, and current

Item	Wiring setting	Single-phase 2 wire	Single-phase 3 wire		Three-phase 3 wire		Three-phase 4 wire
		1P2W	1P3W	1P3W1U	3P3W2M	3P3W3M	3P4W
Voltage $U_{ck}[Vrms]$	$U_{1k}$		$U_{1k}$ $U_{2k}$	$U_{1k}$	$U_{1k}$ $U_{2k}$	$U_{1k}$ $U_{2k}$ $U_{3k}$	$U_{1k}$ $U_{2k}$ $U_{3k}$
	$U_{ck} = \sqrt{U_{ckr}^2 + U_{cki}^2}$						
<ul style="list-style-type: none"> <li>When using 3P3W3M wiring, the phase voltage is used.</li> <li>Harmonic voltage content percentage (%): <math>U_{ck} = U_{ck}/U_{c1} \times 100</math> (%)</li> </ul>							
Current $I_{ck}[Arms]$	$I_{1k}$		$I_{1k}$ $I_{2k}$			$I_{1k}$ $I_{2k}$ $I_{3k}$	
	$I_{ck} = \sqrt{I_{ckr}^2 + I_{cki}^2}$						
<ul style="list-style-type: none"> <li>Harmonic current content percentage (%): <math>I_{ck} = I_{ck}/I_{c1} \times 100</math> (%)</li> </ul>							

\* Subscript c: measurement channel, k: order being analyzed; r: resistance after FFT; i: reactance after FFT

11.5 Calculation Formulas

Total harmonic distortion

Item	Wiring setting	Single-phase 2 wire	Single-phase 3 wire		Three-phase 3 wire		Three-phase 4 wire
		1P2W	1P3W	1P3W1U	3P3W2M	3P3W3M	3P4W
Total harmonic distortion-F THD-F_Uc [%]	THD-F_U1		THD-F_U1 THD-F_U2	THD-F_U1	THD-F_U1 THD-F_U2		THD-F_U1 THD-F_U2 THD-F_U3
	$\sqrt{\frac{\sum_{k=2}^{13} (U_{ck})^2}{U_{C1}}} \times 100$ (%)						
<ul style="list-style-type: none"> <li>When using 3P3W3M wiring, the phase voltage is used.</li> </ul>							
Total harmonic distortion-F THD-F_Ic [%]	THD-F_I1				THD-F_I1 THD-F_I2		THD-F_I1 THD-F_I2 THD-F_I3
	$\sqrt{\frac{\sum_{k=2}^{13} (I_{ck})^2}{I_{C1}}} \times 100$ (%)						
Total harmonic distortion-R THD-R_Uc [%]	THD-R_U1		THD-R_U1 THD-R_U2	THD-R_U1	THD-R_U1 THD-R_U2		THD-R_U1 THD-R_U2 THD-R_U3
	$\sqrt{\frac{\sum_{k=2}^{13} (U_{ck})^2}{\sqrt{\sum_{k=1}^{13} (U_{ck})^2}}} \times 100$ (%)						
<ul style="list-style-type: none"> <li>When using 3P3W3M wiring, the phase voltage is used.</li> </ul>							
Total harmonic distortion-R THD-R_Ic [%]	THD-R_I1				THD-R_I1 THD-R_I2		THD-R_I1 THD-R_I2 THD-R_I3
	$\sqrt{\frac{\sum_{k=2}^{13} (I_{ck})^2}{\sqrt{\sum_{k=1}^{13} (I_{ck})^2}}} \times 100$ (%)						

\* Subscript c: measurement channel, k: order being analyzed

## 11.6 Range Configuration and Accuracy by Clamp Sensor

- Reference**
- The range-configuration table shows the full-scale display value of each measurement range.
  - Voltage measurements is indicated as 5 V to 520 V. If a measurement is below 5 V, it is displayed as the value zero.
  - Current measurements is indicated as 0.4% to 130% f.s. of the range. If a measurement is below 0.4% f.s., it is displayed as the value zero.
  - Power measurement is indicated as 0% to 130% f.s. of the range. It is displayed as the value zero when the voltage or current is zero.
  - The apparent power (S) and reactive power (Q) range makeup is the same as for active power (P) using VA and var units, respectively.
  - When the VT ratio and CT ratio are set, the ranges will be multiplied by (VT ratio x CT ratio) (when a power range falls below 1.0000 mW or exceeds 9.9999 GW and a current range falls less than 1 mA, a scaling error occurs and the setting is not accepted).

### When Model 9660, 9661, or 9695-03 Clamp on Sensor is Used

#### Power ranges

Voltage	Wiring	Current range				
		5.0000 A	10.000 A	50.000 A	100.00 A	500.00 A
400.0 V	1P2W	2.0000 kW	4.0000 kW	20.000 kW	40.000 kW	200.00 kW
	1P3W 1P3W1U 3P3W2M 3P3W3M	4.0000 kW	8.0000 kW	40.000 kW	80.000 kW	400.00 kW
	3P4W	6.0000 kW	12.000 kW	60.000 kW	120.00 kW	600.00 kW

\* Accuracy is guaranteed for 5 A to 100 A ranges (9660 and 9695-03) and for 5 A to 500 A ranges (9661). The 9660 and 9695-03 provide CAT III (300 V) performance.

#### Combined accuracy

Current range	Model 9660, Model 9695-03	Model 9661
500.00 A	-	±2.3% rdg.±0.31% f.s.
100.00 A	±2.3% rdg.±0.32% f.s.	±2.3% rdg.±0.35% f.s.
50.000 A	±2.3% rdg.±0.34% f.s.	±2.3% rdg.±0.4% f.s.
10.000 A	±2.3% rdg.±0.5% f.s.	±2.3% rdg.±0.8% f.s.
5.0000 A	±2.3% rdg.±0.7% f.s.	±2.3% rdg.±1.3% f.s.

**When Model 9669 Clamp on Sensor is Used****Power ranges**

Voltage	Wiring	Current range		
		100.00 A	200.00 A	1.0000 kA
400.0 V	1P2W	40.000 kW	80.000 kW	400.00 kW
	1P3W 1P3W1U 3P3W2M 3P3W3M	80.000 kW	160.00 kW	800.00 kW
	3P4W	120.00 kW	240.00 kW	1.2000 MW

**Combined accuracy**

Current range	Model 9669
1.0000 kA	±3% rdg.±0.31% f.s.
200.00 A	±3% rdg.±0.35% f.s.
100.00 A	±3% rdg.±0.4% f.s.

**When Model 9694 or 9695-02 Clamp on Sensor is Used****Power ranges**

Voltage	Wiring	Current range				
		500.00 mA	1.0000 A	5.0000 A	10.000 A	50.000 A
400.0 V	1P2W	200.00 W	400.00 W	2.0000 kW	4.0000 kW	20.000 kW
	1P3W 1P3W1U 3P3W2M 3P3W3M	400.00 W	800.00 W	4.0000 kW	8.0000 kW	40.000 kW
	3P4W	600.00 W	1.2000 kW	6.0000 kW	12.000 kW	60.000 kW

\* Accuracy is guaranteed for 500 mA to 5 A ranges (9694) and for 500 mA to 50 A ranges (Model 9695-02). Both the 9694 and 9695-02 provide CAT III (300 V) performance.

**Combined accuracy**

Current range	Model 9694	Model 9695-02
50.000 A	-	±2.3% rdg.±0.32% f.s.
10.000 A	-	±2.3% rdg.±0.4% f.s.
5.0000 A	±2.3% rdg.±0.32% f.s.	±2.3% rdg.±0.5% f.s.
1.0000 A	±2.3% rdg.±0.4% f.s.	±2.3% rdg.±1.3% f.s.
500.00 mA	±2.3% rdg.±0.5% f.s.	±2.3% rdg.±2.3% f.s.



### When Model CT9667 Flexible Clamp on Sensor is Used

#### Power ranges

Voltage	Wiring	Current range (when 5 kA is selected)		
		500.00 A	1.0000 kA	5.0000 kA
400.0 V	1P2W	200.00 kW	400.00 kW	2.0000 MW
	1P3W 1P3W1U 3P3W2M 3P3W3M	400.00 kW	800.00 kW	4.0000 MW
	3P4W	600.00 kW	1.2000 MW	6.0000 MW

Voltage	Wiring	Current range (500 A is selected)		
		50.000 A	100.00 A	500.00 A
400.0 V	1P2W	20.000 kW	40.000 kW	200.00 kW
	1P3W 1P3W1U 3P3W2M 3P3W3M	40.000 kW	80.000 kW	400.00 kW
	3P4W	60.000 kW	120.00 kW	600.00 kW

#### Combined accuracy

Current range	Model CT9667 5 kA range	Model CT9667 500 A range
5.0000 kA	±4% rdg.±0.6% f.s.	-
1.0000 kA	±4% rdg.±1.8% f.s.	-
500.00 A	±4% rdg.±3.3% f.s.	±4% rdg.±0.6% f.s.
100.00 A	-	±4% rdg.±1.8% f.s.
50.000 A	-	±4% rdg.±3.3% f.s.

**11.7 PW9020 Safety Voltage Sensor****General Specifications**

Operating environment	Indoors, Pollution degree 2, altitude up to 2,000 m (6562-ft.)
Operating temperature and humidity	0°C to 50°C (32°F to 122°F), 80% RH or less (non-condensation)
Storage temperature and humidity	-10°C to 60°C (14°F to 140°F), 80% RH or less (non-condensation)
Dielectric strength	7.06 kV AC rms (sensing current: 1 mA)(50 Hz/60 Hz,60 sec.) Between clip aperture and output terminal
Power supply	Power is supplied from the PW3365.
Dimensions	Clip: Approx. 33 mm W × 61.5 mm H × 97mm D / Approx. 1.30" W × 2.42" H × 3.82" D (excluding protrusions) Relay box: Approx. 34 mm W × 21 mm H × 131.5mm D / Approx. 1.34" W × 0.83" H × 5.18" D (excluding protrusions)
Mass	Approx. 220 g (Approx. 7.8 oz.)
Cord length	Total length: Approx. 3 m/ Approx. 118.11"(including relay box; not including clip) Between clip and relay box: Approx. 1.5 m/ Approx. 59.06"
Product warranty period	3 years
Applicable standards	Safety EN61010 EMC EN61326 Class A

**Other specifications**

Rated primary voltage	400 V AC
Output voltage	800 mV/400 V
Maximum rated voltage to earth	600 V Measurement Categories III (anticipated transient overvoltage 6000 V) 300 V Measurement Categories IV (anticipated transient overvoltage 6000 V)
Valid measurement range	As per PW3365 <b>See:</b> The PW3365 specifications:"Effective measuring range" (p.187)
Voltage detection method	Coupling capacitance cancellation method
Measurement targets	Metal parts, Insulated wires (IV, CV equivalent) but not shielded wires

## Other specifications

Measurable conductor diameter	Outer (finished) diameter: $\phi 6$ mm to 30 mm (IV wire: 8 mm <sup>2</sup> to 325 mm <sup>2</sup> , CV wire: 2 mm <sup>2</sup> to 250 mm <sup>2</sup> ) When measuring a conductor with a diameter of 15 mm or less, the center of the conductor must be aligned with the r mark on the lower case (see the following figure).
Accuracy warranty for temperature and humidity ranges	23°C $\pm$ 5°C (73 $\pm$ 9°F), 80%RH or less
Accuracy warranty period	1 year
RMS accuracy	45 Hz to 66 Hz: Combination accuracy with PW3365: $\pm 1.5\%$ rdg. $\pm 0.2\%$ f.s. (For the PW9020 alone, $\pm 1.2\%$ rdg. $\pm 0.1\%$ f.s.) f.s. at 400 V, At a fundamental frequency of 50 Hz/60 Hz and an input voltage of 20 V or less 780 Hz or less: For the PW9020 alone, $\pm 25\%$ rdg. $\pm 2.7\%$ f.s.
Phase accuracy	Combination accuracy with PW3365: $\pm 1.3^\circ$ equivalent (For the PW9020 alone, $\pm 1.0^\circ$ equivalent) 50 Hz/60 Hz, f.s. input
Effects of temperature	Defined in combination with PW3365 <b>See:</b> The PW3365 specifications: "Temperature characteristic" (p.189)
Effects of humidity	Add below to combination accuracy with PW3365 (voltage, power, phase): Accuracy within $\pm 1\%$ f.s., phase within $\pm 1^\circ$ During measurement of insulated wire at a humidity of 70% RH to 80% RH
Effects of adjacent wires (conductors)	Add below to combination accuracy with PW3365 (voltage, power): Within $\pm 1\%$ f.s. With adjacent wires (conductors) with a potential difference of 400 V in contact with the clip (see the following figure)

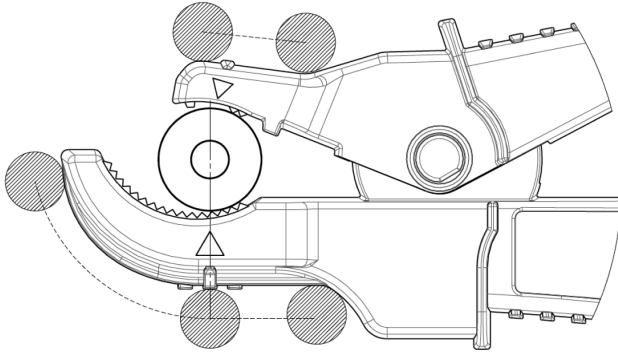

Figure Effects of Adjacent Wires (Conductors)

# Maintenance and Service

## Chapter 12

### 12.1 Trouble Shooting

#### Replaceable Parts and Operating Lifetimes

The characteristics of some of the parts used in the product may deteriorate with extended use. To ensure the product can be used over the long term, it is recommended to replace these parts on a periodic basis. When replacing parts, please contact your Hioki distributor. The service life of parts varies with the operating environment and frequency of use. Parts are not guaranteed to operate throughout the recommended replacement cycle.

Part	Recommended replacement cycle	Remarks/conditions
Lithium battery	Approx. 10 years	The instrument contains a built-in backup lithium battery, which offers a service life of about ten years. If the date and time deviate substantially when the instrument is switched on, it is the time to replace that battery. Contact your authorized Hioki distributor or reseller.
Electrolytic Capacitors	Approx. 10 years	A PCB on which a part concerned is mounted must be replaced. The board on which the parts in question are mounted should be replaced.
9459 Battery Pack	Approx. 1 year or approx. 500 charge/recharge cycles	Requires periodic replacement.
Z4001 SD Memory Card 2GB	Data storage of approx. 10 years or approx. 2 million rewrites	The SD memory card service life varies with the manner in which it is used. Requires periodic replacement.

The fuse is housed in the power unit of the instrument. If the power does not turn on, the fuse may be blown. If this occurs, a replacement or repair cannot be performed by customers. Please contact your authorized Hioki distributor or reseller.

**If damage is suspected**

If damage is suspected, check the "Before Having the Instrument Repaired" (p.223) section before contacting your authorized Hioki distributor or reseller.

**Calibrations****IMPORTANT**

Periodic calibration is necessary in order to ensure that the instrument provides correct measurement results of the specified accuracy.

The calibration frequency varies depending on the status of the instrument or installation environment. We recommend that the calibration frequency is determined in accordance with the status of the instrument or installation environment and that you request that calibration be performed periodically.

**Precautions when transporting the instrument**

- When sending the instrument for repair, remove the battery pack and SD memory card carefully to prevent damage in transit. Include cushioning material so the instrument cannot move within the package.
- Include a description of existing damage. We do not take any responsibility for damage incurred during shipping.

**See:** See also "Transport precautions" (p.3).

**Storage**

To avoid problems with battery pack operation, remove the battery pack from the instrument if it is to be stored for a long time.

---

## Before Having the Instrument Repaired

Before returning for repair

Symptom	Check Item, or Cause	Remedy and Reference
The display does not appear when you turn the power on.	If powering the instrument with the AC adapter <ul style="list-style-type: none"> <li>• Are the power cord and AC adapter properly connected?</li> </ul>	Verify that the power cord or AC adapter is connected properly. <b>See:</b> "2.5 Connecting the AC Adapter" (p.41)
	If powering the instrument with the battery <ul style="list-style-type: none"> <li>• Has the PW9002 Battery Set (9459 Battery Pack) been properly installed?</li> <li>• Has the battery pack been charged?</li> </ul>	Verify that the battery pack has been charged and installed. <b>See:</b> " Installing (replacing) the Battery Pack" (p.32) <b>See:</b>
Keys do not work.	Has the key lock been activated?	Press and hold the  key for at least 3 seconds to cancel the key lock.
Voltage or current measured values are not being displayed.	<ul style="list-style-type: none"> <li>• Are the voltage sensors or clamp sensors connected improperly?</li> <li>• Are the input channels and display channels incorrect?</li> <li>• Has an appropriate current range been selected?</li> </ul>	Check the wirings and wiring settings. <b>See:</b> "3.4 Connecting the Current Sensors to the Instrument" (p.53) to "3.9 Verifying Correct Wiring (Wiring Check)" (p.65)
Measured values do not stabilize.	<ul style="list-style-type: none"> <li>• Is the frequency of the measurement target being measured 50 Hz or 60 Hz? The instrument does not support 400 Hz frequency lines.</li> </ul>	The instrument can only be used with 50 Hz/60 Hz lines. Lines operating at 400 Hz cannot be measured.
	<ul style="list-style-type: none"> <li>• If the wiring setting is 1P2W/1P3W/3P3W2M/3P3W3M/3P4W, is voltage input being supplied? The instrument may not be able to perform stable measurement without voltage input.</li> </ul>	If not measuring voltage, select the current-only wiring and set the frequency setting to the measurement line frequency (50 Hz/60 Hz). <b>See:</b> "4.2 Changing Measurement Settings" (p.72)

## 12.1 Trouble Shooting

---

Symptom	Check Item, or Cause	Remedy and Reference
Unable to charge the 9459 Battery Pack (the Charge LED does not light up).	<ul style="list-style-type: none"> <li>Verify that the ambient temperature is within the range of 10°C to 40°C.</li> </ul>	<p>The instrument's battery can be charged within the ambient temperature range of 10°C to 40°C.</p> <p><b>See:</b> "Installing (replacing) the Battery Pack" (p.32)</p>
	<ul style="list-style-type: none"> <li>Has the instrument been stored for an extended period of time with the battery pack installed?</li> </ul>	<p>The battery pack may have degraded, signaling that it needs to be replaced. Please purchase a new battery pack. Contact your Hioki distributor for more information. If the instrument will not be used for one month or longer, remove the battery pack and store at -20°C to 30°C.</p> <p><b>See:</b> "Installing (replacing) the Battery Pack" (p.32)</p>
The battery pack can only be used for a short period of time.	<ul style="list-style-type: none"> <li>The battery pack's capacity may have deteriorated due to degradation.</li> </ul>	<p><b>See:</b> "Installing (replacing) the Battery Pack" (p.32)</p>

If the cause of the issue remains unclear, reset the system. Doing so will initialize settings to their factory defaults.

**See:** "4.5 Initializing the Instrument (System Reset)" (p.92)



## 12.2 Cleaning

### Instrument and Voltage Sensor

- To clean the instrument and sensor, wipe it gently with a soft cloth moistened with water or mild detergent.

#### IMPORTANT

Never use solvents such as benzene, alcohol, acetone, ether, ketones, thinners or gasoline, as they can deform and discolor the case.

- Wipe the LCD gently with a soft, dry cloth.

### Clamp Sensor

Measurements are degraded by dirt on the mating surfaces of the

**Reference** clamp-on sensor, so keep the surfaces clean by gently wiping with a soft cloth.

## 12.3 Error Indication

Error displays other than system errors can be cleared by pressing any key.



### System error

Error display	Cause	Solution/more information
*** SYSTEM ERROR *** The internal programming of the PW3365 is corrupted and the instrument must be repaired.	A program failure has occurred.	The instrument needs to be repaired. Contact your authorized Hioki distributor or reseller.
*** SYSTEM ERROR *** The SDRAM of the PW3365 is corrupted and the instrument must be repaired.	A memory failure has occurred.	
*** SYSTEM ERROR *** The adjustment values of the PW3365 are corrupted and the instrument must be repaired.	An adjustment value failure has occurred.	
*** SYSTEM ERROR *** The display memory of the PW3365 is corrupted and the instrument must be repaired.	A display memory failure has occurred.	



### 12.3 Error Indication

Error display	Cause	Solution/more information
<p>*** SYSTEM ERROR ***            BACKUP ERROR. The PW3365 must be returned to default factory condition. Initialize?            YES: ENTER key</p>	Backed up system variables are incorrect or contradictory.	Initialize and reconfigure the settings. If you experience backup errors frequently, the backup battery may have deteriorated. The instrument needs to be repaired. Contact your authorized Hioki distributor or reseller.

### Error

Error display	Cause	Solution/more information
<p>*** ERROR ***            Invalid key</p>	While the Quick Set is running, you cannot switch to the Measurement, Settings, File, or Wirings screen.	Press the  [STOP QS] key to exit the Quick Set and then perform your desired operation.
<p>*** ERROR ***            START avail. only in MEAS screen.</p>	Recording can only be started on the Measurement screen.	Press the  key on the Measurement screen to start recording.
<p>*** ERROR ***            STOP avail. only in MEAS screen.</p>	Recording can only be stopped on the Measurement screen.	Press the  key on the Measurement screen to stop recording.
<p>*** ERROR ***            Invalid setting value.</p>	You attempted to configure the setting with a value that is outside the valid setting range.	Configure the setting with a value that falls within the valid setting range. <b>See:</b> "Chapter 4 Changing Settings" (p.71)
<p>*** ERROR ***            Scaling error.</p>	The VT and CT ratios were configured so that the power range exceeded 1 mW to 9.9999 GW.	Set the VT and CT ratios so that the power range falls within 1 mW to 9.9999 GW. <b>See:</b> "11.6 Range Configuration and Accuracy by Clamp Sensor" (p.215)
<p>*** ERROR ***            Only PW3365 folders can be opened.</p>	You cannot move higher up in the folder hierarchy than the root on the SD memory card (by pressing the left arrow key).	Select a folder or file with the up and down arrow keys and switch folders by pressing the right arrow key or the Enter key. <b>See:</b> "8.1 Viewing and Using the File Screen" (p.132)

### Operation error

Error display	Cause	Solution/more information
*** OPERATION ERROR *** This folder cannot be deleted.	You attempted to delete the [PW3365] basic folder.	The [PW3365] basic folder cannot be deleted. If you wish to delete it, you must do so on a computer.
*** OPERATION ERROR *** Cannot modify settings while in STANDBY.	You attempted to change a setting that cannot be changed while the instrument is in the recording standby state.	If you need to change the setting, cancel the recording standby state with the  key on the Measurement screen.
*** OPERATION ERROR *** Cannot modify settings while recording is in progress.	You attempted to change a setting that cannot be changed during recording and measurement.	If you need to change the setting, stop the recording measurement with the  key on the Measurement screen.

### File error

Error display	Cause	Solution/more information
*** FILE ERROR *** Save failed.	The instrument was unable to save data due to a problem with the SD memory card.	Format the SD memory card. <b>See:</b> "8.8 Formatting the SD Memory Card or Internal Memory" (p.146)
	The instrument was unable to save data due to a problem with its internal memory.	Format the internal memory. <b>See:</b> "8.8 Formatting the SD Memory Card or Internal Memory" (p.146)
*** FILE ERROR *** Load failed.	The instrument was unable to load settings data due to a problem with the settings file.	Create a new settings file and load it. <b>See:</b> "8.4 Saving Settings Files" (p.141)
*** FILE ERROR *** File or folder could not be deleted.	The SD memory card is in the locked (write-protected) state, or the file or folder attribute is set to "read-only."	If the SD memory card is locked, unlock it.  If the file or folder attribute is set to "read-only," change the attribute using a computer.

### 12.3 Error Indication

Error display	Cause	Solution/more information
*** FILE ERROR *** The file with the same name exists.	The instrument was unable to copy data from its internal memory to the SD memory card because data with the same filename already existed on the SD memory card.	Delete the data with the same filename from the SD memory card or change the filename using a computer.
*** FILE ERROR *** Formatting failed.	An SD memory card error occurred, or the card was ejected, during formatting.	Reinsert the SD memory card and format it again. If unable to format the card, the card may be damaged and should be replaced.
	An internal memory error occurred.	The instrument needs to be repaired. Contact your authorized Hioki distributor or reseller.
*** FILE ERROR *** No settings file. Select a settings file.	The instrument was unable to load the settings because the selected file is not a settings file.	Select a settings file (extension of .SET).
*** FILE ERROR *** Maximum files reached. Additional files cannot be created.	The maximum number of files and folders that can be created was exceeded.	Switch SD memory cards. Alternately, make a backup of the SD memory card using a computer, delete unnecessary data on the card, and format it. <b>See:</b> "8.6 Copying Internal Memory Files to the SD Memory Card" (p.144) "8.7 Deleting Folders and Files" (p.145)

### SD card error

Error display	Cause	Solution/more information
*** SD CARD ERROR *** SD Card not found. Insert an SD Card.	Data cannot be saved to the SD memory card because no SD memory card has been inserted into the instrument.	Insert an SD memory card. <b>See:</b> "2.4 Inserting (Removing) an SD Memory Card" (p.38)
*** SD CARD ERROR *** SD Card is not formatted for this device.	The SD memory card has not been formatted with the dedicated SD format.	Format the card with the instrument. <b>See:</b> "8.8 Formatting the SD Memory Card or Internal Memory" (p.146)

Error display	Cause	Solution/more information
*** SD CARD ERROR *** SD Card not compatible.	An unsupported card such as an SDXC memory card was inserted into the instrument.	Use the instrument's optional SD memory card.
*** SD CARD ERROR *** SD Card locked. Unlock the SD Card.	The SD memory card is in the locked (write-protected) state.	Unlock the SD memory card. <b>See:</b> "Inserting the SD memory card" (p.40)
*** SD CARD ERROR *** Data has been backed up to internal memory.	Data will be saved to the instrument's internal memory if no SD memory card has been inserted or the SD memory card is full while performing recording and measurement with the save destination set to "SD card."	Insert an SD memory card or switch cards.
*** SD CARD ERROR *** SD Card is full. Delete files or reformat.	Data cannot be saved to the SD memory card because the card is full.	Switch SD memory cards. Alternately, make a backup of the SD memory card using a computer, delete unnecessary data on the card, and format it. <b>See:</b> "8.6 Copying Internal Memory Files to the SD Memory Card" (p.144) "8.7 Deleting Folders and Files" (p.145) "8.8 Formatting the SD Memory Card or Internal Memory" (p.146)

### 12.3 Error Indication

Error display	Cause	Solution/more information
<p>*** SD CARD ERROR ***</p> <p>Error while attempting to access the SD Card.</p>	<p>You attempted to access a corrupt file or a corrupt SD memory card. Alternately, the card was removed while it was being accessed.</p>	<ul style="list-style-type: none"> <li>Back up any data on the SD memory card on a computer before formatting the card.</li> </ul> <p><b>See:</b> "8.8 Formatting the SD Memory Card or Internal Memory" (p.146)</p> <ul style="list-style-type: none"> <li>If the error persists after formatting the SD memory card, replace it with a new card.</li> <li>Do not remove the card while it is mounted by the device (while the  red indicator is lit up).</li> </ul>
<p>*** SD CARD ERROR ***</p> <p>This is a read-only file.</p>	<p>The SD memory card is in the locked (write-protected) state, or the file or folder attribute is set to "read-only."</p>	<p>If the SD memory card is locked, unlock it.</p> <p>If the file or folder attribute is set to "read-only," change the attribute using a computer.</p>

### Internal memory error

Error display	Cause	Solution/more information
<p>*** MEMORY ERROR ***</p> <p>Internal memory is full. Delete files.</p>	<p>The instrument's internal memory is full.</p>	<p>If performing recording and measurement, stop the instrument, back up the internal memory using a computer, and delete files from the internal memory or format it.</p> <p><b>See:</b> "9.2 Copying Data to a Computer (USB)" (p.152) "8.7 Deleting Folders and Files" (p.145)</p>
<p>*** MEMORY ERROR ***</p> <p>Internal memory is corrupted. Please reformat.</p>	<p>The instrument's internal memory is corrupt.</p>	<p>Format the internal memory.</p> <p><b>See:</b> "8.8 Formatting the SD Memory Card or Internal Memory" (p.146)</p>

## 12.4 Disposing of the Instrument

When disposing of this instrument, remove the lithium battery and dispose of battery and instrument in accordance with local regulations.

### WARNING



• Battery may explode if mistreated. Do not short-circuit, recharge, disassemble or dispose of in fire.



• To avoid electric shock, turn off the power switch and disconnect the cords and cables before removing the lithium battery.  
• Keep batteries away from children to prevent accidental swallowing.

### Lithium Battery Removal

#### Preparation items

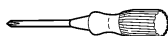

Phillips screwdriver



Tweezers

- 1** Turn off the power switch.
- 2** If any cords are connected, for example voltage sensors, clamp sensors, or the AC adapter, disconnect them.  
If the PW9002 Battery Set (9459 Battery Pack) is installed, remove it.

**See:** "Installing (replacing) the Battery Pack" (p.32)

- 3** Pressing with your fingers on the corners of the two protectors on the left and right sides of the instrument, remove them.

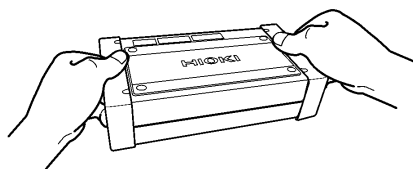

## 12.4 Disposing of the Instrument

- 4** Using a Phillips screwdriver, remove the four screws holding the lower case on the bottom of the instrument.

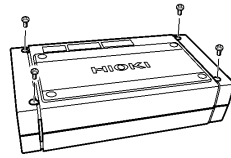

- 5** Remove the lower case.

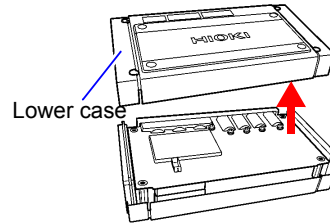

- 6** Remove the single screw holding the board in place and remove the board.

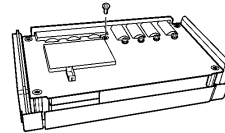

- 7** Insert a pair of tweezers between the battery holder and the battery and lift up to remove the battery

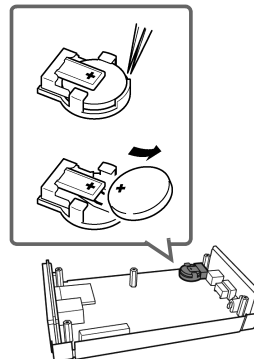

### CALIFORNIA, USA ONLY

This product contains a CR Coin Lithium Battery which contains Perchlorate Material - special handling may apply.

See [www.dtsc.ca.gov/hazardouswaste/perchlorate](http://www.dtsc.ca.gov/hazardouswaste/perchlorate)



# Appendix

## Appendix 1 Voltage Sensor Measurement Principles

Internally, the PW9020 Voltage Sensor incorporates electrode (metal plate). When the PW9020 is clamped onto a measurement target, capacitive coupling of the measurement target and the sensor electrode causes the minuscule current  $I$  to flow.

$$I = \omega CV \quad (1)$$

$\omega$ : Angular speed of measurement target [rad/s]  
 $C$ : Capacitance between the measurement target and the sensor electrode [F]

$V$ : Voltage between the measurement target and the sensor electrode (AC) [V]

Based on equation (1),  $I$  will be 0 when  $V = 0$  (when the measurement target and the sensor electrode are at the same potential). By detecting the minuscule current  $I$  and controlling the voltage of the sensor electrode so that  $I$  reaches 0, the PW9020 generates the same voltage internally as exists on the measurement target.

By equalizing the generated voltage and the measured voltage and then measuring the internally generated voltage, it is possible to make measurements without contacting metal parts.

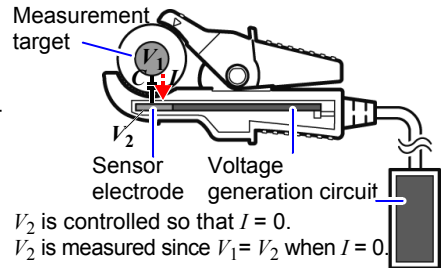

## Appendix 2 How the Instrument Samples Data

The instrument samples each channel at 10.24 kHz. The three voltage channels and three current channels are switched at 61.44 kHz with a multiplexer (MUX), and two A/D converters (ADC) (one for voltage and another for current) sample the channels. Since U1 and I1, U2 and I2, and U3 and I3 are sampled simultaneously, there is no phase difference between voltage and current readings for the same channel. Sampling between channels for voltage (U1, U2, and U3) and current (I1, I2, and I3) is shifted. The phase differences that result from this sampling shift are corrected internally, and the phase angle is displayed. However, since waveforms are not corrected for sampling shift, the waveforms for U1, U2, and U3 as well as I1, I2, and I3 will differ slightly if the same input is supplied to all three channels.

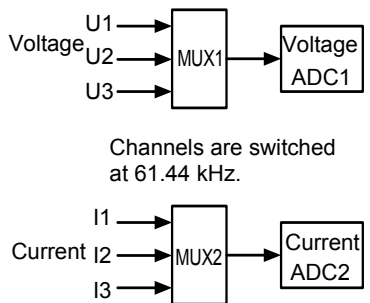

## Appendix 3 Three-phase 3-wire Measurement

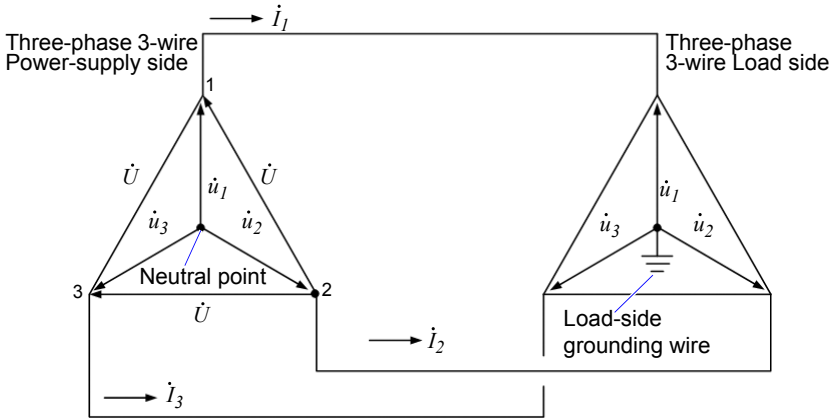

An artificial circuit of a three-phase 3-wire line

$\dot{U}_1, \dot{U}_2, \dot{U}_3$  : The vectors of line-to-line voltage

$\dot{u}_1, \dot{u}_2, \dot{u}_3$  : The vectors of phase to neutral voltage

$\dot{I}_1, \dot{I}_2, \dot{I}_3$  : The vectors of line (phase) current

### 3-phase/3-wire/3-wattmeter measurement (3P3W3M)

In 3-wattmeter measurement, three phase voltages ( $\dot{u}_1, \dot{u}_2, \dot{u}_3$ ) and three line (phase) currents ( $\dot{I}_1, \dot{I}_2, \dot{I}_3$ ) are measured.

Since a 3-phase/3-wire line does not have a neutral point, the actual phase voltage cannot be measured. The conductor-to-ground voltage (phase voltage from the virtual neutral point) is measured using the load-side grounding wire or a grounded metal part on the load side as the virtual neutral point.

The 3-phase active power  $P$  is calculated as the sum of all the phase active power values.

$$P = \dot{u}_1 \dot{I}_1 + \dot{u}_2 \dot{I}_2 + \dot{u}_3 \dot{I}_3 \quad (1)$$

**3-phase/3-wire/2-wattmeter measurement (3P3W2M)**

In 2-wattmeter measurement, two line-to-line voltages ( $\dot{U}_1, \dot{U}_2$ ) and three line (phase) currents ( $\dot{I}_1, \dot{I}_3$ ) are measured. The 3-phase active power  $P$  can be derived from two voltage and current values, as shown below:

$$\begin{aligned} P &= \dot{U}_1 \dot{I}_1 + \dot{U}_2 \dot{I}_3 \quad (\dot{U}_1 = \dot{u}_1 - \dot{u}_2, \dot{U}_2 = \dot{u}_3 - \dot{u}_2) \\ &= (\dot{u}_1 - \dot{u}_2) \dot{I}_1 + (\dot{u}_3 - \dot{u}_2) \dot{I}_3 \\ &= \dot{u}_1 \dot{I}_1 + \dot{u}_2 (-\dot{I}_1 - \dot{I}_3) + \dot{u}_3 \dot{I}_3 \end{aligned}$$

(because  $\dot{I}_1 + \dot{I}_2 + \dot{I}_3 = 0$  due to precondition of a closed circuit)

$$= \dot{u}_1 \dot{I}_1 + \dot{u}_2 \dot{I}_2 + \dot{u}_3 \dot{I}_3 \quad (2)$$

Since equations (1) and (2) agree, it is possible to prove that 2-wattmeter measurement can be used to measure the power of a 3-phase, 3-wire line. Since the only special conditions are that the target be a closed circuit without leakage current, it is possible to calculate 3-phase power without regard to the balance or unbalance state of the electric circuit.

Additionally, since the sum of the voltage and current vectors always equals 0 under these conditions, the instrument internally calculates the third voltage ( $\dot{U}_3$ ) and current ( $\dot{I}_2$ ) values as follows:

$$\begin{aligned} \dot{U}_3 &= \dot{U}_1 - \dot{U}_2 \\ \dot{I}_2 &= -\dot{I}_1 - \dot{I}_3 \end{aligned}$$

Since the  $\dot{U}_3, \dot{I}_2$  values calculated internally are also applied to the 3-phase total reactive power  $Q$ , apparent power  $S$ , and power factor  $PF$  values, these values can also be calculated accurately in the event of an unbalanced state ( $PF/Q/S$  calculation selection: when using RMS calculation).

**See:** "PF/Q/S calculation [PF/Q/S CALC]" (p.75)

However, because the three phases are calculated from two power values in 2-wattmeter measurement, it is not possible to check the power balance for individual phases. If you wish to check the power balance for individual phases, use 3-wattmeter (3P3W3M) measurement.

**Appendix 3 Three-phase 3-wire Measurement**

Item		3P3W2M		Relative merits	3P3W3M	
Voltage	U1	$\dot{U}_1$		=	$\dot{U}_1 = \dot{u}_1 - \dot{u}_2$	
	U2	$\dot{U}_2$			$\dot{U}_2 = \dot{u}_2 - \dot{u}_3$	
	U3	$\dot{U}_3 = \dot{U}_1 - \dot{U}_2$			$\dot{U}_3 = \dot{u}_3 - \dot{u}_1$	
Current	I1	$\dot{I}_1$		=	$\dot{I}_1$	
	I2	$\dot{I}_3$			$\dot{I}_2$	
	I3	$\dot{I}_2 = -\dot{I}_1 - \dot{I}_3$			$\dot{I}_3$	
Active power	P1	$\dot{U}_1 \dot{I}_1$	Since the three phases are calculated from two power meter, it is not possible to check the active power balance for individual phases.	<	$\dot{u}_1 \dot{I}_1$	It is possible to check the active power balance for individual phases.
	P2	$\dot{U}_2 \dot{I}_3$			$\dot{u}_2 \dot{I}_2$	
	P3	-			$\dot{u}_3 \dot{I}_3$	
	P	$\dot{U}_1 \dot{I}_1 + \dot{U}_2 \dot{I}_3$ $= \dot{u}_1 \dot{I}_1 + \dot{u}_2 \dot{I}_2 + \dot{u}_3 \dot{I}_3$ See equation (2).			=	
Apparent power (When the PF/Q/S calculation selection is set to RMS)	S1	$U_1 I_1$	Since calculations are based on the line-to-line voltage and phase (line) current, apparent power values are not generated for individual phases.	<	$u_1 I_1$	Since calculations are based on the phase voltage and phase (line) current, it is possible to check the apparent power for individual phases.
	S2	$U_2 I_3$			$u_2 I_2$	
	S3	$U_3 I_2$			$u_3 I_3$	
	S	$\frac{\sqrt{3}}{3} (U_1 I_1 + U_2 I_3 + U_3 I_2)$			=	

**Reference** In 3P3W2M measurement, the instrument inputs the 3-phase line's T-phase current as each current's I2 parameter. For display purposes, the 3-phase line's T-phase current value is shown as the I2 current, and the 3-phase line's S-phase calculated value is shown as the I3 current.

## Appendix 3 Three-phase 3-wire Measurement

### Power measurement (3P3W3M) wiring

When performing 3-wattmeter (3P3W3M) measurement with an older power meter (PW3360, 3169, etc.), it is typical to use a wiring method that does not use the N terminal.

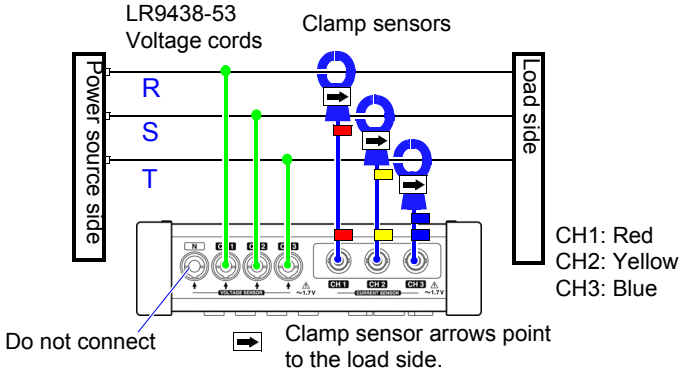

Three-wattmeter measurement with an PW3360

With the PW3365, failure to connect a PW9020 Voltage Sensor to the N terminal may prevent the instrument's internal reference potential from stabilizing, making accurate measurement impossible. When performing three-wattmeter measurement with the PW3365, be sure to connect a PW9020 Voltage Sensor to the N terminal and clamp it to the load-side grounding wire or grounded metal part on the load side. (The power of each channel is measured while using the voltage to which the N terminal's voltage sensor is connected as a virtual neutral point.)

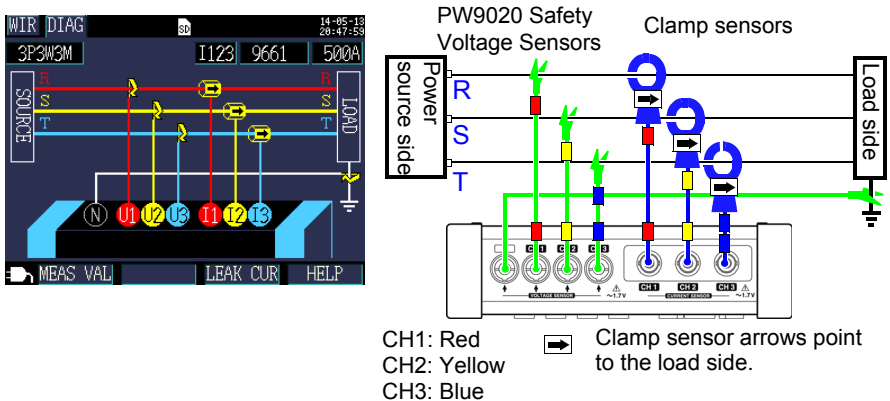

Three-wattmeter measurement with the PW3365

**Appendix 3 Three-phase 3-wire Measurement**

**Precautions when performing measurement using  $\Delta$  wiring**

The PW9020 Safety Voltage Sensor generates an internal voltage that is the same as the conductor-to-ground voltage, and the PW3365 measures the line voltage based on that generated voltage. When one terminal is grounded while using the  $\Delta$  wiring method, performing 3-power measurement (3P3W3M) causes the vector diagram on the [WIR, CHK] screen to appear as follows:

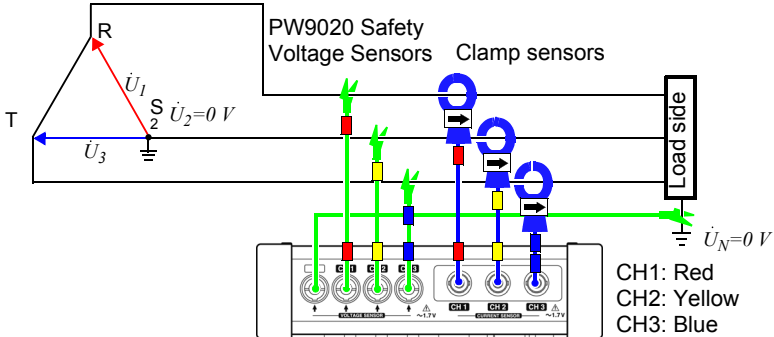

U2 will become 0 V, causing a voltage input fail. (Depending on the installation environment, it may not become 0 V.)



When one terminal is grounded while using the  $\Delta$  wiring method, the wiring check will result in a fail judgment even if the instrument is connected as shown on the [WIR, DIAG] screen for [3P3W3M] (3-power measurement). In this case, active power, reactive power, and apparent power will be the same result as [3P3W2M] (two-wattmeter measurement). You will be able to measure the total power for the three phases, but you will not be able to check the power balance for individual phases. Since the instrument assumes that [3P3W3M] (3-power measurement) will be performed using the Y wiring method, when performing measurement using the  $\Delta$  wiring method, select [3P3W2M] (two-wattmeter measurement). [3P3W2M] (two-wattmeter measurement) supports both the Y and  $\Delta$  wiring methods.

## Appendix 3 Three-phase 3-wire Measurement

### Differences in 3-phase/3-wire/3-wattmeter measurement (3P3W3M) calculations between the PW3360, PW3365, and the 3169-20/21

This section describes differences in how the PW3660 Clamp on Power Logger PW3365 Clamp on Power Logger, and the 3169-20/21 Clamp on Power HiTester perform calculations during 3-phase/3-wire/3-wattmeter (3P3W3M) measurement. As indicated in the following table, the apparent power and power factor values generated by the 3169-20/21 for each channel are not available for each phase because the instrument uses line-to-line voltages to calculate apparent power and power factor for each channel. By contrast, since the PW3660 and PW3365 uses phase voltages, the apparent power and power factor values for each channel are available for each phase. Consequently, it is possible to check balance for individual phases.

Item		Model PW3360 and PW3365 (3P3W3M) When the PF/Q/S calculation selection is set to RMS		Relative merits	Model 3169-20/21(3P3W3M) The reactive power meter method is not used.	
Voltage	U1	$\dot{U}_1 = \dot{u}_1 - \dot{u}_2$		=	$\dot{U}_1 = \dot{u}_1 - \dot{u}_2$	
	U2	$\dot{U}_2 = \dot{u}_2 - \dot{u}_3$			$\dot{U}_2 = \dot{u}_2 - \dot{u}_3$	
	U3	$\dot{U}_3 = \dot{u}_3 - \dot{u}_1$			$\dot{U}_3 = \dot{u}_3 - \dot{u}_1$	
Current	I1	$\dot{I}_1$		=	$\dot{I}_1$	
	I2	$\dot{I}_2$			$\dot{I}_2$	
	I3	$\dot{I}_3$			$\dot{I}_3$	
Active power	P1	$\dot{u}_1 \dot{I}_1$		=	$\dot{u}_1 \dot{I}_1$	
	P2	$\dot{u}_2 \dot{I}_2$			$\dot{u}_2 \dot{I}_2$	
	P3	$\dot{u}_3 \dot{I}_3$			$\dot{u}_3 \dot{I}_3$	
	P	P1+P2+P3			P1+P2+P3	
Apparent power	S1	$u_1 I_1$	Since calculations are based on the phase voltage and phase (line) current, it is possible to check the apparent power for each of the three phases.	>	$U_1 I_1$	Since calculations are based on the line-to-line voltage and line (phase) current, apparent power values are not generated for individual phases.
	S2	$u_2 I_2$			$U_2 I_2$	
	S3	$u_3 I_3$			$U_3 I_3$	
	S	$\frac{\sqrt{3}}{3} (U1I1+U2I2+U3I3)$			=	

### Appendix 3 Three-phase 3-wire Measurement

Item		Model PW3360 and PW3365 (3P3W3M) When the PF/Q/S calculation selection is set to RMS		Relative merits	Model 3169-20/21(3P3W3M) The reactive power meter method is not used.	
Power factor si: Indicates lag/lead.	PF 1	si $\left  \frac{P1}{u_1 I_1} \right $	Since calculations are based on the phase voltage and phase (line) current, it is possible to check the power factor for individual phases.	>	si $\left  \frac{P1}{U_1 I_1} \right $	Since calculations are based on the line-to-line voltage and phase (line) current, power factor values are not generated for individual phases.
	PF 2	si $\left  \frac{P2}{u_2 I_2} \right $			si $\left  \frac{P2}{U_2 I_2} \right $	
	PF 3	si $\left  \frac{P3}{u_3 I_3} \right $			si $\left  \frac{P3}{U_3 I_3} \right $	
	PF	si $\left  \frac{P}{S} \right $	=	si $\left  \frac{P}{S} \right $		



## Appendix 4 Method for Calculating Active Power Accuracy

The accuracy of active power calculations can be calculated as follows, taking into account the phase accuracy:

### Example measurement conditions

Wiring	3-phase/3-wire/2-wattmeter measurement (3P3W2M)
Clamp sensor	Model 9661
Current range	100 A (power range: 80 kW) <b>See:</b> "11.6 Range Configuration and Accuracy by Clamp Sensor" (p.215)
Measured values	Active power of 30 kW, power factor lag 0.9

### Accuracy

Clamp sensor combined accuracy (Model 9661 sensor, 100 A range)	$\pm 2.3\%$ rdg. $\pm 0.35\%$ f.s.
Instrument phase accuracy (PW3365+PW9020)	$\pm 1.3^\circ$
Model 9661 phase accuracy	$\pm 0.5^\circ$

**See:** "11.3 Detailed Measurement Specifications" (p.190),  
"11.6 Range Configuration and Accuracy by Clamp Sensor" (p.215),  
Model 9661 Instruction manual "Specifications" phase accuracy

### Power factor accuracy based on phase accuracy

Phase accuracy (in combination with clamp sensor) = Instrument phase accuracy ( $\pm 1.3^\circ$ ) + Model 9661 phase accuracy ( $\pm 0.5^\circ$ ) =  $\pm 1.8^\circ$

$$\text{Phase difference } \theta = \cos^{-1}(\text{power factor}) = \cos^{-1}0.9 = 25.84^\circ$$

Power factor error range based on phase accuracy

$$= \cos(25.84^\circ \pm 1.8^\circ) = \text{Min. } 0.8859 \text{ to max. } 0.9133$$

Power factor accuracy based on phase accuracy (minimum)

$$= \frac{0.8859 - 0.9}{0.9} \times 100\% = -1.57\%, \text{ Use the worst value as the power factor accuracy.}$$

Power factor accuracy based on phase accuracy (maximum)

$$= \frac{0.9133 - 0.9}{0.9} \times 100\% = +1.48\%$$

Power factor accuracy based on phase accuracy:  $\pm 1.57\%$  rdg.

**Appendix 4 Method for Calculating Active Power Accuracy****Active power accuracy**

$$\begin{aligned}\text{Active power accuracy} &= \text{Clamp sensor combined accuracy} \\ &\quad + \text{power factor accuracy based on phase accuracy} \\ &= \pm 2.3\% \text{ rdg.} \pm 0.35\% \text{ f.s.} \pm 1.57\% \text{ rdg.} \\ &= \pm 3.87\% \text{ rdg.} \pm 0.35\% \text{ f.s.}\end{aligned}$$

$$\begin{aligned}\text{Accuracy relative to measured values (kW)} \\ &= \pm \{30 \text{ kW (active power)} \times 3.87\% \text{ rdg.} + 80 \text{ kW (range)} \times 0.35\% \text{ f.s.}\} \\ &= \pm 1.441 \text{ kW}\end{aligned}$$

$$\begin{aligned}\text{Accuracy relative to measured values (\% rdg.)} &= \pm 1.441 \text{ kW} / 30 \text{ kW} \\ &= \pm 4.8\% \text{ rdg.}\end{aligned}$$

---

## Appendix 5 Terminology

Active power	Power that is consumed doing work.
Active power demand value	The average active power used during a set period of interval time (usually 30 minutes).
Apparent power	Power obtained by combining the active power and reactive power vectors. As its name suggests, apparent power expresses the “visible” power and comprises the product of the voltage and current RMS values.
Binary data	All data other than text (character) data. Use binary data when analyzing data with the SF1001 Power Logger Viewer application.
IEC61000-4-7	An international standard governing measurement of harmonic current and harmonic voltage in power supply systems as well as harmonic current emitted by equipment. The standard specifies the performance of a standard instrument.
Harmonics	A phenomenon caused by distortions in the voltage and current waveforms that affect many devices with power supplies using semiconductor control devices. In the analysis of non-sine waves, the term refers to one RMS value among the components with harmonic frequencies.
Harmonic content percentage	The ratio of the K-th order size to the size of the fundamental wave, expressed as a percentage using the following equation: $\text{K-th order wave} / \text{fundamental wave} \times 100 [\%]$ By observing this value, it is possible to ascertain the harmonic component content for individual orders. This metric provides a useful way to track the harmonic content percentage when monitoring a specific order.
LAN	LAN is the abbreviation of Local Area Network. The LAN was developed as a network for transferring data through a PC within a local area, such as an office, factory, or school. This device comes equipped with the LAN adapter Ethernet 10/100Base-T. Use a twisted-pair cable to connect this device to the hub (central computer) of your LAN. The maximum length of the cable connecting the terminal and the hub is 100 m. Communications using TCP/IP as the LAN interface protocol are supported.

## Appendix 5 Terminology

Power factor (PF/DPF)	<p>Power factor is the ratio of effective power to apparent power. The larger the absolute value of the power factor, the greater the proportion of effective power, which provides the power that is consumed, and the greater the efficiency. The maximum absolute value is 1. Conversely, the smaller the absolute value of the power factor, the greater the proportion of reactive power, which is not consumed, and the lower the efficiency. The minimum absolute value is 0. A positive value (LAG) indicates that the current phase is lagging the voltage. Inductive loads (such as motors) are characterized by lagging phase. A negative value (LEAD) indicates that the current phase is leading the voltage. Capacitive loads (such as capacitors) are characterized by leading phase.</p> <p>This is the same measurement method used by reactive power meters installed at commercial-scale utility customers' facilities. Displacement power factor, or DPF, is typically used by the electric power system, although power factor, or PF, is sometimes used to measure equipment in order to evaluate efficiency.</p> <p>When a lagging phase caused by a large inductive load such as a motor results in a low displacement power factor, there are corrective measures that can be taken to improve the power factor, for example by adding a phase advance capacitor to the power system. Displacement power factor (DPF) measurements can be taken under such circumstances to verify the improvement made by the phase advance capacitor.</p>
Power factor demand value	<p>The power factor calculated using the active power demand value (consumption) and the reactive power demand value (lag) for the set interval time (usually 30 minutes).</p> $PF_{dem} = \frac{P_{dem+}}{\sqrt{(P_{dem+})^2 + (Q_{dem\_LAG})^2}}$
Reactive power	<p>Power that does not perform actual work, resulting in power consumption as it travels between the load and the power supply. Reactive power is calculated by multiplying the active power by the sine of the phase difference (<math>\sin \theta</math>). It arises from inductive loads (deriving from inductance) and capacitive loads (deriving from capacitance), with reactive power derived from inductive loads known as lag reactive power and reactive power derived from capacitive loads known as lead reactive power.</p>
Reactive power demand value	<p>The average reactive power used during a set period of save interval time (usually 30 minutes).</p>
RMS value	<p>The square root of the squares of 1,024 sampling points in a 200 ms interval.</p>
SD memory card	<p>A type of flash memory card.</p>
Text data	<p>A file containing only data expressed using characters and character codes.</p>

Total harmonic distortion factor	<p>THD-F: The ratio of the size of the total harmonic component to the size of the fundamental wave, expressed as a percentage using the following equation:</p> $\text{THD-F} = \frac{\sqrt{\sum(\text{from 2nd order})^2}}{\text{Fundamental waveform}} \times 100 \text{ [%]}$ <p>(for the PW3365, calculated to the 13th order)</p> <p>This value can be monitored to assess waveform distortion for each item, providing a yardstick that indicates the extent to which the total harmonic component is distorting the fundamental waveform. As a general rule, the total distortion factor for a high-voltage system should be 5% or less; it may be higher at the terminal point of the system.</p> <p>THD-R: The ratio of the size of the total harmonic component to the size of RMS values, expressed as a percentage using the following equation:</p> $\text{THD-R} = \frac{\sqrt{\sum(\text{from 2nd order})^2}}{\text{RMS values}} \times 100 \text{ [%]}$ <p>(for the PW3365, calculated to the 13th order)</p> <p>THD-F is typically used.</p>
USB	<p>An interface that allows data to be sent to and received from a host controller (usually a computer) to which a device is connected with a USB cable. Consequently, functions are unable to communicate directly.</p>



# Index

## Number

3169-20/21 ..... A 7

## A

AC adapter ..... 41  
 Active energy ..... 101, 105  
 Active power ..... 65, 101, 104  
 Active power value ..... 65  
 Amount of space used ..... 132  
 Apparent power ..... 75, 101, 104, A 11  
 Average ..... 79

## B

Backlight ..... 89  
 Battery ..... 25, 32, 205  
 Beep sound ..... 89  
 B-type grounding wire ..... 62

## C

Card reader ..... 150  
 Carrying case ..... 4  
 CHARGE ..... 34  
 Clamp Sensor ..... 11  
 Clamp sensor ..... 30, 43, 73  
 Clips ..... 28  
 Clock ..... 36  
 Consumption ..... 105  
 CT ..... 73  
 CURRENCY ..... 77  
 Currency ..... 76  
 Current ..... 24  
 Current phase ..... 69  
 Current range ..... 51, 52, 63, 73  
 Current sensor input terminals ..... 20, 55

## D

Default ..... 93, 94  
 Default gateway ..... 171  
 Default settings ..... 36  
 Demand ..... 79, 106  
 Demand quantity ..... 165  
 demand value ..... 165  
 Displacement power factor ..... 65, 75, 101

Display color ..... 90  
 DPF ..... 65, 75, 101, A 12

## E

Energy ..... 101, 105  
 Energy cost ..... 76  
 Enlarge ..... 111  
 Error indication ..... 225  
 Exceeds the peak ..... 24  
 Excel ..... 149, 157, 168  
 Exponential ..... 167

## F

Factory defaults ..... 93  
 Factory reset ..... 36, 93  
 Factory settings ..... 94  
 File ..... 81, 131  
 Folder ..... 81, 131  
 Format ..... 38, 146  
 Frequency ..... 72, 101  
 Fundamental wave ..... 75, 102  
 Fundamental wave apparent power ..... 75  
 Fundamental wave reactive power ..... 75

## H

HARDCOPY ..... 140  
 Harmonic content percentage ..... A 11  
 Harmonic graph ..... 107  
 Harmonic list ..... 108  
 Harmonics ..... 195, A 11  
 Help ..... 71  
 HOLD ..... 97  
 How much recording time remains ..... 24  
 HTTP server ..... 24, 176

## I

I only ..... 49  
 Inspection ..... 37  
 INTERNAL ..... 78  
 Internal memory ..... 24, 78, 131  
 Internet browser ..... 176  
 Internet explorer ..... 176  
 INTERVAL ..... 83, 120

# Index 2

## Index

---

Interval time ..... 83, 120  
IP address ..... 171

## K

---

Key lock ..... 18, 24

## L

---

LAG ..... A 12  
Lag ..... A 12  
LAN ..... 24, 169  
LAN cable ..... 169  
Language ..... 35, 90  
Lead ..... A 12  
Leakage current ..... 50, 62  
Line current ..... A 2  
Line voltage ..... 48  
Line-to-line voltage ..... A 2

## M

---

MAC address ..... 20, 171  
Making connection ..... 43  
Mass storage ..... 153  
Maximum ..... 79  
Measurement ..... 97  
Measurement categories ..... 8  
Measurement file ..... 159  
Measurement guide ..... 2  
Measurement is not possible 24, 115, 166  
Minimum ..... 79

## O

---

Over-range ..... 24, 115

## P

---

Password ..... 178  
Peak ..... 102, 187  
PF ..... 65, 75, 101, 104, A 12  
Phase advance capacitor ..... 70, A 12  
Phase advancer ..... 69  
Phase angle of the fundamental wave 102  
Phase difference ..... 69  
Phase name ..... 90  
Phase to neutral voltage ..... A 2  
Phase voltage ..... 48  
Power ..... 101, 104  
Power factor ..... 65, 75, 101, 104, A 12  
Power factor demand value ..... 166, A 12  
Power logger viewer ..... 155

Power outage ..... 125  
POWER switch ..... 42  
PT ..... 43, 74

## Q

---

Quick set ..... 91, 127

## R

---

Reactive power ..... 75, 101, 104, A 12  
REC START ..... 118  
REC STOP ..... 121  
Recording ..... 117  
Recording and measurement ..... 117  
Recording start ..... 83, 117  
Recording stop ..... 117  
Regeneration ..... 105  
Removable disk ..... 151, 153  
REPEAT ..... 124  
RMS ..... 75, 101, 102

## S

---

Sampling ..... A 1  
Save destination ..... 78  
Save interval ..... 78  
Save item ..... 79  
Save items ..... 79  
Save to... ..... 78  
Screen color ..... 90  
Screen Copy ..... 18  
Screen copy ..... 80, 131, 140  
SD CARD ..... 78  
SD memory card ..... 24, 38, 78, 131, 149  
Self-test ..... 42  
Serial number ..... 20, 91  
SET.LOAD ..... 132, 133, 142, 143  
Settings ..... 71  
Settings data ..... 131  
Settings files ..... 141, 142  
Spiral tube ..... 2, 28, 55  
Stop recording ..... 87, 121  
Storage time ..... 78  
Subnet mask ..... 171  
System ..... 89  
System reset ..... 92

## T

---

THD ..... 107, 108, A 13  
Total harmonic distortion ...77, 107, 108, A



13	
Transporting .....	3, 222
Trend .....	113

**U**

Unit cost .....	76
USB .....	24
USB Drive .....	132, 153

**V**

Version .....	91
Virtual neutral point .....	48, A 2, A 5
Voltage .....	101
Voltage phase .....	68
Voltage range .....	74
Voltage sensor .....	2, 28, 43
Voltage sensor input terminals .....	20, 53
Voltage transformer .....	74
VT .....	43, 74

**W**

Waveform .....	80
Waveforms .....	109
Wire current .....	48
Wireless LAN .....	170
Wiring .....	72
Wiring check .....	65
Wiring diagram .....	45



# Warranty Certificate

# HIOKI

Model	Serial number	Warranty period Three (3) years from date of purchase ( ___ / ___ )
-------	---------------	--

Customer name: \_\_\_\_\_

Customer address: \_\_\_\_\_

### Important

- Please retain this warranty certificate. Duplicates cannot be reissued.
- Complete the certificate with the model number, serial number, and date of purchase, along with your name and address. The personal information you provide on this form will only be used to provide repair service and information about Hioki products and services.

This document certifies that the product has been inspected and verified to conform to Hioki's standards.

Please contact the place of purchase in the event of a malfunction and provide this document, in which case Hioki will repair or replace the product subject to the warranty terms described below.

### Warranty terms

1. The product is guaranteed to operate properly during the warranty period (three [3] years from the date of purchase).  
If the date of purchase is unknown, the warranty period is defined as three (3) years from the date (month and year) of manufacture (as indicated by the first four digits of the serial number in YYMM format).
2. If the product came with an AC adapter, the adapter is warranted for one (1) year from the date of purchase.
3. The accuracy of measured values and other data generated by the product is guaranteed as described in the product specifications.
4. In the event that the product or AC adapter malfunctions during its respective warranty period due to a defect of workmanship or materials, Hioki will repair or replace the product or AC adapter free of charge.
5. The following malfunctions and issues are not covered by the warranty and as such are not subject to free repair or replacement:
  - 1. Malfunctions or damage of consumables, parts with a defined service life, etc.
  - 2. Malfunctions or damage of connectors, cables, etc.
  - 3. Malfunctions or damage caused by shipment, dropping, relocation, etc., after purchase of the product
  - 4. Malfunctions or damage caused by inappropriate handling that violates information found in the instruction manual or on precautionary labeling on the product itself
  - 5. Malfunctions or damage caused by a failure to perform maintenance or inspections as required by law or recommended in the instruction manual
  - 6. Malfunctions or damage caused by fire, storms or flooding, earthquakes, lightning, power anomalies (involving voltage, frequency, etc.), war or unrest, contamination with radiation, or other acts of God
  - 7. Damage that is limited to the product's appearance (cosmetic blemishes, deformation of enclosure shape, fading of color, etc.)
  - 8. Other malfunctions or damage for which Hioki is not responsible
6. The warranty will be considered invalidated in the following circumstances, in which case Hioki will be unable to perform service such as repair or calibration:
  - 1. If the product has been repaired or modified by a company, entity, or individual other than Hioki
  - 2. If the product has been embedded in another piece of equipment for use in a special application (aerospace, nuclear power, medical use, vehicle control, etc.) without Hioki's having received prior notice
7. If you experience a loss caused by use of the product and Hioki determines that it is responsible for the underlying issue, Hioki will provide compensation in an amount not to exceed the purchase price, with the following exceptions:
  - 1. Secondary damage arising from damage to a measured device or component that was caused by use of the product
  - 2. Damage arising from measurement results provided by the product
  - 3. Damage to a device other than the product that was sustained when connecting the device to the product (including via network connections)
8. Hioki reserves the right to decline to perform repair, calibration, or other service for products for which a certain amount of time has passed since their manufacture, products whose parts have been discontinued, and products that cannot be repaired due to unforeseen circumstances.

**HIOKI E.E. CORPORATION**

<http://www.hioki.com>

18-07 EN-3





# HIOKI

<http://www.hioki.com>



**All regional  
contact  
information**

## **HEADQUARTERS**

81 Koizumi  
Ueda, Nagano 386-1192 Japan

## **HIOKI EUROPE GmbH**

Rudolf-Diesel-Strasse 5  
65760 Eschborn, Germany  
[hioki@hioki.eu](mailto:hioki@hioki.eu)

1906 EN

---

Edited and published by HIOKI E.E. CORPORATION

Printed in Japan

- CE declarations of conformity can be downloaded from our website.
- Contents subject to change without notice.
- This document contains copyrighted content.
- It is prohibited to copy, reproduce, or modify the content of this document without permission.
- Company names, product names, etc. mentioned in this document are trademarks or registered trademarks of their respective companies.